



Click on the logo above to go to [www.panduit.com](http://www.panduit.com) up to date product information find a local distributor technical information

## Section Index



### A. System Overview



### B. Bundle

1. Cable Ties
2. Cable Accessories
3. Stainless Steel Cable Ties and Accessories



### C. Route/Protect

1. Wiring Duct
2. Surface Raceway
3. Abrasion Protection
4. Cable Management



### D. Terminate

1. Terminals
2. Power Connectors
3. Grounding Connectors



### E. Identification and Safety Solutions

1. Labeling Systems
2. Labels
3. Pre-Printed and Write-On Markers
4. Permanent Identification
5. Lockout/Tagout and Safety Solutions



### F. Part Number Index

**CLICK on any of the tabs on this page to jump to that location within the catalog**

|                                       |
|---------------------------------------|
| A. System Overview                    |
| B1. Cable Ties                        |
| B2. Cable Accessories                 |
| B3. Stainless Steel Ties              |
| C1. Wiring Duct                       |
| C2. Surface Raceway                   |
| C3. Abrasion Protection               |
| C4. Cable Management                  |
| D1. Terminals                         |
| D2. Power Connectors                  |
| D3. Grounding Connectors              |
| E1. Labeling Systems                  |
| E2. Labels                            |
| E3. Pre-Printed & Write-On Markers    |
| E4. Permanent Identification          |
| E5. Lockout/Tagout & Safety Solutions |
| F. Index                              |

A.  
System  
Overview

## Table of Contents

B1.  
Cable Ties

### System Overview

|                                   |             |
|-----------------------------------|-------------|
| <b>System Overview</b> .....      | A1.1        |
| Solutions Overview .....          | A1.2 – A1.3 |
| Control Panel Solutions .....     | A1.4        |
| Harness Solutions .....           | A1.5        |
| Contractor Solutions .....        | A1.6        |
| MRO Solutions .....               | A1.6        |
| Harsh Environment Solutions ..... | A1.7        |
| Transportation Solutions .....    | A1.7        |
| Application Standards .....       | A1.8 – A1.9 |
| Programs .....                    | A1.10       |

C1.  
Wiring  
Duct

### Cable Ties

|  |               |
|--|---------------|
| <b>Cable Ties</b> .....  | B1.1          |
| Cable Tie Selection Chart .....  | B1.2 – B1.3   |
| Cable Tie Styles Overview .....  | B1.4 – B1.5   |
| Features and Benefits – Pan-Ty® Cable Ties .....                                       | B1.6          |
| Selection Guide – Pan-Ty® Cable Ties .....   | B1.7          |
| Pan-Ty® Cable Ties – Nylon 6.6 .....   | B1.8          |
| Pan-Ty® Lashing Ties – Nylon 6.6 .....   | B1.9          |
| Pan-Ty® Cable Ties – Weather Resistant Nylon 6.6 .....                                 | B1.10         |
| Pan-Ty® Lashing Ties – Weather Resistant Nylon 6.6 .....                               | B1.11         |
| Lashing Tie Mounting Clip .....  | B1.11         |
| Pan-Ty® Cable Ties – Heat Stabilized Nylon 6.6 .....                                   | B1.12         |
| Pan-Ty® Cable Ties – Heat Stabilized Weather Resistant Nylon 6.6 .....                 | B1.13         |
| Pan-Ty® Cable Ties – Flame Retardant Nylon 6.6 .....                                   | B1.14         |
| Cable Tie Mounts – Flame Retardant Nylon 6.6 .....                                     | B1.14         |
| Pan-Ty® Cable Ties – Weather Resistant Nylon 12 .....                                  | B1.15         |
| Pan-Ty® Cable Ties – Polypropylene – Distinctive Green Color .....                     | B1.16         |
| Pan-Ty® Cable Ties – Weather Resistant Polypropylene .....                             | B1.17         |
| Pan-Ty® Cable Ties – HALAR▲ – Distinctive Maroon Color .....                           | B1.18         |
| Pan-Ty® Cable Ties – TEFZEL■ – Distinctive Aqua Blue Color .....                       | B1.19         |
| Cable Tie Mounts – TEFZEL■ .....   | B1.19         |
| Pan-Ty® Cable Ties – PEEK (Polyetheretherketone) .....                                 | B1.20         |
| ★ Cable Tie Mounts – PEEK (Polyetheretherketone) .....                                 | B1.20         |
| Pan-Ty® Cable Ties – Metal Detectable Nylon 6.6 .....                                  | B1.21         |
| ★ Cable Tie Mounts – Metal Detectable Nylon 6.6 and Polypropylene .....                | B1.21         |
| Pan-Ty® Releasable Cable Ties – Nylon 6.6 .....  | B1.22         |
| Pan-Ty® Releasable Lashing Ties – Nylon 6.6 .....                                      | B1.22         |
| Pan-Ty® Releasable Cable Ties – Weather Resistant and Heat Stabilized Nylon 6.6 .....  | B1.23         |
| Pan-Ty® Releasable Lashing Ties – Weather Resistant Nylon 6.6 .....                    | B1.24         |
| Lashing Tie Mounting Clip – Weather Resistant Nylon 6.6 .....                          | B1.24         |
| Pan-Ty® Releasable Lashing Ties – Weather Resistant Polypropylene .....                | B1.25         |
| Pan-Ty® Clamp Ties – Nylon 6.6 .....   | B1.26         |
| Pan-Ty® Clamp Ties – Weather Resistant and Heat Stabilized Nylon 6.6 .....             | B1.27         |
| Pan-Ty® Wing Push Mount Ties – Nylon 6.6 .....   | B1.28         |
| Pan-Ty® Wing Push Mount Ties – Weather Resistant and Heat Stabilized Nylon 6.6 .....   | B1.29         |
| Pan-Ty® Releasable Wing Push Mount Ties .....  | B1.30         |
| Pan-Ty® Center Mounted Wing Push Mount Ties – Heat Stabilized Nylon 6.6 .....          | B1.31         |
| Pan-Ty® Ladder Style Releasable Wing Push Mount Ties – Heat Stabilized Nylon 6.6 ..... | B1.32         |
| Pan-Ty® Umbrella Wing Push Mount Ties – Nylon and Heat Stabilized Nylon 6.6 .....      | B1.32         |
| Pan-Ty® Push Mount Ties .....  | B1.33         |
| Pan-Ty® Marker and Flag Ties .....   | B1.34         |
| Pan-Ty® Cable Ties Material and Color Chart .....                                      | B1.35 – B1.37 |
| Features and Benefits – Super-Grip® Cable Ties .....                                   | B1.38         |
| Selection Guide – Super-Grip® Cable Ties .....   | B1.39         |
| Super-Grip® Cable Ties – Nylon 6.6 .....   | B1.40         |
| Super-Grip® Cable Ties – Weather Resistant and Heat Stabilized Nylon 6.6 .....         | B1.41         |
| Super-Grip® Cable Ties and Mounts Material and Color Chart .....                       | B1.42         |
| Features and Benefits – Dome-Top® Barb Ty Cable Ties .....                             | B1.43         |
| Selection Guide – Dome-Top® Barb Ty and Dura-Ty™ Cable Ties .....                      | B1.44         |
| Dome-Top® Barb Ty Cable Ties – Nylon 6.6 .....   | B1.45         |
| Dome-Top® Barb Ty Cable Ties – Weather Resistant Nylon 6.6 .....                       | B1.46         |
| Dome-Top® Barb Ty Cable Ties – Heat Stabilized Nylon 6.6 .....                         | B1.47         |
| Dome-Top® Barb Ty Clamp Ties – Nylon 6.6 .....   | B1.48         |

▲HALAR is a registered trademark of Ausimont USA, Inc. ■TEFZEL is a registered trademark of E.I. du Pont de Nemours and Company.

★ Represents new product offering.



## Table of Contents

|   |                 |
|---|-----------------|
| Dome-Top® Barb Ty Clamp Ties – Weather Resistant and Heat Stabilized Nylon 6.6                    | B1.49           |
| Dome-Top® Barb Ty Wing Push Mount Ties – Nylon and Weather Resistant Nylon 6.6                    | B1.50           |
| Dome-Top® Barb Ty Push Mount Ties – Weather Resistant Nylon 6.6                                   | B1.51           |
| Permanent Marking Pens  | B1.51           |
| Dome-Top® Barb Ty Marker and Flag Ties  | B1.52           |
| Dura-Ty™ Cable Ties – Weather Resistant Acetal – Heavy Cross Section                              | B1.53           |
| Dura-Ty™ Cable Ties – Weather Resistant Acetal – Extra-Heavy Cross Section                        | B1.53           |
| Stackable Aerial Cable Spacer – Weather Resistant Polypropylene                                   | B1.54           |
| Dome-Top® Barb Ty and Dura-Ty™ Cable Ties Material and Color Chart                                | B1.54 – B1.55   |
| Features and Benefits – Parallel-Entry Cable Ties   | B1.56           |
| Selection Guide – Parallel-Entry Cable Ties   | B1.57           |
| Contour-Ty® Cable Ties – Nylon 6.6  | B1.58           |
| Contour-Ty® Cable Ties – Weather Resistant Nylon 6.6  | B1.59           |
| Contour-Ty® Cable Ties – Heat Stabilized and Flame Retardant Nylon 6.6                            | B1.60           |
| Belt-Ty™ In-Line Cable Ties – Nylon and Weather Resistant Nylon 6.6                               | B1.61           |
| Hyper-V™ In-Line Cable Ties – Weather Resistant Nylon 6.6   | B1.62           |
| Hyper-V™ Cable Tie Mounts   | B1.62           |
| IN-LINE Cable Ties – Weather Resistant Nylon 6.6  | B1.63           |
| Parallel-Entry Cable Ties Material and Color Chart  | B1.64           |
| Features and Benefits – Sta-Strap® Cable Ties   | B1.65           |
| Selection Guide – Sta-Strap® Cable Ties   | B1.66           |
| Sta-Strap® Cable Ties – Nylon 6.6   | B1.67           |
| Sta-Strap® Cable Ties – Weather Resistant Nylon 6.6   | B1.68           |
| Sta-Strap® Cable Ties – Heat Stabilized Nylon 6.6   | B1.69           |
| Sta-Strap® Clamp Ties   | B1.70           |
| Sta-Strap® Marker Ties – Nylon and Weather Resistant Nylon 6.6                                    | B1.71           |
| Sta-Strap® Cable Ties Material and Color Chart  | B1.72           |
| Selection Guide – Specialty Ties  | B1.73           |
| Pan-Ty® Stud Mounted Cable Ties – Heat Stabilized and Heat Stabilized Weather Resistant Nylon 6.6 | B1.74           |
| Pan-Ty® Ladder Style Stud Mounted Cable Tie – Heat Stabilized Nylon 6.6                           | B1.75           |
| Pan-Ty® Double Loop Cable Ties  | B1.76           |
| Sta-Strap® Bow-Ty™ Cable Ties   | B1.77           |
| Pan-Ty® Triple Loop Cable Tie – Weather Resistant Nylon 6.6                                       | B1.78           |
| Double Hose Clamp – Weather Resistant Nylon 6.6   | B1.78           |
| Sta-Strap® Chassis/Panel Mount Tie – Heat Stabilized Weather Resistant Nylon 6.6                  | B1.79           |
| Cable Marker Straps – Polyethylene  | B1.80           |
| Specialty Cable Ties Material and Color Chart   | B1.81           |
| Pan-Ty® Striped Cable Ties – Nylon 6.6  | B1.82           |
| Telephone Cable Identification Kits   | B1.83           |
| Cable Tie Kits in Steel Boxes   | B1.83           |
| Cable Tie Kits in Plastic Boxes and Bags  | B1.84           |
| Features and Benefits – Hook and Loop Cable Ties  | B1.85           |
| Selection Guide – Hook and Loop Cable Ties  | B1.86           |
| Tak-Ty® Hook & Loop Cable Ties  | B1.87           |
| Tak-Ty® Hook & Loop Cable Ties – Plenum-Rated   | B1.88           |
| Tak-Tape™ Hook & Loop Cable Tie Rolls   | B1.88           |
| Ultra-Cinch™ Hook & Loop Cable Ties   | B1.89           |
| Hook and Loop Cable Ties Color Chart  | B1.90           |
| ★HLW Marker Hook and Loop Wrap Ties   | B1.91           |
| ★Elastomeric Cable Ties – ERT   | B1.91           |
| ★Cable Bundle Organizing Tool – CBOT  | B1.92           |
| Hot Stamping Service – Custom Printed Cable Ties  | B1.93           |
| Panduit Cable Tie Approvals   | B1.94           |
| Military Cross Reference  | B1.95 – B1.97   |
| Cable Tie Selection and Specification Guidelines  | B1.98           |
| Weathering  | B1.99 – B1.100  |
| Flammability  | B1.101 – B1.102 |
| Radiation/Moisture/Temperature/Tensile Strength   | B1.103          |
| Chemical Resistance Table   | B1.104 – B1.107 |
| <b>Manual Cable Tie Installation Tools</b>  | B1.109          |
| Selection Guide – Hand Tools, Accessories, and Kits   | B1.110          |
| Cable Tie Tools – Tool Controlled Tension and Cut-Off   | B1.111          |
| Cable Tie Tools – Installer Controlled Tension and Cut-Off  | B1.112          |
| Pneumatic Hand Tools – Tool Controlled Tension and Cut-Off  | B1.113          |
| Hand Tool Accessories   | B1.113          |
| Tool Tension Locking Kits   | B1.114          |
| Blade Replacement Kits  | B1.114          |
| Hand Tool Holster   | B1.114          |

★ Represents new product offering.

A.  
System  
Overview

## Table of Contents

|                                |  |        |
|--------------------------------|--|--------|
| B1.<br>Cable Ties              | Cushion Sleeve Kits . . . . .  | B1.114 |
|                                | <b>Automatic Cable Tie Installation Systems</b> . . . . .                          | B1.115 |
|                                | Selection Guide – Automatic Installation Systems and Reel-Fed Cable Ties . . . . . | B1.116 |
|                                | Tool Head . . . . .  | B1.117 |
| B2.<br>Cable<br>Accessories    | Dispenser . . . . .  | B1.117 |
|                                | Transfer Hose . . . . .  | B1.118 |
|                                | Dispenser Frame . . . . .  | B1.118 |
|                                | Filter/Regulator and Air Supply Hose . . . . .                                     | B1.118 |
|                                | Bench Mount . . . . .  | B1.118 |
| B3.<br>Stainless<br>Steel Ties | Data Interface Software and Ethernet Enabled Dispenser . . . . .                   | B1.119 |
|                                | PAT/Robot Integration Kit . . . . .  | B1.119 |
|                                | BT-XMR Reel-Fed Cable Ties . . . . .   | B1.120 |
|                                | PLT-XMR Reel-Fed Cable Ties . . . . .  | B1.121 |
| C1.<br>Wiring<br>Duct          | PLT-VMR Reel-Fed Cable Ties . . . . .  | B1.122 |

## Cable Accessories

|  |   |               |
|--|---|---------------|
|  | <b>Cable Accessories</b> . . . . .                                  | B2.1          |
| C2.<br>Surface<br>Raceway                          | Cable Accessories Products Overview . . . . .                       | B2.2 – B2.3   |
|  | 4-Way Adhesive Backed Cable Tie Mounts . . . . .                    | B2.4 – B2.5   |
|  | ABMQ Multiple Bridge Mounts . . . . .                               | B2.6          |
|  | Tak-Ty® Hook & Loop Cable Tie Mounts . . . . .                      | B2.6          |
| C3.<br>Abrasion<br>Protection                      | Super-Grip® Adhesive Back Mounts . . . . .                          | B2.7          |
|  | Combination Adhesive Mount/Cable Ties . . . . .                     | B2.8          |
|  | Snap-In Cable Tie Mounts – Mechanically Applied . . . . .           | B2.8          |
|  | Epoxy Applied Mounts . . . . .                                      | B2.9          |
|  | Epoxy Applied Swivel Mount . . . . .                                | B2.9          |
| C4.<br>Cable<br>Management                         | Epoxy Applied Cable Tie Mount Kits . . . . .                        | B2.9          |
|  | Tie Mounts – Applied with User Supplied Adhesives . . . . .         | B2.10         |
|  | Low Profile Mounts – Screw Applied . . . . .                        | B2.10         |
|  | Cable Tie Mounts – Screw Applied . . . . .                          | B2.11         |
| D1.<br>Terminals                                   | Extra-Heavy Cable Tie Mounts – Screw Applied . . . . .              | B2.12         |
|  | Swivel Mounts . . . . .   | B2.12         |
|  | 4-Way Tie Anchor Mounts – Screw Applied . . . . .                   | B2.13         |
|  | Tie Anchor Mounts . . . . .   | B2.13         |
| D2.<br>Power<br>Connectors                         | Low Profile Mounts – Screw Applied . . . . .                        | B2.13         |
|  | Low Profile Mounts – Push Rivet Applied . . . . .                   | B2.14         |
|  | Cable Tie Plates . . . . .  | B2.15         |
|  | Multiple Tie Plates . . . . .                                       | B2.15 – B2.16 |
|  | Contour Multiple Tie Plates . . . . .                               | B2.16         |
| D3.<br>Grounding<br>Connectors                     | Right Angle Mounts . . . . .  | B2.17         |
|  | Lightening Hole Mounts . . . . .                                    | B2.17         |
|  | Stud Tie Mounts . . . . .   | B2.18         |
|  | Metal Clip-On Mounts . . . . .                                      | B2.18         |
|  | Metal Screw-On Mount . . . . .                                      | B2.19         |
| E1.<br>Labeling<br>Systems                         | Push Barb Cable Tie Mounts . . . . .                                | B2.19         |
|  | Push Mounts . . . . .   | B2.20         |
|  | Push Button Mount . . . . .   | B2.20         |
|  | Masonry Push Mounts . . . . .                                       | B2.21         |
|  | Wood Push Mount . . . . .   | B2.21         |
| E2.<br>Labels                                      | Fir Tree Push Mounts . . . . .                                      | B2.22         |
|  | Fir Tree Push Mount Assemblies . . . . .                            | B2.22         |
|  | Control Panel Mounts . . . . .                                      | B2.23         |
| E3.<br>Pre-Printed<br>& Write-On<br>Markers        | Pan-Post™ Standoff . . . . .  | B2.23         |
|  | Flat Pan-Post™ Standoffs . . . . .                                  | B2.24         |
|  | Right Angle Bases . . . . .   | B2.24         |
|  | Flat Cable Mounting System – FCB Base and FCPI Plate . . . . .      | B2.25         |
|  | Closed Connector Rings . . . . .                                    | B2.26         |
| E4.<br>Permanent<br>Identification                 | Open Connector Ring . . . . .                                       | B2.26         |
|  | Cable Spacers . . . . .   | B2.26         |
|  | Cable Spacer Cross . . . . .  | B2.27         |
|  | Stackable Aerial Cable Spacer . . . . .                             | B2.27         |
| E5.<br>Lockout/<br>Tagout<br>& Safety<br>Solutions | Aerial Support Ties – Weather Resistant Polypropylene . . . . .     | B2.28         |
|  | Permanent Marking Pens . . . . .                                    | B2.28         |
|  | Marker Plates – Loose Piece . . . . .                               | B2.29         |
|  | Cable and Wire Mounting Devices (used without cable ties) . . . . . | B2.30         |
|  | Adhesive Backed Mounting Devices . . . . .                          | B2.30         |
| F.<br>Index  | Clincher™ Adjustable Releasable Clamp . . . . .                     | B2.30         |

★ Represents new product offering.

## Table of Contents

|   |               |
|---|---------------|
| Adhesive Backed Cord Clips .....                                  | B2.31         |
| Push Mount Cord Clip .....  | B2.31         |
| “J” Clips .....   | B2.32         |
| A1C Type Clips .....  | B2.32         |
| A2C Type Clips .....  | B2.33         |
| Metal Adhesive Backed Cord Clips .....                            | B2.33         |
| Latching Wire Clips .....   | B2.34         |
| Bevel Entry Clips .....   | B2.35         |
| Adhesive Backed Dual Cord Clip .....                              | B2.36         |
| Adhesive Backed Mount Cord Clip .....                             | B2.36         |
| Vertical Cord Clips .....   | B2.36         |
| Adhesive Backed Latching Clips .....                              | B2.37         |
| Cable Holder – Adhesive Backed .....                              | B2.37         |
| Low Profile Flat Cable Mounts .....                               | B2.37         |
| Latching Flat Cable Mounts .....                                  | B2.38         |
| Latching Flat Cable Holders .....                                 | B2.38         |
| Flat Cable Clips .....  | B2.39         |
| Pan-Clamp™ Heavy Duty Fixed Diameter Clamps .....                 | B2.39         |
| Fixed Diameter Cable Clamps .....                                 | B2.40         |
| Wire Retainers .....  | B2.41         |
| Siding Clips .....  | B2.42         |
| Wire Standoffs .....  | B2.42         |
| Snap-In Clips .....   | B2.43         |
| Wire Saddles .....  | B2.43         |
| ★ Corrugated Tubing Holder with Push Mount .....                  | B2.44         |
| Harness Clips .....   | B2.44         |
| Optical Fiber Network Saddles .....                               | B2.45         |
| Nylon Edge Clips .....  | B2.45         |
| Wire Bundle Strap .....   | B2.45         |
| Circuit Board Posts .....   | B2.46         |
| Circuit Board Locking Supports .....                              | B2.46         |
| <b>Harness Board Accessories</b> .....                            | B2.47         |
| Elastic Retainers .....   | B2.47         |
| Elastic Retainers – ER Type .....                                 | B2.47         |
| Bundle Retainers .....  | B2.48         |
| Corner Posts .....  | B2.48         |
| T-Junction Fixture .....  | B2.48         |
| Wire End Holder .....   | B2.49         |
| Harness Board Nails .....   | B2.49         |
| Fanning Strip System .....  | B2.50         |
| Spring Wire Breakout System .....                                 | B2.50         |
| Tie Harness Mounts .....  | B2.51         |
| Harness Board Standoff Posts and Adapter .....                    | B2.51         |
| ★ Automatic Cable Tie Mounts .....                                | B2.52         |
| ★ Harness Board Fixtures .....                                    | B2.52         |
| Physical Properties and Colors of Cable Accessory Materials ..... | B2.53         |
| Application Chart .....   | B2.53         |
| Selection and Use of Adhesive Mounts .....                        | B2.54 – B2.55 |

## Stainless Steel Cable Ties and Accessories

|   |               |
|---|---------------|
| <b>Pan-Steel® System</b> .....  | B3.1          |
| Pan-Steel® Products Overview .....                                      | B3.2 – B3.3   |
| Features and Benefits – Pan-Steel® Cable Ties .....                     | B3.4          |
| Part Number System for Pan-Steel® Cable Ties .....                      | B3.5          |
| Pan-Steel® Self-Locking Cable Ties – MLT Series .....                   | B3.5 – B3.7   |
| Pan-Steel® Polyester Fully Coated Cable Ties – MLTFC Series .....       | B3.8          |
| Pan-Steel® Nylon 11 Selectively Coated Ties – MLTC Series .....         | B3.9          |
| Pan-Alum™ Aluminum Cable Ties – MLT Series .....                        | B3.10         |
| Pan-Steel® Double Wrapped Cable Ties – MLTD Series .....                | B3.11         |
| Pan-Steel® Custom Length Banding – MBS, MBH, MBEH and MBSH Series ..... | B3.12 – B3.13 |
| Pan-Steel® Custom Length Banding Heads – MTH Series .....               | B3.13         |
| GS4MT Hand Operated Installation Tool .....                             | B3.14         |
| Tool Tension Locking Kits .....   | B3.14         |
| ST2MT Installation Tool .....   | B3.15         |
| RT2HT and RT2HTN Installation Tools .....                               | B3.15         |
| HTMT Installation Tool .....  | B3.15         |
| PPTMT Pneumatic Installation Tool .....                                 | B3.16         |

★ Represents new product offering.

A.  
System  
Overview

## Table of Contents

B1.  
Cable Ties

|   |       |
|---|-------|
| ★ PBTMT Battery Powered Installation Tools                                | B3.16 |
| Features and Benefits – Pan-Steel® Retained Tension Ties – MRT/MRS Series | B3.17 |
| Part Number System for Pan-Steel® Retained Tension Ties – MRT Series      | B3.18 |

B2.  
Cable  
Accessories

|   |       |
|---|-------|
| ★ Pan-Steel® Retained Tension Ties – MRT Series                                       | B3.18 |
| Part Number System for Pan-Steel® 360° Radial Seal Retained Tension Ties – MRS Series | B3.19 |
| ★ Pan-Steel® 360° Radial Seal Retained Tension Ties – MRS Series                      | B3.19 |
| Retained Tension Installation Tools   | B3.20 |
| Features and Benefits – Pan-Steel® Strapping System                                   | B3.21 |

B3.  
Stainless  
Steel Ties

|   |       |
|---|-------|
| ★ The Panduit Method Reduces Installation Time    | B3.22 |
| Part Number System for Discrete Length Strapping  | B3.22 |
| ★ Pan-Steel® Strapping – MS Series                | B3.23 |
| Pan-Steel® Nylon 11 Coated Strapping – MSC Series | B3.24 |
| ★ Pan-Steel® Custom Length Strapping              | B3.25 |

C1.  
Wiring  
Duct

|  |       |
|--|-------|
| ★ Pan-Steel® Buckles for Custom Length Strapping             | B3.25 |
| BT2HT Hand Operated Installation Tool for Strapping          | B3.26 |
| ★ BT75SDT Hand Operated Installation Tool for MS75 Strapping | B3.26 |
| PCS Cushion Sleeve   | B3.26 |

C2.  
Surface  
Raceway

|                                   |       |
|-----------------------------------|-------|
| Stainless Steel Tie Mounts        | B3.27 |
| Stainless Steel Push Mount        | B3.27 |
| Stainless Steel Push Button Mount | B3.28 |
| Stainless Steel 2-Way Tie Mount   | B3.28 |
| Stainless Steel Bulkhead Mount    | B3.29 |

C3.  
Abrasion  
Protection

|   |       |
|---|-------|
| Stainless Steel Technical Information                     | B3.30 |
| Panduit Stainless Steel Cable Tie and Strapping Approvals | B3.30 |
| Chemical Resistance at 70°F (21°C) Temperature            | B3.31 |
| Rigorous Tests and Physical Properties of Stainless Steel | B3.32 |

C4.  
Cable  
Management

|                                    |       |
|------------------------------------|-------|
| Military Cross Reference (AS23190) | B3.32 |
|------------------------------------|-------|

## Wiring Duct

|                    |      |
|--------------------|------|
| <b>Wiring Duct</b> | C1.1 |
|--------------------|------|

D1.  
Terminals

|   |             |
|---|-------------|
| Wiring Duct for Control Panel Applications                      | C1.2 – C1.3 |
| Features and Benefits – Panduct® PanelMax™ DIN Rail Wiring Duct | C1.4        |

D2.  
Power  
Connectors

|   |      |
|---|------|
| ★ Panduct® PanelMax™ DIN Rail Wiring Duct                     | C1.5 |
| Features and Benefits – Panduct® PanelMax™ Noise Shield       | C1.6 |
| ★ Panduct® PanelMax™ Noise Shield                             | C1.7 |
| Features and Benefits – Panduct® PanelMax™ Corner Wiring Duct | C1.8 |
| PanelMax™ Corner Wiring Duct                                  | C1.9 |

D3.  
Grounding  
Connectors

|   |       |
|---|-------|
| Features and Benefits – Panduct® Type H and HN Hinged Cover Wiring Duct | C1.10 |
| Panduct® Type HN Hinged Cover Narrow Slot Wiring Duct                   | C1.11 |
| Panduct® Type H Hinged Cover Wide Slot Wiring Duct                      | C1.11 |
| Panduct® Type HS Hinged Cover Solid Wall Raceway                        | C1.11 |
| Features and Benefits – Panduct® Type G Wide Slot Wiring Duct           | C1.12 |
| Panduct® Type G Wide Slot Wiring Duct                                   | C1.13 |

E1.  
Labeling  
Systems

|  |       |
|--|-------|
| Features and Benefits – Panduct® Type F Narrow Slot Wiring Duct            | C1.14 |
| Panduct® Type F Narrow Slot Wiring Duct                                    | C1.15 |
| Features and Benefits – Panduct® Flush Cover Type D Round Hole Wiring Duct | C1.16 |
| Panduct® Flush Cover Type D Round Hole Wiring Duct                         | C1.17 |

E2.  
Labels

|   |               |
|---|---------------|
| Features and Benefits – Panduct® Type MC Metric Narrow Slot Wiring Duct | C1.18         |
| Panduct® Type MC Metric Narrow Slot Wiring Duct                         | C1.19         |
| Features and Benefits – Panduct® Type FS Solid Wall Raceway             | C1.20         |
| Panduct® Type FS Solid Wall Raceway                                     | C1.21         |
| Wiring Duct for Special Environments                                    | C1.22 – C1.24 |

E3.  
Pre-Printed  
& Write-On  
Markers

|   |       |
|---|-------|
| Features and Benefits – Panduct® Type NNC Halogen-Free Metric Wiring Duct | C1.22 |
| Panduct® Type NNC Halogen-Free Metric Wiring Duct                         | C1.23 |
| Panduct® Type NNC Divider Wall  | C1.23 |
| Panduct® Type NE Halogen-Free Wiring Duct                                 | C1.24 |

E4.  
Permanent  
Identification

|  |       |
|--|-------|
| <b>Wiring Duct Tools and Accessories</b>         | C1.25 |
| Panduct® Type FL Flexible Wiring Duct            | C1.26 |
| Panduct® Divider Wall                            | C1.26 |
| Panduct® Type NNC Divider Wall                   | C1.27 |
| Panduct® Type G and H Wiring Duct Wire Retainers | C1.28 |

E5.  
Lockout/  
Tagout  
& Safety  
Solutions

|  |       |
|--|-------|
| Panduct® Solid Wall Raceway Type FS and Type D Wiring Duct Wire Retainer | C1.28 |
| Panduct® Type F, HN, and MC Duct Wire Retainers/Labeling Device          | C1.29 |
| Panduct® Duct Corner Strip with 1 Inch Bend Radius Control               | C1.29 |
| Panduct® Duct Corner Strips  | C1.30 |
| Panduct® Snap-Clip Mounting Brackets                                     | C1.31 |

★ Represents new product offering.

## Table of Contents

|  |               |
|--|---------------|
| Panduct® Snap-Clip Mounting Bracket – Type NE Wiring Duct      | C1.31         |
| Adhesive Tape for Wiring Duct                                  | C1.32         |
| Specifications for Factory Applied Tape                        | C1.32         |
| Adhesive Tape Guide  | C1.33         |
| Panduct® Installation Tools                                    | C1.34         |
| Panduct® PanelMax™ DIN Rail Wiring Duct Dimensions             | C1.35         |
| Panduct® PanelMax™ Noise Shield Dimensions                     | C1.35         |
| Panduct® PanelMax™ Corner Wiring Duct Dimensions               | C1.35         |
| Panduct® Type G and D Wiring Duct Dimensions                   | C1.36         |
| Panduct® Type F Wiring Duct and FS Raceway Dimensions          | C1.37         |
| Panduct® Type MC Wiring Duct Dimensions                        | C1.38         |
| Panduct® Type NNC Wiring Duct Dimensions                       | C1.39         |
| Panduct® Type NE Wiring Duct Dimensions                        | C1.40         |
| Panduct® Type H and HS Wiring Duct Dimensions                  | C1.41         |
| Panduct® Type HN Wiring Duct Dimensions                        | C1.41         |
| Panduct® Type FL Wiring Duct Dimensions                        | C1.42         |
| Panduct® PanelMax™ DIN Rail Wiring Duct – Wirefill Capacity    | C1.42         |
| Panduct® PanelMax™ Corner Wiring Duct – Wirefill Capacity      | C1.42         |
| Panduct® Type H, HN and HS Wiring Duct – Wirefill Capacity     | C1.42         |
| Panduct® Type D, G, F and FS Wiring Duct – Wirefill Capacity   | C1.43         |
| Panduct® Type MC and NNC Wiring Duct – Wirefill Capacity       | C1.44         |
| Panduct® Type NE Wiring Duct – Wirefill Capacity               | C1.45         |
| Panduct® Type FL Wiring Duct – Wirefill Capacity               | C1.45         |
| Wirefill Formula   | C1.46         |
| Panduct® Wiring Duct and Raceway – Material Specifications     | C1.47         |
| Panduct® Wiring Duct and Raceway – Color and Size Selection    | C1.48         |
| Installation Tips  | C1.49         |
| Part Number System for Panduct® Wiring Duct                    | C1.49         |
| Part Number System for Panduct® PanelMax™ DIN Rail Wiring Duct | C1.50         |
| Part Number System for Panduct® PanelMax™ Corner Wiring Duct   | C1.50         |
| Panduct® Wiring Duct Approvals and Compliance                  | C1.51 – C1.52 |
| <b>Fiber-Duct™ Routing System</b>                              | C1.53         |
| 2x2 and 4x4 Fiber-Duct™ Routing Systems Roadmap                | C1.54 – C1.55 |
| 2x2 and 4x4 Fiber-Duct™ Routing Systems                        | C1.56         |
| Fiber-Duct™ System Fittings                                    | C1.56 – C1.57 |
| Fiber-Duct™ Spillouts  | C1.58         |
| Fiber-Duct™ Bend Radius Control Trumpets                       | C1.59         |
| Fiber-Duct™ Accessories  | C1.59         |
| Fiber-Duct™ Mounting Brackets                                  | C1.60 – C1.61 |
| Cable Fills 2x2 and 4x4 Fiber-Duct™ Cable Routing Systems      | C1.62         |

## Surface Raceway

|   |               |
|---|---------------|
| <b>Pan-Way® Metal Raceway</b>                                 | C2.1          |
| PMR40 Raceway Roadmap   | C2.2 – C2.3   |
| PMR40 Configurations  | C2.4          |
| Pan-Way® PMR40 Metal Raceway System                           | C2.5          |
| Pan-Way® PMR40 Metal Raceway Fittings                         | C2.5 – C2.6   |
| Cable Fill Capacities for PMR40 Metal Raceway                 | C2.7          |
| PMR5/7 Raceway Roadmap  | C2.8 – C2.9   |
| PMR5/PMR7 Configurations                                      | C2.10         |
| Pan-Way® PMR5/PMR7 Metal Raceway System                       | C2.11         |
| Pan-Way® PMR5/PMR7 Metal Raceway Fittings                     | C2.12         |
| PMR5 and PMR7 Raceway Accessories                             | C2.13         |
| Cable Fill Capacities for PMR5/PMR7 Metal Raceway             | C2.14         |
| Pan-Way® Metal Raceway Boxes                                  | C2.15 – C2.16 |
| Pan-Way® Metal Raceway Faceplates                             | C2.17         |
| <b>Pan-Way® Non-Metallic Surface Raceway</b>                  | C2.18         |
| <b>Pan-Way® TG-70 Non-Metallic Surface Raceway</b>            | C2.19         |
| TG-70 Raceway Roadmap   | C2.20 – C2.21 |
| TG-70 Configurations  | C2.22 – C2.23 |
| Pan-Way® TG-70 Surface Raceway System                         | C2.24         |
| Pan-Way® TG-70 Raceway Fittings                               | C2.25         |
| Pan-Way® TG-70 Raceway Accessories                            | C2.26         |
| Cable Fill Capacities for TG-70 Raceway                       | C2.27         |
| <b>Pan-Way® T-70 and Twin-70 Non-Metallic Surface Raceway</b> | C2.29         |
| T-70 Raceway Roadmap  | C2.30 – C2.31 |
| T-70 Configurations   | C2.32 – C2.33 |

★ Represents new product offering.



## Table of Contents

|  |  |
|--|--|
| A.<br>System<br>Overview                           |  |
| B1.<br>Cable Ties                                  | Twin-70 Raceway Roadmap . . . . . C2.34 – C2.35<br>Pan-Way® T-70 Surface Raceway System . . . . . C2.36<br>Pan-Way® T-70 Raceway Fittings . . . . . C2.36 – C2.37<br>Pan-Way® Twin-70 Surface Raceway System . . . . . C2.38   |
| B2.<br>Cable<br>Accessories                        | Pan-Way® Twin-70 Raceway Fittings . . . . . C2.39<br>Pan-Way® T-70 and Twin-70 Raceway Accessories . . . . . C2.40<br>Cable Fill Capacities for T-70 Raceway . . . . . C2.41<br>Cable Fill Capacities for Twin-70 Raceway . . . . . C2.42  |
| B3.<br>Stainless<br>Steel Ties                     | <b>Pan-Way® T-45 Non-Metallic Surface Raceway</b> . . . . . C2.43<br>T-45 Raceway Roadmap . . . . . C2.44 – C2.45<br>T-45 Configurations . . . . . C2.46 – C2.47<br>Pan-Way® T-45 Surface Raceway System . . . . . C2.48<br>Pan-Way® Type T-45 Raceway Fittings . . . . . C2.49<br>Cable Fill Capacities for T-45 Raceway . . . . . C2.50  |
| C1.<br>Wiring<br>Duct                              | <b>Pan-Way® Snap-On Faceplates and Surface Mount Outlet Boxes</b> . . . . . C2.51<br>Pan-Way® Fast-Snap™ Surface Mount Outlet Boxes . . . . . C2.52<br>Pan-Way® Classic Series Snap-On Faceplates for Use with Panduit® Mini-Com® Modules . . . . . C2.52<br>Component Labels for Pan-Way® Classic Series Snap-On Faceplates for Use with<br>Panduit® Mini-Com® Modules and Inserts . . . . . C2.52  |
| C2.<br>Surface<br>Raceway                          | Pan-Way® Classic Series Snap-On Faceplates for Use with Panduit® Mini-Com® Inserts . . . . . C2.53<br>Pan-Way® Classic Series Snap-On Faceplates for Communication/Power . . . . . C2.53<br>Panduit® NetKey® Snap-On Sloped Keystone Faceplates . . . . . C2.54<br>Panduit® NetKey® Snap-On Flush Universal Keystone Faceplates . . . . . C2.54<br>Component Labels for Snap-On “Sloped” (Keystone) Faceplates and Snap-On “Flush”<br>Universal (Keystone) Faceplates . . . . . C2.54  |
| C3.<br>Abrasion<br>Protection                      | Pan-Way® Snap-On Faceplates for SYSTIMAX® Communication Modules . . . . . C2.55<br>Component Labels for Pan-Way® Snap-On Faceplates for use with SYSTIMAX® Communication Modules . . . . . C2.55<br>Pan-Way® Snap-On Faceplates for Nordx/CDT** Communication Modules . . . . . C2.56<br>Pan-Way® Low Voltage Surface Mount Outlet Boxes . . . . . C2.57<br>Pan-Way® Power Rated Surface Mount Outlet Boxes . . . . . C2.58 – C2.59<br>Pan-Way® Classic Series Faceplates for Power and Communication Applications . . . . . C2.60<br>Component Labels for Pan-Way® Classic Series Faceplates for Power and Communication Applications . . . . . C2.60   |
| C4.<br>Cable<br>Management                         | Pan-Way® Stainless Steel Faceplates . . . . . C2.61<br>Pan-Way® Electrical Outlets . . . . . C2.61<br>Pan-Way® Surface Mount Outlet Box with 20 A Electrical Outlet . . . . . C2.61<br>Selection Chart for using Pan-Way® Surface Raceway with Pan-Way® Surface Mount Outlet Boxes . . . . . C2.62<br><b>Pan-Way® LD Profile Non-Metallic Surface Raceway</b> . . . . . C2.63<br>LD2P10 Profile Raceway Roadmap . . . . . C2.64 – C2.65<br>LD2P10 Configurations . . . . . C2.66 – C2.67<br>LD Profile Raceway Roadmap . . . . . C2.68 – C2.69<br>LD Configurations . . . . . C2.70 – C2.71<br>LDPH Profile Raceway Roadmap . . . . . C2.72 – C2.73<br>LDPH Configurations . . . . . C2.74<br>Pan-Way® Type LD2P10 Multi-Channel Surface Raceway System . . . . . C2.75<br>Multi-Channel Fittings for LD2P10 . . . . . C2.75 |
| D1.<br>Terminals                                   | Pan-Way® LD Surface Raceway System . . . . . C2.76<br>Pan-Way® LDPH Surface Raceway System . . . . . C2.77<br>Pan-Way® LDS Surface Raceway System . . . . . C2.78<br>Method for Bending Type LDS Raceway (Low Voltage Applications) . . . . . C2.78<br>Standard Fittings for Low Voltage Applications . . . . . C2.79<br>One Inch Bend Radius Fittings for TIA/EIA Compliance . . . . . C2.80<br>Power Rated Fittings for Power to 600 V – LDPH/LDS/LD2P Raceway Only . . . . . C2.81<br>Raceway Adapters for LD Raceway . . . . . C2.82<br>Cable Fill Capacities for LD Profile Raceway . . . . . C2.82   |
| D2.<br>Power<br>Connectors                         | ★ Floor Guard . . . . . C2.83<br>Pan-Way® Surface Raceway Cutting Tool . . . . . C2.83<br>Foam Tape . . . . . C2.84<br><b>Pan-Way® Cove Raceway</b> . . . . . C2.85<br>Cove Raceway Roadmap . . . . . C2.86 – C2.87<br>Cove Configurations . . . . . C2.88 – C2.89<br>Pan-Way® Cove Raceway System . . . . . C2.90<br>Pan-Way® Cove Raceway Fittings . . . . . C2.91<br>Cable Fill Capacities for Cove Raceway . . . . . C2.92   |
| D3.<br>Grounding<br>Connectors                     | <b>Pan-Way® Office Furniture Raceway</b> . . . . . C2.93<br>Office Furniture Raceway Roadmap . . . . . C2.94 – C2.95<br>Office Furniture Configurations . . . . . C2.96 – C2.97  |
| E1.<br>Labeling<br>Systems                         |  |
| E2.<br>Labels                                      |  |
| E3.<br>Pre-Printed<br>& Write-On<br>Markers        |  |
| E4.<br>Permanent<br>Identification                 |  |
| E5.<br>Lockout/<br>Tagout<br>& Safety<br>Solutions |  |
| F.<br>Index  |  |

\*SYSTIMAX is a registered trademark of Commscope, Inc.

\*\*Nordx/CDT is a registered trademark of Nordx/CDT, Inc.

★ Represents new product offering.

## Table of Contents

|   |                 |
|---|-----------------|
| Pan-Way® Office Furniture Raceway System .....                              | C2.98           |
| Pan-Way® Office Furniture Raceway Fittings .....                            | C2.98 – C2.101  |
| Cable Fill Capacities for Office Furniture Raceway .....                    | C2.102          |
| <b>Pan-Pole™ Power and Communication Poles</b> .....                        | C2.103          |
| Pan-Pole™ Power Pole .....  | C2.104          |
| Installation of Communication Outlets on Pan-Pole™ Power Pole .....         | C2.105 – C2.106 |
| Pan-Pole™ Communication Pole .....  | C2.107          |
| Installation of Communication Outlets on Pan-Pole™ Communication Pole ..... | C2.108 – C2.109 |
| Pan-Pole™ Extension Kits .....  | C2.110          |
| Pan-Pole™ Power Addition Kits and Standard Faceplate Bracket .....          | C2.110          |
| Pan-Pole™ Replacement Parts .....   | C2.111          |
| Cable Fill Capacities for Pan-Pole™ Power and Communication Poles .....     | C2.112          |

## Abrasion Protection

|  |               |
|--|---------------|
| <b>Abrasion Protection</b> .....   | C3.1          |
| Pan-Wrap™ Split Harness Wrap .....   | C3.2          |
| Pan-Wrap™ Installation Tools .....   | C3.3          |
| Part Number System for Spiral Wrap .....   | C3.3          |
| Spiral Wrap .....  | C3.4 – C3.7   |
| Part Number System for Grommet Edging .....  | C3.8          |
| Grommet Edging .....   | C3.8 – C3.10  |
| Part Number System for Corrugated Loom Tubing .....                                | C3.11         |
| Corrugated Loom Tubing – Slit and Solid Wall .....                                 | C3.11 – C3.13 |
| Corrugated Loom Tubing Fittings .....  | C3.14         |
| Part Number System for Braided Expandable Sleeving .....                           | C3.14         |
| Braided Expandable Sleeving – Polyethylene Terephthalate (PET) .....               | C3.15         |
| Braided Expandable Sleeving – Flame Retardant Polyethylene Terephthalate .....     | C3.16         |
| Tooling Head .....   | C3.16         |
| Fray Resistant Braided Expandable Sleeving .....                                   | C3.17         |
| Part Number System for Non-Shrink PVC Tubing .....                                 | C3.18         |
| Non-Shrink PVC Tubing .....  | C3.18         |
| Duct Seal – Sealing Compounds .....  | C3.18         |
| Flammability Tests and Materials Classification .....                              | C3.19         |
| Abrasion Protection Materials Technical Data .....                                 | C3.20 – C3.21 |
| Panduit® Heat Shrink Tubing Selection Guide .....                                  | C3.22         |
| Part Number System for Thin Wall Heat Shrink .....                                 | C3.23         |
| HSTT Heat Shrink 4 Foot Pieces and Reels .....                                     | C3.24 – C3.25 |
| HSTT Heat Shrink on 25 Foot Reels .....  | C3.25         |
| Heat Shrink in 6 Inch Pieces; Black, Single Diameter .....                         | C3.26         |
| Heat Shrink in 6 Inch Pieces; Multi-Color, Single Diameter .....                   | C3.26         |
| Heat Shrink in 6 Inch Pieces; Black, Multiple Diameters .....                      | C3.27         |
| Heat Shrink in 6 Inch Pieces; Yellow/Green Stripe, Multiple Diameters .....        | C3.27         |
| HSTTV Heat Shrink 4 Foot Pieces .....  | C3.28         |
| HSTTV Heat Shrink on 100 Foot Reels .....  | C3.29         |
| HSTTV Heat Shrink on Bulk Reels .....  | C3.30         |
| HSTTV Heat Shrink on 25 Foot Reels .....   | C3.31         |
| HSTTV Heat Shrink 6 Inch Pieces .....  | C3.31         |
| HSTTP PVC Heat Shrink .....  | C3.32         |
| HSTTPN Crystal Clear PVC Heat Shrink .....   | C3.33         |
| HSTTN Neoprene Heat Shrink .....   | C3.33         |
| TEFLON▲ Heat Shrink .....  | C3.34         |
| HSTTK KYNAR* Heat Shrink 4 Foot .....  | C3.35         |
| HSTTVA Heat Shrink 4 Foot Pieces and 6 Inch Pieces .....                           | C3.35 – C3.36 |
| HSTTA Heat Shrink 4 Foot and 6 Inch Pieces .....                                   | C3.36         |
| HSTT4A Heat Shrink 4 Foot Pieces .....   | C3.37         |
| HSTTRA Heat Shrink 4 Foot Pieces .....   | C3.37         |
| Thick Wall Polyolefin Heat Shrink .....  | C3.38         |
| Heat Shrink End Caps .....   | C3.39         |
| Plastic Heat Shrink Tubing Kit Boxes – For Dry Locations .....                     | C3.40         |
| Heat Shrink Tools and Accessories .....  | C3.40         |
| Heat Shrink Process Defined .....  | C3.41         |
| Heat Shrink Installation Instructions .....  | C3.42         |
| Recommended Tubing Size for Common Wire Types Based on Location .....              | C3.43         |
| Dry-Shrink™, Damp-Shrink™, and Wet-Shrink™ Heat Shrink Tubing Technical Data ..... | C3.44         |

## Cable Management

▲TEFLON is a registered trademark of E.I. du Pont de Nemours and Company. \*KYNAR is a registered trademark of Atofina Chemicals, Inc.

★ Represents new product offering.



A.  
System  
Overview

## Table of Contents

B1.  
Cable Ties

|  |             |
|--|-------------|
| <b>Cable Management</b> . . . . .          | C4.1        |
| Cool Boot™ Raised Floor Assembly . . . . . | C4.2 – C4.3 |
| J-Pro™ Cable Support System . . . . .      | C4.4 – C4.7 |
| J-Mod® Cable Support System . . . . .      | C4.8        |

B2.  
Cable  
Accessories

|   |       |
|---|-------|
| ★ Bridle Rings and Fastening Clip . . . . . | C4.9  |
| ★ Low Voltage Mounting Brackets . . . . .   | C4.9  |
| ★ Metal Stud Accessories . . . . .          | C4.10 |
| Conduit Waterfall . . . . .                 | C4.10 |
| Waterfall Accessories . . . . .             | C4.11 |

B3.  
Stainless  
Steel Ties

|  |       |
|--|-------|
| Double Waterfall Accessory . . . . .   | C4.11 |
| Stackable Cable Rack Spacers . . . . . | C4.12 |
| Threaded Rod Cover . . . . .           | C4.12 |
| Vertical D-Rings . . . . .             | C4.13 |

C1.  
Wiring  
Duct

|   |       |
|---|-------|
| Tak-Ty® Hook & Loop Cable Tie Mounts . . . . .            | C4.13 |
| Flat Pan-Post™ Standoffs . . . . .                        | C4.14 |
| Communication Cable Management Kit for Cabinets . . . . . | C4.14 |

## Terminals

C2.  
Surface  
Raceway

|   |      |
|---|------|
| <b>Pan-Term® Terminals</b> . . . . .                  | D1.1 |
| Features and Benefits – Pan-Term® Terminals . . . . . | D1.2 |
| Selection Guide – Pan-Term® Ring Terminals . . . . .  | D1.3 |
| Selection Guide – Pan-Term® Fork Terminals . . . . .  | D1.4 |

C3.  
Abrasion  
Protection

|  |      |
|--|------|
| Part Number System for Pan-Term® Terminals . . . . .           | D1.5 |
| Ring Terminal, Nylon Insulated . . . . .                       | D1.6 |
| Ring Terminal, Nylon Insulated – Funnel Entry . . . . .        | D1.7 |
| Ring Terminal, Nylon Insulated – Expanded Insulation . . . . . | D1.8 |

C4.  
Cable  
Management

|  |       |
|--|-------|
| Multiple Stud Terminal, Nylon Insulated . . . . .                | D1.8  |
| Ring Terminal, Vinyl Insulated – Funnel Entry . . . . .          | D1.9  |
| Ring Terminal, Vinyl Expanded Insulation . . . . .               | D1.10 |
| Multiple Stud Terminal, Vinyl Insulated – Funnel Entry . . . . . | D1.11 |

D1.  
Terminals

|   |       |
|---|-------|
| Ring Terminal, KYNAR* Insulated . . . . .                           | D1.12 |
| Heat Shrink, Ring Terminal . . . . .                                | D1.13 |
| Ring Terminal, Heavy Duty, Nylon Insulated . . . . .                | D1.13 |
| Ring Terminal, Heavy Duty, Vinyl Insulated – Funnel Entry . . . . . | D1.14 |
| Ring Terminal, Large Wire, Vinyl Insulated . . . . .                | D1.15 |

D2.  
Power  
Connectors

|  |       |
|--|-------|
| Ring Terminal, Large Wire, Vinyl Expanded Insulation . . . . . | D1.16 |
| Ring Terminal, Non-Insulated . . . . .                         | D1.17 |
| Multiple Stud Terminal, Non-Insulated . . . . .                | D1.18 |
| Ring Terminal, Non-Insulated – High Temperature . . . . .      | D1.19 |

D3.  
Grounding  
Connectors

|   |       |
|---|-------|
| Ring Terminal, Heavy Duty Non-Insulated . . . . . | D1.20 |
| Ring Terminal, Large Wire Non-Insulated . . . . . | D1.20 |
| Tubular Ring Terminal, Non-Insulated . . . . .    | D1.21 |
| Fork Terminal, Nylon Insulated . . . . .          | D1.22 |

E1.  
Labeling  
Systems

|  |       |
|--|-------|
| Fork Terminal, Nylon Insulated – Funnel Entry . . . . .        | D1.22 |
| Fork Terminal, Vinyl Insulated – Funnel Entry . . . . .        | D1.23 |
| Fork Terminal, Vinyl Insulated – Expanded Insulation . . . . . | D1.24 |
| Locking Fork Terminal, Nylon Insulated . . . . .               | D1.24 |

E2.  
Labels

|  |       |
|--|-------|
| Locking Fork Terminal, Nylon Insulated – Funnel Entry . . . . .        | D1.25 |
| Locking Fork Terminal, Vinyl Insulated – Funnel Entry . . . . .        | D1.25 |
| Locking Fork Terminal, Vinyl Insulated – Expanded Insulation . . . . . | D1.26 |
| Short Locking Fork Terminal, Nylon Insulated . . . . .                 | D1.26 |

E3.  
Pre-Printed  
& Write-On  
Markers

|   |       |
|---|-------|
| Short Locking Fork Terminal, Nylon Insulated – Funnel Entry . . . . . | D1.27 |
| Short Locking Fork Terminal, Vinyl Insulated – Funnel Entry . . . . . | D1.27 |
| Flanged Fork Terminal, Nylon Insulated . . . . .                      | D1.28 |
| Flanged Fork Terminal, Vinyl Insulated – Funnel Entry . . . . .       | D1.28 |

E4.  
Permanent  
Identification

|  |       |
|--|-------|
| Fork Terminal, Non-Insulated . . . . .               | D1.29 |
| Flanged Fork Terminal, Non-Insulated . . . . .       | D1.30 |
| Locking Fork Terminal, Non-Insulated . . . . .       | D1.30 |
| Short Locking Fork Terminal, Non-Insulated . . . . . | D1.31 |
| Heat Shrink, Fork Terminal . . . . .                 | D1.31 |

E5.  
Lockout/  
Tagout  
& Safety  
Solutions

|  |       |
|--|-------|
| Features and Benefits – Pan-Term® Metric Terminals . . . . .   | D1.32 |
| Part Number System for Pan-Term® Metric Terminals . . . . .    | D1.33 |
| Metric Ring Terminal, Nylon Insulated – Funnel Entry . . . . . | D1.33 |
| Metric Ring Terminal, Vinyl Insulated – Funnel Entry . . . . . | D1.34 |

F.  
Index

|  |       |
|--|-------|
| Metric Ring Terminal, Non-Insulated . . . . .                  | D1.34 |
| Metric Fork Terminal, Nylon Insulated – Funnel Entry . . . . . | D1.35 |
| Metric Fork Terminal, Vinyl Insulated – Funnel Entry . . . . . | D1.35 |
| Metric Fork Terminal, Non-Insulated . . . . .                  | D1.36 |

★ Represents new product offering.

\*KYNAR is a registered trademark of Atofina Chemicals, Inc.

## Table of Contents

|  |               |
|--|---------------|
| Plastic Box Terminal Kits .....  | D1.36         |
| ★ Fabric Terminal Kit .....  | D1.36         |
| Steel Kit Boxes .....  | D1.37         |
| Steel Slide Racks .....  | D1.37         |
| Industrial Maintenance Kits .....  | D1.38         |
| <b>Pan-Term® Disconnects</b> .....   | D1.39         |
| Features and Benefits – Pan-Term® Disconnects .....                              | D1.40 – D1.41 |
| Selection Guide – Pan-Term® Disconnects .....                                    | D1.42         |
| Part Number System for Pan-Term® Disconnects .....                               | D1.43         |
| Supra-Grip™ Female Disconnect, Nylon Fully Insulated – Funnel Entry .....        | D1.43         |
| Disco-Lok™ Female Disconnect, Nylon Fully Insulated – Funnel Entry .....         | D1.44         |
| Male/Female Coupler, Nylon Fully Insulated – Funnel Entry .....                  | D1.44         |
| Female Disconnect Nylon Fully Insulated – Funnel Entry .....                     | D1.45         |
| Female Disconnect, Nylon Fully Insulated – Funnel Entry, Metal Collar .....      | D1.45         |
| DiscoGrip™ Male Disconnect, Premium Nylon Fully Insulated – Funnel Entry .....   | D1.46         |
| DiscoGrip™ Female Disconnect, Premium Nylon Fully Insulated – Funnel Entry ..... | D1.46         |
| Heat Shrink Disconnects, Fully Insulated – Funnel Entry .....                    | D1.47         |
| Female Disconnect, Nylon Barrel Insulated – Funnel Entry .....                   | D1.47         |
| Female Disconnect, Vinyl Barrel Insulated – Funnel Entry .....                   | D1.48         |
| Female Disconnect, Vinyl Barrel Insulated – Butted Seam .....                    | D1.48         |
| Female Disconnect, Non-Insulated – Metal Sleeve .....                            | D1.49         |
| Right Angle Female Disconnect, Nylon Fully Insulated – Funnel Entry .....        | D1.49         |
| Right Angle Female Disconnect, Nylon Insulated – Funnel Entry .....              | D1.50         |
| Right Angle Female Disconnect, Non-Insulated – Metal Sleeve .....                | D1.50         |
| Right Angle Female Disconnect Non-Insulated .....                                | D1.51         |
| Piggyback Disconnect, Vinyl Insulated .....                                      | D1.51         |
| Disconnect Adapter, Non-Insulated .....  | D1.51         |
| Male Disconnect, Nylon Barrel Insulated – Funnel Entry .....                     | D1.52         |
| Male Disconnect, Vinyl Barrel Insulated – Funnel Entry .....                     | D1.52         |
| Male Disconnect, Non-Insulated – Butted Seam .....                               | D1.53         |
| Selection Guide – Specialty Terminals .....                                      | D1.54         |
| Pin Terminal, Vinyl Insulated – Funnel Entry .....                               | D1.54         |
| Pin Terminal, Non-Insulated .....  | D1.54         |
| Male Blade Adapter, Vinyl Insulated – Funnel Entry .....                         | D1.55         |
| Male Blade Adapter, Non-Insulated .....  | D1.55         |
| Features and Benefits – Pan-Term® Metric Disconnects .....                       | D1.56         |
| Part Number System for Pan-Term® Metric Disconnects .....                        | D1.57         |
| Female Metric Disconnect, Fully Insulated Nylon – Funnel Entry .....             | D1.57         |
| Female Metric Disconnect, Nylon Barrel Insulated – Funnel Entry .....            | D1.58         |
| Female Metric Disconnect, Vinyl Barrel Insulated – Funnel Entry .....            | D1.58         |
| Female Metric Disconnect, Non-Insulated – Metal Sleeve .....                     | D1.58         |
| Piggyback Metric Disconnect, Vinyl Barrel Insulated .....                        | D1.59         |
| Male Metric Disconnect, Fully Insulated Nylon – Funnel Entry .....               | D1.59         |
| Male Metric Disconnect, Nylon Barrel Insulated – Funnel Entry .....              | D1.59         |
| Male Metric Disconnect, Non-Insulated – Butted Seam .....                        | D1.60         |
| Metric Pin Terminal, Vinyl Insulated – Funnel Entry .....                        | D1.60         |
| Metric Pin Terminal, Non-Insulated .....   | D1.60         |
| <b>Pan-Term® Splices</b> .....   | D1.61         |
| Features and Benefits – Pan-Term® Splices and Wire Joints .....                  | D1.62 – D1.63 |
| Selection Guide – Pan-Term® Splices and Wire Joints .....                        | D1.64         |
| Part Number System for Pan-Term® Splices .....                                   | D1.64         |
| Part Number System for Pan-Term® Wire Joints .....                               | D1.64         |
| Butt Splice, Nylon Insulated .....   | D1.65         |
| Butt Splice, Vinyl Insulated .....   | D1.65         |
| Butt Splice, Non-Insulated .....   | D1.66         |
| Parallel Splice, Nylon Insulated .....   | D1.66         |
| Parallel Splice, Non-Insulated .....   | D1.67         |
| Wire Joint, Nylon Insulated .....  | D1.67         |
| Wire Joint, Non-Insulated .....  | D1.68         |
| Heat Shrink, Butt Splices .....  | D1.68         |
| Metric Butt Splice, Vinyl Insulated .....  | D1.68         |
| Metric Butt Splice, Non-Insulated .....  | D1.69         |
| Metric Wire Joints, Nylon Insulated .....  | D1.69         |
| <b>Pan-Term® Ferrules</b> .....  | D1.70         |
| Features and Benefits – Pan-Term® Ferrules .....                                 | D1.71         |
| Selection Guide – Pan-Term® Ferrules .....                                       | D1.72         |
| Part Number System for Pan-Term® Ferrules .....                                  | D1.72         |
| Insulated Ferrules – Single Wire DIN End Sleeve .....                            | D1.73         |
| Insulated Ferrules – Single Wire French End Sleeve .....                         | D1.74         |
| Insulated Ferrules – Twin Wire DIN End Sleeve .....                              | D1.75         |

★ Represents new product offering.

## Table of Contents

|  |  |
|--|--|
| A.<br>System<br>Overview                           |  |
| B1.<br>Cable Ties                                  | Insulated Ferrules on Strips – Single Wire .....D1.75<br>Ferrules, Non-Insulated .....D1.76 – D1.77<br>Ferrule Assortment Kits .....D1.78<br><b>Terminal Crimping Tools</b> .....D1.79<br>Crimping Guidelines for Panduit® Pan-Term® Terminals, Disconnects, Splices and Wire Joints .....D1.80 – D1.82<br>Hand Operated Plier Type Tools .....D1.83<br>Wire and Cable Stripping Tools .....D1.83<br>Contour Crimp™ Controlled Cycle Tools .....D1.84<br>Controlled Cycle Crimping Tools .....D1.85<br>Controlled Cycle Crimping Tools – Ferrule End Sleeve .....D1.85<br>Semiautomatic Ferrule Crimping Tool CT-1000 .....D1.86<br>Controlled Cycle Crimping Tools – In-Line .....D1.86<br>Pneumatic Crimping Tool .....D1.86<br>Die Type, Manual, Crimping Tool .....D1.87<br>CD-720 Crimping Dies .....D1.87<br>CT-2500 Battery Powered Crimping Tool .....D1.88<br>★ CT-2600 Battery Powered Hydraulic, 4 Ton, Crimping Tool .....D1.89<br>Tooling Selection Guide for Panduit Terminals, Splices, and Disconnects .....D1.90 – D1.92<br>Tooling Selection Guide for Panduit Tubular Ring Terminals .....D1.93<br>Tooling Selection Guide for Panduit Ferrules .....D1.94<br>Technical Specification and Selection Information .....D1.95<br>Panduit Terminal Approvals .....D1.95<br>Performance Requirements .....D1.96<br>Panduit® Pan-Term® Terminal Military Cross Reference .....D1.96<br>Stud Size Chart (Inches/mm) .....D1.97<br>Equivalent Tables .....D1.98<br>Common Conductor Size Chart (Stranded Wire) .....D1.98<br>Common Conductor Sizes and Strandings Reference Chart .....D1.99 – D1.100<br><b>Reel Smart™ System</b> .....D1.101<br>Features and Benefits – Reel Smart™ Termination System .....D1.102<br>Reel Smart™ CA9 Ezair™ Universal Applicator .....D1.102<br>Nylon Insulated Terminals with Insulation Grip Sleeve (Funnel and Non-Funnel Entry Types) .....D1.102<br>Part Number System for Reel Smart™ Terminals .....D1.103<br>Ring Terminals, Nylon Insulated – Non-Funnel Entry .....D1.103<br>Ring Terminals, Nylon Insulated – Funnel Entry .....D1.104<br>Ring Terminals, Vinyl Insulated – Funnel Entry .....D1.105<br>Multiple Stud Ring Terminals, Vinyl Insulated – Funnel Entry .....D1.105<br>Ring Terminals, Nylon Insulated – Heavy Duty .....D1.106<br>Ring Terminals, Vinyl Insulated – Heavy Duty .....D1.106<br>Fork Terminals, Nylon Insulated – Non-Funnel Entry .....D1.107<br>Fork Terminals, Nylon Insulated – Funnel Entry .....D1.108<br>Fork Terminals, Vinyl Insulated – Funnel Entry .....D1.109<br>Locking Fork Terminals, Nylon Insulated – Non-Funnel Entry .....D1.110<br>Locking Fork Terminals, Nylon Insulated – Funnel Entry .....D1.110<br>Locking Fork Terminals, Vinyl Insulated – Funnel Entry .....D1.111<br>Short Locking Fork Terminals, Nylon Insulated – Non-Funnel Entry .....D1.112<br>Short Locking Fork Terminals, Nylon Insulated – Funnel Entry .....D1.112<br>Short Locking Fork Terminals, Vinyl Insulated – Funnel Entry .....D1.113<br>Flanged Fork Terminals, Nylon Insulated – Non-Funnel Entry .....D1.113<br>Flanged Fork Terminals, Nylon Insulated – Funnel Entry .....D1.114<br>Flanged Fork Terminals, Vinyl Insulated – Funnel Entry .....D1.114<br>Features and Benefits – Reel Smart™ Metric Terminals .....D1.115<br>Part Number System for Reel Smart™ Metric Terminals .....D1.115<br>Metric Ring Terminals, Nylon Insulated – Non-Funnel Entry .....D1.116<br>Metric Ring Terminals, Nylon Insulated – Funnel Entry .....D1.117<br>Metric Ring Terminals, Vinyl Insulated – Funnel Entry .....D1.118<br>Metric Fork Terminals, Nylon Insulated – Non-Funnel Entry .....D1.119<br>Metric Fork Terminals, Nylon Insulated – Funnel Entry .....D1.119<br>Metric Fork Terminals, Vinyl Insulated – Funnel Entry .....D1.120<br>Features and Benefits – Reel Smart™ Disconnects .....D1.121<br>Part Number System for Reel Smart™ Disconnects .....D1.122<br>Supra-Grip™ Female Disconnects, Nylon Fully Insulated – Funnel Entry .....D1.122<br>Disco-Lok™ Female Disconnects, Nylon Fully Insulated – Funnel Entry .....D1.123<br>Female Disconnects, Nylon Fully Insulated – Funnel Entry .....D1.123<br>Disco™ Female Disconnects, Nylon Fully Insulated – Expanded Wire Entry .....D1.124<br>Disco™ Female Disconnects, Nylon Fully Insulated – Right Angle .....D1.124<br>Disco™ Female Disconnects, Vinyl Barrel Insulated – Funnel Entry .....D1.125<br>DiscoGrip™ Female Disconnects, Fully Insulated .....D1.126<br>DiscoGrip™ Male Disconnects, Fully Insulated .....D1.127<br>Disco™ Male Disconnects, Nylon Fully Insulated – Funnel Entry .....D1.128 |
| B2.<br>Cable<br>Accessories                        |  |
| B3.<br>Stainless<br>Steel Ties                     |  |
| C1.<br>Wiring<br>Duct                              |  |
| C2.<br>Surface<br>Raceway                          |  |
| C3.<br>Abrasion<br>Protection                      |  |
| C4.<br>Cable<br>Management                         |  |
| D1.<br>Terminals                                   |  |
| D2.<br>Power<br>Connectors                         |  |
| D3.<br>Grounding<br>Connectors                     |  |
| E1.<br>Labeling<br>Systems                         |  |
| E2.<br>Labels                                      |  |
| E3.<br>Pre-Printed<br>& Write-On<br>Markers        |  |
| E4.<br>Permanent<br>Identification                 |  |
| E5.<br>Lockout/<br>Tagout<br>& Safety<br>Solutions |  |
| F.<br>Index  |  |

★ Represents new product offering.

## Table of Contents

|   |                 |
|---|-----------------|
| Disco™ Male Disconnects, Nylon Fully Insulated – Expanded Wire Entry . . . . .                                  | D1.128          |
| Disco™ Male Disconnects, Nylon Barrel Insulated – Funnel Entry . . . . .  | D1.129          |
| Disco™ Male Disconnects, Vinyl Barrel Insulated – Funnel Entry . . . . .  | D1.129          |
| Pin Terminals, Vinyl Insulated – Funnel Entry . . . . .   | D1.130          |
| Male Blade Adapters, Vinyl Insulated – Funnel Entry . . . . .   | D1.130          |
| Butt Splices Nylon Insulated and Premium Grade Nylon . . . . .  | D1.130          |
| Features and Benefits – Reel Smart™ Metric Disconnects . . . . .  | D1.131          |
| Part Number System for Reel Smart™ Metric Disconnects . . . . .   | D1.132          |
| Metric Supra-Grip™ Female Disconnects, Nylon Fully Insulated – Funnel Entry . . . . .                           | D1.132          |
| Metric Disco-Lok™ Female Disconnects, Nylon Fully Insulated – Funnel Entry . . . . .                            | D1.133          |
| Metric Female Disconnects, Nylon Fully Insulated – Funnel Entry . . . . .                                       | D1.133          |
| Metric Disco™ Female Disconnects, Nylon Fully Insulated – Expanded Wire Entry . . . . .                         | D1.134          |
| Metric Disco™ Female Disconnects, Nylon Fully Insulated – Right Angle . . . . .                                 | D1.134          |
| Metric Disco™ Female Disconnects, Vinyl Barrel Insulated – Funnel Entry . . . . .                               | D1.135          |
| Metric DiscoGrip™ Female Disconnects, Fully Insulated – Funnel Entry . . . . .                                  | D1.135          |
| Metric DiscoGrip™ Male Disconnects, Fully Insulated – Funnel Entry . . . . .                                    | D1.136          |
| Metric Disco™ Male Disconnects, Nylon Fully Insulated – Funnel Entry . . . . .                                  | D1.136          |
| Metric Disco™ Male Disconnects, Nylon Fully Insulated – Expanded Wire Entry . . . . .                           | D1.137          |
| Metric Disco™ Male Disconnects, Nylon Barrel Insulated – Funnel Entry . . . . .                                 | D1.137          |
| Metric Disco™ Male Disconnects, Vinyl Barrel Insulated – Funnel Entry . . . . .                                 | D1.138          |
| Metric Pin Terminals, Vinyl Insulated – Funnel Entry . . . . .  | D1.138          |
| Metric Male Blade Adapters, Vinyl Insulated – Funnel Entry . . . . .  | D1.139          |
| Metric Butt Splices, Nylon Insulated . . . . .  | D1.139          |
| Features and Benefits – Reel Smart™ Ferrules . . . . .  | D1.140          |
| Part Number System for Reel Smart™ Ferrules . . . . .   | D1.140          |
| Insulated Ferrules on Strips – Single Wire . . . . .  | D1.141          |
| Semiautomatic Ferrule Crimping Tool – CT-1000 . . . . .   | D1.142          |
| Insulated Ferrules on Reels – Single Wire . . . . .   | D1.142          |
| Reel Smart™ Ferrule Applicator – CA10 . . . . .   | D1.143          |
| CA9 Ezair™ and CA-800EZ Applicators . . . . .   | D1.143          |
| Electric Bench Press . . . . .  | D1.144          |
| Die Sharpening Kits . . . . .   | D1.144          |
| Die Information . . . . .   | D1.145 – D1.146 |
| CA10, CA9 Ezair™ and CA-800EZ Applicators Wire Processing Machine<br>Manufacturer/Press Compatibility . . . . . | D1.147          |
| Performance Requirements . . . . .  | D1.148          |

## Power Connectors

|  |               |
|--|---------------|
| Compression Connector Reference Information . . . . .  | D2.0          |
| <b>Pan-Lug™ Compression Connectors</b> . . . . .   | D2.1          |
| Features and Benefits – Pan-Lug™ Compression Connectors . . . . .  | D2.2          |
| Selection Guide – Pan-Lug™ Copper Compression Connectors for Copper Code Conductor . . . . .               | D2.3          |
| Selection Guide – Pan-Lug™ Copper Compression Connectors for Copper Code and/or Flex Conductor . . . . .   | D2.4          |
| Selection Guide – Pan-Lug™ Aluminum Compression Connectors for Aluminum or Copper Code Conductor . . . . . | D2.5          |
| Part Number System for Pan-Lug™ Compression AWG Lugs . . . . .   | D2.6          |
| Code Conductor, One-Hole, Short Barrel with Window Lug . . . . .   | D2.7 – D2.8   |
| Code Conductor, One-Hole, Short Barrel with Window Lug, 45° Angle . . . . .                                | D2.9 – D2.10  |
| Code Conductor, One-Hole, Short Barrel with Window Lug, 90° Angle . . . . .                                | D2.11 – D2.12 |
| Code Conductor, One-Hole, Standard Barrel with Window Lug . . . . .  | D2.13 – D2.14 |
| Code Conductor, One-Hole, Standard Barrel with Window Lug, 45° Angle . . . . .                             | D2.15 – D2.16 |
| Code Conductor, One-Hole, Standard Barrel with Window Lug, 90° Angle . . . . .                             | D2.17 – D2.18 |
| Code Conductor, One-Hole, Standard Barrel with Window, Narrow Tongue Lug . . . . .                         | D2.19 – D2.20 |
| Code Conductor, Short Blank Tongue, Standard Barrel with Window Lug . . . . .                              | D2.21         |
| Code Conductor, One-Hole, Long Barrel Lug . . . . .  | D2.22 – D2.23 |
| Code Conductor, One-Hole, Long Barrel Lug, 45° Angle . . . . .   | D2.24 – D2.25 |
| Code Conductor, One-Hole, Long Barrel Lug, 90° Angle . . . . .   | D2.26 – D2.27 |
| Code Conductor, One-Hole, Long Barrel with Window Lug . . . . .  | D2.28         |
| Code Conductor, One-Hole, Long Barrel with Window Lug, 45° Angle . . . . .                                 | D2.29         |
| Code Conductor, One-Hole, Long Barrel with Window Lug, 90° Angle . . . . .                                 | D2.29         |
| Code Conductor, One-Hole, Long Barrel with Corona Relief Taper Lug . . . . .                               | D2.30         |
| Code Conductor, Two-Hole, Standard Barrel with Window Lug . . . . .  | D2.31 – D2.32 |
| Code Conductor, Two-Hole, Standard Barrel with Window Lug, 45° Angle . . . . .                             | D2.33 – D2.34 |
| Code Conductor, Two-Hole, Standard Barrel with Window Lug, 90° Angle . . . . .                             | D2.35 – D2.36 |
| Code Conductor, Two-Hole, Standard Barrel with Window, Narrow Tongue Lug . . . . .                         | D2.37         |
| Code Conductor, Two-Hole, Standard Barrel with Window, Narrow Tongue Lug, 45° . . . . .                    | D2.38         |
| Code Conductor, Two-Hole, Standard Barrel with Window, Narrow Tongue Lug, 90° . . . . .                    | D2.39         |
| Code Conductor, Long Blank Tongue, Standard Barrel with Window Lug . . . . .                               | D2.40         |
| Code Conductor, Two-Hole, Long Barrel Lug . . . . .  | D2.41 – D2.42 |
| Code Conductor, Two-Hole, Long Barrel Lug, 45° Angle . . . . .   | D2.43 – D2.44 |

★ Represents new product offering.

|  |
|--|
| A.<br>System<br>Overview                           |
| B1.<br>Cable Ties                                  |
| B2.<br>Cable<br>Accessories                        |
| B3.<br>Stainless<br>Steel Ties                     |
| C1.<br>Wiring<br>Duct                              |
| C2.<br>Surface<br>Raceway                          |
| C3.<br>Abrasion<br>Protection                      |
| C4.<br>Cable<br>Management                         |
| D1.<br>Terminals                                   |
| D2.<br>Power<br>Connectors                         |
| D3.<br>Grounding<br>Connectors                     |
| E1.<br>Labeling<br>Systems                         |
| E2.<br>Labels                                      |
| E3.<br>Pre-Printed<br>& Write-On<br>Markers        |
| E4.<br>Permanent<br>Identification                 |
| E5.<br>Lockout/<br>Tagout<br>& Safety<br>Solutions |
| F.<br>Index  |

## Table of Contents

A.  
System  
Overview

B1.  
Cable Ties

B2.  
Cable  
Accessories

B3.  
Stainless  
Steel Ties

C1.  
Wiring  
Duct

C2.  
Surface  
Raceway

C3.  
Abrasion  
Protection

C4.  
Cable  
Management

D1.  
Terminals

D2.  
Power  
Connectors

D3.  
Grounding  
Connectors

E1.  
Labeling  
Systems

E2.  
Labels

E3.  
Pre-Printed  
& Write-On  
Markers

E4.  
Permanent  
Identification

E5.  
Lockout/  
Tagout  
& Safety  
Solutions

F.  
Index

|   |                 |
|---|-----------------|
| Code Conductor, Two-Hole, Long Barrel Lug, 90° Angle . . . . .                              | D2.45 – D2.46   |
| Code Conductor, Two-Hole, Long Barrel with Window Lug . . . . .                             | D2.47 – D2.49   |
| Code Conductor, Two-Hole, Long Barrel with Window Lug, 45° Angle . . . . .                  | D2.50 – D2.52   |
| Code Conductor, Two-Hole, Long Barrel with Window Lug, 90° Angle . . . . .                  | D2.53 – D2.55   |
| Code Conductor, Two-Hole, Long Barrel with Window, Narrow Tongue Lug . . . . .              | D2.55           |
| Code Conductor, Two-Hole, Long Barrel with Corona Relief Taper Lug . . . . .                | D2.56           |
| Code Conductor, Blank Tongue, Long Barrel Lug . . . . .                                     | D2.57           |
| Code Conductor, Blank Tongue, Long Barrel with Window Lug . . . . .                         | D2.58           |
| Code Conductor, Short Barrel, Butt Splice . . . . .   | D2.59           |
| Code Conductor, Standard Barrel, Butt Splice . . . . .                                      | D2.60           |
| Code Conductor, Long Barrel, Butt Splice . . . . .  | D2.61           |
| Code Conductor, Long Barrel with Corona Relief Taper Splice . . . . .                       | D2.62           |
| Code Conductor, Long Barrel, T Splice . . . . .   | D2.63           |
| Code Conductor, Color-Coded Parallel Splice . . . . .                                       | D2.64 – D2.65   |
| Flex Conductor, One-Hole, Standard Barrel with Window Lug . . . . .                         | D2.66 – D2.67   |
| Flex Conductor, One-Hole, Standard Barrel with Window Lug, 45° Angle . . . . .              | D2.68 – D2.69   |
| Flex Conductor, One-Hole, Standard Barrel with Window Lug, 90° Angle . . . . .              | D2.70 – D2.71   |
| Flex Conductor, One-Hole, Standard Barrel with Window, Narrow Tongue Lug . . . . .          | D2.72           |
| Flex Conductor, One-Hole, Standard Barrel with Window, Flared NEBS Lug . . . . .            | D2.73 – D2.74   |
| Flex Conductor, One-Hole, Standard Barrel with Window, Flared NEBS Lug, 45° Angle . . . . . | D2.75 – D2.76   |
| Flex Conductor, One-Hole, Standard Barrel with Window, Flared NEBS Lug, 90° Angle . . . . . | D2.77 – D2.78   |
| Flex Conductor, One-Hole, Long Barrel with Window Lug . . . . .                             | D2.79           |
| Flex Conductor, One-Hole, Long Barrel with Window Lug, 45° Angle . . . . .                  | D2.80           |
| Flex Conductor, One-Hole, Long Barrel with Window Lug, 90° Angle . . . . .                  | D2.81           |
| Flex Conductor, Two-Hole, Standard Barrel with Window Lug . . . . .                         | D2.82 – D2.83   |
| Flex Conductor, Two-Hole, Standard Barrel with Window Lug, 45° Angle . . . . .              | D2.84 – D2.85   |
| Flex Conductor, Two-Hole, Standard Barrel with Window Lug, 90° Angle . . . . .              | D2.86 – D2.87   |
| Flex Conductor, Two-Hole, Standard Barrel with Window, Narrow Tongue Lug . . . . .          | D2.88           |
| Flex Conductor, Two-Hole, Standard Barrel with Window, Narrow Tongue Lug, 45° . . . . .     | D2.89           |
| Flex Conductor, Two-Hole, Standard Barrel with Window, Narrow Tongue Lug, 90° . . . . .     | D2.89           |
| Flex Conductor, Two-Hole, Long Barrel with Window Lug . . . . .                             | D2.90 – D2.91   |
| Flex Conductor, Two-Hole, Long Barrel with Window Lug, 45° Angle . . . . .                  | D2.92 – D2.93   |
| Flex Conductor, Two-Hole, Long Barrel with Window Lug, 90° Angle . . . . .                  | D2.94 – D2.95   |
| ★ Flex Conductor, Two-Hole, Long Barrel with Window, Narrow Tongue Lug . . . . .            | D2.95           |
| Flex Conductor, Two-Hole, Long Barrel, Flared NEBS Lug . . . . .                            | D2.96 – D2.97   |
| Flex Conductor, Two-Hole, Long Barrel, Flared NEBS Lug, 45° Angle . . . . .                 | D2.98 – D2.99   |
| Flex Conductor, Two-Hole, Long Barrel, Flared NEBS Lug, 90° Angle . . . . .                 | D2.100 – D2.101 |
| Flex Conductor, Standard Barrel, Flared, NEBS Butt Splice . . . . .                         | D2.102          |
| Code/Flex Conductor, with Window, In-Line Reducing Splice Kit . . . . .                     | D2.103 – D2.104 |
| Code/Flex Conductor, with Window, In-Line Reducing Splice . . . . .                         | D2.105 – D2.106 |
| Part Number System for Metric Lugs . . . . .  | D2.107          |
| Metric Conductor, One-Hole, Standard Barrel with Window Lug . . . . .                       | D2.107 – D2.108 |
| Metric Conductor, Two-Hole, Standard Barrel with Window Lug . . . . .                       | D2.109 – D2.110 |
| Metric Conductor, Standard Barrel, Butt Splice . . . . .                                    | D2.111          |
| Code Conductor, One-Hole, Aluminum Lug . . . . .  | D2.112          |
| Code Conductor, Two-Hole, Aluminum Lug . . . . .  | D2.113          |
| Belleville Compression Washers . . . . .  | D2.114          |
| Code Conductor, Aluminum Splice . . . . .   | D2.115          |
| Code Conductor, Aluminum, Reducing Splice . . . . .   | D2.116          |
| Code Conductor, Aluminum, Bi-Metallic Pin Connector . . . . .                               | D2.117          |
| Joint Compounds . . . . .   | D2.118          |
| <b>Pan-Lug™ Mechanical Connectors</b> . . . . .   | D2.119          |
| Features and Benefits – Pan-Lug™ Mechanical Connectors . . . . .                            | D2.120          |
| Selection Guide – Pan-Lug™ Mechanical Connectors, Cast Copper . . . . .                     | D2.121          |
| Selection Guide – Pan-Lug™ Mechanical Connectors, Stamped and Formed . . . . .              | D2.122          |
| Selection Guide – Pan-Lug™ Mechanical Connectors, Aluminum . . . . .                        | D2.123          |
| Selection Guide – Pan-Lug™ Mechanical Connectors, Split Bolts and Multi-Taps . . . . .      | D2.124          |
| Split Bolt, Copper . . . . .  | D2.125          |
| Split Bolt, Copper, Tin-Plated . . . . .  | D2.126          |
| Split Bolt, Aluminum . . . . .  | D2.127          |
| Two-Bolt Connector, Bronze . . . . .  | D2.127          |
| Two-Bolt Connector, Bronze, Tin-Plated . . . . .  | D2.128          |
| One-Hole, Straight Tongue, Barrel Post Lug . . . . .  | D2.128          |
| One-Hole, Straight Tongue, Tin-Plated, Barrel Post Lug . . . . .                            | D2.129          |
| One-Hole, Straight Tongue Lug . . . . .   | D2.129          |
| One-Hole, Straight Tongue Lug with Internal Pressure Plate . . . . .                        | D2.130          |
| One-Hole, Straight Tongue, Flag Lug . . . . .   | D2.130          |
| One-Hole, Straight Tongue, 90° Lug . . . . .  | D2.131          |
| Two-Hole, Straight Tongue Lug . . . . .   | D2.131          |
| Two-Hole, Straight Tongue Lug with Internal Pressure Plate . . . . .                        | D2.132          |

★ Represents new product offering.



## Table of Contents

|  |                 |
|--|-----------------|
| Two-Hole, Straight Tongue Lug with NEMA Hole Sizes and Spacing .....               | D2.133          |
| Two-Hole, Straight Tongue, Tandem Set Screw Lug .....                              | D2.133          |
| Two-Hole, Straight Tongue, Two-Barrel Lug .....                                    | D2.134          |
| Two-Hole, Straight Tongue, Two-Barrel, Tin-Plated Lug .....                        | D2.134          |
| Two-Set Screw Splice .....   | D2.135          |
| Two-Set Screw Splice with Internal Pressure Plate .....                            | D2.135          |
| One-Hole, Straight Fixed Tongue Lug .....  | D2.136          |
| One-Hole, Straight Fixed Tongue, Tin-Plated Lug .....                              | D2.136          |
| One-Hole, Straight Floating Tongue Lug .....                                       | D2.137          |
| Two-Hole, Straight Floating Tongue Lug .....                                       | D2.138          |
| One-Hole, Offset Floating Tongue Lug .....   | D2.139          |
| Two-Hole, Offset Floating Tongue Lug .....   | D2.140          |
| One-Hole, Single Barrel Lug .....  | D2.141          |
| Two-Hole, Single Barrel Lug .....  | D2.142          |
| One-Hole, Two-Barrel Lug .....   | D2.142          |
| One-Hole, Vertical Two-Barrel Lug .....  | D2.143          |
| Two-Hole, Two-Barrel Lug .....   | D2.143          |
| Two-Hole, Vertical Two-Barrel Lug .....  | D2.144          |
| Two-Hole, Three-Barrel Lug .....   | D2.144          |
| Four-Hole, Three-Barrel Lug .....  | D2.145          |
| Two-Hole, Vertical Four-Barrel Lug .....   | D2.146          |
| Four-Hole, Four-Barrel Lug .....   | D2.146          |
| Transformer Lug Kit .....  | D2.147          |
| Splicer/Reducer .....  | D2.148          |
| Multi-Tap Connector with Clear Insulation, Single-Sided .....                      | D2.149          |
| Multi-Tap Connector with Clear Insulation, Double-Sided .....                      | D2.150 – D2.151 |
| In-Line Splicer/Reducer with Clear Insulation .....                                | D2.152          |
| Multi-Tap Connector with Clear Insulation, Single-Sided, with Mounting Holes ..... | D2.153          |
| Multi-Tap Connector with Clear Insulation, Double-Sided, with Mounting Holes ..... | D2.154          |
| Belleville Compression Washers .....   | D2.155          |
| Joint Compounds .....  | D2.155          |
| Guidelines for Installing Aluminum Mechanical Connectors .....                     | D2.156          |
| Panduit Power Connector Approvals .....  | D2.157          |
| Recommended Termination Hardware .....   | D2.158          |
| Conductor Sizes .....  | D2.159 – D2.161 |
| Common Conductor Sizes and Strandings Reference Chart .....                        | D2.162 – D2.163 |
| Stud Size Chart (Inches/Millimeters) .....   | D2.164          |
| Equivalent Tables .....  | D2.164          |

## Grounding Connectors

|   |               |
|---|---------------|
| <b>StructuredGround™ Grounding Connectors</b> .....                               | D3.1          |
| Features and Benefits – StructuredGround™ Compression Connectors .....            | D3.2          |
| StructuredGround™ Direct Burial Compression System Grounding Roadmap .....        | D3.3          |
| Service Entrance Grounding Roadmap .....  | D3.4          |
| ★ Access Floor Grounding Clamp .....  | D3.5          |
| BICSI/J-STD-607-A Telecommunications Grounding Busbars .....                      | D3.6          |
| Component Labels for BICSI/J-STD-607-A Telecommunications Grounding Busbars ..... | D3.6          |
| Telecommunications Grounding and Bonding Conductor Label Kit .....                | D3.6          |
| ★ NEMA Hole Pattern Grounding Busbars .....                                       | D3.7          |
| ★ Grounding Busbar 1" Hole Spacings .....   | D3.7          |
| ★ Stainless Steel Hardware for Busbars .....                                      | D3.7          |
| ★ E Style Grounding Connectors .....  | D3.8          |
| ★ Grounding Cross Connectors .....  | D3.9          |
| ★ Universal Beam Grounding Clamp .....  | D3.10         |
| ★ Grounding Plate Connector .....   | D3.10         |
| Code Conductor, Thin Wall, CTAP .....   | D3.11         |
| Code Conductor, Heavy Duty, CTAP .....  | D3.12         |
| Clear Covers for HTCT HTAPs .....   | D3.13         |
| Black Covers for Copper HTAPs and CTAPs .....                                     | D3.13         |
| Code/Flex Conductor HTAP .....  | D3.14         |
| Code/Flex Conductor HTAP Kit .....  | D3.15         |
| Features and Benefits – StructuredGround™ Mechanical Connectors .....             | D3.16         |
| Selection Guide – StructuredGround™ Mechanical Connectors .....                   | D3.17 – D3.18 |
| Panduit Grounding Connector Approvals .....                                       | D3.19         |
| Service Post Connector, Male Stud, Single Conductor, Bronze .....                 | D3.20         |
| Service Post Connector, Male Stud, Two Conductor, Bronze .....                    | D3.21         |
| Service Post Connector, Female Thread, Single Conductor, Bronze .....             | D3.22         |
| Service Post Connector, Female Thread, Two Conductor, Bronze .....                | D3.23         |
| ★ One-Hole Aluminum Lay-In Lug .....  | D3.24         |

★ Represents new product offering.

## Table of Contents

|   |   |
|---|---|
| A.<br>System<br>Overview                    |   |
| B1.<br>Cable Ties                           | <ul style="list-style-type: none"> <li>Joint Compounds .....D3.24</li> <li>Grounding Clamp, U-Bolt, Bronze .....D3.25</li> <li>Grounding Clamp, U-Bolt, for Two Cables, Bronze .....D3.26</li> <li>Grounding Clamp for Water Pipes, Bronze .....D3.26</li> <li>Grounding Clamp for Water Pipe with Copper Strap, Bronze .....D3.27</li> </ul>   |
| B2.<br>Cable<br>Accessories                 | <ul style="list-style-type: none"> <li>Grounding Clamp for Conduit, Bronze .....D3.27</li> <li>Grounding Clamp for Water Pipes, Aluminum .....D3.28</li> <li>Grounding Rod Clamp, Bronze .....D3.28</li> <li>Grounding Clamp with Spacer for Flat Surfaces, Bronze .....D3.29</li> </ul>  |
| B3.<br>Stainless<br>Steel Ties              | <ul style="list-style-type: none"> <li>Grounding Clamp for Flat Surfaces, Bronze .....D3.29</li> <li>★ Flat Braided Bonding Straps .....D3.30</li> </ul>  |
| C1.<br>Wiring<br>Duct                       | <ul style="list-style-type: none"> <li><b>Compression Connector Crimping Tools</b> .....D3.31</li> <li>Crimping Guidelines for Panduit® Pan-Lug™ Compression Lugs and Splices .....D3.32</li> <li>Crimping Guidelines for Panduit® StructuredGround™ Compression Connectors .....D3.33</li> <li>Selection Guide – Compression Connector Tools .....D3.34 – D3.36</li> <li>Die Type, Manual, Crimping Tool .....D3.37</li> <li>CD-720 Crimping Dies .....D3.37</li> <li>Die Type, Manual, Crimping Tool and Die Kits .....D3.38</li> </ul>   |
| C2.<br>Surface<br>Raceway                   | <ul style="list-style-type: none"> <li>Cable Stripping Tool for Large Cable Sizes .....D3.38</li> <li>Wire and Cable Stripping Tools .....D3.38</li> <li>★ Cable Cutting Tools .....D3.39</li> <li>Die Type, Manual Hydraulic, 14 Ton, Crimping Tool .....D3.39</li> <li>★ Die Type, Lithium-Ion Powered Hydraulic, 6 Ton, In-Line Crimping Tools .....D3.40</li> <li>★ Die Type, Lithium-Ion Powered Hydraulic, 6 Ton, Crimping Tool with Open “C-Head” .....D3.41</li> <li>CD-2001 Crimping Dies .....D3.42</li> <li>★ Die Type, Lithium-Ion Powered Hydraulic, 14 Ton, Crimping Tool .....D3.43</li> <li>★ Die Type, Lithium-Ion Powered Hydraulic, 15 Ton, Crimping Tool .....D3.44</li> </ul>  |
| C3.<br>Abrasion<br>Protection               | <ul style="list-style-type: none"> <li>Die Type, Remote Hydraulic, 14 Ton, Crimp Head .....D3.45</li> <li>Die Type, Remote Hydraulic, 15 Ton, Crimp Head .....D3.46</li> <li>Hydraulic Pump and Accessories, Electric, 10,000 PSI .....D3.47</li> <li>Die Type, Remote Hydraulic, 10.5 Ton, Crimp Head .....D3.48</li> <li>Hydraulic Pump and Accessories, Electric, 7,500 PSI .....D3.49</li> </ul>  |
| C4.<br>Cable<br>Management                  | <ul style="list-style-type: none"> <li>CD-920 Crimping Dies .....D3.50</li> <li>CD-940 Crimping Dies .....D3.51</li> <li>Uni-Die™ Dieless, Manual Hydraulic, 6.2 Ton, Crimping Tool .....D3.52</li> <li>★ Uni-Die™ Dieless, Lithium-Ion Powered Hydraulic, 6.2 Ton, Crimping Tool .....D3.53</li> <li>Uni-Die™ Dieless, Remote Hydraulic, 6.2 Ton, Crimp Head .....D3.54</li> <li>Uni-Die™ Dieless, Remote Hydraulic, 4.7 Ton, Crimp Head .....D3.54</li> <li>Pressure Gauges .....D3.55</li> <li>★ Accessories for Battery Powered Hydraulic Crimping Tools .....D3.55</li> </ul>  |
| D1.<br>Terminals                            | <ul style="list-style-type: none"> <li>Installation Tooling and Die Selections for: Types LCAS and SCSS .....D3.56 – D3.57</li> <li>Installation Tooling and Die Selections for: Types LCA, LCAN, LCD, LCDN and SCS .....D3.58 – D3.61</li> <li>Installation Tooling and Die Selections for: Types LCB, LCBN, LCC, LCCN and SCL .....D3.62 – D3.65</li> <li>Installation Tooling and Die Selections for: Types LCBH, LCCH and SCH .....D3.66 – D3.67</li> <li>Installation Tooling and Die Selections for: Type SCT .....D3.68 – D3.69</li> <li>Installation Tooling and Die Selections for: Types LCAX, LCAXN, LCBX, LCDX, LCDXN and LCCX .....D3.70 – D3.73</li> </ul>  |
| D2.<br>Power<br>Connectors                  | <ul style="list-style-type: none"> <li>Installation Tooling and Die Selections for: Types LCAF, LCCF and SCSF .....D3.74 – D3.75</li> <li>Installation Tooling and Die Selections for: Type RSC In-Line Reducing Splice .....D3.76 – D3.81</li> <li>Installation Tooling and Die Selections for: Type PSC .....D3.82</li> <li>Installation Tooling and Die Selections for: Types LCMA, LCMD, and SCMS .....D3.83</li> <li>Installation Tooling and Die Selections for: Types LAA, LAB and SA .....D3.84 – D3.85</li> <li>Installation Tooling and Die Selections for: Type SAR .....D3.86 – D3.87</li> <li>Installation Tooling and Die Selections for: Type BPC .....D3.88 – D3.89</li> <li>Installation Tooling and Die Selections for: Types GCE, GCC, and GPC .....D3.90</li> <li>Installation Tooling and Die Selections for: Type CTAP .....D3.91</li> <li>Installation Tooling and Die Selections for: Type CTAPF .....D3.92 – D3.93</li> <li>Installation Tooling and Die Selections for: Type HTCT .....D3.94</li> </ul> |
| D3.<br>Grounding<br>Connectors              |   |
| E1.<br>Labeling<br>Systems                  |   |
| E2.<br>Labels                               |   |
| E3.<br>Pre-Printed<br>& Write-On<br>Markers |   |

## Labeling Systems

|  |  |
|--|--|
| E4.<br>Permanent<br>Identification                 | <ul style="list-style-type: none"> <li><b>Labeling Systems</b> .....E1.0</li> <li><b>Printers: Thermal Transfer Desktop and Hand-Held</b> .....E1.1</li> <li>PanTher™ LS8E Hand-Held Thermal Transfer Printer and Accessories .....E1.2</li> <li>Cougar™ LS9 Hand-Held Thermal Transfer Printer and Accessories .....E1.2</li> <li>P1™ Self-Laminating Label Cassettes for PanTher™ LS8E Hand-Held Thermal Transfer Printer .....E1.3 – E1.4</li> <li>P1™ Non-Laminated Label Cassettes .....E1.5 – E1.6</li> <li>★ P1™ Turn-Tell™ Label Cassettes for PanTher™ LS8E Hand-Held Thermal Transfer Printer .....E1.6</li> <li>★ P1™ Marker Plate Label Cassettes for PanTher™ LS8E Hand-Held Thermal Transfer Printer .....E1.7</li> <li>★ P1™ Flag Label Cassettes for PanTher™ LS8E Hand-Held Thermal Transfer Printer .....E1.7</li> </ul> |
| E5.<br>Lockout/<br>Tagout<br>& Safety<br>Solutions |  |
| F.<br>Index  |  |

★ Represents new product offering.



## Table of Contents

|  |               |
|--|---------------|
| P1™ Military Grade Continuous Heat Shrink Label Cassettes for PanTher™ LS8E or Cougar™ LS9 Hand-Held Thermal Transfer Printers | E1.8          |
| P1™ Military Grade Die-Cut Heat Shrink Label Cassettes for PanTher™ LS8E Hand-Held Thermal Transfer Printer                    | E1.9          |
| P1™ General Component Label Cassettes for PanTher™ LS8E Hand-Held Thermal Transfer Printers                                    | E1.10         |
| P1™ Continuous Tape Cassettes for PanTher™ LS8E and Cougar™ LS9 Hand-Held Thermal Transfer Printers                            | E1.11 – E1.12 |
| ★ P1™ Continuous Reflective Tape Cassettes for PanTher™ LS8E and Cougar™ LS9 Hand-Held Thermal Transfer Printers               | E1.12         |
| TDP43MY Thermal Transfer Desktop Printer and Accessories   | E1.13         |
| Ribbons for Use with the TDP43MY Thermal Transfer Desktop Printer  | E1.13         |
| TDP42HY, TDP43HY, TDP46HY Thermal Transfer Desktop Printers  | E1.14         |
| Ribbons for use with the TDP42HY, TDP43HY and TDP46HY Thermal Transfer Desktop Printers  | E1.14         |
| <b>Labeling Software</b>   | E1.15         |
| Easy-Mark™ Labeling Software   | E1.16         |
| CAD-Connect™ Labeling Software   | E1.16         |

## Labels

|  |               |
|--|---------------|
| <b>Labels: Laser, Ink Jet, and Thermal Transfer</b>        | E2.1          |
| Laser/Ink Jet Self-Laminating Labels                       | E2.2 – E2.3   |
| Laser/Ink Jet Non-Laminated Labels                         | E2.4          |
| Laser/Ink Jet Flag Style Labels                            | E2.5          |
| Laser/Ink Jet Component Labels                             | E2.5 – E2.6   |
| Part Number System for Component Labels                    | E2.5          |
| Thermal Transfer Self-Laminating Labels                    | E2.7 – E2.9   |
| ★ Turn-Tell™ Labels  | E2.10         |
| Thermal Transfer Marker Plates                             | E2.10         |
| Thermal Transfer Non-Laminated Labels                      | E2.11         |
| Part Number System for Non-Laminated Labels                | E2.11         |
| Thermal Transfer Military Grade Heat Shrink Labels         | E2.12 – E2.13 |
| ★ 2-Sided Military Grade Printable Heat Shrink Labels      | E2.14 – E2.15 |
| Heat Shrink Tools and Accessories                          | E2.15         |
| Thermal Transfer Component Labels                          | E2.16 – E2.18 |
| Thermal Transfer Tamper Evident Polyester Component Labels | E2.19         |
| Thermal Transfer Raised Panel Labels                       | E2.19 – E2.20 |
| Thermal Transfer Continuous Tapes                          | E2.21 – E2.22 |
| Size Illustrations of Self-Laminating Labels               | E2.23 – E2.24 |
| Size Illustrations of Non-Laminated and Flag Style Labels  | E2.25         |
| Size Illustrations of Flattened Heat Shrink Labels         | E2.26         |
| Size Illustrations for Component Labels                    | E2.27 – E2.28 |

## Pre-Printed and Write-On Markers

|   |               |
|---|---------------|
| <b>Pre-Printed and Write-On Markers</b>           | E3.1          |
| Pre-Printed Marker Books                          | E3.2          |
| Blank Self-Laminating Write-On Cable Marker Books | E3.3          |
| Pre-Printed Marker Cards PCM Type                 | E3.4 – E3.6   |
| Wire Marker Card Number Combination Packs         | E3.7          |
| Pre-Printed Marker Cards                          | E3.7          |
| Pre-Printed Marker Cards PPM Type                 | E3.8          |
| Write-On Marker Cards – Self-Laminating           | E3.9          |
| Pre-Printed Marker Tape Dispenser                 | E3.9          |
| Pre-Printed Marker Tape Refills                   | E3.10         |
| Self-Laminating Wire Marker Dispenser             | E3.11         |
| Pre-Printed Clip-On Wire Markers                  | E3.11 – E3.12 |

## Permanent Identification

|  |             |
|--|-------------|
| <b>Permanent Identification</b>                  | E4.1        |
| Panduit Factory Custom Marking Service           | E4.2        |
| Stainless Steel and Brass Marker Plates and Tags | E4.3 – E4.4 |
| Pan-Alum™ Aluminum Marker Plates                 | E4.5        |
| Aluminum Marker Plates Pan-Alum™ MMP Series 1    | E4.5        |
| Metal Embossing Tool and Tape System             | E4.5        |
| Metal Indenting Machine                          | E4.6        |
| ★ Portable Embossing System                      | E4.6        |

★ Represents new product offering.

A.  
System  
Overview

## Table of Contents

B1.  
Cable Ties

### Lockout/Tagout and Safety Solutions

B2.  
Cable  
Accessories

B3.  
Stainless  
Steel Ties

C1.  
Wiring  
Duct

C2.  
Surface  
Raceway

C3.  
Abrasion  
Protection

C4.  
Cable  
Management

D1.  
Terminals

D2.  
Power  
Connectors

D3.  
Grounding  
Connectors

E1.  
Labeling  
Systems

E2.  
Labels

E3.  
Pre-Printed  
& Write-On  
Markers

E4.  
Permanent  
Identification

E5.  
Lockout/  
Tagout  
& Safety  
Solutions

F.  
Index

|   |               |
|---|---------------|
| <b>Lockout/Tagout</b> .....                               | E5.1          |
| OSHA Lockout/Tagout Compliance and Training Kit .....     | E5.2          |
| Group Lockout/Tagout Training Video .....                 | E5.2          |
| Lockout/Tagout Steps/Calendar Wallet Card .....           | E5.2          |
| “No Tool” Circuit Breaker Lockout Devices .....           | E5.3          |
| Large Handle Circuit Breaker Lockout Device .....         | E5.3          |
| Circuit Breaker Lockout Devices .....                     | E5.3          |
| Plug Lockout Device .....                                 | E5.4          |
| Cord Lockout Devices .....                                | E5.4          |
| Receptacle Blockout Device .....                          | E5.4          |
| Toggle Switch Lockout Device .....                        | E5.5          |
| Toggle/Rocker Switch Lockout Device .....                 | E5.5          |
| Gate Valve Lockout Devices .....                          | E5.5          |
| Ball Valve Lockout Devices .....                          | E5.6          |
| Multiple Lockout Device .....                             | E5.6          |
| Pneumatic Energy Lockout Device .....                     | E5.6          |
| Electrician Lockout Kit .....                             | E5.7          |
| Contractor Lockout Kit .....                              | E5.7          |
| MRO Lockout Kit .....                                     | E5.7          |
| Power and Panel Distribution Lockout Kit .....            | E5.7          |
| Metal Wall Mount Cabinet .....                            | E5.8          |
| Lockout Stations .....                                    | E5.8          |
| Group Lock Box .....                                      | E5.8          |
| Warning Label .....                                       | E5.9          |
| Circuit Breaker Directory Sign .....                      | E5.9          |
| Non-Conductive Lockout Padlocks .....                     | E5.10         |
| High Security Padlocks .....                              | E5.10         |
| Laminated Steel Padlocks .....                            | E5.11         |
| Lockout Hasps .....                                       | E5.11         |
| Self-Laminating Padlock Labels .....                      | E5.12         |
| Custom Lock Options .....                                 | E5.12         |
| Metal I.D. Tags and Collars .....                         | E5.13         |
| Padlock Eyes .....  | E5.13         |
| Chain Attachment .....                                    | E5.13         |
| Write-On Safety Tags .....                                | E5.14 – E5.16 |
| Bilingual Write-On Safety Tags .....                      | E5.17         |
| ISO Symbol Safety Tags .....                              | E5.17         |
| Do It Yourself Tags .....                                 | E5.17         |
| Self-Laminating Photo Tags .....                          | E5.18         |
| Permanent Marking Pens .....                              | E5.18         |
| Lockout/Tagout Safety Signs .....                         | E5.19         |
| Jack Module Blockout Device .....                         | E5.20         |
| RJ45 Plug Lock-In Device .....                            | E5.21         |
| LC Duplex Adapter Blockout Device .....                   | E5.22         |
| SC Adapter Blockout Device .....                          | E5.22         |
| <b>Safety and Facility Identification</b> .....           | E5.23         |
| Electrical Hazard Safety Signs .....                      | E5.24         |
| ★ Short Circuit Warning Signs .....                       | E5.25         |
| ★ Photoluminescent Safety Signs .....                     | E5.25         |
| Electrical Symbols on Cards .....                         | E5.25         |
| Conductor Identification Labels .....                     | E5.26         |
| ISO Warning Symbols .....                                 | E5.27         |
| Electrical Labels in Dispenser .....                      | E5.28         |
| Write-On Labels on Cards .....                            | E5.29         |
| Write-On Quality Labels in Dispenser .....                | E5.30         |
| Inspection Plates .....                                   | E5.31         |
| Inspection Arrows .....                                   | E5.31         |
| Voltage and Fiber Optic Markers .....                     | E5.32         |
| Voltage and Safety Marker Books .....                     | E5.33         |
| Hazard Tape .....   | E5.33         |
| Solid Color Adhesive Warning Tape .....                   | E5.33         |
| Reflective Tapes .....                                    | E5.34         |
| Photoluminescent Tapes – Thermal Transfer Printable ..... | E5.34         |
| Underground Hazard Tape .....                             | E5.35         |
| Barricade Tapes .....                                     | E5.36         |
| Vinyl Letters and Numbers .....                           | E5.36         |
| Vinyl Cloth Letters and Numbers .....                     | E5.37 – E5.38 |
| Reflective Letters and Numbers .....                      | E5.38         |
| Sign Panels – Blank Space for Custom Messages .....       | E5.39         |

★ Represents new product offering.

## Table of Contents

|  |       |
|--|-------|
| ★ Thermal Transfer Printable Arc Flash Labels .....                          | E5.40 |
| ★ Laser Printable Adhesive Signs .....                                       | E5.40 |
| Self-Laminating Adhesive Sign Carriers .....                                 | E5.41 |
| Self-Laminating Cable Marker Holders for Large Cables or Cable Bundles ..... | E5.41 |
| Self-Laminating Fiber Optic Cable Marker Tags .....                          | E5.42 |
| Ground Warning Tags .....  | E5.42 |
| Panduit Corp. Generic Padlock Order Form .....                               | E5.43 |
| Panduit Corp. Generic PVT Vinyl Tag Order Form .....                         | E5.44 |
| Panduit Corp. Generic Adhesive PPS Safety Sign Order Form .....              | E5.45 |
| Panduit Corp. Generic Semi-Rigid PRS Safety Sign Order Form .....            | E5.46 |
| Panduit Corp. Generic Conduit and Voltage Marker Order Form .....            | E5.47 |
| Panduit Corp. Generic Utility Tapes Order Form .....                         | E5.48 |
| Panduit Corp. Generic Custom Engraved Marker Plate Order Form .....          | E5.49 |
| Wire Size Selection Guide .....  | E5.50 |
| Selection Guide by Wire/Cable Size .....                                     | E5.51 |

## Index

|                                |              |
|--------------------------------|--------------|
| <b>Part Number Index</b> ..... | F1.1 – F1.40 |
|--------------------------------|--------------|

A.  
System  
Overview

B1.  
Cable Ties

B2.  
Cable  
Accessories

B3.  
Stainless  
Steel Ties

C1.  
Wiring  
Duct

C2.  
Surface  
Raceway

C3.  
Abrasion  
Protection

C4.  
Cable  
Management

D1.  
Terminals

D2.  
Power  
Connectors

D3.  
Grounding  
Connectors

E1.  
Labeling  
Systems

E2.  
Labels

E3.  
Pre-Printed  
& Write-On  
Markers

E4.  
Permanent  
Identification

E5.  
Lockout/  
Tagout  
& Safety  
Solutions

F.  
Index

★ Represents new product offering.

A.  
System  
Overview

B1.  
Cable Ties

B2.  
Cable  
Accessories

B3.  
Stainless  
Steel Ties

C1.  
Wiring  
Duct

C2.  
Surface  
Raceway

C3.  
Abrasion  
Protection

C4.  
Cable  
Management

D1.  
Terminals

D2.  
Power  
Connectors

D3.  
Grounding  
Connectors

E1.  
Labeling  
Systems

E2.  
Labels

E3.  
Pre-Printed  
& Write-On  
Markers

E4.  
Permanent  
Identification

E5.  
Lockout/  
Tagout  
& Safety  
Solutions

F.  
Index

# NOTES

## SYSTEM OVERVIEW

Panduit is a global leader in comprehensive physical infrastructure solutions. Issues such as convergence, interoperability, scalability and continuity need to be addressed to reduce risk across the IT, facilities, and manufacturing physical infrastructure. Our holistic approach enables business continuity through robust, leading-edge systems that optimize design and deployment of the physical infrastructure – delivering maximum reliability, availability, security, integration, and safety.

Comprehensive solutions include everything necessary to bundle, identify, route, protect, and terminate wires/cables. Supporting the most demanding application requirements customers trust Panduit for:



Panduit products are developed through continued focus on the needs of the customer and high level of investment in research and development. Solutions are designed for reliability, improved productivity, standards compliance, and lowest total cost of ownership.

- Comprehensive, end-to-end solutions
- World-class quality and reliability
- Innovative products and tools
- Unmatched global sales and technical support

A.  
System  
Overview

B1.  
Cable Ties

B2.  
Cable  
Accessories

B3.  
Stainless  
Steel Ties

C1.  
Wiring  
Duct

C2.  
Surface  
Raceway

C3.  
Abrasion  
Protection

C4.  
Cable  
Management

D1.  
Terminals

D2.  
Power  
Connectors

D3.  
Grounding  
Connectors

E1.  
Labeling  
Systems

E2.  
Labels

E3.  
Pre-Printed  
& Write-On  
Markers

E4.  
Permanent  
Identification

E5.  
Lockout/  
Tagout  
& Safety  
Solutions

F.  
Index



A.  
System  
Overview

## SOLUTIONS OVERVIEW

Panduit provides innovative solutions that offer maximum reliability at the lowest installed cost from the factory and manufacturing floor, to automation and control, to the office area.

B1.  
Cable Ties

B2.  
Cable  
Accessories

B3.  
Stainless  
Steel Ties

C1.  
Wiring  
Duct

C2.  
Surface  
Raceway

C3.  
Abrasion  
Protection

C4.  
Cable  
Management

D1.  
Terminals

D2.  
Power  
Connectors

D3.  
Grounding  
Connectors

E1.  
Labeling  
Systems

E2.  
Labels

E3.  
Pre-Printed  
& Write-On  
Markers

E4.  
Permanent  
Identification

E5.  
Lockout/  
Tagout/  
& Safety  
Solutions

F.  
Index





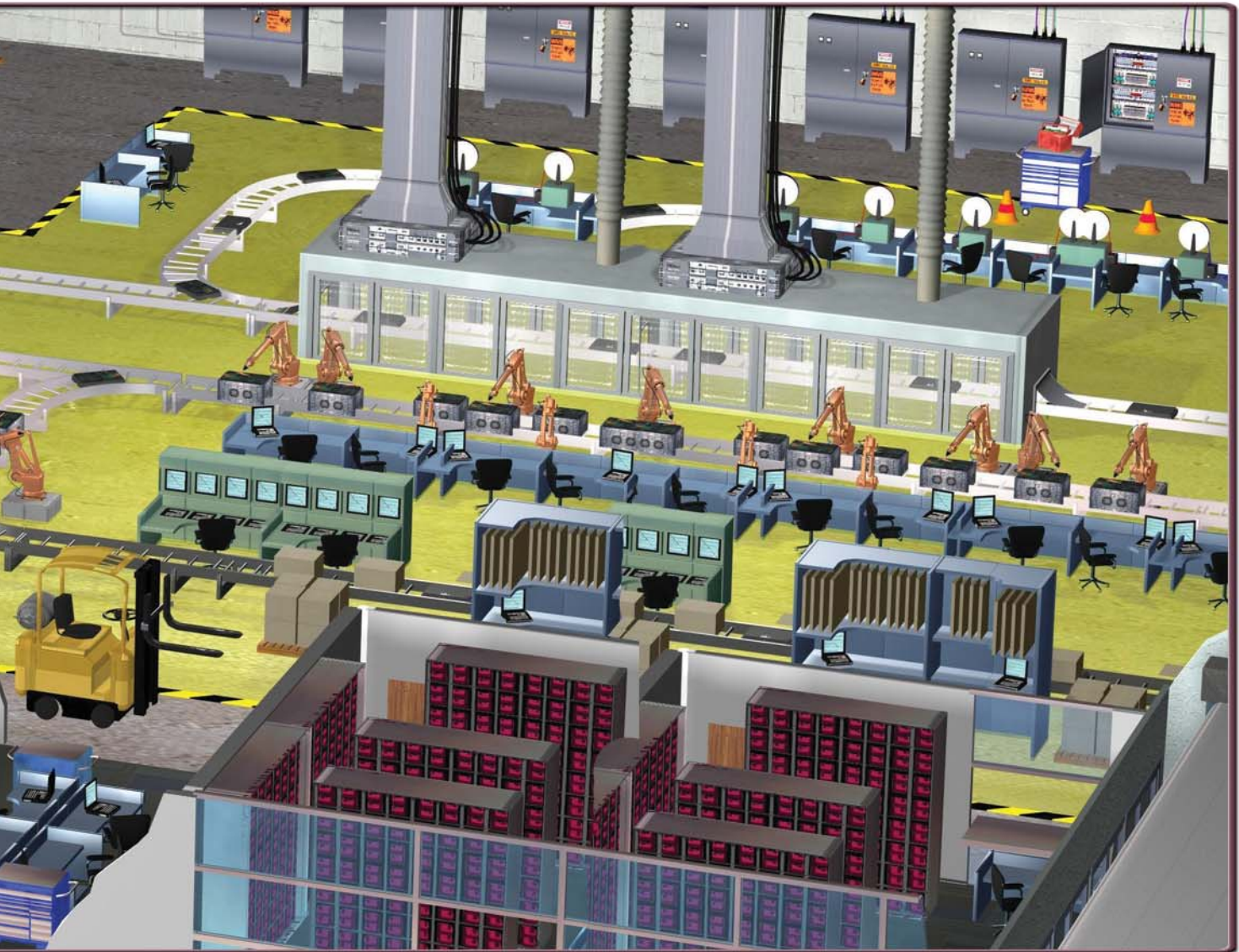

A.  
System  
Overview

B1.  
Cable Ties

B2.  
Cable  
Accessories

B3.  
Stainless  
Steel Ties

C1.  
Wiring  
Duct

C2.  
Surface  
Raceway

C3.  
Abrasion  
Protection

C4.  
Cable  
Management

D1.  
Terminals

D2.  
Power  
Connectors

D3.  
Grounding  
Connectors

E1.  
Labeling  
Systems

E2.  
Labels

E3.  
Pre-Printed  
& Write-On  
Markers

E4.  
Permanent  
Identification

E5.  
Lockout/  
Tagout  
& Safety  
Solutions

F.  
Index

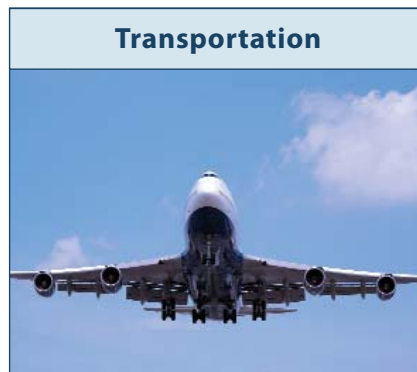



A.  
System  
Overview

## CONTROL PANEL SOLUTIONS

Panduit delivers innovative solutions that support evolving technologies in automation and control. Control panel solutions from Panduit reduce design and assembly time, save valuable panel space, ease installation and maintenance, and improve manageability and reliability, all contributing to lower cost of ownership.

B1.  
Cable Ties

B2.  
Cable  
Accessories

B3.  
Stainless  
Steel Ties

C1.  
Wiring  
Duct

C2.  
Surface  
Raceway

C3.  
Abrasion  
Protection

C4.  
Cable  
Management

D1.  
Terminals

D2.  
Power  
Connectors

D3.  
Grounding  
Connectors

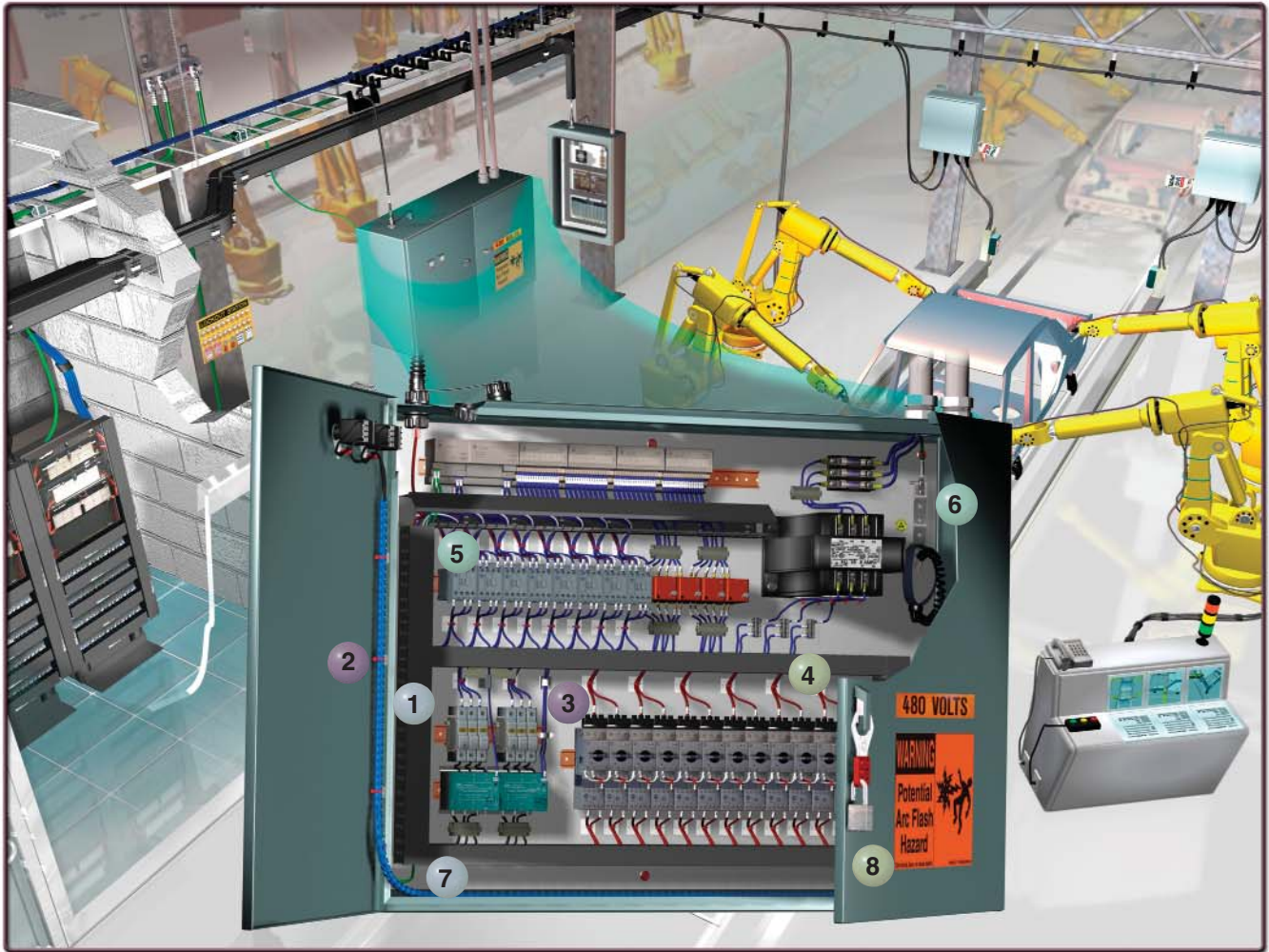

1 **Wiring Duct**

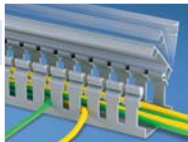

2 **Cable Ties**



3 **Cable Accessories**



4 **Labeling Systems**



5 **Terminals**



6 **Power and  
Grounding  
Connectors**



7 **Abrasion  
Protection**



8 **Lockout/  
Tagout**



For Industrial Automation Solutions, request SA-CPCB65 or visit [www.panduit.com](http://www.panduit.com).

## HARNESS SOLUTIONS

Panduit is a leading supplier of wire management solutions, helping OEM and CMs achieve their strategic objectives. From complete system solutions that provide the lowest installed cost to new product innovations that meet evolving application challenges, Panduit solutions meet a wide range of applications, volumes, and environments in white goods, gaming, vending, and transportation.

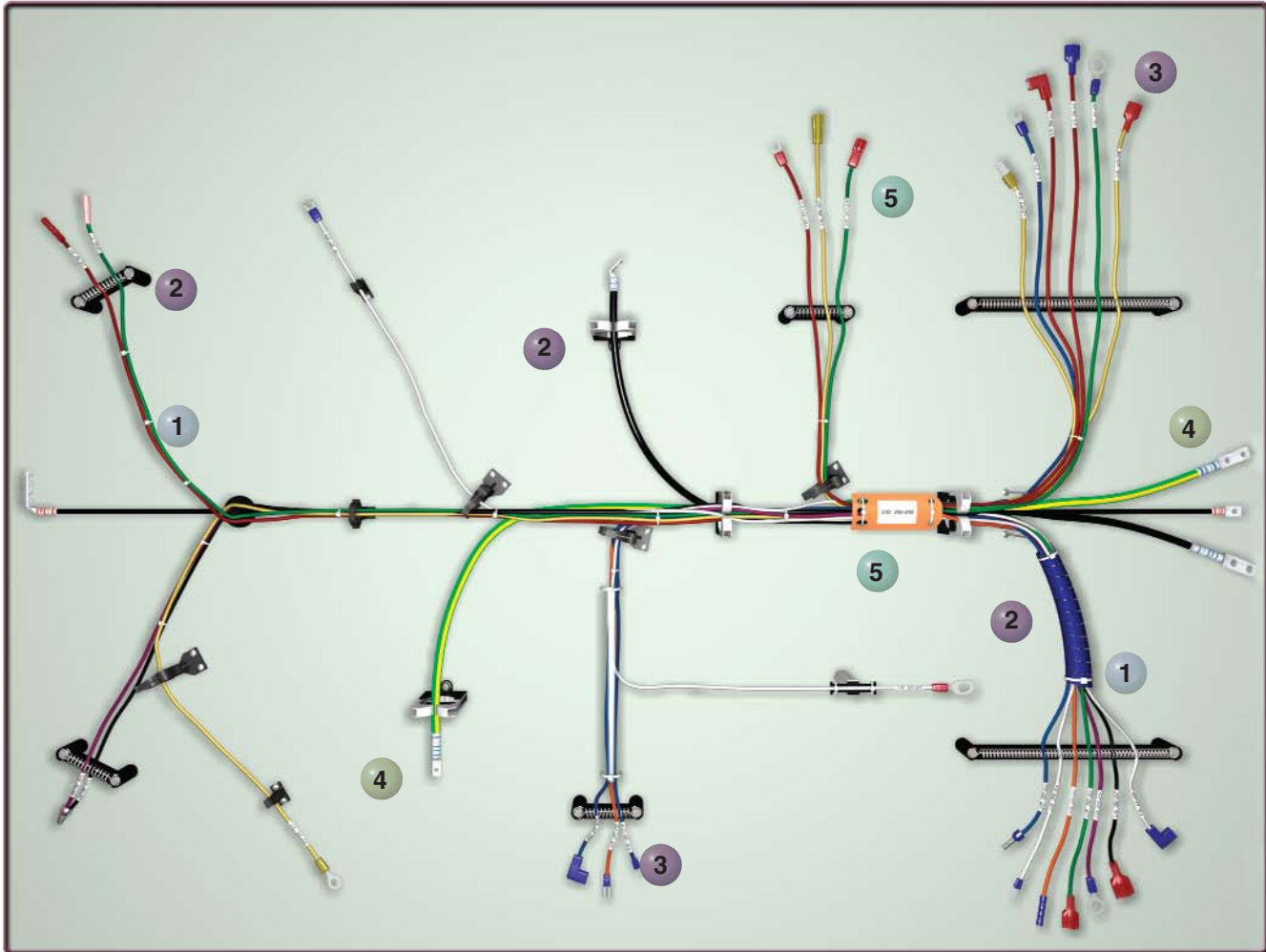

**1 Cable Tie Systems**



**2 Cable Accessories**



**3 Terminal Systems**



**4 Power Connector Systems**



**5 Identification Systems**



A.  
System  
Overview

B1.  
Cable Ties

B2.  
Cable  
Accessories

B3.  
Stainless  
Steel Ties

C1.  
Wiring  
Duct

C2.  
Surface  
Raceway

C3.  
Abrasion  
Protection

C4.  
Cable  
Management

D1.  
Terminals

D2.  
Power  
Connectors

D3.  
Grounding  
Connectors

E1.  
Labeling  
Systems

E2.  
Labels

E3.  
Pre-Printed  
& Write-On  
Markers

E4.  
Permanent  
Identification

E5.  
Lockout/  
Tagout  
& Safety  
Solutions

F.  
Index



A.  
System  
Overview

B1.  
Cable Ties

B2.  
Cable  
Accessories

B3.  
Stainless  
Steel Ties

C1.  
Wiring  
Duct

C2.  
Surface  
Raceway

C3.  
Abrasion  
Protection

C4.  
Cable  
Management

D1.  
Terminals

D2.  
Power  
Connectors

D3.  
Grounding  
Connectors

E1.  
Labeling  
Systems

E2.  
Labels

E3.  
Pre-Printed  
& Write-On  
Markers

E4.  
Permanent  
Identification

E5.  
Lockout/  
Tagout  
& Safety  
Solutions

F.  
Index



## CONTRACTOR SOLUTIONS

Panduit is committed to delivering innovative solutions that meet the needs of electrical and networking installations. Contractors rely on Panduit solutions for improved productivity, reliability, and safety with lower installed costs. A comprehensive range of products and tooling satisfies the most demanding applications and environments. Contractor programs further support your business needs and benefit the bottom line.



## MRO SOLUTIONS

Maximizing facility uptime while containing maintenance and repair costs is a big challenge facing industrial and manufacturing facilities. Electrical and control systems repair, reconfiguration, and preventative maintenance comprise a substantial portion of the total facility spend. Panduit solutions deliver best-in-class quality for maximum reliability and defect-free installations, minimizing rework and reducing downtime. The breadth of product lines and materials selection provides extensive application and environment-specific solutions for faster, easier, and more cost-effective maintenance and repair operations (MRO).



## HARSH ENVIRONMENT SOLUTIONS

When vibration, radiation, weathering, corrosion, and temperature extremes are a factor, you need a high quality, reliable, and durable solution. Panduit provides everything necessary to bundle, route, protect, terminate, and identify electrical and network cable in indoor and outdoor extreme conditions. These innovative solutions meet the needs of the most demanding harsh and industrial environment applications to deliver long life, increased productivity, and improved worker safety.



## TRANSPORTATION SOLUTIONS

Panduit develops high-quality products to meet the requirements of the transportation market while providing the lowest installed cost. Performance, reliability, efficiency, and availability are critical issues to success. Panduit solutions are designed to hold up under vibration, shock, and exposure to nature's elements while preventing corrosion, reducing weight, and speeding installation.

## UNIFIED PHYSICAL INFRASTRUCTURE<sup>SM</sup> APPROACH

The physical infrastructure is the basic foundation on which enterprise systems run, including voice and data communications, power, computing, control, and security systems. The need to provide real-time information, manage applications, and control functional systems through IP networking is also driving increased interdependence between these systems through several core enterprise areas.

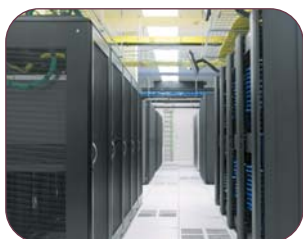

Panduit offers Unified Physical Infrastructure (UPI)-based solutions that help customers optimize the physical infrastructure by intelligently converging physical and logical systems. These solutions leverage real-time information to:

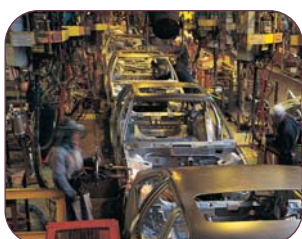

- Manage systems more effectively
- Maximize performance and availability
- Satisfy regulatory compliance requirements
- Increase safety and security in the workplace



As the global leader in comprehensive electrical and network solutions, Panduit helps customers support and manage the physical infrastructure by leveraging robust product systems, technology leadership, global expertise and support, an extensive partner ecosystem, and world-renowned alliances.

Panduit systems optimize availability, reliability, security, integration, and safety throughout the physical infrastructure and combine to deliver industry and application solutions that enable business agility and lowest total cost of ownership. For more information visit:

[www.panduit.com/upi](http://www.panduit.com/upi)

### Unified Physical Infrastructure

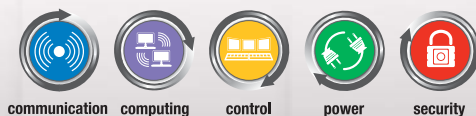

communication    computing    control    power    security

A.  
System  
Overview

B1.  
Cable Ties

B2.  
Cable  
Accessories

B3.  
Stainless  
Steel Ties

C1.  
Wiring  
Duct

C2.  
Surface  
Raceway

C3.  
Abrasion  
Protection

C4.  
Cable  
Management

D1.  
Terminals

D2.  
Power  
Connectors

D3.  
Grounding  
Connectors

E1.  
Labeling  
Systems

E2.  
Labels

E3.  
Pre-Printed  
& Write-On  
Markers

E4.  
Permanent  
Identification

E5.  
Lockout/  
Tagout  
& Safety  
Solutions

F.  
Index

## APPLICATION STANDARDS

To help assure optimum quality, Panduit products are designed and manufactured to meet applicable environmental, safety, market industry and customer standards.

### Restriction of Hazardous Substances (RoHS)

#### RoHS

The European Union (EU) directive on the Restriction of use of certain Hazardous Substances bans the use of six substances in electrical and electronic equipment within the European Economic Community (EEC) after July 1, 2006. The RoHS status of Panduit Electrical Products, shown in this catalog, can be determined by accessing [www.panduit.com](http://www.panduit.com).

### Underwriters Laboratories, Inc



Underwriters Laboratories, Inc. (UL) is an independent, not-for-profit product-safety testing and certification organization based in the United States. Since its founding in 1894, UL is becoming one of the most recognized, reputable conformity assessment providers in the world. Today, services extend to helping companies achieve global acceptance, whether for an electrical device, a programmable system, or an organization's quality process. Further information on UL marks can be found at [www.ul.com/mark/](http://www.ul.com/mark/).

### Canadian Standards Association



The Canadian Standards Association is a not-for-profit membership based association serving business, industry, government and consumers in Canada and the global marketplace. CSA works in Canada and around the world to develop standards that enhance public safety and health. Additional information can be found at [www.csa.ca](http://www.csa.ca).

### Conformity European



CE marketing is required for certain products sold within the European Union (EU). EU Directives and Norms, specify the requirements for products. Applying the CE mark signifies compliance with those requirements.

### ISO 9001



The International Standards Organization (ISO) establishes worldwide standards for products and services in recognition of increasing globalization of markets. The ISO program establishes the requirements for quality assurance systems. All Panduit component manufacturing facilities are third party registered to ISO 9001. Registration certificates are available from Panduit, [www.panduit.com](http://www.panduit.com).

### ISO/TS16949

ISO/TS16949 is a recognized supplier quality standard for the automotive industry. The ISO community of accreditation bodies and registrars considers these additions automotive "interpretations" to the global ISO 9001 standard. Appropriate Panduit locations are third party registered to this standard. Registration certificates are available from Panduit, [www.panduit.com](http://www.panduit.com).

### ISO 14001



ISO14001 is a voluntary standard for Environmental Management Systems established by the International Organization for Standardization. The international standard provides a benchmark for continual improvement in environmental performance. Business partners can be confident that Panduit manufacturing facilities around the globe are engaged in an ongoing process to maximize value while minimizing the impact on natural resources.

### National Electrical Manufacturers Association (NEMA)

NEMA is the largest trade association in the U.S. representing electro-industry manufacturers. NEMA develops industry standards that are in the best interest of the industry and users of its products. NEMA standards for electrical power connector for substations covers uninsulated connectors and busbar supports which are made of metal and intended for use in substations. Included in the standard are manufacturing standards for bolt hole sizes and spacing for terminal connectors with single tangs. Panduit offers connectors that meet NEMA manufacturing standards and these are specially noted as listed within this catalog.

## APPLICATION STANDARDS (continued)

### Alliance for Telecommunications Industry Solutions (ATIS)



ATIS is a technical planning and standards development organization that is committed to rapidly developing and promoting technical and operations standards for the communications and related information technologies industry worldwide using a pragmatic, flexible, and open approach. Over 1,200 participants from more than 400 communications companies are active in ATIS' 22 industry committees, and its Incubator Solutions Program. Additional information can be found at [www.atis.org](http://www.atis.org).

J-STD-607-A-2002, Commercial Building Grounding (Earthing) and Bonding Requirements for Telecommunications is jointly developed by TIA/EIA and ATIS' technical committee T1E1. This document is available on the ATIS Document Center at [www.atis.org](http://www.atis.org).

Adhering to the grounding principles outlined in J-STD-607-A helps ensure that the telecommunications grounding and bonding system will perform acceptably regardless of the data and voice equipment installed. As stated in J-STD-607-A, the preferred means of connecting conductors to busbars is by using two-hole irreversible compression lugs listed by a nationally recognized testing laboratory (NRTL) such as UL. Panduit® Pan-Lug™ Copper Compression Connectors meet these requirements, in all barrel sizes specified by the 607 standard.

### Telecommunications Industry Association (TIA)



The Telecommunications Industry Association is a leading US non-profit trade association serving the communications and information technology industry. TIA represents providers of communications and information technology products and services for the global marketplace through its core competencies in standards development.

ANSI/TIA-942 Telecommunications Infrastructure Standard for Data Centers covers a wide range of facilities issues, including grounding and bonding. It states that electrical continuity is required throughout the rack materials. Adhering to these principles protects network equipment and maintains system performance.

### NEBS Level 3 Approval as Tested by Telcordia Technologies

Telcordia Technologies, formerly known as Bellcore, serves as the testing agency for the Regional Bell Operating Companies. Network Equipment-Building Systems (NEBS) was developed by Bellcore and is currently maintained by Telcordia Technologies. NEBS was developed to standardize requirements for Central Office Equipment and to develop criteria for personal safety, protection of property, and operational continuity.

NEBS Level 3 Criteria is the minimum level of environmental compatibility needed to provide maximum assurance of equipment operability within the network facility environment. The Level 3 criteria is the highest assurance of product operability. Products that meet NEBS Level 3 Criteria are suited for equipment applications which demand minimal service interruptions over the life span of the equipment. Panduit is the first in the industry to have a system of copper compression lugs and splices (#8 AWG – 1,000 kcmil) and crimping tools physically and rigorously tested by Telcordia Technologies to meet NEBS Level 3 compliance.

### American Bureau of Shipping (ABS)



ABS is a not-for-profit organization that promotes the security of life, property, and the natural environment primarily through the development and verification of standards for the design, construction, and operational maintenance of marine related facilities including: merchant and naval vessels, offshore drilling units, submersibles, FPSOs, etc. Panduit has ABS Type Approval for select copper compression lugs and splices and are in compliance with ABS 2005 Steel Vessel Rules and can be installed on ABS Type Approved steel vessel machinery, electrical systems, and electrical equipment. Panduit products that meet ABS Type Approval can be found listed on the ABS website at [www.typeapproval.org](http://www.typeapproval.org).

## PROGRAMS

Panduit maintains a dedicated global sales force of highly qualified industry experts to provide professional, consultative sales guidance. In addition, Panduit has partnered with best-in-class contractors and distributors to provide the services and support to deliver comprehensive, reliable solutions at the lowest installed cost.

### Contractor Loyalty Incentive Program (CLIP)

The CLIP program was developed to strengthen relationships and form alliances with valued contractors. Use Panduit as your preferred vendor for cable ties, terminals, power connectors, identification products, surface raceway, installation tooling and a host of related products, and earn credit towards Panduit tooling.

Benefits of being a CLIP participant include annual credit incentives, continuous training, potential project leads, and alliance with a global, world-class electrical manufacturer and exclusive promotions.

For more program details, go to [www.panduit.com/clip](http://www.panduit.com/clip) or contact Panduit Customer Service at 800-777-3300.

### Tooling Partnership Program

The tooling Partnership Program is designed to make low-cost or no cost tooling available to the customer based on qualification and commitment to termination product purchases.

For more program details, go to [www.panduit.com/tpp](http://www.panduit.com/tpp) or contact Panduit Customer Service at 800-777-3300.

### PC Express Program

PC Express offers the ultimate level of service for your power connector needs. PC Express is offered through select authorized Panduit distributors. The PC Express Program provides customers with the ability to receive power connector orders, via second day delivery, at no additional charge.

The customer can place an order of any size, up to a 300 lb. maximum weight, through an authorized Panduit distributor and Panduit will absorb the second day freight charges. All orders will be shipped directly to the customer. Orders received by Panduit Customer Service before 3:00 P.M. CST will be shipped on the same day, via second day delivery. Orders received after 3:00 P.M. CST will be shipped the next business day, via second day delivery.

For more program details, go to [www.panduit.com/pcexpress](http://www.panduit.com/pcexpress) or contact Panduit Customer Service at 800-777-3300.

Note: All programs and benefits are subject to terms and conditions.



## CABLE TIES



Panduit offers the most complete selection of cable tie styles, sizes, materials and colors to meet our customers' needs. Panduit cable ties bundle, mount, and identify in countless indoor, outdoor, and harsh environment applications. Panduit cable ties, wiring accessories, and installation tools allow our customers to achieve the lowest total installed cost of managing wire and cable.



- Panduit continues to provide innovative new cable tie designs to meet our customers' application challenges
- Panduit cable ties and wiring accessories can be used in a variety of applications and environments, providing the optimal wire management solution
- Panduit offers a large selection of ergonomic cable tie installation tools – all with consistent, and reliable performance

Panduit leads the industry in the breadth and depth of available cable tie designs created from customer feedback on their application requirements. As with all Panduit products, quality in design and production along with customer service excellence are assured.



A.  
System  
Overview

B1.  
Cable Ties

B2.  
Cable  
Accessories

B3.  
Stainless  
Steel Ties

C1.  
Wiring  
Duct

C2.  
Surface  
Raceway

C3.  
Abrasion  
Protection

C4.  
Cable  
Management

D1.  
Terminals

D2.  
Power  
Connectors

D3.  
Grounding  
Connectors

E1.  
Labeling  
Systems

E2.  
Labels

E3.  
Pre-Printed  
& Write-On  
Markers

E4.  
Permanent  
Identification

E5.  
Lockout/  
Tagout  
& Safety  
Solutions

F.  
Index

A. System Overview

## Cable Tie Selection Chart

Follow this step-by-step process to find the cable ties that best suit your application:

B1. Cable Ties

### Cable Tie Function

- 1) Select the main function of the cable tie you need:  
 Bundle = Standard Cable Ties  
 Re-use = Nylon Releasable Ties\*  
 Identify = Marker and Flag Ties  
 Mount = Clamp Ties, Push Mount Ties, and Stud Mount Ties

### Material Properties

- 2) Determine the appropriate material for your application:  
 Mechanical  
 Chemical  
 Thermal

### Cable Tie Family

- 3) Select the cable tie family that meets your overall needs

B2. Cable Accessories

B3. Stainless Steel Ties

C1. Wiring Duct

C2. Surface Raceway

C3. Abrasion Protection

C4. Cable Management

D1. Terminals

D2. Power Connectors

D3. Grounding Connectors

E1. Labeling Systems

E2. Labels

E3. Pre-Printed & Write-On Markers

E4. Permanent Identification

E5. Lockout/Tagout & Safety Solutions

F. Index

|  | Cable Tie Function                               |                           | Bundle, Re-use, Identify, Mount | Bundle, Re-use, Identify, Mount | Bundle, Re-use, Mount                       | Bundle, Re-use, Mount     | Bundle                    | Bundle                                      |
|--|--|---------------------------|---------------------------------|---------------------------------|---|---------------------------|---------------------------|---|
|  | Material   | Test Method               | Nylon 6.6                       | Weather Resistant Nylon 6.6     | Impact Modified Weather Resistant Nylon 6.6 | Heat Stabilized Nylon 6.6 | Heat Stabilized Nylon 6.6 | Heat Stabilized Weather Resistant Nylon 6.6 |
|  | Color  | —                         | Natural                         | Black                           | Black                                       | Black                     | Natural                   | Black                                       |
|  | Part Number Suffix (Material Designation)        | —                         | No Suffix                       | 0                               | 0   | 30                        | 39                        | 300   |
|  | Tensile @ Yield @ 73°F (psi)                     | ISO 527                   | 12,000                          | 12,000                          | 9,700                                       | 12,000                    | 12,000                    | 12,000                                      |
|  | Water Absorption (24 Hours)                      | ASTM D570                 | 1.2%                            | 1.2%                            | 1.2%  | 1.2%                      | 1.2%                      | 1.2%  |
|  | Radiation Resistance (Rads)                      | —                         | 1 x 10 <sup>5</sup>             | 1 x 10 <sup>5</sup>             | 1 x 10 <sup>5</sup>                         | 1 x 10 <sup>5</sup>       | 1 x 10 <sup>5</sup>       | 1 x 10 <sup>5</sup>                         |
|  | Weathering Life Expectancy (Years)/UV Resistance | —                         | 1 – 2                           | 7 – 9                           | 7 – 9                                       | 4 – 5                     | 1 – 2                     | 7 – 9                                       |
|  | Impact Resistance                                | —                         | ○                               | ○                               | ●   | ○                         | ○                         | ○   |
|  | Salts  | —                         | ●                               | ●                               | ●   | ●                         | ●                         | ●   |
|  | Hydrocarbons (Gas, Oil, Lubricants)              | —                         | ●                               | ●                               | ●   | ●                         | ●                         | ●   |
|  | Chlorinated Hydrocarbons                         | —                         | ●                               | ●                               | ●   | ●                         | ●                         | ●   |
|  | Acids  | —                         | ●                               | ●                               | ●   | ●                         | ●                         | ●   |
|  | Bases  | —                         | ●                               | ●                               | ●   | ●                         | ●                         | ●   |
|  | Acid Rain  | —                         | ●                               | ●                               | ●   | ●                         | ●                         | ●   |
|  | Max. Continuous Use Temperature (Note 1)         | UL 746B                   | 185°F<br>85°C                   | 185°F<br>85°C                   | 185°F<br>85°C                               | 239°F<br>115°C            | 239°F<br>115°C            | 212°F<br>100°C<br>(Note 2)                  |
|  | Min. Application Use Temperature                 | EN 50146                  | -76°F<br>-60°C                  | -76°F<br>-60°C                  | -76°F<br>-60°C                              | -76°F<br>-60°C            | -76°F<br>-60°C            | -76°F<br>-60°C                              |
|  | Flammability Rating (Note 4)                     | UL 94                     | V-2                             | V-2                             | HB  | V-2                       | V-2                       | V-2   |
|  | Low Smoke  | ASTM E662                 | PASS                            | PASS                            | PASS  | PASS                      | PASS                      | PASS  |
|  | Oxygen Index                                     | BS ISO 4589               | 28                              | 28                              | —   | 28                        | 28                        | 28  |
|  | Halogen-Free                                     | IEC 60754-2               | Yes                             | Yes                             | Yes   | Yes                       | Yes                       | Yes   |
|  | Burning Fume Toxicity                            | BSS-7239                  | PASS                            | PASS                            | PASS  | PASS                      | PASS                      | PASS  |
|  | Heat Deflection Temperature @ 1.8 Mpa            | ASTM D648<br>ISO 75 -1/-2 | 158°F<br>70°C                   | 158°F<br>70°C                   | 145°F<br>63°C                               | 158°F<br>70°C             | 158°F<br>70°C             | 158°F<br>70°C                               |
|  | Relative Price                                   | —                         | Low                             | Low                             | Low   | Low                       | Low                       | Med   |

| Product Line              |   | Cross Sections |           |   |   |   |
|---------------------------|---|----------------|-----------|---|---|---|
| Pan-Ty® (B1.6 - Note 5)   | ✓ | SM, M, I, S    | LH, H, EH | ✓ | ✓ | ✓ |
| Super-Grip® (B1.38)       | ✓ | M, I, S, LH    | H         | ✓ |   |   |
| Dome-Top® Barb Ty (B1.43) | ✓ | M, I, S        | LH        | ✓ | ✓ | ✓ |
| Dura-Ty™ (B1.53)          |   |                |           |   |   |   |
| Parallel-Entry (B1.56)    | ✓ | M, I, S, HS    | LH        |   | ✓ |   |
| Sta-Strap® (B1.65)        | ✓ | M, I, S, LH, H |           | ✓ |   |   |
| Specialty Ties (B1.73)    | ✓ |                | H         | ✓ |   | ✓ |

Check mark indicates material availability in that product line.

Cross Sections: SM = Subminiature, M = Miniature, I = Intermediate, S = Standard, HS = Heavy-Standard, LH = Light-Heavy, H = Heavy, EH = Extra-Heavy.

\*For information on re-usable Hook and Loop Cable Ties, see page B1.85.

A.  
System  
Overview

B1.  
Cable Ties

B2.  
Cable  
Accessories

B3.  
Stainless  
Steel Ties

C1.  
Wiring  
Duct

C2.  
Surface  
Raceway

C3.  
Abrasion  
Protection

C4.  
Cable  
Management

D1.  
Terminals

D2.  
Power  
Connectors

D3.  
Grounding  
Connectors

E1.  
Labeling  
Systems

E2.  
Labels

E3.  
Pre-Printed  
& Write-On  
Markers

E4.  
Permanent  
Identification

E5.  
Lockout/  
Tagout  
& Safety  
Solutions

F.  
Index

|                       |         |      |            |     |        |
|-----------------------|---------|------|------------|-----|--------|
| Recommendation Legend | Highest | High | Acceptable | Low | Lowest |
|                       | ●       | ◐    | ○          | ◑   | ●      |

| Bundle                    | Bundle, Identify          | Bundle                     | Bundle              | Bundle, Re-use                  | Bundle              | Bundle              | Bundle                     | Bundle                     | Bundle                         | Bundle                   |
|---------------------------|---------------------------|----------------------------|---------------------|---------------------------------|---------------------|---------------------|----------------------------|----------------------------|--------------------------------|--------------------------|
| Flame Retardant Nylon 6.6 | Flame Retardant Nylon 6.6 | Weather Resistant Nylon 12 | Polypropylene       | Weather Resistant Polypropylene | TEFZEL <sup>■</sup> | HALAR <sup>▲</sup>  | PEEK                       | Metal Detectable Nylon 6.6 | Metal Detectable Polypropylene | Weather Resistant Acetal |
| Black                     | Natural Ivory             | Black                      | Green               | Black                           | Aqua Blue           | Maroon              | Brown                      | Blue                       | Blue                           | Black                    |
| 60                        | 69                        | 120                        | 109                 | 100                             | 76                  | 702Y                | 71                         | 86                         | 186                            | N/A                      |
| 11,000                    | 11,000                    | 6,700                      | 4,100               | 4,100                           | 7,500               | 7,000               | 15,200                     | —                          | —                              | 6,500                    |
| 1.1%                      | 1.1%                      | 0.3%                       | 0.1%                | 0.1%                            | <0.03%              | <0.05%              | 0.5%                       | 1.2%                       | 0.1%                           | <0.45%                   |
| 1 x 10 <sup>5</sup>       | 1 x 10 <sup>5</sup>       | 3.5 x 10 <sup>6</sup>      | 1 x 10 <sup>6</sup> | 1 x 10 <sup>6</sup>             | 2 x 10 <sup>8</sup> | 2 x 10 <sup>8</sup> | 1 x 10 <sup>9</sup>        | —                          | 1 x 10 <sup>6</sup>            | 6 x 10 <sup>5</sup>      |
| 1 – 2                     | 1 – 2                     | 12 – 15                    | 1                   | 7 – 9                           | >15                 | >15                 | —                          | —                          | 1                              | >20                      |
| ◑                         | ◑                         | ○                          | ◐                   | ◐                               | ●                   | ●                   | ●                          | ○                          | ◐                              | ◐                        |
| ◑                         | ◑                         | ◐                          | ●                   | ●                               | ●                   | ●                   | ●                          | ●                          | ●                              | ○                        |
| ●                         | ●                         | ●                          | ○                   | ○                               | ●                   | ●                   | ●                          | ●                          | ○                              | ●                        |
| ◐                         | ◐                         | ◐                          | ○                   | ○                               | ●                   | ●                   | ●                          | ◐                          | ○                              | ◐                        |
| ●                         | ●                         | ●                          | ●                   | ●                               | ●                   | ●                   | ○                          | ●                          | ●                              | ●                        |
| ◐                         | ◐                         | ◐                          | ●                   | ●                               | ●                   | ●                   | ●                          | ◐                          | ●                              | ●                        |
| ○                         | ○                         | ◐                          | ●                   | ●                               | ●                   | ●                   | ◐                          | ○                          | ●                              | ○                        |
| 212°F<br>100°C            | 212°F<br>100°C            | 194°F<br>90°C              | 239°F<br>115°C      | 239°F<br>115°C                  | 338°F<br>170°C      | 302°F<br>150°C      | 500°F<br>260°C<br>(Note 3) | 185°F<br>85°C              | 239°F<br>115°C                 | 185°F<br>85°C            |
| -40°F<br>-40°C            | -76°F<br>-60°C            | -76°F<br>-60°C             | -76°F<br>-60°C      | -76°F<br>-60°C                  | -76°F<br>-60°C      | -76°F<br>-60°C      | -76°F<br>-60°C             | -76°F<br>-60°C             | -76°F<br>-60°C                 | -76°F<br>-60°C           |
| V-0                       | V-0                       | HB                         | HB                  | HB                              | V-0                 | V-0                 | V-0                        | HB                         | HB                             | HB                       |
| PASS                      | PASS                      | —                          | —                   | —                               | —                   | —                   | PASS                       | —                          | —                              | PASS                     |
| 34                        | 34                        | —                          | —                   | —                               | 30                  | 52                  | 35                         | —                          | —                              | —                        |
| Yes                       | Yes                       | Yes                        | Yes                 | Yes                             | No                  | No                  | Yes                        | Yes                        | Yes                            | Yes                      |
| PASS                      | PASS                      | —                          | —                   | —                               | —                   | —                   | —                          | —                          | —                              | —                        |
| 154°F<br>68°C             | 154°F<br>68°C             | 122°F<br>50°C              | 122°F<br>50°C       | 122°F<br>50°C                   | —                   | 149°F<br>65°C       | 313°F<br>156°C             | 145°F<br>63°C              | 122°F<br>50°C                  | 239°F<br>115°C           |
| Med                       | Med                       | Med                        | Med                 | Med                             | High                | High                | High                       | Low                        | Med                            | Med                      |

|   |   |   |   |   |   |   |   |   |   |   |
|---|---|---|---|---|---|---|---|---|---|---|
| ✓ | ✓ | ✓ | ✓ | ✓ | ✓ | ✓ | ✓ | ✓ | ✓ | ✓ |
|   | ✓ |   |   |   |   |   |   |   |   |   |
|   | ✓ |   |   |   |   |   |   |   |   | ✓ |
|   |   |   |   |   |   |   |   |   |   |   |
|   |   |   |   |   |   |   |   |   |   |   |

**Note 1:** Also known as Relative Thermal Index (RTI), see Temperature (page B1.103)

**Note 2:** Estimated  
**Note 3:** Based on the UL RTI for electrical properties

**Note 4:** See Table B (page B1.102)  
**Note 5:** Also available in 00 material (meets Mil Spec)

■TEFZEL is a registered trademark of E.I. du Pont de Nemours and Company.

▲HALAR is a registered trademark of Ausimont USA, Inc.

A.  
System  
Overview

## Cable Tie Styles Overview

B1.  
Cable Ties

### Pan-Ty® Cable Ties

Pages B1.6 – B1.37

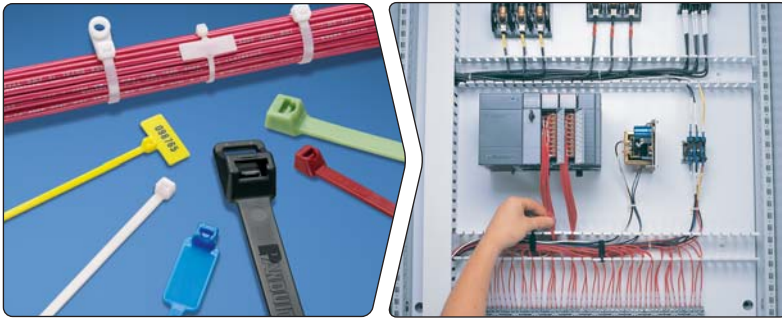

- Designed for use in numerous applications to meet a variety of needs in the OEM, MRO, and construction markets
- Largest selection of styles, materials, and sizes
- One-piece construction for consistent performance and reliability
- Lowest threading force of any one-piece cable tie in the industry

B2.  
Cable  
Accessories

B3.  
Stainless  
Steel Ties

C1.  
Wiring  
Duct

### Super-Grip® Cable Ties

Pages B1.38 – B1.42



- Designed for the strength requirements of the MRO and construction markets
- Thin, wide strap body – flexible, conforms to bundles
- Strong – withstands rough installation practices
- Grips wires tightly and resists lateral movement

C2.  
Surface  
Raceway

C3.  
Abrasion  
Protection

C4.  
Cable  
Management

D1.  
Terminals

### Dome-Top® Barb Ty Cable Ties

Pages B1.43 – B1.55



- Approved for the demanding MRO and construction requirements as typified in the oil and gas markets
- Stainless steel barb provides consistent performance and reliability
- Infinitely adjustable for tight bundles throughout entire bundle range
- Dome-top head features unique patented design with smooth, round edges

D2.  
Power  
Connectors

D3.  
Grounding  
Connectors

E1.  
Labeling  
Systems

E2.  
Labels

### Parallel-Entry Cable Ties

Pages B1.56 – B1.64



- Designed for use in the OEM and transportation markets
- All parallel-entry ties provide a low profile head which avoids snags and reduces overall bundle size
- No protrusion of tie cut-off – protects workers' arms/hands
- Contour-Ty® Cable Ties have outside teeth and smooth, round edges to protect cable jacket – perfect for high vibration applications

E3.  
Pre-Printed  
& Write-On  
Markers

E4.  
Permanent  
Identification

E5.  
Lockout/  
Tagout  
& Safety  
Solutions

F.  
Index



## Sta-Strap® Cable Ties

Pages B1.65 – B1.72

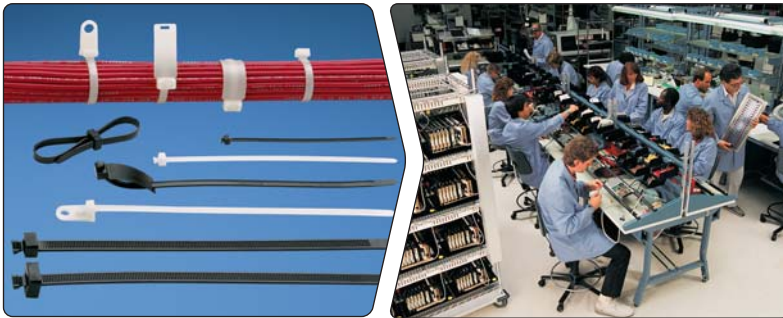

- Convenient and easy to use in OEM manual assembly operations
- Exclusive, two-piece design provides lowest threading force in the industry
- Use for normal bundling and through-panel applications
- Releasable prior to final tensioning and cut-off

## Network Cable Ties

Pages B1.85 – B1.92



- Ideal for the telecommunications, financial, education, and government markets
- Adjustable, releasable, and re-usable
- No risk of over-tensioning or damaging high performance network cables
- Variety of styles, sizes, and colors

## Manual Cable Tie Installation Tools

Pages B1.109 – B1.114

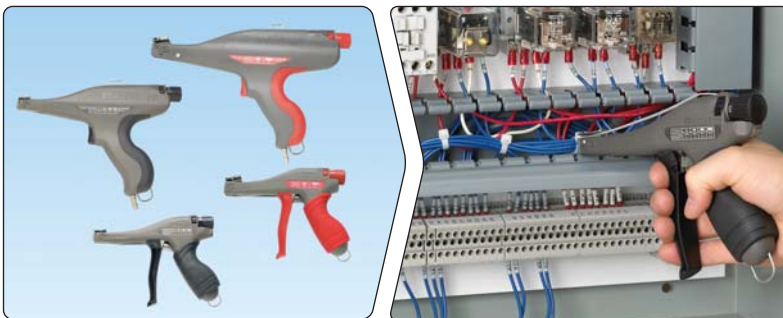

- Used in production, maintenance, and construction applications
- Designed for ease of use and to reduce repetitive stress injuries
- Full line of lightweight, ergonomic hand tools – Panduit leads the industry in reliability and performance
- Flush cut-off of cable tie limits exposure to sharp edges

## Automatic Cable Tie Installation Tools

Pages B1.115 – B1.122



- An efficient solution for high volume OEM harness, assembly, fastening and packaging applications
- High-speed tools lower installed cost and reduce operator fatigue
- Wrap, tension, and cut-off cable ties in less than a second
- Reel-fed systems for miniature and standard cross section cable ties

A.  
System  
Overview

## Features and Benefits – Pan-Ty® Cable Ties

One-piece design for consistent performance and reliability.

Available in lengths from 2.8 to 43.3 inches and a variety of styles, materials, and colors for specific applications.

B1.  
Cable Ties

B2.  
Cable  
Accessories

B3.  
Stainless  
Steel Ties

C1.  
Wiring  
Duct

C2.  
Surface  
Raceway

C3.  
Abrasion  
Protection

C4.  
Cable  
Management

D1.  
Terminals

D2.  
Power  
Connectors

D3.  
Grounding  
Connectors

E1.  
Labeling  
Systems

E2.  
Labels

E3.  
Pre-Printed  
& Write-On  
Markers

E4.  
Permanent  
Identification

E5.  
Lockout/  
Tagout  
& Safety  
Solutions

F.  
Index

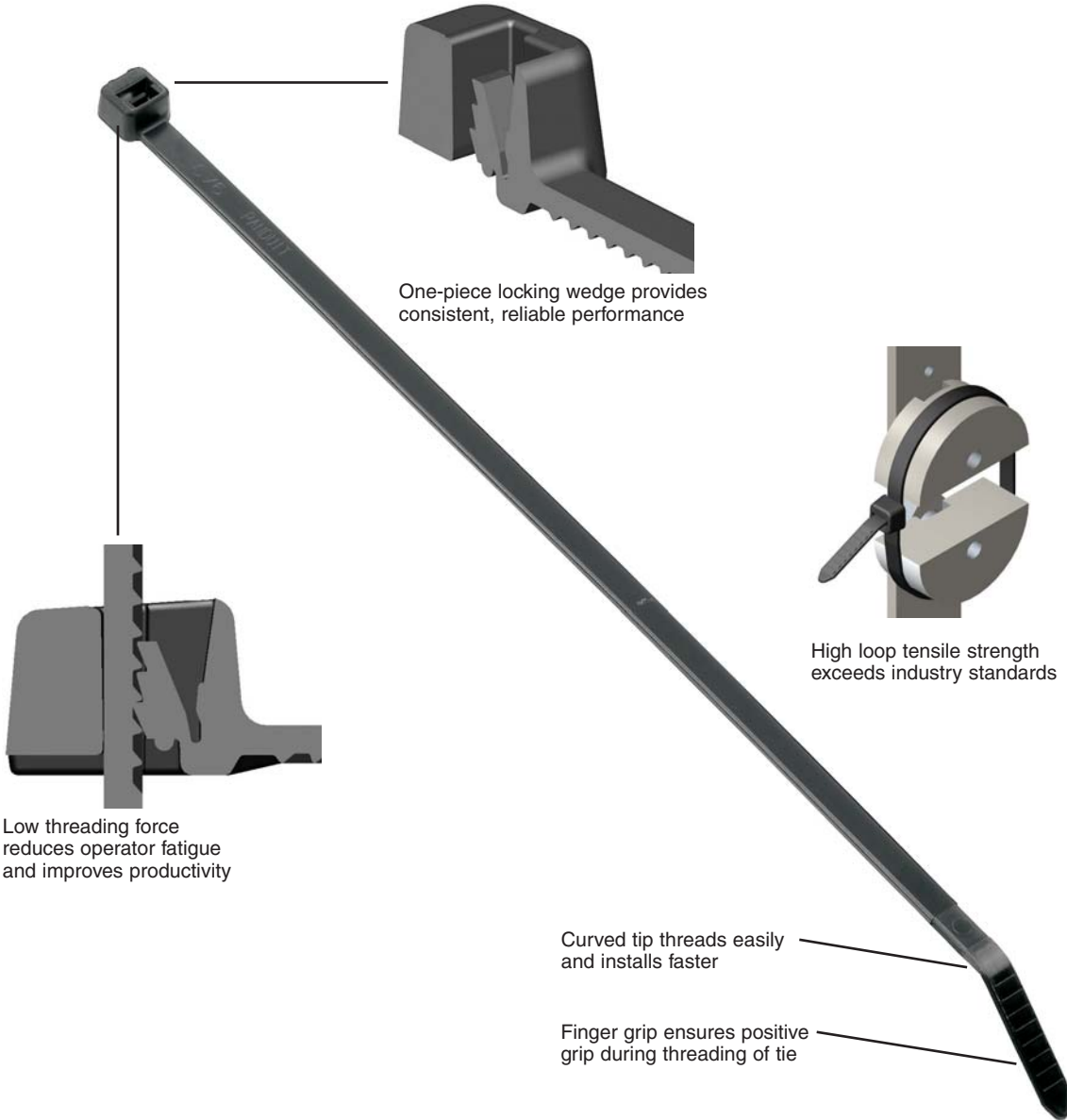

Cable tie tools speed installation and reduce total installed cost. See pages B1.109 – B1.114.



Cable tie accessories are used to speed and simplify the mounting of wires, cables, and tubing. See pages B2.1 – B2.29.

## Selection Guide – Pan-Ty® Cable Ties



| Material, Color (Suffix)  | Style/Function            | Part Number Prefix           | Catalog Page  |
|---|---------------------------|------------------------------|---------------|
| Nylon 6.6, Natural (No Suffix)  | Locking Ties/Bundle       | PLT                          | B1.8,9        |
|   | Releasable Ties/Re-usable | PRT                          | B1.22         |
|   | Clamp Ties/Mount          | PLC                          | B1.26         |
|   | Push Mount Ties/Mount     | PLWP, PRWP, PLUP, PLP        | B1.28,30,33   |
|   | Marker Ties/Identify      | PLF, PLM                     | B1.34         |
| Weather Resistant Nylon 6.6, Black (0)                                    | Locking Ties/Bundle       | PLT                          | B1.10,11      |
|   | Releasable Ties/Re-usable | PRT                          | B1.23,24      |
|   | Clamp Ties/Mount          | PLC                          | B1.27         |
|   | Push Mount Ties/Mount     | PLWP, PRWP, PLUP, PLP        | B1.29 – B1.33 |
|   | Marker Ties/Identify      | PLF, PLM                     | B1.34         |
| Heat Stabilized Nylon 6.6, Black (30)                                     | Locking Ties/Bundle       | PLT                          | B1.12         |
|   | Releasable Ties/Re-usable | PRT                          | B1.23,24      |
|   | Clamp Ties/Mount          | PLC                          | B1.27         |
|   | Push Mount Ties/Mount     | PLWP, PRLWP, PRWP, PLUP, PLP | B1.29 – B1.33 |
| Heat Stabilized Weather Resistant Nylon 6.6, Black (300)                  | Locking Ties/Bundle       | PLT                          | B1.13         |
| Heat Stabilized Nylon 6.6, Natural (39)                                   | Locking Ties/Bundle       | PLT                          | B1.12         |
| Flame Retardant Nylon 6.6, Black (60)                                     | Locking Ties/Bundle       | PLT                          | B1.14         |
| Flame Retardant Nylon 6.6, Ivory (69)                                     | Locking Ties/Bundle       | PLT                          | B1.14         |
|   | Marker Ties/Identify      | PLF, PLM                     | B1.34         |
| Weather Resistant Nylon 12, Black (120)                                   | Locking Ties/Bundle       | PLT                          | B1.15         |
| Polypropylene, Green (109)  | Locking Ties/Bundle       | PLT                          | B1.16         |
| Weather Resistant Polypropylene, Black (100)                              | Locking Ties/Bundle       | PLT                          | B1.17         |
|   | Releasable Ties/Re-usable | PRT                          | B1.25         |
| HALAR <sup>▲</sup> , Maroon (702)<br>TEFZEL <sup>■</sup> , Aqua Blue (76) | Locking Ties/Bundle       | PLT                          | B1.18,19      |
|   | Locking Ties/Bundle       | PLT                          | B1.18,19      |
| PEEK, Translucent Brown (71)  | Locking Ties/Bundle       | PLT                          | B1.20         |
| Metal Detectable, Blue (86, 186)  | Locking Ties/Bundle       | PLT                          | B1.21         |

▲HALAR is a registered trademark of Ausimont USA, Inc.    ■TEFZEL is a registered trademark of E.I. du Pont de Nemours and Company.

### Part Number System for Pan-Ty® Cable Ties

| PLT                                       | 2          | S                 | —                 | C                      | —              |
|---|------------|-------------------|-------------------|------------------------|----------------|
| Type                                      | Size       | Cross Section     | Screw Hole Size   | Package Size           | Material/Color |
| PLT = Locking Tie                         | Approx.    | SM = Subminiature | (Clamp Ties Only) | Q = 25                 | See Page B1.35 |
| PRT = Releasable Tie                      | Maximum    | M = Miniature     | -S4 = #4 (M2.5)   | L = 50                 |                |
| PLC = Locking Clamp                       | Bundle     | I = Intermediate  | -S6 = #6 (M3)     | C = 100                |                |
| PLF = Locking Flag                        | Dia. (In.) | S = Standard      | -S8 = #8 (M4)     | TL = 250               |                |
| PLM = Locking Marker                      |            | LH = Light-Heavy  | -S10 = #10 (M5)   | D = 500                |                |
| PLP = Locking Push Mount                  |            | H = Heavy         | -S25 = 1/4 (M6)   | M = 1000               |                |
| PLWP = Locking Wing Push Mount            |            | EH = Extra-Heavy  |                   | VMR = 2 reels/2500 ea. |                |
| PRLWP = Releasable Ladder Wing Push Mount |            |                   |                   | XMR = 2 reels/5000 ea. |                |
| PRWP = Releasable Wing Push Mount         |            |                   |                   |                        |                |
| PLUP = Locking Umbrella Push Mount        |            |                   |                   |                        |                |

A. System Overview

**UL US** **UL LISTED** **SF US** **Pan-Ty® Cable Ties – Nylon 6.6**

B1. Cable Ties

- For indoor use
- Versatile cable ties can be used in countless applications
- One-piece construction for consistent performance and reliability
- Lowest threading force of any one-piece cable tie in the industry

- Curved tip is easy to pick up from flat surfaces and allows faster initial threading to speed installation
- A variety of materials and colors available for specific applications
- UL Listed for use in plenum or air handling spaces per NEC except PLT.6SM and PLT5H/6H/8H/13H

B2. Cable Accessories

B3. Stainless Steel Ties

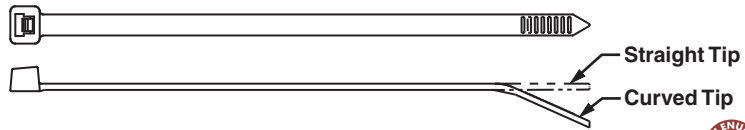
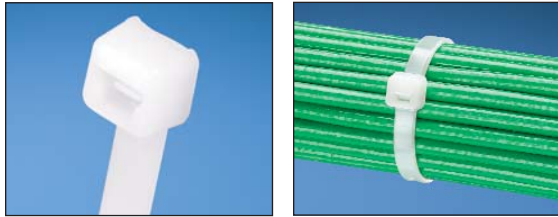

C1. Wiring Duct

C2. Surface Raceway

| Part Number | Length |    | Width |    | Thickness |    | Max. Bundle Dia. |    | Min. Loop Tensile Str. |   | Recommended Installation Tool | Std. Pkg. Qty. | Std. Ctn. Qty. |
|-------------|--------|----|-------|----|-----------|----|------------------|----|------------------------|---|-------------------------------|----------------|----------------|
|             | In.    | mm | In.   | mm | In.       | mm | In.              | mm | Lbs.                   | N |                               |                |                |

**Subminiature Cross Section**

|                  |     |    |      |     |      |    |     |    |   |    |                |     |      |
|------------------|-----|----|------|-----|------|----|-----|----|---|----|----------------|-----|------|
| <b>PLT.6SM-C</b> | 2.8 | 71 | .070 | 1.8 | .030 | .8 | .60 | 15 | 8 | 36 | GTS, GTSL, PTS | 100 | 1000 |
|------------------|-----|----|------|-----|------|----|-----|----|---|----|----------------|-----|------|

**Miniature Cross Section – Plenum-Rated**

|                  |     |     |      |     |      |     |      |    |    |    |                                  |     |      |
|------------------|-----|-----|------|-----|------|-----|------|----|----|----|----------------------------------|-----|------|
| <b>PLT.7M-C</b>  | 3.1 | 79  | .090 | 2.3 | .032 | .8  | .68  | 17 | 18 | 80 | GTS, GTSL, GS2B, PTS, PPTS, STS2 | 100 | 1000 |
| <b>PLT1M-C</b>   | 3.9 | 99  | .098 | 2.5 | .043 | 1.1 | .87  | 22 | 18 | 80 |                                  | 100 | 1000 |
| <b>PLT1.5M-C</b> | 5.6 | 142 | .098 | 2.5 | .043 | 1.1 | 1.25 | 32 | 18 | 80 |                                  | 100 | 1000 |
| <b>PLT2M-C</b>   | 8.0 | 203 | .098 | 2.5 | .043 | 1.1 | 2.00 | 51 | 18 | 80 |                                  | 100 | 1000 |

**Intermediate Cross Section – Plenum-Rated**

|                  |      |     |      |     |      |     |      |     |    |     |                                  |     |      |
|------------------|------|-----|------|-----|------|-----|------|-----|----|-----|----------------------------------|-----|------|
| <b>PLT1.5I-C</b> | 5.6  | 142 | .142 | 3.6 | .045 | 1.1 | 1.38 | 35  | 40 | 178 | GTS, GTSL, GS2B, PTS, PPTS, STS2 | 100 | 1000 |
| <b>PLT2I-C</b>   | 8.0  | 203 | .142 | 3.6 | .045 | 1.1 | 2.00 | 51  | 40 | 178 |                                  | 100 | 1000 |
| <b>PLT2.5I-C</b> | 9.7  | 246 | .145 | 3.7 | .052 | 1.3 | 2.50 | 64  | 40 | 178 |                                  | 100 | 1000 |
| <b>PLT3I-C</b>   | 11.4 | 290 | .145 | 3.7 | .052 | 1.3 | 3.00 | 76  | 40 | 178 |                                  | 100 | 1000 |
| <b>PLT4I-C</b>   | 14.5 | 368 | .145 | 3.7 | .052 | 1.3 | 4.00 | 102 | 40 | 178 |                                  | 100 | 1000 |

**Standard Cross Section – Plenum-Rated**

|                  |      |     |      |     |      |     |      |     |    |     |  |     |      |
|------------------|------|-----|------|-----|------|-----|------|-----|----|-----|--|-----|------|
| <b>PLT1S-C</b>   | 4.8  | 122 | .190 | 4.8 | .052 | 1.3 | 1.00 | 25  | 50 | 222 | GTS, GTSL, GS2B, GTH, GS4H, PTS, PPTS, PTH, STS2, STH2 | 100 | 1000 |
| <b>PLT1.5S-C</b> | 6.2  | 157 | .190 | 4.8 | .052 | 1.3 | 1.50 | 38  | 50 | 222 |  | 100 | 1000 |
| <b>PLT2S-C</b>   | 7.4  | 188 | .190 | 4.8 | .052 | 1.3 | 1.88 | 48  | 50 | 222 |  | 100 | 1000 |
| <b>PLT2.5S-C</b> | 9.8  | 249 | .190 | 4.8 | .052 | 1.3 | 2.50 | 64  | 50 | 222 |  | 100 | 1000 |
| <b>PLT3S-C</b>   | 11.5 | 292 | .190 | 4.8 | .052 | 1.3 | 3.00 | 76  | 50 | 222 |  | 100 | 1000 |
| <b>PLT4S-C</b>   | 14.5 | 368 | .190 | 4.8 | .052 | 1.3 | 4.00 | 102 | 50 | 222 |  | 100 | 1000 |
| <b>PLT4.5S-C</b> | 15.5 | 394 | .190 | 4.8 | .052 | 1.3 | 4.50 | 114 | 50 | 222 |  | 100 | 1000 |
| <b>PLT5S-C</b>   | 17.5 | 445 | .190 | 4.8 | .052 | 1.3 | 5.00 | 127 | 50 | 222 |  | 100 | 500  |

**Light-Heavy Cross Section (Straight Tip) – Plenum-Rated**

|                   |      |     |      |     |      |     |       |     |     |     |                                    |    |      |
|-------------------|------|-----|------|-----|------|-----|-------|-----|-----|-----|------------------------------------|----|------|
| <b>PLT2H-L</b>    | 8.1  | 206 | .300 | 7.6 | .075 | 1.9 | 2.00  | 51  | 120 | 534 | GTH, GS4H, GS4EH, PTH, STH2, ST3EH | 50 | 500  |
| <b>PLT2.5H-L</b>  | 9.8  | 251 | .300 | 7.6 | .075 | 1.9 | 2.50  | 64  | 120 | 534 |                                    | 50 | 500  |
| <b>PLT3H-L</b>    | 11.4 | 290 | .300 | 7.6 | .075 | 1.9 | 3.00  | 76  | 120 | 534 |                                    | 50 | 500  |
| <b>PLT4H-L</b>    | 14.5 | 368 | .300 | 7.6 | .075 | 1.9 | 4.00  | 102 | 120 | 534 |                                    | 50 | 500  |
| <b>PLT6LH-L</b>   | 21.9 | 556 | .300 | 7.6 | .075 | 1.9 | 6.00  | 152 | 120 | 534 |                                    | 50 | 500  |
| <b>PLT7LH-L</b>   | 24.7 | 627 | .300 | 7.6 | .075 | 1.9 | 7.00  | 178 | 120 | 534 |                                    | 50 | 500  |
| <b>PLT8LH-L</b>   | 27.6 | 701 | .300 | 7.6 | .075 | 1.9 | 8.00  | 203 | 120 | 534 |                                    | 50 | 500  |
| <b>PLT9LH-L*</b>  | 30.5 | 775 | .300 | 7.6 | .075 | 1.9 | 9.00  | 229 | 120 | 534 |                                    | 50 | 500  |
| <b>PLT10LH-L*</b> | 34.3 | 871 | .300 | 7.6 | .075 | 1.9 | 10.31 | 262 | 120 | 534 |                                    | 50 | 1000 |

**Heavy Cross Section (Straight Tip)**

|                  |      |      |      |     |      |     |       |     |     |     |                                    |    |     |
|------------------|------|------|------|-----|------|-----|-------|-----|-----|-----|------------------------------------|----|-----|
| <b>PLT5H-L*</b>  | 17.7 | 450  | .350 | 8.9 | .078 | 2.0 | 5.00  | 127 | 175 | 778 | GTH, GS4H, GS4EH, PTH, STH2, ST3EH | 50 | 500 |
| <b>PLT6H-L*</b>  | 20.9 | 530  | .350 | 8.9 | .078 | 2.0 | 6.00  | 152 | 175 | 778 |                                    | 50 | 500 |
| <b>PLT8H-L*</b>  | 30.6 | 779  | .350 | 8.9 | .078 | 2.0 | 9.00  | 229 | 175 | 778 |                                    | 50 | 500 |
| <b>PLT13H-Q*</b> | 43.3 | 1100 | .350 | 8.9 | .078 | 2.0 | 13.00 | 330 | 175 | 778 |                                    | 25 | 500 |

\*UL Listed – meets the requirements of UL 181B-C, for securing UL Listed non-metallic air ducts and air connectors.



## Pan-Ty® Lashing Ties – Nylon 6.6

- For indoor use
- Typically used for heavy duty applications
- Strongest Pan-Ty® Cable Tie available
- Can be used with MCEH mounting clip, see page B1.24

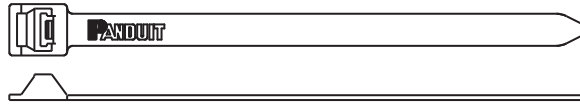

| Part Number                      | Length |      | Width |      | Thickness |     | Max. Bundle Dia. |     | Min. Loop Tensile Str. |      | Recommended Installation Tool | Std. Pkg. Qty. | Std. Ctn. Qty. |
|----------------------------------|--------|------|-------|------|-----------|-----|------------------|-----|------------------------|------|-------------------------------|----------------|----------------|
|                                  | In.    | mm   | In.   | mm   | In.       | mm  | In.              | mm  | Lbs.                   | N    |                               |                |                |
| <b>Extra-Heavy Cross Section</b> |        |      |       |      |           |     |                  |     |                        |      |                               |                |                |
| PLT2EH-C                         | 9.0    | 229  | .500  | 12.7 | .075      | 1.9 | 2.00             | 51  | 250                    | 1112 | GS4EH, ST3EH                  | 100            | 1000           |
| PLT5EH-Q                         | 20.1   | 511  | .500  | 12.7 | .075      | 1.9 | 5.00             | 127 | 250                    | 1112 |                               | 25             | 250            |
| PLT6EH-Q                         | 22.2   | 564  | .500  | 12.7 | .075      | 1.9 | 6.00             | 152 | 250                    | 1112 |                               | 25             | 250            |
| PLT8EH-C                         | 28.3   | 719  | .500  | 12.7 | .085      | 2.2 | 8.00             | 203 | 250                    | 1112 |                               | 100            | 1000           |
| PLT10EH-C                        | 34.2   | 869  | .500  | 12.7 | .085      | 2.2 | 10.00            | 254 | 250                    | 1112 |                               | 100            | 500            |
| PLT12EH-C                        | 40.1   | 1019 | .500  | 12.7 | .085      | 2.2 | 12.00            | 305 | 250                    | 1112 |                               | 100            | 500            |

A.  
System  
Overview

B1.  
Cable Ties

B2.  
Cable  
Accessories

B3.  
Stainless  
Steel Ties

C1.  
Wiring  
Duct

C2.  
Surface  
Raceway

C3.  
Abrasion  
Protection

C4.  
Cable  
Management

D1.  
Terminals

D2.  
Power  
Connectors

D3.  
Grounding  
Connectors

E1.  
Labeling  
Systems

E2.  
Labels

E3.  
Pre-Printed  
& Write-On  
Markers

E4.  
Permanent  
Identification

E5.  
Lockout/  
Tagout  
& Safety  
Solutions

F.  
Index

A. System Overview



## Pan-Ty® Cable Ties – Weather Resistant Nylon 6.6

B1. Cable Ties

- Greater resistance to damage caused by ultraviolet light – indoor or outdoor use
- Versatile cable ties can be used in countless applications
- One-piece construction for consistent performance and reliability
- Lowest threading force of any one-piece cable tie in the industry
- Curved tip is easy to pick up from flat surfaces and allows faster initial threading to speed installation

B2. Cable Accessories



B3. Stainless Steel Ties

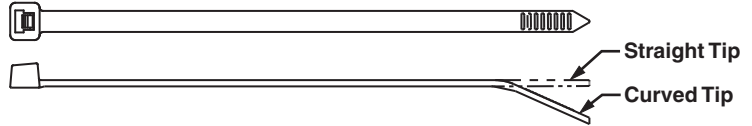

C1. Wiring Duct

C2. Surface Raceway

| Part Number | Length |    | Width |    | Thickness |    | Max. Bundle Dia. |    | Min. Loop Tensile Str. |   | Recommended Installation Tool | Std. Pkg. Qty. | Std. Ctn. Qty. |
|-------------|--------|----|-------|----|-----------|----|------------------|----|------------------------|---|-------------------------------|----------------|----------------|
|             | In.    | mm | In.   | mm | In.       | mm | In.              | mm | Lbs.                   | N |                               |                |                |

### Subminiature Cross Section

|                   |     |    |      |     |      |    |     |    |   |    |                |     |      |
|-------------------|-----|----|------|-----|------|----|-----|----|---|----|----------------|-----|------|
| <b>PLT.6SM-C0</b> | 2.8 | 71 | .070 | 1.8 | .030 | .8 | .60 | 15 | 8 | 36 | GTS, GTSL, PTS | 100 | 1000 |
|-------------------|-----|----|------|-----|------|----|-----|----|---|----|----------------|-----|------|

### Miniature Cross Section

|                   |     |     |      |     |      |     |      |    |    |    |                                  |      |       |
|-------------------|-----|-----|------|-----|------|-----|------|----|----|----|----------------------------------|------|-------|
| <b>PLT.7M-M0</b>  | 3.1 | 79  | .090 | 2.3 | .032 | .8  | .68  | 17 | 18 | 80 | GTS, GTSL, GS2B, PTS, PPTS, STS2 | 1000 | 50000 |
| <b>PLT1M-C0</b>   | 3.9 | 99  | .098 | 2.5 | .043 | 1.1 | .87  | 22 | 18 | 80 |                                  | 100  | 1000  |
| <b>PLT1.5M-C0</b> | 5.6 | 142 | .098 | 2.5 | .043 | 1.1 | 1.25 | 32 | 18 | 80 |                                  | 100  | 1000  |
| <b>PLT2M-C0</b>   | 8.0 | 203 | .098 | 2.5 | .043 | 1.1 | 2.00 | 51 | 18 | 80 |                                  | 100  | 1000  |

### Intermediate Cross Section

|                   |      |     |      |     |      |     |      |     |    |     |                                  |     |      |
|-------------------|------|-----|------|-----|------|-----|------|-----|----|-----|----------------------------------|-----|------|
| <b>PLT1.5I-C0</b> | 5.6  | 142 | .142 | 3.6 | .045 | 1.1 | 1.38 | 35  | 40 | 178 | GTS, GTSL, GS2B, PTS, PPTS, STS2 | 100 | 1000 |
| <b>PLT2I-C0</b>   | 8.0  | 203 | .142 | 3.6 | .045 | 1.1 | 2.00 | 51  | 40 | 178 |                                  | 100 | 1000 |
| <b>PLT2.5I-C0</b> | 9.7  | 246 | .145 | 3.7 | .052 | 1.3 | 2.50 | 64  | 40 | 178 |                                  | 100 | 1000 |
| <b>PLT3I-C0</b>   | 11.4 | 290 | .145 | 3.7 | .052 | 1.3 | 3.00 | 76  | 40 | 178 |                                  | 100 | 1000 |
| <b>PLT4I-C0</b>   | 14.5 | 368 | .145 | 3.7 | .052 | 1.3 | 4.00 | 102 | 40 | 178 |                                  | 100 | 1000 |

### Standard Cross Section

|                   |      |     |      |     |      |     |      |     |    |     |  |     |      |
|-------------------|------|-----|------|-----|------|-----|------|-----|----|-----|--|-----|------|
| <b>PLT1S-C0</b>   | 4.8  | 122 | .190 | 4.8 | .052 | 1.3 | 1.00 | 25  | 50 | 222 | GTS, GTSL, GS2B, GTH, GS4H, PTS, PTH, PPTS, STS2, STH2 | 100 | 1000 |
| <b>PLT1.5S-C0</b> | 6.2  | 157 | .190 | 4.8 | .052 | 1.3 | 1.50 | 38  | 50 | 222 |  | 100 | 1000 |
| <b>PLT2S-C0</b>   | 7.4  | 188 | .190 | 4.8 | .052 | 1.3 | 1.88 | 48  | 50 | 222 |  | 100 | 1000 |
| <b>PLT2.5S-C0</b> | 9.8  | 249 | .190 | 4.8 | .052 | 1.3 | 2.50 | 64  | 50 | 222 |  | 100 | 1000 |
| <b>PLT3S-C0</b>   | 11.5 | 292 | .190 | 4.8 | .052 | 1.3 | 3.00 | 76  | 50 | 222 |  | 100 | 1000 |
| <b>PLT4S-C0</b>   | 14.5 | 368 | .190 | 4.8 | .052 | 1.3 | 4.00 | 102 | 50 | 222 |  | 100 | 1000 |
| <b>PLT4.5S-C0</b> | 15.5 | 394 | .190 | 4.8 | .052 | 1.3 | 4.50 | 114 | 50 | 222 |  | 100 | 1000 |
| <b>PLT5S-C0</b>   | 17.5 | 445 | .190 | 4.8 | .052 | 1.3 | 5.00 | 127 | 50 | 222 |  | 100 | 500  |

### Light-Heavy Cross Section (Straight Tip)

|                   |      |     |      |     |      |     |      |     |     |     |                                    |    |     |
|-------------------|------|-----|------|-----|------|-----|------|-----|-----|-----|------------------------------------|----|-----|
| <b>PLT2H-L0</b>   | 8.1  | 206 | .300 | 7.6 | .075 | 1.9 | 2.00 | 51  | 120 | 534 | GTH, GS4H, GS4EH, PTH, STH2, ST3EH | 50 | 500 |
| <b>PLT2.5H-L0</b> | 9.8  | 251 | .300 | 7.6 | .075 | 1.9 | 2.50 | 64  | 120 | 534 |                                    | 50 | 500 |
| <b>PLT3H-L0</b>   | 11.4 | 290 | .300 | 7.6 | .075 | 1.9 | 3.00 | 76  | 120 | 534 |                                    | 50 | 500 |
| <b>PLT4H-L0</b>   | 14.5 | 368 | .300 | 7.6 | .075 | 1.9 | 4.00 | 102 | 120 | 534 |                                    | 50 | 500 |
| <b>PLT6LH-L0</b>  | 21.9 | 556 | .300 | 7.6 | .075 | 1.9 | 6.00 | 152 | 120 | 534 |                                    | 50 | 500 |
| <b>PLT7LH-L0</b>  | 24.7 | 627 | .300 | 7.6 | .075 | 1.9 | 7.00 | 178 | 120 | 534 |                                    | 50 | 500 |
| <b>PLT8LH-L0</b>  | 27.6 | 701 | .300 | 7.6 | .075 | 1.9 | 8.00 | 203 | 120 | 534 |                                    | 50 | 500 |
| <b>PLT9LH-L0</b>  | 30.5 | 775 | .300 | 7.6 | .075 | 1.9 | 9.00 | 229 | 120 | 534 |                                    | 50 | 500 |

### Heavy Cross Section (Straight Tip)

|                  |      |      |      |     |      |     |       |     |     |     |                                    |    |     |
|------------------|------|------|------|-----|------|-----|-------|-----|-----|-----|------------------------------------|----|-----|
| <b>PLT5H-L0</b>  | 17.7 | 450  | .350 | 8.9 | .078 | 2.0 | 5.00  | 127 | 175 | 778 | GTH, GS4H, GS4EH, PTH, STH2, ST3EH | 50 | 500 |
| <b>PLT6H-L0</b>  | 20.9 | 530  | .350 | 8.9 | .078 | 2.0 | 6.00  | 152 | 175 | 778 |                                    | 50 | 500 |
| <b>PLT8H-L0</b>  | 30.6 | 779  | .350 | 8.9 | .078 | 2.0 | 9.00  | 229 | 175 | 778 |                                    | 50 | 500 |
| <b>PLT13H-Q0</b> | 43.3 | 1100 | .350 | 8.9 | .078 | 2.0 | 13.00 | 330 | 175 | 778 |                                    | 25 | 500 |

Note: UL Listed and UL Recognized except PLT.6SM and PLT2H/2.5H/3H/4H/5H/6H/8H/13H; CSA Certified except LH and H cross sections.

## Pan-Ty® Lashing Ties – Weather Resistant Nylon 6.6

- Greater resistance to damage caused by ultraviolet light – indoor or outdoor use
- Typically used for heavy duty applications
- Strongest Pan-Ty® Cable Tie available
- Can be used with MCEH mounting clip, shown below



Lashing Tie



No Buckle Design

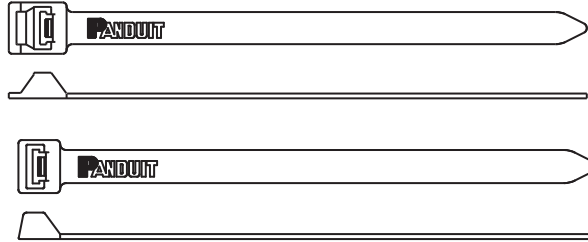

| Part Number   | Length |      | Width |      | Thickness |     | Max. Bundle Dia. |     | Min. Loop Tensile Str. |      | Recommended Installation Tool | Std. Pkg. Qty. | Std. Ctn. Qty. |
|---|--------|------|-------|------|-----------|-----|------------------|-----|------------------------|------|-------------------------------|----------------|----------------|
|   | In.    | mm   | In.   | mm   | In.       | mm  | In.              | mm  | Lbs.                   | N    |                               |                |                |
| <b>Extra-Heavy Cross Section</b>                    |        |      |       |      |           |     |                  |     |                        |      |                               |                |                |
| PLT2EH-Q0   | 9.0    | 229  | .500  | 12.7 | .075      | 1.9 | 2.00             | 51  | 250                    | 1112 | GS4EH, ST3EH                  | 25             | 250            |
| PLT5EH-Q0   | 20.1   | 511  | .500  | 12.7 | .075      | 1.9 | 5.00             | 127 | 250                    | 1112 |                               | 25             | 250            |
| PLT6EH-Q0   | 22.2   | 564  | .500  | 12.7 | .075      | 1.9 | 6.00             | 152 | 250                    | 1112 |                               | 25             | 250            |
| PLT8EH-Q0   | 28.3   | 719  | .500  | 12.7 | .085      | 2.2 | 8.00             | 203 | 250                    | 1112 |                               | 25             | 250            |
| PLT10EH-Q0  | 34.2   | 869  | .500  | 12.7 | .085      | 2.2 | 10.00            | 254 | 250                    | 1112 |                               | 25             | 250            |
| PLT12EH-Q0  | 40.1   | 1019 | .500  | 12.7 | .085      | 2.2 | 12.00            | 305 | 250                    | 1112 |                               | 25             | 250            |
| <b>Extra-Heavy Cross Section (No Buckle Design)</b> |        |      |       |      |           |     |                  |     |                        |      |                               |                |                |
| PLT3EH-NB-C0  | 12.2   | 310  | .500  | 12.7 | .075      | 1.9 | 3.30             | 84  | 250                    | 1112 | GS4EH, ST3EH                  | 100            | 1000           |
| PLT5EH-NB-C0  | 19.8   | 503  | .500  | 12.7 | .075      | 1.9 | 5.00             | 127 | 250                    | 1112 |                               | 100            | 1000           |
| PLT6EH-NB-C0  | 21.8   | 554  | .500  | 12.7 | .075      | 1.9 | 6.00             | 152 | 250                    | 1112 |                               | 100            | 1000           |

## MCEH® Lashing Tie Mounting Clip – Weather Resistant Nylon 6.6

- Greater resistance to damage caused by ultraviolet light – indoor or outdoor use
- Converts Panduit lashing ties into clamps
- Easily snaps in place for a secure clamp
- Use with lashing ties shown on pages B1.9, B1.11, B1.22, B1.24 and B1.25

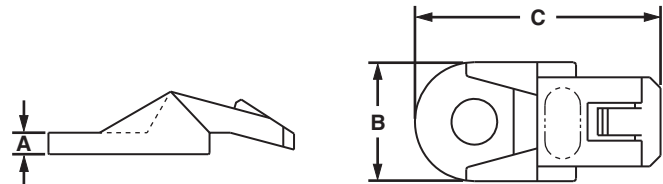

| Part Number | Height A |     | Width B |      | Length C |    | Mounting Method                | Std. Pkg. Qty. | Std. Ctn. Qty. |
|-------------|----------|-----|---------|------|----------|----|--------------------------------|----------------|----------------|
|             | In.      | mm  | In.     | mm   | In.      | mm |                                |                |                |
| MCEH-S25-C0 | .13      | 3.3 | .67     | 17.0 | 1.38     | 35 | 1/4" (M6) screw (not flathead) | 100            | 1000           |

A. System Overview

**Pan-Ty® Cable Ties – Heat Stabilized Nylon 6.6**

B1. Cable Ties

- For high temperature applications up to 239°F (115°C) – indoor use
- One-piece construction for consistent performance and reliability

- Lowest threading force of any one-piece cable tie in the industry
- Curved tip is easy to pick up from flat surfaces and allows faster initial threading to speed installation

B2. Cable Accessories



B3. Stainless Steel Ties

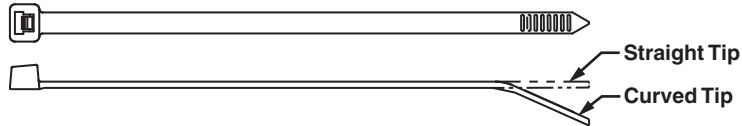

C1. Wiring Duct

C2. Surface Raceway

| Part Number | Length |    | Width |    | Thickness |    | Max. Bundle Dia. |    | Min. Loop Tensile Str. |   | Recommended Installation Tool | Std. Pkg. Qty. | Std. Ctn. Qty. |
|-------------|--------|----|-------|----|-----------|----|------------------|----|------------------------|---|-------------------------------|----------------|----------------|
|             | In.    | mm | In.   | mm | In.       | mm | In.              | mm | Lbs.                   | N |                               |                |                |

**Subminiature Cross Section**

|                    |     |    |      |     |      |    |     |    |   |    |                |      |       |
|--------------------|-----|----|------|-----|------|----|-----|----|---|----|----------------|------|-------|
| <b>PLT.6SM-M30</b> | 2.8 | 71 | .070 | 1.8 | .030 | .8 | .60 | 15 | 8 | 36 | GTS, GTSL, PTS | 1000 | 50000 |
|--------------------|-----|----|------|-----|------|----|-----|----|---|----|----------------|------|-------|

**Miniature Cross Section**

|                    |     |     |      |     |      |     |      |    |    |    |                                  |      |       |
|--------------------|-----|-----|------|-----|------|-----|------|----|----|----|----------------------------------|------|-------|
| <b>PLT.7M-M30</b>  | 3.1 | 79  | .090 | 2.3 | .032 | .8  | .68  | 17 | 18 | 80 | GTS, GTSL, GS2B, PTS, PPTS, STS2 | 1000 | 50000 |
| <b>PLT1M-C30</b>   | 3.9 | 99  | .098 | 2.5 | .043 | 1.1 | .87  | 22 | 18 | 80 |                                  | 100  | 1000  |
| <b>PLT1.5M-M30</b> | 5.6 | 142 | .098 | 2.5 | .043 | 1.1 | 1.25 | 32 | 18 | 80 |                                  | 1000 | 50000 |
| <b>PLT2M-M30</b>   | 8.0 | 203 | .098 | 2.5 | .043 | 1.1 | 2.00 | 51 | 18 | 80 |                                  | 1000 | 25000 |

**Intermediate Cross Section**

|                    |      |     |      |     |      |     |      |     |    |     |                                  |      |       |
|--------------------|------|-----|------|-----|------|-----|------|-----|----|-----|----------------------------------|------|-------|
| <b>PLT1.5I-C30</b> | 5.6  | 142 | .142 | 3.6 | .045 | 1.1 | 1.38 | 35  | 40 | 178 | GTS, GTSL, GS2B, PTS, PPTS, STS2 | 100  | 1000  |
| <b>PLT2I-C30</b>   | 8.0  | 203 | .142 | 3.6 | .045 | 1.1 | 2.00 | 51  | 40 | 178 |                                  | 100  | 1000  |
| <b>PLT3I-M30</b>   | 11.4 | 290 | .145 | 3.7 | .052 | 1.3 | 3.00 | 76  | 40 | 178 |                                  | 1000 | 10000 |
| <b>PLT4I-M30</b>   | 14.5 | 368 | .145 | 3.7 | .052 | 1.3 | 4.00 | 102 | 40 | 178 |                                  | 1000 | 10000 |

**Standard Cross Section**

|                    |      |     |      |     |      |     |      |     |    |     |  |      |       |
|--------------------|------|-----|------|-----|------|-----|------|-----|----|-----|--|------|-------|
| <b>PLT1S-M30</b>   | 4.8  | 122 | .190 | 4.8 | .052 | 1.3 | 1.00 | 25  | 50 | 222 | GTS, GTSL, GS2B, GTH, GS4H, PTS, PTH, PPTS, STS2, STH2 | 1000 | 10000 |
| <b>PLT1.5S-M30</b> | 6.2  | 157 | .190 | 4.8 | .052 | 1.3 | 1.50 | 38  | 50 | 222 |  | 1000 | 10000 |
| <b>PLT2S-C30</b>   | 7.4  | 188 | .190 | 4.8 | .052 | 1.3 | 1.88 | 48  | 50 | 222 |  | 100  | 1000  |
| <b>PLT2S-M39*</b>  | 7.4  | 188 | .190 | 4.8 | .052 | 1.3 | 1.88 | 48  | 50 | 222 |  | 1000 | 10000 |
| <b>PLT2.5S-M30</b> | 9.8  | 249 | .190 | 4.8 | .052 | 1.3 | 2.50 | 64  | 50 | 222 |  | 1000 | 10000 |
| <b>PLT3S-C30</b>   | 11.5 | 292 | .190 | 4.8 | .052 | 1.3 | 3.00 | 76  | 50 | 222 |  | 100  | 1000  |
| <b>PLT4S-C30</b>   | 14.5 | 368 | .190 | 4.8 | .052 | 1.3 | 4.00 | 102 | 50 | 222 |  | 100  | 1000  |
| <b>PLT5S-M30</b>   | 17.5 | 445 | .190 | 4.8 | .052 | 1.3 | 5.00 | 127 | 50 | 222 |  | 1000 | 5000  |

**Light-Heavy Cross Section (Straight Tip)**

|                   |      |     |      |     |      |     |      |     |     |     |                                    |     |      |
|-------------------|------|-----|------|-----|------|-----|------|-----|-----|-----|------------------------------------|-----|------|
| <b>PLT2H-TL30</b> | 8.1  | 206 | .300 | 7.6 | .075 | 1.9 | 2.00 | 51  | 120 | 534 | GTH, GS4H, GS4EH, PTH, STH2, ST3EH | 250 | 2500 |
| <b>PLT3H-TL30</b> | 11.4 | 290 | .300 | 7.6 | .075 | 1.9 | 3.00 | 76  | 120 | 534 |                                    | 250 | 2500 |
| <b>PLT4H-TL30</b> | 14.5 | 368 | .300 | 7.6 | .075 | 1.9 | 4.00 | 102 | 120 | 534 |                                    | 250 | 2500 |
| <b>PLT7LH-C30</b> | 24.7 | 627 | .300 | 7.6 | .075 | 1.9 | 7.00 | 178 | 120 | 534 |                                    | 100 | 2000 |
| <b>PLT9LH-C30</b> | 30.5 | 775 | .300 | 7.6 | .075 | 1.9 | 9.00 | 229 | 120 | 534 |                                    | 100 | 1000 |

**Heavy Cross Section (Straight Tip)**

|                  |      |     |      |     |      |     |      |     |     |     |                                    |     |      |
|------------------|------|-----|------|-----|------|-----|------|-----|-----|-----|------------------------------------|-----|------|
| <b>PLT5H-C30</b> | 17.7 | 450 | .350 | 8.9 | .078 | 2.0 | 5.00 | 127 | 175 | 778 | GTH, GS4H, GS4EH, PTH, STH2, ST3EH | 100 | 2000 |
| <b>PLT6H-C30</b> | 20.9 | 530 | .350 | 8.9 | .078 | 2.0 | 6.00 | 152 | 175 | 778 |                                    | 100 | 2000 |
| <b>PLT8H-C30</b> | 30.6 | 779 | .350 | 8.9 | .078 | 2.0 | 9.00 | 229 | 175 | 778 |                                    | 100 | 1500 |

\*Natural heat stabilized material (39).  
Note: UL Listed except PLT.6SM and PLT5H/6H/8H.

E5. Lockout/Tagout & Safety Solutions

F. Index





## Pan-Ty® Cable Ties – Heat Stabilized Weather Resistant Nylon 6.6

- Greater resistance to damage caused by ultraviolet light and for high temperature applications up to 212°F (100°C) – indoor or outdoor use
- One-piece construction for consistent performance and reliability

- Lowest threading force of any one-piece cable tie in the industry
- Curved tip is easy to pick up from flat surfaces and allows faster initial threading to speed installation

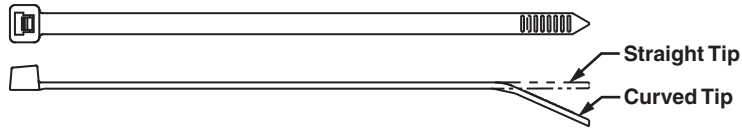

| Part Number                                     | Length |     | Width |     | Thickness |     | Max. Bundle Dia. |     | Min. Loop Tensile Str. |     | Recommended Installation Tool                          | Std. Pkg. Qty. | Std. Ctn. Qty. |
|---|--------|-----|-------|-----|-----------|-----|------------------|-----|------------------------|-----|--|----------------|----------------|
|   | In.    | mm  | In.   | mm  | In.       | mm  | In.              | mm  | Lbs.                   | N   |  |                |                |
| <b>Miniature Cross Section</b>                  |        |     |       |     |           |     |                  |     |                        |     |  |                |                |
| <b>PLT1M-M300</b>                               | 3.9    | 99  | .098  | 2.5 | .035      | .9  | .87              | 22  | 18                     | 80  | GTS, GTSL, GS2B, PTS, PPTS, STS2                       | 1000           | 50000          |
| <b>Intermediate Cross Section</b>               |        |     |       |     |           |     |                  |     |                        |     |  |                |                |
| <b>PLT1.5I-M300</b>                             | 5.6    | 142 | .142  | 3.6 | .045      | 1.1 | 1.38             | 35  | 40                     | 178 | GTS, GTSL, GS2B, PTS, PPTS, STS2                       | 1000           | 25000          |
| <b>PLT2I-M300</b>                               | 8.0    | 203 | .142  | 3.6 | .045      | 1.1 | 2.00             | 51  | 40                     | 178 |  | 1000           | 25000          |
| <b>Standard Cross Section</b>                   |        |     |       |     |           |     |                  |     |                        |     |  |                |                |
| <b>PLT1S-M300</b>                               | 4.8    | 122 | .190  | 4.8 | .052      | 1.3 | 1.00             | 25  | 50                     | 222 | GTS, GTSL, GS2B, GTH, GS4H, PTS, PTH, PPTS, STS2, STH2 | 1000           | 10000          |
| <b>PLT2S-M300</b>                               | 7.4    | 188 | .190  | 4.8 | .052      | 1.3 | 1.88             | 48  | 50                     | 222 |  | 1000           | 10000          |
| <b>PLT4S-M300</b>                               | 14.5   | 368 | .190  | 4.8 | .052      | 1.3 | 4.00             | 102 | 50                     | 222 |  | 1000           | 5000           |
| <b>Light-Heavy Cross Section (Straight Tip)</b> |        |     |       |     |           |     |                  |     |                        |     |  |                |                |
| <b>PLT2H-TL300</b>                              | 8.4    | 213 | .300  | 7.6 | .075      | 1.9 | 2.00             | 51  | 120                    | 534 | GTH, GS4H, GS4EH, PTH, STH2, ST3EH                     | 250            | 2500           |
| <b>PLT4H-TL300</b>                              | 14.5   | 368 | .300  | 7.6 | .075      | 1.9 | 4.00             | 102 | 120                    | 534 |  | 250            | 2500           |

A. System Overview

B1. Cable Ties

B2. Cable Accessories

B3. Stainless Steel Ties

C1. Wiring Duct

C2. Surface Raceway

C3. Abrasion Protection

C4. Cable Management

D1. Terminals

D2. Power Connectors

D3. Grounding Connectors

E1. Labeling Systems

E2. Labels

E3. Pre-Printed & Write-On Markers

E4. Permanent Identification

E5. Lockout/Tagout & Safety Solutions

F. Index

A. System Overview

## UL US c SP US Pan-Ty® Cable Ties – Flame Retardant Nylon 6.6

- Flammability rating of UL 94V-0 – indoor use
- One-piece construction for consistent performance and reliability
- Lowest threading force of any one-piece cable tie in the industry
- Curved tip is easy to pick up from flat surfaces and allows faster initial threading to speed installation

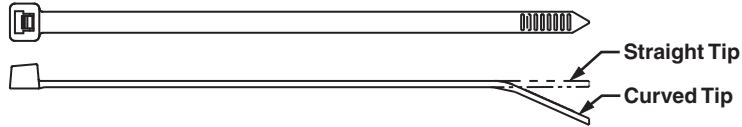

B1. Cable Ties

B2. Cable Accessories

B3. Stainless Steel Ties

C1. Wiring Duct

| Part Number | Length |    | Width |    | Thickness |    | Max. Bundle Dia. |    | Min. Loop Tensile Str. |   | Recommended Installation Tool | Std. Pkg. Qty. | Std. Ctn. Qty. |
|-------------|--------|----|-------|----|-----------|----|------------------|----|------------------------|---|-------------------------------|----------------|----------------|
|             | In.    | mm | In.   | mm | In.       | mm | In.              | mm | Lbs.                   | N |                               |                |                |

### Miniature Cross Section

|                   |     |     |      |     |      |     |      |    |    |    |                                  |      |       |
|-------------------|-----|-----|------|-----|------|-----|------|----|----|----|----------------------------------|------|-------|
| <b>PLT1M-M60*</b> | 4.0 | 102 | .098 | 2.5 | .043 | 1.1 | .87  | 22 | 18 | 80 | GTS, GTSL, GS2B, PTS, PPTS, STS2 | 1000 | 25000 |
| <b>PLT1M-M69</b>  | 4.0 | 102 | .098 | 2.5 | .043 | 1.1 | .87  | 22 | 18 | 80 |                                  | 1000 | 25000 |
| <b>PLT2M-M69</b>  | 8.0 | 203 | .098 | 2.5 | .043 | 1.1 | 2.00 | 51 | 18 | 80 |                                  | 1000 | 25000 |

### Intermediate Cross Section

|                    |     |     |      |     |      |     |      |    |    |     |                                  |      |       |
|--------------------|-----|-----|------|-----|------|-----|------|----|----|-----|----------------------------------|------|-------|
| <b>PLT1.5I-M69</b> | 5.6 | 142 | .142 | 3.6 | .044 | 1.1 | 1.38 | 35 | 40 | 178 | GTS, GTSL, GS2B, PTS, PPTS, STS2 | 1000 | 25000 |
| <b>PLT2I-M69</b>   | 8.0 | 203 | .142 | 3.6 | .044 | 1.1 | 2.00 | 51 | 40 | 178 |                                  | 1000 | 25000 |

### Standard Cross Section

|                   |      |     |      |     |      |     |      |     |    |     |  |      |       |
|-------------------|------|-----|------|-----|------|-----|------|-----|----|-----|--|------|-------|
| <b>PLT2S-M60*</b> | 7.4  | 188 | .190 | 4.8 | .052 | 1.3 | 1.88 | 48  | 50 | 222 | GTS, GTSL, GS2B, GTH, GS4H, PTS, PTH, PPTS, STS2, STH2 | 1000 | 10000 |
| <b>PLT2S-M69</b>  | 7.4  | 188 | .190 | 4.8 | .052 | 1.3 | 1.88 | 48  | 50 | 222 |  | 1000 | 10000 |
| <b>PLT4S-M69</b>  | 14.5 | 368 | .190 | 4.8 | .052 | 1.3 | 4.00 | 102 | 50 | 222 |  | 1000 | 5000  |

### Light-Heavy Cross Section (Straight Tip)

|                   |      |     |      |     |      |     |      |     |     |     |                                    |     |      |
|-------------------|------|-----|------|-----|------|-----|------|-----|-----|-----|------------------------------------|-----|------|
| <b>PLT4H-TL69</b> | 14.6 | 371 | .300 | 7.6 | .075 | 1.9 | 4.00 | 102 | 120 | 534 | GTH, GS4H, GS4EH, PTH, STH2, ST3EH | 250 | 2500 |
|-------------------|------|-----|------|-----|------|-----|------|-----|-----|-----|------------------------------------|-----|------|

\*Black flame retardant material (60).  
Note: UL Recognized and CSA Certified except 60 material.

D1. Terminals

D2. Power Connectors

D3. Grounding Connectors

## Cable Tie Mounts – Flame Retardant Nylon 6.6

- Flammability rating of UL 94V-0 – indoor use
- Unique cradle design provides maximum stability for the cable bundle
- Low profile design keeps bundle close to mounting surface

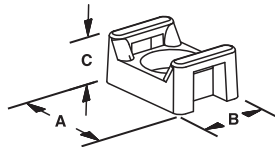

E1. Labeling Systems

E2. Labels

E3. Pre-Printed & Write-On Markers

| Part Number       | Used with Cable Ties* | Length A |      | Width B |      | Height C |     | Counterbore Diameter |     | Mounting Method | Std. Pkg. Qty. | Std. Ctn. Qty. |
|-------------------|-----------------------|----------|------|---------|------|----------|-----|----------------------|-----|-----------------|----------------|----------------|
|                   |                       | In.      | mm   | In.     | mm   | In.      | mm  | In.                  | mm  |                 |                |                |
| <b>TM1S4-M69</b>  | M                     | 0.51     | 13.0 | 0.32    | 8.0  | 0.23     | 5.8 | 0.23                 | 5.7 | #4 (M2.5) Screw | 1000           | 5000           |
| <b>TM1S6-M69</b>  |                       | 0.51     | 13.0 | 0.32    | 8.0  | 0.23     | 5.8 | 0.28                 | 7.0 | #6 (M3) Screw   | 1000           | 5000           |
| <b>TM2S6-M69</b>  | M, I, S               | 0.63     | 16.0 | 0.43    | 10.8 | 0.28     | 7.0 | 0.29                 | 7.1 | #6 (M3) Screw   | 1000           | 5000           |
| <b>TM2S8-M69</b>  |                       | 0.63     | 16.0 | 0.43    | 10.8 | 0.28     | 7.0 | 0.33                 | 8.4 | #8 (M4) Screw   | 1000           | 5000           |
| <b>TM3S8-C69</b>  | M, I, S, LH           | 0.86     | 21.9 | 0.61    | 15.5 | 0.37     | 9.4 | 0.32                 | 8.1 | #8 (M4) Screw   | 100            | 500            |
| <b>TM3S10-M69</b> |                       | 0.86     | 21.9 | 0.61    | 15.8 | 0.37     | 9.4 | 0.38                 | 9.7 | #10 (M5) Screw  | 1000           | 5000           |

\*Cable tie cross section sizes: M = Miniature, I = Intermediate, S = Standard and LH = Light-Heavy.

F. Index

## Pan-Ty® Cable Ties – Weather Resistant Nylon 12

- For high moisture, corrosive (zinc chloride and dilute acids), and low temperature indoor or outdoor applications
- Cable tie of choice for making attachments to galvanized surfaces
- One-piece construction for consistent performance and reliability
- Lowest threading force of any one-piece cable tie in the industry
- Curved tip is easy to pick up from flat surfaces and allows faster initial threading to speed installation

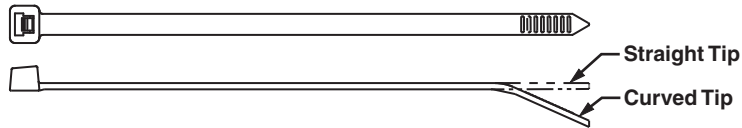

| Part Number                                     | Length |     | Width |     | Thickness |     | Max. Bundle Dia. |     | Min. Loop Tensile Str. |     | Recommended Installation Tool                          | Std. Pkg. Qty. | Std. Ctn. Qty. |
|---|--------|-----|-------|-----|-----------|-----|------------------|-----|------------------------|-----|--|----------------|----------------|
|   | In.    | mm  | In.   | mm  | In.       | mm  | In.              | mm  | Lbs.                   | N   |  |                |                |
| <b>Intermediate Cross Section</b>               |        |     |       |     |           |     |                  |     |                        |     |  |                |                |
| <b>PLT1.5I-M120</b>                             | 5.6    | 142 | .142  | 3.6 | .045      | 1.1 | 1.38             | 35  | 25                     | 111 | GTS, GTSL, GS2B, PTS, PPTS, STS2                       | 1000           | 25000          |
| <b>Standard Cross Section</b>                   |        |     |       |     |           |     |                  |     |                        |     |  |                |                |
| <b>PLT2S-M120</b>                               | 7.4    | 188 | .190  | 4.8 | .052      | 1.3 | 1.88             | 48  | 40                     | 178 | GTS, GTSL, GS2B, GTH, GS4H, PTS, PTH, PPTS, STS2, STH2 | 1000           | 10000          |
| <b>PLT4S-M120</b>                               | 14.5   | 368 | .190  | 4.8 | .052      | 1.3 | 4.00             | 102 | 40                     | 178 |  | 1000           | 5000           |
| <b>Light-Heavy Cross Section (Straight Tip)</b> |        |     |       |     |           |     |                  |     |                        |     |  |                |                |
| <b>PLT4H-TL120</b>                              | 14.5   | 368 | .300  | 7.6 | .075      | 1.9 | 4.00             | 102 | 90                     | 400 | GTH, GTSL, GS4H, GS4EH, PTH, STH2, ST3EH               | 250            | 2500           |
| <b>PLT8LH-C120</b>                              | 27.6   | 701 | .300  | 7.6 | .075      | 1.9 | 8.00             | 203 | 90                     | 400 |  | 100            | 2000           |

A.  
System  
Overview

B1.  
Cable Ties

B2.  
Cable  
Accessories

B3.  
Stainless  
Steel Ties

C1.  
Wiring  
Duct

C2.  
Surface  
Raceway

C3.  
Abrasion  
Protection

C4.  
Cable  
Management

D1.  
Terminals

D2.  
Power  
Connectors

D3.  
Grounding  
Connectors

E1.  
Labeling  
Systems

E2.  
Labels

E3.  
Pre-Printed  
& Write-On  
Markers

E4.  
Permanent  
Identification

E5.  
Lockout/  
Tagout  
& Safety  
Solutions

F.  
Index

A.  
System  
Overview

## Pan-Ty® Cable Ties – Polypropylene – Distinctive Green Color

B1.  
Cable Ties

- For chemical resistance where high loop tensile strength is not required especially in the presence of hydrochloric acid, salts, and bases
- For indoor use
- Material requires lowering the tool setting (see table below)

- One-piece construction for consistent performance and reliability
- Lowest threading force of any one-piece cable tie in the industry
- Curved tip is easy to pick up from flat surfaces and allows faster initial threading to speed installation

B2.  
Cable  
Accessories



B3.  
Stainless  
Steel Ties

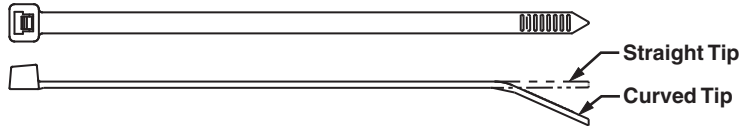

C1.  
Wiring  
Duct

C2.  
Surface  
Raceway

| Part Number                                     | Length |     | Width |     | Thickness |     | Max. Bundle Dia. |     | Min. Loop Tensile Str. |     | Recommended Installation Tool                          | Tool Setting                              | Std. Pkg. Qty. | Std. Ctn. Qty. |
|---|--------|-----|-------|-----|-----------|-----|------------------|-----|------------------------|-----|--|---|----------------|----------------|
|   | In.    | mm  | In.   | mm  | In.       | mm  | In.              | mm  | Lbs.                   | N   |  |   |                |                |
| <b>Miniature Cross Section</b>                  |        |     |       |     |           |     |                  |     |                        |     |  |   |                |                |
| <b>PLT1M-M109</b>                               | 3.9    | 99  | .098  | 2.5 | .043      | 1.1 | .87              | 22  | 11                     | 49  | GTS, GTSL, GS2B, PTS, PPTS, STS2                       | 2   | 1000           | 50000          |
| <b>Intermediate Cross Section</b>               |        |     |       |     |           |     |                  |     |                        |     |  |   |                |                |
| <b>PLT1.5I-M109</b>                             | 5.6    | 142 | .142  | 3.6 | .045      | 1.1 | 1.38             | 35  | 18                     | 80  | GTS, GTSL, GS2B, PTS, PPTS, STS2                       | 3   | 1000           | 25000          |
| <b>Standard Cross Section</b>                   |        |     |       |     |           |     |                  |     |                        |     |  |   |                |                |
| <b>PLT2S-M109</b>                               | 7.4    | 188 | .190  | 4.8 | .052      | 1.3 | 1.88             | 48  | 30                     | 133 | GTS, GTSL, GS2B, GTH, GS4H, PTS, PTH, PPTS, STS2, STH2 | 5 (GTS, GS2B, PTS, PPTS)<br>2 (GTH, GS4H) | 1000           | 10000          |
| <b>PLT3S-M109</b>                               | 11.5   | 292 | .190  | 4.8 | .052      | 1.3 | 3.00             | 76  | 30                     | 133 |  |   | 1000           | 10000          |
| <b>PLT4S-M109</b>                               | 14.5   | 368 | .190  | 4.8 | .052      | 1.3 | 4.00             | 102 | 30                     | 133 |  |   | 1000           | 5000           |
| <b>Light-Heavy Cross Section (Straight Tip)</b> |        |     |       |     |           |     |                  |     |                        |     |  |   |                |                |
| <b>PLT2H-TL109</b>                              | 8.1    | 206 | .300  | 7.6 | .075      | 1.9 | 2.00             | 51  | 50                     | 222 | GTH, GS4H, GS4EH, PTH, STH2, ST3EH                     | 5   | 250            | 2500           |
| <b>PLT3H-TL109</b>                              | 11.4   | 290 | .300  | 7.6 | .075      | 1.9 | 3.00             | 76  | 50                     | 222 |  | 5   | 250            | 2500           |
| <b>PLT4H-TL109</b>                              | 14.5   | 368 | .300  | 7.6 | .075      | 1.9 | 4.00             | 102 | 50                     | 222 |  | 5   | 250            | 2500           |

D2.  
Power  
Connectors

D3.  
Grounding  
Connectors

E1.  
Labeling  
Systems

E2.  
Labels

E3.  
Pre-Printed  
& Write-On  
Markers

E4.  
Permanent  
Identification

E5.  
Lockout/  
Tagout  
& Safety  
Solutions

F.  
Index



## Pan-Ty® Cable Ties – Weather Resistant Polypropylene

- For chemical resistance where high loop tensile strength is not required especially in the presence of hydrochloric acid, salts, and bases
- Greater resistance to damage caused by ultraviolet light – indoor or outdoor use
- Material requires lowering the tool setting (see table below)
- One-piece construction for consistent performance and reliability
- Lowest threading force of any one-piece cable tie in the industry
- Curved tip is easy to pick up from flat surfaces and allows faster initial threading to speed installation

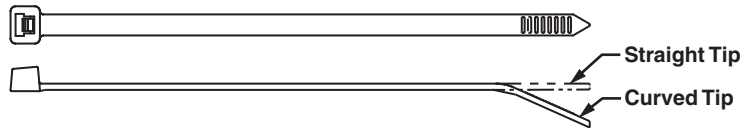

| Part Number                                     | Length |     | Width |     | Thickness |     | Max. Bundle Dia. |     | Min. Loop Tensile Str. |     | Recommended Installation Tool                     | Tool Setting                              | Std. Pkg. Qty. | Std. Ctn. Qty. |
|---|--------|-----|-------|-----|-----------|-----|------------------|-----|------------------------|-----|---|---|----------------|----------------|
|   | In.    | mm  | In.   | mm  | In.       | mm  | In.              | mm  | Lbs.                   | N   |   |   |                |                |
| <b>Miniature Cross Section</b>                  |        |     |       |     |           |     |                  |     |                        |     |   |   |                |                |
| <b>PLT1M-M100</b>                               | 3.9    | 99  | .098  | 2.5 | .043      | 1.1 | .87              | 22  | 11                     | 49  | GTS, GTSL, GS2B, PTS, PPTS, STS2                  | 2   | 1000           | 50000          |
| <b>Intermediate Cross Section</b>               |        |     |       |     |           |     |                  |     |                        |     |   |   |                |                |
| <b>PLT1.5I-M100</b>                             | 5.6    | 142 | .142  | 3.6 | .045      | 1.1 | 1.38             | 35  | 18                     | 80  | GTS, GTSL, GS2B, PTS, PPTS, STS2                  | 3   | 1000           | 25000          |
| <b>Standard Cross Section</b>                   |        |     |       |     |           |     |                  |     |                        |     |   |   |                |                |
| <b>PLT2S-M100</b>                               | 7.4    | 188 | .190  | 4.8 | .052      | 1.3 | 1.88             | 48  | 30                     | 133 | GTS, GTSL, GS2B, GTH, GS4H, PTS, PPTS, STS2, STH2 | 5 (GTS, GS2B, PTS, PPTS)<br>2 (GTH, GS4H) | 1000           | 10000          |
| <b>PLT3S-M100</b>                               | 11.5   | 292 | .190  | 4.8 | .052      | 1.3 | 3.00             | 76  | 30                     | 133 |   |   | 1000           | 10000          |
| <b>PLT4S-M100</b>                               | 14.5   | 368 | .190  | 4.8 | .052      | 1.3 | 4.00             | 102 | 30                     | 133 |   |   | 1000           | 5000           |
| <b>Light-Heavy Cross Section (Straight Tip)</b> |        |     |       |     |           |     |                  |     |                        |     |   |   |                |                |
| <b>PLT2H-TL100</b>                              | 8.1    | 206 | .300  | 7.6 | .075      | 1.9 | 2.00             | 51  | 50                     | 222 | GTH, GS4H, GS4EH, PTH, STH2, ST3EH                | 5   | 250            | 2500           |
| <b>PLT3H-TL100</b>                              | 11.4   | 290 | .300  | 7.6 | .075      | 1.9 | 3.00             | 76  | 50                     | 222 |   | 5   | 250            | 2500           |
| <b>PLT4H-TL100</b>                              | 14.5   | 368 | .300  | 7.6 | .075      | 1.9 | 4.00             | 102 | 50                     | 222 |   | 5   | 250            | 2500           |

A. System Overview

B1. Cable Ties

B2. Cable Accessories

B3. Stainless Steel Ties

C1. Wiring Duct

C2. Surface Raceway

C3. Abrasion Protection

C4. Cable Management

D1. Terminals

D2. Power Connectors

D3. Grounding Connectors

E1. Labeling Systems

E2. Labels

E3. Pre-Printed & Write-On Markers

E4. Permanent Identification

E5. Lockout/Tagout & Safety Solutions

F. Index

A. System Overview

**UL US** **UL LISTED** **SP US** **Pan-Ty® Cable Ties – HALAR® – Distinctive Maroon Color**

B1. Cable Ties

- UL Listed for use in plenum or air handling spaces per NEC, Section 300-22 (C) and (D)
- Low smoke density and excellent flammability rating of UL 94V-0
- Commonly accepted solution for bundling qualified cable without conduit in air handling space applications
- Greater resistance to damage caused by ultraviolet light – indoor or outdoor use
- One-piece construction for consistent performance and reliability
- Lowest threading force of any one-piece cable tie in the industry
- Curved tip is easy to pick up from flat surfaces and allows faster initial threading to speed installation

B2. Cable Accessories

B3. Stainless Steel Ties

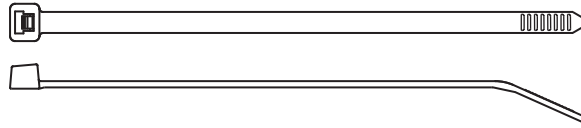
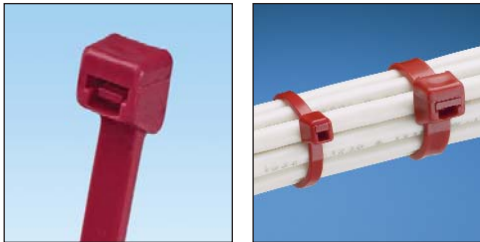

C1. Wiring Duct

C2. Surface Raceway

| Part Number                                   | Length |     | Width |     | Thickness |     | Max. Bundle Dia. |    | Min. Loop Tensile Str. |     | Recommended Installation Tool                          | Std. Pkg. Qty. | Std. Ctn. Qty. |
|---|--------|-----|-------|-----|-----------|-----|------------------|----|------------------------|-----|--|----------------|----------------|
|   | In.    | mm  | In.   | mm  | In.       | mm  | In.              | mm | Lbs.                   | N   |  |                |                |
| <b>Miniature Cross Section – Plenum-Rated</b> |        |     |       |     |           |     |                  |    |                        |     |  |                |                |
| <b>PLT1M-C702Y</b>                            | 4.0    | 102 | .098  | 2.5 | .043      | 1.1 | .87              | 22 | 18                     | 80  | GTS, GTSL, GS2B, PTS, PPTS, STS2                       | 100            | 1000           |
| <b>Standard Cross Section – Plenum-Rated</b>  |        |     |       |     |           |     |                  |    |                        |     |  |                |                |
| <b>PLT2S-C702Y</b>                            | 7.4    | 188 | .190  | 4.8 | .055      | 1.4 | 1.88             | 48 | 50                     | 222 | GTS, GTSL, GS2B, GTH, GS4H, PTS, PTH, PPTS, STS2, STH2 | 100            | 1000           |
| <b>PLT3S-C702Y</b>                            | 11.6   | 295 | .190  | 4.8 | .055      | 1.4 | 3.00             | 76 | 50                     | 222 |  | 100            | 1000           |

\*HALAR is a registered trademark of Ausimont USA, Inc.

D1. Terminals

D2. Power Connectors

D3. Grounding Connectors

E1. Labeling Systems

E2. Labels

E3. Pre-Printed & Write-On Markers

E4. Permanent Identification

E5. Lockout/Tagout & Safety Solutions

F. Index



## Pan-Ty® Cable Ties – TEFZEL® – Distinctive Aqua Blue Color

- Ideal for applications requiring resistance to environmental stresses such as chemical attack, gamma radiation, ultraviolet radiation and extreme high and low temperatures
- Ideal for use in nuclear power facilities and chemical processing plants and meets the requirements of IEEE 383
- Low smoke density and excellent flammability rating of UL 94V-0

- One-piece construction for consistent performance and reliability
- Lowest threading force of any one-piece cable tie in the industry
- Curved tip is easy to pick up from flat surfaces and allows faster initial threading to speed installation
- For indoor or outdoor use

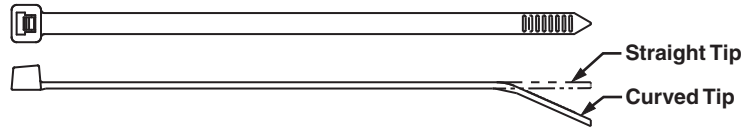
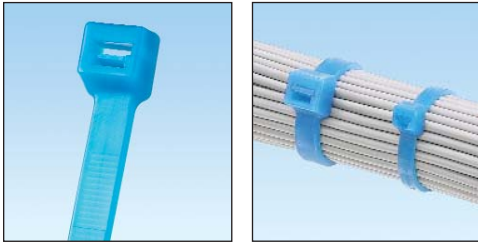

| Part Number                                     | Length |     | Width |     | Thickness |     | Max. Bundle Dia. |     | Min. Loop Tensile Str. |     | Recommended Installation Tool                          | Std. Pkg. Qty. | Std. Ctn. Qty. |
|---|--------|-----|-------|-----|-----------|-----|------------------|-----|------------------------|-----|--|----------------|----------------|
|   | In.    | mm  | In.   | mm  | In.       | mm  | In.              | mm  | Lbs.                   | N   |  |                |                |
| <b>Miniature Cross Section</b>                  |        |     |       |     |           |     |                  |     |                        |     |  |                |                |
| <b>PLT1M-C76</b>                                | 4.0    | 102 | .098  | 2.5 | .043      | 1.1 | .87              | 22  | 18                     | 80  | GTS, GTSL, GS2B, PTS, PPTS, STS2                       | 100            | 1000           |
| <b>Intermediate Cross Section</b>               |        |     |       |     |           |     |                  |     |                        |     |  |                |                |
| <b>PLT2I-C76</b>                                | 8.0    | 203 | .135  | 3.4 | .045      | 1.1 | 2.00             | 51  | 25                     | 111 | GTS, GTSL, GS2B, PTS, PPTS, STS2                       | 100            | 1000           |
| <b>Standard Cross Section</b>                   |        |     |       |     |           |     |                  |     |                        |     |  |                |                |
| <b>PLT2S-C76</b>                                | 7.4    | 188 | .190  | 4.8 | .055      | 1.4 | 1.88             | 48  | 50                     | 222 | GTS, GTSL, GS2B, GTH, GS4H, PTS, PTH, PPTS, STS2, STH2 | 100            | 1000           |
| <b>PLT3S-C76</b>                                | 11.6   | 295 | .190  | 4.8 | .059      | 1.5 | 3.00             | 76  | 50                     | 222 |  | 100            | 1000           |
| <b>PLT4S-C76</b>                                | 14.6   | 371 | .190  | 4.8 | .059      | 1.5 | 4.00             | 102 | 50                     | 222 |  | 100            | 1000           |
| <b>Light-Heavy Cross Section (Straight Tip)</b> |        |     |       |     |           |     |                  |     |                        |     |  |                |                |
| <b>PLT3H-L76</b>                                | 11.5   | 292 | .300  | 7.6 | .075      | 1.9 | 3.00             | 78  | 120                    | 534 | GTH, GS4H, GS4EH, PTH, STH2, ST3EH                     | 50             | 500            |
| <b>PLT4H-L76</b>                                | 14.6   | 371 | .300  | 7.6 | .075      | 1.9 | 4.00             | 102 | 120                    | 534 |  | 50             | 500            |

\*TEFZEL is a registered trademark of E. I. du Pont de Nemours and Company.

## Panduit® Cable Tie Mounts – TEFZEL®

- Flammability rating of UL 94V-0 – indoor use
- Unique cradle design provides maximum stability for the cable bundle

- Low profile design keeps bundle close to mounting surface

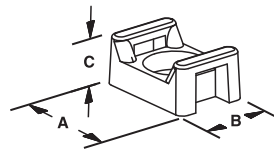

| Part Number       | Used with Cable Ties* | Length A |      | Width B |      | Height C |     | Counterbore Diameter |     | Mounting Method | Std. Pkg. Qty. | Std. Ctn. Qty. |
|-------------------|-----------------------|----------|------|---------|------|----------|-----|----------------------|-----|-----------------|----------------|----------------|
|                   |                       | In.      | mm   | In.     | mm   | In.      | mm  | In.                  | mm  |                 |                |                |
| <b>TM2S8-C76</b>  | M, I, S               | .63      | 16.0 | .43     | 10.8 | .28      | 7.0 | .30                  | 7.6 | #8 (M4) screw   | 100            | 500            |
| <b>TM3S8-C76</b>  | S, LH                 | .86      | 21.7 | .62     | 15.5 | .38      | 9.5 | .37                  | 9.4 | #8 (M4) screw   | 100            | 500            |
| <b>TM3S10-C76</b> |                       | .86      | 21.7 | .62     | 15.8 | .38      | 9.5 | .37                  | 9.4 | #10 (M5) screw  | 100            | 500            |

\*Cable tie cross section sizes: M = Miniature, I = Intermediate, S = Standard, LH = Light-Heavy.

\*TEFZEL is a registered trademark of E. I. du Pont de Nemours and Company.

A. System Overview

## Pan-Ty® Cable Ties – PEEK (Polyetheretherketone)

B1. Cable Ties

- Ideal for harsh environments where a cable tie material is required to hold up to chemical or radiation exposure
- Non-conductive material that is excellent for high temperature applications up to 500°F (260°C)
- High strength properties over a wide range of temperatures
- Flammability rating of UL 94V-0 with low smoke and toxicity; halogen-free
- PEEK material meets MIL specification MIL-P-46183, and is approved for use by the Department of Defense
- One-piece construction for consistent performance and reliability
- Lowest threading force of any one-piece cable tie in the industry

B2. Cable Accessories

B3. Stainless Steel Ties

C1. Wiring Duct

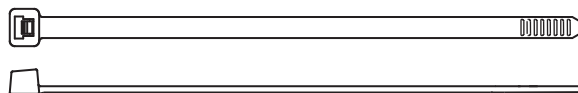
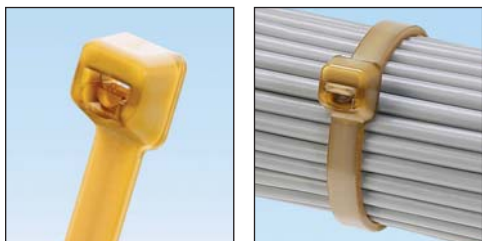

C2. Surface Raceway

| Part Number                    | Length |     | Width |     | Thickness |     | Max. Bundle Dia. |    | Min. Loop Tensile Str. |     | Recommended Installation Tool                          | Std. Pkg. Qty. | Std. Ctn. Qty. |
|--------------------------------|--------|-----|-------|-----|-----------|-----|------------------|----|------------------------|-----|--|----------------|----------------|
|                                | In.    | mm  | In.   | mm  | In.       | mm  | In.              | mm | Lbs.                   | N   |  |                |                |
| <b>Miniature Cross Section</b> |        |     |       |     |           |     |                  |    |                        |     |  |                |                |
| PLT1M-C71                      | 3.9    | 99  | 0.098 | 2.5 | 0.048     | 1.2 | 0.87             | 22 | 35                     | 156 | GTS, GTSL, PTS   | 100            | 1000           |
| PLT1.5M-C71                    | 5.8    | 147 | 0.098 | 2.5 | 0.048     | 1.2 | 1.38             | 35 | 35                     | 156 | GTS, GTSL, PTS   | 100            | 1000           |
| <b>Standard Cross Section</b>  |        |     |       |     |           |     |                  |    |                        |     |  |                |                |
| PLT2S-C71                      | 7.4    | 188 | 0.190 | 4.8 | 0.055     | 1.4 | 1.88             | 48 | 150                    | 668 | GTS, GTSL, GS2B, GTH, GS4H, PTS, PTH, PPTS, STS2, STH2 | 100            | 1000           |

C3. Abrasion Protection

C4. Cable Management

D1. Terminals

D2. Power Connectors

D3. Grounding Connectors

## Cable Tie Mounts – (Polyetheretherketone)

- Unique cradle design provides maximum stability for cable bundle
- Low profile design keeps bundle close to mounting surface where overhead space is limited

E1. Labeling Systems

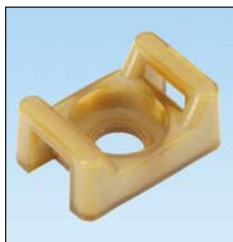

E2. Labels

E3. Pre-Printed & Write-On Markers

E4. Permanent Identification

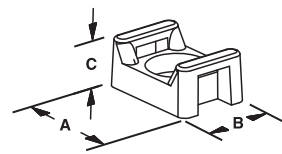

E5. Lockout/Tagout & Safety Solutions

F. Index

| Part Number | Used with Cable Ties | A Length In. (mm) | B Width In. (mm) | C Height In. (mm) | Counterbore Diameter In. (mm) | Mounting Method | Std. Pkg. Qty. | Std. Ctn. Qty. |
|-------------|----------------------|-------------------|------------------|-------------------|-------------------------------|-----------------|----------------|----------------|
| TM2S8-C71   | Min., Std.           | .636 (16.2)       | .427 (10.8)      | .278 (7.1)        | .335 (8.5)                    | #8 (M4) screw   | 100            | 500            |



## Pan-Ty® Cable Ties – Metal Detectable Nylon 6.6 and Polypropylene

- Metal impregnated material allows identification by metal detectors or x-ray inspection equipment to help meet food, beverage, and pharmaceutical safety standards, to help reduce product contamination, loss, and recall
- Nylon material for general purpose maintenance and repair applications; ideal for use in control panels and overhead cable runs
- Polypropylene material provides excellent chemical resistance for use in processing and packaging areas where aggressive acid and alkaline chemicals are used to clean the equipment
- One-piece construction for consistent performance and reliability
- Lowest threading force of any one-piece cable tie in the industry
- Curved tip is easy to pick up from flat surfaces and allows faster initial threading to speed installation

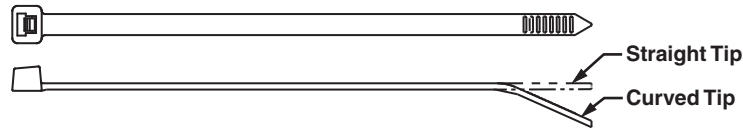

| Part Number | Length |    | Width |    | Thickness |    | Max. Bundle Dia. |    | Min. Loop Tensile Str. |   | Recommended Installation Tool | Material | Std. Pkg. Qty. | Std. Ctn. Qty. |
|-------------|--------|----|-------|----|-----------|----|------------------|----|------------------------|---|-------------------------------|----------|----------------|----------------|
|             | In.    | mm | In.   | mm | In.       | mm | In.              | mm | Lbs.                   | N |                               |          |                |                |

### Nylon 6.6

#### Miniature Cross Section

|           |     |     |      |     |      |     |     |    |    |    |                       |           |     |      |
|-----------|-----|-----|------|-----|------|-----|-----|----|----|----|-----------------------|-----------|-----|------|
| PLT1M-C86 | 3.9 | 100 | .098 | 2.5 | .044 | 1.1 | .87 | 22 | 18 | 80 | GTS, GTSL, GS2B, STS2 | Nylon 6.6 | 100 | 1000 |
|-----------|-----|-----|------|-----|------|-----|-----|----|----|----|-----------------------|-----------|-----|------|

#### Intermediate Cross Section

|           |     |     |      |     |      |     |      |    |    |     |                       |           |     |      |
|-----------|-----|-----|------|-----|------|-----|------|----|----|-----|-----------------------|-----------|-----|------|
| PLT2I-C86 | 8.0 | 203 | .135 | 3.4 | .047 | 1.2 | 2.00 | 51 | 40 | 178 | GTS, GTSL, GS2B, STS2 | Nylon 6.6 | 100 | 1000 |
|-----------|-----|-----|------|-----|------|-----|------|----|----|-----|-----------------------|-----------|-----|------|

#### Standard Cross Section

|           |      |     |      |     |      |     |      |     |    |     |  |           |     |      |
|-----------|------|-----|------|-----|------|-----|------|-----|----|-----|--|-----------|-----|------|
| PLT2S-C86 | 7.3  | 186 | .190 | 4.8 | .057 | 1.4 | 1.85 | 47  | 50 | 222 | GTS, GTSL, GS2B, GTH, GS4H, STS2, STH2 | Nylon 6.6 | 100 | 1000 |
| PLT3S-C86 | 11.5 | 291 | .190 | 4.8 | .057 | 1.4 | 3.00 | 76  | 50 | 222 |  | Nylon 6.6 | 100 | 1000 |
| PLT4S-C86 | 14.4 | 366 | .190 | 4.8 | .057 | 1.4 | 4.00 | 102 | 50 | 222 |  | Nylon 6.6 | 100 | 1000 |

#### Light-Heavy Cross Section (Straight Tip)

|           |      |     |      |     |      |     |      |     |     |     |                               |           |    |     |
|-----------|------|-----|------|-----|------|-----|------|-----|-----|-----|-------------------------------|-----------|----|-----|
| PLT3H-L86 | 11.1 | 282 | .300 | 7.6 | .075 | 1.9 | 3.00 | 76  | 120 | 120 | GTH, GS4H, GS4EH, STH2, ST3EH | Nylon 6.6 | 50 | 500 |
| PLT4H-L86 | 14.4 | 366 | .300 | 7.6 | .075 | 1.9 | 4.00 | 102 | 120 | 120 |                               | Nylon 6.6 | 50 | 500 |

### Polypropylene

#### Miniature Cross Section

**NEW!**

|            |     |     |       |     |       |     |      |    |    |    |                       |               |     |      |
|------------|-----|-----|-------|-----|-------|-----|------|----|----|----|-----------------------|---------------|-----|------|
| PLT1M-C186 | 3.9 | 100 | 0.098 | 2.5 | 0.044 | 1.1 | 0.87 | 22 | 15 | 67 | GTS, GTSL, GS2B, STS2 | Polypropylene | 100 | 1000 |
|------------|-----|-----|-------|-----|-------|-----|------|----|----|----|-----------------------|---------------|-----|------|

#### Intermediate Cross Section

|            |     |     |      |     |      |     |      |    |    |     |                       |               |     |      |
|------------|-----|-----|------|-----|------|-----|------|----|----|-----|-----------------------|---------------|-----|------|
| PLT2I-C186 | 8.0 | 203 | .135 | 3.4 | .047 | 1.2 | 2.00 | 51 | 24 | 107 | GTS, GTSL, GS2B, STS2 | Polypropylene | 100 | 1000 |
|------------|-----|-----|------|-----|------|-----|------|----|----|-----|-----------------------|---------------|-----|------|

#### Standard Cross Section

|            |      |     |      |     |      |     |      |     |    |     |  |               |     |      |
|------------|------|-----|------|-----|------|-----|------|-----|----|-----|--|---------------|-----|------|
| PLT2S-C186 | 7.3  | 186 | .190 | 4.8 | .057 | 1.4 | 1.85 | 47  | 30 | 133 | GTS, GTSL, GS2B, GTH, GS4H, STS2, STH2 | Polypropylene | 100 | 1000 |
| PLT3S-C186 | 11.5 | 291 | .190 | 4.8 | .057 | 1.4 | 3.00 | 76  | 30 | 133 |  | Polypropylene | 100 | 1000 |
| PLT4S-C186 | 14.4 | 366 | .190 | 4.8 | .057 | 1.4 | 4.00 | 102 | 30 | 133 |  | Polypropylene | 100 | 1000 |

#### Light-Heavy Cross Section (Straight Tip)

|            |      |     |      |     |      |     |      |     |    |     |                               |               |    |     |
|------------|------|-----|------|-----|------|-----|------|-----|----|-----|-------------------------------|---------------|----|-----|
| PLT3H-L186 | 11.1 | 282 | .300 | 7.6 | .075 | 1.9 | 3.00 | 76  | 60 | 267 | GTH, GS4H, GS4EH, STH2, ST3EH | Polypropylene | 50 | 500 |
| PLT4H-L186 | 14.4 | 366 | .300 | 7.6 | .075 | 1.9 | 4.00 | 102 | 60 | 267 |                               | Polypropylene | 50 | 500 |

| Part Number | Material | Used with Cable Ties | A Length In. (mm) | B Width In. (mm) | C Height In. (mm) | Counterbore Diameter In. (mm) | Mounting Method | Std. Pkg. Qty. | Std. Ctn. Qty. |
|-------------|----------|----------------------|-------------------|------------------|-------------------|-------------------------------|-----------------|----------------|----------------|
|-------------|----------|----------------------|-------------------|------------------|-------------------|-------------------------------|-----------------|----------------|----------------|

**NEW!**

#### Cable Tie Mounts

|             |               |                  |             |             |            |            |                |     |     |
|-------------|---------------|------------------|-------------|-------------|------------|------------|----------------|-----|-----|
| TM2S8-C86   | Nylon 6.6     | Min., Int., Std. | .630 (16.0) | .422 (10.7) | .275 (7.0) | .325 (8.3) | #8 (M4) screw  | 100 | 500 |
| TM3S8-C86   |               | Std., Lt. Hvy.   | .867 (22.0) | .614 (15.6) | .373 (9.5) | .325 (8.3) | #8 (M4) screw  | 100 | 500 |
| TM3S10-C86  |               |                  |             |             |            |            | #10 (M5) screw | 100 | 500 |
| TM2S8-C186  | Polypropylene | Min., Int., Std. | .630 (16.0) | .422 (10.7) | .275 (7.0) | .325 (8.3) | #8 (M4) screw  | 100 | 500 |
| TM3S8-C186  |               | Std., Lt. Hvy.   | .867 (22.0) | .614 (15.6) | .373 (9.5) | .325 (8.3) | #8 (M4) screw  | 100 | 500 |
| TM3S10-C186 |               |                  |             |             |            |            | #10 (M5) screw | 100 | 500 |

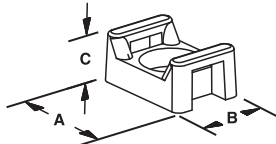

A. System Overview



## Pan-Ty® Releasable Cable Ties – Nylon 6.6

B1. Cable Ties

- For indoor use
- Extended release tab permits easy release and re-use where changes are anticipated during development, production, or servicing in the field

- One-piece construction for consistent performance and reliability
- Curved tip is easy to pick up from flat surfaces and allows faster initial threading to speed installation
- UL Listed for use in plenum or air handling spaces per NEC except PR2H/3H/4H

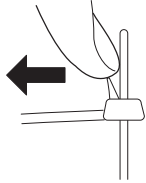

To release, grasp the head of the cable tie, deflect release tab, and pull the cable tie away from the bundle.

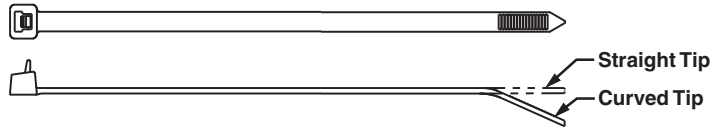

C1. Wiring Duct

C2. Surface Raceway

| Part Number                                     | Length |     | Width |     | Thickness |     | Max. Bundle Dia. |     | Min. Loop Tensile Str. |     | Recommended Installation Tool | Std. Pkg. Qty. | Std. Ctn. Qty. |
|---|--------|-----|-------|-----|-----------|-----|------------------|-----|------------------------|-----|-------------------------------|----------------|----------------|
|   | In.    | mm  | In.   | mm  | In.       | mm  | In.              | mm  | Lbs.                   | N   |                               |                |                |
| <b>Standard Cross Section – Plenum-Rated</b>    |        |     |       |     |           |     |                  |     |                        |     |                               |                |                |
| <b>PRT1S-C</b>                                  | 4.8    | 122 | .190  | 4.8 | .052      | 1.3 | 1.00             | 25  | 50                     | 222 | Hand install only             | 100            | 1000           |
| <b>PRT1.5S-C</b>                                | 6.3    | 160 | .190  | 4.8 | .052      | 1.3 | 1.50             | 38  | 50                     | 222 |                               | 100            | 1000           |
| <b>PRT2S-C</b>                                  | 7.4    | 188 | .190  | 4.8 | .052      | 1.3 | 1.88             | 48  | 50                     | 222 |                               | 100            | 1000           |
| <b>PRT3S-C</b>                                  | 11.5   | 292 | .190  | 4.8 | .052      | 1.3 | 3.00             | 76  | 50                     | 222 |                               | 100            | 1000           |
| <b>PRT4S-C</b>                                  | 14.5   | 368 | .190  | 4.8 | .052      | 1.3 | 4.00             | 102 | 50                     | 222 |                               | 100            | 1000           |
| <b>Light-Heavy Cross Section (Straight Tip)</b> |        |     |       |     |           |     |                  |     |                        |     |                               |                |                |
| <b>PRT2H-L</b>                                  | 8.4    | 213 | .300  | 7.6 | .075      | 1.9 | 2.00             | 51  | 80                     | 356 | Hand install only             | 50             | 500            |
| <b>PRT3H-L</b>                                  | 11.4   | 290 | .300  | 7.6 | .075      | 1.9 | 3.00             | 76  | 80                     | 356 |                               | 50             | 500            |
| <b>PRT4H-L</b>                                  | 14.5   | 368 | .300  | 7.6 | .075      | 1.9 | 4.00             | 102 | 80                     | 356 |                               | 50             | 500            |

C3. Abrasion Protection

C4. Cable Management

D1. Terminals

D2. Power Connectors

D3. Grounding Connectors

E1. Labeling Systems

E2. Labels

E3. Pre-Printed & Write-On Markers

E4. Permanent Identification

E5. Lockout/Tagout & Safety Solutions

F. Index

## Pan-Ty® Releasable Lashing Ties – Nylon 6.6

- For indoor use
- Release tab permits easy release and re-use where changes are anticipated during development, production, or servicing in the field
- Typically used for heavy duty applications
- Strongest Pan-Ty® Cable Tie available
- Can be used with MCEH mounting clip, see page B1.24

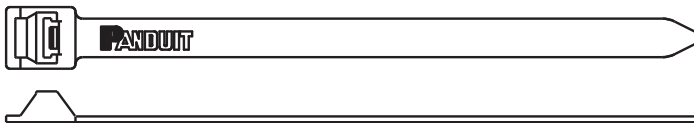

| Part Number                      | Length |      | Width |      | Thickness |     | Max. Bundle Dia. |     | Min. Loop Tensile Str. |      | Recommended Installation Tool | Std. Pkg. Qty. | Std. Ctn. Qty. |
|----------------------------------|--------|------|-------|------|-----------|-----|------------------|-----|------------------------|------|-------------------------------|----------------|----------------|
|                                  | In.    | mm   | In.   | mm   | In.       | mm  | In.              | mm  | Lbs.                   | N    |                               |                |                |
| <b>Extra-Heavy Cross Section</b> |        |      |       |      |           |     |                  |     |                        |      |                               |                |                |
| <b>PRT2EH-C</b>                  | 9.0    | 229  | .500  | 12.7 | .075      | 1.9 | 2.00             | 51  | 250                    | 1112 | Hand install only             | 100            | 1000           |
| <b>PRT5EH-Q</b>                  | 20.1   | 511  | .500  | 12.7 | .075      | 1.9 | 5.00             | 127 | 250                    | 1112 |                               | 25             | 250            |
| <b>PRT6EH-Q</b>                  | 22.2   | 564  | .500  | 12.7 | .075      | 1.9 | 6.00             | 152 | 250                    | 1112 |                               | 25             | 250            |
| <b>PRT8EH-C</b>                  | 28.3   | 719  | .500  | 12.7 | .085      | 2.2 | 8.00             | 203 | 250                    | 1112 |                               | 100            | 1000           |
| <b>PRT10EH-C</b>                 | 34.2   | 869  | .500  | 12.7 | .085      | 2.2 | 10.00            | 254 | 250                    | 1112 |                               | 100            | 500            |
| <b>PRT12EH-C</b>                 | 40.1   | 1019 | .500  | 12.7 | .085      | 2.2 | 12.00            | 305 | 250                    | 1112 |                               | 100            | 500            |



## Pan-Ty® Releasable Cable Ties – Weather Resistant and Heat Stabilized Nylon 6.6

- Weather resistant material has greater resistance to damage caused by ultraviolet light – indoor or outdoor use
- Heat stabilized material for high temperature applications up to 239°F (115°C) – indoor use

- Extended release tab permits easy release and re-use where changes are anticipated during development, production, or servicing in the field
- One-piece construction for consistent performance and reliability
- Curved tip is easy to pick up from flat surfaces and allows faster initial threading to speed installation

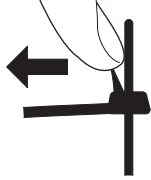

To release, grasp the head of the cable tie, deflect release tab, and pull the cable tie away from the bundle.

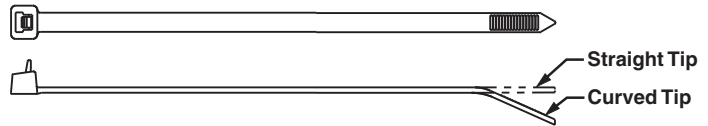

| Part Number | Length |    | Width |    | Thickness |    | Max. Bundle Dia. |    | Min. Loop Tensile Str. |   | Recommended Installation Tool | Std. Pkg. Qty. | Std. Ctn. Qty. |
|-------------|--------|----|-------|----|-----------|----|------------------|----|------------------------|---|-------------------------------|----------------|----------------|
|             | In.    | mm | In.   | mm | In.       | mm | In.              | mm | Lbs.                   | N |                               |                |                |

### Weather Resistant Nylon 6.6

#### Standard Cross Section

|            |      |     |      |     |      |     |      |     |    |     |                   |     |      |
|------------|------|-----|------|-----|------|-----|------|-----|----|-----|-------------------|-----|------|
| PRT1S-C0   | 4.8  | 122 | .190 | 4.8 | .052 | 1.3 | 1.00 | 25  | 50 | 222 | Hand install only | 100 | 1000 |
| PRT1.5S-C0 | 6.3  | 160 | .190 | 4.8 | .052 | 1.3 | 1.50 | 38  | 50 | 222 |                   | 100 | 1000 |
| PRT2S-C0   | 7.4  | 188 | .190 | 4.8 | .052 | 1.3 | 1.88 | 48  | 50 | 222 |                   | 100 | 1000 |
| PRT3S-C0   | 11.5 | 292 | .190 | 4.8 | .052 | 1.3 | 3.00 | 76  | 50 | 222 |                   | 100 | 1000 |
| PRT4S-C0   | 14.5 | 368 | .190 | 4.8 | .052 | 1.3 | 4.00 | 102 | 50 | 222 |                   | 100 | 1000 |

#### Light-Heavy Cross Section (Straight Tip)

|          |      |     |      |     |      |     |      |     |    |     |                   |    |     |
|----------|------|-----|------|-----|------|-----|------|-----|----|-----|-------------------|----|-----|
| PRT2H-L0 | 8.4  | 213 | .300 | 7.6 | .075 | 1.9 | 2.00 | 51  | 80 | 356 | Hand install only | 50 | 500 |
| PRT3H-L0 | 11.4 | 290 | .300 | 7.6 | .075 | 1.9 | 3.00 | 76  | 80 | 356 |                   | 50 | 500 |
| PRT4H-L0 | 14.5 | 368 | .300 | 7.6 | .075 | 1.9 | 4.00 | 102 | 80 | 356 |                   | 50 | 500 |

### Heat Stabilized Nylon 6.6

#### Standard Cross Section

|             |     |     |      |     |      |     |      |    |    |     |                   |      |       |
|-------------|-----|-----|------|-----|------|-----|------|----|----|-----|-------------------|------|-------|
| PRT1.5S-M30 | 6.3 | 160 | .190 | 4.8 | .052 | 1.3 | 1.50 | 38 | 50 | 222 | Hand install only | 1000 | 10000 |
|-------------|-----|-----|------|-----|------|-----|------|----|----|-----|-------------------|------|-------|

Note: UL Listed, UL Recognized, and CSA Certified, except PRT2H/3H/4H.

A. System Overview

B1. Cable Ties

B2. Cable Accessories

B3. Stainless Steel Ties

C1. Wiring Duct

C2. Surface Raceway

C3. Abrasion Protection

C4. Cable Management

D1. Terminals

D2. Power Connectors

D3. Grounding Connectors

E1. Labeling Systems

E2. Labels

E3. Pre-Printed & Write-On Markers

E4. Permanent Identification

E5. Lockout/Tagout & Safety Solutions

F. Index

A. System Overview

## Pan-Ty® Releasable Lashing Ties – Weather Resistant and Heat Stabilized Nylon 6.6

B1. Cable Ties

- Weather resistant material has greater resistance to damage caused by ultraviolet light – indoor or outdoor use
- Heat stabilized material for high temperature applications up to 239°F (115°C) – indoor use
- Release tab permits easy release and re-use where changes are anticipated during development, production, or servicing in the field
- Typically used for heavy duty applications
- Strongest Pan-Ty® Cable Tie available
- Can be used with MCEH mounting clip shown below

B2. Cable Accessories

B3. Stainless Steel Ties

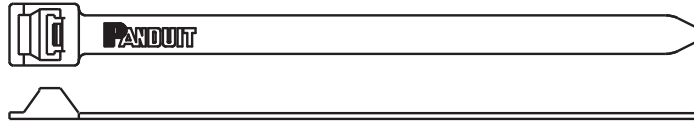

C1. Wiring Duct

C2. Surface Raceway

| Part Number | Length |    | Width |    | Thickness |    | Max. Bundle Dia. |    | Min. Loop Tensile Str. |   | Recommended Installation Tool | Std. Pkg. Qty. | Std. Ctn. Qty. |
|-------------|--------|----|-------|----|-----------|----|------------------|----|------------------------|---|-------------------------------|----------------|----------------|
|             | In.    | mm | In.   | mm | In.       | mm | In.              | mm | Lbs.                   | N |                               |                |                |

C3. Abrasion Protection

### Weather Resistant Nylon 6.6

#### Extra-Heavy Cross Section

|                   |      |      |       |      |       |     |       |     |     |      |                   |    |     |
|-------------------|------|------|-------|------|-------|-----|-------|-----|-----|------|-------------------|----|-----|
| <b>PRT2EH-Q0</b>  | 9.0  | 229  | 0.500 | 12.7 | 0.075 | 1.9 | 2.00  | 51  | 250 | 1112 | Hand install only | 25 | 250 |
| <b>PRT5EH-Q0</b>  | 20.1 | 511  | 0.500 | 12.7 | 0.075 | 1.9 | 5.00  | 127 | 250 | 1112 |                   | 25 | 250 |
| <b>PRT6EH-Q0</b>  | 22.2 | 564  | 0.500 | 12.7 | 0.075 | 1.9 | 6.00  | 152 | 250 | 1112 |                   | 25 | 250 |
| <b>PRT8EH-Q0</b>  | 28.3 | 719  | 0.500 | 12.7 | 0.085 | 2.2 | 8.00  | 203 | 250 | 1112 |                   | 25 | 250 |
| <b>PRT10EH-Q0</b> | 34.2 | 869  | 0.500 | 12.7 | 0.085 | 2.2 | 10.00 | 254 | 250 | 1112 |                   | 25 | 250 |
| <b>PRT12EH-Q0</b> | 40.1 | 1019 | 0.500 | 12.7 | 0.085 | 2.2 | 12.00 | 305 | 250 | 1112 |                   | 25 | 250 |

C4. Cable Management

D1. Terminals

### Heat Stabilized Nylon 6.6

#### Extra-Heavy Cross Section

|                   |      |     |       |      |       |     |      |     |     |      |                   |     |      |
|-------------------|------|-----|-------|------|-------|-----|------|-----|-----|------|-------------------|-----|------|
| <b>PRT5EH-C30</b> | 20.1 | 511 | 0.500 | 12.7 | 0.075 | 1.9 | 5.00 | 127 | 250 | 1112 | Hand install only | 100 | 1000 |
|-------------------|------|-----|-------|------|-------|-----|------|-----|-----|------|-------------------|-----|------|

D2. Power Connectors

D3. Grounding Connectors

## Lashing Tie Mounting Clip – Weather Resistant Nylon 6.6

E1. Labeling Systems

- Greater resistance to damage caused by ultraviolet light – indoor or outdoor use
- Converts Panduit lashing ties into clamps
- Easily snaps in place for a secure clamp
- Use with lashing ties shown on pages B1.9, B1.11, B1.22, B1.24 and B1.25

E2. Labels

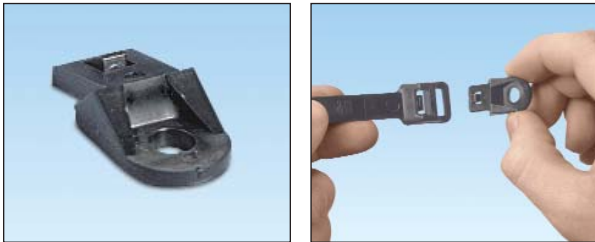

E3. Pre-Printed & Write-On Markers

E4. Permanent Identification

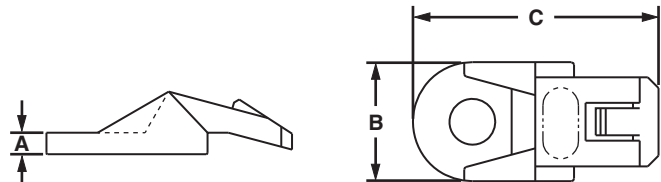

E5. Lockout/Tagout & Safety Solutions

| Part Number        | Height A |     | Width B |      | Length C |    | Mounting Method                | Std. Pkg. Qty. | Std. Ctn. Qty. |
|--------------------|----------|-----|---------|------|----------|----|--------------------------------|----------------|----------------|
|                    | In.      | mm  | In.     | mm   | In.      | mm |                                |                |                |
| <b>MCEH-S25-C0</b> | .13      | 3.3 | .67     | 17.0 | 1.38     | 35 | 1/4" (M6) screw (not flathead) | 100            | 1000           |

F. Index



## Pan-Ty® Releasable Lashing Ties – Weather Resistant Polypropylene

- For chemical resistance where high loop tensile strength is not required especially in the presence of hydrochloric acid, salts, and bases
- Greater resistance to damage caused by ultraviolet light – indoor or outdoor use
- Release tab permits easy release and re-use where changes are anticipated during development, production, or servicing in the field
- Typically used for heavy duty applications
- Can be used with MCEH mounting clip, see page B1.24

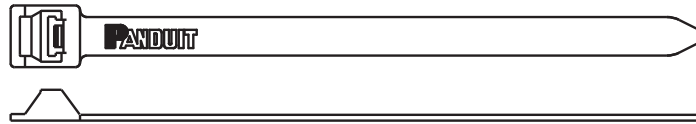

| Part Number                      | Length |     | Width |      | Thickness |     | Max. Bundle Dia. |     | Min. Loop Tensile Str. |     | Recommended Installation Tool | Std. Pkg. Qty. | Std. Ctn. Qty. |
|----------------------------------|--------|-----|-------|------|-----------|-----|------------------|-----|------------------------|-----|-------------------------------|----------------|----------------|
|                                  | In.    | mm  | In.   | mm   | In.       | mm  | In.              | mm  | Lbs.                   | N   |                               |                |                |
| <b>Extra-Heavy Cross Section</b> |        |     |       |      |           |     |                  |     |                        |     |                               |                |                |
| <b>PRT2EH-C100</b>               | 9.0    | 229 | .500  | 12.7 | .075      | 1.9 | 2.00             | 51  | 90                     | 400 | Hand install only             | 100            | 1000           |
| <b>PRT5EH-C100</b>               | 20.1   | 511 | .500  | 12.7 | .075      | 1.9 | 5.00             | 127 | 90                     | 400 |                               | 100            | 1000           |
| <b>PRT6EH-C100</b>               | 22.2   | 564 | .500  | 12.7 | .075      | 1.9 | 6.00             | 152 | 90                     | 400 |                               | 100            | 1000           |
| <b>PRT8EH-C100</b>               | 28.3   | 719 | .500  | 12.7 | .085      | 2.2 | 8.00             | 203 | 90                     | 400 |                               | 100            | 1000           |

A.  
System  
Overview

B1.  
Cable Ties

B2.  
Cable  
Accessories

B3.  
Stainless  
Steel Ties

C1.  
Wiring  
Duct

C2.  
Surface  
Raceway

C3.  
Abrasion  
Protection

C4.  
Cable  
Management

D1.  
Terminals

D2.  
Power  
Connectors

D3.  
Grounding  
Connectors

E1.  
Labeling  
Systems

E2.  
Labels

E3.  
Pre-Printed  
& Write-On  
Markers

E4.  
Permanent  
Identification

E5.  
Lockout/  
Tagout  
& Safety  
Solutions

F.  
Index

A. System Overview

**UL** **UL** **SP** **Pan-Ty® Clamp Ties – Nylon 6.6**

B1. Cable Ties

- For indoor use
- Used to secure a cable bundle to another surface such as a control panel, communication rack, wall or ceiling
- Design allows for bundling before or after screwing clamp in place

- One-piece construction for consistent performance and reliability
- Curved tip is easy to pick up from flat surfaces and allows faster initial threading to speed installation
- UL Listed for use in plenum or air handling spaces per NEC

B2. Cable Accessories

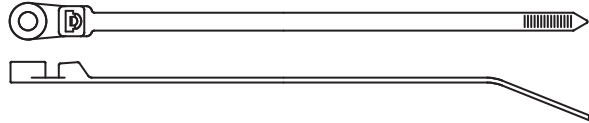

B3. Stainless Steel Ties

C1. Wiring Duct



C2. Surface Raceway

| Part Number | Length |    | Width |    | Thickness |    | Nominal Hole Dia. |    | Screw Size | Metric Screw Size | Max. Bundle Dia. |    | Min. Loop Tensile Str. |   | Recommended Installation Tool | Std. Pkg. Qty. | Std. Ctn. Qty. |
|-------------|--------|----|-------|----|-----------|----|-------------------|----|------------|-------------------|------------------|----|------------------------|---|-------------------------------|----------------|----------------|
|             | In.    | mm | In.   | mm | In.       | mm | In.               | mm |            |                   | In.              | mm | Lbs.                   | N |                               |                |                |

**Miniature Cross Section – Plenum-Rated**

|                   |     |     |      |     |      |     |      |     |    |      |     |    |    |    |                                  |     |      |
|-------------------|-----|-----|------|-----|------|-----|------|-----|----|------|-----|----|----|----|----------------------------------|-----|------|
| <b>PLC1M-S4-C</b> | 4.3 | 109 | .100 | 2.5 | .045 | 1.1 | .122 | 3.1 | #4 | M2.5 | .75 | 19 | 18 | 80 | GTS, GTSL, GS2B, PTS, PPTS, STS2 | 100 | 1000 |
|-------------------|-----|-----|------|-----|------|-----|------|-----|----|------|-----|----|----|----|----------------------------------|-----|------|

**Intermediate Cross Section – Plenum-Rated**

|                     |     |     |      |     |      |     |      |     |    |    |      |    |    |     |                                  |     |      |
|---------------------|-----|-----|------|-----|------|-----|------|-----|----|----|------|----|----|-----|----------------------------------|-----|------|
| <b>PLC1.5I-S8-C</b> | 6.1 | 155 | .135 | 3.4 | .045 | 1.1 | .174 | 4.4 | #8 | M4 | 1.25 | 32 | 40 | 178 | GTS, GTSL, GS2B, PTS, PPTS, STS2 | 100 | 1000 |
|---------------------|-----|-----|------|-----|------|-----|------|-----|----|----|------|----|----|-----|----------------------------------|-----|------|

**Standard Cross Section – Plenum-Rated**

|                    |      |     |      |     |      |     |      |     |     |    |      |     |    |     |  |     |      |
|--------------------|------|-----|------|-----|------|-----|------|-----|-----|----|------|-----|----|-----|--|-----|------|
| <b>PLC2S-S6-C</b>  | 7.9  | 201 | .190 | 4.8 | .047 | 1.2 | .148 | 3.8 | #6  | M3 | 1.84 | 47  | 50 | 222 | GTS, GTSL, GS2B, GTH, GS4H, PTS, PTH, PPTS, STS2, STH2 | 100 | 1000 |
| <b>PLC2S-S10-C</b> | 7.9  | 201 | .190 | 4.8 | .047 | 1.2 | .200 | 5.1 | #10 | M5 | 1.84 | 47  | 50 | 222 |  | 100 | 1000 |
| <b>PLC3S-S10-C</b> | 12.0 | 305 | .190 | 4.8 | .047 | 1.2 | .200 | 5.1 | #10 | M5 | 3.00 | 76  | 50 | 222 |  | 100 | 1000 |
| <b>PLC4S-S10-C</b> | 15.0 | 381 | .190 | 4.8 | .052 | 1.3 | .200 | 5.1 | #10 | M5 | 4.00 | 102 | 50 | 222 |  | 100 | 1000 |

**Light-Heavy Cross Section – Plenum-Rated**

|                    |      |     |      |     |      |     |      |     |     |    |      |     |     |     |                                    |    |     |
|--------------------|------|-----|------|-----|------|-----|------|-----|-----|----|------|-----|-----|-----|------------------------------------|----|-----|
| <b>PLC2H-S25-L</b> | 9.0  | 229 | .300 | 7.6 | .075 | 1.9 | .260 | 6.6 | 1/4 | M6 | 2.00 | 51  | 120 | 534 | GTH, GS4H, GS4EH, PTH, STH2, ST3EH | 50 | 500 |
| <b>PLC4H-S25-L</b> | 15.1 | 384 | .300 | 7.6 | .075 | 1.9 | .260 | 6.6 | 1/4 | M6 | 4.00 | 102 | 120 | 534 |                                    | 50 | 500 |

D1. Terminals

D2. Power Connectors

D3. Grounding Connectors

E1. Labeling Systems

E2. Labels

E3. Pre-Printed & Write-On Markers

E4. Permanent Identification

E5. Lockout/Tagout & Safety Solutions

F. Index

## UL<sup>®</sup> US<sup>®</sup> CS<sup>®</sup> Pan-Ty<sup>®</sup> Clamp Ties – Weather Resistant and Heat Stabilized Nylon 6.6

- Weather resistant material has greater resistance to damage caused by ultraviolet light – indoor or outdoor use
- Heat stabilized material for high temperature applications up to 239°F (115°C) – indoor use
- Used to secure a cable bundle to another surface such as a control panel, communication rack, wall or ceiling

- Design allows for bundling before or after screwing clamp in place
- One-piece construction for consistent performance and reliability
- Curved tip is easy to pick up from flat surfaces and allows faster initial threading to speed installation

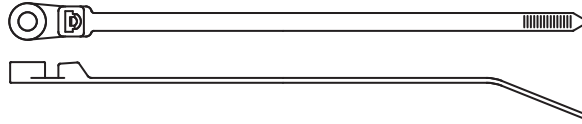

| Part Number | Length |    | Width |    | Thickness |    | Nominal Hole Dia. |    | Screw Size | Metric Screw Size | Max. Bundle Dia. |    | Min. Loop Tensile Str. |   | Recommended Installation Tool | Std. Pkg. Qty. | Std. Ctn. Qty. |
|-------------|--------|----|-------|----|-----------|----|-------------------|----|------------|-------------------|------------------|----|------------------------|---|-------------------------------|----------------|----------------|
|             | In.    | mm | In.   | mm | In.       | mm | In.               | mm |            |                   | In.              | mm | Lbs.                   | N |                               |                |                |

### Weather Resistant Nylon 6.6

#### Miniature Cross Section

|             |     |     |      |     |      |     |      |     |    |      |     |    |    |    |                                  |     |      |
|-------------|-----|-----|------|-----|------|-----|------|-----|----|------|-----|----|----|----|----------------------------------|-----|------|
| PLC1M-S4-C0 | 4.3 | 109 | .100 | 2.5 | .045 | 1.1 | .122 | 3.1 | #4 | M2.5 | .75 | 19 | 18 | 80 | GTS, GTSL, GS2B, PTS, PPTS, STS2 | 100 | 1000 |
|-------------|-----|-----|------|-----|------|-----|------|-----|----|------|-----|----|----|----|----------------------------------|-----|------|

#### Intermediate Cross Section

|               |     |     |      |     |      |     |      |     |    |    |      |    |    |     |                                  |     |      |
|---------------|-----|-----|------|-----|------|-----|------|-----|----|----|------|----|----|-----|----------------------------------|-----|------|
| PLC1.5I-S8-C0 | 6.1 | 155 | .135 | 3.4 | .045 | 1.1 | .174 | 4.4 | #8 | M4 | 1.25 | 32 | 40 | 178 | GTS, GTSL, GS2B, PTS, PPTS, STS2 | 100 | 1000 |
|---------------|-----|-----|------|-----|------|-----|------|-----|----|----|------|----|----|-----|----------------------------------|-----|------|

#### Standard Cross Section

|              |      |     |      |     |      |     |      |     |     |    |      |     |    |     |  |     |      |
|--------------|------|-----|------|-----|------|-----|------|-----|-----|----|------|-----|----|-----|--|-----|------|
| PLC2S-S6-C0  | 7.9  | 201 | .190 | 4.8 | .047 | 1.2 | .148 | 3.8 | #6  | M3 | 1.84 | 47  | 50 | 222 | GTS, GTSL, GS2B, GTH, GS4H, PTS, PTH, PPTS, STS2, STH2 | 100 | 1000 |
| PLC2S-S10-C0 | 7.9  | 201 | .190 | 4.8 | .047 | 1.2 | .200 | 5.1 | #10 | M5 | 1.84 | 47  | 50 | 222 |  | 100 | 1000 |
| PLC3S-S10-C0 | 12.0 | 305 | .190 | 4.8 | .052 | 1.3 | .200 | 5.1 | #10 | M5 | 3.00 | 76  | 50 | 222 |  | 100 | 1000 |
| PLC4S-S10-C0 | 15.0 | 381 | .190 | 4.8 | .052 | 1.3 | .200 | 5.1 | #10 | M5 | 4.00 | 102 | 50 | 222 |  | 100 | 1000 |

#### Light-Heavy Cross Section

|               |      |     |      |     |      |     |      |     |     |    |      |     |     |     |                                    |     |      |
|---------------|------|-----|------|-----|------|-----|------|-----|-----|----|------|-----|-----|-----|------------------------------------|-----|------|
| PLC2H-S25-TL0 | 9.0  | 229 | .300 | 7.6 | .075 | 1.9 | .260 | 6.6 | 1/4 | M6 | 2.00 | 51  | 120 | 534 | GTH, GS4H, GS4EH, PTH, STH2, ST3EH | 250 | 2500 |
| PLC4H-S25-L0  | 15.1 | 384 | .300 | 7.6 | .075 | 1.9 | .260 | 6.6 | 1/4 | M6 | 4.00 | 102 | 120 | 534 |                                    | 50  | 500  |

### Heat Stabilized Nylon 6.6

#### Miniature Cross Section

|              |     |     |      |     |      |     |      |     |    |      |     |    |    |    |                                  |      |       |
|--------------|-----|-----|------|-----|------|-----|------|-----|----|------|-----|----|----|----|----------------------------------|------|-------|
| PLC1M-S4-M30 | 4.3 | 109 | .100 | 2.5 | .045 | 1.1 | .122 | 3.1 | #4 | M2.5 | .75 | 19 | 18 | 80 | GTS, GTSL, GS2B, PTS, PPTS, STS2 | 1000 | 50000 |
|--------------|-----|-----|------|-----|------|-----|------|-----|----|------|-----|----|----|----|----------------------------------|------|-------|

#### Intermediate Cross Section

|                |     |     |      |     |      |     |      |     |    |    |      |    |    |     |                                  |      |       |
|----------------|-----|-----|------|-----|------|-----|------|-----|----|----|------|----|----|-----|----------------------------------|------|-------|
| PLC1.5I-S8-M30 | 6.1 | 155 | .135 | 3.4 | .045 | 1.1 | .174 | 4.4 | #8 | M4 | 1.25 | 32 | 40 | 178 | GTS, GTSL, GS2B, PTS, PPTS, STS2 | 1000 | 25000 |
|----------------|-----|-----|------|-----|------|-----|------|-----|----|----|------|----|----|-----|----------------------------------|------|-------|

#### Standard Cross Section

|               |      |     |      |     |      |     |      |     |     |    |      |     |    |     |  |      |       |
|---------------|------|-----|------|-----|------|-----|------|-----|-----|----|------|-----|----|-----|--|------|-------|
| PLC2S-S10-M30 | 7.9  | 201 | .190 | 4.8 | .047 | 1.2 | .200 | 5.1 | #10 | M5 | 1.84 | 47  | 50 | 222 | GTS, GTSL, GS2B, GTH, GS4H, PTS, PTH, PPTS, STS2, STH2 | 1000 | 10000 |
| PLC4S-S10-M30 | 15.0 | 381 | .190 | 4.8 | .052 | 1.3 | .200 | 5.1 | #10 | M5 | 4.00 | 102 | 50 | 222 |  | 1000 | 5000  |

#### Light-Heavy Cross Section

|                |      |     |      |     |      |     |      |     |     |    |      |     |     |     |                                    |     |      |
|----------------|------|-----|------|-----|------|-----|------|-----|-----|----|------|-----|-----|-----|------------------------------------|-----|------|
| PLC2H-S25-TL30 | 9.0  | 229 | .300 | 7.6 | .075 | 1.9 | .260 | 6.6 | 1/4 | M6 | 2.00 | 51  | 120 | 534 | GTH, GS4H, GS4EH, PTH, STH2, ST3EH | 250 | 2500 |
| PLC4H-S25-TL30 | 15.1 | 384 | .300 | 7.6 | .075 | 1.9 | .260 | 6.6 | 1/4 | M6 | 4.00 | 102 | 120 | 534 |                                    | 250 | 2500 |

Note: UL Recognized and CSA Certified except PLC2H/4H in Weather Resistant material (0).

A.  
System  
Overview

B1.  
Cable Ties

B2.  
Cable  
Accessories

B3.  
Stainless  
Steel Ties

C1.  
Wiring  
Duct

C2.  
Surface  
Raceway

C3.  
Abrasion  
Protection

C4.  
Cable  
Management

D1.  
Terminals

D2.  
Power  
Connectors

D3.  
Grounding  
Connectors

E1.  
Labeling  
Systems

E2.  
Labels

E3.  
Pre-Printed  
& Write-On  
Markers

E4.  
Permanent  
Identification

E5.  
Lockout/  
Tagout  
& Safety  
Solutions

F.  
Index

A. System Overview

## UL<sup>®</sup> CS<sup>®</sup> Pan-Ty<sup>®</sup> Wing Push Mount Ties – Nylon 6.6

B1. Cable Ties

- For indoor use
- Cable tie, mount, and fastener in a single part
- Used to attach bundles to another surface such as a flat panel
- Anchor is easily pressed into a pre-formed hole and locks in place

- Wings provide constant tension for a stable, secure, and rattle-free installation
- Curved tip is easy to pick up from flat surfaces and allows faster initial threading to speed installation

B2. Cable Accessories



B3. Stainless Steel Ties

C1. Wiring Duct

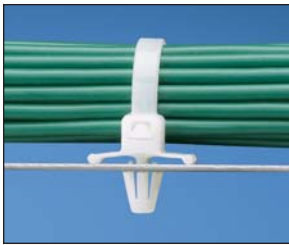

C2. Surface Raceway

C3. Abrasion Protection

C4. Cable Management

D1. Terminals

D2. Power Connectors

D3. Grounding Connectors

E1. Labeling Systems

E2. Labels

E3. Pre-Printed & Write-On Markers

E4. Permanent Identification

E5. Lockout/Tagout & Safety Solutions

F. Index

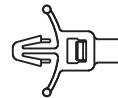
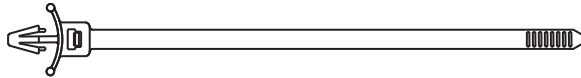

**PLWP\_SA Head Design**



**PLWP\_SB Head Design**

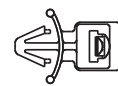

**PLWP\_H Head Design**



| Part Number                       | Length |     | Width |     | Thickness |     | Nominal Hole Dia. |     | Max. Panel Thickness |     | Max. Bundle Dia. |    | Min. Loop Tensile Str. |     | Recommended Installation Tool                          | Std. Pkg. Qty. | Std. Ctn. Qty. |
|-----------------------------------|--------|-----|-------|-----|-----------|-----|-------------------|-----|----------------------|-----|------------------|----|------------------------|-----|--|----------------|----------------|
|                                   | In.    | mm  | In.   | mm  | In.       | mm  | In.               | mm  | In.                  | mm  | In.              | mm | Lbs.                   | N   |  |                |                |
| <b>Miniature Cross Section</b>    |        |     |       |     |           |     |                   |     |                      |     |                  |    |                        |     |  |                |                |
| <b>PLWP1M-C</b>                   | 4.3    | 109 | .098  | 2.5 | .044      | 1.1 | .187              | 4.7 | .093                 | 2.4 | .87              | 22 | 18                     | 80  | GTS, GTSL, GS2B, PTS, PPTS, STS2                       | 100            | 1000           |
| <b>Intermediate Cross Section</b> |        |     |       |     |           |     |                   |     |                      |     |                  |    |                        |     |  |                |                |
| <b>PLWP1.5I-C</b>                 | 6.0    | 152 | .135  | 3.4 | .045      | 1.2 | .187              | 4.7 | .093                 | 2.4 | 1.25             | 32 | 40                     | 178 | GTS, GTSL, GS2B, PTS, PPTS, STS2                       | 100            | 1000           |
| <b>Standard Cross Section</b>     |        |     |       |     |           |     |                   |     |                      |     |                  |    |                        |     |  |                |                |
| <b>PLWP1S-C</b>                   | 5.2    | 132 | .190  | 4.8 | .052      | 1.3 | .250              | 6.4 | .105                 | 2.7 | 1.00             | 25 | 50                     | 222 | GTS, GTSL, GS2B, GTH, GS4H, PTS, PTH, PPTS, STS2, STH2 | 100            | 1000           |
| <b>PLWP1SA-D</b>                  | 5.1    | 130 | .190  | 4.8 | .052      | 1.3 | .187              | 4.7 | .093                 | 2.4 | 1.00             | 25 | 50                     | 222 |  | 500            | 5000           |
| <b>PLWP1SB-D</b>                  | 5.2    | 132 | .190  | 4.8 | .052      | 1.3 | .187              | 4.7 | .157                 | 4.0 | 1.00             | 25 | 50                     | 222 |  | 500            | 5000           |
| <b>PLWP1.5S-D</b>                 | 6.8    | 173 | .190  | 4.8 | .052      | 1.3 | .250              | 6.4 | .105                 | 2.7 | 1.50             | 38 | 50                     | 222 |  | 500            | 5000           |
| <b>PLWP1.5SA-D</b>                | 6.7    | 170 | .190  | 4.8 | .052      | 1.3 | .187              | 4.7 | .093                 | 2.4 | 1.50             | 38 | 50                     | 222 |  | 500            | 5000           |
| <b>PLWP2S-C</b>                   | 7.8    | 198 | .190  | 4.8 | .052      | 1.3 | .250              | 6.4 | .105                 | 2.7 | 1.75             | 45 | 50                     | 222 |  | 100            | 1000           |
| <b>PLWP2SA-D</b>                  | 7.7    | 196 | .190  | 4.8 | .052      | 1.3 | .187              | 4.7 | .093                 | 2.4 | 1.75             | 45 | 50                     | 222 |  | 500            | 5000           |
| <b>PLWP2SB-D</b>                  | 7.8    | 198 | .190  | 4.8 | .052      | 1.3 | .187              | 4.7 | .157                 | 4.0 | 1.75             | 45 | 50                     | 222 |  | 500            | 5000           |
| <b>Light-Heavy Cross Section</b>  |        |     |       |     |           |     |                   |     |                      |     |                  |    |                        |     |  |                |                |
| <b>PLWP2H-TL</b>                  | 8.9    | 226 | .300  | 7.6 | .075      | 1.9 | .266              | 6.8 | .105                 | 2.7 | 2.00             | 51 | 120                    | 534 | GTH, GS4H, GS4EH, PTH, STH2, ST3EH                     | 250            | 2500           |
| <b>PLWP3H-TL</b>                  | 12.0   | 305 | .300  | 7.6 | .075      | 1.9 | .266              | 6.8 | .105                 | 2.7 | 3.00             | 76 | 120                    | 534 |  | 250            | 2500           |

Note: UL Recognized and CSA Certified except PLWP2H/3H.



## Pan-Ty® Wing Push Mount Ties – Weather Resistant and Heat Stabilized Nylon 6.6

- Weather resistant material has greater resistance to damage caused by ultraviolet light – indoor or outdoor use
- Heat stabilized material for high temperature applications up to 239°F (115°C) – indoor use
- Cable tie, mount, and fastener in a single part
- Used to attach bundles to another surface such as a flat panel

- Anchor is easily pressed into a pre-formed hole and locks in place
- Wings provide constant tension for a stable, secure, and rattle-free installation
- Curved tip is easy to pick up from flat surfaces and allows faster initial threading to speed installation

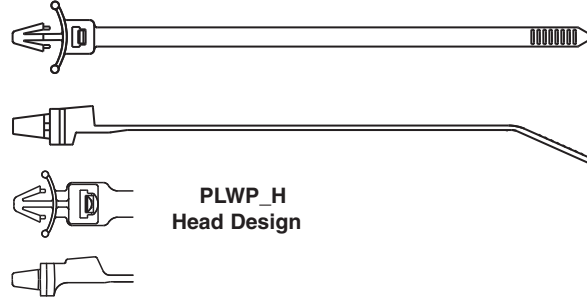

| Part Number | Length |    | Width |    | Thickness |    | Nominal Hole Dia. |    | Max. Panel Thickness |    | Max. Bundle Dia. |    | Min. Loop Tensile Str. |   | Recommended Installation Tool | Std. Pkg. Qty. | Std. Ctn. Qty. |
|-------------|--------|----|-------|----|-----------|----|-------------------|----|----------------------|----|------------------|----|------------------------|---|-------------------------------|----------------|----------------|
|             | In.    | mm | In.   | mm | In.       | mm | In.               | mm | In.                  | mm | In.              | mm | Lbs.                   | N |                               |                |                |

### Weather Resistant Nylon 6.6

#### Miniature Cross Section

|                  |     |     |      |     |      |     |      |     |      |     |     |    |    |    |                                  |     |      |
|------------------|-----|-----|------|-----|------|-----|------|-----|------|-----|-----|----|----|----|----------------------------------|-----|------|
| <b>PLWP1M-D0</b> | 4.3 | 109 | .098 | 2.5 | .044 | 1.1 | .187 | 4.7 | .093 | 2.4 | .87 | 22 | 18 | 80 | GTS, GTSL, GS2B, PTS, PPTS, STS2 | 500 | 5000 |
|------------------|-----|-----|------|-----|------|-----|------|-----|------|-----|-----|----|----|----|----------------------------------|-----|------|

#### Standard Cross Section

|                  |     |     |      |     |      |     |      |     |      |     |      |    |    |     |  |     |      |
|------------------|-----|-----|------|-----|------|-----|------|-----|------|-----|------|----|----|-----|--|-----|------|
| <b>PLWP1S-C0</b> | 5.2 | 132 | .190 | 4.8 | .052 | 1.3 | .250 | 6.4 | .105 | 2.7 | 1.00 | 25 | 50 | 222 | GTS, GTSL, GS2B, GTH, GS4H, PTS, PTH, PPTS, STS2, STH2 | 100 | 1000 |
| <b>PLWP2S-C0</b> | 7.8 | 198 | .190 | 4.8 | .052 | 1.3 | .250 | 6.4 | .105 | 2.7 | 1.75 | 45 | 50 | 222 |  | 100 | 1000 |

#### Light-Heavy Cross Section

|                   |      |     |      |     |      |     |      |     |      |     |      |    |     |     |                                    |     |      |
|-------------------|------|-----|------|-----|------|-----|------|-----|------|-----|------|----|-----|-----|------------------------------------|-----|------|
| <b>PLWP2H-TL0</b> | 8.9  | 226 | .300 | 7.6 | .075 | 1.9 | .266 | 6.8 | .105 | 2.7 | 2.00 | 51 | 120 | 534 | GTH, GS4H, GS4EH, PTH, STH2, ST3EH | 250 | 2500 |
| <b>PLWP3H-TL0</b> | 12.0 | 305 | .300 | 7.6 | .075 | 1.9 | .266 | 6.8 | .105 | 2.7 | 3.00 | 76 | 120 | 534 |                                    | 250 | 2500 |

### Heat Stabilized Nylon 6.6

#### Miniature Cross Section

|                   |     |     |      |     |      |     |      |     |      |     |     |    |    |    |                                  |     |      |
|-------------------|-----|-----|------|-----|------|-----|------|-----|------|-----|-----|----|----|----|----------------------------------|-----|------|
| <b>PLWP1M-D30</b> | 4.3 | 109 | .098 | 2.5 | .044 | 1.1 | .187 | 4.7 | .093 | 2.4 | .87 | 22 | 18 | 80 | GTS, GTSL, GS2B, PTS, PPTS, STS2 | 500 | 5000 |
|-------------------|-----|-----|------|-----|------|-----|------|-----|------|-----|-----|----|----|----|----------------------------------|-----|------|

#### Intermediate Cross Section

|                     |     |     |      |     |      |     |      |     |      |     |      |    |    |     |                                  |     |      |
|---------------------|-----|-----|------|-----|------|-----|------|-----|------|-----|------|----|----|-----|----------------------------------|-----|------|
| <b>PLWP1.5I-D30</b> | 6.0 | 152 | .135 | 3.4 | .045 | 1.2 | .187 | 4.7 | .093 | 2.4 | 1.25 | 32 | 40 | 178 | GTS, GTSL, GS2B, PTS, PPTS, STS2 | 500 | 5000 |
|---------------------|-----|-----|------|-----|------|-----|------|-----|------|-----|------|----|----|-----|----------------------------------|-----|------|

#### Standard Cross Section

|                     |     |     |      |     |      |     |      |     |      |     |      |    |    |     |  |     |      |
|---------------------|-----|-----|------|-----|------|-----|------|-----|------|-----|------|----|----|-----|--|-----|------|
| <b>PLWP1S-D30</b>   | 5.2 | 132 | .190 | 4.8 | .052 | 1.3 | .250 | 6.4 | .105 | 2.7 | 1.00 | 25 | 50 | 222 | GTS, GTSL, GS2B, GTH, GS4H, PTS, PTH, PPTS, STS2, STH2 | 500 | 5000 |
| <b>PLWP1.5S-D30</b> | 6.8 | 173 | .190 | 4.8 | .052 | 1.3 | .250 | 6.4 | .105 | 2.7 | 1.50 | 38 | 50 | 222 |  | 500 | 5000 |
| <b>PLWP2S-D30</b>   | 7.8 | 198 | .190 | 4.8 | .052 | 1.3 | .250 | 6.4 | .105 | 2.7 | 1.75 | 45 | 50 | 222 |  | 500 | 5000 |

#### Light-Heavy Cross Section

|                    |     |     |      |     |      |     |      |     |      |     |      |    |     |     |                                    |     |      |
|--------------------|-----|-----|------|-----|------|-----|------|-----|------|-----|------|----|-----|-----|------------------------------------|-----|------|
| <b>PLWP2H-TL30</b> | 8.9 | 226 | .300 | 7.6 | .075 | 1.9 | .266 | 6.8 | .105 | 2.7 | 2.00 | 51 | 120 | 534 | GTH, GS4H, GS4EH, PTH, STH2, ST3EH | 250 | 2500 |
|--------------------|-----|-----|------|-----|------|-----|------|-----|------|-----|------|----|-----|-----|------------------------------------|-----|------|

Note: UL Recognized and CSA Certified except PLWP2H/3H.

A.  
System  
Overview

B1.  
Cable Ties

B2.  
Cable  
Accessories

B3.  
Stainless  
Steel Ties

C1.  
Wiring  
Duct

C2.  
Surface  
Raceway

C3.  
Abrasion  
Protection

C4.  
Cable  
Management

D1.  
Terminals

D2.  
Power  
Connectors

D3.  
Grounding  
Connectors

E1.  
Labeling  
Systems

E2.  
Labels

E3.  
Pre-Printed  
& Write-On  
Markers

E4.  
Permanent  
Identification

E5.  
Lockout/  
Tagout  
& Safety  
Solutions

F.  
Index



A. System Overview

## UL<sup>®</sup> cUL<sup>®</sup> CSA<sup>®</sup> Pan-Ty<sup>®</sup> Releasable Wing Push Mount Ties

B1. Cable Ties

- Natural nylon material for indoor use
- Weather resistant material has greater resistance to damage caused by ultraviolet light – indoor or outdoor use
- Heat stabilized material for high temperature applications up to 239°F (115°C) – indoor use
- Cable tie, mount, and fastener in a single part
- Used to attach bundles to another surface such as a flat panel

- Anchor is easily pressed into a pre-formed hole and locks in place
- Wings provide constant tension for a stable, secure, and rattle-free installation
- Extended release tab permits easy release and re-use where changes are anticipated during development, production, or servicing in the field
- Curved tip is easy to pick up from flat surfaces and allows faster initial threading to speed installation

B2. Cable Accessories

B3. Stainless Steel Ties

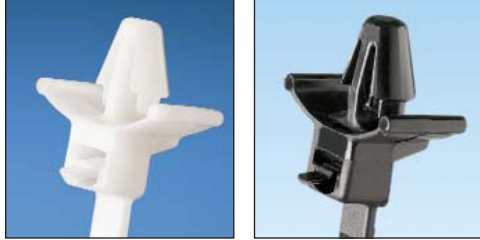

PRWP2S-D

PRWP2S-D0

C1. Wiring Duct

C2. Surface Raceway

C3. Abrasion Protection

C4. Cable Management



D1. Terminals

D2. Power Connectors

D3. Grounding Connectors

E1. Labeling Systems

E2. Labels

E3. Pre-Printed & Write-On Markers

E4. Permanent Identification

E5. Lockout/Tagout & Safety Solutions

F. Index

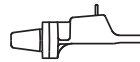
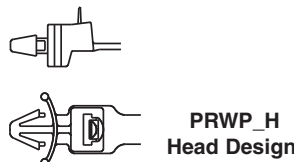
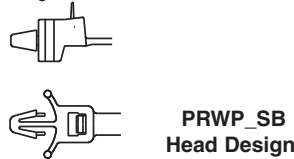
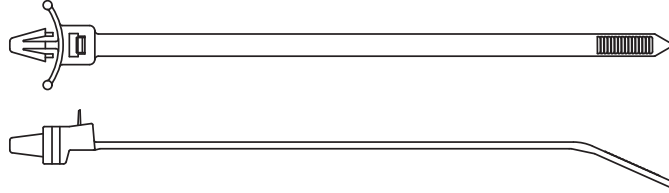

| Part Number | Length |    | Width |    | Thickness |    | Nominal Hole Dia. |    | Max. Panel Thickness |    | Max. Bundle Dia. |    | Min. Loop Tensile Str. |   | Recommended Installation Tool | Std. Pkg. Qty. | Std. Ctn. Qty. |
|-------------|--------|----|-------|----|-----------|----|-------------------|----|----------------------|----|------------------|----|------------------------|---|-------------------------------|----------------|----------------|
|             | In.    | mm | In.   | mm | In.       | mm | In.               | mm | In.                  | mm | In.              | mm | Lbs.                   | N |                               |                |                |

### Nylon 6.6

#### Standard Cross Section

|                   |     |     |      |     |      |     |      |     |      |     |      |    |    |     |                   |     |      |
|-------------------|-----|-----|------|-----|------|-----|------|-----|------|-----|------|----|----|-----|-------------------|-----|------|
| <b>PRWP1S-C</b>   | 5.2 | 132 | .190 | 4.8 | .052 | 1.3 | .250 | 6.4 | .105 | 2.7 | 1.00 | 25 | 50 | 222 | Hand install only | 100 | 1000 |
| <b>PRWP1SA-D</b>  | 5.1 | 130 | .190 | 4.8 | .052 | 1.3 | .187 | 4.7 | .093 | 2.4 | 1.00 | 25 | 50 | 222 |                   | 500 | 5000 |
| <b>PRWP1SB-D</b>  | 5.2 | 132 | .190 | 4.8 | .052 | 1.3 | .187 | 4.7 | .157 | 4.0 | 1.00 | 25 | 50 | 222 |                   | 500 | 5000 |
| <b>PRWP1.5S-D</b> | 6.8 | 173 | .190 | 4.8 | .052 | 1.3 | .250 | 6.4 | .105 | 2.7 | 1.50 | 38 | 50 | 222 |                   | 500 | 5000 |
| <b>PRWP2S-D</b>   | 7.8 | 198 | .190 | 4.8 | .052 | 1.3 | .250 | 6.4 | .105 | 2.7 | 1.75 | 45 | 50 | 222 |                   | 500 | 5000 |

#### Light-Heavy Cross Section

|                  |     |     |      |     |      |     |      |     |      |     |      |    |     |     |                   |     |      |
|------------------|-----|-----|------|-----|------|-----|------|-----|------|-----|------|----|-----|-----|-------------------|-----|------|
| <b>PRWP2H-TL</b> | 8.9 | 226 | .300 | 7.6 | .075 | 1.9 | .266 | 6.8 | .105 | 2.7 | 2.00 | 51 | 120 | 534 | Hand install only | 250 | 2500 |
|------------------|-----|-----|------|-----|------|-----|------|-----|------|-----|------|----|-----|-----|-------------------|-----|------|

### Weather Resistant Nylon 6.6

#### Standard Cross Section

|                    |     |     |      |     |      |     |      |     |      |     |      |    |    |     |                   |     |      |
|--------------------|-----|-----|------|-----|------|-----|------|-----|------|-----|------|----|----|-----|-------------------|-----|------|
| <b>PRWP1S-D0</b>   | 5.2 | 132 | .190 | 4.8 | .052 | 1.3 | .250 | 6.4 | .105 | 2.7 | 1.00 | 25 | 50 | 222 | Hand install only | 500 | 5000 |
| <b>PRWP1.5S-D0</b> | 6.8 | 173 | .190 | 4.8 | .052 | 1.3 | .250 | 6.4 | .105 | 2.7 | 1.50 | 38 | 50 | 222 |                   | 500 | 5000 |
| <b>PRWP2S-D0</b>   | 7.8 | 198 | .190 | 4.8 | .052 | 1.3 | .250 | 6.4 | .105 | 2.7 | 1.75 | 45 | 50 | 222 |                   | 500 | 5000 |

### Heat Stabilized Nylon 6.6

#### Standard Cross Section

|                     |     |     |      |     |      |     |      |     |      |     |      |    |    |     |                   |     |      |
|---------------------|-----|-----|------|-----|------|-----|------|-----|------|-----|------|----|----|-----|-------------------|-----|------|
| <b>PRWP1.5S-D30</b> | 6.8 | 173 | .190 | 4.8 | .052 | 1.3 | .250 | 6.4 | .105 | 2.7 | 1.50 | 38 | 50 | 222 | Hand install only | 500 | 5000 |
|---------------------|-----|-----|------|-----|------|-----|------|-----|------|-----|------|----|----|-----|-------------------|-----|------|

Note: UL Recognized and CSA Certified except PRWP2H.



## Pan-Ty® Center Mounted Wing Push Mount Ties – Heat Stabilized Nylon 6.6

- For high temperature applications up to 239°F (115°C) – indoor use
- Used to center the bundle over the mount on all bundle diameters
- Cable tie, mount, and fastener in a single part
- Anchor is easily pressed into a pre-formed hole and locks in place

- Wings provide constant tension for a stable, secure, and rattle-free installation
- Curved tip is easy to pick up from flat surfaces and allows faster initial threading to speed installation



**PLWP-SC** – Designed for normal wire bundles.

**PLWP-SD** – Designed for corrugated loom tubing. Bump prevents lateral and axial movement.

**PLWP-SE** – Designed for corrugated loom tubing, see page C3.11. Bump prevents lateral movement.

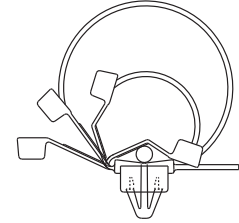

**Bundle diameters from .12" to 1.97" (3mm to 50mm)**

| Part Number                   | Length |     | Width |     | Thickness |     | Nominal Hole Dia. |     | Max. Panel Thickness |     | Max. Bundle Dia. |    | Min. Loop Tensile Str. |     | Recommended Installation Tool                          | Std. Pkg. Qty. | Std. Ctn. Qty. |  |
|-------------------------------|--------|-----|-------|-----|-----------|-----|-------------------|-----|----------------------|-----|------------------|----|------------------------|-----|--|----------------|----------------|--|
|                               | In.    | mm  | In.   | mm  | In.       | mm  | In.               | mm  | In.                  | mm  | In.              | mm | Lbs.                   | N   |  |                |                |  |
| <b>Standard Cross Section</b> |        |     |       |     |           |     |                   |     |                      |     |                  |    |                        |     |  |                |                |  |
| <b>PLWP30SC-D30</b>           | 5.8    | 147 | .190  | 4.8 | .050      | 1.3 | .266              | 6.8 | .118                 | 3.0 | 1.18             | 30 | 50                     | 222 | GTS, GTSL, GS2B, GTH, GS4H, PTS, PTH, PPTS, STS2, STH2 | 500            | 5000           |  |
| <b>PLWP40SC-D30</b>           | 7.0    | 178 | .190  | 4.8 | .050      | 1.3 | .266              | 6.8 | .118                 | 3.0 | 1.58             | 40 | 50                     | 222 |  | 500            | 5000           |  |
| <b>PLWP40SD-D30</b>           | 7.0    | 178 | .190  | 4.8 | .050      | 1.3 | .266              | 6.8 | .118                 | 3.0 | 1.58             | 40 | 50                     | 222 |  | 500            | 5000           |  |
| <b>PLWP50SC-D30</b>           | 8.2    | 208 | .190  | 4.8 | .050      | 1.3 | .266              | 6.8 | .118                 | 3.0 | 1.97             | 50 | 50                     | 222 |  | 500            | 5000           |  |
| <b>PLWP50SE-D30</b>           | 8.2    | 208 | .190  | 4.8 | .050      | 1.3 | .266              | 6.8 | .118                 | 3.0 | 1.97             | 50 | 50                     | 222 |  | 500            | 5000           |  |

A. System Overview

B1. Cable Ties

B2. Cable Accessories

B3. Stainless Steel Ties

C1. Wiring Duct

C2. Surface Raceway

C3. Abrasion Protection

C4. Cable Management

D1. Terminals

D2. Power Connectors

D3. Grounding Connectors

E1. Labeling Systems

E2. Labels

E3. Pre-Printed & Write-On Markers

E4. Permanent Identification

E5. Lockout/Tagout & Safety Solutions

F. Index

A. System Overview



## Pan-Ty® Ladder Style Releasable Wing Push Mount Ties – Heat Stabilized Nylon 6.6

B1. Cable Ties

- For high temperature applications up to 239°F (115°C) – indoor use
- Unique releasable ladder design eliminates the need for multiple clamp sizes
- Cable tie, mount, and fastener in a single part

- Used to attach bundles to another surface such as a flat panel
- Anchor is easily pressed into a pre-formed hole and locks in place
- Wings provide constant tension for a stable, secure, and rattle-free installation
- Curved tip is easy to pick up from flat surfaces and allows faster initial threading to speed installation

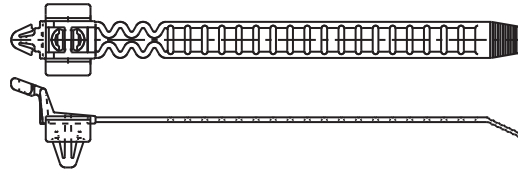
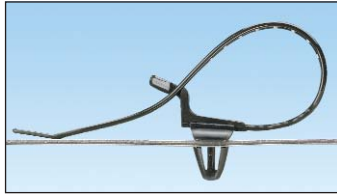

B3. Stainless Steel Ties

C1. Wiring Duct

C2. Surface Raceway

| Part Number                   | Length |     | Width |     | Thickness |     | Nominal Hole Dia. |     | Max. Panel Thickness |     | Max. Bundle Dia. |    | Min. Loop Tensile Str. |     | Recommended Installation Tool | Std. Pkg. Qty. | Std. Ctn. Qty. |
|-------------------------------|--------|-----|-------|-----|-----------|-----|-------------------|-----|----------------------|-----|------------------|----|------------------------|-----|-------------------------------|----------------|----------------|
|                               | In.    | mm  | In.   | mm  | In.       | mm  | In.               | mm  | In.                  | mm  | In.              | mm | Lbs.                   | N   |                               |                |                |
| <b>Standard Cross Section</b> |        |     |       |     |           |     |                   |     |                      |     |                  |    |                        |     |                               |                |                |
| <b>PRLWP30S-D30</b>           | 4.7    | 119 | .380  | 9.7 | .050      | 1.3 | .266              | 6.8 | .118                 | 3.0 | 1.43             | 36 | 35                     | 156 | Hand install only             | 500            | 5000           |
| <b>PRLWP50S-D30</b>           | 7.1    | 180 | .380  | 9.7 | .050      | 1.3 | .266              | 6.8 | .118                 | 3.0 | 2.18             | 55 | 35                     | 156 |                               | 500            | 5000           |

C3. Abrasion Protection

C4. Cable Management

## Pan-Ty® Umbrella Wing Push Mount Ties – Nylon and Heat Stabilized Nylon 6.6

- Natural nylon material for indoor use
- Heat stabilized material for high temperature applications up to 239°F (115°C) – indoor use
- Quick, secure way to fasten to clearance holes in panel
- Anchor is easily pressed into a pre-formed hole in a light gauge metal or plastic and locks in place

- Umbrella shaped disk provides constant tension for a stable, secure, and rattle-free installation
- Disk forms a dust-tight and semi-liquid tight seal to the panel surface
- PLUP40SE style is for use with corrugated loom tubing, see page C3.11
- Curved tip is easy to pick up from flat surfaces and allows faster initial threading to speed installation

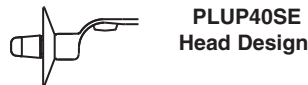
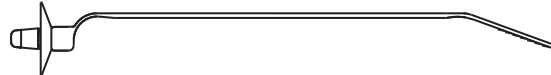

D1. Terminals

D2. Power Connectors

D3. Grounding Connectors

E1. Labeling Systems

E2. Labels

E3. Pre-Printed & Write-On Markers

E4. Permanent Identification

E5. Lockout/Tagout & Safety Solutions

F. Index

| Part Number                   | Length |     | Width |     | Thickness |     | Nominal Hole Dia. |     | Max. Panel Thickness |     | Max. Bundle Dia. |    | Min. Loop Tensile Str. |     | Recommended Installation Tool                          | Std. Pkg. Qty. | Std. Ctn. Qty. |
|-------------------------------|--------|-----|-------|-----|-----------|-----|-------------------|-----|----------------------|-----|------------------|----|------------------------|-----|--|----------------|----------------|
|                               | In.    | mm  | In.   | mm  | In.       | mm  | In.               | mm  | In.                  | mm  | In.              | mm | Lbs.                   | N   |  |                |                |
| <b>Standard Cross Section</b> |        |     |       |     |           |     |                   |     |                      |     |                  |    |                        |     |  |                |                |
| <b>PLUP40S-D30*</b>           | 7.0    | 177 | .190  | 4.8 | .047      | 1.2 | .266              | 6.8 | .050                 | 1.3 | 1.57             | 40 | 50                     | 222 | GTS, GTSL, GS2B, GTH, GS4H, PTS, PTH, PPTS, STS2, STH2 | 500            | 5000           |
| <b>PLUP40SE-D</b>             | 7.0    | 177 | .190  | 4.8 | .047      | 1.2 | .266              | 6.8 | .050                 | 1.3 | 1.57             | 40 | 50                     | 222 |  | 500            | 5000           |
| <b>PLUP40SE-D30*</b>          | 7.0    | 177 | .190  | 4.8 | .047      | 1.2 | .266              | 6.8 | .050                 | 1.3 | 1.57             | 40 | 50                     | 222 |  | 500            | 5000           |

\*Heat stabilized material (30).

## Pan-Ty® Push Mount Ties

- Natural nylon material for indoor use
- Weather resistant material has greater resistance to damage caused by ultraviolet light – indoor or outdoor use
- Heat stabilized material for high temperature applications up to 239°F (115°C) – indoor use
- *Wingless* design allows tie to be used in confined spaces

- Cable tie, mount, and fastener in a single part
- Economical push mount ties are used to attach bundles to another surface such as a flat panel
- Anchor is easily pressed into a pre-formed hole and locks in place
- Curved tip is easy to pick up from flat surfaces and allows faster initial threading to speed installation

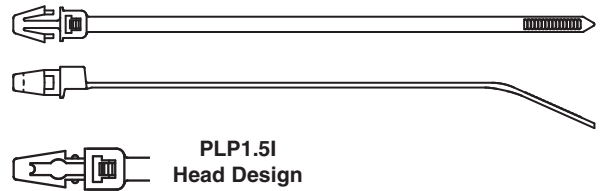
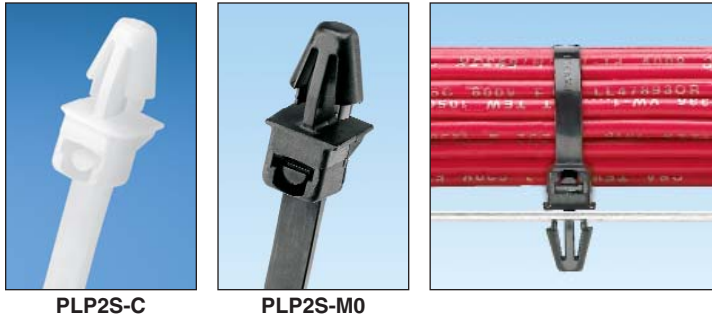

| Part Number | Length |    | Width |    | Thickness |    | Nominal Hole Dia. |    | Max. Panel Thickness |    | Max. Bundle Dia. |    | Min. Loop Tensile Str. |   | Recommended Installation Tool | Std. Pkg. Qty. | Std. Ctn. Qty. |
|-------------|--------|----|-------|----|-----------|----|-------------------|----|----------------------|----|------------------|----|------------------------|---|-------------------------------|----------------|----------------|
|             | In.    | mm | In.   | mm | In.       | mm | In.               | mm | In.                  | mm | In.              | mm | Lbs.                   | N |                               |                |                |

### Nylon 6.6

#### Intermediate Cross Section

|           |     |     |      |     |      |     |      |     |      |     |      |    |    |     |                                  |     |      |
|-----------|-----|-----|------|-----|------|-----|------|-----|------|-----|------|----|----|-----|----------------------------------|-----|------|
| PLP1.5I-C | 6.1 | 156 | .135 | 3.4 | .045 | 1.1 | .187 | 4.7 | .093 | 2.4 | 1.25 | 32 | 40 | 178 | GTS, GTSL, GS2B, PTS, PPTS, STS2 | 100 | 1000 |
|-----------|-----|-----|------|-----|------|-----|------|-----|------|-----|------|----|----|-----|----------------------------------|-----|------|

#### Standard Cross Section

|                |     |     |      |     |      |     |      |     |      |     |      |    |    |     |  |      |       |
|----------------|-----|-----|------|-----|------|-----|------|-----|------|-----|------|----|----|-----|--|------|-------|
| <b>PLP1S-M</b> | 5.3 | 135 | .180 | 4.6 | .050 | 1.3 | .250 | 6.4 | .125 | 3.2 | 1.00 | 25 | 50 | 222 | GTS, GTSL, GS2B, GTH, GS4H, PTS, PTH, PPTS, STS2, STH2 | 1000 | 10000 |
| PLP1.5S-M      | 6.7 | 170 | .180 | 4.6 | .050 | 1.3 | .250 | 6.4 | .125 | 3.2 | 1.50 | 38 | 50 | 222 |  | 1000 | 10000 |
| PLP2S-C        | 7.9 | 200 | .180 | 4.6 | .050 | 1.3 | .250 | 6.4 | .125 | 3.2 | 1.75 | 45 | 50 | 222 |  | 100  | 1000  |

### Weather Resistant Nylon 6.6

#### Intermediate Cross Section

|            |     |     |      |     |      |     |      |     |      |     |      |    |    |     |                                  |      |       |
|------------|-----|-----|------|-----|------|-----|------|-----|------|-----|------|----|----|-----|----------------------------------|------|-------|
| PLP1.5I-M0 | 6.1 | 156 | .135 | 3.4 | .045 | 1.1 | .187 | 4.7 | .093 | 2.4 | 1.25 | 32 | 40 | 178 | GTS, GTSL, GS2B, PTS, PPTS, STS2 | 1000 | 25000 |
|------------|-----|-----|------|-----|------|-----|------|-----|------|-----|------|----|----|-----|----------------------------------|------|-------|

#### Standard Cross Section

|                 |     |     |      |     |      |     |      |     |      |     |      |    |    |     |  |      |       |
|-----------------|-----|-----|------|-----|------|-----|------|-----|------|-----|------|----|----|-----|--|------|-------|
| PLP1S-M0        | 5.3 | 135 | .180 | 4.6 | .050 | 1.3 | .250 | 6.4 | .125 | 3.2 | 1.00 | 25 | 50 | 222 | GTS, GTSL, GS2B, GTH, GS4H, PTS, PTH, PPTS, STS2, STH2 | 1000 | 10000 |
| <b>PLP2S-M0</b> | 7.9 | 200 | .180 | 4.6 | .050 | 1.3 | .250 | 6.4 | .125 | 3.2 | 1.75 | 45 | 50 | 222 |  | 1000 | 10000 |

### Heat Stabilized Nylon 6.6

#### Intermediate Cross Section

|             |     |     |      |     |      |     |      |     |      |     |      |    |    |     |                                  |      |       |
|-------------|-----|-----|------|-----|------|-----|------|-----|------|-----|------|----|----|-----|----------------------------------|------|-------|
| PLP1.5I-M30 | 6.1 | 156 | .135 | 3.4 | .045 | 1.1 | .187 | 4.7 | .093 | 2.4 | 1.25 | 32 | 40 | 178 | GTS, GTSL, GS2B, PTS, PPTS, STS2 | 1000 | 25000 |
|-------------|-----|-----|------|-----|------|-----|------|-----|------|-----|------|----|----|-----|----------------------------------|------|-------|

#### Standard Cross Section

|           |     |     |      |     |      |     |      |     |      |     |      |    |    |     |  |      |       |
|-----------|-----|-----|------|-----|------|-----|------|-----|------|-----|------|----|----|-----|--|------|-------|
| PLP1S-M30 | 5.3 | 135 | .180 | 4.6 | .050 | 1.3 | .250 | 6.4 | .125 | 3.2 | 1.00 | 25 | 50 | 222 | GTS, GTSL, GS2B, GTH, GS4H, PTS, PTH, PPTS, STS2, STH2 | 1000 | 10000 |
| PLP2S-M30 | 7.9 | 200 | .180 | 4.6 | .050 | 1.3 | .250 | 6.4 | .125 | 3.2 | 1.75 | 45 | 50 | 222 |  | 1000 | 10000 |

A.  
System  
Overview

B1.  
Cable Ties

B2.  
Cable  
Accessories

B3.  
Stainless  
Steel Ties

C1.  
Wiring  
Duct

C2.  
Surface  
Raceway

C3.  
Abrasion  
Protection

C4.  
Cable  
Management

D1.  
Terminals

D2.  
Power  
Connectors

D3.  
Grounding  
Connectors

E1.  
Labeling  
Systems

E2.  
Labels

E3.  
Pre-Printed  
& Write-On  
Markers

E4.  
Permanent  
Identification

E5.  
Lockout/  
Tagout  
& Safety  
Solutions

F.  
Index

A. System Overview



## Pan-Ty® Marker and Flag Ties

- Natural nylon material for indoor use
- Weather resistant material has greater resistance to damage caused by ultraviolet light – indoor or outdoor use
- Flame retardant material has a flammability rating of UL 94V-0 – for indoor use
- Used to fasten and identify bundles at the same time
- One-piece construction for consistent performance and reliability
- Can be marked with Panduit marker pens on page B1.51 or computer printable labels
- Custom imprinting with text, symbols, or trademarks available using Panduit Custom Hot Stamping Service, see page B1.93
- Curved tip is easy to pick up from flat surfaces and allows faster initial threading to speed installation

B1. Cable Ties

B2. Cable Accessories

B3. Stainless Steel Ties

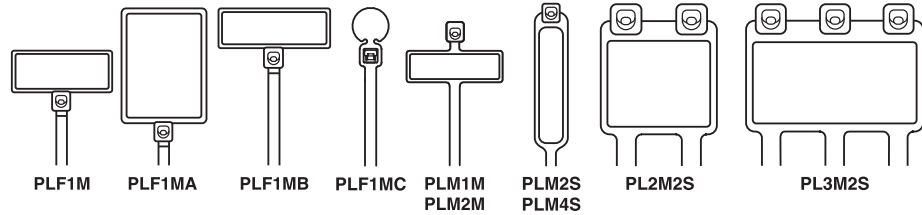
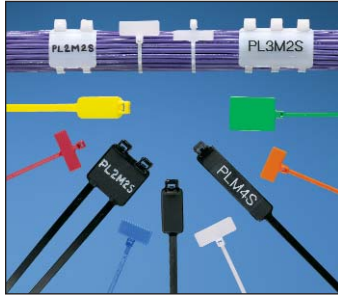

C1. Wiring Duct

C2. Surface Raceway

C3. Abrasion Protection

C4. Cable Management

D1. Terminals

D2. Power Connectors

D3. Grounding Connectors

E1. Labeling Systems

E2. Labels

E3. Pre-Printed & Write-On Markers

E4. Permanent Identification

E5. Lockout/Tagout & Safety Solutions

F. Index

| Part Number | Marker Type | Length |    | Width |    | Thickness |    | Marker Write-On Area |    | Max. Bundle Dia. |    | Min. Loop Tensile Str. |   | Recommended Installation Tool | Std. Pkg. Qty. | Std. Ctn. Qty. |
|-------------|-------------|--------|----|-------|----|-----------|----|----------------------|----|------------------|----|------------------------|---|-------------------------------|----------------|----------------|
|             |             | In.    | mm | In.   | mm | In.       | mm | In.                  | mm | In.              | mm | Lbs.                   | N |                               |                |                |

### Nylon 6.6

#### Miniature Cross Section

|                 |      |     |     |      |     |      |     |            |             |      |    |    |    |                                  |      |       |
|-----------------|------|-----|-----|------|-----|------|-----|------------|-------------|------|----|----|----|----------------------------------|------|-------|
| <b>PLF1M-C</b>  | Flag | 4.3 | 109 | .098 | 2.5 | .045 | 1.1 | .31 x .75  | 7.9 x 19.1  | .87  | 22 | 18 | 80 | GTS, GTSL, GS2B, PTS, PPTS, STS2 | 100  | 1000  |
| <b>PLF1MA-C</b> | Flag | 5.1 | 130 | .098 | 2.5 | .045 | 1.1 | .76 x 1.04 | 19.1 x 26.4 | .87  | 22 | 18 | 80 |                                  | 100  | 1000  |
| <b>PLF1MB-C</b> | Flag | 4.0 | 101 | .098 | 2.5 | .045 | 1.1 | .31 x .92  | 7.9 x 23.4  | .75  | 19 | 18 | 80 |                                  | 100  | 1000  |
| <b>PLF1MC-M</b> | Flag | 4.3 | 109 | .098 | 2.5 | .045 | 1.1 | .29 x .32  | 7.4 x 8.0   | .87  | 22 | 18 | 80 |                                  | 1000 | 25000 |
| <b>PLM1M-C</b>  | Wrap | 3.9 | 99  | .098 | 2.5 | .035 | .9  | .26 x .95  | 6.6 x 24.1  | .75  | 19 | 18 | 80 |                                  | 100  | 1000  |
| <b>PLM2M-C</b>  | Wrap | 8.0 | 203 | .098 | 2.5 | .035 | .9  | .26 x .95  | 6.6 x 24.1  | 2.00 | 51 | 18 | 80 |                                  | 100  | 1000  |

#### Standard Cross Section

|                 |      |      |     |      |     |      |     |            |             |      |     |    |     |  |     |      |
|-----------------|------|------|-----|------|-----|------|-----|------------|-------------|------|-----|----|-----|--|-----|------|
| <b>PLM2S-C</b>  | Wrap | 7.4  | 188 | .185 | 4.7 | .052 | 1.3 | .44 x .87  | 11.1 x 22.1 | 1.75 | 45  | 50 | 222 | GTS, GTSL, GS2B, GTH, GS4H, PTS, PTH, PPTS, STS2, STH2 | 100 | 1000 |
| <b>PLM4S-C</b>  | Wrap | 14.6 | 371 | .185 | 4.7 | .052 | 1.3 | .44 x 2.00 | 11.1 x 50.8 | 4.00 | 102 | 50 | 222 |  | 100 | 1000 |
| <b>PL2M2S-L</b> | Wrap | 7.4  | 188 | .185 | 4.7 | .052 | 1.3 | .87 x 1.07 | 22.1 x 27.2 | 1.75 | 45  | 50 | 222 |  | 50  | 500  |
| <b>PL3M2S-L</b> | Wrap | 7.4  | 188 | .185 | 4.7 | .052 | 1.3 | .87 x 1.79 | 22.1 x 45.5 | 1.75 | 45  | 50 | 222 |  | 50  | 500  |

### Weather Resistant Nylon 6.6

#### Miniature Cross Section

|                  |      |     |     |      |     |      |     |            |             |      |    |    |    |                                  |      |       |
|------------------|------|-----|-----|------|-----|------|-----|------------|-------------|------|----|----|----|----------------------------------|------|-------|
| <b>PLF1M-C0</b>  | Flag | 4.3 | 109 | .098 | 2.5 | .045 | 1.1 | .31 x .75  | 7.9 x 19.1  | .87  | 22 | 18 | 80 | GTS, GTSL, GS2B, PTS, PPTS, STS2 | 100  | 1000  |
| <b>PLF1MA-M0</b> | Flag | 5.1 | 130 | .098 | 2.5 | .045 | 1.1 | .76 x 1.04 | 19.1 x 26.4 | .87  | 22 | 18 | 80 |                                  | 1000 | 10000 |
| <b>PLM1M-C0</b>  | Wrap | 3.9 | 99  | .098 | 2.5 | .035 | .9  | .26 x .95  | 6.6 x 24.1  | .75  | 19 | 18 | 80 |                                  | 100  | 1000  |
| <b>PLM2M-M0</b>  | Wrap | 8.0 | 203 | .098 | 2.5 | .035 | .9  | .26 x .95  | 6.6 x 24.1  | 2.00 | 51 | 18 | 80 |                                  | 1000 | 25000 |

#### Standard Cross Section

|                  |      |      |     |      |     |      |     |            |             |      |     |    |     |  |     |      |
|------------------|------|------|-----|------|-----|------|-----|------------|-------------|------|-----|----|-----|--|-----|------|
| <b>PLM2S-C0</b>  | Wrap | 7.4  | 188 | .185 | 4.7 | .052 | 1.3 | .44 x .87  | 11.1 x 22.1 | 1.75 | 45  | 50 | 222 | GTS, GTSL, GS2B, GTH, GS4H, PTS, PTH, PPTS, STS2, STH2 | 100 | 1000 |
| <b>PLM4S-D0</b>  | Wrap | 14.6 | 371 | .185 | 4.7 | .052 | 1.3 | .44 x 2.00 | 11.1 x 50.8 | 4.00 | 102 | 50 | 222 |  | 500 | 5000 |
| <b>PL2M2S-L0</b> | Wrap | 7.4  | 188 | .185 | 4.7 | .052 | 1.3 | .87 x 1.07 | 22.1 x 27.2 | 1.75 | 45  | 50 | 222 |  | 50  | 500  |
| <b>PL3M2S-D0</b> | Wrap | 7.4  | 188 | .185 | 4.7 | .052 | 1.3 | .87 x 1.79 | 22.1 x 45.5 | 1.75 | 45  | 50 | 222 |  | 500 | 2500 |

### Flame Retardant Nylon 6.6

#### Miniature Cross Section

|                  |      |     |     |      |     |      |     |           |            |     |    |    |    |                                  |      |       |
|------------------|------|-----|-----|------|-----|------|-----|-----------|------------|-----|----|----|----|----------------------------------|------|-------|
| <b>PLF1M-M69</b> | Flag | 4.3 | 109 | .098 | 2.5 | .045 | 1.1 | .31 x .75 | 7.9 x 19.1 | .87 | 22 | 18 | 80 | GTS, GTSL, GS2B, PTS, PPTS, STS2 | 1000 | 25000 |
| <b>PLM1M-M69</b> | Wrap | 3.9 | 99  | .098 | 2.5 | .035 | .9  | .26 x .95 | 6.6 x 24.1 | .75 | 19 | 18 | 80 |                                  | 1000 | 25000 |



## Pan-Ty® Cable Ties

### Material and Color Chart

| Material                                       | Color          | Panduit Suffix |
|--|----------------|----------------|
| Nylon 6.6                                      | Natural        | ✓              |
| Weather Resistant Nylon 6.6                    | Black          | 0              |
| Weather Resistant Nylon 6.6 (meets Mil. Spec.) | Black          | 00             |
| Nylon 6.6                                      | Brown          | 1              |
| Nylon 6.6                                      | Red            | 2              |
| Nylon 6.6                                      | Orange         | 3              |
| Nylon 6.6                                      | Yellow         | 4Y             |
| Nylon 6.6                                      | Green          | 5              |
| Nylon 6.6                                      | Blue           | 6              |
| Nylon 6.6                                      | Purple         | 7              |
| Nylon 6.6                                      | Gray           | 8              |
| Nylon 6.6                                      | White          | 10             |
| Nylon 6.6                                      | Telephone Gray | 14             |
| Nylon 6.6                                      | Black          | 20             |
| Heat Stabilized Nylon 6.6                      | Black          | 30             |

| Material                                    | Color              | Panduit Suffix |
|---|--------------------|----------------|
| Heat Stabilized Nylon 6.6                   | Natural            | 39             |
| Nylon 6.6                                   | Fluorescent Orange | 53             |
| Nylon 6.6                                   | Fluorescent Yellow | 54             |
| Nylon 6.6                                   | Fluorescent Green  | 55             |
| Nylon 6.6                                   | Fluorescent Pink   | 59             |
| Flame Retardant Nylon 6.6                   | Black              | 60             |
| Flame Retardant Nylon 6.6                   | Natural (Ivory)    | 69             |
| PEEK (Polyetheretherketone)                 | Translucent Brown  | 71             |
| TEFZEL <sup>■</sup>                         | Aqua Blue          | 76             |
| Metal Detectable, Nylon                     | Blue               | 86             |
| Metal Detectable, Polypropylene             | Blue               | 186            |
| Weather Resistant Polypropylene             | Black              | 100            |
| Polypropylene                               | Green              | 109            |
| Nylon 12                                    | Black              | 120            |
| Heat Stabilized Weather Resistant Nylon 6.6 | Black              | 300            |
| HALAR <sup>▲</sup>                          | Maroon             | 702Y           |

✓Denotes Panduit Natural Nylon 6.6 (no suffix).

■TEFZEL is a registered trademark of E.I. du Pont de Nemours and Company.

▲HALAR is a registered trademark of Ausimont USA, Inc.

### Part Number Availability List

| Standard Packaging |                   |                       | Bulk Packaging |                   |                          |
|--------------------|-------------------|-----------------------|----------------|-------------------|--------------------------|
| Part Number        | Natural Nylon 6.6 | Material/Color Suffix | Part Number    | Natural Nylon 6.6 | Material/Color Suffix    |
| PLC1M-S4-C         | ✓                 | 0                     | PLC1M-S4-M     | ✓                 | 0,30                     |
| PLC1.5I-S8-C       | ✓                 | 0                     | PLC1.5I-S8-M   | ✓                 | 0,30                     |
| PLC2S-S6-C         | ✓                 | 0                     | PLC2S-S6-M     | ✓                 | 0                        |
| PLC2S-S10-C        | ✓                 | 0,14                  | PLC2S-S10-M    | ✓                 | 0,20,30                  |
| PLC3S-S10-C        | ✓                 | 0                     | PLC3S-S10-M    | ✓                 | 0                        |
| PLC4S-S10-C        | ✓                 | 0                     | PLC4S-S10-M    | ✓                 | 0,30                     |
| PLC2H-S25-L        | ✓                 |                       | PLC2H-S25-TL   | ✓                 | 0,30                     |
| PLC4H-S25-L        | ✓                 | 0                     | PLC4H-S25-TL   | ✓                 | 0,30                     |
| PLF1M-C            | ✓                 | 0                     | PLF1M-M        | ✓                 | 0,2,3,4Y,6,10,69         |
| PLF1MA-C           | ✓                 | 3,4Y                  | PLF1MA-M       | ✓                 | 0,2,3,4Y,5,6,10          |
| PLF1MB-C           | ✓                 |                       | PLF1MB-M       | ✓                 |                          |
|                    |                   |                       | PLF1MC-M       |                   | 3                        |
| PLM1M-C            | ✓                 | 0                     | PLM1M-M        | ✓                 | 0,1,2,3,4Y,5,6,7,8,10,69 |
| PLM2M-C            | ✓                 |                       | PLM2M-M        | ✓                 | 0,4Y,6                   |
| PLM2S-C            | ✓                 | 0,4Y                  | PLM2S-D        | ✓                 | 0,2,3,4Y,5,6,8           |
| PLM4S-C            | ✓                 |                       | PLM4S-D        | ✓                 | 0,2,4Y,6                 |

List continues on page B1.36

A. System Overview

## Pan-Ty® Cable Ties (continued)

B1. Cable Ties

B2. Cable Accessories

B3. Stainless Steel Ties

C1. Wiring Duct

C2. Surface Raceway

C3. Abrasion Protection

C4. Cable Management

D1. Terminals

D2. Power Connectors

D3. Grounding Connectors

E1. Labeling Systems

E2. Labels

E3. Pre-Printed & Write-On Markers

E4. Permanent Identification

E5. Lockout/Tagout & Safety Solutions

F. Index

| Standard Packaging |                   |  | Bulk Packaging |                   |   |
|--------------------|-------------------|--|----------------|-------------------|---|
| Part Number        | Natural Nylon 6.6 | Material/Color Suffix                            | Part Number    | Natural Nylon 6.6 | Material/Color Suffix   |
| PL2M2S-L           | ✓                 | 0  | PL2M2S-D       | ✓                 | 0,4Y,10   |
| PL3M2S-L           | ✓                 |  | PL3M2S-D       | ✓                 | 0,4Y  |
| PLP1.5I-C          | ✓                 |  | PLP1.5I-M      | ✓                 | 0,30  |
|                    |                   |  | PLP1S-M        | ✓                 | 0,30  |
|                    |                   |  | PLP1.5S-M      | ✓                 |   |
| PLP2S-C            | ✓                 |  | PLP2S-M        | ✓                 | 0,30  |
| PLT.6SM-C          | ✓                 | 0  | PLT.6SM-M      | ✓                 | 0,30  |
| PLT.7M-C           | ✓                 |  | PLT.7M-M       | ✓                 | 0,30  |
| PLT1M-C            | ✓                 | 0,00,1,2,3,4Y,5,6,7,8,10,14,30,71,76,86,186,702Y | PLT1M-M        | ✓                 | 0,00,1,2,3,4Y,5,6,7,8,10,14,20,30,53,54,55,59,60,69,76,100,109,300,702Y           |
|                    |                   |  | PLT1M-XMR      | ✓                 | 0,1,2,3,4Y,5,6,7,8,10,30  |
|                    |                   |  |                |                   |   |
| PLT1.5M-C          | ✓                 | 0  | PLT1.5M-M      | ✓                 | 0,00,1,2,3,4Y,5,6,7,8,10,14,20,30   |
|                    |                   |  | PLT1.5M-XMR    | ✓                 | 0,00,30   |
| PLT2M-C            | ✓                 | 0  | PLT2M-M        | ✓                 | 0,1,2,3,4Y,5,6,7,8,10,20,30,69  |
| PLT1.5I-C          | ✓                 | 0,1,2,3,4Y,5,6,7,8,10,20,30                      | PLT1.5I-M      | ✓                 | 0,00,1,2,3,4Y,5,6,7,8,10,20,30,69,100,109,120,300                                 |
| PLT2I-C            | ✓                 | 0,14,30,76,86,186                                | PLT2I-M        | ✓                 | 0,00,1,2,3,4Y,5,6,7,8,10,14,20,30,53,54,55,59,69,76,300                           |
| PLT2.5I-C          | ✓                 | 0  | PLT2.5I-M      | ✓                 | 0,20  |
| PLT3I-C            | ✓                 | 0,14   | PLT3I-M        | ✓                 | 0,2,3,4Y,5,6,8,10,14,20,30  |
| PLT4I-C            | ✓                 | 0,14   | PLT4I-M        | ✓                 | 0,2,5,6,14,20,30  |
| PLT1S-C            | ✓                 | 0  | PLT1S-M        | ✓                 | 0,30,38,300   |
| PLT1.5S-C          | ✓                 | 0  | PLT1.5S-M      | ✓                 | 0,30  |
| PLT2S-C            | ✓                 | 0,00,1,2,3,4Y,5,6,7,8,10,20,30,71,76,86,186,702Y | PLT2S-M        | ✓                 | 0,00,1,2,3,4Y,5,6,7,8,10,20,30,38,39,53,54,55,59,60,69,71,76,100,109,120,300,702Y |
|                    |                   |  | PLT2S-VMR      | ✓                 | 0,30  |
| PLT2.5S-C          | ✓                 | 0  | PLT2.5S-M      | ✓                 | 0,30  |
| PLT3S-C            | ✓                 | 0,00,2,20,30,76,86,186,702Y                      | PLT3S-M        | ✓                 | 0,00,1,2,3,4Y,5,6,7,8,10,20,30,53,54,55,59,76,100,109,702Y                        |
| PLT4S-C            | ✓                 | 0,00,2,3,4Y,5,6,8,20,30,76,86,186                | PLT4S-M        | ✓                 | 0,00,1,2,3,4Y,5,6,7,8,10,14,20,30,69,76,100,109,120,300                           |
| PLT4.5S-C          | ✓                 | 0  | PLT4.5S-M      | ✓                 | 0   |
| PLT5S-C            | ✓                 | 0  | PLT5S-M        | ✓                 | 0,2,3,4Y,5,6,8,30   |
| PLT6LH-L           | ✓                 | 0  | PLT6LH-C       | ✓                 | 0   |
| PLT7LH-L           | ✓                 | 0  | PLT7LH-C       | ✓                 | 0,30  |
| PLT8LH-L           | ✓                 | 0  | PLT8LH-C       | ✓                 | 0,120   |
| PLT8LH-Q           |                   | 0  |                |                   |   |
| PLT9LH-L           | ✓                 | 0  | PLT9LH-C       | ✓                 | 0,30  |
| PLT10LH-L          | ✓                 |  | PLT10LH-C      | ✓                 |   |
| PLT2H-L            | ✓                 | 0  | PLT2H-TL       | ✓                 | 0,2,4Y,6,30,100,109,300   |
| PLT2.5H-L          | ✓                 | 0  | PLT2.5H-TL     | ✓                 | 0   |
| PLT3H-L            | ✓                 | 0,76,86,186                                      | PLT3H-TL       | ✓                 | 0,30,76,100,109   |
| PLT4H-L            | ✓                 | 0,00,76,86,186                                   | PLT4H-TL       | ✓                 | 0,00,1,2,3,4Y,5,6,10,20,30,69,76,100,109,120,300                                  |
| PLT4H-C            | ✓                 | 0  |                |                   |   |
| PLT5H-L            | ✓                 | 0  | PLT5H-C        | ✓                 | 0,30  |
| PLT6H-L            | ✓                 | 0  | PLT6H-C        | ✓                 | 0,30  |
| PLT8H-L            | ✓                 | 0  | PLT8H-C        | ✓                 | 0,00,30   |
| PLT8H-L            | ✓                 | 0  |                |                   |   |
| PLT13H-Q           | ✓                 | 0  | PLT13H-C       | ✓                 | 0,3   |

| Standard Packaging |                   |                       | Bulk Packaging |                   |                       |
|--------------------|-------------------|-----------------------|----------------|-------------------|-----------------------|
| Part Number        | Natural Nylon 6.6 | Material/Color Suffix | Part Number    | Natural Nylon 6.6 | Material/Color Suffix |
| PLT2EH-Q           |                   | 0                     | PLT2EH-C       | ✓                 | 0                     |
|                    |                   |                       | PLT3EH-NB-C    |                   | 0                     |
| PLT5EH-Q           | ✓                 | 0                     | PLT5EH-C       | ✓                 | 0                     |
|                    |                   |                       | PLT5EH-NB-C    |                   | 0                     |
| PLT6EH-Q           | ✓                 | 0                     | PLT6EH-C       | ✓                 | 0                     |
|                    |                   |                       | PLT6EH-NB-C    |                   | 0                     |
| PLT8EH-Q           |                   | 0                     | PLT8EH-C       | ✓                 | 0                     |
| PLT10EH-Q          |                   | 0                     | PLT10EH-C      | ✓                 | 0                     |
| PLT12EH-Q          |                   | 0                     | PLT12EH-C      | ✓                 | 0                     |
|                    |                   |                       | PLUP40S-D      |                   | 30                    |
|                    |                   |                       | PLUP40SE-D     | ✓                 | 30                    |
| PLWP1M-C           | ✓                 |                       | PLWP1M-D       | ✓                 | 0,30                  |
| PLWP1.5I-C         | ✓                 |                       | PLWP1.5I-D     | ✓                 | 30                    |
| PLWP1S-C           | ✓                 | 0                     | PLWP1S-D       | ✓                 | 0,20,30               |
|                    |                   |                       | PLWP1SA-D      | ✓                 |                       |
|                    |                   |                       | PLWP1SB-D      | ✓                 |                       |
|                    |                   |                       | PLWP1.5S-D     | ✓                 | 30                    |
|                    |                   |                       | PLWP1.5SA-D    | ✓                 |                       |
| PLWP2S-C           | ✓                 | 0                     | PLWP2S-D       | ✓                 | 0,30                  |
|                    |                   |                       | PLWP2SA-D      | ✓                 |                       |
|                    |                   |                       | PLWP2SB-D      | ✓                 |                       |
|                    |                   |                       | PLWP2H-TL      | ✓                 | 0,30                  |
|                    |                   |                       | PLWP3H-TL      | ✓                 | 0                     |
|                    |                   |                       | PLWP30SC-D     |                   | 30                    |
|                    |                   |                       | PLWP40SC-D     |                   | 30                    |
|                    |                   |                       | PLWP40SD-D     |                   | 30                    |
|                    |                   |                       | PLWP50SC-D     |                   | 30                    |
|                    |                   |                       | PLWP50SE-D     |                   | 30                    |
|                    |                   |                       | PRLWP30S-D     |                   | 30                    |
|                    |                   |                       | PRLWP50S-D     |                   | 30                    |
| PRT1S-C            | ✓                 | 0                     | PRT1S-M        | ✓                 | 0                     |
| PRT1.5S-C          | ✓                 | 0                     | PRT1.5S-M      | ✓                 | 0,30                  |
| PRT2S-C            | ✓                 | 0                     | PRT2S-M        | ✓                 | 0,2,3,4Y,6,7          |
| PRT3S-C            | ✓                 | 0                     | PRT3S-M        | ✓                 | 0                     |
| PRT4S-C            | ✓                 | 0                     | PRT4S-M        | ✓                 | 0,2,3,4Y,6            |
| PRT2H-L            | ✓                 | 0                     | PRT2H-TL       | ✓                 | 0                     |
| PRT3H-L            | ✓                 | 0                     | PRT3H-TL       | ✓                 | 0                     |
| PRT4H-L            | ✓                 | 0                     | PRT4H-TL       | ✓                 | 0                     |
| PRT2EH-Q           |                   | 0                     | PRT2EH-C       | ✓                 | 0,100                 |
| PRT5EH-Q           | ✓                 | 0                     | PRT5EH-C       | ✓                 | 0,100                 |
| PRT6EH-Q           | ✓                 | 0                     | PRT6EH-C       | ✓                 | 0,100                 |
| PRT8EH-Q           |                   | 0                     | PRT8EH-C       | ✓                 | 0,100                 |
| PRT10EH-Q          |                   | 0                     | PRT10EH-C      | ✓                 | 0                     |
| PRT12EH-Q          |                   | 0                     | PRT12EH-C      | ✓                 | 0                     |
| PRWP1S-C           | ✓                 |                       | PRWP1S-D       | ✓                 | 0                     |
|                    |                   |                       | PRWP1SA-D      | ✓                 |                       |
|                    |                   |                       | PRWP1SB-D      | ✓                 |                       |
|                    |                   |                       | PRWP1.5S-D     | ✓                 | 0,20,30               |
|                    |                   |                       | PRWP2S-D       | ✓                 | 0                     |
|                    |                   |                       | PRWP2H-TL      | ✓                 |                       |

A.  
System  
Overview

B1.  
Cable  
Ties

B2.  
Cable  
Accessories

B3.  
Stainless  
Steel Ties

C1.  
Wiring  
Duct

C2.  
Surface  
Raceway

C3.  
Abrasion  
Protection

C4.  
Cable  
Management

D1.  
Terminals

D2.  
Power  
Connectors

D3.  
Grounding  
Connectors

E1.  
Labeling  
Systems

E2.  
Labels

E3.  
Pre-Printed  
& Write-On  
Markers

E4.  
Permanent  
Identification

E5.  
Lockout/  
Tagout  
& Safety  
Solutions

F.  
Index

A. System Overview

## Features and Benefits – Super-Grip® Cable Ties

One-piece design with a thin, wide strap body for improved flexibility.

B1. Cable Ties

Dome shaped head and smooth, round strap body protect the cable insulation

B2. Cable Accessories

B3. Stainless Steel Ties

C1. Wiring Duct

C2. Surface Raceway

C3. Abrasion Protection

C4. Cable Management

D1. Terminals

D2. Power Connectors

D3. Grounding Connectors

E1. Labeling Systems

E2. Labels

E3. Pre-Printed & Write-On Markers

E4. Permanent Identification

E5. Lockout/Tagout & Safety Solutions

F. Index

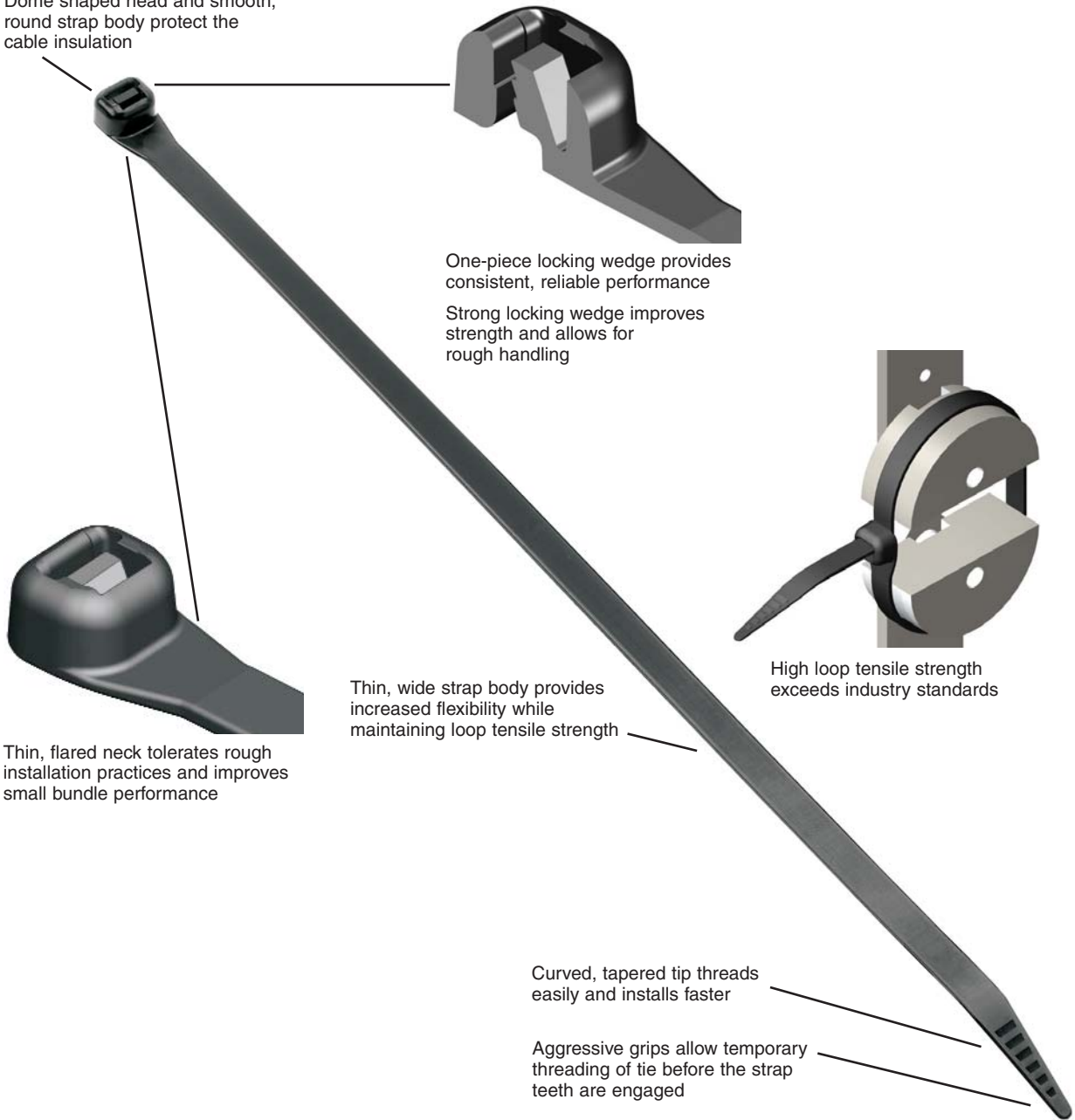

Cable tie tools speed installation and reduce total installed cost. See pages B1.107 – B1.112.



Cable tie accessories are used to speed and simplify the mounting of wires, cables, and tubing. See pages B2.7, B2.11, B2.13, B2.21.

## Selection Guide – Super-Grip® Cable Ties



| Material, Color (Suffix)               | Style/Function      | Part Number Prefix | Catalog Page |
|--|---------------------|--------------------|--------------|
| Nylon 6.6, Natural (No Suffix)         | Locking Ties/Bundle | SG                 | B1.40        |
| Weather Resistant Nylon 6.6, Black (0) | Locking Ties/Bundle | SG                 | B1.41        |
| Heat Stabilized Nylon 6.6, Black (30)  | Locking Ties/Bundle | SG                 | B1.41        |

## Part Number System for Super-Grip® Cable Ties

**SG**

Type

SG = Locking Tie

**200**

Length

Approx. Length (mm)

**S**

Cross Section

M = Miniature  
I = Intermediate  
S = Standard  
LH = Light-Heavy  
H = Heavy

—

**C**

Package Size

L = 50  
C = 100  
TL = 250  
M = 1000

—

Material/Color

See Page B1.42

A. System Overview

B1. Cable Ties

B2. Cable Accessories

B3. Stainless Steel Ties

C1. Wiring Duct

C2. Surface Raceway

C3. Abrasion Protection

C4. Cable Management

D1. Terminals

D2. Power Connectors

D3. Grounding Connectors

E1. Labeling Systems

E2. Labels

E3. Pre-Printed & Write-On Markers

E4. Permanent Identification

E5. Lockout/Tagout & Safety Solutions

F. Index



A.  
System  
Overview



## Super-Grip® Cable Ties – Nylon 6.6

B1.  
Cable Ties

- For indoor use
- Designed to grip the bundle tightly to resist lateral movement of the tie once installed
- High strength allows the tie to withstand rough installation practices that occur in MRO and construction environments
- Thin, wide strap body provides flexibility enabling it to conform to bundle while maintaining tensile strength

- Curved tip is easy to pick up from flat surfaces and allows faster initial threading to speed installation
- UL Listed for use in plenum or air handling spaces per NEC
- Complementary mounts available, see pages B2.7, B2.11, B2.13 and B2.21

B2.  
Cable  
Accessories

B3.  
Stainless  
Steel Ties

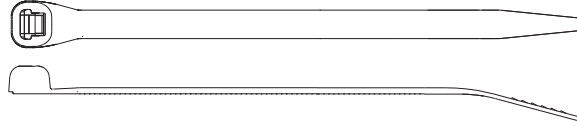

C1.  
Wiring  
Duct

C2.  
Surface  
Raceway

C3.  
Abrasion  
Protection

C4.  
Cable  
Management

D1.  
Terminals

D2.  
Power  
Connectors

D3.  
Grounding  
Connectors

E1.  
Labeling  
Systems

E2.  
Labels

E3.  
Pre-Printed  
& Write-On  
Markers

E4.  
Permanent  
Identification

E5.  
Lockout/  
Tagout/  
& Safety  
Solutions

F.  
Index

| Part Number                                      | Length |     | Width |     | Thickness |     | Max. Bundle Dia. |     | Min. Loop Tensile Str. |     | Recommended Installation Tool                          | Std. Pkg. Qty. | Std. Ctn. Qty. |
|--|--------|-----|-------|-----|-----------|-----|------------------|-----|------------------------|-----|--|----------------|----------------|
|  | In.    | mm  | In.   | mm  | In.       | mm  | In.              | mm  | Lbs.                   | N   |  |                |                |
| <b>Miniature Cross Section – Plenum-Rated</b>    |        |     |       |     |           |     |                  |     |                        |     |  |                |                |
| <b>SG100M-C</b>                                  | 4.2    | 106 | .118  | 3.0 | .038      | 1.0 | .90              | 23  | 18                     | 80  | GTS, GTSL, GS2B, PTS, PPTS, STS2                       | 100            | 1000           |
| <b>Intermediate Cross Section – Plenum-Rated</b> |        |     |       |     |           |     |                  |     |                        |     |  |                |                |
| <b>SG150I-C</b>                                  | 6.2    | 157 | .168  | 4.3 | .040      | 1.0 | 1.50             | 38  | 40                     | 178 | GTS, GTSL, GS2B, PTS, PPTS, STS2                       | 100            | 1000           |
| <b>Standard Cross Section – Plenum-Rated</b>     |        |     |       |     |           |     |                  |     |                        |     |  |                |                |
| <b>SG200S-C</b>                                  | 8.3    | 211 | .225  | 5.7 | .046      | 1.2 | 2.00             | 51  | 50                     | 222 | GTS, GTSL, GS2B, GTH, GS4H, PTS, PTH, PPTS, STS2, STH2 | 100            | 1000           |
| <b>SG250S-C</b>                                  | 10.4   | 264 | .225  | 5.7 | .050      | 1.3 | 2.60             | 66  | 75                     | 334 |  | 100            | 1000           |
| <b>SG300S-C</b>                                  | 12.4   | 315 | .225  | 5.7 | .050      | 1.3 | 3.20             | 81  | 75                     | 334 |  | 100            | 1000           |
| <b>SG370S-C</b>                                  | 15.3   | 389 | .225  | 5.7 | .052      | 1.3 | 4.20             | 107 | 75                     | 334 |  | 100            | 1000           |
| <b>Light-Heavy Cross Section – Plenum-Rated</b>  |        |     |       |     |           |     |                  |     |                        |     |  |                |                |
| <b>SG350LH-L</b>                                 | 15.3   | 389 | .330  | 8.4 | .064      | 1.6 | 4.13             | 105 | 120                    | 534 | GTH, GS4H, GS4EH, PTH, STH2, ST3EH                     | 50             | 500            |
| <b>Heavy Cross Section – Plenum-Rated</b>        |        |     |       |     |           |     |                  |     |                        |     |  |                |                |
| <b>SG450H-L</b>                                  | 18.6   | 471 | .380  | 9.7 | .068      | 1.7 | 5.20             | 132 | 175                    | 778 | GTH, GS4H, GS4EH, PTH, STH2, ST3EH                     | 50             | 500            |



## Super-Grip® Cable Ties – Weather Resistant and Heat Stabilized Nylon 6.6

- Weather resistant material has greater resistance to damage caused by ultraviolet light – indoor or outdoor use
- Heat stabilized material for high temperature applications up to 239°F (115°C) – indoor use
- Designed to grip the bundle tightly to resist lateral movement of the tie once installed

- High strength allows the tie to withstand rough installation practices that occur in MRO and construction environments
- Thin, wide strap body provides flexibility enabling it to conform to bundle while maintaining tensile strength
- Curved tip is easy to pick up from flat surfaces and allows faster initial threading to speed installation
- Complementary mounts available, see pages B2.7, B2.11, B2.13 and B2.21

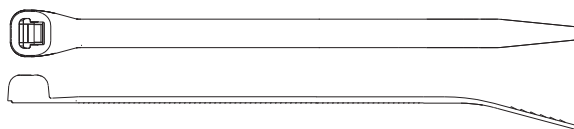

| Part Number | Length |    | Width |    | Thickness |    | Max. Bundle Dia. |    | Min. Loop Tensile Str. |   | Recommended Installation Tool | Std. Pkg. Qty. | Std. Ctn. Qty. |
|-------------|--------|----|-------|----|-----------|----|------------------|----|------------------------|---|-------------------------------|----------------|----------------|
|             | In.    | mm | In.   | mm | In.       | mm | In.              | mm | Lbs.                   | N |                               |                |                |

### Weather Resistant Nylon 6.6

#### Miniature Cross Section

|                  |     |     |      |     |      |     |     |    |    |    |                                  |     |      |
|------------------|-----|-----|------|-----|------|-----|-----|----|----|----|----------------------------------|-----|------|
| <b>SG100M-C0</b> | 4.2 | 106 | .118 | 3.0 | .038 | 1.0 | .90 | 23 | 18 | 80 | GTS, GTSL, GS2B, PTS, PPTS, STS2 | 100 | 1000 |
|------------------|-----|-----|------|-----|------|-----|-----|----|----|----|----------------------------------|-----|------|

#### Intermediate Cross Section

|                  |     |     |      |     |      |     |      |    |    |     |                                  |     |      |
|------------------|-----|-----|------|-----|------|-----|------|----|----|-----|----------------------------------|-----|------|
| <b>SG150I-C0</b> | 6.2 | 157 | .168 | 4.3 | .040 | 1.0 | 1.50 | 38 | 40 | 178 | GTS, GTSL, GS2B, PTS, PPTS, STS2 | 100 | 1000 |
|------------------|-----|-----|------|-----|------|-----|------|----|----|-----|----------------------------------|-----|------|

#### Standard Cross Section

|                  |      |     |      |     |      |     |      |     |    |     |  |     |      |
|------------------|------|-----|------|-----|------|-----|------|-----|----|-----|--|-----|------|
| <b>SG200S-C0</b> | 8.3  | 211 | .225 | 5.7 | .046 | 1.2 | 2.00 | 51  | 50 | 222 | GTS, GTSL, GS2B, GTH, GS4H, PTS, PTH, PPTS, STS2, STH2 | 100 | 1000 |
| <b>SG250S-C0</b> | 10.4 | 264 | .225 | 5.7 | .050 | 1.3 | 2.60 | 66  | 75 | 334 |  | 100 | 1000 |
| <b>SG300S-C0</b> | 12.4 | 315 | .225 | 5.7 | .050 | 1.3 | 3.20 | 81  | 75 | 334 |  | 100 | 1000 |
| <b>SG370S-C0</b> | 15.3 | 389 | .225 | 5.7 | .052 | 1.3 | 4.20 | 107 | 75 | 334 |  | 100 | 1000 |

#### Light-Heavy Cross Section

|                   |      |     |      |     |      |     |      |     |     |     |                                    |    |     |
|-------------------|------|-----|------|-----|------|-----|------|-----|-----|-----|------------------------------------|----|-----|
| <b>SG350LH-L0</b> | 15.3 | 389 | .330 | 8.4 | .064 | 1.6 | 4.13 | 105 | 120 | 534 | GTH, GS4H, GS4EH, PTH, STH2, ST3EH | 50 | 500 |
|-------------------|------|-----|------|-----|------|-----|------|-----|-----|-----|------------------------------------|----|-----|

#### Heavy Cross Section

|                  |      |     |      |     |      |     |      |     |     |     |                                    |    |     |
|------------------|------|-----|------|-----|------|-----|------|-----|-----|-----|------------------------------------|----|-----|
| <b>SG450H-L0</b> | 18.6 | 471 | .380 | 9.7 | .068 | 1.7 | 5.20 | 132 | 175 | 778 | GTH, GS4H, GS4EH, PTH, STH2, ST3EH | 50 | 500 |
|------------------|------|-----|------|-----|------|-----|------|-----|-----|-----|------------------------------------|----|-----|

### Heat Stabilized Nylon 6.6

#### Standard Cross Section

|                   |      |     |      |     |      |     |      |    |    |     |  |      |       |
|-------------------|------|-----|------|-----|------|-----|------|----|----|-----|--|------|-------|
| <b>SG200S-M30</b> | 8.3  | 211 | .225 | 5.7 | .046 | 1.2 | 2.00 | 51 | 50 | 222 | GTS, GTSL, GS2B, GTH, GS4H, PTS, PTH, PPTS, STS2, STH2 | 1000 | 10000 |
| <b>SG300S-M30</b> | 12.4 | 315 | .225 | 5.7 | .050 | 1.3 | 3.20 | 81 | 70 | 311 |  | 1000 | 10000 |

#### Light-Heavy Cross Section

|                     |      |     |      |     |      |     |      |     |     |     |                                    |     |      |
|---------------------|------|-----|------|-----|------|-----|------|-----|-----|-----|------------------------------------|-----|------|
| <b>SG350LH-TL30</b> | 15.3 | 389 | .330 | 8.4 | .064 | 1.6 | 4.13 | 105 | 120 | 534 | GTH, GS4H, GS4EH, PTH, STH2, ST3EH | 250 | 2500 |
|---------------------|------|-----|------|-----|------|-----|------|-----|-----|-----|------------------------------------|-----|------|

Note: UL Listed and CSA Certified except SG450H-L0 and heat stabilized material (30).

A.  
System  
Overview

B1.  
Cable  
Ties

B2.  
Cable  
Accessories

B3.  
Stainless  
Steel Ties

C1.  
Wiring  
Duct

C2.  
Surface  
Raceway

C3.  
Abrasion  
Protection

C4.  
Cable  
Management

D1.  
Terminals

D2.  
Power  
Connectors

D3.  
Grounding  
Connectors

E1.  
Labeling  
Systems

E2.  
Labels

E3.  
Pre-Printed  
& Write-On  
Markers

E4.  
Permanent  
Identification

E5.  
Lockout/  
Tagout/  
& Safety  
Solutions

F.  
Index

A.  
System  
Overview

## Super-Grip® Cable Ties and Mounts

B1.  
Cable Ties

### Material and Color Chart

| Material                    | Color   | Panduit Suffix |
|-----------------------------|---------|----------------|
| Nylon 6.6                   | Natural | ✓              |
| Weather Resistant Nylon 6.6 | Black   | 0              |
| Heat Stabilized Nylon 6.6   | Black   | 30             |

✓Denotes Panduit Natural Nylon 6.6 (no suffix).

B2.  
Cable  
Accessories

B3.  
Stainless  
Steel Ties

C1.  
Wiring  
Duct

### Part Number Availability List

|                               | Standard Packaging |                   |                       | Bulk Packaging |                   |                       |
|-------------------------------|--------------------|-------------------|-----------------------|----------------|-------------------|-----------------------|
|                               | Part Number        | Natural Nylon 6.6 | Material/Color Suffix | Part Number    | Natural Nylon 6.6 | Material/Color Suffix |
| C2.<br>Surface<br>Raceway     | SG100M-C           | ✓                 | 0                     | SG100M-M       | ✓                 | 0                     |
|                               | SG150I-C           | ✓                 | 0                     | SG150I-M       | ✓                 | 0                     |
| C3.<br>Abrasion<br>Protection | SG200S-C           | ✓                 | 0                     | SG200S-M       | ✓                 | 0,30                  |
|                               | SG250S-C           | ✓                 | 0                     |                |                   |                       |
| C4.<br>Cable<br>Management    | SG300S-C           | ✓                 | 0                     | SG300S-M       | ✓                 | 0,30                  |
|                               | SG370S-C           | ✓                 | 0                     | SG370S-M       | ✓                 | 0                     |
|                               | SG350LH-L          | ✓                 | 0                     | SG350LH-TL     | ✓                 | 0,30                  |
|                               | SG450H-L           | ✓                 | 0                     | SG450H-C       | ✓                 | 0                     |

D1.  
Terminals

D2.  
Power  
Connectors

D3.  
Grounding  
Connectors

E1.  
Labeling  
Systems

E2.  
Labels

E3.  
Pre-Printed  
& Write-On  
Markers

E4.  
Permanent  
Identification

E5.  
Lockout/  
Tagout  
& Safety  
Solutions

F.  
Index

## Features and Benefits – Dome-Top® Barb Ty Cable Ties

Two-piece design incorporates a stainless steel locking barb in a nylon cable tie.

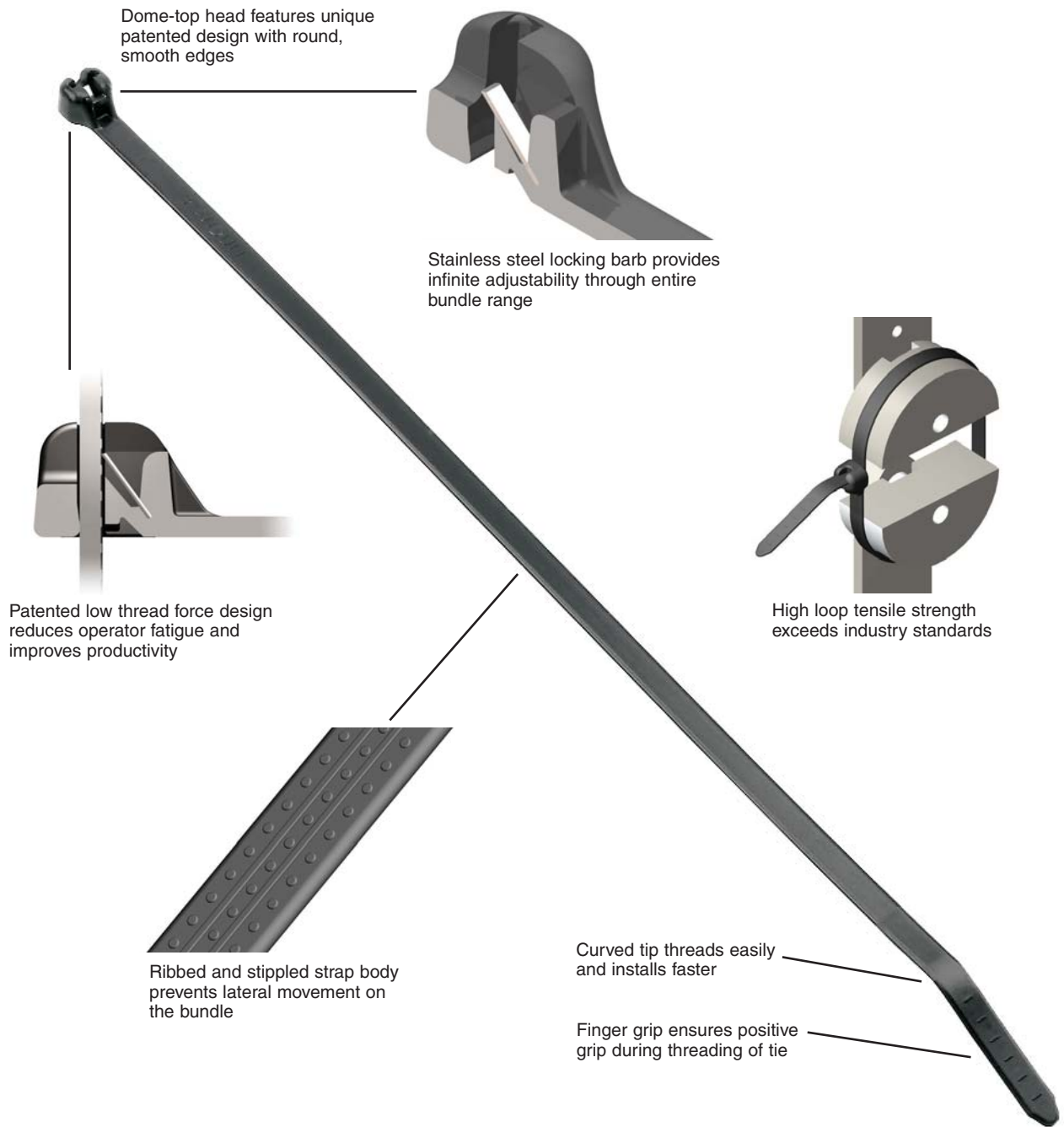

Dome-top head features unique patented design with round, smooth edges



Stainless steel locking barb provides infinite adjustability through entire bundle range



Patented low thread force design reduces operator fatigue and improves productivity



High loop tensile strength exceeds industry standards



Ribbed and stippled strap body prevents lateral movement on the bundle

Curved tip threads easily and installs faster

Finger grip ensures positive grip during threading of tie



Cable tie tools speed installation and reduce total installed cost. See pages B1.109 – B1.114.



Cable tie accessories are used to speed and simplify the mounting of wires, cables, and tubing. See pages B2.1 – B2.29.

A. System Overview

B1. Cable Ties

B2. Cable Accessories

B3. Stainless Steel Ties

C1. Wiring Duct

C2. Surface Raceway

C3. Abrasion Protection

C4. Cable Management

D1. Terminals

D2. Power Connectors

D3. Grounding Connectors

E1. Labeling Systems

E2. Labels

E3. Pre-Printed & Write-On Markers

E4. Permanent Identification

E5. Lockout/Tagout & Safety Solutions

F. Index

A. System Overview

## Selection Guide – Dome-Top® Barb Ty and Dura-Ty™ Cable Ties

B1. Cable Ties

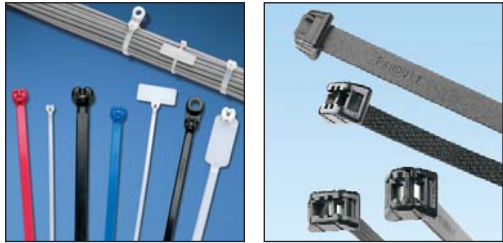

B2. Cable Accessories

B3. Stainless Steel Ties

C1. Wiring Duct

C2. Surface Raceway

C3. Abrasion Protection

C4. Cable Management

D1. Terminals

D2. Power Connectors

D3. Grounding Connectors

E1. Labeling Systems

E2. Labels

E3. Pre-Printed & Write-On Markers

E4. Permanent Identification

E5. Lockout/Tagout & Safety Solutions

F. Index

### Dome-Top® Barb Ty Cable Ties

| Material, Color (Suffix)                | Style/Function        | Part Number Prefix    | Catalog Page |
|---|-----------------------|-----------------------|--------------|
| Nylon 6.6, Natural (No Suffix)          | Locking Ties/Bundle   | BT                    | B1.45        |
|   | Clamp Ties/Mount      | BC                    | B1.48        |
|   | Push Mount Ties/Mount | BW                    | B1.50        |
|   | Marker Ties/Identify  | BF, BM, B2M, B3M, B4M | B1.52        |
| Weather Resistant Nylon 6.6, Black (0)  | Locking Ties/Bundle   | BT                    | B1.46        |
|   | Clamp Ties/Mount      | BC                    | B1.49        |
|   | Push Mount Ties/Mount | BW, BP                | B1.50,51     |
|   | Marker Ties/Identify  | BF, BM, B2M, B3M, B4M | B1.52        |
| Heat Stabilized Nylon 6.6, Black (30)   | Locking Ties/Bundle   | BT                    | B1.47        |
|   | Clamp Ties/Mount      | BC                    | B1.49        |
| Heat Stabilized Nylon 6.6, Natural (39) | Locking Ties/Bundle   | BT                    | B1.47        |

### Dura-Ty™ Cable Ties, Strapping, and Kits

|                                 |                     |    |       |
|---------------------------------|---------------------|----|-------|
| Weather Resistant Acetal, Black | Locking Ties/Bundle | DT | B1.53 |
|---------------------------------|---------------------|----|-------|

## Part Number System for Dome-Top® Barb Ty and Dura-Ty™ Cable Ties

| <b>BT</b>   | <b>2</b>                          | <b>S</b>   | <b>—</b>   | <b>C</b>  | <b>T</b>       |
|---|-----------------------------------|--|--|---|----------------|
| Type  | Size                              | Cross Section  | Screw Hole Size  | Package Size  | Material/Color |
| BT = Locking Tie<br>BC = Clamp Tie<br>BF = Flag Tie<br>BM = Marker Tie<br>BP = Push Mount Tie<br>BW = Wing Push Mount Tie<br>DT = Locking Tie | Approx. Maximum Bundle Dia. (In.) | M = Miniature<br>I = Intermediate<br>S = Standard<br>LH = Light-Heavy<br>H = Heavy<br>EH = Extra-Heavy | (Clamp Ties Only)<br>-S4 = #4 (M2.5)<br>-S6 = #6 (M3)<br>-S8 = #8 (M4)<br>-S10 = #10 (M5)<br>-S25 = 1/4 (M6) | Q = 25<br>L = 50<br>C = 100<br>TL = 250<br>D = 500<br>M = 1000<br>LR = 50' Reel | See Page B1.54 |





## Dome-Top® Barb Ty Cable Ties – Nylon 6.6

- For indoor use
- Dome-top head features unique patented design with round, smooth edges
- Stainless steel locking barb provides consistent performance, reliability, and infinite adjustability through entire bundle range

- High strength and low thread force
- A variety of materials and colors are available for specific applications
- Curved tip is easy to pick up from flat surfaces and allows faster initial threading to speed installation
- UL Listed for use in plenum or air handling spaces per NEC

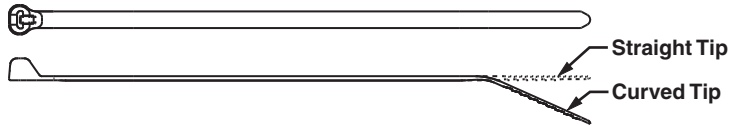

| Part Number | Length |    | Width |    | Thickness |    | Max. Bundle Dia. |    | Min. Loop Tensile Str. |   | Recommended Installation Tool | Std. Pkg. Qty. | Std. Ctn. Qty. |
|-------------|--------|----|-------|----|-----------|----|------------------|----|------------------------|---|-------------------------------|----------------|----------------|
|             | In.    | mm | In.   | mm | In.       | mm | In.              | mm | Lbs.                   | N |                               |                |                |

### Miniature Cross Section – Plenum-Rated

|                 |      |     |      |     |      |     |      |     |    |    |                                  |     |      |
|-----------------|------|-----|------|-----|------|-----|------|-----|----|----|----------------------------------|-----|------|
| <b>BT1M-C</b>   | 4.0  | 102 | .095 | 2.4 | .036 | .9  | .90  | 23  | 18 | 80 | GTS, GTSL, GS2B, PTS, PPTS, STS2 | 100 | 1000 |
| <b>BT1.5M-C</b> | 6.3  | 160 | .095 | 2.4 | .046 | 1.2 | 1.50 | 38  | 18 | 80 |                                  | 100 | 1000 |
| <b>BT2M-C</b>   | 7.9  | 201 | .095 | 2.4 | .046 | 1.2 | 2.00 | 51  | 18 | 80 |                                  | 100 | 1000 |
| <b>BT4M-C</b>   | 14.2 | 361 | .095 | 2.4 | .046 | 1.2 | 4.00 | 102 | 18 | 80 |                                  | 100 | 1000 |

### Intermediate Cross Section – Plenum-Rated

|                 |      |     |      |     |      |     |      |     |    |     |                                  |     |      |
|-----------------|------|-----|------|-----|------|-----|------|-----|----|-----|----------------------------------|-----|------|
| <b>BT1.5I-C</b> | 6.1  | 155 | .141 | 3.6 | .041 | 1.0 | 1.50 | 38  | 40 | 178 | GTS, GTSL, GS2B, PTS, PPTS, STS2 | 100 | 1000 |
| <b>BT2I-C</b>   | 8.0  | 203 | .141 | 3.6 | .041 | 1.0 | 2.00 | 51  | 40 | 178 |                                  | 100 | 1000 |
| <b>BT3I-C</b>   | 11.3 | 287 | .141 | 3.6 | .049 | 1.2 | 3.00 | 76  | 40 | 178 |                                  | 100 | 1000 |
| <b>BT4I-C</b>   | 14.3 | 363 | .141 | 3.6 | .049 | 1.2 | 4.00 | 102 | 40 | 178 |                                  | 100 | 1000 |

### Standard Cross Section – Plenum-Rated

|               |      |     |      |     |      |     |      |     |    |     |  |     |      |
|---------------|------|-----|------|-----|------|-----|------|-----|----|-----|--|-----|------|
| <b>BT2S-C</b> | 8.0  | 203 | .185 | 4.7 | .045 | 1.1 | 2.00 | 51  | 50 | 222 | GTS, GTSL, GS2B, GTH, GS4H, PTS, PTH, PPTS, STS2, STH2 | 100 | 1000 |
| <b>BT3S-C</b> | 12.0 | 305 | .185 | 4.7 | .052 | 1.3 | 3.00 | 76  | 50 | 222 |  | 100 | 1000 |
| <b>BT4S-C</b> | 15.1 | 384 | .185 | 4.7 | .052 | 1.3 | 4.00 | 102 | 50 | 222 |  | 100 | 1000 |

### Light-Heavy Cross Section (Straight Tip) – Plenum-Rated

|                |      |     |      |     |      |     |      |     |     |     |                                    |    |     |
|----------------|------|-----|------|-----|------|-----|------|-----|-----|-----|------------------------------------|----|-----|
| <b>BT2LH-L</b> | 8.7  | 221 | .275 | 7.0 | .065 | 1.7 | 2.00 | 51  | 120 | 534 | GTH, GS4H, GS4EH, PTH, STH2, ST3EH | 50 | 500 |
| <b>BT3LH-L</b> | 11.8 | 300 | .275 | 7.0 | .065 | 1.7 | 3.00 | 76  | 120 | 534 |                                    | 50 | 500 |
| <b>BT4LH-L</b> | 14.9 | 378 | .275 | 7.0 | .065 | 1.7 | 4.00 | 102 | 120 | 534 |                                    | 50 | 500 |
| <b>BT5LH-L</b> | 18.1 | 460 | .275 | 7.0 | .065 | 1.7 | 5.00 | 127 | 120 | 534 |                                    | 50 | 500 |
| <b>BT6LH-L</b> | 21.2 | 538 | .275 | 7.0 | .065 | 1.7 | 6.00 | 152 | 120 | 534 |                                    | 50 | 500 |
| <b>BT7LH-L</b> | 24.4 | 620 | .275 | 7.0 | .065 | 1.7 | 7.00 | 178 | 120 | 534 |                                    | 50 | 500 |
| <b>BT8LH-L</b> | 27.5 | 699 | .275 | 7.0 | .065 | 1.7 | 8.00 | 203 | 120 | 534 |                                    | 50 | 500 |
| <b>BT9LH-L</b> | 30.7 | 780 | .275 | 7.0 | .065 | 1.7 | 9.00 | 229 | 120 | 534 |                                    | 50 | 500 |

A. System Overview

**UL** **UL** **CSA** **Dome-Top® Barb Ty Cable Ties – Weather Resistant Nylon 6.6**

B1. Cable Ties

- Greater resistance to damage caused by ultraviolet light – indoor or outdoor use
- Dome-top head features unique patented design with round, smooth edges

- Stainless steel locking barb provides consistent performance, reliability, and infinite adjustability through entire bundle range
- High strength and low thread force
- Curved tip is easy to pick up from flat surfaces and allows faster initial threading to speed installation

B2. Cable Accessories



B3. Stainless Steel Ties

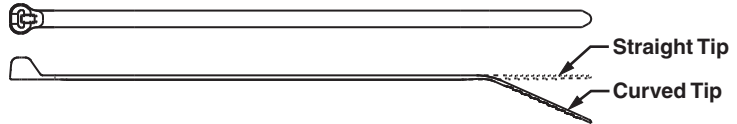

C1. Wiring Duct

C2. Surface Raceway

| Part Number | Length |    | Width |    | Thickness |    | Max. Bundle Dia. |    | Min. Loop Tensile Str. |   | Recommended Installation Tool | Std. Pkg. Qty. | Std. Ctn. Qty. |
|-------------|--------|----|-------|----|-----------|----|------------------|----|------------------------|---|-------------------------------|----------------|----------------|
|             | In.    | mm | In.   | mm | In.       | mm | In.              | mm | Lbs.                   | N |                               |                |                |

C3. Abrasion Protection

| Miniature Cross Section |      |     |      |     |      |     |      |     |    |    |                                  |     |      |
|-------------------------|------|-----|------|-----|------|-----|------|-----|----|----|----------------------------------|-----|------|
| <b>BT1M-C0</b>          | 4.0  | 102 | .095 | 2.4 | .036 | .9  | .90  | 23  | 18 | 80 | GTS, GTSL, GS2B, PTS, PPTS, STS2 | 100 | 1000 |
| <b>BT1.5M-C0</b>        | 6.3  | 160 | .095 | 2.4 | .046 | 1.2 | 1.50 | 38  | 18 | 80 |                                  | 100 | 1000 |
| <b>BT2M-C0</b>          | 7.9  | 201 | .095 | 2.4 | .046 | 1.2 | 2.00 | 51  | 18 | 80 |                                  | 100 | 1000 |
| <b>BT4M-C0</b>          | 14.2 | 361 | .095 | 2.4 | .046 | 1.2 | 4.00 | 102 | 18 | 80 |                                  | 100 | 1000 |

C4. Cable Management

| Intermediate Cross Section |      |     |      |     |      |     |      |     |    |     |                                  |     |      |
|----------------------------|------|-----|------|-----|------|-----|------|-----|----|-----|----------------------------------|-----|------|
| <b>BT1.5I-C0</b>           | 6.1  | 155 | .141 | 3.6 | .041 | 1.0 | 1.50 | 38  | 40 | 178 | GTS, GTSL, GS2B, PTS, PPTS, STS2 | 100 | 1000 |
| <b>BT2I-C0</b>             | 8.0  | 203 | .141 | 3.6 | .041 | 1.0 | 2.00 | 51  | 40 | 178 |                                  | 100 | 1000 |
| <b>BT3I-C0</b>             | 11.3 | 287 | .141 | 3.6 | .049 | 1.2 | 3.00 | 76  | 40 | 178 |                                  | 100 | 1000 |
| <b>BT4I-C0</b>             | 14.3 | 363 | .141 | 3.6 | .049 | 1.2 | 4.00 | 102 | 40 | 178 |                                  | 100 | 1000 |

D1. Terminals

| Standard Cross Section |      |     |      |     |      |     |      |     |    |     |  |     |      |
|------------------------|------|-----|------|-----|------|-----|------|-----|----|-----|--|-----|------|
| <b>BT2S-C0</b>         | 8.0  | 203 | .185 | 4.7 | .045 | 1.1 | 2.00 | 51  | 50 | 222 | GTS, GTSL, GS2B, GTH, GS4H, PTS, PTH, PPTS, STS2, STH2 | 100 | 1000 |
| <b>BT3S-C0</b>         | 12.0 | 305 | .185 | 4.7 | .052 | 1.3 | 3.00 | 76  | 50 | 222 |  | 100 | 1000 |
| <b>BT4S-C0</b>         | 15.1 | 384 | .185 | 4.7 | .052 | 1.3 | 4.00 | 102 | 50 | 222 |  | 100 | 1000 |

D2. Power Connectors

D3. Grounding Connectors

| Light-Heavy Cross Section (Straight Tip) |      |     |      |     |      |     |      |     |     |     |                                    |    |     |
|--|------|-----|------|-----|------|-----|------|-----|-----|-----|------------------------------------|----|-----|
| <b>BT2LH-L0</b>                          | 8.7  | 221 | .275 | 7.0 | .065 | 1.7 | 2.00 | 51  | 120 | 534 | GTH, GS4H, GS4EH, PTH, STH2, ST3EH | 50 | 500 |
| <b>BT3LH-L0</b>                          | 11.8 | 300 | .275 | 7.0 | .065 | 1.7 | 3.00 | 76  | 120 | 534 |                                    | 50 | 500 |
| <b>BT4LH-L0</b>                          | 14.9 | 378 | .275 | 7.0 | .065 | 1.7 | 4.00 | 102 | 120 | 534 |                                    | 50 | 500 |
| <b>BT5LH-L0</b>                          | 18.1 | 460 | .275 | 7.0 | .065 | 1.7 | 5.00 | 127 | 120 | 534 |                                    | 50 | 500 |
| <b>BT6LH-L0</b>                          | 21.2 | 538 | .275 | 7.0 | .065 | 1.7 | 6.00 | 152 | 120 | 534 |                                    | 50 | 500 |
| <b>BT7LH-L0</b>                          | 24.4 | 620 | .275 | 7.0 | .065 | 1.7 | 7.00 | 178 | 120 | 534 |                                    | 50 | 500 |
| <b>BT8LH-L0</b>                          | 27.5 | 699 | .275 | 7.0 | .065 | 1.7 | 8.00 | 203 | 120 | 534 |                                    | 50 | 500 |
| <b>BT9LH-L0</b>                          | 30.7 | 780 | .275 | 7.0 | .065 | 1.7 | 9.00 | 229 | 120 | 534 |                                    | 50 | 500 |

E1. Labeling Systems

E2. Labels

Note: UL Recognized, UL Listed, and CSA Certified, except LH cross section.

E3. Pre-Printed & Write-On Markers

E4. Permanent Identification

E5. Lockout/Tagout & Safety Solutions

F. Index



## Dome-Top® Barb Ty Cable Ties – Heat Stabilized Nylon 6.6

- For high temperature applications up to 239°F (115°C) – indoor use
- Dome-top head features unique patented design with round, smooth edges

- Stainless steel locking barb provides consistent performance, reliability, and infinite adjustability through entire bundle range
- Curved tip is easy to pick up from flat surfaces and allows faster initial threading to speed installation



BT2S-M30



BT2S-M39

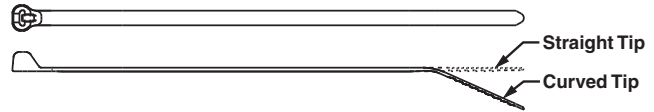

| Part Number | Length |    | Width |    | Thickness |    | Max. Bundle Dia. |    | Min. Loop Tensile Str. |   | Recommended Installation Tool | Std. Pkg. Qty. | Std. Ctn. Qty. |
|-------------|--------|----|-------|----|-----------|----|------------------|----|------------------------|---|-------------------------------|----------------|----------------|
|             | In.    | mm | In.   | mm | In.       | mm | In.              | mm | Lbs.                   | N |                               |                |                |

### Heat Stabilized Nylon 6.6 – Black Miniature Cross Section

|            |     |     |      |     |      |     |      |    |    |    |                                  |      |       |
|------------|-----|-----|------|-----|------|-----|------|----|----|----|----------------------------------|------|-------|
| BT1M-C30   | 4.0 | 102 | .095 | 2.4 | .036 | .9  | .90  | 23 | 18 | 80 | GTS, GTSL, GS2B, PTS, PPTS, STS2 | 100  | 1000  |
| BT1.5M-M30 | 6.3 | 160 | .095 | 2.4 | .046 | 1.2 | 1.50 | 38 | 18 | 80 |                                  | 1000 | 50000 |
| BT2M-M30   | 7.9 | 201 | .095 | 2.4 | .046 | 1.2 | 2.00 | 51 | 18 | 80 |                                  | 1000 | 25000 |

### Intermediate Cross Section

|            |      |     |      |     |      |     |      |    |    |     |                                  |      |       |
|------------|------|-----|------|-----|------|-----|------|----|----|-----|----------------------------------|------|-------|
| BT1.5I-M30 | 6.1  | 155 | .141 | 3.6 | .041 | 1.0 | 1.50 | 38 | 40 | 178 | GTS, GTSL, GS2B, PTS, PPTS, STS2 | 1000 | 25000 |
| BT2I-M30   | 8.0  | 203 | .141 | 3.6 | .041 | 1.0 | 2.00 | 51 | 40 | 178 |                                  | 1000 | 25000 |
| BT3I-M30   | 11.3 | 287 | .141 | 3.6 | .049 | 1.2 | 3.00 | 76 | 40 | 178 |                                  | 1000 | 10000 |

### Standard Cross Section

|          |      |     |      |     |      |     |      |     |    |     |  |      |       |
|----------|------|-----|------|-----|------|-----|------|-----|----|-----|--|------|-------|
| BT2S-M30 | 8.0  | 203 | .185 | 4.7 | .045 | 1.1 | 2.00 | 51  | 50 | 222 | GTS, GTSL, GS2B, GTS, GS4H, PTS, PTH, PPTS, STS2, STH2 | 1000 | 10000 |
| BT3S-M30 | 12.0 | 305 | .185 | 4.7 | .052 | 1.3 | 3.00 | 76  | 50 | 222 |  | 1000 | 10000 |
| BT4S-M30 | 15.1 | 384 | .185 | 4.7 | .052 | 1.3 | 4.00 | 102 | 50 | 222 |  | 1000 | 5000  |

### Light-Heavy Cross Section (Straight Tip)

|            |      |     |      |     |      |     |      |     |     |     |                                    |     |      |
|------------|------|-----|------|-----|------|-----|------|-----|-----|-----|------------------------------------|-----|------|
| BT4LH-TL30 | 14.9 | 378 | .275 | 7.0 | .065 | 1.7 | 4.00 | 102 | 120 | 534 | GTH, GS4H, GS4EH, PTH, STH2, ST3EH | 250 | 2500 |
|------------|------|-----|------|-----|------|-----|------|-----|-----|-----|------------------------------------|-----|------|

### Heat Stabilized Nylon 6.6 – Natural

#### Miniature Cross Section

|          |     |     |      |     |      |    |     |    |    |    |                                  |      |       |
|----------|-----|-----|------|-----|------|----|-----|----|----|----|----------------------------------|------|-------|
| BT1M-M39 | 4.0 | 102 | .095 | 2.4 | .036 | .9 | .90 | 23 | 18 | 80 | GTS, GTSL, GS2B, PTS, PPTS, STS2 | 1000 | 50000 |
|----------|-----|-----|------|-----|------|----|-----|----|----|----|----------------------------------|------|-------|

#### Intermediate Cross Section

|            |     |     |      |     |      |     |      |    |    |     |                                  |      |       |
|------------|-----|-----|------|-----|------|-----|------|----|----|-----|----------------------------------|------|-------|
| BT1.5I-M39 | 6.1 | 155 | .141 | 3.6 | .041 | 1.0 | 1.50 | 38 | 40 | 178 | GTS, GTSL, GS2B, PTS, PPTS, STS2 | 1000 | 25000 |
|------------|-----|-----|------|-----|------|-----|------|----|----|-----|----------------------------------|------|-------|

#### Standard Cross Section

|          |      |     |      |     |      |     |      |     |    |     |  |      |       |
|----------|------|-----|------|-----|------|-----|------|-----|----|-----|--|------|-------|
| BT2S-M39 | 8.0  | 203 | .185 | 4.7 | .045 | 1.1 | 2.00 | 51  | 50 | 222 | GTS, GTSL, GS2B, GTS, GS4H, PTS, PTH, PPTS, STS2, STH2 | 1000 | 10000 |
| BT3S-M39 | 12.0 | 305 | .185 | 4.7 | .052 | 1.3 | 3.00 | 76  | 50 | 222 |  | 1000 | 10000 |
| BT4S-M39 | 15.1 | 384 | .185 | 4.7 | .052 | 1.3 | 4.00 | 102 | 50 | 222 |  | 1000 | 5000  |

#### Light-Heavy Cross Section (Straight Tip)

|            |      |     |      |     |      |     |      |     |     |     |                                    |     |      |
|------------|------|-----|------|-----|------|-----|------|-----|-----|-----|------------------------------------|-----|------|
| BT4LH-TL39 | 14.9 | 378 | .275 | 7.0 | .065 | 1.7 | 4.00 | 102 | 120 | 534 | GTH, GS4H, GS4EH, PTH, STH2, ST3EH | 250 | 2500 |
|------------|------|-----|------|-----|------|-----|------|-----|-----|-----|------------------------------------|-----|------|

A. System Overview

B1. Cable Ties

B2. Cable Accessories

B3. Stainless Steel Ties

C1. Wiring Duct

C2. Surface Raceway

C3. Abrasion Protection

C4. Cable Management

D1. Terminals

D2. Power Connectors

D3. Grounding Connectors

E1. Labeling Systems

E2. Labels

E3. Pre-Printed & Write-On Markers

E4. Permanent Identification

E5. Lockout/Tagout & Safety Solutions

F. Index

A. System Overview



## Dome-Top® Barb Ty Clamp Ties – Nylon 6.6

B1. Cable Ties

- For indoor use
- Used to secure a cable bundle to another surface such as a control panel, communication rack, wall or ceiling
- Design allows for bundling before or after screwing clamp in place

- Stainless steel locking barb provides consistent performance, reliability, and infinite adjustability through entire bundle range
- Curved tip is easy to pick up from flat surfaces and allows faster initial threading to speed installation
- UL Listed for use in plenum or air handling spaces per NEC

B2. Cable Accessories

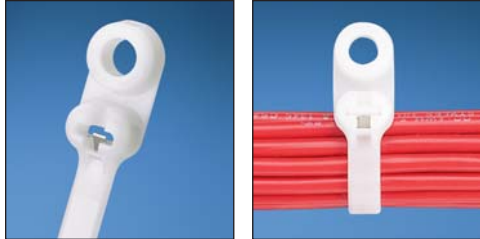

B3. Stainless Steel Ties

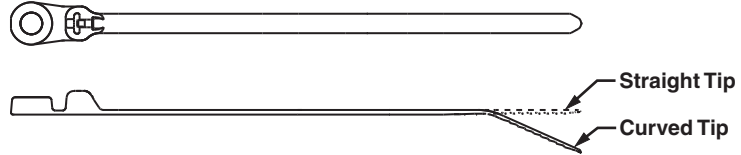

C1. Wiring Duct



C2. Surface Raceway

| Part Number | Length |    | Width |    | Thickness |    | Nominal Hole Dia. |    | Screw Size | Metric Screw Size | Max. Bundle Dia. |    | Min. Loop Tensile Str. |   | Recommended Installation Tool | Std. Pkg. Qty. | Std. Ctn. Qty. |
|-------------|--------|----|-------|----|-----------|----|-------------------|----|------------|-------------------|------------------|----|------------------------|---|-------------------------------|----------------|----------------|
|             | In.    | mm | In.   | mm | In.       | mm | In.               | mm |            |                   | In.              | mm | Lbs.                   | N |                               |                |                |

C3. Abrasion Protection

| Miniature Cross Section – Plenum-Rated |     |     |      |     |      |     |      |     |    |      |      |    |    |    |                                  |      |       |
|--|-----|-----|------|-----|------|-----|------|-----|----|------|------|----|----|----|----------------------------------|------|-------|
| <b>BC1M-S4-M</b>                       | 4.6 | 117 | .095 | 2.4 | .046 | 1.2 | .122 | 3.1 | #4 | M2.5 | .90  | 23 | 18 | 80 | GTS, GTSL, GS2B, PTS, PPTS, STS2 | 1000 | 50000 |
| <b>BC2M-S4-M</b>                       | 8.3 | 211 | .095 | 2.4 | .046 | 1.2 | .122 | 3.1 | #4 | M2.5 | 2.00 | 51 | 18 | 80 |                                  | 1000 | 25000 |

C4. Cable Management

| Intermediate Cross Section – Plenum-Rated |     |     |      |     |      |     |      |     |    |    |      |    |    |     |                                  |      |       |
|---|-----|-----|------|-----|------|-----|------|-----|----|----|------|----|----|-----|----------------------------------|------|-------|
| <b>BC1.5I-S8-M</b>                        | 6.6 | 168 | .141 | 3.6 | .041 | 1.0 | .174 | 4.4 | #8 | M4 | 1.50 | 38 | 40 | 178 | GTS, GTSL, GS2B, PTS, PPTS, STS2 | 1000 | 25000 |

D1. Terminals

| Standard Cross Section – Plenum-Rated |      |     |      |     |      |     |      |     |     |    |      |     |    |     |  |     |      |
|---------------------------------------|------|-----|------|-----|------|-----|------|-----|-----|----|------|-----|----|-----|--|-----|------|
| <b>BC2S-S10-C</b>                     | 8.5  | 216 | .185 | 4.7 | .052 | 1.3 | .200 | 5.1 | #10 | M5 | 2.00 | 51  | 50 | 222 | GTS, GTSL, GS2B, GTH, GS4H, PTS, PTH, PPTS, STS2, STH2 | 100 | 1000 |
| <b>BC3S-S10-D</b>                     | 12.5 | 318 | .185 | 4.7 | .052 | 1.3 | .200 | 5.1 | #10 | M5 | 3.00 | 76  | 50 | 222 |  | 500 | 5000 |
| <b>BC4S-S10-C</b>                     | 15.6 | 396 | .185 | 4.7 | .052 | 1.3 | .200 | 5.1 | #10 | M5 | 4.00 | 102 | 50 | 222 |  | 100 | 1000 |

D2. Power Connectors

| Light-Heavy Cross Section (Straight Tip) – Plenum-Rated |      |     |      |     |      |     |      |     |     |    |      |     |     |     |                                    |    |     |
|---|------|-----|------|-----|------|-----|------|-----|-----|----|------|-----|-----|-----|------------------------------------|----|-----|
| <b>BC4LH-S25-L</b>                                      | 15.5 | 394 | .275 | 7.0 | .065 | 1.7 | .260 | 6.6 | 1/4 | M6 | 4.00 | 102 | 120 | 534 | GTH, GS4H, GS4EH, PTH, STH2, ST3EH | 50 | 500 |

D3. Grounding Connectors

E1. Labeling Systems

E2. Labels

E3. Pre-Printed & Write-On Markers

E4. Permanent Identification

E5. Lockout/Tagout & Safety Solutions

F. Index



## Dome-Top® Barb Ty Clamp Ties – Weather Resistant and Heat Stabilized Nylon 6.6

- Weather Resistant material has greater resistance to damage caused by ultraviolet light – indoor or outdoor use
- Heat stabilized material for high temperature applications up to 239°F (115°C) – indoor use
- Used to secure a cable bundle to another surface such as a control panel, communication rack, wall or ceiling

- Design allows for bundling before or after screwing clamp in place
- Stainless steel locking barb provides consistent performance, reliability, and infinite adjustability through entire bundle range
- Curved tip is easy to pick up from flat surfaces and allows faster initial threading to speed installation

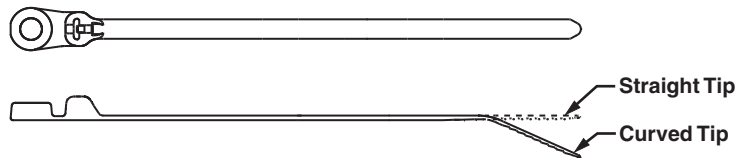
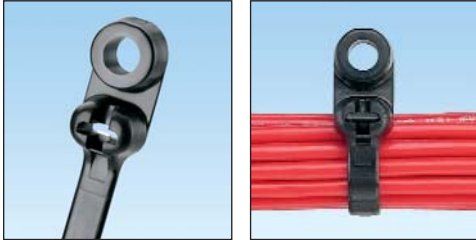

| Part Number | Length |    | Width |    | Thickness |    | Nominal Hole Dia. |    | Screw Size | Metric Screw Size | Max. Bundle Dia. |    | Min. Loop Tensile Str. |   | Recommended Installation Tool | Std. Pkg. Qty. | Std. Ctn. Qty. |
|-------------|--------|----|-------|----|-----------|----|-------------------|----|------------|-------------------|------------------|----|------------------------|---|-------------------------------|----------------|----------------|
|             | In.    | mm | In.   | mm | In.       | mm | In.               | mm |            |                   | In.              | mm | Lbs.                   | N |                               |                |                |

### Weather Resistant Nylon 6.6

#### Miniature Cross Section

|            |     |     |      |     |      |     |      |     |    |      |      |    |    |    |                                  |      |       |
|------------|-----|-----|------|-----|------|-----|------|-----|----|------|------|----|----|----|----------------------------------|------|-------|
| BC1M-S4-M0 | 4.6 | 117 | .095 | 2.4 | .046 | 1.2 | .122 | 3.1 | #4 | M2.5 | .90  | 23 | 18 | 80 | GTS, GTSL, GS2B, PTS, PPTS, STS2 | 1000 | 50000 |
| BC2M-S4-M0 | 8.3 | 211 | .095 | 2.4 | .046 | 1.2 | .122 | 3.1 | #4 | M2.5 | 2.00 | 51 | 18 | 80 |                                  | 1000 | 25000 |

#### Intermediate Cross Section

|              |     |     |      |     |      |     |      |     |    |    |      |    |    |     |                                  |      |       |
|--------------|-----|-----|------|-----|------|-----|------|-----|----|----|------|----|----|-----|----------------------------------|------|-------|
| BC1.5I-S8-M0 | 6.6 | 168 | .141 | 3.6 | .041 | 1.0 | .174 | 4.4 | #8 | M4 | 1.50 | 38 | 40 | 178 | GTS, GTSL, GS2B, PTS, PPTS, STS2 | 1000 | 25000 |
|--------------|-----|-----|------|-----|------|-----|------|-----|----|----|------|----|----|-----|----------------------------------|------|-------|

#### Standard Cross Section

|             |      |     |      |     |      |     |      |     |     |    |      |     |    |     |  |     |      |
|-------------|------|-----|------|-----|------|-----|------|-----|-----|----|------|-----|----|-----|--|-----|------|
| BC2S-S10-C0 | 8.5  | 216 | .185 | 4.7 | .052 | 1.3 | .200 | 5.1 | #10 | M5 | 2.00 | 51  | 50 | 222 | GTS, GTSL, GS2B, GTH, GS4H, PTS, PTH, PPTS, STS2, STH2 | 100 | 1000 |
| BC3S-S10-D0 | 12.5 | 318 | .185 | 4.7 | .052 | 1.3 | .200 | 5.1 | #10 | M5 | 3.00 | 76  | 50 | 222 |  | 500 | 5000 |
| BC4S-S10-C0 | 15.6 | 396 | .185 | 4.7 | .052 | 1.3 | .200 | 5.1 | #10 | M5 | 4.00 | 102 | 50 | 222 |  | 100 | 1000 |

#### Light-Heavy Cross Section (Straight Tip)

|              |      |     |      |     |      |     |      |     |     |    |      |     |     |     |                                    |    |     |
|--------------|------|-----|------|-----|------|-----|------|-----|-----|----|------|-----|-----|-----|------------------------------------|----|-----|
| BC4LH-S25-L0 | 15.5 | 394 | .275 | 7.0 | .065 | 1.7 | .260 | 6.6 | 1/4 | M6 | 4.00 | 102 | 120 | 534 | GTH, GS4H, GS4EH, PTH, STH2, ST3EH | 50 | 500 |
|--------------|------|-----|------|-----|------|-----|------|-----|-----|----|------|-----|-----|-----|------------------------------------|----|-----|

### Heat Stabilized Nylon 6.6

#### Standard Cross Section

|              |      |     |      |     |      |     |      |     |     |    |      |     |    |     |  |     |      |
|--------------|------|-----|------|-----|------|-----|------|-----|-----|----|------|-----|----|-----|--|-----|------|
| BC4S-S10-D30 | 15.6 | 396 | .185 | 4.7 | .052 | 1.3 | .200 | 5.1 | #10 | M5 | 4.00 | 102 | 50 | 222 | GTS, GTSL, GS2B, GTH, GS4H, PTS, PTH, PPTS, STH2, STS2 | 500 | 5000 |
|--------------|------|-----|------|-----|------|-----|------|-----|-----|----|------|-----|----|-----|--|-----|------|

Note: UL Recognized and CSA Certified except BC4LH-S25-L0.

A.  
System  
Overview

B1.  
Cable Ties

B2.  
Cable  
Accessories

B3.  
Stainless  
Steel Ties

C1.  
Wiring  
Duct

C2.  
Surface  
Raceway

C3.  
Abrasion  
Protection

C4.  
Cable  
Management

D1.  
Terminals

D2.  
Power  
Connectors

D3.  
Grounding  
Connectors

E1.  
Labeling  
Systems

E2.  
Labels

E3.  
Pre-Printed  
& Write-On  
Markers

E4.  
Permanent  
Identification

E5.  
Lockout/  
Tagout  
& Safety  
Solutions

F.  
Index



A. System Overview



## Dome-Top® Barb Ty Wing Push Mount Ties – Nylon and Weather Resistant Nylon 6.6

B1. Cable Ties

- Natural nylon material for indoor use
- Weather resistant material has greater resistance to damage caused by ultraviolet light – indoor or outdoor use
- Combine cable tie, mount, and fastener into a single part
- Used to attach bundles to another surface such as a flat panel
- Anchor is easily pressed into a pre-formed hole and locks in place

- Wings provide constant tension for a stable, secure, and rattle-free installation
- Stainless steel locking barb provides consistent performance, reliability, and infinite adjustability through entire bundle range
- Curved tip is easy to pick up from flat surfaces and allows faster initial threading to speed installation

B2. Cable Accessories

B3. Stainless Steel Ties



BW2S-D

BW2S-D0

C1. Wiring Duct

C2. Surface Raceway

C3. Abrasion Protection

C4. Cable Management

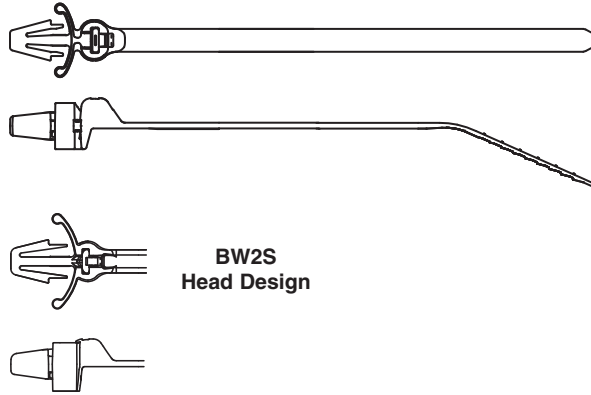
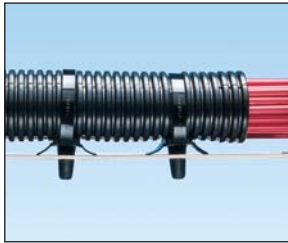

D1. Terminals

D2. Power Connectors

D3. Grounding Connectors

E1. Labeling Systems

E2. Labels

E3. Pre-Printed & Write-On Markers

E4. Permanent Identification

E5. Lockout/Tagout & Safety Solutions

F. Index

| Part Number | Length |    | Width |    | Thickness |    | Nominal Hole Dia. |    | Max. Panel Thickness |    | Max. Bundle Dia. |    | Min. Loop Tensile Str. |   | Recommended Installation Tool | Std. Pkg. Qty. | Std. Ctn. Qty. |
|-------------|--------|----|-------|----|-----------|----|-------------------|----|----------------------|----|------------------|----|------------------------|---|-------------------------------|----------------|----------------|
|             | In.    | mm | In.   | mm | In.       | mm | In.               | mm | In.                  | mm | In.              | mm | Lbs.                   | N |                               |                |                |

### Nylon 6.6

#### Intermediate Cross Section

|                 |     |     |      |     |      |     |      |     |      |     |      |    |    |     |                                  |     |      |
|-----------------|-----|-----|------|-----|------|-----|------|-----|------|-----|------|----|----|-----|----------------------------------|-----|------|
| <b>BW1.5I-D</b> | 6.6 | 168 | .141 | 3.6 | .041 | 1.0 | .187 | 4.7 | .093 | 2.4 | 1.50 | 38 | 40 | 178 | GTS, GTSL, GS2B, PTS, PPTS, STS2 | 500 | 5000 |
|-----------------|-----|-----|------|-----|------|-----|------|-----|------|-----|------|----|----|-----|----------------------------------|-----|------|

#### Standard Cross Section

|               |      |     |      |     |      |     |      |     |      |     |      |    |    |     |  |     |      |
|---------------|------|-----|------|-----|------|-----|------|-----|------|-----|------|----|----|-----|--|-----|------|
| <b>BW2S-D</b> | 8.5  | 216 | .185 | 4.7 | .052 | 1.3 | .250 | 6.4 | .156 | 4.0 | 2.00 | 51 | 50 | 222 | GTS, GTSL, GS2B, GTH, GS4H, PTS, PTH, PPTS, STS2, STH2 | 500 | 5000 |
| <b>BW3S-D</b> | 12.5 | 318 | .185 | 4.7 | .052 | 1.3 | .250 | 6.4 | .156 | 4.0 | 3.00 | 76 | 50 | 222 |  | 500 | 5000 |

### Weather Resistant Nylon 6.6

#### Standard Cross Section

|                |      |     |      |     |      |     |      |     |      |     |      |    |    |     |  |     |      |
|----------------|------|-----|------|-----|------|-----|------|-----|------|-----|------|----|----|-----|--|-----|------|
| <b>BW2S-D0</b> | 8.5  | 216 | .185 | 4.7 | .052 | 1.3 | .250 | 6.4 | .156 | 4.0 | 2.00 | 51 | 50 | 222 | GTS, GTSL, GS2B, GTH, GS4H, PTS, PTH, PPTS, STS2, STH2 | 500 | 5000 |
| <b>BW3S-D0</b> | 12.5 | 318 | .185 | 4.7 | .052 | 1.3 | .250 | 6.4 | .156 | 4.0 | 3.00 | 76 | 50 | 222 |  | 500 | 5000 |

## UL US CS Dome-Top® Barb Ty Push Mount Ties – Weather Resistant Nylon 6.6

- Greater resistance to damage caused by ultraviolet light – indoor or outdoor use
- Used to attach bundles to another surface such as a flat panel
- Cable tie, mount, and fastener in a single part
- Anchor is easily pressed into a pre-formed hole and locks in place

- *Wingless* design allows tie to be used in confined spaces
- Stainless steel locking barb provides consistent performance, reliability, and infinite adjustability through entire bundle range
- Curved tip is easy to pick up from flat surfaces and allows faster initial threading to speed installation

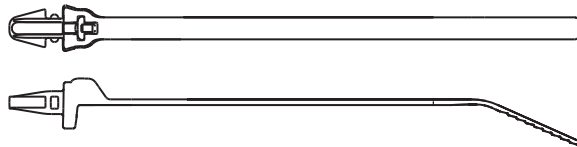
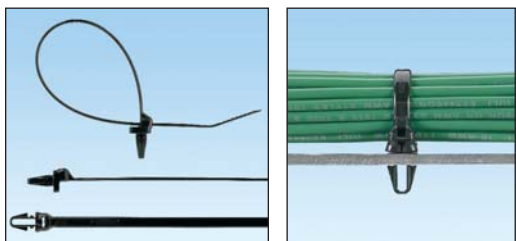

| Part Number                   | Length |     | Width |     | Thickness |     | Nominal Hole Dia. |     | Max. Panel Thickness |     | Max. Bundle Dia. |    | Min. Loop Tensile Str. |     | Recommended Installation Tool                          | Std. Pkg. Qty. | Std. Ctn. Qty. |
|-------------------------------|--------|-----|-------|-----|-----------|-----|-------------------|-----|----------------------|-----|------------------|----|------------------------|-----|--|----------------|----------------|
|                               | In.    | mm  | In.   | mm  | In.       | mm  | In.               | mm  | In.                  | mm  | In.              | mm | Lbs.                   | N   |  |                |                |
| <b>Standard Cross Section</b> |        |     |       |     |           |     |                   |     |                      |     |                  |    |                        |     |  |                |                |
| BP2S-D0                       | 8.5    | 216 | .185  | 4.7 | .052      | 1.3 | .255              | 6.5 | .125                 | 3.2 | 2.00             | 51 | 50                     | 222 | GTS, GTSL, GS2B, GTH, GS4H, PTS, PTH, PPTS, STS2, STH2 | 500            | 5000           |

## Permanent Marking Pens

- Fast drying, permanent ink for identification on marker ties (pages B1.34, B1.52, and B1.71), marker plates (page B2.29), or cable marker straps (page B1.80)
- May be used with any label shown in the catalog when a printer is not available



PX-0  
PX-2



PFX-0  
PFX-2



PX-10

| Part Number | Color | Description  | Std. Pkg. Qty. | Std. Ctn. Qty. |
|-------------|-------|--|----------------|----------------|
| PX-0        | Black | Permanent marking pen – regular tip.                             | 12             | 144            |
| PX-2        | Red   | Permanent marking pen – regular tip.                             | 12             | 144            |
| PFX-0       | Black | Permanent marking pen – fine tip.                                | 12             | 144            |
| PFX-2       | Red   | Permanent marking pen – fine tip.                                | 12             | 144            |
| PX-10       | White | Marking pen for black or other dark colored parts – regular tip. | 12             | 300            |

A.  
System  
Overview

B1.  
Cable Ties

B2.  
Cable  
Accessories

B3.  
Stainless  
Steel Ties

C1.  
Wiring  
Duct

C2.  
Surface  
Raceway

C3.  
Abrasion  
Protection

C4.  
Cable  
Management

D1.  
Terminals

D2.  
Power  
Connectors

D3.  
Grounding  
Connectors

E1.  
Labeling  
Systems

E2.  
Labels

E3.  
Pre-Printed  
& Write-On  
Markers

E4.  
Permanent  
Identification

E5.  
Lockout/  
Tagout/  
& Safety  
Solutions

F.  
Index

A. System Overview

## Dome-Top® Barb Ty Marker and Flag Ties

- Natural nylon material for indoor use
- Weather resistant material has greater resistance to damage caused by ultraviolet light – indoor or outdoor use
- Used to fasten and identify bundles at the same time
- Stainless steel locking barb provides consistent performance, reliability, and infinite adjustability through entire bundle range
- Can be marked with Panduit marker pens on the previous page or computer printable labels
- Custom imprinting with text, symbols, or trademarks available using Panduit Custom Hot Stamping Service, see page B1.93
- Curved tip is easy to pick up from flat surfaces and allows faster initial threading to speed installation

B1. Cable Ties

B2. Cable Accessories

B3. Stainless Steel Ties

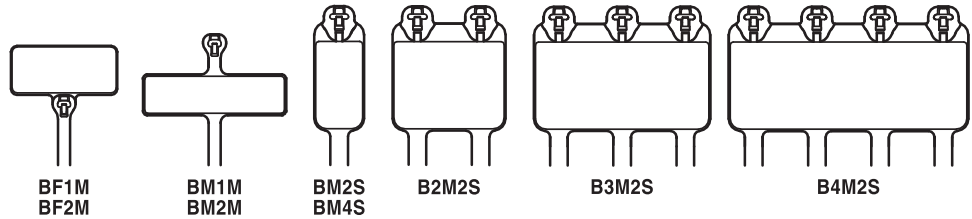
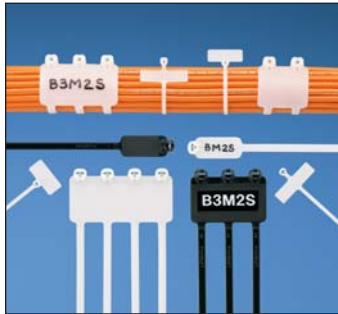

C1. Wiring Duct

C2. Surface Raceway

C3. Abrasion Protection

| Part Number | Marker Type | Length |    | Width |    | Thickness |    | Marker Write-On Area |    | Max. Bundle Dia. |    | Min. Loop Tensile Str. |   | Recommended Installation Tool | Std. Pkg. Qty. | Std. Ctn. Qty. |
|-------------|-------------|--------|----|-------|----|-----------|----|----------------------|----|------------------|----|------------------------|---|-------------------------------|----------------|----------------|
|             |             | In.    | mm | In.   | mm | In.       | mm | In.                  | mm | In.              | mm | Lbs.                   | N |                               |                |                |

C4. Cable Management

### Nylon 6.6

#### Miniature Cross Section

|               |      |     |     |      |     |      |     |            |            |      |    |    |    |                                  |     |      |
|---------------|------|-----|-----|------|-----|------|-----|------------|------------|------|----|----|----|----------------------------------|-----|------|
| <b>BF1M-C</b> | Flag | 4.6 | 117 | .095 | 2.4 | .046 | 1.2 | .36 x .81  | 9.1 x 20.6 | .90  | 23 | 18 | 80 | GTS, GTSL, GS2B, PTS, PPTS, STS2 | 100 | 1000 |
| <b>BF2M-C</b> | Flag | 8.3 | 211 | .095 | 2.4 | .046 | 1.2 | .36 x .81  | 9.1 x 20.6 | 2.00 | 51 | 18 | 80 |                                  | 100 | 1000 |
| <b>BM1M-C</b> | Wrap | 4.2 | 107 | .095 | 2.4 | .046 | 1.2 | .29 x 1.09 | 7.4 x 27.7 | .90  | 23 | 18 | 80 |                                  | 100 | 1000 |
| <b>BM2M-C</b> | Wrap | 7.9 | 201 | .095 | 2.4 | .046 | 1.2 | .29 x 1.09 | 7.4 x 27.7 | 2.00 | 51 | 18 | 80 |                                  | 100 | 1000 |

D1. Terminals

#### Standard Cross Section

|                 |      |      |     |      |     |      |     |            |             |      |     |    |     |  |     |      |
|-----------------|------|------|-----|------|-----|------|-----|------------|-------------|------|-----|----|-----|--|-----|------|
| <b>BM2S-C</b>   | Wrap | 8.0  | 203 | .185 | 4.7 | .045 | 1.2 | .49 x .91  | 12.4 x 23.1 | 2.00 | 51  | 50 | 222 | GTS, GTSL, GS2B, GTH, GS4H, PTS, PTH, PPTS, STS2, STH2 | 100 | 1000 |
| <b>BM4S-C</b>   | Wrap | 15.1 | 384 | .185 | 4.7 | .052 | 1.3 | .50 x 2.13 | 12.7 x 54.1 | 4.00 | 102 | 50 | 222 |  | 100 | 1000 |
| <b>B2M2S-D</b>  | Wrap | 8.0  | 203 | .185 | 4.7 | .045 | 1.2 | 1.15 x .91 | 29.2 x 23.1 | 2.00 | 51  | 50 | 222 |  | 500 | 2500 |
| <b>B3M2S-TL</b> | Wrap | 8.0  | 203 | .185 | 4.7 | .045 | 1.2 | 1.81 x .91 | 46.0 x 23.1 | 2.00 | 51  | 50 | 222 |  | 250 | 2500 |
| <b>B4M2S-TL</b> | Wrap | 8.0  | 203 | .185 | 4.7 | .045 | 1.2 | 2.47 x .91 | 62.7 x 23.1 | 2.00 | 51  | 50 | 222 |  | 250 | 2500 |

D2. Power Connectors

D3. Grounding Connectors

### Weather Resistant Nylon 6.6

#### Miniature Cross Section

|                |      |     |     |      |     |      |     |            |            |      |    |    |    |                                  |      |       |
|----------------|------|-----|-----|------|-----|------|-----|------------|------------|------|----|----|----|----------------------------------|------|-------|
| <b>BF1M-M0</b> | Flag | 4.6 | 117 | .095 | 2.4 | .046 | 1.2 | .36 x .81  | 9.1 x 20.6 | .90  | 23 | 18 | 80 | GTS, GTSL, GS2B, PTS, PPTS, STS2 | 1000 | 25000 |
| <b>BF2M-M0</b> | Flag | 8.3 | 211 | .095 | 2.4 | .046 | 1.2 | .36 x .81  | 9.1 x 20.6 | 2.00 | 51 | 18 | 80 |                                  | 1000 | 25000 |
| <b>BM1M-M0</b> | Wrap | 4.2 | 107 | .095 | 2.4 | .046 | 1.2 | .29 x 1.09 | 7.4 x 27.7 | .90  | 23 | 18 | 80 |                                  | 1000 | 25000 |
| <b>BM2M-M0</b> | Wrap | 7.9 | 201 | .095 | 2.4 | .046 | 1.2 | .29 x 1.09 | 7.4 x 27.7 | 2.00 | 51 | 18 | 80 |                                  | 1000 | 25000 |

E1. Labeling Systems

E2. Labels

#### Standard Cross Section

|                  |      |      |     |      |     |      |     |            |             |      |     |    |     |  |     |       |
|------------------|------|------|-----|------|-----|------|-----|------------|-------------|------|-----|----|-----|--|-----|-------|
| <b>BM2S-D0</b>   | Wrap | 8.0  | 203 | .185 | 4.7 | .045 | 1.2 | .49 x .91  | 12.4 x 23.1 | 2.00 | 51  | 50 | 222 | GTS, GTSL, GS2B, GTH, GS4H, PTS, PTH, PPTS, STS2, STH2 | 500 | 10000 |
| <b>BM4S-D0</b>   | Wrap | 15.1 | 384 | .185 | 4.7 | .052 | 1.3 | .50 x 2.13 | 12.7 x 54.1 | 4.00 | 102 | 50 | 222 |  | 500 | 5000  |
| <b>B2M2S-D0</b>  | Wrap | 8.0  | 203 | .185 | 4.7 | .045 | 1.2 | 1.15 x .91 | 29.2 x 23.1 | 2.00 | 51  | 50 | 222 |  | 500 | 2500  |
| <b>B3M2S-TL0</b> | Wrap | 8.0  | 203 | .185 | 4.7 | .045 | 1.2 | 1.81 x .91 | 46.0 x 23.1 | 2.00 | 51  | 50 | 222 |  | 250 | 2500  |
| <b>B4M2S-TL0</b> | Wrap | 8.0  | 203 | .185 | 4.7 | .045 | 1.2 | 2.47 x .91 | 62.7 x 23.1 | 2.00 | 51  | 50 | 222 |  | 250 | 2500  |

E3. Pre-Printed & Write-On Markers

E4. Permanent Identification

E5. Lockout/Tagout & Safety Solutions

F. Index



## Dura-Ty™ Cable Ties – Weather Resistant Acetal – Heavy Cross Section

- Black acetal strap and head material provide 20+ years outdoor life and high impact resistance
- Excellent ultraviolet light, chemical, and moisture resistance

- Double stainless steel locking barbs provide consistent and predictable holding values
- Textured strap provides better gripping surface to prevent tie from moving laterally along the length of the bundle for tight, consistent bundles
- Robust head design allows tie to be tightened over a wide range of angles
- Convenient reel dispenser pack allows installer to cut-to-size for customized field applications; recyclable box has through-hole for attaching to belt, plus storage area for bag of heads
- Ideal for securing cables in outdoor messenger strand applications
- May be used with stackable aerial cable spacer on the next page



| Part Number  | Description                      | Strap Length |      | Strap Width |      | Min. Loop Tensile Str. |     | Head Height |      | Head Width |       | Recommended Installation Tool | Std. Pkg. Qty. | Std. Ctn. Qty. |
|--|----------------------------------|--------------|------|-------------|------|------------------------|-----|-------------|------|------------|-------|-------------------------------|----------------|----------------|
|  |                                  | Ft.          | m    | In.         | mm   | Lbs.                   | N   | In.         | mm   | In.        | mm    |                               |                |                |
| <b>Strapping, Heads, and Kit – Allows user to customize strap length</b> |                                  |              |      |             |      |                        |     |             |      |            |       |                               |                |                |
| DTRH-LR0   | 50' reel of strapping.           | 50.0         | 15.2 | .331        | 8.40 | 200                    | 890 | —           | —    | —          | —     | GTH, GS4EH, STH2, STHV, ST3EH | 1              | 20             |
| DTHH-Q0  | 25 cable tie heads.              | —            | —    | —           | —    | —                      | —   | .393        | 9.98 | .557       | 14.15 | —                             | 25             | 500            |
| DTKH-0   | Kit: Strapping (50'), Heads (25) | 50.0         | 15.2 | .331        | 8.40 | 200                    | 890 | .393        | 9.98 | .557       | 14.15 | GTH, GS4EH, STH2, STHV, ST3EH | 1              | 20             |

## Dura-Ty™ Cable Ties – Weather Resistant Acetal – Extra-Heavy Cross Section

- Black acetal strap and head material provide 20+ years outdoor life and high impact resistance
- Excellent ultraviolet light, chemical, and moisture resistance
- Double stainless steel locking barbs provide consistent and predictable holding values
- Ideal for securing cables in outdoor messenger strand applications
- Meets Telcordia TR-TSY-000789 industry guidelines for lashed cable supports

- Convenient reel dispenser pack allows installer to cut-to-size for customized field applications; recyclable box has through-hole for attaching to belt, plus storage area for bag of heads
- Several pre-cut sizes have lead-in style angled tips on pre-assembled straps for easy installation, even with gloved hands, to speed installation
- May be used with stackable aerial cable spacer on the next page



**Formula to determine amount of strapping required:**  
 Diameter (inches) x 3.14 + 4.5 inches  
 Diameter (mm) x 3.14 + 114mm

| Part Number  | Description                      | Strap Length |      | Strap Width |       | Min. Loop Tensile Str. |      | Head Height |       | Head Width |       | Recommended Installation Tool | Std. Pkg. Qty. | Std. Ctn. Qty. |
|--|----------------------------------|--------------|------|-------------|-------|------------------------|------|-------------|-------|------------|-------|-------------------------------|----------------|----------------|
|  |                                  | Ft.          | m    | In.         | mm    | Lbs.                   | N    | In.         | mm    | In.        | mm    |                               |                |                |
| <b>Strapping, Heads, and Kit – Allows user to customize strap length</b> |                                  |              |      |             |       |                        |      |             |       |            |       |                               |                |                |
| DTREH-LR0  | 50' reel of strapping.           | 50.0         | 15.2 | .500        | 12.70 | 250                    | 1112 | —           | —     | —          | —     | GS4EH, ST3EH                  | 1              | 20             |
| DTHEH-Q0   | 25 cable tie heads.              | —            | —    | —           | —     | —                      | —    | .490        | 12.45 | .718       | 18.24 | —                             | 25             | 500            |
| DTKEH-0  | Kit: Strapping (50'), Heads (25) | 50.0         | 15.2 | .500        | 12.70 | 250                    | 1112 | .490        | 12.45 | .718       | 18.24 | GS4EH, ST3EH                  | 1              | 20             |

| Part Number                                  | Length |      | Width |       | Thickness | Head Height |      | Head Width |      | Max. Bundle Dia. |      | Min. Loop Tensile Strength |     | Recommended Installation Tool | Std. Pkg. Qty. | Std. Ctn. Qty. |      |
|--|--------|------|-------|-------|-----------|-------------|------|------------|------|------------------|------|----------------------------|-----|-------------------------------|----------------|----------------|------|
|  | In.    | mm   | In.   | mm    | In.       | mm          | In.  | mm         | In.  | mm               | Lbs. | N                          |     |                               |                |                |      |
| <b>Discrete Lengths – Speed installation</b> |        |      |       |       |           |             |      |            |      |                  |      |                            |     |                               |                |                |      |
| DT4EH-L0                                     | 13.5   | 343  | .500  | 12.70 | .059      | 1.50        | .490 | 12.45      | .718 | 18.24            | 3.8  | 98                         | 250 | 1112                          | GS4EH, ST3EH   | 50             | 1000 |
| DT8EH-Q0                                     | 27.0   | 686  | .500  | 12.70 | .059      | 1.50        | .490 | 12.45      | .718 | 18.24            | 8.0  | 203                        | 250 | 1112                          |                | 25             | 500  |
| DT14EH-L0                                    | 48.0   | 1219 | .500  | 12.70 | .059      | 1.50        | .490 | 12.45      | .718 | 18.24            | 14.0 | 355                        | 250 | 1112                          |                | 50             | 250  |
| DT15EH-L0                                    | 53.0   | 1346 | .500  | 12.70 | .059      | 1.50        | .490 | 12.45      | .718 | 18.24            | 15.0 | 381                        | 250 | 1112                          |                | 50             | 250  |
| DT28EH-C0                                    | 96.0   | 2438 | .500  | 12.70 | .059      | 1.50        | .490 | 12.45      | .718 | 18.24            | 28.0 | 711                        | 250 | 1112                          |                | 100            | —    |
| DT44EH-C0                                    | 144.0  | 3658 | .500  | 12.70 | .059      | 1.50        | .490 | 12.45      | .718 | 18.24            | 44.0 | 1117                       | 250 | 1112                          |                | 100            | —    |

A.  
System  
Overview

## Stackable Aerial Cable Spacer – Weather Resistant Polypropylene

B1.  
Cable Ties

- Greater resistance to damage caused by ultraviolet light – indoor or outdoor use
- Each spacer snaps into another to increase spacer heights by 1/2" increments
- Designed for use in parallel or perpendicular applications
- For use with Dura-Ty™ Cable Ties shown on the previous page

B2.  
Cable  
Accessories

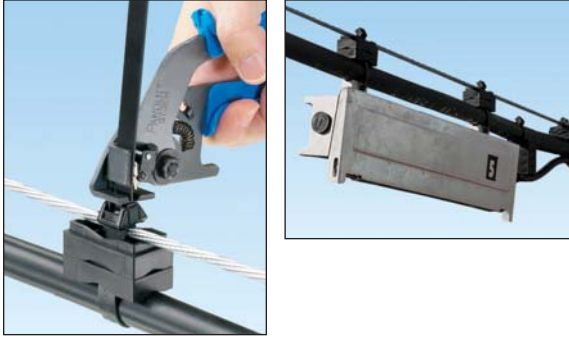

B3.  
Stainless  
Steel Ties

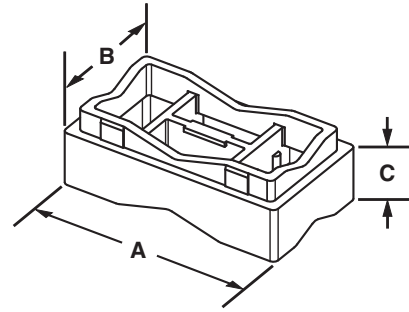

C1.  
Wiring  
Duct

C2.  
Surface  
Raceway

| Part Number | Length<br>A |      | Width<br>B |      | Height<br>C |      | Used with<br>Cable Ties* | Std.<br>Pkg.<br>Qty. | Std.<br>Ctn.<br>Qty. |
|-------------|-------------|------|------------|------|-------------|------|--------------------------|----------------------|----------------------|
|             | In.         | mm   | In.        | mm   | In.         | mm   |                          |                      |                      |
| SACS50-T100 | 2.08        | 52.8 | 1.16       | 29.5 | 0.71        | 18.0 | LH, H, EH                | 200                  | 2000                 |

\*Cable tie cross section sizes: LH = Light-Heavy, H = Heavy, and EH = Extra-Heavy.

C4.  
Cable  
Management

D1.  
Terminals

## Dome-Top® Barb Ty and Dura-Ty™ Cable Ties

D2.  
Power  
Connectors

### Material and Color Chart

D3.  
Grounding  
Connectors

| Material                    | Color   | Panduit<br>Suffix |
|-----------------------------|---------|-------------------|
| Nylon 6.6                   | Natural | ✓                 |
| Weather Resistant Nylon 6.6 | Black   | 0                 |
| Nylon 6.6                   | Brown   | 1                 |
| Nylon 6.6                   | Red     | 2                 |
| Nylon 6.6                   | Orange  | 3                 |
| Nylon 6.6                   | Yellow  | 4Y                |
| Nylon 6.6                   | Green   | 5                 |
| Nylon 6.6                   | Blue    | 6                 |

| Material                  | Color           | Panduit<br>Suffix |
|---------------------------|-----------------|-------------------|
| Nylon 6.6                 | Purple          | 7                 |
| Nylon 6.6                 | Gray            | 8                 |
| Nylon 6.6                 | White           | 10                |
| Nylon 6.6                 | Telephone Gray  | 14                |
| Nylon 6.6                 | Black           | 20                |
| Heat Stabilized Nylon 6.6 | Black           | 30                |
| Heat Stabilized Nylon 6.6 | Natural         | 39                |
| Flame Retardant Nylon 6.6 | Natural (Ivory) | 69                |
| Weather Resistant Acetal  | Black           | *                 |

✓ Denotes Panduit Natural Nylon 6.6 (no suffix).

\*Denotes Dura-Ty™ Weather Resistant Acetal material (no suffix).

E3.  
Pre-Printed  
& Write-On  
Markers

E4.  
Permanent  
Identification

E5.  
Lockout/  
Tagout/  
& Safety  
Solutions

F.  
Index



## Part Number Availability List

| Standard Packaging |                   |                       | Bulk Packaging |                   |                                |
|--------------------|-------------------|-----------------------|----------------|-------------------|--------------------------------|
| Part Number        | Natural Nylon 6.6 | Material/Color Suffix | Part Number    | Natural Nylon 6.6 | Material/Color Suffix          |
|                    |                   |                       | BC1M-S4-M      | ✓                 | 0                              |
|                    |                   |                       | BC2M-S4-M      | ✓                 | 0                              |
|                    |                   |                       | BC1.5I-S8-M    | ✓                 | 0                              |
| BC2S-S10-C         | ✓                 | 0                     | BC2S-S10-D     | ✓                 | 0                              |
|                    |                   |                       | BC3S-S10-D     | ✓                 | 0                              |
| BC4S-S10-C         | ✓                 | 0                     | BC4S-S10-D     | ✓                 | 0,30                           |
| BC4LH-S25-L        | ✓                 | 0                     | BC4LH-S25-TL   | ✓                 | 0                              |
| BF1M-C             | ✓                 |                       | BF1M-M         | ✓                 | 0                              |
| BF2M-C             | ✓                 |                       | BF2M-M         | ✓                 | 0                              |
| BM1M-C             | ✓                 |                       | BM1M-M         | ✓                 | 0                              |
| BM2M-C             | ✓                 |                       | BM2M-M         | ✓                 | 0                              |
| BM2S-C             | ✓                 |                       | BM2S-D         | ✓                 | 0                              |
| BM4S-C             | ✓                 |                       | BM4S-D         | ✓                 | 0                              |
|                    |                   |                       | BP2S-D         |                   | 0                              |
| BT1M-C             | ✓                 | 0,30                  | BT1M-M         | ✓                 | 0,1,2,3,4Y,5,6,7,8,10,30,39    |
|                    |                   |                       | BT1M-XMR       | ✓                 | 0,30                           |
| BT1.5M-C           | ✓                 | 0                     | BT1.5M-M       | ✓                 | 0,30                           |
|                    |                   |                       | BT1.5M-XMR     | ✓                 | 0,30,69                        |
| BT2M-C             | ✓                 | 0                     | BT2M-M         | ✓                 | 0,2,3,4Y,5,6,8,30              |
| BT4M-C             | ✓                 | 0                     | BT4M-M         | ✓                 | 0                              |
| BT1.5I-C           | ✓                 | 0                     | BT1.5I-M       | ✓                 | 0,1,2,3,4Y,5,6,7,8,10,30,39    |
| BT2I-C             | ✓                 | 0                     | BT2I-M         | ✓                 | 0,30                           |
| BT3I-C             | ✓                 | 0                     | BT3I-M         | ✓                 | 0,14,30                        |
| BT4I-C             | ✓                 | 0                     | BT4I-M         | ✓                 | 0,14                           |
| BT2S-C             | ✓                 | 0                     | BT2S-M         | ✓                 | 0,1,2,3,4Y,5,6,7,8,10,20,30,39 |
| BT3S-C             | ✓                 | 0,2                   | BT3S-M         | ✓                 | 0,30,39                        |
| BT4S-C             | ✓                 | 0                     | BT4S-M         | ✓                 | 0,2,3,4Y,5,6,7,8,10,30,39      |
| BT2LH-L            | ✓                 | 0                     | BT2LH-TL       | ✓                 | 0                              |
| BT3LH-L            | ✓                 | 0                     | BT3LH-TL       | ✓                 | 0                              |
| BT4LH-L            | ✓                 | 0                     | BT4LH-TL       | ✓                 | 0,30,39                        |
| BT5LH-L            | ✓                 | 0                     | BT5LH-C        | ✓                 | 0                              |
| BT6LH-L            | ✓                 | 0                     | BT6LH-C        | ✓                 | 0                              |
| BT7LH-L            | ✓                 | 0                     | BT7LH-C        | ✓                 | 0                              |
| BT8LH-L            | ✓                 | 0                     | BT8LH-C        | ✓                 | 0                              |
| BT9LH-L            | ✓                 | 0                     | BT9LH-C        | ✓                 | 0                              |
|                    |                   |                       | BW1.5I-D       | ✓                 |                                |
|                    |                   |                       | BW2S-D         | ✓                 | 0                              |
|                    |                   |                       | BW3S-D         | ✓                 | 0                              |
|                    |                   |                       | B2M2S-D        | ✓                 | 0                              |
|                    |                   |                       | B3M2S-TL       | ✓                 | 0                              |
|                    |                   |                       | B4M2S-TL       | ✓                 | 0                              |

### Dura-Ty™ Cable Ties and Strapping

|                   |   |  |           |   |
|-------------------|---|--|-----------|---|
| DTHEH-Q0, DTHH-Q0 | * |  |           |   |
| DTKEH-0, DTKH-0   | * |  |           |   |
| DTREH-LR0         | * |  |           |   |
| DTRH-LR0          | * |  |           |   |
| DT4EH-L0          | * |  |           |   |
| DT8EH-Q0          | * |  |           |   |
| DT14EH-L0         | * |  | DT14EH-C0 | * |
| DT15EH-L0         | * |  |           |   |
| DT28EH-C0         | * |  |           |   |
| DT44EH-C0         | * |  |           |   |

\*Denotes Dura-Ty™ Weather Resistant Acetal material (no suffix).

A. System Overview

## Features and Benefits – Parallel-Entry Cable Ties

Parallel-entry cable ties limit exposure to sharp edges and protect workers' arms/hands. The ties are designed with a low profile head to avoid snags and reduce overall bundle size.

B1. Cable Ties

### Contour-Ty® Cable Ties

Fully enclosed head for consistent strength

Fully rounded edges on head and strap

Outside teeth and smooth round edges protect cable jacket – ideal for high vibration applications

Curved tip threads easily and installs faster

Rounded tip and aggressive grip for faster initial threading

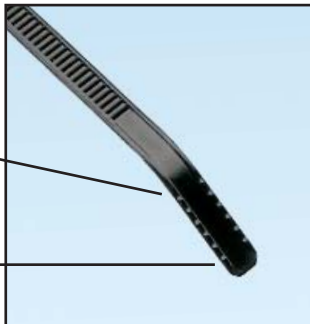

### Hyper-V™ Cable Ties

Design provides for an optional threading position that allows releasable, temporary bundling

Fixed and flexible 2-wedge locking design

Tip bending serrations and threading hole facilitate installations in confined spaces

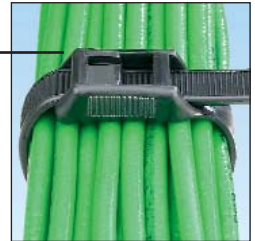

C1. Wiring Duct

C2. Surface Raceway

C3. Abrasion Protection

C4. Cable Management

D1. Terminals

D2. Power Connectors

D3. Grounding Connectors

E1. Labeling Systems

E2. Labels

E3. Pre-Printed & Write-On Markers

E4. Permanent Identification

E5. Lockout/Tagout & Safety Solutions

F. Index

### Belt-Ty™ In-Line Cable Ties



"Finger grip" shaped head assures positive grip while threading tie

Parallel-entry limits exposure to sharp edges and protects workers' arms/hands



### IN-LINE Cable Ties

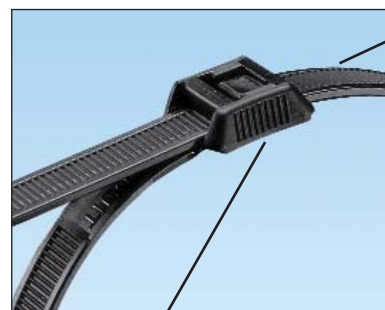

Outside teeth protect cable jacket and wire insulation

"Finger grip" shaped head with serrations assures positive grip while threading tie



Cable tie tools speed installation and reduce total installed cost. See pages B1.109 – B1.114.



Cable tie accessories are used to speed and simplify the mounting of wires, cables, and tubing. See pages B2.1 – B2.29.

## Selection Guide – Parallel-Entry Cable Ties

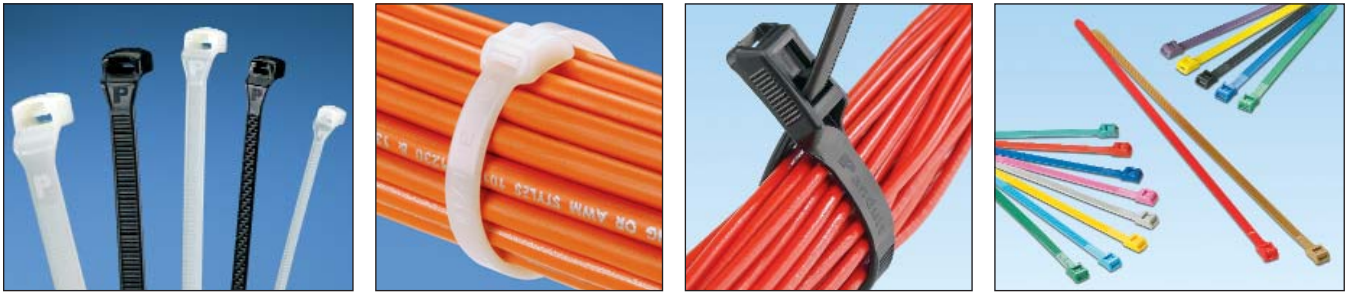

|                                    | Material, Color (Suffix)                          | Style/Function      | Part Number Prefix | Catalog Page |
|------------------------------------|---|---------------------|--------------------|--------------|
| <b>Contour-Ty® Cable Ties</b>      | Nylon 6.6, Natural (No Suffix)                    | Locking Ties/Bundle | CBR                | B1.58        |
|                                    | Weather Resistant Nylon 6.6, Black (0)            | Locking Ties/Bundle | CBR                | B1.59        |
|                                    | Heat Stabilized Nylon 6.6, Black (30)             | Locking Ties/Bundle | CBR                | B1.60        |
|                                    | Heat Stabilized Nylon 6.6, Natural (39)           | Locking Ties/Bundle | CBR                | B1.60        |
|                                    | Flame Retardant Nylon 6.6, Ivory (69)             | Locking Ties/Bundle | CBR                | B1.60        |
| <b>Belt-Ty™ In-Line Cable Ties</b> | Nylon 6.6, Natural (No Suffix)                    | Locking Ties/Bundle | ILT                | B1.61        |
|                                    | Weather Resistant Nylon 6.6, Black (0)            | Locking Ties/Bundle | ILT                | B1.61        |
| <b>Hyper-V™ Cable Ties</b>         | Weather Resistant Nylon 6.6, Black (0)            | Locking Ties/Bundle | HV                 | B1.62        |
| <b>IN-LINE Cable Ties</b>          | Weather Resistant Nylon 6.6, Black (0 and colors) | Locking Ties/Bundle | IT                 | B1.63        |

### Part Number System for Contour-Ty® and Belt-Ty™ Cable Ties

| <b>CBR</b>                             | <b>2</b>                          | <b>S</b>   | — | <b>M</b>                                   | —              |
|--|-----------------------------------|--|---|--|----------------|
| Type                                   | Size                              | Cross Section  |   | Package Size                               | Material/Color |
| CBR = Locking Tie<br>ILT = Locking Tie | Approx. Maximum Bundle Dia. (In.) | M = Miniature<br>I = Intermediate<br>S = Standard<br>HS = Heavy-Standard<br>LH = Light-Heavy |   | C = 100<br>TL = 250<br>D = 500<br>M = 1000 | See page B1.64 |

### Part Number System for Hyper-V™ and IN-LINE Cable Ties

| <b>HV</b>                           | <b>9</b>           | <b>100</b>                       | — | <b>C</b>     | —              |
|-------------------------------------|--------------------|----------------------------------|---|--------------|----------------|
| Type                                | Width              | Size                             |   | Package Size | Material/Color |
| HV= Locking Tie<br>IT = Locking Tie | Approx. Width (mm) | Approx. Maximum Bundle Dia. (mm) |   | C = 100      | See page B1.64 |

A. System Overview



## Contour-Ty® Cable Ties – Nylon 6.6

B1. Cable Ties

- For indoor use
- Unique design prevents wire and cable damage
- Low profile head avoids snags and reduces overall bundle size
- Outside teeth and smooth round edges protect cable jacket – ideal for high vibration applications
- Parallel-entry limits exposure to sharp edges and protects workers' arms/hands
- Fully enclosed head for consistent strength

- Curved tip is easy to pick up from flat surfaces and allows faster initial threading to speed installation
- UL Listed for use in plenum or air handling spaces per NEC

Note: Nylon 6.6 cable ties in natural and colors meet the testing requirements of the U.S. Military Aerospace Standard SAE-AS23190A and the dimensional requirements of Aerospace Standard SAE-AS33671

B2. Cable Accessories

B3. Stainless Steel Ties

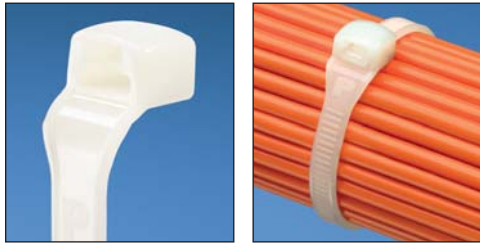

C1. Wiring Duct

C2. Surface Raceway

C3. Abrasion Protection

C4. Cable Management

D1. Terminals

D2. Power Connectors

D3. Grounding Connectors

E1. Labeling Systems

E2. Labels

E3. Pre-Printed & Write-On Markers

E4. Permanent Identification

E5. Lockout/Tagout & Safety Solutions

F. Index

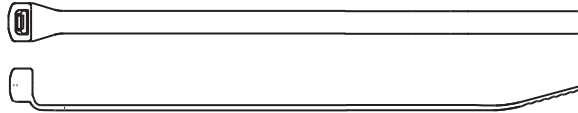

| Part Number  | Length |     | Width |     | Thickness |     | Max. Bundle Dia. |     | Min. Loop Tensile Str. |     | Recommended Installation Tool                          | Std. Pkg. Qty. | Std. Ctn. Qty. |
|--|--------|-----|-------|-----|-----------|-----|------------------|-----|------------------------|-----|--|----------------|----------------|
|  | In.    | mm  | In.   | mm  | In.       | mm  | In.              | mm  | Lbs.                   | N   |  |                |                |
| <b>Miniature Cross Section – Plenum-Rated</b>      |        |     |       |     |           |     |                  |     |                        |     |  |                |                |
| <b>CBR1M-M</b>                                     | 4.1    | 104 | .098  | 2.5 | .038      | 1.0 | 1.00             | 25  | 18                     | 80  | GTS, GTSL, GS2B, PTS, PPTS, STS2                       | 1000           | 50000          |
| <b>CBR1.5M-M</b>                                   | 5.6    | 142 | .098  | 2.5 | .042      | 1.1 | 1.50             | 38  | 18                     | 80  |  | 1000           | 50000          |
| <b>CBR2M-M</b>                                     | 7.2    | 183 | .098  | 2.5 | .042      | 1.1 | 2.00             | 51  | 18                     | 80  |  | 1000           | 25000          |
| <b>Intermediate Cross Section – Plenum-Rated</b>   |        |     |       |     |           |     |                  |     |                        |     |  |                |                |
| <b>CBR1.5I-M</b>                                   | 5.9    | 150 | .140  | 3.6 | .040      | 1.0 | 1.50             | 38  | 40                     | 178 | GTS, GTSL, GS2B, PTS, PPTS, STS2                       | 1000           | 25000          |
| <b>CBR3I-M</b>                                     | 10.4   | 264 | .140  | 3.6 | .052      | 1.3 | 3.00             | 76  | 40                     | 178 |  | 1000           | 10000          |
| <b>CBR4I-M</b>                                     | 13.6   | 345 | .140  | 3.6 | .052      | 1.3 | 4.00             | 102 | 40                     | 178 |  | 1000           | 10000          |
| <b>Standard Cross Section – Plenum-Rated</b>       |        |     |       |     |           |     |                  |     |                        |     |  |                |                |
| <b>CBR2S-M</b>                                     | 7.6    | 193 | .190  | 4.8 | .044      | 1.1 | 2.00             | 51  | 50                     | 222 | GTS, GTSL, GS2B, GTH, GS4H, PTS, PTH, PPTS, STS2, STH2 | 1000           | 10000          |
| <b>CBR3S-M</b>                                     | 10.8   | 274 | .190  | 4.8 | .052      | 1.3 | 3.00             | 76  | 50                     | 222 |  | 1000           | 5000           |
| <b>CBR4S-M</b>                                     | 14.0   | 356 | .190  | 4.8 | .052      | 1.3 | 4.00             | 102 | 50                     | 222 |  | 1000           | 5000           |
| <b>Heavy-Standard Cross Section – Plenum-Rated</b> |        |     |       |     |           |     |                  |     |                        |     |  |                |                |
| <b>CBR2HS-D</b>                                    | 8.0    | 203 | .250  | 6.4 | .058      | 1.4 | 2.00             | 51  | 85                     | 378 | GTH, GS4H, GS4EH, PTH, STH2, ST3EH                     | 500            | 5000           |
| <b>Light-Heavy Cross Section – Plenum-Rated</b>    |        |     |       |     |           |     |                  |     |                        |     |  |                |                |
| <b>CBR4LH-TL</b>                                   | 14.6   | 371 | .300  | 7.6 | .070      | 1.8 | 4.00             | 102 | 120                    | 534 | GTH, GS4H, GS4EH, PTH, STH2, ST3EH                     | 250            | 2500           |
| <b>CBR6LH-C</b>                                    | 20.9   | 531 | .300  | 7.6 | .070      | 1.8 | 6.00             | 152 | 120                    | 534 |  | 100            | 2000           |



## Contour-Ty® Cable Ties – Weather Resistant Nylon 6.6

- Greater resistance to damage caused by ultraviolet light – indoor or outdoor use
- Unique design prevents wire and cable damage
- Low profile head avoids snags and reduces overall bundle size
- Outside teeth and smooth round edges protect cable jacket – ideal for high vibration applications

- Parallel-entry limits exposure to sharp edges and protects workers' arms/hands
- Fully enclosed head for consistent strength
- Curved tip is easy to pick up from flat surfaces and allows faster initial threading to speed installation

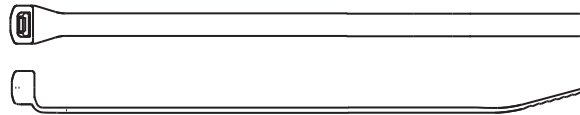

| Part Number                         | Length |     | Width |     | Thickness |     | Max. Bundle Dia. |     | Min. Loop Tensile Str. |     | Recommended Installation Tool                          | Std. Pkg. Qty. | Std. Ctn. Qty. |
|-------------------------------------|--------|-----|-------|-----|-----------|-----|------------------|-----|------------------------|-----|--|----------------|----------------|
|                                     | In.    | mm  | In.   | mm  | In.       | mm  | In.              | mm  | Lbs.                   | N   |  |                |                |
| <b>Miniature Cross Section</b>      |        |     |       |     |           |     |                  |     |                        |     |  |                |                |
| <b>CBR1M-M0</b>                     | 4.1    | 104 | .098  | 2.5 | .038      | 1.0 | 1.00             | 25  | 18                     | 80  | GTS, GTSL, GS2B, PTS, PPTS, STS2                       | 1000           | 50000          |
| <b>CBR1.5M-M0</b>                   | 5.6    | 142 | .098  | 2.5 | .042      | 1.1 | 1.50             | 38  | 18                     | 80  |  | 1000           | 50000          |
| <b>CBR2M-M0</b>                     | 7.2    | 183 | .098  | 2.5 | .042      | 1.1 | 2.00             | 51  | 18                     | 80  |  | 1000           | 25000          |
| <b>Intermediate Cross Section</b>   |        |     |       |     |           |     |                  |     |                        |     |  |                |                |
| <b>CBR1.5I-M0</b>                   | 5.9    | 150 | .140  | 3.6 | .040      | 1.0 | 1.50             | 38  | 40                     | 178 | GTS, GTSL, GS2B, PTS, PPTS, STS2                       | 1000           | 25000          |
| <b>CBR3I-M0</b>                     | 10.4   | 264 | .140  | 3.6 | .052      | 1.3 | 3.00             | 76  | 40                     | 178 |  | 1000           | 10000          |
| <b>CBR4I-M0</b>                     | 13.6   | 345 | .140  | 3.6 | .052      | 1.3 | 4.00             | 102 | 40                     | 178 |  | 1000           | 10000          |
| <b>Standard Cross Section</b>       |        |     |       |     |           |     |                  |     |                        |     |  |                |                |
| <b>CBR2S-M0</b>                     | 7.6    | 193 | .190  | 4.8 | .044      | 1.1 | 2.00             | 51  | 50                     | 222 | GTS, GTSL, GS2B, GTH, GS4H, PTS, PTH, PPTS, STS2, STH2 | 1000           | 10000          |
| <b>CBR3S-M0</b>                     | 10.8   | 274 | .190  | 4.8 | .052      | 1.3 | 3.00             | 76  | 50                     | 222 |  | 1000           | 5000           |
| <b>CBR4S-M0</b>                     | 14.0   | 356 | .190  | 4.8 | .052      | 1.3 | 4.00             | 102 | 50                     | 222 |  | 1000           | 5000           |
| <b>Heavy-Standard Cross Section</b> |        |     |       |     |           |     |                  |     |                        |     |  |                |                |
| <b>CBR2HS-D0</b>                    | 8.0    | 203 | .250  | 6.4 | .058      | 1.4 | 2.00             | 51  | 85                     | 378 | GTH, GS4H, GS4EH, PTH, STH2, ST3EH                     | 500            | 5000           |
| <b>Light-Heavy Cross Section</b>    |        |     |       |     |           |     |                  |     |                        |     |  |                |                |
| <b>CBR4LH-TL0</b>                   | 14.6   | 371 | .300  | 7.6 | .070      | 1.8 | 4.00             | 102 | 120                    | 534 | GTH, GS4H, GS4EH, PTH, STH2, ST3EH                     | 250            | 2500           |
| <b>CBR6LH-C0</b>                    | 20.9   | 531 | .300  | 7.6 | .070      | 1.8 | 6.00             | 152 | 120                    | 534 |  | 100            | 2000           |



A. System Overview



## Contour-Ty® Cable Ties – Heat Stabilized and Flame Retardant Nylon 6.6

B1. Cable Ties

- Heat stabilized material for high temperature applications up to 239°F (115°C) – indoor use
- Flame retardant material has a flammability rating of UL 94V-0 – indoor use
- Unique design prevents wire and cable damage
- Low profile head avoids snags and reduces overall bundle size
- Outside teeth and smooth round edges protect cable jacket – ideal for high vibration applications
- Parallel-entry limits exposure to sharp edges and protects workers' arms/hands
- Fully enclosed head for consistent strength
- Curved tip is easy to pick up from flat surfaces and allows faster initial threading to speed installation

B2. Cable Accessories

B3. Stainless Steel Ties



CBR2S-M30



CBR2S-M39



CBR3S-M69

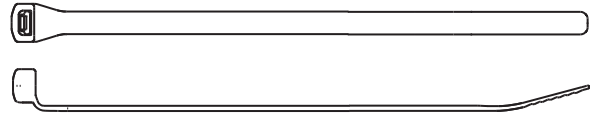

C1. Wiring Duct

C2. Surface Raceway

C3. Abrasion Protection

C4. Cable Management

D1. Terminals

D2. Power Connectors

D3. Grounding Connectors

E1. Labeling Systems

E2. Labels

E3. Pre-Printed & Write-On Markers

E4. Permanent Identification

E5. Lockout/Tagout & Safety Solutions

F. Index

| Part Number | Length |     | Width |    | Thickness |    | Max. Bundle Dia. |    | Min. Loop Tensile Str. |   | Recommended Installation Tool | Std. Pkg. Qty. | Std. Ctn. Qty. |
|-------------|--------|-----|-------|----|-----------|----|------------------|----|------------------------|---|-------------------------------|----------------|----------------|
|             | In.    | mm. | In.   | mm | In.       | mm | In.              | mm | Lbs.                   | N |                               |                |                |

### Heat Stabilized Nylon 6.6 – Black

#### Miniature Cross Section

|                  |     |     |      |     |      |     |      |    |    |    |                                  |      |       |
|------------------|-----|-----|------|-----|------|-----|------|----|----|----|----------------------------------|------|-------|
| <b>CBR1M-M30</b> | 4.1 | 104 | .098 | 2.5 | .038 | 1.0 | 1.00 | 25 | 18 | 80 | GTS, GTSL, GS2B, PTS, PPTS, STS2 | 1000 | 50000 |
|------------------|-----|-----|------|-----|------|-----|------|----|----|----|----------------------------------|------|-------|

#### Intermediate Cross Section

|                    |     |     |      |     |      |     |      |    |    |     |                                  |      |       |
|--------------------|-----|-----|------|-----|------|-----|------|----|----|-----|----------------------------------|------|-------|
| <b>CBR1.5I-M30</b> | 5.9 | 150 | .140 | 3.6 | .040 | 1.0 | 1.50 | 38 | 40 | 178 | GTS, GTSL, GS2B, PTS, PPTS, STS2 | 1000 | 25000 |
|--------------------|-----|-----|------|-----|------|-----|------|----|----|-----|----------------------------------|------|-------|

#### Standard Cross Section

|                  |      |     |      |     |      |     |      |     |    |     |  |      |       |
|------------------|------|-----|------|-----|------|-----|------|-----|----|-----|--|------|-------|
| <b>CBR2S-M30</b> | 7.6  | 193 | .190 | 4.8 | .044 | 1.1 | 2.00 | 51  | 50 | 222 | GTS, GTSL, GS2B, GTH, GS4H, PTS, PTH, PPTS, STS2, STH2 | 1000 | 10000 |
| <b>CBR3S-M30</b> | 10.8 | 274 | .190 | 4.8 | .052 | 1.3 | 3.00 | 76  | 50 | 222 |  | 1000 | 5000  |
| <b>CBR4S-M30</b> | 14.0 | 356 | .190 | 4.8 | .052 | 1.3 | 4.00 | 102 | 50 | 222 |  | 1000 | 5000  |

#### Light-Heavy Cross Section

|                    |      |     |      |     |      |     |      |     |     |     |                                    |     |      |
|--------------------|------|-----|------|-----|------|-----|------|-----|-----|-----|------------------------------------|-----|------|
| <b>CBR4LH-TL30</b> | 14.6 | 371 | .300 | 7.6 | .070 | 1.8 | 4.00 | 102 | 120 | 534 | GTH, GS4H, GS4EH, PTH, STH2, ST3EH | 250 | 2500 |
| <b>CBR6LH-C30</b>  | 20.9 | 531 | .300 | 7.6 | .070 | 1.8 | 6.00 | 152 | 120 | 534 |                                    | 100 | 2000 |

### Heat Stabilized Nylon 6.6 – Natural

#### Standard Cross Section

|                  |     |     |      |     |      |     |      |    |    |     |  |      |       |
|------------------|-----|-----|------|-----|------|-----|------|----|----|-----|--|------|-------|
| <b>CBR2S-M39</b> | 7.6 | 193 | .190 | 4.8 | .044 | 1.1 | 2.00 | 51 | 50 | 222 | GTS, GTSL, GS2B, GTH, GS4H, PTS, PTH, PPTS, STS2, STH2 | 1000 | 10000 |
|------------------|-----|-----|------|-----|------|-----|------|----|----|-----|--|------|-------|

### Flame Retardant Nylon 6.6 – Natural Ivory

#### Standard Cross Section

|                  |      |     |      |     |      |     |      |    |    |     |  |      |      |
|------------------|------|-----|------|-----|------|-----|------|----|----|-----|--|------|------|
| <b>CBR3S-M69</b> | 10.8 | 274 | .190 | 4.8 | .052 | 1.3 | 3.00 | 76 | 50 | 222 | GTS, GTSL, GS2B, GTH, GS4H, PTS, PTH, PPTS, STS2, STH2 | 1000 | 5000 |
|------------------|------|-----|------|-----|------|-----|------|----|----|-----|--|------|------|

Note: UL Recognized, UL Listed, and CSA Certified, except CBR3S-M69.



## Belt-Ty™ In-Line Cable Ties – Nylon and Weather Resistant Nylon 6.6

- Natural nylon material for indoor use
- Weather resistant material has greater resistance to damage caused by ultraviolet light – indoor or outdoor use
- Parallel-entry cable tie that threads like a belt (180° entry)
- Low profile head avoids snags and reduces overall bundle size
- 35% lower head height than conventional 90° ties

- Parallel-entry limits exposure to sharp edges and protects workers' arms/hands
- Curved tip is easy to pick up from flat surfaces and allows faster initial threading to speed installation
- Nylon 6.6 cable ties are UL Listed for use in plenum or air handling spaces per NEC



ILT2S-C



ILT2S-C0

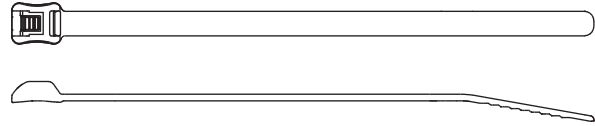

| Part Number | Length |    | Width |    | Thickness |    | Max. Bundle Dia. |    | Min. Loop Tensile Str. |   | Recommended Installation Tool | Std. Pkg. Qty. | Std. Ctn. Qty. |
|-------------|--------|----|-------|----|-----------|----|------------------|----|------------------------|---|-------------------------------|----------------|----------------|
|             | In.    | mm | In.   | mm | In.       | mm | In.              | mm | Lbs.                   | N |                               |                |                |

### Nylon 6.6

#### Standard Cross Section – Plenum-Rated

|                |      |     |      |     |      |     |      |     |    |     |  |     |      |
|----------------|------|-----|------|-----|------|-----|------|-----|----|-----|--|-----|------|
| <b>ILT2S-C</b> | 8.3  | 211 | .190 | 4.8 | .052 | 1.3 | 1.88 | 48  | 50 | 222 | GTS, GTSL, GS2B, GTH, GS4H, PTS, PTH, PPTS, STS2, STH2 | 100 | 1000 |
| <b>ILT3S-C</b> | 11.5 | 292 | .190 | 4.8 | .052 | 1.3 | 3.00 | 76  | 50 | 222 |  | 100 | 1000 |
| <b>ILT4S-C</b> | 14.7 | 373 | .190 | 4.8 | .052 | 1.3 | 4.00 | 102 | 50 | 222 |  | 100 | 1000 |

#### Light-Heavy Cross Section – Plenum-Rated

|                  |      |     |      |     |      |     |      |     |     |     |                                    |     |      |
|------------------|------|-----|------|-----|------|-----|------|-----|-----|-----|------------------------------------|-----|------|
| <b>ILT4LH-TL</b> | 14.8 | 376 | .300 | 7.6 | .075 | 1.9 | 4.00 | 102 | 120 | 534 | GTH, GS4H, GS4EH, PTH, STH2, ST3EH | 250 | 2500 |
| <b>ILT6LH-C</b>  | 21.2 | 538 | .300 | 7.6 | .075 | 1.9 | 6.00 | 152 | 120 | 534 |                                    | 100 | 2000 |

### Weather Resistant Nylon 6.6

#### Standard Cross Section

|                 |      |     |      |     |      |     |      |     |    |     |  |     |      |
|-----------------|------|-----|------|-----|------|-----|------|-----|----|-----|--|-----|------|
| <b>ILT2S-C0</b> | 8.3  | 211 | .190 | 4.8 | .052 | 1.3 | 1.88 | 48  | 50 | 222 | GTS, GTSL, GS2B, GTH, GS4H, PTS, PTH, PPTS, STS2, STH2 | 100 | 1000 |
| <b>ILT3S-C0</b> | 11.5 | 292 | .190 | 4.8 | .052 | 1.3 | 3.00 | 76  | 50 | 222 |  | 100 | 1000 |
| <b>ILT4S-C0</b> | 14.7 | 373 | .190 | 4.8 | .052 | 1.3 | 4.00 | 102 | 50 | 222 |  | 100 | 1000 |

#### Light-Heavy Cross Section

|                   |      |     |      |     |      |     |      |     |     |     |                                    |     |      |
|-------------------|------|-----|------|-----|------|-----|------|-----|-----|-----|------------------------------------|-----|------|
| <b>ILT4LH-TL0</b> | 14.8 | 376 | .300 | 7.6 | .075 | 1.9 | 4.00 | 102 | 120 | 534 | GTH, GS4H, GS4EH, PTH, STH2, ST3EH | 250 | 2500 |
| <b>ILT6LH-C0</b>  | 21.2 | 538 | .300 | 7.6 | .075 | 1.9 | 6.00 | 152 | 120 | 534 |                                    | 100 | 2000 |

Weather resistant nylon 6.6 cable ties are UL Recognized, UL Listed, and CSA Certified, except ILT4LH/6LH.

A. System Overview

B1. Cable Ties

B2. Cable Accessories

B3. Stainless Steel Ties

C1. Wiring Duct

C2. Surface Raceway

C3. Abrasion Protection

C4. Cable Management

D1. Terminals

D2. Power Connectors

D3. Grounding Connectors

E1. Labeling Systems

E2. Labels

E3. Pre-Printed & Write-On Markers

E4. Permanent Identification

E5. Lockout/Tagout & Safety Solutions

F. Index

A. System Overview

## Hyper-V™ In-Line Cable Ties – Weather Resistant Nylon 6.6

B1. Cable Ties

- Fixed and flexible two-wedge locking design provides a low threading force
- Teeth on both sides of cable tie body provide additional locking strength and improved flexibility to conform to irregular bundle shapes such as securing cables to cable tray systems
- Releasable head position for temporary bundling of cables prior to final locking; no need to replace ties when adding cables/wires to the bundle
- Teeth on full length of body support a wide range of bundle diameters
- Bending serrations on the tip of the tie allow the tip to be easily formed into an arc, enabling installer to “fish” the tie around the bundle in a confined space
- Threading hole in the tip of the tie allows an installer to hook the tip with a simple device to pull the tie through spaces with limited access
- In-Line tie design for parallel-entry of the tie into head resulting in a lower profile on cable bundles
- Complementary mounts shown below

B2. Cable Accessories

B3. Stainless Steel Ties

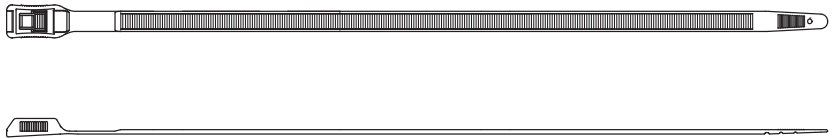

C1. Wiring Duct

C2. Surface Raceway

C3. Abrasion Protection

C4. Cable Management

| Part Number      | Length |     | Width |     | Thickness |     | Max. Bundle Dia. |     | Min. Loop Tensile Str. |     | Recommended Installation Tool            | Std. Pkg. Qty. | Std. Ctn. Qty. |
|------------------|--------|-----|-------|-----|-----------|-----|------------------|-----|------------------------|-----|--|----------------|----------------|
|                  | In.    | mm  | In.   | mm  | In.       | mm  | In.              | mm  | Lbs.                   | N   |  |                |                |
| <b>HV965-C0</b>  | 10.4   | 265 | .350  | 8.9 | .076      | 1.9 | 2.60             | 65  | 160                    | 710 | GTH, GS4H, GS4EH, PTH, STH2, ST3EH, STHV | 100            | 1000           |
| <b>HV9100-C0</b> | 14.4   | 367 | .350  | 8.9 | .076      | 1.9 | 3.90             | 100 | 160                    | 710 |  | 100            | 1000           |
| <b>HV9150-C0</b> | 20.7   | 525 | .350  | 8.9 | .076      | 1.9 | 5.90             | 150 | 160                    | 710 |  | 100            | 1000           |
| <b>HV9250-C0</b> | 33.1   | 841 | .350  | 8.9 | .076      | 1.9 | 9.80             | 250 | 160                    | 710 |  | 100            | 1000           |

D1. Terminals

D2. Power Connectors

D3. Grounding Connectors

E1. Labeling Systems

E2. Labels

## Hyper-V™ Cable Tie Mounts

- Tie mount has retaining tab within window to hold cable tie in position when pre-installed in the mount; low profile design keeps bundle close to mounting surface
- Masonry mounts are used to secure wire, cable, or tubing to masonry surfaces
- For outdoor use



HVTM

HVMPM

E3. Pre-Printed & Write-On Markers

E4. Permanent Identification

E5. Lockout/Tagout & Safety Solutions

F. Index

| Part Number           | Material                                    | Color | Mounting Method                          | Std. Pkg. Qty. | Std. Ctn. Qty. |
|-----------------------|---|-------|--|----------------|----------------|
| <b>Tie Mounts</b>     |   |       |  |                |                |
| <b>HVTM3S10-C0</b>    | Weather Resistant Nylon 6.6                 | Black | #10 (6mm) screw                          | 100            | 500            |
| <b>Masonry Mounts</b> |   |       |  |                |                |
| <b>HVMPM32-C0</b>     | Impact Modified Weather Resistant Nylon 6.6 | Black | Tree barb for .31" (7.9mm) hole diameter | 100            | 500            |

Note: UL Recognized except HVTM mount.

## IN-LINE Cable Ties – Weather Resistant Nylon 6.6

- Greater resistance to damage caused by ultraviolet light – indoor or outdoor use
- Parallel-entry cable tie that threads like a belt (180° entry)
- Wide tie body provides high tensile strength
- 50% lower head height than conventional 90° ties
- Parallel-entry limits exposure to sharp edges and protects workers' arms/hands
- Outside teeth protect cable jacket and wire insulation
- Outside teeth protect cable jacket and wire insulation
- "Finger grip" shaped head with serrations assures positive grip while threading tie
- Install by hand or use Panduit GTH installation tool, see page B1.111
- Flexible – easy to handle and install
- Available in UV weather resistant colors for color coordination and UV stability

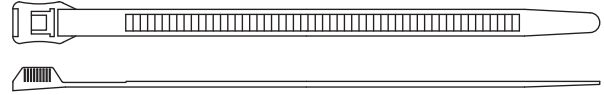

| Part Number               | Color           | Length |     | Width |     | Thickness |     | Max. Bundle Dia. |     | Min. Loop Tensile Str. |     | Std. Pkg. Qty | Std. Ctn. Qty. |
|---------------------------|-----------------|--------|-----|-------|-----|-----------|-----|------------------|-----|------------------------|-----|---------------|----------------|
|                           |                 | In.    | mm  | In.   | mm  | In.       | mm  | In.              | mm  | Lbs.                   | N   |               |                |
| <b>Black Cable Ties</b>   |                 |        |     |       |     |           |     |                  |     |                        |     |               |                |
| IT940-C0                  | UV Black        | 6.8    | 173 | .350  | 8.9 | .065      | 1.7 | 1.57             | 40  | 124                    | 552 | 100           | 1000           |
| IT965-C0                  | UV Black        | 10.1   | 257 | .350  | 8.9 | .065      | 1.7 | 2.56             | 65  | 124                    | 552 | 100           | 1000           |
| <b>IT9100-C0</b>          | UV Black        | 14.1   | 358 | .350  | 8.9 | .065      | 1.7 | 3.94             | 100 | 124                    | 552 | 100           | 1000           |
| IT9115-C0                 | UV Black        | 15.3   | 389 | .350  | 8.9 | .065      | 1.7 | 4.53             | 115 | 124                    | 552 | 100           | 1000           |
| <b>Colored Cable Ties</b> |                 |        |     |       |     |           |     |                  |     |                        |     |               |                |
| IT9100-CUV2               | UV Red          | 14.1   | 358 | .350  | 8.9 | .065      | 1.7 | 3.94             | 100 | 124                    | 552 | 100           | 1000           |
| IT9100-CUV4Y              | UV Yellow       | 14.1   | 358 | .350  | 8.9 | .065      | 1.7 | 3.94             | 100 | 124                    | 552 | 100           | 1000           |
| IT9100-CUV6               | UV Dark Blue    | 14.1   | 358 | .350  | 8.9 | .065      | 1.7 | 3.94             | 100 | 124                    | 552 | 100           | 1000           |
| IT9100-CUV6A              | UV Light Blue   | 14.1   | 358 | .350  | 8.9 | .065      | 1.7 | 3.94             | 100 | 124                    | 552 | 100           | 1000           |
| IT9100-CUV7A              | UV Purple       | 14.1   | 358 | .350  | 8.9 | .065      | 1.7 | 3.94             | 100 | 124                    | 552 | 100           | 1000           |
| IT9100-CUV8               | UV Silver       | 14.1   | 358 | .350  | 8.9 | .065      | 1.7 | 3.94             | 100 | 124                    | 552 | 100           | 1000           |
| IT9100-CUV16B             | UV Magenta      | 14.1   | 358 | .350  | 8.9 | .065      | 1.7 | 3.94             | 100 | 124                    | 552 | 100           | 1000           |
| IT9115-CUV2               | UV Red          | 15.3   | 389 | .350  | 8.9 | .065      | 1.7 | 4.53             | 115 | 124                    | 552 | 100           | 1000           |
| IT9115-CUV2A              | UV Bright Red   | 15.3   | 389 | .350  | 8.9 | .065      | 1.7 | 4.53             | 115 | 124                    | 552 | 100           | 1000           |
| IT9115-CUV4Y              | UV Yellow       | 15.3   | 389 | .350  | 8.9 | .065      | 1.7 | 4.53             | 115 | 124                    | 552 | 100           | 1000           |
| IT9115-CUV4A              | UV Butterscotch | 15.3   | 389 | .350  | 8.9 | .065      | 1.7 | 4.53             | 115 | 124                    | 552 | 100           | 1000           |
| IT9115-CUV5A              | UV Green        | 15.3   | 389 | .350  | 8.9 | .065      | 1.7 | 4.53             | 115 | 124                    | 552 | 100           | 1000           |
| IT9115-CUV5B              | UV Hunter Green | 15.3   | 389 | .350  | 8.9 | .065      | 1.7 | 4.53             | 115 | 124                    | 552 | 100           | 1000           |
| IT9115-CUV6               | UV Dark Blue    | 15.3   | 389 | .350  | 8.9 | .065      | 1.7 | 4.53             | 115 | 124                    | 552 | 100           | 1000           |
| IT9115-CUV6A              | UV Light Blue   | 15.3   | 389 | .350  | 8.9 | .065      | 1.7 | 4.53             | 115 | 124                    | 552 | 100           | 1000           |
| IT9115-CUV6B              | UV Cobalt Blue  | 15.3   | 389 | .350  | 8.9 | .065      | 1.7 | 4.53             | 115 | 124                    | 552 | 100           | 1000           |
| IT9115-CUV7A              | UV Purple       | 15.3   | 389 | .350  | 8.9 | .065      | 1.7 | 4.53             | 115 | 124                    | 552 | 100           | 1000           |
| IT9115-CUV8               | UV Gray         | 15.3   | 389 | .350  | 8.9 | .065      | 1.7 | 4.53             | 115 | 124                    | 552 | 100           | 1000           |
| IT9115-CUV11              | UV Teal         | 15.3   | 389 | .350  | 8.9 | .065      | 1.7 | 4.53             | 115 | 124                    | 552 | 100           | 1000           |
| IT9115-CUV16B             | UV Magenta      | 15.3   | 389 | .350  | 8.9 | .065      | 1.7 | 4.53             | 115 | 124                    | 552 | 100           | 1000           |
| IT9115-CUV18              | UV Tan          | 15.3   | 389 | .350  | 8.9 | .065      | 1.7 | 4.53             | 115 | 124                    | 552 | 100           | 1000           |

A.  
System  
Overview

## Parallel-Entry Cable Ties

B1.  
Cable Ties

### Material and Color Chart

B2.  
Cable  
Accessories

B3.  
Stainless  
Steel Ties

C1.  
Wiring  
Duct

C2.  
Surface  
Raceway

C3.  
Abrasion  
Protection

C4.  
Cable  
Management

D1.  
Terminals

D2.  
Power  
Connectors

D3.  
Grounding  
Connectors

E1.  
Labeling  
Systems

E2.  
Labels

E3.  
Pre-Printed  
& Write-On  
Markers

E4.  
Permanent  
Identification

E5.  
Lockout/  
Tagout  
& Safety  
Solutions

F.  
Index

| Material                    | Color           | Panduit Suffix |
|-----------------------------|-----------------|----------------|
| Nylon 6.6                   | Natural         | ✓              |
| Weather Resistant Nylon 6.6 | Black           | 0              |
| Nylon 6.6                   | Brown           | 1              |
| Nylon 6.6                   | Red             | 2              |
| Nylon 6.6                   | Orange          | 3              |
| Nylon 6.6                   | Yellow          | 4Y             |
| Nylon 6.6                   | Green           | 5              |
| Nylon 6.6                   | Blue            | 6              |
| Nylon 6.6                   | Purple          | 7              |
| Nylon 6.6                   | Gray            | 8              |
| Nylon 6.6                   | White           | 10             |
| Heat Stabilized Nylon 6.6   | Black           | 30             |
| Heat Stabilized Nylon 6.6   | Natural         | 39             |
| Flame Retardant Nylon 6.6   | Natural (Ivory) | 69             |

| Material  | Color                    | Panduit Suffix |
|-----------|--------------------------|----------------|
| Nylon 6.6 | Ultraviolet Red          | UV2            |
| Nylon 6.6 | Ultraviolet Bright Red   | UV2A           |
| Nylon 6.6 | Ultraviolet Yellow       | UV4Y           |
| Nylon 6.6 | Ultraviolet Butterscotch | UV4A           |
| Nylon 6.6 | Ultraviolet Green        | UV5A           |
| Nylon 6.6 | Ultraviolet Hunter Green | UV5B           |
| Nylon 6.6 | Ultraviolet Dark Blue    | UV6            |
| Nylon 6.6 | Ultraviolet Light Blue   | UV6A           |
| Nylon 6.6 | Ultraviolet Cobalt Blue  | UV6B           |
| Nylon 6.6 | Ultraviolet Purple       | UV7A           |
| Nylon 6.6 | Ultraviolet Gray         | UV8            |
| Nylon 6.6 | Ultraviolet Teal         | UV11           |
| Nylon 6.6 | Ultraviolet Magenta      | UV16B          |
| Nylon 6.6 | Ultraviolet Tan          | UV18           |

✓Denotes Panduit Natural Nylon 6.6 (no suffix).

### Part Number Availability List

| Part Number | Standard Packaging |                         | Part Number | Bulk Packaging    |   |
|-------------|--------------------|-------------------------|-------------|-------------------|---|
|             | Natural Nylon 6.6  | Material/Color (Suffix) |             | Natural Nylon 6.6 | Material/Color (Suffix)   |
|             |                    |                         | CBR1M-M     | ✓                 | 0,30  |
|             |                    |                         | CBR1.5M-M   | ✓                 | 0   |
|             |                    |                         | CBR2M-M     | ✓                 | 0,1,2,3,4Y,5,6,7  |
|             |                    |                         | CBR1.5I-M   | ✓                 | 0,30  |
|             |                    |                         | CBR3I-M     | ✓                 | 0,1,2,3,4Y,5,6,7,8,10   |
|             |                    |                         | CBR4I-M     | ✓                 | 0   |
|             |                    |                         | CBR2S-M     | ✓                 | 0,30,39   |
|             |                    |                         | CBR3S-M     | ✓                 | 0,30,69   |
|             |                    |                         | CBR4S-M     | ✓                 | 0,30  |
|             |                    |                         | CBR2HS-D    | ✓                 | 0   |
|             |                    |                         | CBR4LH-TL   | ✓                 | 0,30  |
|             |                    |                         | CBR6LH-C    | ✓                 | 0,30  |
|             |                    |                         | HV965-C     |                   | 0   |
|             |                    |                         | HV9100-C    |                   | 0   |
|             |                    |                         | HV9150-C    |                   | 0   |
|             |                    |                         | HV9250-C    |                   | 0   |
| ILT2S-C     | ✓                  | 0                       | ILT2S-M     | ✓                 | 0   |
| ILT3S-C     | ✓                  | 0                       | ILT3S-M     | ✓                 | 0   |
| ILT4S-C     | ✓                  | 0                       | ILT4S-M     | ✓                 | 0   |
|             |                    |                         | ILT4LH-TL   | ✓                 | 0   |
|             |                    |                         | ILT6LH-C    | ✓                 | 0   |
|             |                    |                         | IT940-C     |                   | 0   |
|             |                    |                         | IT965-C     |                   | 0   |
|             |                    |                         | IT9100-C    |                   | 0,UV2,UV4Y,UV6,UV6A,UV7A,UV8,UV16B                                    |
|             |                    |                         | IT9115-C    |                   | 0,UV2,UV2A,UV4Y,UV4A,UV5A,UV5B,UV6,UV6A,UV6B,UV7A,UV8,UV11,UV16B,UV18 |



## Features and Benefits – Sta-Strap® Cable Ties

Two-piece design incorporates a separate nylon head and strap.

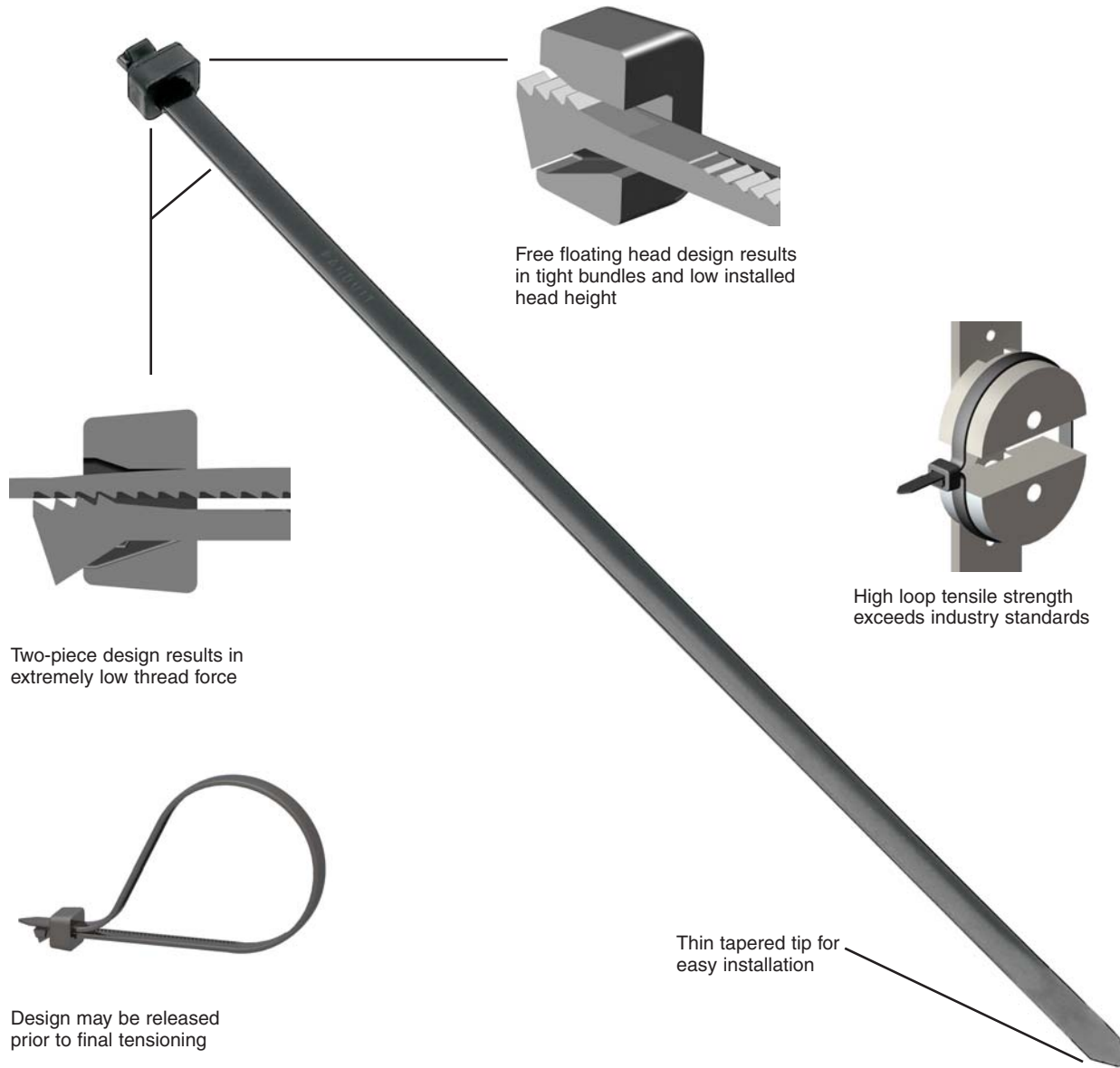

Free floating head design results in tight bundles and low installed head height

High loop tensile strength exceeds industry standards

Two-piece design results in extremely low thread force

Design may be released prior to final tensioning

Thin tapered tip for easy installation



Cable tie tools speed installation and reduce total installed cost. See pages B1.109 – B1.114.



Cable tie accessories are used to speed and simplify the mounting of wires, cables, and tubing. See pages B2.1 – B2.29.

A. System Overview

B1. Cable Ties

B2. Cable Accessories

B3. Stainless Steel Ties

C1. Wiring Duct

C2. Surface Raceway

C3. Abrasion Protection

C4. Cable Management

D1. Terminals

D2. Power Connectors

D3. Grounding Connectors

E1. Labeling Systems

E2. Labels

E3. Pre-Printed & Write-On Markers

E4. Permanent Identification

E5. Lockout/Tagout & Safety Solutions

F. Index

A. System Overview

## Selection Guide – Sta-Strap® Cable Ties

B1. Cable Ties



B2. Cable Accessories

B3. Stainless Steel Ties

C1. Wiring Duct

| Material, Color (Suffix)       | Style/Function       | Part Number Prefix | Catalog Page |
|--------------------------------|----------------------|--------------------|--------------|
| Nylon 6.6, Natural (No Suffix) | Locking Ties/Bundle  | SST                | B1.67        |
|                                | Clamp Ties/Mount     | SSC                | B1.70        |
|                                | Marker Ties/Identify | SSM                | B1.71        |

C2. Surface Raceway

C3. Abrasion Protection

|  |                      |     |       |
|--|----------------------|-----|-------|
| Weather Resistant Nylon 6.6, Black (0) | Locking Ties/Bundle  | SST | B1.68 |
|  | Clamp Ties/Mount     | SSC | B1.70 |
|  | Marker Ties/Identify | SSM | B1.71 |

C4. Cable Management

|                                       |                     |     |       |
|---------------------------------------|---------------------|-----|-------|
| Heat Stabilized Nylon 6.6, Black (30) | Locking Ties/Bundle | SST | B1.69 |
|                                       | Clamp Ties/Mount    | SSC | B1.70 |

D1. Terminals

D2. Power Connectors

D3. Grounding Connectors

E1. Labeling Systems

E2. Labels

### Part Number System for Sta-Strap® Cable Ties

**SST**

**1**

**M**

—

**C**

—

Type

Size

Cross Section

Screw Hole Size

Package Size

Material/Color

SST = Locking Tie  
SSC = Clamp Tie  
SSM = Marker Tie

Approx. Maximum Bundle Dia. (In.)

M = Miniature  
I = Intermediate  
S = Standard  
H = Heavy  
HH = Heavy Head

(Clamp Ties Only)  
-S6 = #6 (M3)  
-S10 = #10 (M5)  
-S25 = 1/4 (M6)

L = 50  
C = 100  
D = 500  
M = 1000

See Page B1.72

E4. Permanent Identification

E5. Lockout/Tagout & Safety Solutions

F. Index

## UL® US C SP® Sta-Strap® Cable Ties – Nylon 6.6

- For indoor use
- Used for normal bundling and through-panel applications
- Small head height allows more efficient use of space in compact areas

- Exclusive two-piece design offers the lowest threading force in the industry
- Average 14% lighter than one-piece cable ties
- Releasable prior to final tensioning for bundle modifications

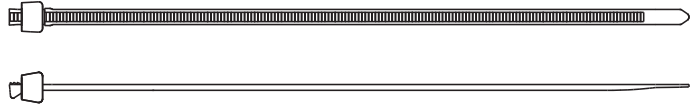

| Part Number                       | Length |     | Width |     | Thickness |     | Max. Bundle Dia. |     | Min. Loop Tensile Str. |     | Recommended Installation Tool                          | Std. Pkg. Qty. | Std. Ctn. Qty. |
|-----------------------------------|--------|-----|-------|-----|-----------|-----|------------------|-----|------------------------|-----|--|----------------|----------------|
|                                   | In.    | mm  | In.   | mm  | In.       | mm  | In.              | mm  | Lbs.                   | N   |  |                |                |
| <b>Miniature Cross Section</b>    |        |     |       |     |           |     |                  |     |                        |     |  |                |                |
| <b>SST1M-C</b>                    | 4.0    | 102 | .095  | 2.4 | .035      | .9  | .78              | 20  | 18                     | 80  | GTS, GTSL, GS2B, PTS, PPTS, STS2                       | 100            | 1000           |
| <b>SST1.5M-C</b>                  | 5.5    | 140 | .095  | 2.4 | .037      | .9  | 1.25             | 32  | 18                     | 80  |  | 100            | 1000           |
| <b>Intermediate Cross Section</b> |        |     |       |     |           |     |                  |     |                        |     |  |                |                |
| <b>SST1.5I-C</b>                  | 5.3    | 137 | .135  | 3.4 | .037      | .9  | 1.25             | 32  | 40                     | 178 | GTS, GTSL, GS2B, PTS, PPTS, STS2                       | 100            | 1000           |
| <b>SST2I-C</b>                    | 8.1    | 206 | .135  | 3.4 | .040      | 1.0 | 2.00             | 51  | 40                     | 178 |  | 100            | 1000           |
| <b>SST3I-C</b>                    | 11.0   | 279 | .135  | 3.4 | .040      | 1.0 | 3.00             | 76  | 40                     | 178 |  | 100            | 1000           |
| <b>SST4I-C</b>                    | 14.7   | 375 | .135  | 3.4 | .040      | 1.0 | 4.00             | 102 | 40                     | 178 |  | 100            | 1000           |
| <b>Standard Cross Section</b>     |        |     |       |     |           |     |                  |     |                        |     |  |                |                |
| <b>SST1.5S-M</b>                  | 5.7    | 146 | .180  | 4.6 | .045      | 1.2 | 1.25             | 32  | 50                     | 222 | GTS, GTSL, GS2B, GTH, GS4H, PTS, PTH, PPTS, STS2, STH2 | 1000           | 25000          |
| <b>SST2S-C</b>                    | 6.7    | 172 | .180  | 4.6 | .045      | 1.2 | 1.75             | 45  | 50                     | 222 |  | 100            | 1000           |
| <b>SST3S-C</b>                    | 11.0   | 279 | .180  | 4.6 | .048      | 1.2 | 3.00             | 76  | 50                     | 222 |  | 100            | 1000           |
| <b>SST4S-C</b>                    | 15.0   | 381 | .180  | 4.6 | .048      | 1.2 | 4.00             | 102 | 50                     | 222 |  | 100            | 1000           |
| <b>Light-Heavy Cross Section</b>  |        |     |       |     |           |     |                  |     |                        |     |  |                |                |
| <b>SST2H-D</b>                    | 8.0    | 203 | .300  | 7.6 | .062      | 1.6 | 2.00             | 51  | 120                    | 534 | GTH, GS4H, GS4EH, PTH, STH2, ST3EH                     | 500            | 5000           |
| <b>SST4H-L</b>                    | 14.8   | 376 | .300  | 7.6 | .067      | 1.7 | 4.00             | 102 | 120                    | 534 |  | 50             | 500            |
| <b>SST8H-L</b>                    | 27.5   | 699 | .300  | 7.6 | .067      | 1.7 | 8.00             | 203 | 120                    | 534 |  | 50             | 500            |

A. System Overview

B1. Cable Ties

B2. Cable Accessories

B3. Stainless Steel Ties

C1. Wiring Duct

C2. Surface Raceway

C3. Abrasion Protection

C4. Cable Management

D1. Terminals

D2. Power Connectors

D3. Grounding Connectors

E1. Labeling Systems

E2. Labels

E3. Pre-Printed & Write-On Markers

E4. Permanent Identification

E5. Lockout/Tagout & Safety Solutions

F. Index

A.  
System  
Overview

## **PA** **US** **SP** **US** Sta-Strap® Cable Ties – Weather Resistant Nylon 6.6

B1.  
Cable Ties

- Greater resistance to damage caused by ultraviolet light – indoor or outdoor use
- Used for normal bundling and through-panel applications
- Small head height allows more efficient use of space in compact areas
- Exclusive two-piece design offers the lowest threading force in the industry
- Average 14% lighter than one-piece cable ties
- Releasable prior to final tensioning for bundle modifications

B2.  
Cable  
Accessories



B3.  
Stainless  
Steel Ties

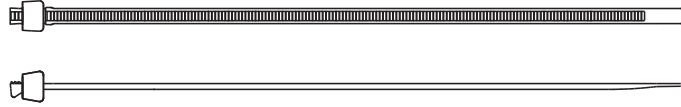

C1.  
Wiring  
Duct

C2.  
Surface  
Raceway

| Part Number                       | Length |     | Width |     | Thickness |     | Max. Bundle Dia. |     | Min. Loop Tensile Str. |     | Recommended Installation Tool                          | Std. Pkg. Qty. | Std. Ctn. Qty. |
|-----------------------------------|--------|-----|-------|-----|-----------|-----|------------------|-----|------------------------|-----|--|----------------|----------------|
|                                   | In.    | mm  | In.   | mm  | In.       | mm  | In.              | mm  | Lbs.                   | N   |  |                |                |
| <b>Miniature Cross Section</b>    |        |     |       |     |           |     |                  |     |                        |     |  |                |                |
| <b>SST1M-C0</b>                   | 4.0    | 102 | .095  | 2.4 | .035      | .9  | .78              | 20  | 18                     | 80  | GTS, GTSL, GS2B, PTS, PPTS, STS2                       | 100            | 1000           |
| <b>SST1.5M-M0</b>                 | 5.5    | 140 | .095  | 2.4 | .037      | .9  | 1.25             | 32  | 18                     | 80  |  | 1000           | 50000          |
| <b>Intermediate Cross Section</b> |        |     |       |     |           |     |                  |     |                        |     |  |                |                |
| <b>SST1.5I-M0</b>                 | 5.3    | 137 | .135  | 3.4 | .037      | .9  | 1.25             | 32  | 40                     | 178 | GTS, GTSL, GS2B, PTS, PPTS, STS2                       | 1000           | 25000          |
| <b>SST2I-M0</b>                   | 8.1    | 206 | .135  | 3.4 | .040      | 1.0 | 2.00             | 51  | 40                     | 178 |  | 1000           | 25000          |
| <b>SST3I-C0</b>                   | 11.0   | 279 | .135  | 3.4 | .040      | 1.0 | 3.00             | 76  | 40                     | 178 |  | 100            | 1000           |
| <b>SST4I-M0</b>                   | 14.7   | 375 | .135  | 3.4 | .040      | 1.0 | 4.00             | 102 | 40                     | 178 |  | 1000           | 10000          |
| <b>Standard Cross Section</b>     |        |     |       |     |           |     |                  |     |                        |     |  |                |                |
| <b>SST1.5S-M0</b>                 | 5.7    | 146 | .180  | 4.6 | .045      | 1.2 | 1.25             | 32  | 50                     | 222 | GTS, GTSL, GS2B, GTH, GS4H, PTS, PTH, PPTS, STS2, STH2 | 1000           | 25000          |
| <b>SST2S-C0</b>                   | 6.7    | 172 | .180  | 4.6 | .045      | 1.2 | 1.75             | 45  | 50                     | 222 |  | 100            | 1000           |
| <b>SST3S-C0</b>                   | 11.0   | 279 | .180  | 4.6 | .048      | 1.2 | 3.00             | 76  | 50                     | 222 |  | 100            | 1000           |
| <b>SST4S-C0</b>                   | 15.0   | 381 | .180  | 4.6 | .048      | 1.2 | 4.00             | 102 | 50                     | 222 |  | 100            | 1000           |
| <b>Light-Heavy Cross Section</b>  |        |     |       |     |           |     |                  |     |                        |     |  |                |                |
| <b>SST2H-D0</b>                   | 8.0    | 203 | .300  | 7.6 | .062      | 1.6 | 2.00             | 51  | 120                    | 534 | GTH, GS4H, GS4EH, PTH, STH2, ST3EH                     | 500            | 5000           |
| <b>SST4H-L0</b>                   | 14.8   | 376 | .300  | 7.6 | .067      | 1.7 | 4.00             | 102 | 120                    | 534 |  | 50             | 500            |
| <b>SST8H-L0</b>                   | 27.5   | 699 | .300  | 7.6 | .067      | 1.7 | 8.00             | 203 | 120                    | 534 |  | 50             | 500            |

E1.  
Labeling  
Systems

E2.  
Labels

E3.  
Pre-Printed  
& Write-On  
Markers

E4.  
Permanent  
Identification

E5.  
Lockout/  
Tagout  
& Safety  
Solutions

F.  
Index

## UL® cUL® Sta-Strap® Cable Ties – Heat Stabilized Nylon 6.6

- For high temperature applications up to 239°F (115°C) – indoor use
- Used for normal bundling and through-panel applications
- *Heavy head* design is available for use in through-panel applications with a larger opening up to .400" (10.2mm)
- Small head height allows more efficient use of space in compact areas

- Exclusive two-piece design offers the lowest threading force in the industry
- Average 14% lighter than one-piece cable ties
- Releasable prior to final tensioning for bundle modifications

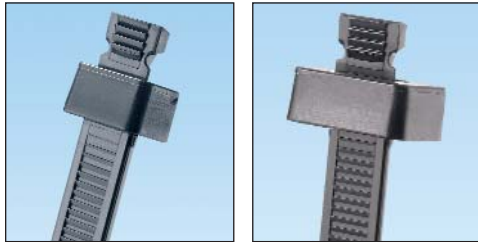

SST

SST2HH

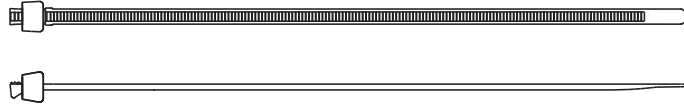

| Part Number  | Length |     | Width |     | Thickness |     | Max. Bundle Dia. |     | Min. Loop Tensile Str. |     | Recommended Installation Tool                          | Std. Pkg. Qty. | Std. Ctn. Qty. |
|--|--------|-----|-------|-----|-----------|-----|------------------|-----|------------------------|-----|--|----------------|----------------|
|  | In.    | mm  | In.   | mm  | In.       | mm  | In.              | mm  | Lbs.                   | N   |  |                |                |
| <b>Miniature Cross Section</b>                     |        |     |       |     |           |     |                  |     |                        |     |  |                |                |
| <b>SST1M-M30</b>                                   | 4.0    | 102 | .095  | 2.4 | .035      | .9  | .78              | 20  | 18                     | 80  | GTS, GTSL, GS2B, PTS, PPTS, STS2                       | 1000           | 50000          |
| <b>SST1.5M-M30</b>                                 | 5.5    | 140 | .095  | 2.4 | .037      | .9  | 1.25             | 32  | 18                     | 80  |  | 1000           | 50000          |
| <b>Standard Cross Section</b>                      |        |     |       |     |           |     |                  |     |                        |     |  |                |                |
| <b>SST2S-M30</b>                                   | 6.7    | 172 | .180  | 4.6 | .045      | 1.2 | 1.75             | 45  | 50                     | 222 | GTS, GTSL, GS2B, GTH, GS4H, PTS, PTH, PPTS, STS2, STH2 | 1000           | 15000          |
| <b>SST3S-M30</b>                                   | 11.0   | 279 | .180  | 4.6 | .048      | 1.2 | 3.00             | 76  | 50                     | 222 |  | 1000           | 10000          |
| <b>SST4S-M30</b>                                   | 15.0   | 381 | .180  | 4.6 | .048      | 1.2 | 4.00             | 102 | 50                     | 222 |  | 1000           | 5000           |
| <b>Light-Heavy Cross Section</b>                   |        |     |       |     |           |     |                  |     |                        |     |  |                |                |
| <b>SST4H-D30</b>                                   | 14.8   | 376 | .300  | 7.6 | .067      | 1.7 | 4.00             | 102 | 120                    | 534 | GTH, GS4H, GS4EH, PTH, STH2, ST3EH                     | 500            | 2500           |
| <b>SST8H-D30</b>                                   | 27.5   | 699 | .300  | 7.6 | .067      | 1.7 | 8.00             | 203 | 120                    | 534 |  | 500            | 2000           |
| <b>Heavy Head Design Light-Heavy Cross Section</b> |        |     |       |     |           |     |                  |     |                        |     |  |                |                |
| <b>SST2HH-D30</b>                                  | 8.0    | 203 | .300  | 7.6 | .062      | 1.6 | 2.00             | 50  | 120                    | 534 | GTH, GS4H, GS4EH, PTH, STH2, ST3EH                     | 500            | 2500           |
| <b>SST4HH-D30</b>                                  | 14.8   | 376 | .300  | 7.6 | .062      | 1.6 | 4.00             | 102 | 120                    | 534 |  | 500            | 2500           |

A. System Overview

B1. Cable Ties

B2. Cable Accessories

B3. Stainless Steel Ties

C1. Wiring Duct

C2. Surface Raceway

C3. Abrasion Protection

C4. Cable Management

D1. Terminals

D2. Power Connectors

D3. Grounding Connectors

E1. Labeling Systems

E2. Labels

E3. Pre-Printed & Write-On Markers

E4. Permanent Identification

E5. Lockout/Tagout & Safety Solutions

F. Index



A. System Overview

## UL® cUL® Sta-Strap® Clamp Ties

- Natural nylon material for indoor use
- Weather resistant material has greater resistance to damage caused by ultraviolet light – indoor or outdoor use
- Heat stabilized material for high temperature applications up to 239°F (115°C) – indoor use
- Design allows for bundling before or after screwing clamp in place

- Exclusive two-piece design offers the lowest threading force in the industry
- Used to secure a cable bundle to another surface such as a control panel, communication rack, wall or ceiling
- Only clamp tie that is releasable prior to final tensioning



SSC2S-S10-C



SSC2S-S10-M0

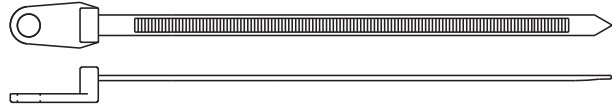

B1. Cable Ties

B2. Cable Accessories

B3. Stainless Steel Ties

C1. Wiring Duct

C2. Surface Raceway

C3. Abrasion Protection

C4. Cable Management

D1. Terminals

D2. Power Connectors

D3. Grounding Connectors

E1. Labeling Systems

E2. Labels

E3. Pre-Printed & Write-On Markers

E4. Permanent Identification

E5. Lockout/Tagout & Safety Solutions

F. Index

| Part Number | Length |    | Width |    | Thickness |    | Nominal Hole Dia. |    | Screw Size | Metric Screw Size | Max. Bundle Dia. |    | Min. Loop Tensile Str. |   | Recommended Installation Tool | Std. Pkg. Qty. | Std. Ctn. Qty. |
|-------------|--------|----|-------|----|-----------|----|-------------------|----|------------|-------------------|------------------|----|------------------------|---|-------------------------------|----------------|----------------|
|             | In.    | mm | In.   | mm | In.       | mm | In.               | mm |            |                   | In.              | mm | Lbs.                   | N |                               |                |                |

### Nylon 6.6

#### Standard Cross Section

|                    |      |     |      |     |      |     |      |     |     |    |      |     |    |     |  |     |      |
|--------------------|------|-----|------|-----|------|-----|------|-----|-----|----|------|-----|----|-----|--|-----|------|
| SSC2S-S6-C         | 7.4  | 187 | .180 | 4.6 | .045 | 1.1 | .148 | 3.8 | #6  | M3 | 1.75 | 45  | 50 | 222 | GTS, GTSL, GS2B, GTH, GS4H, PTS, PTH, PPTS, STS2, STH2 | 100 | 1000 |
| <b>SSC2S-S10-C</b> | 7.4  | 187 | .180 | 4.6 | .045 | 1.1 | .200 | 5.1 | #10 | M5 | 1.75 | 45  | 50 | 222 |  | 100 | 1000 |
| SSC4S-S10-C        | 15.7 | 398 | .180 | 4.6 | .045 | 1.1 | .200 | 5.1 | #10 | M5 | 4.00 | 102 | 50 | 222 |  | 100 | 500  |

#### Light-Heavy Cross Section

|             |      |     |      |     |      |     |      |     |     |    |      |     |     |     |                                    |    |     |
|-------------|------|-----|------|-----|------|-----|------|-----|-----|----|------|-----|-----|-----|------------------------------------|----|-----|
| SSC4H-S25-L | 15.6 | 395 | .300 | 7.6 | .065 | 1.7 | .260 | 6.6 | 1/4 | M6 | 4.00 | 102 | 120 | 534 | GTH, GS4H, GS4EH, PTH, STH2, ST3EH | 50 | 500 |
|-------------|------|-----|------|-----|------|-----|------|-----|-----|----|------|-----|-----|-----|------------------------------------|----|-----|

### Weather Resistant Nylon 6.6

#### Standard Cross Section

|                     |      |     |      |     |      |     |      |     |     |    |      |     |    |     |  |      |       |
|---------------------|------|-----|------|-----|------|-----|------|-----|-----|----|------|-----|----|-----|--|------|-------|
| SSC2S-S6-M0         | 7.4  | 187 | .180 | 4.6 | .045 | 1.1 | .148 | 3.8 | #6  | M3 | 1.75 | 45  | 50 | 222 | GTS, GTSL, GS2B, GTH, GS4H, PTS, PTH, PPTS, STS2, STH2 | 1000 | 10000 |
| <b>SSC2S-S10-M0</b> | 7.4  | 187 | .180 | 4.6 | .045 | 1.1 | .200 | 5.1 | #10 | M5 | 1.75 | 45  | 50 | 222 |  | 1000 | 10000 |
| SSC4S-S10-M0        | 15.7 | 398 | .180 | 4.6 | .045 | 1.1 | .200 | 5.1 | #10 | M5 | 4.00 | 102 | 50 | 222 |  | 1000 | 5000  |

#### Light-Heavy Cross Section

|              |      |     |      |     |      |     |      |     |     |    |      |     |     |     |                                    |     |      |
|--------------|------|-----|------|-----|------|-----|------|-----|-----|----|------|-----|-----|-----|------------------------------------|-----|------|
| SSC4H-S25-D0 | 15.6 | 395 | .300 | 7.6 | .065 | 1.7 | .260 | 6.6 | 1/4 | M6 | 4.00 | 102 | 120 | 534 | GTH, GS4H, GS4EH, PTH, STH2, ST3EH | 500 | 2500 |
|--------------|------|-----|------|-----|------|-----|------|-----|-----|----|------|-----|-----|-----|------------------------------------|-----|------|

### Heat Stabilized Nylon 6.6

#### Standard Cross Section

|                      |     |     |      |     |      |     |      |     |     |    |      |    |    |     |  |      |       |
|----------------------|-----|-----|------|-----|------|-----|------|-----|-----|----|------|----|----|-----|--|------|-------|
| <b>SSC2S-S10-M30</b> | 7.4 | 187 | .180 | 4.6 | .045 | 1.2 | .200 | 5.1 | #10 | M5 | 1.75 | 45 | 50 | 222 | GTS, GTSL, GS2B, GTH, GS4H, PTS, PTH, PPTS, STS2, STH2 | 1000 | 10000 |
|----------------------|-----|-----|------|-----|------|-----|------|-----|-----|----|------|----|----|-----|--|------|-------|

#### Light-Heavy Cross Section

|               |      |     |      |     |      |     |      |     |     |    |      |     |     |     |                                    |     |      |
|---------------|------|-----|------|-----|------|-----|------|-----|-----|----|------|-----|-----|-----|------------------------------------|-----|------|
| SSC4H-S25-D30 | 15.6 | 395 | .300 | 7.6 | .065 | 1.7 | .260 | 6.6 | 1/4 | M6 | 4.00 | 102 | 120 | 534 | GTH, GS4H, GS4EH, PTH, STH2, ST3EH | 500 | 2500 |
|---------------|------|-----|------|-----|------|-----|------|-----|-----|----|------|-----|-----|-----|------------------------------------|-----|------|

## UL<sup>®</sup> CS<sup>®</sup> Sta-Strap<sup>®</sup> Marker Ties – Nylon and Weather Resistant Nylon 6.6

- Natural nylon material for indoor use
- Weather resistant material has greater resistance to damage caused by ultraviolet light – indoor or outdoor use
- Used to fasten and identify bundles at the same time
- Unique design allows tie to be used as a wrap-around or flag marker

- Can be marked with Panduit Marker Pens on page B1.51 or computer printable labels
- Custom imprinting with text, symbols, or trademarks available using Panduit Custom Hot Stamping Service, see page B1.91



SSM2S-C



SSM2S-D0

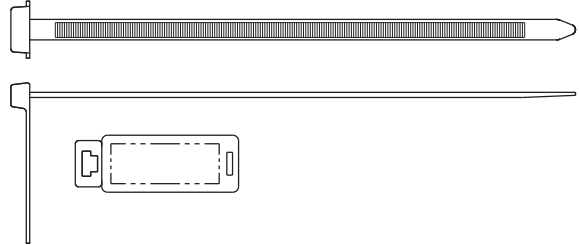

| Part Number | Marker Type | Length |    | Width |    | Thickness |    | Marker Write-On Area |    | Max. Bundle Dia. |    | Min. Loop Tensile Str. |   | Recommended Installation Tool | Std. Pkg. Qty. | Std. Ctn. Qty. |
|-------------|-------------|--------|----|-------|----|-----------|----|----------------------|----|------------------|----|------------------------|---|-------------------------------|----------------|----------------|
|             |             | In.    | mm | In.   | mm | In.       | mm | In.                  | mm | In.              | mm | Lbs.                   | N |                               |                |                |

### Nylon 6.6

#### Standard Cross Section

|                |           |      |     |      |     |      |     |           |             |      |     |    |     |  |     |      |
|----------------|-----------|------|-----|------|-----|------|-----|-----------|-------------|------|-----|----|-----|--|-----|------|
| <b>SSM2S-C</b> | Wrap/Flag | 6.7  | 170 | .180 | 4.6 | .045 | 1.1 | .44 x .96 | 11.2 x 24.4 | 1.75 | 45  | 50 | 222 | GTS, GTSL, GS2B, GTH, GS4H, PTS, PTH, PPTS, STS2, STH2 | 100 | 500  |
| <b>SSM4S-D</b> | Wrap/Flag | 14.9 | 378 | .180 | 4.6 | .045 | 1.1 | .44 x .96 | 11.2 x 24.4 | 4.00 | 102 | 50 | 222 |  | 500 | 5000 |

### Weather Resistant Nylon 6.6

#### Standard Cross Section

|                 |           |     |     |      |     |      |     |           |             |      |    |    |     |  |     |       |
|-----------------|-----------|-----|-----|------|-----|------|-----|-----------|-------------|------|----|----|-----|--|-----|-------|
| <b>SSM2S-D0</b> | Wrap/Flag | 6.7 | 170 | .180 | 4.6 | .045 | 1.1 | .44 x .96 | 11.2 x 24.4 | 1.75 | 45 | 50 | 222 | GTS, GTSL, GS2B, GTH, GS4H, PTS, PTH, PPTS, STS2, STH2 | 500 | 10000 |
|-----------------|-----------|-----|-----|------|-----|------|-----|-----------|-------------|------|----|----|-----|--|-----|-------|

A.  
System Overview

B1.  
Cable Ties

B2.  
Cable Accessories

B3.  
Stainless Steel Ties

C1.  
Wiring Duct

C2.  
Surface Raceway

C3.  
Abrasion Protection

C4.  
Cable Management

D1.  
Terminals

D2.  
Power Connectors

D3.  
Grounding Connectors

E1.  
Labeling Systems

E2.  
Labels

E3.  
Pre-Printed & Write-On Markers

E4.  
Permanent Identification

E5.  
Lockout/Tagout & Safety Solutions

F.  
Index

A.  
System  
Overview

## Sta-Strap® Cable Ties

B1.  
Cable Ties

### Material and Color Chart

| Material                    | Color   | Panduit Suffix |
|-----------------------------|---------|----------------|
| Nylon 6.6                   | Natural | ✓              |
| Weather Resistant Nylon 6.6 | Black   | 0              |
| Nylon 6.6                   | Red     | 2              |

| Material                  | Color | Panduit Suffix |
|---------------------------|-------|----------------|
| Nylon 6.6                 | Black | 20             |
| Heat Stabilized Nylon 6.6 | Black | 30             |

✓Denotes Panduit Natural Nylon 6.6 (no suffix).

C1.  
Wiring  
Duct

C2.  
Surface  
Raceway

C3.  
Abrasion  
Protection

### Part Number Availability List

|  | Standard Packaging |                   |                       | Bulk Packaging |                   |                       |
|--|--------------------|-------------------|-----------------------|----------------|-------------------|-----------------------|
|  | Part Number        | Natural Nylon 6.6 | Material/Color Suffix | Part Number    | Natural Nylon 6.6 | Material/Color Suffix |
| C4.<br>Cable<br>Management                         | SSC2S-S6-C         | ✓                 |                       | SSC2S-S6-M     | ✓                 | 0                     |
|  | SSC2S-S10-C        | ✓                 |                       | SSC2S-S10-M    | ✓                 | 0,30                  |
|  | SSC4S-S10-C        | ✓                 |                       | SSC4S-S10-M    | ✓                 | 0                     |
|  | SSC4H-S25-L        | ✓                 |                       | SSC4H-S25-D    | ✓                 | 0                     |
|  | SSM2S-C            | ✓                 |                       | SSM2S-D        | ✓                 | 0                     |
| D1.<br>Terminals                                   |                    |                   |                       | SSM4S-D        | ✓                 |                       |
|  | SST1M-C            | ✓                 | 0                     | SST1M-M        | ✓                 | 0,20,30               |
|  | SST1.5M-C          | ✓                 |                       | SST1.5M-M      | ✓                 | 0,20,30               |
|  | SST1.5I-C          | ✓                 |                       | SST1.5I-M      | ✓                 | 0                     |
|  | SST2I-C            | ✓                 |                       | SST2I-M        | ✓                 | 0                     |
| D2.<br>Power<br>Connectors                         | SST3I-C            | ✓                 | 0                     | SST3I-M        | ✓                 | 0                     |
|  | SST4I-C            | ✓                 |                       | SST4I-M        | ✓                 | 0                     |
|  |                    |                   |                       | SST1.5S-M      | ✓                 | 0                     |
|  | SST2S-C            | ✓                 | 0                     | SST2S-M        | ✓                 | 0,20,30               |
|  | SST3S-C            | ✓                 | 0                     | SST3S-M        | ✓                 | 0,20,30               |
| D3.<br>Grounding<br>Connectors                     | SST4S-C            | ✓                 | 0                     | SST4S-M        | ✓                 | 0,2,30                |
|  |                    |                   |                       | SST2H-D        | ✓                 | 0                     |
|  |                    |                   |                       | SST2HH-D       |                   | 30                    |
|  | SST4H-L            | ✓                 | 0                     | SST4H-D        | ✓                 | 0,30                  |
|  |                    |                   | 0                     | SST4HH-D       |                   | 30                    |
| E1.<br>Labeling<br>Systems                         | SST8H-L            | ✓                 | 0                     | SST8H-D        | ✓                 | 0,30                  |
|  |                    |                   |                       |                |                   |                       |
| E2.<br>Labels                                      |                    |                   |                       |                |                   |                       |
|  |                    |                   |                       |                |                   |                       |
| E3.<br>Pre-Printed<br>& Write-On<br>Markers        |                    |                   |                       |                |                   |                       |
| E4.<br>Permanent<br>Identification                 |                    |                   |                       |                |                   |                       |
| E5.<br>Lockout/<br>Tagout<br>& Safety<br>Solutions |                    |                   |                       |                |                   |                       |
| F.<br>Index  |                    |                   |                       |                |                   |                       |

## Selection Guide – Specialty Ties



|                                     | Material, Color (Suffix)                                 | Style/Function       | Part Number Prefix | Catalog Page |
|-------------------------------------|--|----------------------|--------------------|--------------|
| <b>Stud Mounted Cable Ties</b>      | Heat Stabilized Nylon 6.6, Black (30)                    | Locking Ties/Bundle  | PLST               | B1.74        |
|                                     |  | Releasable/Re-usable | PRST               | B1.74        |
|                                     | Heat Stabilized Weather Resistant Nylon 6.6, Black (300) | Locking/Bundle       | PLST               | B1.74        |
| <b>Ladder Style Stud Mount</b>      | Heat Stabilized Nylon 6.6, Black (30)                    | Releasable/Re-usable | PRST               | B1.75        |
| <b>Double Loop Ties – One-Piece</b> | Nylon 6.6, Natural (No Suffix)                           | Locking/Bundle       | PLB                | B1.76        |
|                                     | Weather Resistant Nylon 6.6, Black (0)                   |                      |                    |              |
|                                     | Heat Stabilized Nylon 6.6, Black (30)                    |                      |                    |              |
| <b>Double Loop Ties – Two-Piece</b> | Nylon 6.6, Natural (No Suffix)                           | Locking/Bundle       | SSB                | B1.77        |
|                                     | Weather Resistant Nylon 6.6, Black (0)                   |                      |                    |              |
|                                     | Heat Stabilized Nylon 6.6, Black (30)                    |                      |                    |              |
| <b>Triple Loop Ties</b>             | Weather Resistant Nylon 6.6, Black (0)                   | Locking/Bundle       | PL3B               | B1.78        |
| <b>Double Hose Clamp</b>            | Weather Resistant Nylon 6.6, Black (0)                   | Locking/Bundle       | DHC                | B1.78        |
| <b>Chassis/Panel Mount Ties</b>     | Heat Stabilized Weather Resistant Nylon 6.6, Black (300) | Locking/Bundle       | SSPM               | B1.79        |
| <b>Cable Marker Strap</b>           | Polyethylene (No Suffix)                                 | Releasable/Re-usable | CM4S               | B1.80        |

### Part Number System for Specialty Cable Ties

| PLST                                      | 4                                 | H   | S25                                  | — | TL   | 300            |
|---|-----------------------------------|---|--------------------------------------|---|--|----------------|
| Type                                      | Size                              | Cross Section                                 | Stud Size                            |   | Package Size   | Material/Color |
| CM4S = Cable Marker Strap                 | Approx. Maximum Bundle Dia. (In.) | S = Standard<br>H = Heavy<br>EH = Extra-Heavy | -S25 = M6<br>-SC = 5mm<br>-S14 = 5mm |   | L = 50<br>C = 100<br>TL = 250<br>D = 500<br>M = 1000 | See Page B1.81 |
| PLB = Locking Bow Tie                     |                                   |   |                                      |   |  |                |
| PL3B = Triple Loop Tie                    |                                   |   |                                      |   |  |                |
| DHC = Double Hose Clamp                   |                                   |   |                                      |   |  |                |
| PLST = Locking Stud Mounted Tie           |                                   |   |                                      |   |  |                |
| PRST = Releasable Stud Mount Ladder Style |                                   |   |                                      |   |  |                |
| SSB = Sta-Strap® Bow-Ty™ Tie              |                                   |   |                                      |   |  |                |
| SSPM = Sta-Strap® Panel Mount             |                                   |   |                                      |   |  |                |



Cable tie tools speed installation and reduce total installed cost. See pages B1.109 – B1.114.



Cable tie accessories are used to speed and simplify the mounting of wires, cables, and tubing. See pages B2.1 – B2.29.

A. System Overview



## Pan-Ty® Stud Mounted Cable Ties – Heat Stabilized and Heat Stabilized Weather Resistant Nylon 6.6

B1. Cable Ties

- Heat stabilized material for high temperature applications up to 239°F (115°C) – indoor use
- Heat stabilized weather resistant material has greater resistance to damage caused by ultraviolet light and for high temperature applications up to 212°F (100°C) – indoor or outdoor use
- Integral mount pushes onto a threaded stud and tie wraps around bundle

- Mid-mount style (PLST\_SC) centers the wire bundle over the stud
- Tie can be removed from the stud by turning counterclockwise
- Releasable style available (PRST)
- Curved tip is easy to pick up from flat surfaces and allows faster initial threading to speed installation

B2. Cable Accessories

B3. Stainless Steel Ties

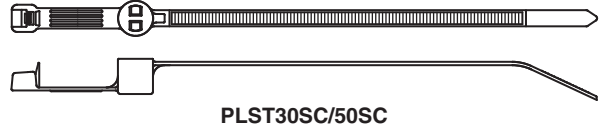

C1. Wiring Duct

C2. Surface Raceway

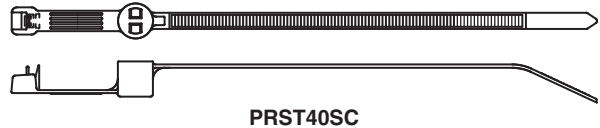

C3. Abrasion Protection

C4. Cable Management

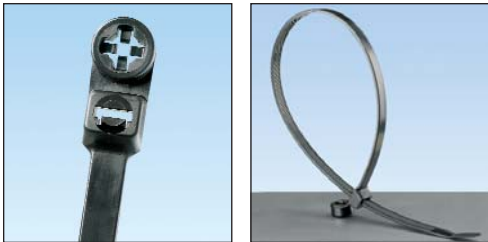

D1. Terminals

D2. Power Connectors

D3. Grounding Connectors

| Part Number | Length |    | Width |    | Thickness |    | Recommended Stud Size |    | Max. Bundle Dia. |    | Min. Loop Tensile Str. |   | Recommended Installation Tool | Std. Pkg. Qty. | Std. Ctn. Qty. |
|-------------|--------|----|-------|----|-----------|----|-----------------------|----|------------------|----|------------------------|---|-------------------------------|----------------|----------------|
|             | In.    | mm | In.   | mm | In.       | mm | In.                   | mm | In.              | mm | Lbs.                   | N |                               |                |                |

E1. Labeling Systems

### Heat Stabilized Nylon 6.6 Standard Cross Section

|                     |     |     |      |     |      |     |       |     |      |    |    |     |  |                   |      |
|---------------------|-----|-----|------|-----|------|-----|-------|-----|------|----|----|-----|--|-------------------|------|
| <b>PLST30SC-D30</b> | 5.7 | 146 | .190 | 4.8 | .050 | 1.3 | 10-24 | 5.0 | 1.18 | 30 | 50 | 222 | GTS, GTSL, GS2B, GTH, GS4H, PTS, PTH, PPTS, STS2, STH2 | 500               | 5000 |
| <b>PLST50SC-D30</b> | 8.1 | 207 | .190 | 4.8 | .050 | 1.3 | 10-24 | 5.0 | 1.97 | 50 | 50 | 222 |  | 500               | 5000 |
| <b>PRST40SC-D30</b> | 6.9 | 176 | .190 | 4.8 | .050 | 1.3 | 10-24 | 5.0 | 1.57 | 40 | 50 | 222 |  | Hand install only | 500  |

E2. Labels

E3. Pre-Printed & Write-On Markers

### Heat Stabilized Weather Resistant Nylon 6.6 Light-Heavy Cross Section

|                        |      |     |      |     |      |     |        |     |      |     |     |     |                                    |     |      |
|------------------------|------|-----|------|-----|------|-----|--------|-----|------|-----|-----|-----|------------------------------------|-----|------|
| <b>PLST4HS25-TL300</b> | 15.3 | 389 | .300 | 7.6 | .075 | 1.9 | 1/4-20 | 6.4 | 4.00 | 102 | 120 | 534 | GTH, GS4H, GS4EH, PTH, STH2, ST3EH | 250 | 2500 |
|------------------------|------|-----|------|-----|------|-----|--------|-----|------|-----|-----|-----|------------------------------------|-----|------|

E4. Permanent Identification

E5. Lockout/Tagout & Safety Solutions

F. Index

Note: UL Recognized and CSA Certified except PLST4H.



## c<sub>UL</sub>® c<sub>SP</sub>® Pan-Ty® Ladder Style Stud Mounted Cable Tie – Heat Stabilized Nylon 6.6

- For high temperature applications up to 239°F (115°C) – indoor use
- Integral mount pushes onto a threaded stud and tie wraps around bundle

- Tie can be removed from the stud by turning counterclockwise
- Adjustable, releasable, and re-usable
- Install by hand – no tools required

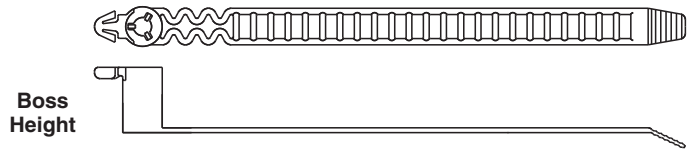
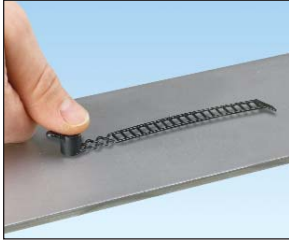

| Part Number                   | Length |     | Width |     | Thickness |     | Boss Height |    | Recommended Stud Size |     | Max. Bundle Dia. |    | Min. Loop Tensile Str. |     | Std. Pkg. Qty. | Std. Ctn. Qty. |
|-------------------------------|--------|-----|-------|-----|-----------|-----|-------------|----|-----------------------|-----|------------------|----|------------------------|-----|----------------|----------------|
|                               | In.    | mm  | In.   | mm  | In.       | mm  | In.         | mm | In.                   | mm  | In.              | mm | Lbs.                   | N   |                |                |
| <b>Standard Cross Section</b> |        |     |       |     |           |     |             |    |                       |     |                  |    |                        |     |                |                |
| PRST30S-S14-M30               | 5.2    | 132 | .380  | 9.7 | .050      | 1.3 | .59         | 15 | 10-24                 | 5.0 | 1.18             | 30 | 35                     | 156 | 1000           | 10000          |

A.  
System Overview

B1.  
Cable Ties

B2.  
Cable Accessories

B3.  
Stainless Steel Ties

C1.  
Wiring Duct

C2.  
Surface Raceway

C3.  
Abrasion Protection

C4.  
Cable Management

D1.  
Terminals

D2.  
Power Connectors

D3.  
Grounding Connectors

E1.  
Labeling Systems

E2.  
Labels

E3.  
Pre-Printed & Write-On Markers

E4.  
Permanent Identification

E5.  
Lockout/Tagout & Safety Solutions

F.  
Index

A. System Overview

## UL® US CS® Pan-Ty® Double Loop Cable Ties

B1. Cable Ties

- Natural nylon material for indoor use
- Weather resistant material has greater resistance to damage caused by ultraviolet light – indoor or outdoor use
- Heat stabilized material for high temperature applications up to 239°F (115°C) – indoor use

- A fast and economical method to secure and separate two bundles
- Reduces part number inventory – single part covers multiple bundle sizes
- Installs easily by hand – second loop can be installed with Panduit cable tie installation tools

B2. Cable Accessories

B3. Stainless Steel Ties



**PLB4H**  
Head Design



**PLB2S/3S/4S**  
Head Design

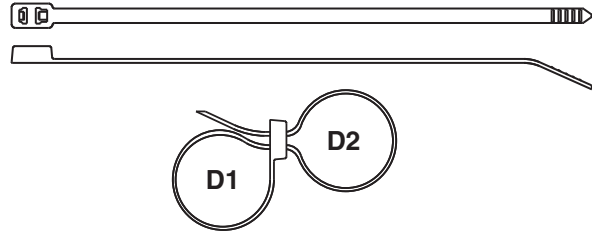

Assembled View

C1. Wiring Duct

C2. Surface Raceway

C3. Abrasion Protection

C4. Cable Management

D1. Terminals

D2. Power Connectors

D3. Grounding Connectors

E1. Labeling Systems

E2. Labels

E3. Pre-Printed & Write-On Markers

E4. Permanent Identification

E5. Lockout/Tagout & Safety Solutions

F. Index

| Part Number | Max. Combined Bundle Dia. D1 + D2 |    | Length |    | Width |    | Thickness |    | Min. Loop Tensile Str. |   | Recommended Installation Tool | Std. Pkg. Qty. | Std. Ctn. Qty. |
|-------------|-----------------------------------|----|--------|----|-------|----|-----------|----|------------------------|---|-------------------------------|----------------|----------------|
|             | In.                               | mm | In.    | mm | In.   | mm | In.       | mm | Lbs.                   | N |                               |                |                |

### Nylon 6.6

#### Standard Cross Section

|                |      |     |      |     |      |     |      |     |    |     |  |     |      |
|----------------|------|-----|------|-----|------|-----|------|-----|----|-----|--|-----|------|
| <b>PLB2S-C</b> | 1.80 | 46  | 7.6  | 193 | .190 | 4.8 | .052 | 1.3 | 50 | 222 | GTS, GTSL, GS2B, GTH, GS4H, PTS, PTH, PPTS, STS2, STH2 | 100 | 1000 |
| <b>PLB3S-C</b> | 3.00 | 76  | 11.8 | 300 | .190 | 4.8 | .052 | 1.3 | 50 | 222 |  | 100 | 1000 |
| <b>PLB4S-C</b> | 4.10 | 104 | 14.8 | 376 | .190 | 4.8 | .052 | 1.3 | 50 | 222 |  | 100 | 1000 |

#### Light-Heavy Cross Section

|                 |      |    |      |     |      |     |      |     |     |     |                                    |     |      |
|-----------------|------|----|------|-----|------|-----|------|-----|-----|-----|------------------------------------|-----|------|
| <b>PLB4H-TL</b> | 3.60 | 91 | 14.7 | 373 | .300 | 7.6 | .075 | 1.9 | 120 | 534 | GTH, GS4H, GS4EH, PTH, STH2, ST3EH | 250 | 2500 |
|-----------------|------|----|------|-----|------|-----|------|-----|-----|-----|------------------------------------|-----|------|

### Weather Resistant Nylon 6.6

#### Standard Cross Section

|                 |      |     |      |     |      |     |      |     |    |     |  |      |      |
|-----------------|------|-----|------|-----|------|-----|------|-----|----|-----|--|------|------|
| <b>PLB2S-C0</b> | 1.80 | 46  | 7.6  | 193 | .190 | 4.8 | .052 | 1.3 | 50 | 222 | GTS, GTSL, GS2B, GTH, GS4H, PTS, PTH, PPTS, STS2, STH2 | 100  | 1000 |
| <b>PLB3S-C0</b> | 3.00 | 76  | 11.8 | 300 | .190 | 4.8 | .052 | 1.3 | 50 | 222 |  | 100  | 1000 |
| <b>PLB4S-M0</b> | 4.10 | 104 | 14.8 | 376 | .190 | 4.8 | .052 | 1.3 | 50 | 222 |  | 1000 | 5000 |

#### Light-Heavy Cross Section

|                  |      |    |      |     |      |     |      |     |     |     |                                    |     |      |
|------------------|------|----|------|-----|------|-----|------|-----|-----|-----|------------------------------------|-----|------|
| <b>PLB4H-TL0</b> | 3.60 | 91 | 14.7 | 373 | .300 | 7.6 | .075 | 1.9 | 120 | 534 | GTH, GS4H, GS4EH, PTH, STH2, ST3EH | 250 | 2500 |
|------------------|------|----|------|-----|------|-----|------|-----|-----|-----|------------------------------------|-----|------|

### Heat Stabilized Nylon 6.6

#### Standard Cross Section

|                  |      |     |      |     |      |     |      |     |    |     |  |      |       |
|------------------|------|-----|------|-----|------|-----|------|-----|----|-----|--|------|-------|
| <b>PLB2S-M30</b> | 1.80 | 46  | 7.6  | 193 | .190 | 4.8 | .052 | 1.3 | 50 | 222 | GTS, GTSL, GS2B, GTH, GS4H, PTS, PTH, PPTS, STS2, STH2 | 1000 | 10000 |
| <b>PLB3S-M30</b> | 3.00 | 76  | 11.8 | 300 | .190 | 4.8 | .052 | 1.3 | 50 | 222 |  | 1000 | 10000 |
| <b>PLB4S-M30</b> | 4.10 | 104 | 14.8 | 376 | .190 | 4.8 | .052 | 1.3 | 50 | 222 |  | 1000 | 5000  |

#### Light-Heavy Cross Section

|                   |      |    |      |     |      |     |      |     |     |     |                                    |     |      |
|-------------------|------|----|------|-----|------|-----|------|-----|-----|-----|------------------------------------|-----|------|
| <b>PLB4H-TL30</b> | 3.60 | 91 | 14.7 | 373 | .300 | 7.6 | .075 | 1.9 | 120 | 534 | GTH, GS4H, GS4EH, PTH, STH2, ST3EH | 250 | 2500 |
|-------------------|------|----|------|-----|------|-----|------|-----|-----|-----|------------------------------------|-----|------|

Note: UL Recognized and CSA Certified except PLB4H-TL0.

## UL® cUL® Sta-Strap® Bow-Ty™ Cable Ties

- Natural nylon material for indoor use
- Weather resistant material has greater resistance to damage caused by ultraviolet light – indoor or outdoor use
- Heat stabilized material for high temperature applications up to 239°F (115°C) – indoor use

- A fast and economical method to secure and separate two bundles
- Exclusive two-piece design offers the lowest threading force in the industry
- First loop is releasable prior to final tensioning



SSB2S-C

SSB2S-M0 (30)

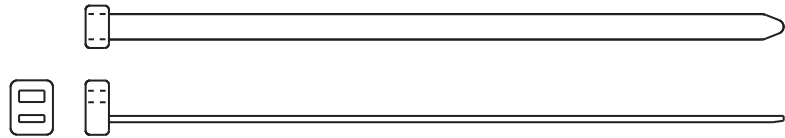

Top View



Assembled View

| Part Number | Max. Combined Bundle Dia. D1 + D2 |    | Length |    | Width |    | Thickness |    | Min. Loop Tensile Str. |   | Recommended Installation Tool | Std. Pkg. Qty. | Std. Ctn. Qty. |
|-------------|-----------------------------------|----|--------|----|-------|----|-----------|----|------------------------|---|-------------------------------|----------------|----------------|
|             | In.                               | mm | In.    | mm | In.   | mm | In.       | mm | Lbs.                   | N |                               |                |                |

### Nylon 6.6

#### Standard Cross Section

|         |      |    |     |     |     |     |      |     |    |     |                   |     |      |
|---------|------|----|-----|-----|-----|-----|------|-----|----|-----|-------------------|-----|------|
| SSB2S-C | 1.25 | 32 | 6.8 | 172 | .18 | 4.6 | .045 | 1.1 | 30 | 133 | Hand install only | 100 | 1000 |
|---------|------|----|-----|-----|-----|-----|------|-----|----|-----|-------------------|-----|------|

### Weather Resistant Nylon 6.6

#### Standard Cross Section

|          |      |    |     |     |     |     |      |     |    |     |                   |      |       |
|----------|------|----|-----|-----|-----|-----|------|-----|----|-----|-------------------|------|-------|
| SSB2S-M0 | 1.25 | 32 | 6.8 | 172 | .18 | 4.6 | .045 | 1.1 | 30 | 133 | Hand install only | 1000 | 10000 |
|----------|------|----|-----|-----|-----|-----|------|-----|----|-----|-------------------|------|-------|

### Heat Stabilized Nylon 6.6

#### Standard Cross Section

|           |      |    |     |     |     |     |      |     |    |     |                   |      |       |
|-----------|------|----|-----|-----|-----|-----|------|-----|----|-----|-------------------|------|-------|
| SSB2S-M30 | 1.25 | 32 | 6.8 | 172 | .18 | 4.6 | .045 | 1.1 | 30 | 133 | Hand install only | 1000 | 10000 |
|-----------|------|----|-----|-----|-----|-----|------|-----|----|-----|-------------------|------|-------|

A.  
System  
Overview

B1.  
Cable  
Ties

B2.  
Cable  
Accessories

B3.  
Stainless  
Steel Ties

C1.  
Wiring  
Duct

C2.  
Surface  
Raceway

C3.  
Abrasion  
Protection

C4.  
Cable  
Management

D1.  
Terminals

D2.  
Power  
Connectors

D3.  
Grounding  
Connectors

E1.  
Labeling  
Systems

E2.  
Labels

E3.  
Pre-Printed  
& Write-On  
Markers

E4.  
Permanent  
Identification

E5.  
Lockout/  
Tagout  
& Safety  
Solutions

F.  
Index

A. System Overview

## Pan-Ty® Triple Loop Cable Tie – Weather Resistant Nylon 6.6

B1. Cable Ties

- Greater resistance to damage caused by ultraviolet light – indoor or outdoor use
- A fast and economical method to secure and separate three bundles

- Third loop can be installed with Panduit cable tie installation tools

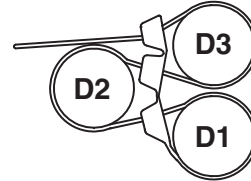
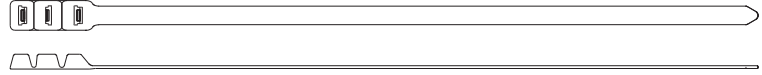

Assembled View

C1. Wiring Duct

C2. Surface Raceway

| Part Number                      | Max. Combined Bundle Dia. D1 + D2 + D3 |     | Length |     | Width |      | Thickness |     | Min. Loop Tensile Str. |     | Recommended Installation Tool | Std. Pkg. Qty. | Std. Ctn. Qty. |
|----------------------------------|--|-----|--------|-----|-------|------|-----------|-----|------------------------|-----|-------------------------------|----------------|----------------|
|                                  | In.                                    | mm  | In.    | mm  | In.   | mm   | In.       | mm  | Lbs.                   | N   |                               |                |                |
| <b>Extra-Heavy Cross Section</b> |  |     |        |     |       |      |           |     |                        |     |                               |                |                |
| <b>PL3B5EH-C0</b>                | 5.00                                   | 127 | 20.0   | 508 | .500  | 12.7 | .075      | 1.9 | 125                    | 556 | GS4EH, ST3EH                  | 100            | 1000           |

C3. Abrasion Protection

C4. Cable Management

## Double Hose Clamp – Weather Resistant Nylon 6.6

- Greater resistance to damage caused by ultraviolet light – indoor or outdoor use

- Holds and separates two gasoline, hydraulic, or pneumatic hoses
- Holds each hose individually to prevent abrasion and twisting

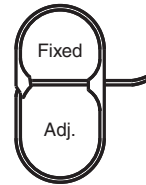
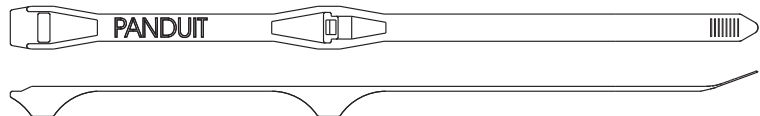

Assembled View

D1. Terminals

D2. Power Connectors

D3. Grounding Connectors

E1. Labeling Systems

E2. Labels

| Part Number            | Length |     | Width |     | Thickness |     | Fixed Loop Dia. |    | Adjustable Loop Dia. |         | Min. Loop Tensile Str. |     | Recommended Installation Tool | Std. Pkg. Qty. | Std. Ctn. Qty. |
|------------------------|--------|-----|-------|-----|-----------|-----|-----------------|----|----------------------|---------|------------------------|-----|-------------------------------|----------------|----------------|
|                        | In.    | mm  | In.   | mm  | In.       | mm  | In.             | mm | In.                  | mm      | Lbs.                   | N   |                               |                |                |
| <b>DHC1.12X1.75-D0</b> | 11.0   | 279 | 0.28  | 7.1 | 0.05      | 1.3 | 1.12            | 28 | 1.00 – 1.75          | 25 – 44 | 100                    | 445 | GTH, GS4H, PTH, STH2, ST3EH   | 500            | 2500           |

E3. Pre-Printed & Write-On Markers

E4. Permanent Identification

E5. Lockout/Tagout & Safety Solutions

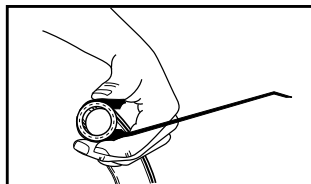

1) Wrap clamp around hose

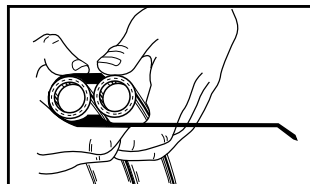

2) Position second hose in clamp

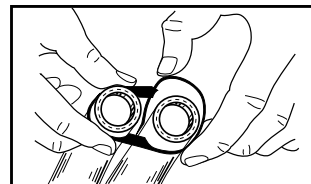

3) Loop tail around second hose and thread tail through both spacer heads

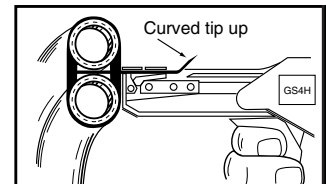

4) Tension and cut off with recommended tool

F. Index



## Sta-Strap® Chassis/Panel Mount Ties – Heat Stabilized Weather Resistant Nylon 6.6

- Greater resistance to damage caused by ultraviolet light and for high temperature applications up to 212°F (100°C) – indoor or outdoor use
- Unique design allows tie to secure a bundle directly to a chassis or panel without the need for separate fasteners or mounting devices

- Releasable prior to final tensioning for bundle modifications
- Engages clearance hole with optional centering pilot to prevent tie from shifting or abrading in high vibration environments

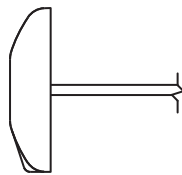

Without Centering Pilot

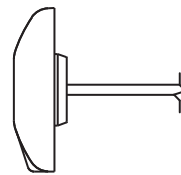

With Centering Pilot

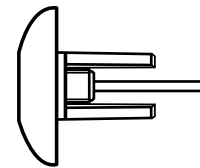

With Long Centering Pilot

| Part Number                      | Length |     | Width |     | Thickness |     | Hole Diameter Range |             | Max. Bundle Dia. |     | Min. Loop Tensile Str. |     | Recommended Installation Tool      | Std. Pkg. Qty. | Std. Ctn. Qty. |
|----------------------------------|--------|-----|-------|-----|-----------|-----|---------------------|-------------|------------------|-----|------------------------|-----|------------------------------------|----------------|----------------|
|                                  | In.    | mm  | In.   | mm  | In.       | mm  | In.                 | mm          | In.              | mm  | Lbs.                   | N   |                                    |                |                |
| <b>Without Centering Pilot</b>   |        |     |       |     |           |     |                     |             |                  |     |                        |     |                                    |                |                |
| SSPM2.5H-L300                    | 10.1   | 257 | .300  | 7.6 | .062      | 1.6 | .316 – .820         | 8.0 – 21.0  | 2.76             | 70  | 120                    | 534 | GTH, GS4H, GS4EH, PTH, STH2, ST3EH | 50             | 2500           |
| SSPM4H-L300                      | 14.8   | 376 | .300  | 7.6 | .062      | 1.6 | .316 – .820         | 8.0 – 21.0  | 4.00             | 102 | 120                    | 534 | GTH, GS4H, GS4EH, PTH, STH2, ST3EH | 50             | 2500           |
| <b>With Centering Pilot</b>      |        |     |       |     |           |     |                     |             |                  |     |                        |     |                                    |                |                |
| SSPM2.5HP-L300                   | 10.1   | 257 | .300  | 7.6 | .062      | 1.6 | .440 – .820         | 11.2 – 21.0 | 2.76             | 70  | 120                    | 534 | GTH, GS4H, GS4EH, PTH, STH2, ST3EH | 50             | 2500           |
| SSPM4HP-L300                     | 14.8   | 376 | .300  | 7.6 | .062      | 1.6 | .440 – .820         | 11.2 – 21.0 | 4.00             | 102 | 120                    | 534 | GTH, GS4H, GS4EH, PTH, STH2, ST3EH | 50             | 2500           |
| <b>With Long Centering Pilot</b> |        |     |       |     |           |     |                     |             |                  |     |                        |     |                                    |                |                |
| SSPM4HLP-TL300                   | 14.8   | 376 | .300  | 7.6 | .062      | 1.6 | .440 – .820         | 11.2 – 21.0 | 4.00             | 102 | 120                    | 534 | GTH, GS4H, GS4EH, PTH, STH2, ST3EH | 250            | 2500           |

### Through-Panel Mount Installation in Three Easy Steps:

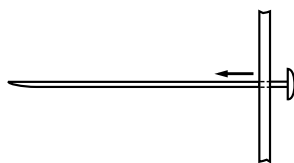

1) Insert tip of cable tie through the pre-drilled hole in the panel.

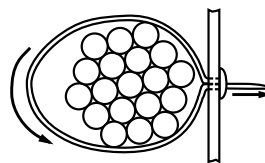

2) Wrap cable tie around the bundle and insert tip back through the hole and head of the cable tie.

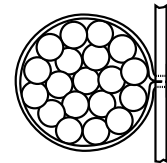

3) Pull tip until cable tie is snug on bundle. Tension and cut off excess portion with installation tool.



A. System Overview

## Cable Marker Straps – Polyethylene

B1. Cable Ties

- Identify and code telephone and fiber optic cable
- Eliminate the need for costly and cumbersome lead marking tags
- Lightweight and easy to install
- Use as wrap-around or flag marker

- For underground identification applications
- Can be marked with Panduit marker pens, see page B1.51
- Custom imprinting with text, symbols, or trademarks available using Panduit Custom Hot Stamping Service, see page B1.93

B2. Cable Accessories

B3. Stainless Steel Ties

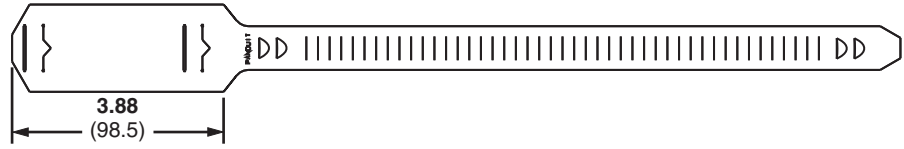

C1. Wiring Duct

C2. Surface Raceway

C3. Abrasion Protection

C4. Cable Management

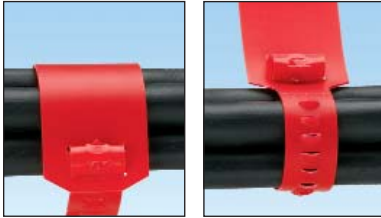

**Wrap-Around Marker**  
(Min. Dia.: 1.27")

**Flag Marker**  
(Min. Dia.: .25")

D1. Terminals

D2. Power Connectors

D3. Grounding Connectors

| Part Number                   | Length |     | Width |      | Thickness |     | Color | Marker Write-On Area |             | Max. Bundle Dia. |     | Recommended Installation Tool | Std. Pkg. Qty. | Std. Ctn. Qty. |
|-------------------------------|--------|-----|-------|------|-----------|-----|-------|----------------------|-------------|------------------|-----|-------------------------------|----------------|----------------|
|                               | In.    | mm  | In.   | mm   | In.       | mm  |       | In.                  | mm          | In.              | mm  |                               |                |                |
| <b>Standard Cross Section</b> |        |     |       |      |           |     |       |                      |             |                  |     |                               |                |                |
| <b>CM4S-L2</b>                | 15.3   | 387 | .750  | 19.1 | .033      | .84 | Red   | 1.50 x 2.62          | 38.1 x 66.5 | 4.38             | 111 | Hand install only             | 50             | 500            |
| <b>CM4S-L8</b>                | 15.3   | 387 | .750  | 19.1 | .033      | .84 | Gray  | 1.50 x 2.62          | 38.1 x 66.5 | 4.38             | 111 |                               | 50             | 500            |

E1. Labeling Systems

E2. Labels

E3. Pre-Printed & Write-On Markers

E4. Permanent Identification

E5. Lockout/Tagout & Safety Solutions

F. Index

## Specialty Cable Ties

### Material and Color Chart

| Material                    | Color   | Panduit Suffix |
|-----------------------------|---------|----------------|
| Nylon 6.6                   | Natural | ✓              |
| Weather Resistant Nylon 6.6 | Black   | 0              |
| Nylon 6.6                   | Red     | 2              |
| Nylon 6.6                   | Gray    | 8              |

| Material                                    | Color | Panduit Suffix |
|---|-------|----------------|
| Heat Stabilized Nylon 6.6                   | Black | 30             |
| Heat Stabilized Weather Resistant Nylon 6.6 | Black | 300            |

✓Denotes Panduit Natural Nylon 6.6 (no suffix).

### Part Number Availability List

| Standard Packaging |                   |                       | Bulk Packaging |                   |                       |
|--------------------|-------------------|-----------------------|----------------|-------------------|-----------------------|
| Part Number        | Natural Nylon 6.6 | Material/Color Suffix | Part Number    | Natural Nylon 6.6 | Material/Color Suffix |
| CM4S-L             |                   | 2,8                   |                |                   |                       |
|                    |                   |                       | DHC1.12X1.75-D |                   | 0                     |
| PLB2S-C            | ✓                 | 0                     | PLB2S-M        | ✓                 | 0,30                  |
| PLB3S-C            | ✓                 | 0                     | PLB3S-M        | ✓                 | 0,30                  |
| PLB4S-C            | ✓                 |                       | PLB4S-M        | ✓                 | 0,30                  |
|                    |                   |                       | PLB4H-TL       | ✓                 | 0,30                  |
|                    |                   |                       | PL3B5EH-C      |                   | 0                     |
|                    |                   |                       | PLST4HS25-TL   |                   | 300                   |
|                    |                   |                       | PLST30SC-D     |                   | 30                    |
|                    |                   |                       | PLST50SC-D     |                   | 30                    |
|                    |                   |                       | PRST30S-S14-M  |                   | 30                    |
|                    |                   |                       | PRST40SC-SD    |                   | 30                    |
| SSB2S-C            | ✓                 |                       | SSB2S-M        | ✓                 | 0,30                  |
| SSPM2.5H-L         |                   | 300                   | SSPM2.5H-TL    |                   | 300                   |
| SSPM2.5HP-L        |                   | 300                   | SSPM2.5HP-TL   |                   | 300                   |
| SSPM4H-L           |                   | 300                   | SSPM4H-TL      |                   | 300                   |
| SSPM4HP-L          |                   | 300                   | SSPM4HP-TL     |                   | 300                   |
|                    |                   |                       | SSPM4HLP-TL    |                   | 300                   |

A.  
System  
Overview

B1.  
Cable Ties

B2.  
Cable  
Accessories

B3.  
Stainless  
Steel Ties

C1.  
Wiring  
Duct

C2.  
Surface  
Raceway

C3.  
Abrasion  
Protection

C4.  
Cable  
Management

D1.  
Terminals

D2.  
Power  
Connectors

D3.  
Grounding  
Connectors

E1.  
Labeling  
Systems

E2.  
Labels

E3.  
Pre-Printed  
& Write-On  
Markers

E4.  
Permanent  
Identification

E5.  
Lockout/  
Tagout  
& Safety  
Solutions

F.  
Index

# PANDUIT® ELECTRICAL SOLUTIONS

A. System Overview

## UL US CS Pan-Ty® Striped Cable Ties – Nylon 6.6

B1. Cable Ties

- Nylon material for indoor use
- Striped Pan-Ty® Cable Ties in 25 color combinations match the universally accepted Even-Count Color Code

- Solid color ties are available for identification of “super groups” in cable containing more than 600 pairs
- Each 50-piece package fits in the Pan-Pouch™ Kit or pocket pouch shown on the next page

B2. Cable Accessories

B3. Stainless Steel Ties

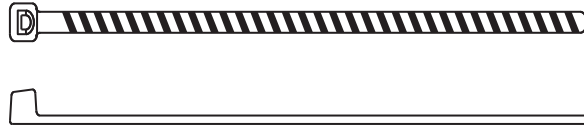
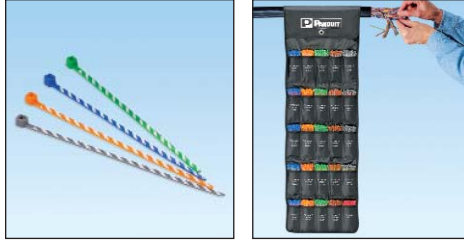

C1. Wiring Duct

C2. Surface Raceway

C3. Abrasion Protection

C4. Cable Management

D1. Terminals

D2. Power Connectors

D3. Grounding Connectors

E1. Labeling Systems

E2. Labels

E3. Pre-Printed & Write-On Markers

E4. Permanent Identification

E5. Lockout/Tagout & Safety Solutions

F. Index

| Part Number                                   | Color                | Length |     | Width |     | Thickness |    | Max. Bundle Dia. |    | Min. Loop Tensile Str. |    | Std. Pkg. Qty. | Std. Ctn. Qty. |
|---|----------------------|--------|-----|-------|-----|-----------|----|------------------|----|------------------------|----|----------------|----------------|
|   |                      | In.    | mm  | In.   | mm  | In.       | mm | In.              | mm | Lbs.                   | N  |                |                |
| <b>Miniature Cross Section (Straight Tip)</b> |                      |        |     |       |     |           |    |                  |    |                        |    |                |                |
| <b>PLT1M-L6-10</b>                            | Blue/White Stripe    | 4.0    | 102 | .100  | 2.5 | .036      | .9 | .82              | 21 | 18                     | 80 | 50             | 1000           |
| <b>PLT1M-L3-10</b>                            | Orange/White Stripe  | 4.0    | 102 | .100  | 2.5 | .036      | .9 | .82              | 21 | 18                     | 80 | 50             | 1000           |
| <b>PLT1M-L5-10</b>                            | Green/White Stripe   | 4.0    | 102 | .100  | 2.5 | .036      | .9 | .82              | 21 | 18                     | 80 | 50             | 1000           |
| <b>PLT1M-L1-10</b>                            | Brown/White Stripe   | 4.0    | 102 | .100  | 2.5 | .036      | .9 | .82              | 21 | 18                     | 80 | 50             | 1000           |
| <b>PLT1M-L8-10</b>                            | Slate/White Stripe   | 4.0    | 102 | .100  | 2.5 | .036      | .9 | .82              | 21 | 18                     | 80 | 50             | 1000           |
| <b>PLT1M-L6-2</b>                             | Blue/Red Stripe      | 4.0    | 102 | .100  | 2.5 | .036      | .9 | .82              | 21 | 18                     | 80 | 50             | 1000           |
| <b>PLT1M-L3-2</b>                             | Orange/Red Stripe    | 4.0    | 102 | .100  | 2.5 | .036      | .9 | .82              | 21 | 18                     | 80 | 50             | 1000           |
| <b>PLT1M-L5-2</b>                             | Green/Red Stripe     | 4.0    | 102 | .100  | 2.5 | .036      | .9 | .82              | 21 | 18                     | 80 | 50             | 1000           |
| <b>PLT1M-L1-2</b>                             | Brown/Red Stripe     | 4.0    | 102 | .100  | 2.5 | .036      | .9 | .82              | 21 | 18                     | 80 | 50             | 1000           |
| <b>PLT1M-L8-2</b>                             | Slate/Red Stripe     | 4.0    | 102 | .100  | 2.5 | .036      | .9 | .82              | 21 | 18                     | 80 | 50             | 1000           |
| <b>PLT1M-L6-0</b>                             | Blue/Black Stripe    | 4.0    | 102 | .100  | 2.5 | .036      | .9 | .82              | 21 | 18                     | 80 | 50             | 1000           |
| <b>PLT1M-L3-0</b>                             | Orange/Black Stripe  | 4.0    | 102 | .100  | 2.5 | .036      | .9 | .82              | 21 | 18                     | 80 | 50             | 1000           |
| <b>PLT1M-L5-0</b>                             | Green/Black Stripe   | 4.0    | 102 | .100  | 2.5 | .036      | .9 | .82              | 21 | 18                     | 80 | 50             | 1000           |
| <b>PLT1M-L1-0</b>                             | Brown/Black Stripe   | 4.0    | 102 | .100  | 2.5 | .036      | .9 | .82              | 21 | 18                     | 80 | 50             | 1000           |
| <b>PLT1M-L8-0</b>                             | Slate/Black Stripe   | 4.0    | 102 | .100  | 2.5 | .036      | .9 | .82              | 21 | 18                     | 80 | 50             | 1000           |
| <b>PLT1M-L6-4</b>                             | Blue/Yellow Stripe   | 4.0    | 102 | .100  | 2.5 | .036      | .9 | .82              | 21 | 18                     | 80 | 50             | 1000           |
| <b>PLT1M-L3-4</b>                             | Orange/Yellow Stripe | 4.0    | 102 | .100  | 2.5 | .036      | .9 | .82              | 21 | 18                     | 80 | 50             | 1000           |
| <b>PLT1M-L5-4</b>                             | Green/Yellow Stripe  | 4.0    | 102 | .100  | 2.5 | .036      | .9 | .82              | 21 | 18                     | 80 | 50             | 1000           |
| <b>PLT1M-L1-4</b>                             | Brown/Yellow Stripe  | 4.0    | 102 | .100  | 2.5 | .036      | .9 | .82              | 21 | 18                     | 80 | 50             | 1000           |
| <b>PLT1M-L8-4</b>                             | Slate/Yellow Stripe  | 4.0    | 102 | .100  | 2.5 | .036      | .9 | .82              | 21 | 18                     | 80 | 50             | 1000           |
| <b>PLT1M-L6-7</b>                             | Blue/Violet Stripe   | 4.0    | 102 | .100  | 2.5 | .036      | .9 | .82              | 21 | 18                     | 80 | 50             | 1000           |
| <b>PLT1M-L3-7</b>                             | Orange/Violet Stripe | 4.0    | 102 | .100  | 2.5 | .036      | .9 | .82              | 21 | 18                     | 80 | 50             | 1000           |
| <b>PLT1M-L5-7</b>                             | Green/Violet Stripe  | 4.0    | 102 | .100  | 2.5 | .036      | .9 | .82              | 21 | 18                     | 80 | 50             | 1000           |
| <b>PLT1M-L1-7</b>                             | Brown/Violet Stripe  | 4.0    | 102 | .100  | 2.5 | .036      | .9 | .82              | 21 | 18                     | 80 | 50             | 1000           |
| <b>PLT1M-L8-7</b>                             | Slate/Violet Stripe  | 4.0    | 102 | .100  | 2.5 | .036      | .9 | .82              | 21 | 18                     | 80 | 50             | 1000           |
| <b>PLT1M-L0</b>                               | Black                | 4.0    | 102 | .100  | 2.5 | .036      | .9 | .82              | 21 | 18                     | 80 | 50             | 1000           |
| <b>PLT1M-L1</b>                               | Brown                | 4.0    | 102 | .100  | 2.5 | .036      | .9 | .82              | 21 | 18                     | 80 | 50             | 1000           |
| <b>PLT1M-L2</b>                               | Red                  | 4.0    | 102 | .100  | 2.5 | .036      | .9 | .82              | 21 | 18                     | 80 | 50             | 1000           |
| <b>PLT1M-L3</b>                               | Orange               | 4.0    | 102 | .100  | 2.5 | .036      | .9 | .82              | 21 | 18                     | 80 | 50             | 1000           |
| <b>PLT1M-L4Y</b>                              | Yellow               | 4.0    | 102 | .100  | 2.5 | .036      | .9 | .82              | 21 | 18                     | 80 | 50             | 1000           |
| <b>PLT1M-L5</b>                               | Green                | 4.0    | 102 | .100  | 2.5 | .036      | .9 | .82              | 21 | 18                     | 80 | 50             | 1000           |
| <b>PLT1M-L6</b>                               | Blue                 | 4.0    | 102 | .100  | 2.5 | .036      | .9 | .82              | 21 | 18                     | 80 | 50             | 1000           |
| <b>PLT1M-L8</b>                               | Slate                | 4.0    | 102 | .100  | 2.5 | .036      | .9 | .82              | 21 | 18                     | 80 | 50             | 1000           |

Note: CSA Certified on solid colors only.

## Telephone Cable Identification Kits

- Pan-Pouch™ Kit is made of two-ply laminated black nylon/vinyl and folds for easy storage
- Easily hang pouch from cable by using hook and loop fasteners
- Pocket pouch holds five (50-piece) packages and is made of a white vinyl



PPC25X50F



PP5X50F

| Part Number | Description  | Dimensions                     |                                | Std. Pkg. Qty. |
|-------------|--|--------------------------------|--------------------------------|----------------|
|             |  | Open                           | Closed                         |                |
| PPC25X50F   | Pouch filled with 1,250 cable ties (50 each of all 24 striped ties and 50 solid red ties)                                | 10.5" x 38"<br>(267mm x 965mm) | 10.5" x 6"<br>(267mm x 152mm)  | 1              |
| PPC25X50    | Empty pouch  | 10.5" x 38"<br>(267mm x 965mm) | 10.5" x 6"<br>(267mm x 152mm)  | 1              |
| PP5X50F     | Pocket pouch filled with 250 cable ties (50 of each color: blue, orange, green, brown and slate – all with white stripe) | —                              | 3.5" x 5.25"<br>(89mm x 133mm) | 1              |

## Cable Tie Kits in Steel Boxes



K-205



K-504/SR2

| Part Number | Part Description  | Std. Pkg. Qty. |
|-------------|---|----------------|
| K-205       | <b>Kit for Indoor Use</b><br>Pan-Ty® Cable Ties, cable tie installation tool, terminals, splices and crimp tool:<br>(1) GTS tool<br>(1) CT-100 crimp tool<br><u>Natural Nylon 6.6 Cable Ties</u><br>(100) PLT1M<br>(100) PLT1.5I<br>(100) PLT2S<br><u>Terminals</u><br>(100) PV18-6LF<br>(100) PV14-8LF<br>(100) PV14-10LF<br>(50) PV10-10LF<br><u>Splices</u><br>(50) BSV10X<br>(100) BSV14X<br>(100) BSV18X | 1              |
| K-504       | <b>Kit for Indoor Use</b><br>Pan-Ty® Cable Ties, cable tie installation tool, and mounts:<br>(1) STS2 tool<br><u>Natural Nylon 6.6 Cable Ties</u><br>(100) PLT1M<br>(100) PLT1.5I<br>(100) PLT2S<br>(100) PLC2S-S10<br><u>Mounts</u><br>(100) TM2S8<br>(100) ABM2S-A  | 1              |
| SR2         | Two-drawer slide rack to hold K-504 cable tie kit or K-1000 series terminal kit. Dimensions: 6.25"H x 15.25"W x 11.75"D (158.7mm x 387.4mm x 298.5mm)   | 1              |

A.  
System  
Overview

## Cable Tie Kits in Plastic Boxes and Bags

B1.  
Cable Ties

B2.  
Cable  
Accessories

B3.  
Stainless  
Steel Ties



**KP-506A**

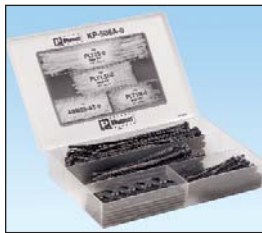

**KP-506A-0**



**KP-509**



**KB-550**



**KB-551**

C1.  
Wiring  
Duct

C2.  
Surface  
Raceway

C3.  
Abrasion  
Protection

C4.  
Cable  
Management

D1.  
Terminals

D2.  
Power  
Connectors

D3.  
Grounding  
Connectors

E1.  
Labeling  
Systems

E2.  
Labels

E3.  
Pre-Printed  
& Write-On  
Markers

E4.  
Permanent  
Identification

E5.  
Lockout/  
Tagout  
& Safety  
Solutions

F.  
Index

| Part Number      | Part Description   | Std. Pkg. Qty. |
|------------------|--|----------------|
| <b>KP-506A</b>   | <b>Kit for Indoor Use</b><br>Pan-Ty® Cable Ties and Mounts:<br><u>Natural Nylon 6.6</u><br>(100) PLT1M<br>(100) PLT1.5I<br>(100) PLT2S<br>(50) ABM2S-A mounts  | 1              |
| <b>KP-506A-0</b> | <b>Kit for Outdoor Use</b><br>Pan-Ty® Cable Ties and Mounts:<br><u>Black Weather Resistant Nylon 6.6</u><br>(100) PLT1M-0<br>(100) PLT1.5I-0<br>(100) PLT2S-0<br>(50) ABM2S-AT-0 mounts  | 1              |
| <b>KP-509</b>    | <b>Kit for Indoor Use</b><br>For prototyping and new product development – contains over 600 pieces.<br>Pan-Ty® Cable Ties in different styles, sizes, and colors.<br>Huge assortment of cable tie mounts and wiring accessories.  | 1              |
| <b>KB-550</b>    | <b>Assortment Pack for Indoor and Outdoor Use</b><br>Pan-Ty® Cable Ties:<br><u>Natural Nylon 6.6</u><br>(15) PLT1M<br>(15) PLT1.5I<br>(15) PLT2S<br>(15) PLT3S<br><u>Black Weather Resistant Nylon 6.6</u><br>(10) PLT1M-0<br>(10) PLT1.5I-0<br>(10) PLT2S-0<br>(10) PLT3S-0   | 1              |
| <b>KB-551</b>    | <b>Assortment Pack for Indoor and Outdoor Use</b><br>Dome-Top® Barb Ty Cable Ties:<br><u>Natural Nylon 6.6</u><br>(15) BT1M<br>(15) BT1.5I<br>(15) BT2S<br>(15) BT3S<br><u>Black Weather Resistant Nylon 6.6</u><br>(10) BT1M-0<br>(10) BT1.5I-0<br>(10) BT2S-0<br>(10) BT3S-0 | 1              |



## Features and Benefits – Hook and Loop Cable Ties

The comprehensive family of hook and loop cable ties delivers reliability by protecting against over-tensioning of high performance fiber and copper cables. These ties are adjustable, releasable, and re-usable to effectively support frequent moves, adds, and changes (MACs). A wide range of colors provides flexibility and an aesthetically pleasing appearance. The complete line of Panduit Hook and Loop Cable Ties help maintain the reliable, scalable, and aesthetic requirements of data centers.

### Tak-Ty® Hook & Loop Cable Ties – Premium, durable designs and sizes

#### Loop Style



Allows for pre-wrapping of bundles

#### Roll/Strip/Brick Style



Available in continuous or perforated rolls and stacked strips

#### Plenum-Rated



Distinctive maroon color (also available in black)

### Tak-Tape™ Hook & Loop Rolls



Strong, low profile hook and loop material

Convenient packaging



### Ultra-Cinch™ Hook & Loop Cable Ties



Unique same-sided material secures a greater range of bundle diameters

Available in three styles and eight colors; grommet styles used for bundle mounting applications

Low profile contoured cinch ring reduces overall bundle size



Wire management accessories speed and simplify the mounting of high performance cabling.

See pages B2.4, B2.5, B2.12, B2.21, B2.24, C4.4 – C4.6, C4.10, C4.11, C4.13, and C4.14.

A. System Overview

B1. Cable Ties

B2. Cable Accessories

B3. Stainless Steel Ties

C1. Wiring Duct

C2. Surface Raceway

C3. Abrasion Protection

C4. Cable Management

D1. Terminals

D2. Power Connectors

D3. Grounding Connectors

E1. Labeling Systems

E2. Labels

E3. Pre-Printed & Write-On Markers

E4. Permanent Identification

E5. Lockout/Tagout & Safety Solutions

F. Index

A. System Overview

## Selection Guide – Hook and Loop Cable Ties

B1. Cable Ties



B2. Cable Accessories

B3. Stainless Steel Ties

C1. Wiring Duct

| Product, Color (Suffix) | Style/Function | Part Number Prefix | Catalog Page |
|-------------------------|----------------|--------------------|--------------|
|-------------------------|----------------|--------------------|--------------|

C2. Surface Raceway

|                         |                             |          |       |
|-------------------------|-----------------------------|----------|-------|
| Tak-Ty® Ties, Black (0) | Loop Ties/Re-usable         | HLT      | B1.87 |
|                         | Strip Ties/Re-usable        | HLS      | B1.87 |
|                         | 15' and 75' Rolls/Re-usable | HLM, HLS | B1.87 |
|                         | Strip Ties/Re-usable/Brick  | HLB      | B1.87 |

C3. Abrasion Protection

|  |                      |      |       |
|--|----------------------|------|-------|
| Tak-Ty® Plenum-Rated Ties, UL Listed Black, Maroon (0, 12) | Loop Ties/Re-usable  | HLTP | B1.88 |
|  | Strip Ties/Re-usable | HLSP | B1.88 |

C4. Cable Management

|                            |                             |     |       |
|----------------------------|-----------------------------|-----|-------|
| Tak-Tape™ Rolls, Black (0) | 20' and 35' Rolls/Re-usable | TTS | B1.88 |
|----------------------------|-----------------------------|-----|-------|

D1. Terminals

|                              |   |       |       |
|------------------------------|---|-------|-------|
| Ultra-Cinch™ Ties, Black (0) | Cinch Ties/Re-usable                        | UCT   | B1.89 |
|                              | Cinch Ties – Center Mount Grommet/Re-usable | UGCTC | B1.89 |
|                              | Cinch Ties – End Mount Grommet/Re-usable    | UGCTE | B1.89 |
|                              |   |       |       |

D2. Power Connectors

D3. Grounding Connectors

E1. Labeling Systems

E2. Labels

E3. Pre-Printed & Write-On Markers

E4. Permanent Identification

E5. Lockout/Tagout & Safety Solutions

F. Index

### Part Number System for Hook and Loop Ties

| HLT  | 2                                 | I                                | — | X  | 0              |
|--|-----------------------------------|----------------------------------|---|--|----------------|
| Type   | Size                              | Cross Section                    |   | Package Size   | Color          |
| HL = Hook and Loop                           | Approx. Maximum Bundle Dia. (In.) | I = Intermediate<br>S = Standard |   | X = 10<br>C = 100<br>15R = 15' Roll<br>20R = 20' Roll<br>35R3 = 35' Rolls (3)<br>35RX = 35' Rolls (10)<br>75R = 75' Roll | See page B1.90 |
| HLB = HL Brick                               |                                   |                                  |   |  |                |
| HLM = HL Miniature                           |                                   |                                  |   |  |                |
| HLT = HL Loop Tie                            |                                   |                                  |   |  |                |
| HLTP = HL Loop Tie Plenum-Rated              |                                   |                                  |   |  |                |
| HLS = HL Strip Tie                           |                                   |                                  |   |  |                |
| HLSP = HL Strip Tie Plenum-Rated             |                                   |                                  |   |  |                |
| TTS = Tak-Tape™ Roll                         |                                   |                                  |   |  |                |
| UCT = Ultra-Cinch™ Tie                       |                                   |                                  |   |  |                |
| UGCTC = UCT Grommet Cinch Tie – Center Mount |                                   |                                  |   |  |                |
| UGCTE = UCT Grommet Cinch Tie – End Mount    |                                   |                                  |   |  |                |

## Tak-Ty® Hook & Loop Cable Ties

- Soft, premium material is safe to use on high performance cabling protecting against over-tensioning
- Broadest selection of durable designs and sizes to meet your application needs
- Adjustable, releasable, and re-usable multiple times – ideal for applications requiring frequent moves, adds, or changes

- A full range of colors
- Operating temperature range: 0°F to 220°F (-18°C to 104°C)
- Complementary mounts available, see page B2.6

Note: Minimum 2" overlap required to achieve loop tensile rating.



HLT (Loop Ties)



HLS (Strip Ties)



HLM/HLS (Rolls)



HLB2S (Stacked Strips)



| Part Number | Length |    | Width |    | Max. Bundle Dia. |    | Min. Loop Tensile Str. |   | Std. Pkg. Qty. | Std. Ctn. Qty. |
|-------------|--------|----|-------|----|------------------|----|------------------------|---|----------------|----------------|
|             | In.    | mm | In.   | mm | In.              | mm | Lbs.                   | N |                |                |

### Loop Ties – Slot allows for pre-wrapping of bundles

|                 |      |     |       |      |      |    |    |     |    |     |
|-----------------|------|-----|-------|------|------|----|----|-----|----|-----|
| <b>HLS21-X0</b> | 8.0  | 203 | 0.500 | 12.7 | 1.91 | 49 | 40 | 178 | 10 | 100 |
| <b>HLS31-X0</b> | 12.0 | 305 | 0.500 | 12.7 | 3.18 | 81 | 40 | 178 | 10 | 100 |

### Strip Ties – Perforated in convenient 6", 12", and 18" strips

|                   |      |     |       |      |      |     |    |     |    |     |
|-------------------|------|-----|-------|------|------|-----|----|-----|----|-----|
| <b>HLS1.5S-X0</b> | 6.0  | 152 | 0.750 | 19.1 | 1.50 | 38  | 50 | 222 | 10 | 100 |
| <b>HLS3S-X0</b>   | 12.0 | 305 | 0.750 | 19.1 | 3.20 | 81  | 50 | 222 | 10 | 100 |
| <b>HLS5S-X0</b>   | 18.0 | 457 | 0.750 | 19.1 | 5.00 | 127 | 50 | 222 | 10 | 100 |

### Stacked Strip Ties – Eliminates cutting ties to length and staging them for each job

Rounded edges for installer safety – 100 pieces

|                 |     |     |       |      |      |    |    |     |   |    |
|-----------------|-----|-----|-------|------|------|----|----|-----|---|----|
| <b>HLB2S-C0</b> | 7.0 | 178 | 0.750 | 19.1 | 1.60 | 41 | 50 | 222 | 1 | 10 |
|-----------------|-----|-----|-------|------|------|----|----|-----|---|----|

| Part Number | Length |   | Width |    | Max. Bundle Dia. |    | Min. Loop Tensile Str. |   | Std. Pkg. Qty. | Std. Ctn. Qty. |
|-------------|--------|---|-------|----|------------------|----|------------------------|---|----------------|----------------|
|             | Ft.    | m | In.   | mm | In.              | mm | Lbs.                   | N |                |                |

### 15' and 75' Continuous Rolls – Can be cut to desired length, eliminating waste

|                 |      |      |      |      |         |         |    |     |   |    |
|-----------------|------|------|------|------|---------|---------|----|-----|---|----|
| <b>HLM-15R0</b> | 15.0 | 4.6  | .330 | 8.4  | Various | Various | 40 | 178 | 1 | 10 |
| <b>HLS-15R0</b> | 15.0 | 4.6  | .750 | 19.1 | Various | Various | 50 | 222 | 1 | 10 |
| <b>HLS-75R0</b> | 75.0 | 22.9 | .750 | 19.1 | Various | Various | 50 | 222 | 1 | 10 |

A. System Overview

B1. Cable Ties

B2. Cable Accessories

B3. Stainless Steel Ties

C1. Wiring Duct

C2. Surface Raceway

C3. Abrasion Protection

C4. Cable Management

D1. Terminals

D2. Power Connectors

D3. Grounding Connectors

E1. Labeling Systems

E2. Labels

E3. Pre-Printed & Write-On Markers

E4. Permanent Identification

E5. Lockout/Tagout & Safety Solutions

F. Index

A. System Overview



## Tak-Ty® Hook & Loop Cable Ties – Plenum-Rated

B1. Cable Ties

- Soft, premium material is safe to use on high performance cabling protecting against over-tensioning
- UL Listed for use in plenum or air handling spaces (such as ceiling voids and underfloor areas) per NEC, Section 300-22 (C) and (D)
- Flammability rating: UL 94V-2

- Adjustable, releasable, and re-usable multiple times – ideal for applications requiring frequent moves, adds, or changes
- Operating temperature range: 0°F to 122°F (-18°C to 50°C)

Note: Minimum 2" overlap required to achieve loop tensile rating.

B2. Cable Accessories

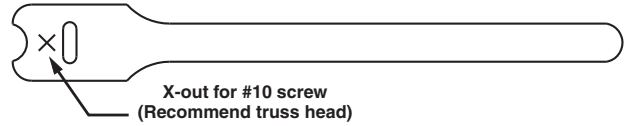
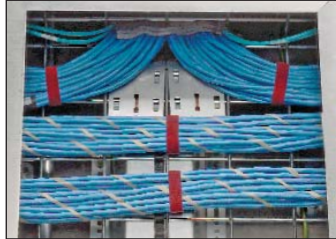

B3. Stainless Steel Ties



C1. Wiring Duct

C2. Surface Raceway

C3. Abrasion Protection

C4. Cable Management

D1. Terminals

D2. Power Connectors

D3. Grounding Connectors

E1. Labeling Systems

E2. Labels

E3. Pre-Printed & Write-On Markers

E4. Permanent Identification

E5. Lockout/Tagout & Safety Solutions

F. Index

| Part Number   | Length |     | Width |      | Max. Bundle Dia. |     | Min. Loop Tensile Str. |     | Std. Pkg. Qty. | Std. Ctn. Qty. |
|---|--------|-----|-------|------|------------------|-----|------------------------|-----|----------------|----------------|
|   | In.    | mm  | In.   | mm   | In.              | mm  | Lbs.                   | N   |                |                |
| <b>UL Listed Loop Ties (Maroon) – Slot allows for pre-wrapping of bundles</b>           |        |     |       |      |                  |     |                        |     |                |                |
| HLTP2I-X12  | 8.0    | 203 | .500  | 12.7 | 1.91             | 49  | 40                     | 178 | 10             | 100            |
| HLTP3I-X12  | 12.0   | 305 | .500  | 12.7 | 3.18             | 81  | 40                     | 178 | 10             | 100            |
| <b>UL Listed Loop Ties (Black) – Slot allows for pre-wrapping of bundles</b>            |        |     |       |      |                  |     |                        |     |                |                |
| <b>HLTP2I-X0</b>  | 8.0    | 203 | .500  | 12.7 | 1.91             | 49  | 40                     | 178 | 10             | 100            |
| <b>HLTP3I-X0</b>  | 12.0   | 305 | .500  | 12.7 | 3.18             | 81  | 40                     | 178 | 10             | 100            |
| <b>UL Listed Strip Ties (Maroon) – Perforated in convenient 6", 12", and 18" strips</b> |        |     |       |      |                  |     |                        |     |                |                |
| HLSP1.5S-X12  | 6.0    | 152 | .750  | 19.1 | 1.50             | 38  | 50                     | 222 | 10             | 100            |
| HLSP3S-X12  | 12.0   | 305 | .750  | 19.1 | 3.20             | 81  | 50                     | 222 | 10             | 100            |
| HLSP5S-X12  | 18.0   | 457 | .750  | 19.1 | 5.00             | 127 | 50                     | 222 | 10             | 100            |
| <b>UL Listed Strip Ties (Black) – Perforated in convenient 6", 12", and 18" strips</b>  |        |     |       |      |                  |     |                        |     |                |                |
| <b>HLSP1.5S-X0</b>  | 6.0    | 152 | .750  | 19.1 | 1.50             | 38  | 50                     | 222 | 10             | 100            |
| <b>HLSP3S-X0</b>  | 12.0   | 305 | .750  | 19.1 | 3.20             | 81  | 50                     | 222 | 10             | 100            |
| <b>HLSP5S-X0</b>  | 18.0   | 457 | .750  | 19.1 | 5.00             | 127 | 50                     | 222 | 10             | 100            |

## Tak-Tape™ Hook & Loop Cable Tie Rolls

- Strong, low profile, flexible material is safe to use on high performance cabling protecting against over-tensioning
- Adjustable, releasable, and re-usable
- Cost-effective for general purpose bundling
- Continuous rolls can be easily cut to size – Panduit cutter included with TTS-35RX0
- Handy, re-usable plastic case with TTS-20R0, keeps material clean

- Leaves no residue
- Available in black color
- Operating temperature range: -22°F to 194°F (-30°C to 90°C)
- Complementary mounts available, see page B2.6

Note: Minimum 2" overlap required to achieve loop tensile rating.



| Part Number       | Length |      | Width |      | Max. Bundle Dia. |         | Min. Loop Tensile Str. |     | Std. Pkg. Qty. | Std. Ctn. Qty. |
|-------------------|--------|------|-------|------|------------------|---------|------------------------|-----|----------------|----------------|
|                   | Ft.    | m    | In.   | mm   | In.              | mm      | Lbs.                   | N   |                |                |
| <b>TTS-20R0</b>   | 20.0   | 6.1  | .750  | 19.1 | Various          | Various | 40                     | 178 | 1              | 10             |
| <b>TTS-35R3-0</b> | 35.0   | 10.7 | .750  | 19.1 | Various          | Various | 40                     | 178 | 1              | 8              |
| <b>TTS-35RX0</b>  | 35.0   | 10.7 | .750  | 19.1 | Various          | Various | 40                     | 178 | 1              | 10             |

Std. Pkg. Qty. of TTS-35R3-0 denotes 1 package of three 35' rolls, TTS-35RX0 denotes 1 package of ten 35' rolls.



## Ultra-Cinch™ Hook & Loop Cable Ties

- Unique material with hooks and loops on same side allows user to secure a greater range of bundle diameters, including smaller bundles
- Soft, premium material is safe to use on high performance cabling, protecting against over-tensioning
- Adjustable, releasable, and re-usable multiple times – ideal for applications requiring frequent moves, adds, or changes
- Low profile contoured cinch ring provides extra strength and bundle tightness while reducing overall bundle size
- Grommet (UGCTC and UGCTE styles) offers strength and assures reliable installations that resist pullout when bundling and mounting cables within cabinet applications
- Tapered tip facilitates easy, snag-free threading to speed installation
- Use flat-head screws for grommet applications shown below

Note: Minimum 2" overlap required to achieve loop tensile rating.

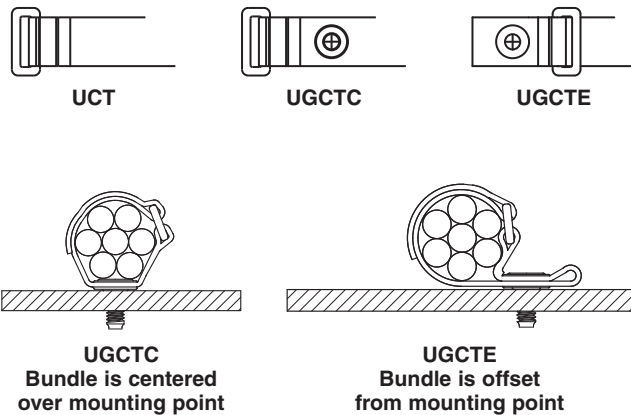

| Part Number   | Length |     | Width |      | Max. Bundle Dia. |     | Min. Loop Tensile Str. |     | Std. Pkg. Qty. | Std. Ctn. Qty. |
|---|--------|-----|-------|------|------------------|-----|------------------------|-----|----------------|----------------|
|   | In.    | mm  | In.   | mm   | In.              | mm  | Lbs.                   | N   |                |                |
| <b>Cinch Ties</b>   |        |     |       |      |                  |     |                        |     |                |                |
| UCT3S-X0  | 12.0   | 305 | .850  | 21.6 | 3.00             | 76  | 50                     | 222 | 10             | 100            |
| UCT5S-X0  | 18.0   | 457 | .850  | 21.6 | 5.00             | 127 | 50                     | 222 | 10             | 100            |
| <b>Cinch Ties – Center Mount Grommet (Bundle is centered over mounting point)</b> |        |     |       |      |                  |     |                        |     |                |                |
| UGCTC3S-X0  | 12.0   | 305 | .850  | 21.6 | 3.00             | 76  | 50                     | 222 | 10             | 100            |
| UGCTC5S-X0  | 18.0   | 457 | .850  | 21.6 | 5.00             | 127 | 50                     | 222 | 10             | 100            |
| <b>Cinch Ties – End Mount Grommet (Bundle is offset from mounting point)</b>      |        |     |       |      |                  |     |                        |     |                |                |
| UGCTE3S-X0  | 12.0   | 305 | .850  | 21.6 | 3.00             | 76  | 50                     | 222 | 10             | 100            |
| UGCTE5S-X0  | 18.7   | 475 | .850  | 21.6 | 5.00             | 127 | 50                     | 222 | 10             | 100            |

Note: 1/4" (6mm) diameter mounting hole on grommet style cinch ties.

### Flat Head Screws for Grommet Cinch Ties

| Part Number | Part Description                                   | Std. Pkg. Qty. | Std. Ctn. Qty. |
|-------------|--|----------------|----------------|
| UCTGS1224-X | 12-24 UNC x 5/8mm (.625") flat head phillips screw | 10             | 100            |
| UCTGSM5-X   | M5 x 16mm flat head phillips screw                 | 10             | 100            |
| UCTGSM6-X   | M6 x 16mm flat head phillips screw                 | 10             | 100            |

A.  
System  
Overview

B1.  
Cable  
Ties

B2.  
Cable  
Accessories

B3.  
Stainless  
Steel Ties

C1.  
Wiring  
Duct

C2.  
Surface  
Raceway

C3.  
Abrasion  
Protection

C4.  
Cable  
Management

D1.  
Terminals

D2.  
Power  
Connectors

D3.  
Grounding  
Connectors

E1.  
Labeling  
Systems

E2.  
Labels

E3.  
Pre-Printed  
& Write-On  
Markers

E4.  
Permanent  
Identification

E5.  
Lockout/  
Tagout  
& Safety  
Solutions

F.  
Index



A.  
System  
Overview

## Hook and Loop Cable Ties

B1.  
Cable Ties

### Color Chart

| Color  | Panduit<br>Suffix |
|--------|-------------------|
| Black  | 0                 |
| Red    | 2                 |
| Orange | 3                 |
| Yellow | 4                 |
| Green  | 5                 |

| Color  | Panduit<br>Suffix |
|--------|-------------------|
| Blue   | 6                 |
| Gray   | 8                 |
| White  | 10                |
| Maroon | 12                |

C1.  
Wiring  
Duct

C2.  
Surface  
Raceway

C3.  
Abrasion  
Protection

C4.  
Cable  
Management

D1.  
Terminals

D2.  
Power  
Connectors

D3.  
Grounding  
Connectors

E1.  
Labeling  
Systems

E2.  
Labels

E3.  
Pre-Printed  
& Write-On  
Markers

E4.  
Permanent  
Identification

E5.  
Lockout/  
Tagout  
& Safety  
Solutions

F.  
Index

### Part Number Availability List

| Standard Packaging |                  |
|--------------------|------------------|
| Part Number        | Color            |
| HLB2S              | 0                |
| HLM-15R            | 0,2,3,4,5,6,8,10 |
| HLS-15R            | 0,2,3,4,5,6,8,10 |
| HLS-75R            | 0,2,3,4,5,6,8,10 |
| HLS1.5S-X          | 0,2,3,4,5,6,8,10 |
| HLS3S-X            | 0,2,3,4,5,6,8,10 |
| HLS5S-X            | 0,2,3,4,5,6,8,10 |
| HLSP1.5S-X         | 0,12             |
| HLSP3S-X           | 0,12             |
| HLSP5S-X           | 0,12             |
| HLT2I-X            | 0,2,3,4,5,6,8,10 |
| HLT3I-X            | 0,2,3,4,5,6,8,10 |
| HLTP2I-X           | 0,12             |
| HLTP3I-X           | 0,12             |
| TTS-20R            | 0                |
| TTS-35RX           | 0                |
| TTS-35R3           | 0                |
| UCT3S-X            | 0,2,3,4,5,6,8,10 |
| UCT5S-X            | 0,2,3,4,5,6,8,10 |
| UGCTC3S-X          | 0,2,3,4,5,6,8,10 |
| UGCTC5S-X          | 0,2,3,4,5,6,8,10 |
| UGCTE3S-X          | 0,2,3,4,5,6,8,10 |
| UGCTE5S-X          | 0,2,3,4,5,6,8,10 |



## HLW Marker Hook and Loop Wrap Ties

- Safe choice for network cable bundling
- Re-usable multiple times; use where frequent moves, adds, and changes are anticipated

- Black tie contains a white rectangular "write-on" area where users can write a message using Panduit permanent marking pens on page B2.28
- Minimum 2" overlap required to achieve loop tensile rating



| Part Number | Max. Bundle Diameter In. (mm) | Length In. (mm) | Width In. (mm) | Thickness In. (mm) | Marker Write-on Area In. (mm) | Min. Loop Tensile Strength Lbs. (N) | Std. Pkg. Qty. | Std. Ctn. Qty. |
|-------------|-------------------------------|-----------------|----------------|--------------------|-------------------------------|-------------------------------------|----------------|----------------|
| HLWM1.5S-X0 | 1.5 (38)                      | 6.0 (152)       | 0.790 (20.1)   | 0.17 (4.3)         | 2.5 x 0.50<br>63.5 x 12.7     | 50 (222)                            | 10             | 100            |
| HLWM3S-X0   | 3.2 (81)                      | 12.0 (305)      | 0.790 (20.1)   | 0.17 (4.3)         | 2.5 x 0.50<br>63.5 x 12.7     | 50 (222)                            | 10             | 100            |

## Elastomeric Cable Ties – ERT



- Elastic material provides a flexible tie body that safely contours around cable bundle to prevent over-tensioning of data cables to maintain network integrity
- UL 94V-0 material provides greater flame resistance and meets stringent telecommunication flammability requirements (i.e. NEBS GR-63-CORE)
- Greater resistance to damage caused by ultraviolet light – indoor or outdoor use
- Soft material has no sharp edges to protect the installer and cable bundle for improved jobsite safety and reliability

- The high coefficient of friction material provides a tight grip and prevents lateral movement along cable bundle, minimizing overall installation time and potential re-work
- Releasable design allows release and re-use to accommodate frequent moves, adds, and changes to support evolving equipment and cabling needs
- Halogen-free, non-toxic and environmentally safe material will not release toxic or corrosive gases upon combustion
- Locking head design; the tapered tip tail threads into locking head to speed productivity; industry-accepted, intuitive tie design



| Part Number | Color | Length In. (mm) | Width In. (mm) | Thickness In. (mm) | Head Height In. (mm) | Head Width In. (mm) | Min. Loop Tensile Strength Lbs. (N) | Std. Pkg. Qty. | Std. Ctn. Qty. |
|-------------|-------|-----------------|----------------|--------------------|----------------------|---------------------|-------------------------------------|----------------|----------------|
| ERT2M-C20   | Black | 8.5 (216)       | 0.500 (12.70)  | 0.090 (2.29)       | .323 (8.20)          | .841 (21.36)        | 18 (80)                             | 100            | 1000           |
| ERT3M-C20   | Black | 11.0 (279)      |                |                    |                      |                     |                                     | 100            | 1000           |
| ERT4.5M-C20 | Black | 16.0 (406)      |                |                    |                      |                     |                                     | 100            | 1000           |

A. System Overview

B1. Cable Ties

B2. Cable Accessories

B3. Stainless Steel Ties

C1. Wiring Duct

C2. Surface Raceway

C3. Abrasion Protection

C4. Cable Management

D1. Terminals

D2. Power Connectors

D3. Grounding Connectors

E1. Labeling Systems

E2. Labels

E3. Pre-Printed & Write-On Markers

E4. Permanent Identification

E5. Lockout/Tagout & Safety Solutions

F. Index



## Cable Bundle Organizing Tool

A. System Overview

B1. Cable Ties

B2. Cable Accessories

B3. Stainless Steel Ties

C1. Wiring Duct

C2. Surface Raceway

C3. Abrasion Protection

C4. Cable Management

D1. Terminals

D2. Power Connectors

D3. Grounding Connectors

E1. Labeling Systems

E2. Labels

E3. Pre-Printed & Write-On Markers

E4. Permanent Identification

E5. Lockout/Tagout & Safety Solutions

F. Index

- Reduces cable installation time up to 50% compared to traditional methods
- Arranges 24 cables prior to applying Panduit network cable ties
- Optimizes bundle size and improves installed appearance
- Two inserts handle multiple network cable diameters

- Unique design allows twist-free bundling from the end or the middle of bundle
- Smooth edges; safe for use on network cables preventing cable abrasion
- Ergonomic fit and compact design
- Impact resistant material and low friction design to glide smoothly across cable bundle



| Part Number | Description  | Recommended for Cable Outer Diameter Range | Use the Following Insert | Insert Used with the Following Panduit Cable Types                               | Std. Pkg. Qty. | Std. Ctn. Qty. |
|-------------|--|--|--------------------------|--|----------------|----------------|
| CBOT24K     | Kit contains jacket cover with hook and loop fastener and two inserts. | 0.180" – 0.248"<br>(4.57mm – 6.30mm)       | Fluorescent Green        | TX5500™ Category 5e UTP<br>TX6000™ Category 6 UTP                                | 1              | 10             |
|             |  | 0.230" – 0.310"<br>(5.84mm – 7.87mm)       | Fluorescent Yellow       | TX6500™ Enhanced Category 6<br>TX6A™ 10Gig™ Category 6A**<br>All Shielded Cables |                |                |

\*\*When using the CBOT24K on 10 Gigabit cables, it is recommended that Panduit 10Gig™ Category 6A cables be used for optimum performance of installed cable. See [www.panduit.com](http://www.panduit.com) for cable details.

## Installation Instructions

The steps below outline how easy it is to use the Panduit cable bundle organizing tool starting from the middle of the bundle outwards, using two tools. For starting at the end of the bundle, follow the same steps using only one tool. (Use above table to select appropriate insert based on cable diameter/type.)

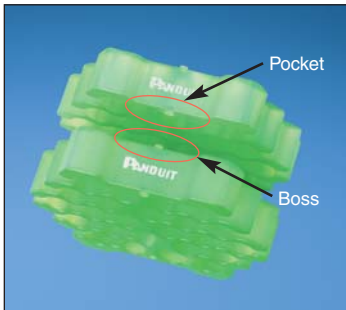

### Step 1

Use the unique pocket and boss features to align two same color inserts. Hold both together.



### Step 2

Insert cables, one at a time, into the pre-formed slots of both inserts until all cables are installed.

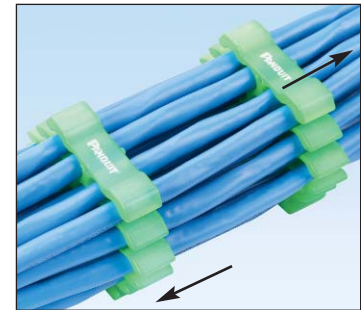

### Step 3

Pull the two inserts apart.



### Step 4

Place the jacket cover around each insert and secure with the attached hook and loop fastener.



### Step 5

Guide the tool along the bundle length to organize the cables, stopping at desired intervals to apply Panduit Network Cable Ties.



### Step 6

When completed, slide tool off of cable bundle. The Panduit cable bundle organizing tool reduces installation time up to 50% and delivers a professional, organized installation.

## Hot Stamping Service Custom Printed Cable Ties

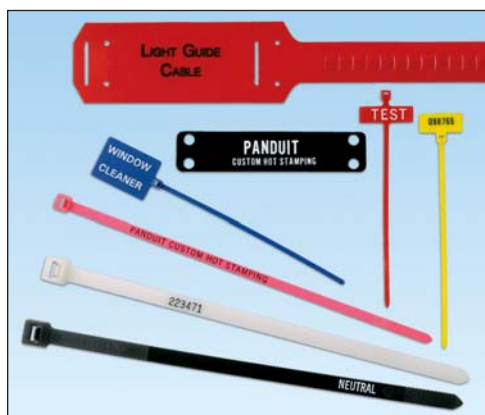

Custom Hot Stamping Service provides a permanent, high quality imprinted message on Panduit cable ties and marker plates. Graphics, text, numbers and colors provide a variety of choices for customization.

Hot stamped cable ties and marker plates are typically used for identification, or for labeling critical components. Panduit cable ties, marker ties, marker plates and marker straps are available to suit your application.

Your choice of:

- Seven text colors (black, blue, green, red, yellow, orange, white)
- A variety of characters and fonts
- Sequential numbering
- Special customer logos and diagrams

### FAST! TWO WEEK LEAD TIME

Minimum Order: (Pieces/part number and message)

- 5,000 for Miniature\*, Intermediate, Standard and Heavy-Standard cross section cable ties
- 3,000 for Light-Heavy, Heavy, and Extra-Heavy cross section cable ties
- 3,000 for Hook and Loop Wrap Ties

For hot stamping orders and inquiries, please call 1-800-777-3300



### Cable Ties

- Used wherever you need to bundle wire, cable, hose or tubing
- A variety of colors for color-coding applications
- Cross Sections: Intermediate, Standard, Heavy-Standard, Light-Heavy, Heavy and Extra-Heavy

### Marker and Flag Ties

- Fasten and identify bundles at the same time
- A variety of colors for color-coding applications
- Cross Sections: Miniature and Standard

### Marker Plates

- Mount in any direction, either vertically or horizontally as flags, tags, or wrap-around identification plates.
- White or Weather Resistant black color
- Marker plate sizes:
 

|              |               |
|--------------|---------------|
| 1.50" x .75" | 2.50" x .75"  |
| 1.75" x .75" | 3.50" x .75"  |
| 2.00" x .75" | 2.50" x 1.75" |

### Cable Marker Straps

- Identify and code telephone and fiber optic cable – replaces costly and cumbersome lead marking tags
- Lightweight and easy to install
- Can be used as **wrap-around** or **flag** marker
- Also can be used in underground identification applications
- Polyethylene material available in red and gray
- Marking area: 1.50" x 2.62"

\*Custom imprinting available on Miniature cross section for the Flag Style Cable Ties (PLF) only.



## Panduit Cable Tie Approvals

|                                       | Logo (Symbol) | Agency                              | Spec/Approval   | Requirement  | Applicable Products  |
|---------------------------------------|---------------|-------------------------------------|---|--|--|
| B1. Cable Ties                        |               | Underwriters Laboratories, Inc.     | File E56854 and MH29590   | ZODZ(7), ZODZ(8), ALKW   | Most miniature, intermediate, standard, light-heavy and heavy cross section ties are Recognized or Listed in the US and Canada |
| B2. Cable Accessories                 |               | Canadian Standards Association      | File 031212   | C22.2 No. 18.5-02 under the category "Fittings – Positioning Devices"  | Most miniature, intermediate, standard, light-heavy and heavy cross section ties are Recognized or Listed in the US and Canada |
| B3. Stainless Steel Ties              |               | Conformity European                 | Low Voltage Directive 73/23/EEC (amended 93/68/EEC). PAN-TY AND Dome-Top Barb Ty cable ties also meet the requirements from EN50146 | CE Marking is required for products sold within the European Union. CE Marking Directives specify the minimum performance of these products. Applying the CE mark signifies compliance with essential requirements of specific directives.                                     | All cable tie products   |
| C1. Wiring Duct                       |               | ABS (American Bureau of Shipping)   | 05-HS463235-PDA   | 2005 Vessel Rules 1-1-4/7.7, 4-8/421.9.3 2001 MODU Rules 4-3-3/5.9.1   | PLT Series, BT Series  |
| C2. Surface Raceway                   |               | Bureau Veritas                      | Cert 05968/C0 BV1178B/BVN/04 File ACE 14/601/01   | Bureau Veritas Rules for the Classification of Steel Ships   | PLT Series, BT Series, PRT Series, CBR Series  |
| C3. Abrasion Protection               |               | Det Norske Veritas                  | E-6405  | Det Norske Veritas' Rules for Classification of Ships and Mobile Offshore Units  | PLT Series, PLC Series, PLM Series, PRT Series, PLWP Series, PRWP Series, PRST Series  |
| C4. Cable Management                  |               | Germany (VG) Military               | K17/97165   | VG 95 387 – 100 MS 3367F   | PLT Series, BT Series, SST Series  |
| D1. Terminals                         |               | Lloyd's Register of Shipping        | 89/60111 (E3)   | Lloyd's Register Type Approval   | PLT Series, BT Series, SST Series  |
| D2. Power Connectors                  |               | NRC (Nuclear Regulatory Commission) | NRC 10CFR50   | Quality Assurance Criteria for Nuclear Plants and Reprocessing Plants  | All cable tie products   |
| D3. Grounding Connectors              |               | Plenum-Rated                        | Panduit logo  | Panduit symbol indicates that the cable ties represented are suitable for use in plenum or air handling spaces in accordance with Sec. 300.22(C) and (D) of the National Electrical Code and Rules 12-010 (3), (4) and (5) and 12-020 of the Canadian Electrical Code, Part I. | Halar (702Y) and select Nylon 6.6 cable ties as noted throughout catalog   |
| E1. Labeling Systems                  |               | US Military Aerospace Standard      | QPL-AS23190-2   | SAE spec AS23190   | See Military Cross Reference Page B1.95  |
| E2. Labels                            |               | AQA International                   | ISO/TS16949   | AQA registration. Quality management system assessment certificate   | Tinley Park, Illinois Manufacturing Operations (Cable Tie Division) Quality Management System.                                 |
| E3. Pre-Printed & Write-On Markers    |               |                                     |   |  |  |
| E4. Permanent Identification          |               |                                     |   |  |  |
| E5. Lockout/Tagout & Safety Solutions |               |                                     |   |  |  |
| F. Index                              |               |                                     |   |  |  |



## Military Cross Reference

The Panduit cable ties and marker ties listed in the following tables meet all of the testing requirements of Aerospace Standard SAE-AS23190A (formerly MIL-S-23190E) and the dimensional requirements of Aerospace Standards SAE-AS33671 (formerly MS3367) and SAE-AS33681 (formerly MS3368).

| Cable Tie Cross Reference |         |                         |                   |             |                  |             |
|---------------------------|---------|-------------------------|-------------------|-------------|------------------|-------------|
| Mil. Std. Part Number     | Color   | Pan-Ty®                 | Dome-Top® Barb Ty | Sta-Strap®  | Belt-Ty™ In-Line | Contour-Ty® |
| MS3367-1-0                | Black*  | PLT2S-C00, -M00         | —                 | —           | —                | —           |
| MS3367-1-1                | Brown   | PLT2S-C1, -M1           | BT2S-M1           | —           | —                | —           |
| MS3367-1-2                | Red     | PLT2S-C2, -M2           | BT2S-M2           | —           | —                | —           |
| MS3367-1-3                | Orange  | PLT2S-C3, -M3           | BT2S-M3           | —           | —                | —           |
| MS3367-1-4                | Yellow  | PLT2S-C4Y, -M4Y         | BT2S-M4Y          | —           | —                | —           |
| MS3367-1-5                | Green   | PLT2S-C5, -M5           | BT2S-M5           | —           | —                | —           |
| MS3367-1-6                | Blue    | PLT2S-C6, -M6           | BT2S-M6           | —           | —                | —           |
| MS3367-1-7                | Purple  | PLT2S-C7, -M7           | BT2S-M7           | —           | —                | —           |
| MS3367-1-8                | Gray    | PLT2S-C8, -M8           | BT2S-M8           | —           | —                | —           |
| MS3367-1-9                | Natural | PLT2S-C, -M, -VMR       | BT2S-C, -M        | SST2S-C, -M | —                | —           |
| MS3367-2-0                | Black*  | PLT4S-C00, -M00         | —                 | —           | —                | —           |
| MS3367-2-1                | Brown   | PLT4S-M1                | —                 | —           | —                | —           |
| MS3367-2-2                | Red     | PLT4S-C2, -M2           | BT4S-M2           | SST4S-M2    | —                | —           |
| MS3367-2-3                | Orange  | PLT4S-C3, -M3           | BT4S-M3           | —           | —                | —           |
| MS3367-2-4                | Yellow  | PLT4S-C4Y, -M4Y         | BT4S-M4Y          | —           | —                | —           |
| MS3367-2-5                | Green   | PLT4S-C5, -M5           | BT4S-M5           | —           | —                | —           |
| MS3367-2-6                | Blue    | PLT4S-C6, -M6           | BT4S-M6           | —           | —                | —           |
| MS3367-2-7                | Purple  | PLT4S-C7, -M7           | BT4S-M7           | —           | —                | —           |
| MS3367-2-8                | Gray    | PLT4S-C8, -M8           | BT4S-M8           | —           | —                | —           |
| MS3367-2-9                | Natural | PLT4S-C, -M             | BT4S-C, -M        | SST4S-C, -M | —                | —           |
| MS3367-3-0                | Black*  | PLT4H-L00, -TL00        | —                 | —           | —                | —           |
| MS3367-3-1                | Brown   | PLT4H-TL1               | —                 | —           | —                | —           |
| MS3367-3-2                | Red     | PLT4H-TL2               | —                 | —           | —                | —           |
| MS3367-3-3                | Orange  | PLT4H-TL3               | —                 | —           | —                | —           |
| MS3367-3-4                | Yellow  | PLT4H-TL4Y              | —                 | —           | —                | —           |
| MS3367-3-5                | Green   | PLT4H-TL5               | —                 | —           | —                | —           |
| MS3367-3-6                | Blue    | PLT4H-TL6               | —                 | —           | —                | —           |
| MS3367-3-9                | Natural | PLT4H-L, -C, -TL        | BT4LH-L, -TL      | SST4H-L, -D | —                | —           |
| MS3367-4-0                | Black*  | PLT1M-C00, -M00, -XMR00 | —                 | —           | —                | —           |
| MS3367-4-0                | Black*  | PLT1.5M-XMR00           | —                 | —           | —                | —           |
| MS3367-4-1                | Brown   | PLT1M-C1, -M1, -XMR1    | BT1M-M1           | —           | —                | —           |
| MS3367-4-2                | Red     | PLT1M-C2, -M2, -XMR2    | BT1M-M2           | —           | —                | —           |
| MS3367-4-3                | Orange  | PLT1M-C3, -M3, -XMR3    | BT1M-M3           | —           | —                | —           |
| MS3367-4-4                | Yellow  | PLT1M-C4Y, -M4Y, -XMR4Y | BT1M-M4Y          | —           | —                | —           |
| MS3367-4-5                | Green   | PLT1M-C5, -M5, -XMR5    | BT1M-M5           | —           | —                | —           |
| MS3367-4-6                | Blue    | PLT1M-C6, -M6, -XMR6    | BT1M-M6           | —           | —                | —           |
| MS3367-4-7                | Purple  | PLT1M-C7, -M7, -XMR7    | BT1M-M7           | —           | —                | —           |
| MS3367-4-8                | Gray    | PLT1M-C8, -M8, -XMR8    | BT1M-M8           | —           | —                | —           |
| MS3367-4-9                | Natural | PLT1M-C, -M, -XMR       | BT1M-C, -M, -XMR  | SST1M-C, -M | —                | —           |
| MS3367-4-9                | Natural | PLT.7M-C, -M            | —                 | —           | —                | —           |
| MS3367-4-9                | Natural | PLT1.5M-XMR             | BT1.5M-XMR        | —           | —                | —           |
| MS3367-5-0                | Black*  | PLT1.5I-M00             | —                 | —           | —                | —           |
| MS3367-5-1                | Brown   | PLT1.5I-C1, -M1         | BT1.5I-M1         | —           | —                | —           |
| MS3367-5-2                | Red     | PLT1.5I-C2, -M2         | BT1.5I-M2         | —           | —                | —           |
| MS3367-5-3                | Orange  | PLT1.5I-C3, -M3         | BT1.5I-M3         | —           | —                | —           |
| MS3367-5-4                | Yellow  | PLT1.5I-C4Y, -M4Y       | BT1.5I-M4Y        | —           | —                | —           |

\*Weather resistant per ASTM D 4066-94B.

Table continues on page B1.96

A.  
System  
Overview

## Military Cross Reference (continued)

B1.  
Cable Ties

B2.  
Cable  
Accessories

B3.  
Stainless  
Steel Ties

C1.  
Wiring  
Duct

C2.  
Surface  
Raceway

C3.  
Abrasion  
Protection

C4.  
Cable  
Management

D1.  
Terminals

D2.  
Power  
Connectors

D3.  
Grounding  
Connectors

E1.  
Labeling  
Systems

E2.  
Labels

E3.  
Pre-Printed  
& Write-On  
Markers

E4.  
Permanent  
Identification

E5.  
Lockout/  
Tagout  
& Safety  
Solutions

F.  
Index

### Cable Tie Cross Reference

| Mil. Std. Part Number | Color   | Pan-Ty®         | Dome-Top® Barb Ty | Sta-Strap®    | Belt-Ty™ In-Line | Contour-Ty® |
|-----------------------|---------|-----------------|-------------------|---------------|------------------|-------------|
| MS3367-5-5            | Green   | PLT1.5I-C5, -M5 | BT1.5I-M5         | —             | —                | —           |
| MS3367-5-6            | Blue    | PLT1.5I-C6, -M6 | BT1.5I-M6         | —             | —                | —           |
| MS3367-5-7            | Purple  | PLT1.5I-C7, -M7 | BT1.5I-M7         | —             | —                | —           |
| MS3367-5-8            | Gray    | PLT1.5I-C8, -M8 | BT1.5I-M8         | —             | —                | —           |
| MS3367-5-9            | Natural | PLT1.5I-C, -M   | BT1.5I-C, -M      | SST1.5I-C, -M | —                | —           |
| MS3367-6-9            | Natural | PLT8LH-L, -C    | BT8LH-L, -C       | SST8H-L, -D   | —                | —           |
| MS3367-6-9            | Natural | —               | BT9LH-L, -C       | —             | —                | —           |
| MS3367-7-0            | Black*  | PLT3S-C00, -M00 | —                 | —             | —                | —           |
| MS3367-7-1            | Brown   | PLT3S-M1        | —                 | —             | —                | —           |
| MS3367-7-2            | Red     | PLT3S-C2, -M2   | BT3S-C2           | —             | —                | —           |
| MS3367-7-3            | Orange  | PLT3S-M3        | —                 | —             | —                | —           |
| MS3367-7-4            | Yellow  | PLT3S-M4Y       | —                 | —             | —                | —           |
| MS3367-7-5            | Green   | PLT3S-M5        | —                 | —             | —                | —           |
| MS3367-7-6            | Blue    | PLT3S-M6        | —                 | —             | —                | —           |
| MS3367-7-7            | Purple  | PLT3S-M7        | —                 | —             | —                | —           |
| MS3367-7-8            | Gray    | PLT3S-M8        | —                 | —             | —                | —           |
| MS3367-7-9            | Natural | PLT3S-C, -M     | BT3S-C, -M        | SST3S-C, -M   | —                | —           |
| MS3367-8-9            | Natural | PLT5H-L, -C     | —                 | —             | —                | —           |
| MS3367-9-9            | Natural | PLT6H-L, -C     | —                 | —             | —                | —           |
| MS3367-11-9           | Natural | PLT8H-L, -C     | —                 | —             | —                | —           |
| MS3367-14-9           | Natural | PLT13H-Q, -C    | —                 | —             | —                | —           |
| MS3367-20-9           | Natural | PLT5EH-Q, -C    | —                 | —             | —                | —           |
| MS3367-21-9           | Natural | PLT6EH-Q, -C    | —                 | —             | —                | —           |
| MS3367-22-9           | Natural | PLT8EH-C        | —                 | —             | —                | —           |
| MS3367-23-9           | Natural | —               | —                 | —             | ILT2S-C, -M      | —           |
| MS3367-24-9           | Natural | —               | —                 | —             | ILT4S-C, -M      | —           |
| MS3367-25-9           | Natural | —               | —                 | —             | ILT4LH-TL        | —           |
| MS3367-29-9           | Natural | —               | —                 | —             | ILT3S-C, -M      | —           |
| MS3367-30-9           | Natural | —               | —                 | —             | —                | CBR1M-M     |
| MS3367-31-9           | Natural | —               | —                 | —             | —                | CBR1.5M-M   |
| MS3367-32-1           | Brown   | —               | —                 | —             | —                | CBR2M-M1    |
| MS3367-32-2           | Red     | —               | —                 | —             | —                | CBR2M-M2    |
| MS3367-32-3           | Orange  | —               | —                 | —             | —                | CBR2M-M3    |
| MS3367-32-4           | Yellow  | —               | —                 | —             | —                | CBR2M-M4Y   |
| MS3367-32-5           | Green   | —               | —                 | —             | —                | CBR2M-M5    |
| MS3367-32-6           | Blue    | —               | —                 | —             | —                | CBR2M-M6    |
| MS3367-32-7           | Purple  | —               | —                 | —             | —                | CBR2M-M7    |
| MS3367-32-9           | Natural | —               | —                 | —             | —                | CBR2M-M     |
| MS3367-33-9           | Natural | —               | —                 | —             | —                | CBR1.5I-M   |
| MS3367-34-1           | Brown   | —               | —                 | —             | —                | CBR3I-M1    |
| MS3367-34-2           | Red     | —               | —                 | —             | —                | CBR3I-M2    |
| MS3367-34-3           | Orange  | —               | —                 | —             | —                | CBR3I-M3    |
| MS3367-34-4           | Yellow  | —               | —                 | —             | —                | CBR3I-M4Y   |
| MS3367-34-5           | Green   | —               | —                 | —             | —                | CBR3I-M5    |
| MS3367-34-6           | Blue    | —               | —                 | —             | —                | CBR3I-M6    |
| MS3367-34-7           | Purple  | —               | —                 | —             | —                | CBR3I-M7    |
| MS3367-34-8           | Gray    | —               | —                 | —             | —                | CBR3I-M8    |
| MS3367-34-9           | Natural | —               | —                 | —             | —                | CBR3I-M     |
| MS3367-35-9           | Natural | —               | —                 | —             | —                | CBR4I-M     |

\*Weather resistant per ASTM D 4066-94B.

### Cable Tie Cross Reference

| Mil. Std. Part Number | Color   | Pan-Ty®         | Dome-Top® Barb Ty | Sta-Strap®  | Belt-Ty™ In-Line | Contour-Ty® |
|-----------------------|---------|-----------------|-------------------|-------------|------------------|-------------|
| MS3367-36-9           | Natural | —               | —                 | —           | —                | CBR2S-M     |
| MS3367-37-9           | Natural | —               | —                 | —           | —                | CBR3S-M     |
| MS3367-38-9           | Natural | —               | —                 | —           | —                | CBR4S-M     |
| MS3367-39-9           | Natural | —               | —                 | —           | —                | CBR2HS-D    |
| MS3367-40-9           | Natural | —               | —                 | —           | —                | CBR4LH-TL   |
| MS3367-41-9           | Natural | —               | —                 | —           | —                | CBR6LH-C    |
| MS3368-1-2A           | Red     | PLM2S-D2        | —                 | —           | —                | —           |
| MS3368-1-3A           | Orange  | PLM2S-D3        | —                 | —           | —                | —           |
| MS3368-1-4A           | Yellow  | PLM2S-C4Y, -D4Y | —                 | —           | —                | —           |
| MS3368-1-5A           | Green   | PLM2S-D5        | —                 | —           | —                | —           |
| MS3368-1-6A           | Blue    | PLM2S-D6        | —                 | —           | —                | —           |
| MS3368-1-8A           | Gray    | PLM2S-D8        | —                 | —           | —                | —           |
| MS3368-1-9A           | Natural | PLM2S-C, -D     | BM2S-C, -D        | —           | —                | —           |
| MS3368-1-9B           | Natural | —               | —                 | SSM2S-C, -D | —                | —           |
| MS3368-2-2A           | Red     | PLM4S-D2        | —                 | —           | —                | —           |
| MS3368-2-4A           | Yellow  | PLM4S-D4Y       | —                 | —           | —                | —           |
| MS3368-2-6A           | Blue    | PLM4S-D6        | —                 | —           | —                | —           |
| MS3368-2-9A           | Natural | PLM4S-C, -D     | BM4S-C, -D        | —           | —                | —           |
| MS3368-2-9B           | Natural | —               | —                 | SSM4S-D     | —                | —           |
| MS3368-3-4C           | Yellow  | PL2M2S-D4Y      | —                 | —           | —                | —           |
| MS3368-3-9C           | Natural | PL2M2S-L, -D    | B2M2S-D           | —           | —                | —           |
| MS3368-4-4D           | Yellow  | PL3M2S-D4Y      | —                 | —           | —                | —           |
| MS3368-4-9D           | Natural | PL3M2S-L, -D    | B3M2S-TL          | —           | —                | —           |
| MS3368-5-1E           | Brown   | PLM1M-M1        | —                 | —           | —                | —           |
| MS3368-5-2E           | Red     | PLM1M-M2        | —                 | —           | —                | —           |
| MS3368-5-3E           | Orange  | PLM1M-M3        | —                 | —           | —                | —           |
| MS3368-5-4E           | Yellow  | PLM1M-M4Y       | —                 | —           | —                | —           |
| MS3368-5-5E           | Green   | PLM1M-M5        | —                 | —           | —                | —           |
| MS3368-5-6E           | Blue    | PLM1M-M6        | —                 | —           | —                | —           |
| MS3368-5-7E           | Purple  | PLM1M-M7        | —                 | —           | —                | —           |
| MS3368-5-8E           | Gray    | PLM1M-M8        | —                 | —           | —                | —           |
| MS3368-5-9E           | Natural | PLM1M-C, -M     | BM1M-C, -M        | —           | —                | —           |

## Installation Tools

The Panduit installation tools listed in the table below meet all of the testing requirements of MIL-T-81306 and the dimensional requirements of MS90387.

| Mil. Spec. Part Number | Panduit Part Number |
|------------------------|---------------------|
| MS90387-1              | GTS, GS2B           |
| MS90387-2              | GS4H, GTH           |
| MS90387-4              | GS4EH               |
| MS90387-5              | GTSL                |

A.  
System  
Overview

## Cable Tie Selection and Specification Guidelines

B1.  
Cable Ties

### Selecting the Proper Cable Tie Material for Your Application

B2.  
Cable  
Accessories

By using the information on our material selection chart on pages B1.2 and B1.3 as a guide, the user will be better equipped to select the best cable tie and material suited to perform its intended function over a long period of time.

B3.  
Stainless  
Steel Ties

For long life and dependable service, there are many factors to consider when selecting the proper cable tie for each application. Since it is impossible for Panduit to provide data on all the various combinations of conditions which may arise, it is suggested that this data be used as a guide. Sample cable ties should be tested under actual end-use conditions to determine the correct cable tie for the application.

C1.  
Wiring  
Duct

To select the optimum cable tie for a specific application, the chart on pages B1.2 and B1.3 can be used as a reference. First, determine the most critical design criteria and then read across the table to find which material is most suitable to meet this need. Next, review the other criteria by scanning in a vertical direction on the chart and then make your final selection.

C2.  
Surface  
Raceway

#### Example No. 1

| Application   | Selection   |
|---|---|
| The application requires high radiation (2 x 10 <sup>6</sup> rads) resistance and excellent resistance to hydrocarbons. | The best choice is PEEK, TEFZEL <sup>■</sup> , or HALAR <sup>▲</sup> . The price is higher than other materials, but all have high ratings in resistance to radiation and hydrocarbons. |

C3.  
Abrasion  
Protection

#### Example No. 2

| Application   | Selection   |
|---|---|
| The application requires a low cost material, good ultraviolet resistance, and good resistance to acid rains. | The best choice is Weather Resistant Polypropylene. Price is medium, the UV rating is 6, and the acid resistance rating is 9. |

C4.  
Cable  
Management

D1.  
Terminals

■TEFZEL is a registered trademark of E.I. du Pont de Nemours and Company.  
▲HALAR is a registered trademark of Ausimont USA, Inc.

D2.  
Power  
Connectors

D3.  
Grounding  
Connectors

E1.  
Labeling  
Systems

E2.  
Labels

E3.  
Pre-Printed  
& Write-On  
Markers

E4.  
Permanent  
Identification

E5.  
Lockout/  
Tagout  
& Safety  
Solutions

F.  
Index

## Weathering

Over a period of time, ultraviolet light (a component of sunlight) attacks most plastic materials and reduces their properties by breaking the molecular chain. The material breakdown is accompanied by reductions in tensile strength and elongation, increased brittleness, color changes and loss of surface gloss.

Carbon black, which is used in Panduit nylon, polypropylene, and acetal cable ties, is one of the most effective stabilizers known today. A uniform dispersion of carbon black provides good ultraviolet light resistance without adversely affecting physical properties. The addition of carbon black, or any other ultraviolet light stabilizer, prolongs the useful outdoor life of plastic products, but it does not totally eliminate the destructive effects of the light. Some plastics, such as TEFZEL<sup>■</sup> or HALAR<sup>▲</sup>, are intrinsically very resistant to ultraviolet light and do not require stabilizing additives.

## Weathering Test Methods

In order to monitor the effects of ultraviolet light and the effectiveness of ultraviolet stabilizers, Panduit, in conformance with industry standards, adopted two methods of weatherability testing: Outdoor Aging and Accelerated Weather Aging.

## Outdoor Aging

The Outdoor Aging method is probably the best and most realistic method of the two. It is conducted in accordance with ASTM D 1435 Standard Practice for Outdoor Weathering of Plastics, and allows the material to be affected by not only ultraviolet light, but by all other outdoor elements as well. Although this may more closely approximate an actual application, two drawbacks do exist. The period of time required to produce property decay and material failure may be quite long, and varying adverse chemical environments cannot be tested.

## Accelerated Weather Aging

Accelerated weathering tests are conducted to estimate the rate of degradation due to a combination of ultraviolet light, temperature, and moisture. The methods used are in accordance with the following standards:

- ASTM D 1499, Operating Light and Water Exposure Apparatus (Carbon-Arc type) for exposure to plastics
- ASTM G 154-04, Operating Light and Water Exposure (Fluorescent UV Condensation type) for exposure of non-metallic materials

The condition specified in ASTM D 1499 utilizes a water spray and a carbon arc to simulate natural sunshine. The test chamber is operated 20 hrs./day with a two-hour cycle of 108 minutes of simulated sunshine and twelve minutes of sunshine and water spray. The temperature of a black body inside the chamber is approximately 63°C (145°F) during the “sunshine only” portion of the cycle. Humidity is not controlled inside the chamber.

The test chamber per ASTM G 154-04 uses fluorescent sun lamps to generate ultraviolet light only. A heated water pan produces condensation during a portion of the cycle. The daily cycle is composed of 20 hours of light followed by 4 hours of condensation. Black body temperatures during the light cycle are 50°C (122°F) and 40°C (104°F) during the condensation cycle.

Panduit has also designed a special chamber, which is used to simulate the effect of acid rain and ultraviolet light on cable tie materials. The effects of other common chemicals, such as road salt, are also evaluated in this chamber.

These methods are effective in quickly determining the ultraviolet light resistance of the various cable tie materials, but it must be emphasized that there are no exact correlations between accelerated aging and actual outdoor exposure.

■TEFZEL is a registered trademark of E.I. du Pont de Nemours and Company.

▲HALAR is a registered trademark of Ausimont USA, Inc.

A.  
System  
Overview

B1.  
Cable Ties

B2.  
Cable  
Accessories

B3.  
Stainless  
Steel Ties

C1.  
Wiring  
Duct

C2.  
Surface  
Raceway

C3.  
Abrasion  
Protection

C4.  
Cable  
Management

D1.  
Terminals

D2.  
Power  
Connectors

D3.  
Grounding  
Connectors

E1.  
Labeling  
Systems

E2.  
Labels

E3.  
Pre-Printed  
& Write-On  
Markers

E4.  
Permanent  
Identification

E5.  
Lockout/  
Tagout  
& Safety  
Solutions

F.  
Index



A.  
System  
Overview

## Weathering (continued)

B1.  
Cable Ties

### Material Failure Testing

Property decay can lead to three different modes of failure: loss of strength, loss of toughness, or change in appearance. The critical mode for any given application would depend upon the application and the requirements it places upon the material itself.

B2.  
Cable  
Accessories

Loss of strength is monitored by tensile testing samples of the material before and after it has been weathered. This test will reveal the decreasing strength accompanied by extended weathering.

B3.  
Stainless  
Steel Ties

Loss of toughness can be monitored by measuring changes in elongation and impact strength. As ultraviolet light exposure time increases and the material becomes brittle, its elongation and impact strength are greatly reduced. It is important to note that brittle failures can occur even when the tensile strength shows no change.

C1.  
Wiring  
Duct

Although change in appearance is normally not a failure mode for cable ties, the plastic does tend to discolor and lose its surface gloss as exposure increases. These changes can be measured by color difference using Adams units, which are similar to National Bureau of Standard units.

C2.  
Surface  
Raceway

Panduit has its own weathering test program to determine estimated life of various cable tie materials. This includes examining many previously aged samples obtained throughout the world.

C3.  
Abrasion  
Protection

In all cases, the amount of property decay increased with increasing exposure to ultraviolet light. The principal signs of degradation were found to be brittleness, cracking, and loss of surface gloss. It was also determined that the time for failure to occur was shorter than indicated from industry tests performed on material samples. This discrepancy is in part due to the fact that cable ties were tested in an end use, stressed condition, while most plastic resin suppliers conduct weathering tests using unstressed test bars.

C4.  
Cable  
Management

Five cable tie materials have superior ultraviolet light resistance: TEFZEL<sup>■</sup>, HALAR<sup>▲</sup>, Weather Resistant Acetal, Nylon 12 and Stainless Steel.

D1.  
Terminals

Determining the outdoor life expectancy of any material is difficult since there are other factors, besides ultraviolet light stability, which have to be considered. These factors are listed below and should be considered before specifying a cable tie material.

D2.  
Power  
Connectors

**Table A – External Factors That Affect the Life of a Cable Tie**

| Factor             | Effect on Cable Tie Life   |
|--------------------|--|
| Chemicals          | Applications which have chemicals present can reduce the life of a tie. <b>This is the most detrimental factor to the life of a tie.</b> |
| Bundle diameter    | As the bundle diameter is reduced, the tie has more bending stress. A thick strap on a small bundle diameter has more stress.            |
| Loading            | If the tie is under high loading, this will add additional stress on the tie body.   |
| Thickness          | A thinner tie will have a decreased life since surface cracks will penetrate the thickness of the tie faster.                            |
| Vibration          | Applications with high vibrations will cause impact, which will propagate any surface cracks.  |
| Degree of exposure | No shield or shade, southern exposure, higher altitudes and high temperatures, decrease the life of a cable tie.                         |
| Moisture           | High humidity plus high temperature can result in degradation due to hydrolysis in nylon.  |
| Galvanized metals  | Acid rain and acid moisture acting on galvanized metals release chemicals known to attack Nylon 6.6.                                     |

| Weathering Life Expectancy                               |         |
|--|---------|
| Material, Color (Part Number Suffix)                     | Years*  |
| Polypropylene, Green (109)                               | 1       |
| Nylon 6.6, Natural (No suffix)                           | 1 – 2   |
| Flame Retardant Nylon 6.6, Black (60)                    | 1 – 2   |
| Flame Retardant Nylon 6.6, Ivory (69)                    | 1 – 2   |
| Heat Stabilized Nylon 6.6, Natural (39)                  | 1 – 2   |
| PEEK, Polyetheretherketone, Translucent Brown (71)       | 1 – 2   |
| Heat Stabilized Nylon 6.6, Black (30)                    | 4 – 5   |
| Weather Resistant Polypropylene, Black (100)             | 7 – 9   |
| Weather Resistant Nylon 6.6, Black (0 and 00)            | 7 – 9   |
| Heat Stabilized Weather Resistant Nylon 6.6, Black (300) | 7 – 9   |
| Weather Resistant Nylon 12, Black (120)                  | 12 – 15 |
| TEFZEL <sup>■</sup> , Aqua Blue (76)                     | >15     |
| HALAR <sup>▲</sup> , Maroon (702Y)                       | >15     |
| Weather Resistant Acetal, Black                          | >20     |
| Stainless Steel  | >30     |

\*Based on the assumption of minimum loading, no chemical attack and impact-free conditions.

■TEFZEL is a registered trademark of E.I. du Pont de Nemours and Company.

▲HALAR is a registered trademark of Ausimont USA, Inc.

## Flammability

### Flammability

A number of test procedures have been developed which can be used for the evaluation and comparison of various materials to support combustion.

### UL 94 Vertical Burning Test

Samples of a material, with dimensions 127mm by 12.7mm and the thickness of the intended end use product, are tested in an unaged “as manufactured” state and in an aged state (seven days at 158°F, 70°C). The test requires the placement of a precisely controlled flame under a vertically supported specimen for a ten second period. The controlled flame is removed and the duration of flaming combustion of the specimen is recorded. When the flaming combustion of the specimen extinguishes, it is immediately subjected to an additional controlled flame exposure. After the additional ten seconds of exposure, the controlled flame is removed, and the duration of flaming combustion of the specimen is recorded. A piece of surgical cotton is placed under the specimen. If drips ignite the cotton, this fact is also recorded.

### Materials Classed 94V-0

Requirements:

- None of the specimens will burn with flaming combustion for more than ten seconds after either application of the controlled flame
- The total flaming combustion time will not exceed 50 seconds for the ten controlled flame applications (two controlled flame applications for each of the five specimens)
- None of the specimens will burn with flaming or glowing combustion up to the holding clamp
- None of the specimens will drip flaming particles that ignite the dry absorbent surgical cotton located 12 inches (305mm) below the test specimen
- None of the specimens will exhibit glowing combustion that persists for more than 30 seconds after the second removal of the controlled flame

### Materials Classed 94V-1

Requirements:

- None of the specimens will burn with flaming combustion for more than 30 seconds after either application of the controlled flame
- The total flaming combustion time will not exceed 250 seconds for the ten controlled flame applications (two controlled flame applications for each of the five specimens)
- None of the specimens will burn with flaming or glowing combustion up to the holding clamp
- Specimens may drip flaming particles which burn only briefly, and may not ignite the dry absorbent surgical cotton located 12 inches (305mm) below the test specimen
- None of the specimens will exhibit glowing combustion that persists for more than 60 seconds after the second removal of the controlled flame

### Materials Classed 94V-2

Requirements:

- None of the specimens will burn with flaming combustion for more than 30 seconds after either application of the controlled flame
- The total flaming combustion time will not exceed 250 seconds for the ten controlled flame applications (two controlled flame applications for each of the five specimens)
- None of the specimens will burn with flaming or glowing combustion up to the holding clamp
- Specimens may drip flaming particles which burn only briefly, and may ignite the dry absorbent surgical cotton placed 12 inches (305mm) below the test specimen
- None of the specimens will exhibit glowing combustion that persists for more than 60 seconds after the second removal of the controlled flame

A.  
System  
Overview

B1.  
Cable Ties

B2.  
Cable  
Accessories

B3.  
Stainless  
Steel Ties

C1.  
Wiring  
Duct

C2.  
Surface  
Raceway

C3.  
Abrasion  
Protection

C4.  
Cable  
Management

D1.  
Terminals

D2.  
Power  
Connectors

D3.  
Grounding  
Connectors

E1.  
Labeling  
Systems

E2.  
Labels

E3.  
Pre-Printed  
& Write-On  
Markers

E4.  
Permanent  
Identification

E5.  
Lockout/  
Tagout  
& Safety  
Solutions

F.  
Index

A.  
System  
Overview

B1.  
Cable Ties

B2.  
Cable  
Accessories

B3.  
Stainless  
Steel Ties

C1.  
Wiring  
Duct

C2.  
Surface  
Raceway

C3.  
Abrasion  
Protection

C4.  
Cable  
Management

D1.  
Terminals

D2.  
Power  
Connectors

D3.  
Grounding  
Connectors

E1.  
Labeling  
Systems

E2.  
Labels

E3.  
Pre-Printed  
& Write-On  
Markers

E4.  
Permanent  
Identification

E5.  
Lockout/  
Tagout  
& Safety  
Solutions

F.  
Index

## Flammability (continued)

### ASTM D 635

Samples of a material, with dimensions 125mm by 12.5mm and the thickness of the intended end use product, are tested in an unaged “as manufactured” state. A precisely controlled flame is applied to the specimen and a stopwatch is started. The flame is applied for 30 seconds. The stopwatch is stopped when burning or glowing combustion ceases or when the flame has proceeded to a mark 100mm from the free end. Ten specimens are tested. If any of the specimens burn to the 100mm mark, an additional ten specimens are tested.

#### Burning Rate

- If two or more specimens have burned to the 100mm mark then Average Burning Rate (cm/min.) shall be reported as the average of the burning rates of all specimens which have burned to the 100mm mark

#### Average Time of Burning and Average Extent of Burning

- Average time of burning and average extent of burning of the sample shall be reported if none of the ten samples or no more than one of the twenty specimens have burned to the 100mm mark

- Average Time of Burning (ATB):

$$ATB, s = \frac{\sum_0^N [time(sec) - 30(sec)]}{N}$$

N = Number of specimens tested  
Rounded to the nearest 5 seconds

- Average Extent of Burning (AEB):

$$AEB, mm = \frac{\sum_0^N [10(mm) - unburned length(mm)]}{N}$$

N = Number of specimens tested  
Rounded to the nearest 5mm

**Table B – Flammability Ratings**

| Materials  | Part Number<br>Suffix | UL 94           | ASTM D 635                      |
|--|-----------------------|-----------------|---------------------------------|
| Nylon 6.6, Natural                                       | None                  | 94V-2 @ .71mm   | AEB = 20mm<br>ATB = 5 seconds   |
| Weather Resistant Nylon 6.6, Black<br>(Meets Mil. Spec.) | 00                    | 94V-2 @ .71mm   | AEB = 20mm<br>ATB = 5 seconds   |
| Weather Resistant Nylon 6.6, Black*                      | 0                     | 94V-2** @ .71mm | AEB = 20mm<br>ATB = 5 seconds   |
| Heat Stabilized Nylon 6.6, Black                         | 30                    | 94V-2 @ .71mm   | AEB = 20mm<br>ATB = 5 seconds   |
| Heat Stabilized Nylon 6.6, Natural                       | 39                    | 94V-2 @ .71mm   | AEB = 20mm<br>ATB = 5 seconds   |
| Heat Stabilized Weather Resistant<br>Nylon 6.6, Black    | 300                   | 94V-2 @ .71mm   | AEB = 20mm<br>ATB = 5 seconds   |
| Flame Retardant Nylon 6.6, Black                         | 60                    | 94V-0 @ .81mm   | AEB = 15mm<br>ATB = < 5 seconds |
| Flame Retardant Nylon 6.6,<br>Natural (Ivory)            | 69                    | 94V-0 @ .81mm   | AEB = 15mm<br>ATB = < 5 seconds |
| PEEK, Polyetheretherketone,<br>Translucent Brown         | 71                    | 94V-0 @ 1.5mm   | —                               |
| Metal Detectable Nylon 6.6, Blue                         | 86                    | 94 HB @ .71mm   | AEB = 20mm<br>ATB = 5 seconds   |
| Weather Resistant Nylon 12, Black                        | 120                   | 94 HB @ 1.6mm   | Avg. Burning Rate<br>1.6cm/min. |
| Polypropylene, Green                                     | 109                   | 94 HB @ .94mm   | Avg. Burning Rate<br>2cm/min.   |
| Weather Resistant Polypropylene, Black                   | 100                   | 94 HB @ .94mm   | Avg. Burning Rate<br>2cm/min.   |
| TEFZEL <sup>■</sup> , Aqua Blue                          | 76                    | 94V-0 @ 1.5mm   | AEB = 15mm<br>ATB = < 5 seconds |
| HALAR <sup>▲</sup> , Maroon                              | 702Y                  | 94V-0 @ .18mm   | AEB = 15mm<br>ATB = < 5 seconds |
| Weather Resistant Acetal, Black                          | DT Prefix             | 94 HB @ 1.5mm   | Avg. Burning Rate<br>2.8cm/min  |

\*UL Recognized cable ties meet stated ratings. \*\*UL Recognized -0 parts

■TEFZEL is a registered trademark of E.I. du Pont de Nemours and Company.

▲HALAR is a registered trademark of Ausimont USA, Inc.

## Radiation/Moisture/Temperature/Tensile Strength

### Radiation

Installed cable ties of various materials have been exposed to different amounts of radiation to determine the maximum acceptable limit. These tests were conducted by Panduit to determine the acceptability for use in various areas of nuclear power plants (for radiation exposure accumulated over a 40 year life). See Cable Tie Selection Chart (pages B1.2 and B1.3) for radiation resistance rating.

### Moisture

Many plastics when exposed to high relative humidity absorb water and, as such, the tensile strength of the material can change dramatically. Nylon 6.6 when exposed to 100% relative humidity, will absorb as much as 8.5% water which will reduce tensile strength by 50% when compared to a dry cable tie. Polypropylene, HALAR<sup>▲</sup>, Type 12 Nylon, TEFZEL<sup>■</sup>, Acetal and PEEK are low water absorbing materials and, as such, the effect of water is minimal. See Cable Tie Selection Chart (pages B1.2 and B1.3) for moisture absorption.

### Proper Storage

Nylon 6.6 is a hygroscopic material (affected by atmospheric moisture variations). The optimum storage requirement for Nylon 6.6 cable ties is 73°F (± 15°F) and 50% RH (relative humidity) in sealed containers. Improper storage, especially in cold/dry conditions can result in moisture loss, which impedes cable tie performance. Panduit packaging provides Nylon 6.6 cable ties conditioned to 2.5% moisture added by weight in heavy-wall, polyethylene heat-sealed bags.

### Temperature

Plastic materials normally undergo property loss due to oxidation caused by exposure to high temperatures. The maximum continuous use temperature for cable tie materials depends upon the time at the elevated temperature as well as other environmental conditions. Initially, plastics become more flexible and weaker when exposed to high temperatures. After a period of time, oxidation may occur which will cause embrittlement, making plastic cable ties more susceptible to failure from impact and vibration.

The maximum continuous use temperature, is based on the UL Relative Thermal Index (mechanical without impact) as determined by UL per UL 746B. It is one indicator of a material's ability to retain a particular physical property when exposed to elevated temperatures over an extended period of time. It is based on the assumption that there is no loading, no chemical attack, and impact-free condition. The maximum continuous use temperatures for cable tie materials are listed in the Cable Tie Selection Chart (pages B1.2 and B1.3).

Low temperature exposure will also make most plastics more brittle during the exposure, but little property loss occurs when the material is returned to room temperatures. The minimum application use temperatures for cable tie materials are listed in the Cable Tie Selection Chart (pages B1.2 and B1.3).

### Tensile Strength

Most cable ties are selected based on material, length, and minimum loop tensile strength. Minimum loop tensile strength was established under SAE Aerospace Standard AS23190. Each cable tie cross section (SM = Subminiature, M = Miniature, I = Intermediate, S = Standard, HS = Heavy-Standard, LH = Light-Heavy, H = Heavy and EH = Extra-Heavy) has a different loop tensile strength when tested per AS23190.

The cable tie is first conditioned at 49°C (120°F), 20% relative humidity for 24 hours, then the cable tie is installed on a split mandrel and the halves of the mandrel separated at a rate of 1 inch (25.4mm) per minute. The separating force required to unlock or break the cable tie is the loop tensile strength. Loop tensile strength is dependent both on the locking design and the tensile strength (psi) of the material. As an example, the tensile strength of polypropylene material is approximately 1/2 to 1/3 of Nylon 6.6; thus the loop tensile strength of a given cross section tie made of polypropylene would be much less than a tie made of Nylon 6.6. This is another property to be considered when selecting a cable tie. The various representative loop tensile strengths are listed in the Cable Tie Selection Chart (pages B1.2 and B1.3).

### Halogen-Free

All Panduit cable ties (with the exception of TEFZEL<sup>■</sup> and HALAR<sup>▲</sup>) are halogen-free per IEC Specification 61249-2-21.

<sup>▲</sup>HALAR is a registered trademark of Ausimont USA, Inc.

<sup>■</sup>TEFZEL is a registered trademark of E.I. du Pont de Nemours and Company.

A.  
System  
Overview

B1.  
Cable Ties

B2.  
Cable  
Accessories

B3.  
Stainless  
Steel Ties

C1.  
Wiring  
Duct

C2.  
Surface  
Raceway

C3.  
Abrasion  
Protection

C4.  
Cable  
Management

D1.  
Terminals

D2.  
Power  
Connectors

D3.  
Grounding  
Connectors

E1.  
Labeling  
Systems

E2.  
Labels

E3.  
Pre-Printed  
& Write-On  
Markers

E4.  
Permanent  
Identification

E5.  
Lockout/  
Tagout  
& Safety  
Solutions

F.  
Index

A.  
System  
Overview

B1.  
Cable Ties

B2.  
Cable  
Accessories

B3.  
Stainless  
Steel Ties

## Table C – Chemical Resistance Table

Many factors combine to determine the useful life of a cable tie material and none is as important as chemical exposure. Various chemicals will have different effects on plastics depending on such variables as chemical concentrations, temperature, stress and ultraviolet light. This table is an excellent guideline for the selection of the best cable tie material for various cable tie environments. It should be noted that the exposure for this chemical resistance chart is at 70°F (21°C).

### Resistance of Panduit cable tie materials to chemical attack at 70°F (21°C)

A = Excellent

B = Satisfactory

C = Slight Attack

D = Attacked

— = Not Tested

<sup>1</sup> = Pitting occurs under some conditions

<sup>2</sup> = Attack may occur if sulfuric acid present

Aq. = Aqueous

C.S. = Cold Saturated

C1.  
Wiring  
Duct

C2.  
Surface  
Raceway

C3.  
Abrasion  
Protection

C4.  
Cable  
Management

D1.  
Terminals

D2.  
Power  
Connectors

D3.  
Grounding  
Connectors

E1.  
Labeling  
Systems

E2.  
Labels

E3.  
Pre-Printed  
& Write-On  
Markers

E4.  
Permanent  
Identification

E5.  
Lockout/  
Tagout  
& Safety  
Solutions

F.  
Index

| Agent                      | Percent Concentration | Nylon 6.6* | Nylon 12 | Polypropylene | TEFZEL <sup>‡</sup> | HALAR <sup>‡</sup> | PEEK | 304 Stainless Steel | 316 Stainless Steel |
|----------------------------|-----------------------|------------|----------|---------------|---------------------|--------------------|------|---------------------|---------------------|
| Acetaldehyde               | 90                    | B          | —        | C             | A                   | A                  | A    | —                   | —                   |
| Acetic Acid                | 97                    | D          | D        | A             | A                   | A                  | A    | A                   | A                   |
| Acetic Acid                | 10                    | C          | B        | A             | A                   | A                  | —    | A                   | A                   |
| Acetic Anhydride           | 90                    | —          | B        | A             | A                   | A                  | —    | A                   | A                   |
| Acetone                    | 100                   | A          | A        | A             | A                   | A                  | A    | A                   | A                   |
| Acetophenone               | 100                   | —          | —        | B             | A                   | A                  | —    | A                   | A                   |
| Acetylene                  | 100                   | —          | —        | A             | A                   | A                  | A    | A                   | A                   |
| Aluminum Chloride          | 10                    | B          | A        | A             | A                   | A                  | A    | D                   | C                   |
| Aluminum Fluoride          | 10                    | B          | A        | A             | A                   | A                  | —    | D                   | C                   |
| Aluminum Hydroxide         | Aq. C.S.              | —          | A        | A             | A                   | A                  | —    | A                   | A                   |
| Aluminum Potassium Sulfate | 10                    | B          | A        | A             | A                   | A                  | —    | A <sup>1</sup>      | A <sup>1</sup>      |
| Ammonia                    | All                   | —          | A        | A             | A                   | A                  | A    | A                   | A                   |
| Ammonium Carbonate         | 1 to 5                | —          | A        | —             | A                   | A                  | —    | A                   | A                   |
| Ammonium Chloride          | 10 to 25              | D          | A        | A             | A                   | A                  | A    | A <sup>1</sup>      | A                   |
| Ammonium Hydroxide         | 10                    | A          | —        | —             | A                   | A                  | A    | —                   | —                   |
| Ammonium Nitrate           | 100                   | —          | A        | A             | A                   | A                  | A    | A                   | A <sup>1</sup>      |
| Ammonium Sulfate           | 10                    | —          | A        | A             | A                   | A                  | A    | E <sup>1</sup>      | A                   |
| Amyl Acetate               | 100                   | —          | —        | C             | A                   | A                  | A    | A                   | A                   |
| Aniline                    | 100                   | —          | B        | A             | A                   | A                  | A    | A                   | A                   |
| Antimony Trichloride       | All                   | D          | —        | A             | A                   | A                  | A    | A                   | A                   |
| Arsenic Acid               | 1 to 80               | —          | —        | A             | A                   | A                  | —    | A                   | A                   |
| Barium Carbonate           | All                   | —          | A        | A             | A                   | A                  | —    | A                   | A                   |
| Barium Chloride            | All                   | —          | A        | A             | A                   | A                  | —    | A <sup>1</sup>      | A                   |
| Barium Sulfate             | All                   | —          | A        | A             | A                   | A                  | —    | A                   | A                   |
| Barium Sulfide             | All                   | —          | A        | A             | A                   | A                  | —    | A                   | A                   |
| Benzene                    | 100                   | A          | A        | C             | A                   | A                  | A    | A                   | A                   |
| Benzoic Acid               | 100                   | D          | A        | A             | A                   | A                  | A    | A                   | A                   |
| Benzoyl Chloride           | 100                   | —          | —        | C             | A                   | A                  | —    | —                   | —                   |
| Benzyl Alcohol             | 100                   | —          | —        | A             | A                   | A                  | A    | —                   | —                   |
| Boric Acid                 | All                   | D          | A        | A             | A                   | A                  | A    | B                   | —                   |
| Bromine                    | 100                   | D          | D        | D             | A                   | A                  | D    | D                   | D                   |
| Butadiene                  | 100                   | —          | —        | C             | A                   | A                  | —    | A                   | A                   |
| Butane                     | 100                   | —          | A        | A             | A                   | A                  | A    | A                   | A                   |
| Butanediol                 | 100                   | —          | —        | A             | A                   | A                  | —    | —                   | —                   |
| Butyl Acetate              | 100                   | —          | A        | C             | A                   | A                  | A    | —                   | —                   |
| N. Butyl Alcohol           | 100                   | —          | A        | A             | A                   | A                  | A    | A                   | A                   |
| Butyl Phthalate            | 100                   | —          | —        | A             | A                   | A                  | —    | —                   | —                   |
| Butyraldehyde              | 100                   | —          | —        | A             | A                   | A                  | —    | —                   | —                   |
| Butyric Acid               | 10 to 100             | D          | —        | A             | A                   | A                  | —    | A                   | A                   |
| Calcium Carbonate          | Aq. C.S.              | —          | —        | A             | A                   | A                  | A    | A                   | A                   |
| Calcium Chlorate           | Aq. C.S.              | —          | —        | A             | A                   | A                  | —    | A                   | A                   |

\*Includes all 6.6 Nylons (weather resistant, heat stabilized, and flame retardant).

<sup>‡</sup>TEFZEL is a registered trademark of E.I. du Pont de Nemours and Company.

<sup>‡</sup>HALAR is a registered trademark of Ausimont USA, Inc.



| Agent                | Percent Concentration | Nylon 6.6* | Nylon 12 | Polypropylene | TEFZEL® | HALAR® | PEEK | 304 Stainless Steel | 316 Stainless Steel            |
|----------------------|-----------------------|------------|----------|---------------|---------|--------|------|---------------------|--------------------------------|
| Calcium Chloride     | 5                     | C          | A        | A             | A       | A      | A    | A <sup>1</sup>      | A <sup>1</sup>                 |
| Calcium Hydroxide    | 50                    | —          | —        | A             | A       | A      | A    | A                   | A                              |
| Calcium Hypochlorite | 2                     | D          | —        | A             | A       | A      | A    | A <sup>1</sup>      | A <sup>1</sup>                 |
| Calcium Nitrate      | 50                    | —          | A        | A             | A       | A      | A    | —                   | —                              |
| Calcium Sulfate      | 2                     | C          | —        | A             | A       | A      | A    | A                   | A                              |
| Carbon Tetrachloride | 100                   | A          | A        | D             | A       | A      | A    | A                   | A                              |
| Carbon Tetrachloride | Aq. 10                | —          | —        | —             | —       | A      | —    | C <sup>1</sup>      | A <sup>1</sup>                 |
| Chlorine             | Dry                   | —          | D        | D             | A       | A      | D    | C                   | C                              |
| Chlorine             | Wet                   | —          | D        | C             | A       | A      | D    | D                   | D                              |
| Chloroacetic Acid    | 10 to 50              | D          | —        | A             | A       | A      | A    | D                   | C                              |
| Chlorobenzene        | 100                   | —          | C        | A             | A       | A      | A    | —                   | —                              |
| Chloroform           | 100                   | A          | C        | C             | A       | A      | A    | A                   | A                              |
| Chlorosulphonic Acid | 10 to 100             | D          | D        | D             | B       | A      | D    | D                   | D                              |
| Chromic Acid         | 10 to 50              | D          | D        | A             | A       | A      | A    | C                   | C                              |
| Citric Acid          | 10 to 50              | B          | B        | A             | —       | A      | A    | A                   | A                              |
| Copper Chloride      | 1 to 10               | D          | —        | A             | A       | A      | A    | A <sup>1</sup> -D   | A <sup>1</sup> -C <sup>1</sup> |
| Copper Cyanide       | Aq. C.S.              | —          | —        | A             | A       | A      | A    | A                   | A                              |
| Copper Nitrate       | 50                    | —          | —        | A             | A       | A      | A    | A                   | A                              |
| Cresol               | 100                   | D          | D        | —             | A       | A      | —    | A                   | A                              |
| Crotonaldehyde       | 100                   | —          | —        | A             | A       | A      | —    | —                   | —                              |
| Cyclohexane          | 100                   | —          | A        | C             | A       | A      | A    | A                   | —                              |
| Cyclohexanol         | 100                   | —          | A        | A             | A       | A      | A    | A                   | —                              |
| Cyclohexanone        | 100                   | —          | A        | C             | A       | A      | A    | A                   | —                              |
| Dibutyl Phthalate    | 100                   | —          | —        | A             | A       | A      | A    | —                   | —                              |
| Dichloroethane       | 100                   | —          | —        | A             | —       | A      | A    | A                   | A                              |
| Dichloroethylene     | 100                   | —          | —        | C             | A       | A      | —    | —                   | —                              |
| Diesel Fuel          | 100                   | —          | A        | C             | A       | A      | A    | A                   | A                              |
| Diethyl Ether        | 100                   | —          | A        | A             | A       | A      | A    | A                   | A                              |
| Diglycolic Acid      | Aq. C.S.              | —          | —        | A             | A       | A      | —    | —                   | —                              |
| Diisobutyl Ketone    | 100                   | —          | —        | A             | A       | A      | —    | —                   | —                              |
| Dimethyl Amine       | 100                   | —          | —        | A             | A       | A      | —    | —                   | —                              |
| Dimethyl Formamide   | 100                   | —          | A        | A             | A       | A      | A    | A                   | —                              |
| Dimethyl Sulfate     | 100                   | —          | —        | C             | A       | A      | —    | —                   | —                              |
| Diocetyl Phthalate   | 100                   | —          | —        | A             | A       | A      | A    | A                   | —                              |
| 1,4-Dioxane          | 100                   | —          | B        | C             | A       | A      | A    | A                   | —                              |
| Ethyl Acetate        | 100                   | A          | A        | B             | A       | A      | A    | A                   | A                              |
| Ethyl Alcohol        | 100                   | A          | A        | A             | A       | A      | A    | A                   | A                              |
| Ethyl Chloride       | 100                   | —          | —        | C             | A       | A      | —    | A                   | A                              |
| Ethylene Chloride    | 100                   | A          | C        | C             | A       | A      | —    | A                   | A                              |
| Ethylene Glycol      | 100                   | A          | A        | A             | A       | A      | A    | A                   | A                              |
| Ethylene Oxide       | 100                   | —          | —        | C             | A       | A      | A    | —                   | —                              |
| Fatty Acids          | 100                   | —          | —        | A             | A       | A      | —    | —                   | —                              |
| Ferric Chloride      | 50                    | D          | —        | A             | A       | A      | C    | D                   | D                              |
| Ferric Hydroxide     | All                   | —          | —        | A             | A       | A      | —    | A                   | A                              |
| Ferric Nitrate       | All                   | —          | —        | A             | A       | A      | A    | A                   | A                              |
| Ferrous Chloride     | Aq. C.S.              | D          | —        | A             | A       | A      | A    | D                   | C                              |
| Ferrous Sulfate      | 10                    | —          | —        | A             | A       | A      | A    | A <sup>1</sup>      | A                              |
| Fluorine (Dry)       | 100                   | —          | —        | D             | A       | —      | D    | D                   | D                              |
| Formaldehyde         | 40                    | A          | B        | A             | A       | A      | A    | A <sup>1</sup>      | A                              |
| Formic Acid          | All                   | D          | D        | A             | A       | A      | C    | A                   | A                              |
| Freons               | 100                   | A          | —        | —             | A       | A      | A    | —                   | —                              |
| Fuel Oil             | 100                   | —          | A        | —             | A       | A      | A    | A                   | A                              |
| Furfural             | 100                   | A          | —        | —             | A       | A      | —    | A                   | A                              |
| Gallic Acid          | Aq. C.S.              | —          | —        | —             | A       | A      | —    | A                   | A                              |
| Gasoline             | 100                   | A          | —        | C             | A       | A      | A    | A                   | A                              |
| Glycerin             | 100                   | —          | A        | A             | —       | A      | —    | A                   | A                              |
| Glycolic Acid        | 40                    | D          | —        | A             | A       | A      | —    | —                   | —                              |
| Heptane              | 100                   | —          | A        | A             | A       | A      | A    | A                   | A                              |
| Hexane               | 100                   | —          | A        | A             | A       | A      | A    | A                   | A                              |
| Hydrobromic Acid     | All                   | D          | D        | A             | A       | A      | D    | D                   | D                              |

\*Includes all 6.6 Nylons (weather resistant, heat stabilized, and flame retardant).

®TEFZEL is a registered trademark of E.I. du Pont de Nemours and Company.

®HALAR is a registered trademark of Ausimont USA, Inc.

Table continues on page B1.106

### Table C – Chemical Resistance Table (continued)

| Agent                          | Percent Concentration | Nylon 6.6* | Nylon 12 | Polypropylene | TEFZEL <sup>■</sup> | HALAR <sup>▲</sup> | PEEK | 304 Stainless Steel | 316 Stainless Steel |
|--------------------------------|-----------------------|------------|----------|---------------|---------------------|--------------------|------|---------------------|---------------------|
| <b>Hydrochloric Acid</b>       | All                   | D          | D        | A             | A                   | A                  | A    | D                   | D                   |
| <b>Hydrocyanic Acid</b>        | All                   | —          | D        | A             | A                   | A                  | A    | C                   | C                   |
| <b>Hydrofluoric Acid</b>       | All                   | D          | D        | A             | A                   | A                  | D    | D                   | D                   |
| <b>Hydrofluorosilicic Acid</b> | 30                    | —          | D        | A             | A                   | A                  | —    | D                   | D                   |
| <b>Hydrogen Peroxide</b>       | 30                    | D          | B        | B             | A                   | A                  | A    | B                   | A                   |
| <b>Hydrogen Sulfide</b>        | Dry                   | —          | —        | A             | A                   | A                  | A    | A                   | A                   |
| <b>Hydrogen Sulfide</b>        | Wet                   | D          | —        | A             | A                   | A                  | —    | C <sup>2</sup>      | A <sup>2</sup>      |
| <b>Hydroquinone</b>            | 100                   | —          | —        | A             | A                   | A                  | —    | —                   | —                   |
| <b>Iodine</b>                  | 100                   | —          | —        | A             | A                   | A                  | C    | D                   | D                   |
| <b>Iodoform</b>                | 100                   | —          | —        | —             | A                   | A                  | —    | A                   | A                   |
| <b>Isopropyl Alcohol</b>       | 100                   | A          | A        | A             | A                   | A                  | A    | A                   | A                   |
| <b>Jet Fuel</b>                | 100                   | A          | —        | A             | A                   | A                  | A    | A                   | A                   |
| <b>Lactic Acid</b>             | 10                    | A          | B        | A             | A                   | A                  | —    | A                   | A                   |
| <b>Lanolin</b>                 | 10                    | A          | A        | A             | A                   | A                  | —    | A                   | A                   |
| <b>Lead Acetate</b>            | Aq. C.S.              | —          | —        | A             | A                   | A                  | A    | A                   | A                   |
| <b>Linseed Oil</b>             | 100                   | A          | A        | A             | A                   | A                  | —    | A                   | A                   |
| <b>Magnesium Carbonate</b>     | Aq. C. S.             | —          | A        | A             | A                   | A                  | —    | A                   | A                   |
| <b>Magnesium Chloride</b>      | Aq. C.S.              | C          | A        | A             | A                   | A                  | A    | A <sup>1</sup>      | A <sup>1</sup>      |
| <b>Magnesium Nitrate</b>       | Aq. C. S.             | —          | A        | A             | A                   | A                  | —    | A                   | A                   |
| <b>Maleic Acid</b>             | 100                   | —          | —        | A             | A                   | A                  | A    | —                   | —                   |
| <b>Malic Acid</b>              | Aq. C.S.              | —          | —        | A             | A                   | A                  | —    | A                   | A                   |
| <b>Mercuric Chloride</b>       | Dilute                | —          | A        | A             | A                   | A                  | A    | D                   | D                   |
| <b>Mercury</b>                 | 100                   | —          | A        | A             | A                   | A                  | A    | A                   | A                   |
| <b>Methyl Alcohol</b>          | 100                   | A          | A        | A             | A                   | A                  | A    | A                   | A                   |
| <b>Methyl Bromide</b>          | 100                   | —          | —        | D             | A                   | A                  | —    | —                   | —                   |
| <b>Methyl Chloride</b>         | 100                   | —          | —        | C             | A                   | A                  | —    | —                   | A                   |
| <b>Methyl Chloroform</b>       | 100                   | A          | —        | C             | A                   | A                  | —    | —                   | —                   |
| <b>Methyl Ethyl Ketone</b>     | 100                   | —          | A        | C             | A                   | A                  | A    | A                   | A                   |
| <b>Methyl Isobutyl Ketone</b>  | 100                   | A          | —        | C             | A                   | A                  | —    | A                   | A                   |
| <b>Methylene Chloride</b>      | 100                   | C          | D        | C             | A                   | A                  | A    | A                   | A                   |
| <b>Naphtha</b>                 | 100                   | —          | —        | A             | A                   | A                  | A    | A                   | A                   |
| <b>Naphthalene</b>             | 100                   | —          | B        | A             | A                   | A                  | A    | A                   | A                   |
| <b>Nickel Chloride</b>         | Aq. C.S.              | —          | A        | A             | A                   | A                  | A    | A <sup>1</sup>      | A <sup>1</sup>      |
| <b>Nickel Sulfate</b>          | Aq. C.S.              | —          | A        | A             | A                   | A                  | A    | A <sup>1</sup>      | A <sup>1</sup>      |
| <b>Nitric Acid</b>             | 10 to 30              | D          | D        | A             | A                   | A                  | —    | A                   | A                   |
| <b>Nitric Acid</b>             | 30 to 68              | D          | D        | D             | B                   | A                  | C    | A                   | A                   |
| <b>Nitro Benzene</b>           | 100                   | —          | C        | C             | A                   | A                  | A    | A                   | A                   |
| <b>Nitro Methane</b>           | 100                   | A          | —        | —             | A                   | A                  | —    | —                   | —                   |
| <b>Nitrous Acid</b>            | 5                     | —          | —        | —             | A                   | A                  | A    | A                   | A                   |
| <b>Oleic Acid</b>              | 100                   | —          | C        | A             | A                   | A                  | A    | A                   | A                   |
| <b>Oxalic Acid</b>             | 10                    | —          | C        | A             | A                   | A                  | A    | A                   | A                   |
| <b>Oxygen</b>                  | All                   | —          | —        | A             | A                   | A                  | A    | —                   | —                   |
| <b>Paraffin</b>                | 100                   | A          | A        | A             | A                   | A                  | —    | A                   | A                   |
| <b>Perchloroethylene</b>       | 100                   | —          | —        | C             | A                   | A                  | A    | A                   | A                   |
| <b>Petroleum Ether</b>         | 100                   | —          | A        | A             | A                   | A                  | A    | A                   | A                   |
| <b>Phenol</b>                  | 90                    | D          | D        | A             | A                   | A                  | D    | A                   | A                   |
| <b>Phosphoric Acid</b>         | 10                    | D          | D        | A             | A                   | A                  | A    | A                   | A                   |
| <b>Phosphorous Pentoxide</b>   | 100                   | —          | D        | A             | A                   | A                  | A    | —                   | —                   |
| <b>Phosphorous Trichloride</b> | 100                   | —          | D        | C             | A                   | A                  | —    | A                   | A                   |
| <b>Phthalic Acid</b>           | 50                    | —          | —        | C             | A                   | A                  | —    | A                   | A                   |
| <b>Picric Acid</b>             | 1                     | —          | —        | A             | A                   | A                  | A    | A                   | A                   |
| <b>Potassium Borate</b>        | 1                     | —          | —        | A             | A                   | A                  | —    | —                   | —                   |
| <b>Potassium Bromide</b>       | Aq. C.S.              | —          | —        | A             | A                   | A                  | A    | A <sup>1</sup>      | A <sup>1</sup>      |
| <b>Potassium Carbonate</b>     | Aq. C.S.              | —          | C        | A             | A                   | A                  | A    | A                   | A                   |
| <b>Potassium Chlorate</b>      | Aq. C. S.             | —          | B        | A             | A                   | A                  | A    | A                   | A                   |
| <b>Potassium Chloride</b>      | 5                     | —          | A        | A             | A                   | A                  | A    | A <sup>1</sup>      | A <sup>1</sup>      |
| <b>Potassium Dichromate</b>    | Aq. C.S.              | —          | D        | A             | A                   | A                  | A    | A                   | A                   |
| <b>Potassium Ferrocyanide</b>  | 25                    | —          | —        | A             | A                   | A                  | A    | A                   | A                   |
| <b>Potassium Hydroxide</b>     | 30                    | C          | —        | A             | A                   | A                  | A    | C                   | C                   |

\*Includes all 6.6 Nylons (weather resistant, heat stabilized, and flame retardant).

■TEFZEL is a registered trademark of E.I. du Pont de Nemours and Company.

▲HALAR is a registered trademark of Ausimont USA, Inc.

| Agent                  | Percent Concentration | Nylon 6.6* | Nylon 12 | Polypropylene | TEFZEL <sup>®</sup> | HALAR <sup>▲</sup> | PEEK | 304 Stainless Steel | 316 Stainless Steel |
|------------------------|-----------------------|------------|----------|---------------|---------------------|--------------------|------|---------------------|---------------------|
| Potassium Iodide       | Aq. C.S.              | —          | A        | A             | —                   | A                  | —    | A                   | A                   |
| Potassium Nitrate      | Aq. C.S.              | —          | A        | A             | A                   | A                  | A    | A                   | A                   |
| Potassium Perchlorate  | 1                     | —          | —        | A             | A                   | A                  | —    | —                   | —                   |
| Potassium Permanganate | 5                     | D          | D        | A             | A                   | A                  | A    | A                   | A                   |
| Potassium Persulfate   | All                   | —          | —        | A             | A                   | A                  | —    | —                   | —                   |
| Potassium Sulfate      | Aq. C.S.              | —          | A        | A             | A                   | A                  | A    | A                   | A                   |
| Potassium Sulfide      | Aq. C.S.              | —          | —        | A             | A                   | A                  | A    | A                   | A                   |
| Propionic Acid         | 50                    | —          | —        | A             | A                   | A                  | —    | —                   | —                   |
| Propyl Alcohol         | 100                   | A          | —        | A             | A                   | A                  | A    | A                   | A                   |
| Pyridine               | 100                   | —          | A        | C             | A                   | A                  | A    | C                   | C                   |
| Sea Water              | 100                   | —          | A        | A             | A                   | A                  | —    | A <sup>1</sup>      | A <sup>1</sup>      |
| Silver Chloride        | Aq. C.S.              | —          | A        | A             | A                   | A                  | —    | D                   | D                   |
| Silver Nitrate         | 10                    | —          | A        | A             | A                   | A                  | A    | A                   | A                   |
| Sodium Acetate         | Aq. C.S.              | A          | —        | A             | A                   | A                  | A    | A <sup>1</sup>      | A                   |
| Sodium Benzoate        | Aq. C.S.              | —          | —        | A             | A                   | A                  | —    | —                   | —                   |
| Sodium Bicarbonate     | Aq. C.S.              | A          | A        | A             | A                   | A                  | A    | A                   | A                   |
| Sodium Bisulfate       | 10                    | —          | —        | A             | A                   | A                  | —    | A                   | A                   |
| Sodium Bisulfite       | Aq. C.S.              | —          | B        | A             | A                   | A                  | —    | A                   | A                   |
| Sodium Borate          | Aq. C.S.              | —          | —        | A             | A                   | A                  | —    | A                   | A                   |
| Sodium Carbonate       | 2                     | A          | A        | A             | A                   | A                  | A    | A                   | A                   |
| Sodium Chlorate        | 25                    | —          | C        | A             | A                   | A                  | A    | A                   | A                   |
| Sodium Chloride        | 10                    | A          | A        | A             | A                   | A                  | A    | A <sup>1</sup>      | A <sup>1</sup>      |
| Sodium Chromate        | Aq. C.S.              | D          | —        | A             | A                   | A                  | —    | A                   | A                   |
| Sodium Fluoride        | 5                     | —          | —        | A             | A                   | A                  | —    | A <sup>1</sup>      | A <sup>1</sup>      |
| Sodium Hydroxide       | 10                    | A          | A        | A             | A                   | A                  | A    | A                   | A                   |
| Sodium Hypochlorite    | 5                     | B          | C        | A             | A                   | A                  | A    | C <sup>1</sup>      | A <sup>1</sup>      |
| Sodium Hyposulfite     | Aq.C.S.               | —          | —        | —             | A                   | A                  | —    | A                   | A                   |
| Sodium Nitrate         | 5                     | A          | A        | A             | A                   | A                  | A    | A                   | A                   |
| Sodium Perborate       | Aq. C.S.              | —          | B        | A             | A                   | A                  | —    | —                   | C                   |
| Sodium Perchlorate     | 10                    | —          | —        | —             | A                   | A                  | —    | A                   | A                   |
| Sodium Phosphate       | 5                     | —          | A        | A             | A                   | A                  | —    | A                   | A                   |
| Sodium Sulfate         | 5                     | —          | A        | A             | A                   | A                  | A    | A                   | A                   |
| Sodium Sulfide         | 5                     | —          | A        | A             | A                   | A                  | A    | A <sup>1</sup>      | A                   |
| Sodium Thiosulfate     | 25                    | —          | A        | A             | A                   | A                  | —    | A <sup>2</sup>      | A <sup>2</sup>      |
| Stannic Chloride       | Aq. C.S.              | D          | —        | A             | A                   | A                  | A    | D                   | C                   |
| Stannous Chloride      | Aq. C.S.              | —          | A        | A             | A                   | A                  | A    | C                   | B                   |
| Stearic Acid           | 100                   | —          | C        | A             | A                   | A                  | —    | A                   | A                   |
| Succinic Acid          | 100                   | —          | B        | A             | A                   | A                  | —    | —                   | —                   |
| Sulfur                 | 100                   | —          | A        | A             | A                   | A                  | A    | B                   | C                   |
| Sulfur Dioxide         | All                   | D          | —        | C             | A                   | A                  | A    | A                   | A                   |
| Sulfuric Acid          | 5                     | D          | C        | A             | A                   | A                  | C    | C                   | A                   |
| Sulfuric Acid          | 50                    | D          | D        | A             | A                   | A                  | D    | D                   | C                   |
| Sulfuric Acid          | Concentrate           | D          | D        | C             | A                   | A                  | D    | C                   | C                   |
| Sulfurous Acid         | 10                    | A          | —        | A             | A                   | A                  | A    | C <sup>1</sup>      | A <sup>1</sup>      |
| Tannic Acid            | 10                    | —          | A        | A             | A                   | A                  | A    | A                   | A                   |
| Tartaric Acid          | 50                    | —          | B        | A             | A                   | A                  | A    | A                   | A                   |
| Tetrahydrofuran        | 100                   | —          | C        | C             | A                   | A                  | A    | A                   | A                   |
| Toluene                | 100                   | A          | A        | C             | A                   | A                  | A    | A                   | A                   |
| Trichloroacetic Acid   | 10                    | D          | —        | B             | A                   | A                  | —    | D                   | D                   |
| Trichloroethylene      | 100                   | —          | D        | C             | A                   | A                  | A    | A <sup>1</sup>      | A <sup>1</sup>      |
| Turpentine             | 100                   | —          | B        | D             | A                   | A                  | A    | A                   | A                   |
| Urea                   | 50                    | —          | A        | A             | A                   | A                  | —    | —                   | —                   |
| Vinyl Acetate          | 100                   | —          | —        | A             | A                   | A                  | —    | —                   | —                   |
| Xylene                 | 100                   | A          | —        | D             | A                   | A                  | A    | A                   | A                   |
| Zinc Chloride          | 70                    | D          | A        | A             | A                   | A                  | A    | A                   | A                   |
| Zinc Nitrate           | Aq. C.S.              | —          | A        | A             | A                   | A                  | —    | A                   | A                   |
| Zinc Sulfate           | Aq. C.S.              | —          | A        | A             | A                   | A                  | A    | A                   | A                   |

\*Includes all 6.6 Nylons (weather resistant, heat stabilized, and flame retardant).

®TEFZEL is a registered trademark of E.I. du Pont de Nemours and Company.

▲HALAR is a registered trademark of Ausimont USA, Inc.

A.  
System  
Overview

B1.  
Cable Ties

B2.  
Cable  
Accessories

B3.  
Stainless  
Steel Ties

C1.  
Wiring  
Duct

C2.  
Surface  
Raceway

C3.  
Abrasion  
Protection

C4.  
Cable  
Management

D1.  
Terminals

D2.  
Power  
Connectors

D3.  
Grounding  
Connectors

E1.  
Labeling  
Systems

E2.  
Labels

E3.  
Pre-Printed  
& Write-On  
Markers

E4.  
Permanent  
Identification

E5.  
Lockout/  
Tagout  
& Safety  
Solutions

F.  
Index

A.  
System  
Overview

B1.  
Cable Ties

B2.  
Cable  
Accessories

B3.  
Stainless  
Steel Ties

C1.  
Wiring  
Duct

C2.  
Surface  
Raceway

C3.  
Abrasion  
Protection

C4.  
Cable  
Management

D1.  
Terminals

D2.  
Power  
Connectors

D3.  
Grounding  
Connectors

E1.  
Labeling  
Systems

E2.  
Labels

E3.  
Pre-Printed  
& Write-On  
Markers

E4.  
Permanent  
Identification

E5.  
Lockout/  
Tagout  
& Safety  
Solutions

F.  
Index

## NOTES

## MANUAL CABLE TIE INSTALLATION TOOLS

Panduit provides the most preferred hand-operated tools in the industry. These versatile tools can be used for production, maintenance, or construction applications.

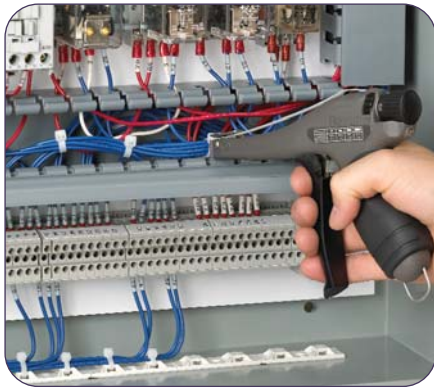

### Tool Highlights:

- Tool controlled tension and cut-off
  - Ergonomic tools are durable, lightweight, and easy to use
  - Manual tools
  - Pneumatic tools
- Installer controlled tension and cut-off
  - Large selection of tools available for complete range of Panduit cable ties
  - Cost-effective alternative for small volume applications



Panduit cable tie installation tools promote worker safety, help reduce downtime, improve productivity and provide the lowest total installed cost. As with all Panduit products, quality in design and production along with customer service excellence, are assured.

A.  
System  
Overview

B1.  
Cable Ties

B2.  
Cable  
Accessories

B3.  
Stainless  
Steel Ties

C1.  
Wiring  
Duct

C2.  
Surface  
Raceway

C3.  
Abrasion  
Protection

C4.  
Cable  
Management

D1.  
Terminals

D2.  
Power  
Connectors

D3.  
Grounding  
Connectors

E1.  
Labeling  
Systems

E2.  
Labels

E3.  
Pre-Printed  
& Write-On  
Markers

E4.  
Permanent  
Identification

E5.  
Lockout/  
Tagout  
& Safety  
Solutions

F.  
Index



## Selection Guide – Hand Tools, Accessories, and Kits

A. System Overview

B1. Cable Ties

B2. Cable Accessories

B3. Stainless Steel Ties

C1. Wiring Duct

C2. Surface Raceway

C3. Abrasion Protection

C4. Cable Management

D1. Terminals

D2. Power Connectors

D3. Grounding Connectors

E1. Labeling Systems

E2. Labels

E3. Pre-Printed & Write-On Markers

E4. Permanent Identification

E5. Lockout/Tagout & Safety Solutions

F. Index

### Hand Tools

#### Manual

##### Tool Controlled Tension and Cut-Off

Recommended usage: under 50,000 ties/year

Typical applications: Low to medium volume tie usage in OEM, MRO, or construction

| Cross Section | Tool Part Number – Page B1.111 |      |      |     |      |       |
|---------------|--------------------------------|------|------|-----|------|-------|
|               | GTS                            | GTSL | GS2B | GTH | GS4H | GS4EH |
| SM            | X                              | X    |      |     |      |       |
| M             | X                              | X    | X    |     |      |       |
| I             | X                              | X    | X    |     |      |       |
| S             | X                              | X    | X    | X   | X    |       |
| HS            |                                |      |      | X   | X    |       |
| LH            |                                |      |      | X   | X    | X     |
| H             |                                |      |      | X   | X    | X     |
| EH            |                                |      |      |     |      | X     |

| Cross Sections |                  |
|----------------|------------------|
| SM             | = Subminiature   |
| M              | = Miniature      |
| I              | = Intermediate   |
| S              | = Standard       |
| HS             | = Heavy-Standard |
| LH             | = Light-Heavy    |
| H              | = Heavy          |
| EH             | = Extra-Heavy    |

##### Installer Controlled Tension and Cut-Off

Recommended usage: under 10,000 ties/year

Typical applications: MRO or construction

| Cross Section | Tool Part Number – Page B1.112 |      |       |      |
|---------------|--------------------------------|------|-------|------|
|               | STS2                           | STH2 | ST3EH | STHV |
| M             | X                              |      |       |      |
| I             | X                              |      |       |      |
| S             | X                              | X    |       |      |
| HS            |                                | X    |       |      |
| LH            |                                | X    | X     | X    |
| H             |                                | X    | X     | X    |
| EH            |                                |      | X     |      |

#### Pneumatic

Recommended usage: under 250,000 ties/year

Typical applications: Medium to high volume tie usage in OEM

| Cross Section | Tool Part Number – Page B1.113 |     |
|---------------|--------------------------------|-----|
|               | PTS                            | PTH |
| SM            | X                              |     |
| M             | X                              |     |
| I             | X                              |     |
| S             | X                              | X   |
| HS            |                                | X   |
| LH            |                                | X   |
| H             |                                | X   |

### Accessories/Kits

#### Manual

|   | Part Number | For Tool                          | Page   |
|---|-------------|-----------------------------------|--------|
| Tool Tension Locking Kits                                   | KGTSTL      | GTS, GTSL                         | B1.114 |
|   | KGHTL       | GTH                               | B1.114 |
|   | TTLK3       | GS2B, GS4H                        | B1.114 |
| Blade Replacement Kits                                      | KGTSBLD     | GTS, GTSL                         | B1.114 |
|   | KGTHBLD     | GTH                               | B1.114 |
|   | K2-BLD2     | GS2B                              | B1.114 |
|   | K4H-BLD     | GS4H                              | B1.114 |
| Tool Holster  | GHH         | GTS, GTSL, GS2B, GTH, GS4H, GS4EH | B1.114 |
|   | KGTHSLV     | GTH                               | B1.114 |
| Cushion Sleeve Kit  | KGTSBLV     | GTS                               | B1.114 |
|   | KGTHSLV     | GTH                               | B1.114 |
| Pneumatic Hose Assembly, Filter/Regulator, Adapter Fittings | PPH10       |                                   | B1.113 |
|   | PL289N1     |                                   | B1.113 |
|   | PHCAQ       | PTS, PTH, PPTS                    | B1.113 |
|   | PHCAT       |                                   | B1.113 |

#### Pneumatic

| Part Number | For Tool       | Page   |
|-------------|----------------|--------|
| KPTSTL      | PTS, PTH       | B1.114 |
| TTLK3       | PPTS           | B1.114 |
| KGTSBLD     | PTS            | B1.114 |
| KPTHBLD     | PTH            | B1.114 |
| K2-BLD2     | PPTS           | B1.114 |
| GHH         | PTS, PPTS      | B1.114 |
| PPH10       |                | B1.113 |
| PL289N1     |                | B1.113 |
| PHCAQ       | PTS, PTH, PPTS | B1.113 |
| PHCAT       |                | B1.113 |

## Cable Tie Tools – Tool Controlled Tension and Cut-Off



GTS

- Used in production, maintenance, or construction applications
- Tool controlled tension provides flush cut-off and speeds installation to lower installed cost
- Lightweight and balanced
- Easy to change tension adjustment and easy to operate
- A combination of design, operation, and construction features, provides a long service life
- Replacement blades available, see page B1.114
- No special maintenance required



GTS



GTSL



GS2B



GTH



GS4H



GS4EH

| Part Number | Used with Cable Ties | Weight |     | Part Features  | Standards  | Std. Pkg. Qty. |
|-------------|----------------------|--------|-----|--|--|----------------|
|             |                      | Oz.    | g   |  |  |                |
| GTS         | SM, M, I, S          | 9.8    | 278 | Ergonomic design with impact resistant resin housing, narrow nose, and cushion handle.   | QPL per Mil. Std. SAE AS81306 and Mil. Spec. SAE AS90387-1 | 1              |
| GTSL        | SM, M, I, S          | 8.8    | 249 | Ergonomic design with impact resistant resin housing, narrow nose, and cushion handle. Shorter handle reach (than GTS) for users with smaller hands. | QPL per Mil. Std. SAE AS81306 and Mil. Spec. SAE AS90387-5 | 1              |
| GS2B        | M, I, S              | 11.5   | 327 | Metal tool with a durable powder coat finish.  | QPL per Mil. Std. SAE AS81306 and Mil. Spec. SAE AS90387-1 | 1              |
| GTH         | S, HS, LH, H         | 12.0   | 340 | Ergonomic design with impact resistant resin housing, narrow nose, and cushion handle.   | QPL per Mil. Std. SAE AS81306 and Mil. Spec. SAE AS90387-2 | 1              |
| GS4H        | S, HS, LH, H         | 16.0   | 454 | Metal tool with a durable powder coat finish.  | QPL per Mil. Std. SAE AS81306 and Mil. Spec. SAE AS90387-2 | 1              |
| GS4EH       | LH, H, EH            | 16.0   | 454 | Metal tool with a durable powder coat finish.  | QPL per Mil. Std. SAE AS81306 and Mil. Spec. SAE AS90387-4 | 1              |

Cable tie cross section sizes: SM = Subminiature, M = Miniature, I = Intermediate, S = Standard, HS = Heavy-Standard, LH = Light-Heavy, H = Heavy, EH = Extra-Heavy.

A.  
System  
Overview

B1.  
Cable Ties

B2.  
Cable  
Accessories

B3.  
Stainless  
Steel Ties

C1.  
Wiring  
Duct

C2.  
Surface  
Raceway

C3.  
Abrasion  
Protection

C4.  
Cable  
Management

D1.  
Terminals

D2.  
Power  
Connectors

D3.  
Grounding  
Connectors

E1.  
Labeling  
Systems

E2.  
Labels

E3.  
Pre-Printed  
& Write-On  
Markers

E4.  
Permanent  
Identification

E5.  
Lockout/  
Tagout  
& Safety  
Solutions

F.  
Index

A. System Overview

## Cable Tie Tools – Installer Controlled Tension and Cut-Off

B1. Cable Ties

B2. Cable Accessories

B3. Stainless Steel Ties



STS2

- Economical series of tools for maintenance or construction applications
- Excellent tools for low volume applications

C1. Wiring Duct



STS2

C2. Surface Raceway



STH2

C3. Abrasion Protection

C4. Cable Management



ST3EH

D1. Terminals

D2. Power Connectors



STHV

D3. Grounding Connectors

E1. Labeling Systems

E2. Labels

E3. Pre-Printed & Write-On Markers

E4. Permanent Identification

E5. Lockout/Tagout & Safety Solutions

F. Index

| Part Number | Used with Cable Ties | Color      | Weight |     | Part Features   | Std. Pkg. Qty. |
|-------------|----------------------|------------|--------|-----|---|----------------|
|             |                      |            | Oz.    | g   |   |                |
| STS2        | M, I, S              | Black      | 2.5    | 71  | Economical tool with short handle span and top loading feature for right- or left-handed users. | 1              |
| STH2        | S, HS, LH, H         | Red        | 2.5    | 71  | Economical tool with short handle span and top loading feature for right- or left-handed users. | 1              |
| ST3EH       | LH, H, EH            | Blue/Black | 9.0    | 256 | Durable, all steel construction with comfortable plastic handles.                               | 1              |
| STHV        | LH, H                | Yellow     | 12.0   | 341 | Durable all steel construction and "travel stop" to prevent pinched fingers.                    | 1              |

Cable tie cross section sizes: SM = Subminiature, M = Miniature, I = Intermediate, S = Standard, HS = Heavy-Standard, LH = Light-Heavy, H = Heavy, EH = Extra-Heavy.

### Installation Procedure (STS2/STH2/ST3EH):

Install cable tie around bundle and tension tie by squeezing tool handle. Reduce tension slightly and twist tool 1/4" turn either direction to cut off excess cable tie.

### Installation Procedure (STHV):

Install cable tie around bundle and tension tie by squeezing tool handle. A separate lever cuts off excess cable tie.

## Pneumatic Hand Tools – Tool Controlled Tension and Cut-Off



PTS



PTS



PTH

- Pneumatic, push button operation tensions and cuts off excess tie in a fraction of a second
- Durable, lightweight, ergonomic design is easy to operate and designed to reduce operator fatigue
- Easy to change tension adjustment
- Operates on non-lubricated air, without special maintenance

| Part Number | Used with Cable Ties | Weight |     | Part Features  | Std. Pkg. Qty. |
|-------------|----------------------|--------|-----|--|----------------|
|             |                      | Oz.    | g   |  |                |
| PTS         | SM, M, I, S          | 17.3   | 490 | Ergonomic design with impact resistant resin housing and black knob; replacement parts can be part of a scheduled maintenance program. | 1              |
| PTH         | S, HS, LH, H         | 32.0   | 907 | Ergonomic design with impact resistant resin housing and red knob; replacement parts can be part of a scheduled maintenance program.   | 1              |

Note: All tools require the PPH10 hose and PL289N1 filter/regulator for proper operation.

Cable tie cross section sizes: SM = Subminiature, M = Miniature, I = Intermediate, S = Standard, HS = Heavy-Standard, LH = Light-Heavy, H = Heavy.

## Pneumatic Tool Accessories



PL289N1/PPH10



PHCAQ



PHCAT

| Part Number | Used with Installation Tool | Part Description  | Std. Pkg. Qty. |
|-------------|-----------------------------|---|----------------|
| PL289N1     | PTS, PPTS, PTH              | Filter/regulator .5 micron element, regulated range 3 – 100 psig, features 1/8" NPT female output port (to hose PPH10) and 1/4" male quick disconnect to source air line.                       | 1              |
| PPH10       | PTS, PPTS, PTH              | 10.0' (3m) hose assembly (regulator to tool); includes a 1/8" NPT male connector (to regulator) and 1/8" female quick disconnect (to tool).   | 1              |
| PHCAQ       | PTS, PPTS, PTH              | Adapter fitting for 10.0' (3m) hose (PPH10) to regulator with 1/4" female quick disconnect output, features 1/8" NPT female connection (to hose) and 1/4" male quick disconnect (to regulator). | 1              |
| PHCAT       | PTS, PPTS, PTH              | Adapter fitting for 10.0' (3m) hose (PPH10) to regulator with 1/4" NPT female output port, features 1/8" NPT female connection (to hose) and 1/4" NPT male connection (to regulator).           | 1              |

A.  
System  
Overview

## Hand Tool Accessories: Tool Tension Locking Kits

B1.  
Cable Ties

- For applications requiring a locking device on either the selector knob (one cross section size and tension only) or tension level adjustment (but allow cross section size changes)

B2.  
Cable  
Accessories



KGTHTL

B3.  
Stainless  
Steel Ties

| Part Number | Used with Installation Tool | Contents                           | Std. Pkg. Qty. |
|-------------|-----------------------------|------------------------------------|----------------|
| KGTSTL      | GTS, GTSL                   | Lockout cap and screw.             | 1              |
| KGTHTL      | GTH                         | Lockout cap and screw.             | 1              |
| KPTSTL      | PTS, PTH                    | Lockout cap and screw.             | 1              |
| TTLK3       | GS2B, GS4H, PPTS            | Selection locking clip and screws. | 1              |

C1.  
Wiring  
Duct

## Blade Replacement Kits

C2.  
Surface  
Raceway

- Blade replacement kits can be part of a user's scheduled maintenance plan or used when cut-offs are not clean and crisp



KGTSBLD

C3.  
Abrasion  
Protection

| Part Number | Used with Installation Tool | Contents   | Std. Pkg. Qty. |
|-------------|-----------------------------|--|----------------|
| KGTSBLD     | GTS, GTSL, PTS              | Threadlocker, screw, washer and replacement blade. | 1              |
| KGTHBLD     | GTH                         | Threadlocker, screw, and replacement blade.        | 1              |
| K2-BLD2     | GS2B, PPTS                  | Threadlocker, screws, and replacement blade.       | 1              |
| K4H-BLD     | GS4H                        | Threadlocker, screws, and replacement blade.       | 1              |
| K4EH-BLD    | GS4EH                       | Threadlocker, screw, and replacement blade.        | 1              |
| KPTHBLD     | PTH                         | Threadlocker, screw, and replacement blade.        | 1              |

C4.  
Cable  
Management

D1.  
Terminals

## Hand Tool Holster

D2.  
Power  
Connectors

- Durable leather construction holster with rivets and extra tie-down strap to hold tool in place – easily fits on belt



| Part Number | Used with Installation Tool                         | Color | Std. Pkg. Qty. |
|-------------|---|-------|----------------|
| GHH         | GTS, GTSL, GS2B, GTH, GS4H, GS4EH, PTS, PPTS, ST3EH | Black | 1              |

D3.  
Grounding  
Connectors

E1.  
Labeling  
Systems

E2.  
Labels

## **NEW!** Cushion Sleeve Kits

E3.  
Pre-Printed  
& Write-On  
Markers

- Cushion sleeve can be added to existing GTS or GTH hand tool
- Reduce the amount of shock an operator may experience while tensioning and cutting off cable ties
- Reduce operator fatigue
- Unique thermoplastic elastomer material that won't split or fall off the tool over time

E4.  
Permanent  
Identification



KGTSSLV

E5.  
Lockout/  
Tagout  
& Safety  
Solutions

| Part Number | Used with Installation Tool | Color | Contents                      | Std. Pkg. Qty. |
|-------------|-----------------------------|-------|-------------------------------|----------------|
| KGTSSLV     | GTS                         | Black | Cushion sleeve and lubricant. | 1              |
| KGTHSLV     | GTH                         | Red   | Cushion sleeve and lubricant. | 1              |

F.  
Index



## AUTOMATIC CABLE TIE INSTALLATION SYSTEMS



The complete line of Panduit automatic cable tie installation systems offers a superior solution for high volume harness, assembly, fastening and packaging applications. These ergonomic systems increase productivity, provide consistent performance, and reduce activities that lead to repetitive motion injuries. A variety of tool options provide users with flexible solutions for their unique application needs.



### System Highlights

Multiple systems improve productivity, reliability, and versatility:

- Install a cable tie in less than one second
- Multiple cable tie styles and sizes for maximum productivity
- Optional software for advanced system monitoring and performance



Combined, these innovations improve reliability, maximize productivity, and lower installed costs. As with all Panduit products, quality in design and production along with customer service excellence, are assured.

A.  
System  
Overview

B1.  
Cable Ties

B2.  
Cable  
Accessories

B3.  
Stainless  
Steel Ties

C1.  
Wiring  
Duct

C2.  
Surface  
Raceway

C3.  
Abrasion  
Protection

C4.  
Cable  
Management

D1.  
Terminals

D2.  
Power  
Connectors

D3.  
Grounding  
Connectors

E1.  
Labeling  
Systems

E2.  
Labels

E3.  
Pre-Printed  
& Write-On  
Markers

E4.  
Permanent  
Identification

E5.  
Lockout/  
Tagout  
& Safety  
Solutions

F.  
Index

A.  
System  
Overview

## Selection Guide – Automatic Installation Systems and Reel-Fed Cable Ties

B1.  
Cable Ties

Recommended for annual usage of over 250,000 cable ties/year.  
Typical applications: High volume OEM/contract manufacturing.

B2.  
Cable  
Accessories

### PAT1M/PAT1.5M Systems

Tool Head for use with MINIATURE Cross Section

| Part Number | Description  | Page   |
|-------------|--|--------|
| PAT1M       | For miniature cross section up to .82" (21mm) bundle diameter. | B1.117 |
| PAT1.5M     | For miniature cable ties up to 1.31" (33mm) bundle diameter.   | B1.117 |

#### Dispenser

| Part Number | Description   | Page   |
|-------------|---|--------|
| PDM         | Stationary dispenser.                                   | B1.117 |
| PDM-DI      | Dispenser and data interface software.                  | B1.119 |
| PD-DIA      | Data interface accessory – software and interface card. | B1.119 |

#### Transfer Hose

| Part Number | Description               | Page   |
|-------------|---------------------------|--------|
| PHM1        | 3.2' (1m) transfer hose.  | B1.118 |
| PHM2        | 6.5' (2m) transfer hose.  | B1.118 |
| PHM3        | 10.0' (3m) transfer hose. | B1.118 |
| PHM4        | 13.1' (4m) transfer hose. | B1.118 |

#### Optional System Accessories

| Part Number | Description                 | Page   |
|-------------|-----------------------------|--------|
| PDH10-37    | Air hose.                   | B1.118 |
| PL283N1     | Filter/regulator.           | B1.118 |
| PATMBM      | Bench mount and foot pedal. | B1.118 |

### Reel-Fed Cable Ties

#### MINIATURE Cross Section

| Part Number  | Description                                   | Color         | Page   |
|--|---|---------------|--------|
| <b>Barbed Tie – Max. Bundle Dia.: .82" (21mm), 30 lbs.</b>     |   |               |        |
| BT1M-XMR   | Nylon 6.6.                                    | Natural       | B1.120 |
| BT1M-XMR0  | Weather Resistant Nylon 6.6.                  | Black         | B1.120 |
| BT1M-XMR30   | Heat Stabilized Nylon 6.6.                    | Black         | B1.120 |
| <b>Barbed Tie – Max. Bundle Dia.: 1.31" (33mm), 30 lbs.</b>    |   |               |        |
| BT1.5M-XMR   | Nylon 6.6.                                    | Natural       | B1.120 |
| BT1.5M-XMR0  | Weather Resistant Nylon 6.6.                  | Black         | B1.120 |
| BT1.5M-XMR30   | Heat Stabilized Nylon 6.6.                    | Black         | B1.120 |
| BT1.5M-XMR69   | Flame Retardant Nylon 6.6.                    | Natural Ivory | B1.120 |
| <b>All-Nylon Tie – Max. Bundle Dia.: .82" (21mm), 18 lbs.</b>  |   |               |        |
| PLT1M-XMR  | Nylon 6.6.                                    | Natural       | B1.121 |
| PLT1M-XMR0   | Weather Resistant Nylon 6.6.                  | Black         | B1.121 |
| PLT1M-XMR00  | Weather Resistant Nylon 6.6 (Meets Mil Spec). | Black         | B1.121 |
| PLT1M-XMR30  | Heat Stabilized Nylon 6.6.                    | Black         | B1.121 |
| <b>All-Nylon Tie – Max. Bundle Dia.: 1.31" (33mm), 18 lbs.</b> |   |               |        |
| PLT1.5M-XMR  | Nylon 6.6.                                    | Natural       | B1.121 |
| PLT1.5M-XMR0   | Weather Resistant Nylon 6.6.                  | Black         | B1.121 |
| PLT1.5M-XMR00  | Weather Resistant Nylon 6.6 (Meets Mil Spec). | Black         | B1.121 |
| PLT1.5M-XMR30  | Heat Stabilized Nylon 6.6.                    | Black         | B1.121 |

C1.  
Wiring  
Duct

C2.  
Surface  
Raceway

C3.  
Abrasion  
Protection

C4.  
Cable  
Management

D1.  
Terminals

D2.  
Power  
Connectors

D3.  
Grounding  
Connectors

E1.  
Labeling  
Systems

E2.  
Labels

E3.  
Pre-Printed  
& Write-On  
Markers

E4.  
Permanent  
Identification

E5.  
Lockout/  
Tagout  
& Safety  
Solutions

F.  
Index

### PAT2S/PAT3S Systems

Tool Head for use with STANDARD Cross Section

| Part Number | Description  | Page   |
|-------------|--|--------|
| PAT2S       | For standard cross section up to 2.00" (51mm) bundle diameter. | B1.117 |
| PAT3S       | For standard cross section up to 2.75" (70mm) bundle diameter. | B1.117 |

#### Dispenser

| Part Number | Description   | Page   |
|-------------|---|--------|
| PDS         | Stationary dispenser, PAT2S.                            | B1.117 |
| PD3S        | Stationary dispenser, PAT3S.                            | B1.117 |
| PDS-DI      | Dispenser and data interface software.                  | B1.119 |
| PDS-DIA     | Data interface accessory – software and interface card. | B1.119 |

#### Transfer Hose

| Part Number | Description               | Page   |
|-------------|---------------------------|--------|
| PHS2        | 6.5' (2m) transfer hose.  | B1.118 |
| PHS3        | 10.0' (3m) transfer hose. | B1.118 |

#### Dispenser Frame

| Part Number | Description             | Page   |
|-------------|-------------------------|--------|
| PDSF        | Dispenser frame, PAT2S. | B1.118 |
| PD3SF       | Dispenser frame, PAT3S. | B1.118 |

#### Optional System Accessories

| Part Number | Description                                     | Page   |
|-------------|---|--------|
| PDH10-37    | Air hose.                                       | B1.118 |
| PL283N1     | Filter/regulator.                               | B1.118 |
| PAT2SBM     | Bench mount and foot pedal for PAT2S and PAT3S. | B1.118 |

### Reel-Fed Cable Ties

#### STANDARD Cross Section

| Part Number  | Description                                   | Color   | Page   |
|--|---|---------|--------|
| <b>All-Nylon Tie – Max. Bundle Dia.: 2.00" (51mm), 50 lbs.</b> |   |         |        |
| PLT2S-VMR  | Nylon 6.6.                                    | Natural | B1.122 |
| PLT2S-VMR0   | Weather Resistant Nylon 6.6.                  | Black   | B1.122 |
| PLT2S-VMR00  | Weather Resistant Nylon 6.6 (Meets Mil Spec). | Black   | B1.122 |
| PLT2S-VMR30  | Heat Stabilized Nylon 6.6.                    | Black   | B1.122 |
| <b>All-Nylon Tie – Max. Bundle Dia.: 2.75" (70mm), 50 lbs.</b> |   |         |        |
| PLT3S-VMR  | Nylon 6.6.                                    | Natural | B1.122 |
| PLT3S-VMR30  | Heat Stabilized Nylon 6.6.                    | Black   | B1.122 |

## Tool Head – Multiple sizes accommodate a wide variety of applications

- Ergonomic, lightweight design reduces operator fatigue and repetitive motion injuries – no counter balance required
- Right or left hand operation
- Durable, one-piece cable tie tip collector (for cut-off tips)
- Includes tension adjustment
- Built-in safety interlock prevents false triggering if anything obstructs jaw path



PAT1M



PAT1.5M



PAT2S



PAT3S



PAT1.5M-ATM  
For Bundling and  
Mounting Applications

| Part Number | Max. Bundle Dia. |    | Dispenser/Frame | Transfer Hose          | Used with Cable Ties    | Std. Pkg. Qty. |
|-------------|------------------|----|-----------------|------------------------|-------------------------|----------------|
|             | In.              | mm |                 |                        |                         |                |
| PAT1M       | .82              | 21 | PDM             | PHM1, PHM2, PHM3, PHM4 | PLT1M-XMR, BT1M-XMR     | 1              |
| PAT1.5M     | 1.31             | 33 | PDM             |                        | PLT1.5M-XMR, BT1.5M-XMR | 1              |
| PAT2S       | 2.00             | 51 | PDS/PDSF        | PHS2, PHS3             | PLT2S-VMR               | 1              |
| PAT3S       | 2.75             | 70 | PD3S/PD3SF      |                        | PLT3S-VMR               | 1              |
| PAT1.5M-ATM | 1.31             | 33 | PDM             | PHM1, PHM2, PHM3, PHM4 | PLT1.5M-XMR, BT1.5M-XMR | 1              |

## Dispensers

- Microprocessor based controller monitors system performance through LCD display; provides production data and reporting, including error detection and cycle count for improved reliability
- Online HELP menu through LCD display in five languages (English, Spanish, German, Italian or French), is user-friendly for quick and simple training



PDM



PDS/PD3S

| Part Number | Used with Tool Head         | Description   | Std. Pkg. Qty. |
|-------------|-----------------------------|---|----------------|
| PDM         | PAT1M, PAT1.5M, PAT1.5M-ATM | Stationary dispenser with electronic display. Online help menu. System operates on 65 psig (minimum) non-lubricated filtered air and 100 – 24 FAC/TP or 60 MHz. | 1              |
| PDS         | PAT2S                       |   | 1              |
| PD3S        | PAT3S                       |   | 1              |

A. System Overview

B1. Cable Ties

B2. Cable Accessories

B3. Stainless Steel Ties

C1. Wiring Duct

C2. Surface Raceway

C3. Abrasion Protection

C4. Cable Management

D1. Terminals

D2. Power Connectors

D3. Grounding Connectors

E1. Labeling Systems

E2. Labels

E3. Pre-Printed & Write-On Markers

E4. Permanent Identification

E5. Lockout/Tagout & Safety Solutions

F. Index

A.  
System  
Overview

## Transfer Hoses



PHM3

| Part Number | Used with Tool Head | Part Description  | Length |   | Std. Pkg. Qty. |
|-------------|---------------------|---|--------|---|----------------|
|             |                     |   | Ft.    | m |                |
| PHM1        | PAT1M, PAT1.5M      | Transfers cable tie and signal from dispenser to tool head; electrical connectors designed for easy attachment provide a reliable, secure connection. | 3.2    | 1 | 1              |
| PHM2        |                     |   | 6.5    | 2 | 1              |
| PHM3        |                     |   | 10.0   | 3 | 1              |
| PHM4        |                     |   | 13.1   | 4 | 1              |
| PHS2        | PAT2S, PAT3S        |   | 6.5    | 2 | 1              |
| PHS3        |                     |   | 10.0   | 3 | 1              |

B1.  
Cable Ties

B2.  
Cable  
Accessories

B3.  
Stainless  
Steel Ties

C1.  
Wiring  
Duct

## Dispenser Frame



PDSF



PD3SF

| Part Number | Used with Dispenser | Description  | Std. Pkg. Qty. |
|-------------|---------------------|--|----------------|
| PDSF        | PDS (PAT2S)         | Metal frame supports the PDS dispenser for PAT2S above the cable tie reel as ties are loaded into the dispenser; can be used as a freestanding unit or permanently mounted to a bench or cart. | 1              |
| PD3SF       | PD3S (PAT3S)        | Assembly holds cable tie reel and rewinds the packaging paper liner as cable ties are being loaded into the dispenser.   | 1              |

C2.  
Surface  
Raceway

C3.  
Abrasion  
Protection

C4.  
Cable  
Management

## Optional System Accessories:

### Filter/Regulator and Air Supply Hose



PL283N1



PDH10-37

| Part Number | Used with Dispenser | Description  | Std. Pkg. Qty. |
|-------------|---------------------|--|----------------|
| PL283N1     | PDM, PDS            | Regulates air flow to dispenser. Filter/regulator 25 micron (max.) element, 3/8" ports. Includes a male connector and a 3/8" port. | 1              |
| PDH10-37    | PDM, PDS            | Air hose from filter/regulator to dispenser; 10.0' (3m) – includes standard air fittings.  | 1              |

D1.  
Terminals

D2.  
Power  
Connectors

D3.  
Grounding  
Connectors

E1.  
Labeling  
Systems

## Bench Mount



PATMBM

| Part Number | Used with Tool Head | Description  | Std. Pkg. Qty. |
|-------------|---------------------|--|----------------|
| PATMBM      | PAT1M, PAT1.5M      | Allows hands-free operation for high volume usage. Includes bench mount fixture and foot pedal assembly. | 1              |
| PATSBM      | PAT2S, PAT3S        |  | 1              |

E2.  
Labels

E3.  
Pre-Printed  
& Write-On  
Markers

E4.  
Permanent  
Identification



E5.  
Lockout/  
Tagout/  
& Safety  
Solutions

F.  
Index

## Data Interface Software and Ethernet Enabled Dispenser

Panduit exclusive Ethernet enabled dispenser and customized data interface software allow production personnel to monitor real-time data in a shop floor environment.

The Ethernet enabled dispenser provides a physical connection between the cable tie installation system and an Industrial Ethernet Network via an RJ45 connection and internal Ethernet card.

- Allows production and/or engineering personnel the capability to measure and track production performance such as job tracking, cycle counts, tool and dispenser serial numbers, and routine maintenance
- Provides the ability to send email notifications for specific system messages
- Data extraction and reporting capabilities on system performance through an exportable electronic log; helps identify operator training needs
- Ability to monitor alerts from remote desktop locations



| Part Number | Used with Dispenser | Description   | Std. Pkg. Qty. |
|-------------|---------------------|---|----------------|
| PDM-DI      | PDM                 | Ethernet enabled PDM dispenser and data interface software.                                     | 1              |
| PDS-DI      | PDS                 | Ethernet enabled PDS dispenser and data interface software.                                     | 1              |
| PD-DIA      | PDM/PDS             | Data interface accessory for existing PDM, PDS dispensers; software and network interface card. | 1              |

## PAT/Robot Integration Kit

- Used with the PAT1M and PAT1.5M tool heads
- Utilizes the PAT system electronic interface option, PDM-EI, to optimally integrate the PAT system to a robot for a completely automated cable tie installation process
- Significantly reduces labor costs while improving installation quality, reliability, and consistency



PATM-RK



PATM-TT

| Part Number | Components                      | Description   | Std. Pkg. Qty. |
|-------------|---------------------------------|---|----------------|
| PATM-RK     | Metallic housing                | Includes a pneumatic trigger actuator for remote cable tie installation and a mounting bolt pattern to ease PAT tool integration with a robot end effector for a robust and accurate grip.  | 1              |
|             | Transfer hose strain relief kit | Strain relief to maintain transfer hose bend radius reducing tie misfeeds due to sharp hose bend radii during robot motion; also sold separately under part number PATM-RKS (includes two 1-foot strain relief tubes with fastening cable ties).                  |                |
|             | Quick start guides              | Provides easily understood electrical, network, and mechanical installation instructions minimizing the robot integrator's design time and simplifying the integration process.   |                |
|             | Best practices document         | List of best practices when integrating the PAT system to a robot optimizing system performance and productivity.   |                |
| PATM-TT     | Test tool with rubber jaws      | This test tool is used during robot cable tie installation programming, providing a safe method to debug robot software without damaging actual PAT tools (test tool is not provided with the PAT/Robot Integration Kit).   | 1              |
| PATM-RKS    | Transfer hose strain relief kit | Strain relief to maintain transfer hose bend radius reducing cable tie misfeeds due to sharp hose bend radii during robot motion; kit is also included on the PATM-RK kit or sold separately (includes two 1-foot strain relief tubes with fastening cable ties). | 1              |



A. System Overview



## BT-XMR Reel-Fed Cable Ties

B1. Cable Ties

- Continuously molded cable ties (5,000 ties/reel) provide continuous feeding for high productivity and reduced downtime due to fewer reel changes
- Reel-fed cable ties with exclusive stainless steel locking barb and 30 lbs. minimum loop tensile strength permit higher tension for demanding applications
- Metal locking barb and tie body design provide greater bundle tightness, reducing both rotational and lateral movement of the tie
- Reel-fed cable ties in Nylon 6.6 material (Natural color) are UL Listed for use in plenum or air handling spaces per NEC

B2. Cable Accessories

B3. Stainless Steel Ties

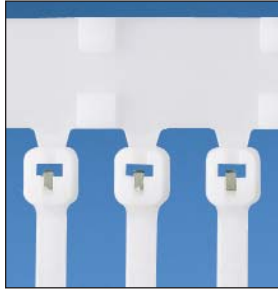

BT\_XMR

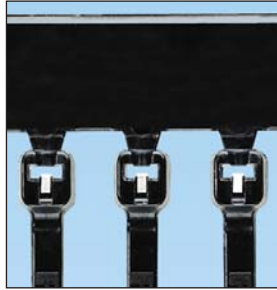

BT\_XMR (0, 30)

C1. Wiring Duct

C2. Surface Raceway

C3. Abrasion Protection

C4. Cable Management

D1. Terminals

D2. Power Connectors

D3. Grounding Connectors

E1. Labeling Systems

E2. Labels

E3. Pre-Printed & Write-On Markers

E4. Permanent Identification

E5. Lockout/Tagout & Safety Solutions

F. Index



| Part Number                                 | Tie Style | Material                    | Color   | Max. Bundle Dia. |    | Length |     | Width |     | Min. Loop Tensile Str. |     |
|---|-----------|-----------------------------|---------|------------------|----|--------|-----|-------|-----|------------------------|-----|
|   |           |                             |         | In.              | mm | In.    | mm  | In.   | mm  | Lbs.                   | N   |
| <b>Reel-Fed Cable Ties for PAT1M System</b> |           |                             |         |                  |    |        |     |       |     |                        |     |
| <b>BT1M-XMR</b>                             | Barbed    | Nylon 6.6                   | Natural | .82              | 21 | 4.0    | 102 | .100  | 2.5 | 30                     | 133 |
| <b>BT1M-XMR0</b>                            | Barbed    | Weather Resistant Nylon 6.6 | Black   | .82              | 21 | 4.0    | 102 | .100  | 2.5 | 30                     | 133 |
| <b>BT1M-XMR30</b>                           | Barbed    | Heat Stabilized Nylon 6.6   | Black   | .82              | 21 | 4.0    | 102 | .100  | 2.5 | 30                     | 133 |

|   |        |                             |         |      |    |     |     |      |     |    |     |
|---|--------|-----------------------------|---------|------|----|-----|-----|------|-----|----|-----|
| <b>Reel-Fed Cable Ties for PAT1.5M System</b> |        |                             |         |      |    |     |     |      |     |    |     |
| <b>BT1.5M-XMR</b>                             | Barbed | Nylon 6.6                   | Natural | 1.31 | 33 | 5.6 | 142 | .100 | 2.5 | 30 | 133 |
| <b>BT1.5M-XMR0</b>                            | Barbed | Weather Resistant Nylon 6.6 | Black   | 1.31 | 33 | 5.6 | 142 | .100 | 2.5 | 30 | 133 |
| <b>BT1.5M-XMR30</b>                           | Barbed | Heat Stabilized Nylon 6.6   | Black   | 1.31 | 33 | 5.6 | 142 | .100 | 2.5 | 30 | 133 |



## PLT-XMR Reel-Fed Cable Ties

- Continuously molded cable ties (5,000 ties/reel) provide continuous feeding for high productivity and reduced downtime due to fewer reel changes
- All-nylon, one-piece locking ties with 18 lbs. minimum loop tensile strength in miniature cross section
- Available in a variety of colors and materials
- Reel-fed cable ties in Nylon 6.6 material (except black) are UL Listed for use in plenum or air handling spaces per NEC



| Part Number                                 | Tie Style | Material                    | Color   | Max. Bundle Dia. |    | Length |     | Width |     | Min. Loop Tensile Str. |    |
|---|-----------|-----------------------------|---------|------------------|----|--------|-----|-------|-----|------------------------|----|
|   |           |                             |         | In.              | mm | In.    | mm  | In.   | mm  | Lbs.                   | N  |
| <b>Reel-Fed Cable Ties for PAT1M System</b> |           |                             |         |                  |    |        |     |       |     |                        |    |
| PLT1M-XMR                                   | All-Nylon | Nylon 6.6                   | Natural | .82              | 21 | 4.0    | 102 | .100  | 2.5 | 18                     | 80 |
| PLT1M-XMR0                                  | All-Nylon | Weather Resistant Nylon 6.6 | Black   | .82              | 21 | 4.0    | 102 | .100  | 2.5 | 18                     | 80 |
| PLT1M-XMR00*                                | All-Nylon | Weather Resistant Nylon 6.6 | Black   | .82              | 21 | 4.0    | 102 | .100  | 2.5 | 18                     | 80 |
| PLT1M-XMR1                                  | All-Nylon | Nylon 6.6                   | Brown   | .82              | 21 | 4.0    | 102 | .100  | 2.5 | 18                     | 80 |
| PLT1M-XMR2                                  | All-Nylon | Nylon 6.6                   | Red     | .82              | 21 | 4.0    | 102 | .100  | 2.5 | 18                     | 80 |
| PLT1M-XMR3                                  | All-Nylon | Nylon 6.6                   | Orange  | .82              | 21 | 4.0    | 102 | .100  | 2.5 | 18                     | 80 |
| PLT1M-XMR4Y                                 | All-Nylon | Nylon 6.6                   | Yellow  | .82              | 21 | 4.0    | 102 | .100  | 2.5 | 18                     | 80 |
| PLT1M-XMR5                                  | All-Nylon | Nylon 6.6                   | Green   | .82              | 21 | 4.0    | 102 | .100  | 2.5 | 18                     | 80 |
| PLT1M-XMR6                                  | All-Nylon | Nylon 6.6                   | Blue    | .82              | 21 | 4.0    | 102 | .100  | 2.5 | 18                     | 80 |
| PLT1M-XMR7                                  | All-Nylon | Nylon 6.6                   | Purple  | .82              | 21 | 4.0    | 102 | .100  | 2.5 | 18                     | 80 |
| PLT1M-XMR8                                  | All-Nylon | Nylon 6.6                   | Gray    | .82              | 21 | 4.0    | 102 | .100  | 2.5 | 18                     | 80 |
| PLT1M-XMR10                                 | All-Nylon | Nylon 6.6                   | White   | .82              | 21 | 4.0    | 102 | .100  | 2.5 | 18                     | 80 |
| PLT1M-XMR30                                 | All-Nylon | Heat Stabilized Nylon 6.6   | Black   | .82              | 21 | 4.0    | 102 | .100  | 2.5 | 18                     | 80 |

### Reel-Fed Cable Ties for PAT1.5M System

|                |           |                             |         |      |    |     |     |      |     |    |    |
|----------------|-----------|-----------------------------|---------|------|----|-----|-----|------|-----|----|----|
| PLT1.5M-XMR    | All-Nylon | Nylon 6.6                   | Natural | 1.31 | 33 | 5.6 | 142 | .100 | 2.5 | 18 | 80 |
| PLT1.5M-XMR0   | All-Nylon | Weather Resistant Nylon 6.6 | Black   | 1.31 | 33 | 5.6 | 142 | .100 | 2.5 | 18 | 80 |
| PLT1.5M-XMR00* | All-Nylon | Weather Resistant Nylon 6.6 | Black   | 1.31 | 33 | 5.6 | 142 | .100 | 2.5 | 18 | 80 |
| PLT1.5M-XMR30  | All-Nylon | Heat Stabilized Nylon 6.6   | Black   | 1.31 | 33 | 5.6 | 142 | .100 | 2.5 | 18 | 80 |

\*Military grade weather resistant material.

Note: PLT\_XMR cable ties (natural, 00, and colors) are Class 2 Mil. Spec. per SAE-AS23190A and SAE-AS33671.

A.  
System  
Overview

B1.  
Cable Ties

B2.  
Cable  
Accessories

B3.  
Stainless  
Steel Ties

C1.  
Wiring  
Duct

C2.  
Surface  
Raceway

C3.  
Abrasion  
Protection

C4.  
Cable  
Management

D1.  
Terminals

D2.  
Power  
Connectors

D3.  
Grounding  
Connectors

E1.  
Labeling  
Systems

E2.  
Labels

E3.  
Pre-Printed  
& Write-On  
Markers

E4.  
Permanent  
Identification

E5.  
Lockout/  
Tagout  
& Safety  
Solutions

F.  
Index

A. System Overview

**PLT-VMR Reel-Fed Cable Ties**

- Continuously molded cable ties (2,500 ties/reel) provide continuous feeding for high productivity and reduced downtime due to fewer reel changes
- All-nylon, one-piece locking ties with 50 lbs. minimum loop tensile strength in standard cross section for larger bundles up to 1.94" (49mm) diameter
- Reel-fed cable ties in Nylon 6.6 material (Natural color) are UL Listed for use in plenum or air handling spaces per NEC

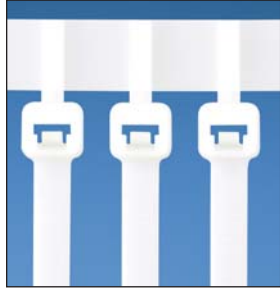

B1. Cable Ties

B2. Cable Accessories

B3. Stainless Steel Ties

C1. Wiring Duct

C2. Surface Raceway

C3. Abrasion Protection

C4. Cable Management

D1. Terminals

D2. Power Connectors

D3. Grounding Connectors

E1. Labeling Systems

E2. Labels

E3. Pre-Printed & Write-On Markers

E4. Permanent Identification

E5. Lockout/Tagout & Safety Solutions

F. Index

| Part Number                                 | Tie Style | Material                    | Color   | Max. Bundle Dia. |    | Length |     | Width |     | Min. Loop Tensile Str. |     |  |
|---|-----------|-----------------------------|---------|------------------|----|--------|-----|-------|-----|------------------------|-----|--|
|   |           |                             |         | In.              | mm | In.    | mm  | In.   | mm  | Lbs.                   | N   |  |
| <b>Reel-Fed Cable Ties for PAT2S System</b> |           |                             |         |                  |    |        |     |       |     |                        |     |  |
| <b>PLT2S-VMR</b>                            | All-Nylon | Nylon 6.6                   | Natural | 1.94             | 49 | 8.1    | 206 | 0.190 | 4.8 | 50                     | 222 |  |
| <b>PLT2S-VMR0</b>                           | All-Nylon | Weather Resistant Nylon 6.6 | Black   | 1.94             | 49 | 8.1    | 206 | 0.190 | 4.8 | 50                     | 222 |  |
| <b>PLT2S-VMR30</b>                          | All-Nylon | Heat Stabilized Nylon 6.6   | Black   | 1.94             | 49 | 8.1    | 206 | 0.190 | 4.8 | 50                     | 222 |  |
| <b>Reel-Fed Cable Ties for PAT3S System</b> |           |                             |         |                  |    |        |     |       |     |                        |     |  |
| <b>PLT3S-VMR</b>                            | All-Nylon | Nylon 6.6                   | Natural | 2.75             | 70 | 11.3   | 287 | 0.190 | 4.8 | 50                     | 222 |  |
| <b>PLT3S-VMR30</b>                          | All-Nylon | Heat Stabilized Nylon 6.6   | Black   | 2.75             | 70 | 11.3   | 287 | 0.190 | 4.8 | 50                     | 222 |  |

Note: PLT\_VMR Nylon 6.6 cable ties are Class 2 Mil. Spec. per SAE-AS23190A and SAE-AS33671.

## CABLE ACCESSORIES



Panduit provides a comprehensive offering of cable accessories. These accessories are engineered to speed installation and lower installed costs for routing and managing cable. Panduit cable accessories are designed and manufactured to meet applicable quality standards including International, UL, Military, ISO and Aerospace.



- Largest selection of mounts, clips, and clamps for cable management
- Panduit cable ties and accessories can be used in a variety of applications and environments, providing the optimal cable management solution
- Installation methods include adhesive backed, user applied adhesive, screws, rivets or push barb

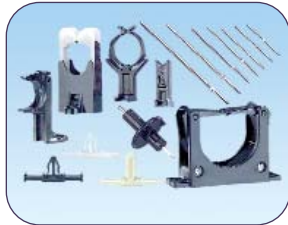

Panduit mounts, clips, and clamps are manufactured in an environment committed to design innovation, high quality, and knowledgeable service to our customers. Adhesive backed mounts provide a strong adhesive bond for long-term reliability. Cable clips offer a one-piece solution to save time and reduce inventory. Harness board accessories speed the routing and forming of cable bundles in the fabrication of a harness. They hold bundles at a uniform height above the board and are ideal for use with Panduit manual and automatic cable tie tooling.

A.  
System  
Overview

B1.  
Cable Ties

B2.  
Cable  
Accessories

B3.  
Stainless  
Steel Ties

C1.  
Wiring  
Duct

C2.  
Surface  
Raceway

C3.  
Abrasion  
Protection

C4.  
Cable  
Management

D1.  
Terminals

D2.  
Power  
Connectors

D3.  
Grounding  
Connectors

E1.  
Labeling  
Systems

E2.  
Labels

E3.  
Pre-Printed  
& Write-On  
Markers

E4.  
Permanent  
Identification

E5.  
Lockout/  
Tagout  
& Safety  
Solutions

F.  
Index

A.  
System  
Overview

## Cable Accessories Products Overview – Used with Cable Ties

B1.  
Cable Ties

### Adhesive Backed Cable Tie Mounts

Pages B2.4 – B2.10

B2.  
Cable  
Accessories



- Uses premium Panduit adhesive for a long-term, reliable bond
- Adhesive backing allows routing of wires and cables where mounting holes cannot be drilled
- Mounts should be used with Panduit cable ties for a complete wire routing solution

B3.  
Stainless  
Steel Ties

C1.  
Wiring  
Duct

C2.  
Surface  
Raceway

C3.  
Abrasion  
Protection

### Screw Applied Cable Tie Mounts

Pages B2.11 – B2.17

C4.  
Cable  
Management



- Screw/riev applied cable tie mounts offer a countersunk or through hole in the mount through which a screw or rivet can be secured
- Offered in a wide selection of specialty materials for resistance to severe conditions such as heat, radiation, chemicals, and outdoor environments
- Available in styles ranging from low profile mounts with integral push-rivet to high stability cradle mounts for Extra-Heavy strength cable ties

D1.  
Terminals

D2.  
Power  
Connectors

D3.  
Grounding  
Connectors

E1.  
Labeling  
Systems

### Other Cable Tie Mounts

Pages B2.18 – B2.29

E2.  
Labels



- Push mount designs lock into a hole in a metallic panel or in a blind masonry hole
- Edge clip mounts secure to a panel edge using metal barbs that dig into panel surface
- Stud mounts secure onto threaded bolts by screwing or hammering on the bolt
- Connector rings can be used to attach adjacent bundles to provide spacing and prevent vibration damage

E3.  
Pre-Printed  
& Write-On  
Markers

E4.  
Permanent  
Identification

E5.  
Lockout/  
Tagout  
& Safety  
Solutions

F.  
Index



## Cable Accessories Products Overview – Used without Cable Ties

### Adhesive Backed Clips and Clamps

Pages B2.30 – B2.39

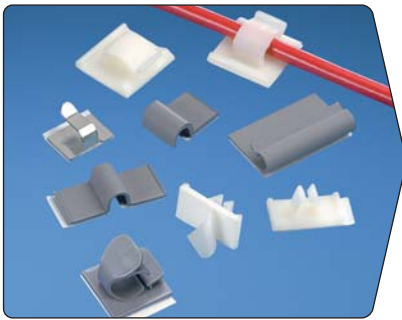

- A wide range of styles and sizes of adhesive backed clips and clamps to secure a variety of cables, from individual small diameter wires to large flat cables
- Products come in designs that use friction to hold a few cables, or more secure releasable latching designs
- Uses premium Panduit adhesive for a long-term, reliable bond

### Other Clips and Clamps

Pages B2.39 – B2.46



- Screw clips use a screw, nail, or rivet to secure the clip to surface
- Plastic edge clips secure to an edge in a panel which incorporates a punched hole to provide mechanical retention
- Push-in clips use an arrow-head shaped barb to lock into a hole in a panel, and is available in a range of bundle sizes

### Harness Board Accessories

Pages B2.47 – B2.52



- Allow an installer to quickly configure a specific arrangement of wires, to aid in required wire bundling and termination
- Hold wire bundles at a uniform height from a harness board to ease manual or automatic cable tie installation
- Aid in the proper routing and forming of wire bundles to help maintain end product consistency, reduce expensive rework and maximize safety

A.  
System  
Overview

B1.  
Cable  
Ties

B2.  
Cable  
Accessories

B3.  
Stainless  
Steel  
Ties

C1.  
Wiring  
Duct

C2.  
Surface  
Raceway

C3.  
Abrasion  
Protection

C4.  
Cable  
Management

D1.  
Terminals

D2.  
Power  
Connectors

D3.  
Grounding  
Connectors

E1.  
Labeling  
Systems

E2.  
Labels

E3.  
Pre-Printed  
& Write-On  
Markers

E4.  
Permanent  
Identification

E5.  
Lockout/  
Tagout  
& Safety  
Solutions

F.  
Index

A. System Overview

## 4-Way Adhesive Backed Cable Tie Mounts

B1. Cable Ties

- Allow cable tie entry from all four sides
- Available in multiple sizes to match application load requirements
- Produced 2-up or 4-up for fast and easy liner removal to speed installation

B2. Cable Accessories

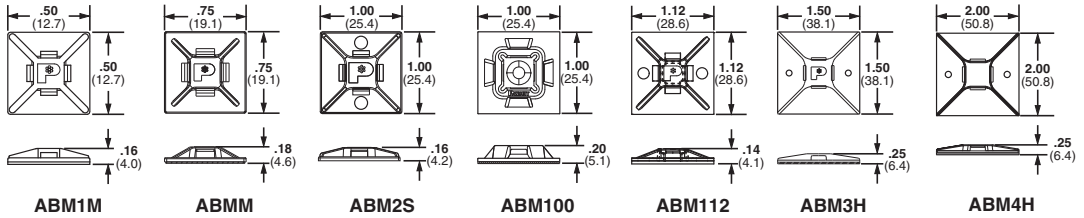

B3. Stainless Steel Ties

C1. Wiring Duct

| Part Number | Used with Cable Ties‡ | Material | Color | Environment | Mounting Method* | Std. Pkg. Qty. | Std. Ctn. Qty. |
|-------------|-----------------------|----------|-------|-------------|------------------|----------------|----------------|
|-------------|-----------------------|----------|-------|-------------|------------------|----------------|----------------|

### 4-Way Mounts with Pre-Installed Adhesive

|                     |                             |                             |                    |                    |         |      |      |
|---------------------|-----------------------------|-----------------------------|--------------------|--------------------|---------|------|------|
| <b>ABM1M-A-C</b>    | M                           | Nylon 6.6                   | White              | Indoors            | Rubber  | 100  | 500  |
| <b>ABM1M-AT-C</b>   |                             | Nylon 6.6                   | White              | Indoors/High Temp  | Acrylic | 100  | 500  |
| <b>ABMM-A-C</b>     | M, I                        | ABS                         | White              | Indoors            | Rubber  | 100  | 500  |
| <b>ABMM-AT-C</b>    |                             | ABS                         | White              | Indoors/High Temp  | Acrylic | 100  | 500  |
| <b>ABMM-AT-C0</b>   |                             | Weather Resistant ABS       | Black              | Outdoors/High Temp | Acrylic | 100  | 500  |
| <b>ABM2S-A-C</b>    | M, I, S                     | ABS                         | White              | Indoors            | Rubber  | 100  | 500  |
| <b>ABM2S-A-C14</b>  |                             | ABS                         | Gray               | Indoors            | Rubber  | 100  | 500  |
| <b>ABM2S-A-C15</b>  |                             | ABS                         | Ivory              | Indoors            | Rubber  | 100  | 500  |
| <b>ABM2S-AT-C</b>   |                             | ABS                         | White              | Indoors/High Temp  | Acrylic | 100  | 500  |
| <b>ABM2S-AT-C0</b>  |                             | Weather Resistant ABS       | Black              | Outdoors/High Temp | Acrylic | 100  | 500  |
| <b>ABM100-A-C</b>   | M, I, S                     | Nylon 6.6                   | White              | Indoors            | Rubber  | 100  | 1000 |
| <b>ABM100-A-C15</b> |                             | Nylon 6.6                   | Ivory              | Indoors            | Rubber  | 100  | 1000 |
| <b>ABM100-AT-C</b>  |                             | Nylon 6.6                   | White              | Indoors/High Temp  | Acrylic | 100  | 1000 |
| <b>ABM100-AT-C0</b> |                             | Weather Resistant Nylon 6.6 | Black              | Outdoors/High Temp | Acrylic | 100  | 1000 |
| <b>ABM112-A-C</b>   |                             | Nylon 6.6                   | White              | Indoors            | Rubber  | 100  | 500  |
| <b>ABM112-AT-C</b>  | Nylon 6.6                   | White                       | Indoors/High Temp  | Acrylic            | 100     | 1000 |      |
| <b>ABM112-AT-C0</b> | Weather Resistant Nylon 6.6 | Black                       | Outdoors/High Temp | Acrylic            | 100     | 1000 |      |
| <b>ABM3H-A-L</b>    | M, I, S, HS, LH, H, HLM     | Nylon 6.6                   | White              | Indoors            | Rubber  | 50   | 500  |
| <b>ABM3H-AT-L</b>   |                             | Nylon 6.6                   | White              | Indoors/High Temp  | Acrylic | 50   | 500  |
| <b>ABM4H-A-L</b>    |                             | Nylon 6.6                   | White              | Indoors            | Rubber  | 50   | 500  |
| <b>ABM4H-AT-L</b>   |                             | Nylon 6.6                   | White              | Indoors/High Temp  | Acrylic | 50   | 500  |

‡Cable tie cross section sizes: M = Miniature, I = Intermediate, S = Standard, HS = Heavy-Standard, LH = Light-Heavy, and H = Heavy, HLM = Miniature Tak-Ty® Hook & Loop Ties.

\*For proper selection of adhesives see page B2.54.

E4. Permanent Identification

E5. Lockout/Tagout & Safety Solutions

F. Index

## 4-Way Adhesive Backed Cable Tie Mounts (continued)

| Part Number  | Used with Cable Ties‡ | Material                  | Color     | Environment | Mounting Method*                                 | Std. Pkg. Qty.                                   | Std. Ctn. Qty. |      |
|--|-----------------------|---------------------------|-----------|-------------|--|--|----------------|------|
| <b>4-Way Mounts for Installation with Screws or User-Supplied Adhesive</b> |                       |                           |           |             |  |  |                |      |
| ABMM-D   | M, I                  | ABS                       | White     | Indoors     | User Supplied Adhesive                           | 500  | 5000           |      |
| ABM2S-S6-D   | M, I, S               | ABS                       | White     | Indoors     | User Supplied Adhesive and/or two #6 (M3) Screws | 500  | 5000           |      |
| ABM100-S6-C  |                       | Nylon 6.6                 | White     | Indoors     |  | 100  | 1000           |      |
| ABM100-S6-C69  |                       | Flame Retardant Nylon 6.6 | Natural   | Indoors     | User Supplied Adhesive and/or #6 (M3) Screw      | 100  | 1000           |      |
| ABM112-S6-C  |                       | Nylon 6.6                 | White     | Indoors     | User Supplied Adhesive and/or Two #6 (M3) Screws | 100  | 1000           |      |
| ABM112-S6-C69  |                       | Flame Retardant Nylon 6.6 | Natural   | Indoors     |  | 100  | 500            |      |
| ABM3H-S6-T   |                       | M, I, S, HS, LH, H, HLM   | Nylon 6.6 | White       | Indoors  | User Supplied Adhesive and/or Two #6 (M3) Screws | 200            | 2000 |
| ABM4H-S6-T   |                       |                           | Nylon 6.6 | White       | Indoors  |  | 200            | 1000 |

‡Cable tie cross section sizes: M = Miniature, I = Intermediate, S = Standard, HS = Heavy-Standard, LH = Light-Heavy, and H = Heavy, HLM = Miniature Tak-Ty® Hook & Loop Ties.

\*For proper selection of adhesives see page B2.54.

A.  
System  
Overview

B1.  
Cable Ties

B2.  
Cable  
Accessories

B3.  
Stainless  
Steel Ties

C1.  
Wiring  
Duct

C2.  
Surface  
Raceway

C3.  
Abrasion  
Protection

C4.  
Cable  
Management

D1.  
Terminals

D2.  
Power  
Connectors

D3.  
Grounding  
Connectors

E1.  
Labeling  
Systems

E2.  
Labels

E3.  
Pre-Printed  
& Write-On  
Markers

E4.  
Permanent  
Identification

E5.  
Lockout/  
Tagout  
& Safety  
Solutions

F.  
Index

A. System Overview

## ABMQ® Multiple Bridge Adhesive Backed Cable Tie Mounts

B1. Cable Ties

B2. Cable Accessories

B3. Stainless Steel Ties

- Multiple cable tie bridges on one mount speeds installation of cable bundles by reducing the number of mounts applied
- Dovetail connection system provides alignment and a joining method to expand routing capabilities
- V-groove allows for easy separation into two mounts with two bridges each for separate applications

- 4-way cable tie bridges allow cable bundles to be secured perpendicular to the mount for even spacing or inline to secure a bundle in multiple places
- Large adhesive surface area provides long-term reliability and keeps product in place despite heavy load or high stress

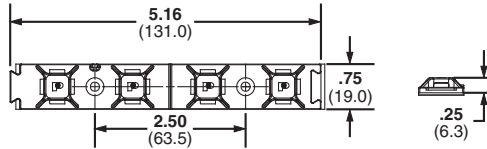

C1. Wiring Duct

C2. Surface Raceway

C3. Abrasion Protection

C4. Cable Management

D1. Terminals

D2. Power Connectors

D3. Grounding Connectors

E1. Labeling Systems

E2. Labels

E3. Pre-Printed & Write-On Markers

E4. Permanent Identification

E5. Lockout/Tagout & Safety Solutions

F. Index

| Part Number   | Used with Cable Ties‡ | Material              | Color | Environment        | Mounting Method  | Std. Pkg. Qty. | Std. Ctn. Qty. |
|---|-----------------------|-----------------------|-------|--------------------|------------------|----------------|----------------|
| <b>ABMQ Mounts with Pre-Installed Adhesive</b>                            |                       |                       |       |                    |                  |                |                |
| <b>ABMQS-A-Q</b>  | M, I, S               | ABS                   | White | Indoors            | Rubber           | 25             | 250            |
| <b>ABMQS-A-Q20</b>  |                       | ABS                   | Black | Indoors            | Rubber           | 25             | 250            |
| <b>ABMQS-AT-Q</b>   |                       | ABS                   | White | Indoors/High Temp  | Acrylic          | 25             | 250            |
| <b>ABMQS-AT-Q0</b>  |                       | Weather Resistant ABS | Black | Outdoors/High Temp | Acrylic          | 25             | 250            |
| <b>ABMQ Mounts for Installation with Screws or User-Supplied Adhesive</b> |                       |                       |       |                    |                  |                |                |
| <b>ABMQS-S6-C0</b>  | M, I, S               | Weather Resistant ABS | Black | Outdoors/High Temp | Two #6 M3 Screws | 100            | 1000           |
| <b>ABMQS-S6-C</b>   |                       | ABS                   | White | Indoors/High Temp  |                  | 100            | 1000           |

‡Cable tie cross section sizes: M = Miniature, I = Intermediate, and S = Standard.

## Tak-Ty® Hook & Loop Cable Tie Mounts

- For use with hook and loop cable ties, see page B1.87, B1.88
- Unique cradle design provides maximum stability for cable bundle
- For indoor use only

- Dimensions: 1.10"L x 1.12"W x 0.34"H (27.9mm x 28.4mm x 8.6mm)

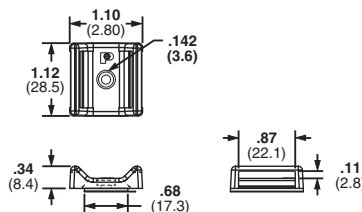

| Part Number        | Used with Cable Ties‡ | Material                  | Color   | Max. Static Load |      | Mounting Method*              | Std. Pkg. Qty. | Std. Ctn. Qty. |
|--------------------|-----------------------|---------------------------|---------|------------------|------|-------------------------------|----------------|----------------|
|                    |                       |                           |         | Lbs.             | g    |                               |                |                |
| <b>ABMT-A-C</b>    | HLT, HLS, TTS, UCT    | Nylon 6.6                 | Natural | 0.38             | 174  | Pre-installed Rubber Adhesive | 100            | 1000           |
| <b>ABMT-A-C20</b>  |                       |                           | Black   |                  |      |                               |                |                |
| <b>ABMT-S6-C</b>   |                       |                           | Natural | —                | —    | #6 (M3) Screw                 | 100            | 1000           |
| <b>ABMT-S6-C20</b> |                       | Black                     |         |                  |      |                               |                |                |
| <b>ABMT-S6-C60</b> |                       | Black                     |         |                  |      |                               |                |                |
| <b>ABMT-S6-C69</b> |                       | Flame Retardant Nylon 6.6 | Natural | 100              | 1000 |                               |                |                |

‡Cable tie cross section sizes: HLT = Tak-Ty™ Hook & Loop Ties, HLS = Tak-Ty™ Hook & Loop Strip Tie, TTS = Tak-Tape™ Roll, UCT = Ultra-Cinch™ Tie.  
\*For proper selection of adhesives see page B2.54.

## Super-Grip™ Adhesive Backed Cable Tie Mounts

- Low profile design keeps bundle close to mounting surface
- Small overall size allows use where space is limited

- For use with Super-Grip™ Cable Ties found on page B1.38
- New! High Bond Adhesive available

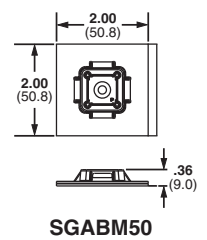
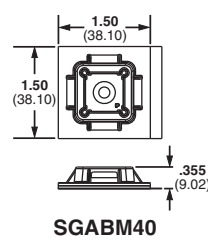
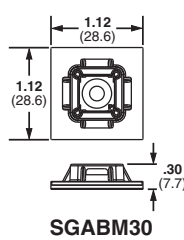
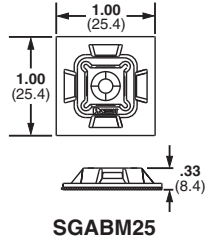
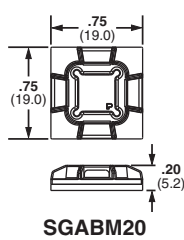

| Part Number  | Used with Cable Ties‡    | Material                                    | Color | Environment        | Mounting Method*                        | Std. Pkg. Qty. | Std. Ctn. Qty. |
|--|--------------------------|---|-------|--------------------|---|----------------|----------------|
| <b>Super-Grip™ Mounts with Pre-Installed Adhesive</b>                            |                          |   |       |                    |   |                |                |
| SGABM20-A-C  | SGM, SGI                 | Nylon 6.6                                   | White | Indoor Use         | Rubber Adhesive                         | 100            | 500            |
| SGABM20-AT-C0  |                          | Weather Resistant Nylon 6.6                 | Black | Outdoors/High Temp | Acrylic Adhesive                        | 100            | 500            |
| SGABM20-AV-C300  |                          | Heat Stabilized Weather Resistant Nylon 6.6 | Black | Outdoors/High Temp | High Bond Acrylic Adhesive              | 100            | 500            |
| SGABM25-A-C  | SGM, SGI, SGS            | Nylon 6.6                                   | White | Indoor Use         | Rubber Adhesive                         | 100            | 1000           |
| SGABM25-AT-C0  |                          | Weather Resistant Nylon 6.6                 | Black | Outdoors/High Temp | Acrylic Adhesive                        | 100            | 1000           |
| SGABM25-AV-C300  |                          | Heat Stabilized Weather Resistant Nylon 6.6 | Black | Outdoors/High Temp | High Bond Acrylic Adhesive              | 100            | 1000           |
| SGABM30-A-C  |                          | Nylon 6.6                                   | White | Indoor Use         | Rubber Adhesive                         | 100            | 500            |
| SGABM30-AT-C0  |                          | Weather Resistant Nylon 6.6                 | Black | Outdoors/High Temp | Acrylic Adhesive                        | 100            | 500            |
| SGABM30-AV-C300  |                          | Heat Stabilized Weather Resistant Nylon 6.6 | Black | Outdoors/High Temp | High Bond Acrylic Adhesive              | 100            | 500            |
| SGABM40-A-L  | SGM, SGI, SGS, SGLH, SGH | Nylon 6.6                                   | White | Indoor Use         | Rubber Adhesive                         | 50             | 500            |
| SGABM40-AT-L0  |                          | Weather Resistant Nylon 6.6                 | Black | Outdoors/High Temp | Acrylic Adhesive                        | 50             | 500            |
| SGABM50-A-L  |                          | Nylon 6.6                                   | White | Indoor Use         | Rubber Adhesive                         | 50             | 500            |
| SGABM50-AT-L0  |                          | Weather Resistant Nylon 6.6                 | Black | Outdoors/High Temp | Acrylic Adhesive                        | 50             | 500            |
| <b>Super-Grip™ Mounts for Installation with Screws or User-Supplied Adhesive</b> |                          |   |       |                    |   |                |                |
| SGABM25-S6-C   | SGM, SGI, SGS            | Nylon 6.6                                   | White | Indoors            | #6 (M3) Screw                           | 100            | 1000           |
| SGABM25-S6-C0  |                          | Weather Resistant Nylon 6.6                 | Black | Outdoors           | #6 (M3) Screw or User Supplied Adhesive | 100            | 1000           |

‡Cable tie cross section sizes: SGM = Super-Grip® Miniature, SGI = Super-Grip® Intermediate, SGS = Super-Grip® Standard, SGLH = Super-Grip® Light-Heavy, and SGH = Super-Grip® Heavy.

\*For proper selection of adhesive see page B2.54.



A. System Overview

## Combination Adhesive Mount/Cable Ties

B1. Cable Ties

- Adhesive mount and cable tie molded as one-piece helps reduce inventory costs
- Available with locking or releasable tie
- For indoor use only
- Material: Nylon 6.6

B2. Cable Accessories



B3. Stainless Steel Ties

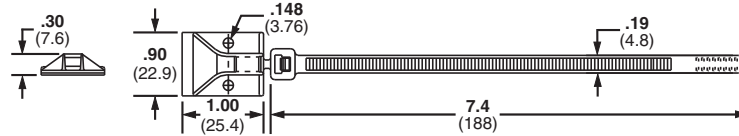

| Part Number                 | Tool  | Color | Adhesive Type | Std. Pkg. Qty. | Std. Ctn. Qty. |
|-----------------------------|---|-------|---------------|----------------|----------------|
| <b>Locking Cable Tie</b>    |   |       |               |                |                |
| <b>PLA2S-A-Q</b>            | GTS, GTSL, GS2B, GS4H, PTS, PTH, PPTS, STS2, STH2 | White | Rubber        | 25             | 250            |
| <b>Releasable Cable Tie</b> |   |       |               |                |                |
| <b>PRA2S-A-Q</b>            | Hand installed only                               | White | Rubber        | 25             | 250            |

C1. Wiring Duct

C2. Surface Raceway

C3. Abrasion Protection

C4. Cable Management

## Snap-In Cable Tie Mounts – Mechanically Applied

D1. Terminals

- For use with Panduit Standard cross section cable ties including PLT1S, PLT1.5S, PLT2S, PRT1.5S and PRT2S
- Integral retaining notch holds cable tie head in place below bundle
- Eliminates protruding tie head and facilitates one hand tie threading
- Quickly route wire and cable where mounting holes cannot be drilled
- For indoor use only
- Material: ABS

D2. Power Connectors

D3. Grounding Connectors



E1. Labeling Systems

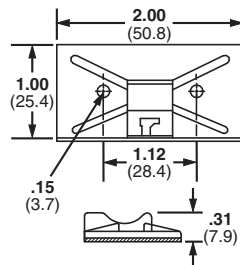

E2. Labels

E3. Pre-Printed & Write-On Markers

E4. Permanent Identification

E5. Lockout/Tagout & Safety Solutions

F. Index

| Part Number   | Used with Cable Ties† | Color | Mounting Method                                | Std. Pkg. Qty. | Std. Ctn. Qty. |
|---|-----------------------|-------|--|----------------|----------------|
| <b>Snap-In Mounts with Pre-Installed Adhesive</b>                           |                       |       |  |                |                |
| <b>SMS-A-C</b>  | S                     | White | Rubber   | 100            | 500            |
| <b>SMS-A-C14</b>  |                       | Gray  | Rubber   | 100            | 500            |
| <b>SMS-A-C15</b>  |                       | Ivory | Rubber   | 100            | 500            |
| <b>Snap-in Mounts for application with screws or user-supplied adhesive</b> |                       |       |  |                |                |
| <b>SMS-S6-D</b>   | S                     | White | User Supplied Adhesive and/or Two #6 M3 Screws | 500            | 5000           |

†Cable tie cross section size: S = Standard.

## Epoxy Applied Mounts

- Provide a fast, strong, economical method to secure wire/cable to most surfaces
- Eliminate the need to drill holes

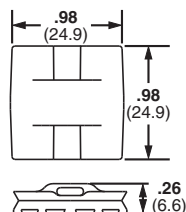

| Part Number | Used with Cable Ties‡ | Material                    | Color   | Environment | Mounting Method | Std. Pkg. Qty. | Std. Ctn. Qty. |
|-------------|-----------------------|-----------------------------|---------|-------------|-----------------|----------------|----------------|
| EMS-A-C     | M, I, S               | Nylon 6.6                   | Natural | Indoors     | EMA epoxy       | 100            | 1000           |
| EMS-A-C0    |                       | Weather Resistant Nylon 6.6 | Black   | Outdoors    |                 |                |                |

‡Cable tie cross section sizes: M = Miniature, I = Intermediate, and S = Standard.

## Epoxy Applied Swivel Mount

- Swivels 360° to assure proper orientation with harness
- For indoor use only
- Four inspection holes to check adhesive coverage

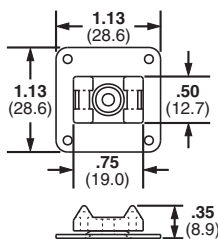

| Part Number | Used with Cable Ties‡ | Mounting Method | Std. Pkg. Qty. | Std. Ctn. Qty. |
|-------------|-----------------------|-----------------|----------------|----------------|
| ASMS-A-X    | M, I, S, SGM, SGI     | EMA Epoxy       | 10             | 100            |

‡Cable tie cross section sizes: M = Miniature, I = Intermediate, S = Standard, SGM = Super-Grip® Miniature, and SGI = Super-Grip® Intermediate.

## Epoxy Applied Cable Tie Mount Kits

- EMA Epoxy supplied in convenient two-compartment mixer cup with a mixer stick for each cup
- Each cup contains adhesive for three EMS or ASMS mounts
- Epoxy hardens in approximately five minutes
- After full 24 hour cure time, bonding strength will exceed 50 lbs. on a clean, grease-free surface
- Not recommended for use on polyethylene and polypropylene surfaces

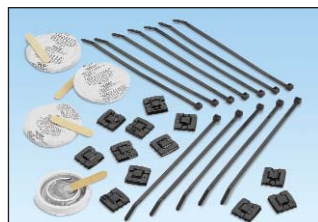

| Part Number  | Used with Cable Ties‡ | Environment      | Epoxy Cups | Mixer Sticks | EMS Mounts | Cable Ties | Std. Pkg. Qty. | Std. Ctn. Qty. |
|--|-----------------------|------------------|------------|--------------|------------|------------|----------------|----------------|
| <b>Epoxy Adhesive Only</b>                               |                       |                  |            |              |            |            |                |                |
| EMA-X  | —                     | Indoors/Outdoors | 10         | 10           | —          | —          | 10             | —              |
| <b>Epoxy Mounting Kit with EMS Mounts</b>                |                       |                  |            |              |            |            |                |                |
| EMSK3-1-X0   | M, I, S               | Indoors/Outdoors | 1          | 1            | 3          | —          | 10             | —              |
| <b>Epoxy Mounting Kit with EMS Mounts and Cable Ties</b> |                       |                  |            |              |            |            |                |                |
| EMSK3-1-3-0  | M, I, S               | Indoors/Outdoors | 1          | 1            | 3          | 3          | 1              | 10             |
| EMSK12-4-12-X0   |                       | Indoors/Outdoors | 4          | 4            | 12         | 12         | 10             | 10             |

‡Cable tie cross section sizes: M = Miniature, I = Intermediate, and S = Standard.

A.  
System  
Overview

## Tie Mounts – Applied with User Supplied Adhesives

B1.  
Cable Ties

- Solid flat bottom surface provides maximum holding area
- For indoor use only
- Material: Nylon 6.6

B2.  
Cable  
Accessories



B3.  
Stainless  
Steel Ties

| Part Number | Used with Cable Ties‡ | Color   | Mounting Method        | Std. Pkg. Qty. | Std. Ctn. Qty. |
|-------------|-----------------------|---------|------------------------|----------------|----------------|
| TM1A-C      | M                     | Natural | User Supplied Adhesive | 100            | 1000           |
| TM2A-C      | M, I, S               |         |                        | 100            | 500            |
| TM3A-C      | M, I, S, HS, LH       |         |                        | 100            | 500            |

‡Cable tie cross section sizes: M = Miniature, I = Intermediate, S = Standard, HS = Heavy Standard and LH = Light-Heavy.

C1.  
Wiring  
Duct

C2.  
Surface  
Raceway

## Low Profile Tie Mounts – User Supplied Adhesive Mounts

C3.  
Abrasion  
Protection

- Low profile design keeps bundle close to mounting surface
- For indoor use only
- Material: Nylon 6.6

C4.  
Cable  
Management



D1.  
Terminals

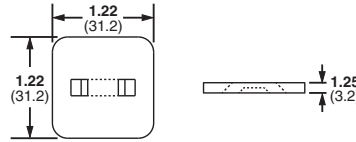

D2.  
Power  
Connectors

| Part Number | Used with Cable Ties‡ | Color   | Mounting Method        | Std. Pkg. Qty. | Std. Ctn. Qty. |
|-------------|-----------------------|---------|------------------------|----------------|----------------|
| AM2-C       | M, I, S               | Natural | User Supplied Adhesive | 100            | 500            |

‡Cable tie cross section sizes: M = Miniature, I = Intermediate, and S = Standard.

D3.  
Grounding  
Connectors

E1.  
Labeling  
Systems

E2.  
Labels

E3.  
Pre-Printed  
& Write-On  
Markers

E4.  
Permanent  
Identification

E5.  
Lockout/  
Tagout  
& Safety  
Solutions

F.  
Index

## Cable Tie Mounts – Screw Applied

- Unique cradle design provides maximum stability for the cable bundle
- Low profile design keeps bundle close to mounting surface

- Wide selection of materials available
- UL Recognized except HVTM and SGTM series

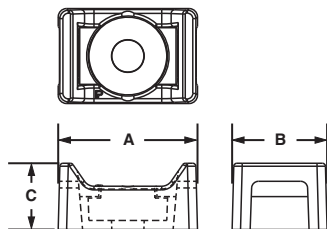

| Part Number | Used with Cable Ties† | Counterbore Diameter |     | Length A |      | Width B |      | Height C |     | Mounting Method | Std. Pkg. Qty. | Std. Ctn. Qty. |
|-------------|-----------------------|----------------------|-----|----------|------|---------|------|----------|-----|-----------------|----------------|----------------|
|             |                       | In.                  | mm  | In.      | mm   | In.     | mm   | In.      | mm  |                 |                |                |
| TM1S4-C     | M                     | 0.23                 | 5.7 | 0.51     | 13.0 | 0.32    | 8.0  | 0.23     | 5.8 | #4 (M2.5) Screw | 100            | 500            |
| TM1S6-C     |                       | 0.28                 | 7.0 | 0.51     | 13.0 | 0.32    | 8.0  | 0.23     | 5.8 | #6 (M3) Screw   | 100            | 500            |
| TM2S6-C     | M, I, S               | 0.29                 | 7.1 | 0.63     | 16.0 | 0.43    | 10.8 | 0.28     | 7.0 | #6 (M3) Screw   | 100            | 500            |
| TM2S8-C     |                       | 0.33                 | 8.4 | 0.63     | 16.0 | 0.43    | 10.8 | 0.28     | 7.0 | #8 (M4) Screw   | 100            | 500            |
| TM3S8-C     | M, I, S, LH           | 0.32                 | 8.1 | 0.86     | 21.9 | 0.61    | 15.5 | 0.37     | 9.4 | #8 (M4) Screw   | 100            | 500            |
| TM3S10-C    |                       | 0.38                 | 9.7 | 0.86     | 21.9 | 0.61    | 15.8 | 0.37     | 9.4 | #10 (M5) Screw  | 100            | 500            |

### Super-Grip® Cable Tie Mounts

|             |                     |      |     |      |      |      |      |      |      |                |     |     |
|-------------|---------------------|------|-----|------|------|------|------|------|------|----------------|-----|-----|
| SGTM1S6-C   | SGM                 | 0.28 | 7.0 | 0.51 | 13.0 | 0.38 | 9.7  | 0.22 | 5.6  | #6 (M3) Screw  | 100 | 500 |
| SGTM1S6-C0  | SGM                 | 0.28 | 7.0 | 0.51 | 13.0 | 0.38 | 9.7  | 0.22 | 5.6  | #6 (M3) Screw  | 100 | 500 |
| SGTM2S8-C   | SGM, SGI, SGS       | 0.33 | 8.4 | 0.66 | 16.7 | 0.48 | 12.2 | 0.34 | 7.0  | #8 (M4) Screw  | 100 | 500 |
| SGTM2S8-C0  | SGM, SGI, SGS       | 0.33 | 8.4 | 0.66 | 16.7 | 0.48 | 12.2 | 0.34 | 8.6  | #8 (M4) Screw  | 100 | 500 |
| SGTM3S10-C  | SGM, SGI, SGS, SGLH | 0.38 | 9.7 | 0.91 | 23.1 | 0.61 | 15.4 | 0.43 | 11.0 | #10 (M5) Screw | 100 | 500 |
| SGTM3S10-C0 | SGM, SGI, SGS, SGLH | 0.38 | 9.7 | 0.91 | 23.1 | 0.61 | 15.4 | 0.43 | 11.0 | #10 (M5) Screw | 100 | 500 |

### Hyper-V™ Cable Tie Mounts

|            |    |      |      |      |      |      |      |      |      |                 |     |     |
|------------|----|------|------|------|------|------|------|------|------|-----------------|-----|-----|
| HVTM-06-C0 | HV | 0.40 | 10.2 | 0.81 | 20.6 | 0.68 | 17.3 | 0.41 | 10.4 | #10 (6mm) Screw | 100 | 500 |
|------------|----|------|------|------|------|------|------|------|------|-----------------|-----|-----|

†Cable tie cross section sizes: M = Miniature, I = Intermediate, S = Standard, LH = Light-Heavy, SGM = Super-Grip® Miniature, SGI = Super-Grip® Intermediate, SGS = Super-Grip® Standard, SGLH = Super-Grip® Light-Heavy, and HV = Hyper-V™.

### Additional tie mounts available in specified materials. All are available as standard Panduit parts.

| Metal Detectable Nylon | Metal Detectable Polypropylene | PEEK        | Heat Stabilized Nylon | Flame Retardant Nylon | Weather Resistant Nylon | Weather Resistant Polypropylene | Tefzel®    |
|------------------------|--------------------------------|-------------|-----------------------|-----------------------|-------------------------|---------------------------------|------------|
| TMS28-C86              | TMS28-C186                     | TM2S8-C71   | TM1S4-M30             | TM1S4-M69             | TM1S6-M0                | TM2S8-C100                      | TM2S8-C76  |
| TM3S8-C86              | TM3S8-C186                     | <b>NEW!</b> | TM1S6-M30             | TM1S6-M69             | TM2R6-M0                | TM3S8-C100                      | TM3S8-C76  |
| TM3S10-C86             | TM3S10-C186                    | <b>NEW!</b> | TM2R6-M30             | TM2S6-M69             | TM2S6-M0                | TM3S8-M100                      | TM3S10-C76 |
|                        |                                |             | TM2S6-M30             | TM2S8-M69             | TM2S8-M0                |                                 |            |
|                        |                                |             | TM2S8-M30             | TM3S8-C69             | TM3R6-M0                |                                 |            |
|                        |                                |             | TM3S8-M30             | TM3S8-M69             | TM3S10-M0               |                                 |            |
|                        |                                |             | TM3S10-M30            | TM3S10-M69            | TM3S25-M0               |                                 |            |
|                        |                                |             | TM3S25-M30            |                       |                         |                                 |            |

®TEFZEL is a registered trademark of E.I. du Pont de Nemours and Company.

A.  
System  
Overview

B1.  
Cable  
Ties

B2.  
Cable  
Accessories

B3.  
Stainless  
Steel  
Ties

C1.  
Wiring  
Duct

C2.  
Surface  
Raceway

C3.  
Abrasion  
Protection

C4.  
Cable  
Management

D1.  
Terminals

D2.  
Power  
Connectors

D3.  
Grounding  
Connectors

E1.  
Labeling  
Systems

E2.  
Labels

E3.  
Pre-Printed  
& Write-On  
Markers

E4.  
Permanent  
Identification

E5.  
Lockout/  
Tagout  
& Safety  
Solutions

F.  
Index

A. System Overview

## Extra-Heavy Cable Tie Mounts – Screw Applied

- Unique cradle design provides maximum stability for cable bundle
- Route and support large diameter and heavy cable bundles

B1. Cable Ties

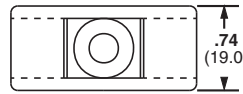
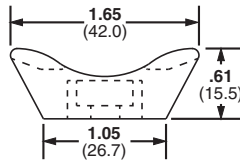

B2. Cable Accessories

B3. Stainless Steel Ties

| Part Number          | Used with Cable Ties‡       | Material                        | Color | Environment | Mounting Method | Std. Pkg. Qty. | Std. Ctn. Qty. |
|----------------------|-----------------------------|---------------------------------|-------|-------------|-----------------|----------------|----------------|
| <b>TMEH-S8-Q0</b>    | M, I, S, HS, LH, H, EH, HLM | Weather Resistant Nylon 6.6     | Black | Outdoors    | #8 (M4) Screw   | 25             | 250            |
| <b>TMEH-S10-Q0</b>   |                             |                                 |       |             | #10 (M5) Screw  | 25             | 250            |
| <b>TMEH-S25-Q0</b>   |                             |                                 |       |             | 1/4 (M6) Screw  | 25             | 250            |
| <b>TMEH-S10-C100</b> |                             | Weather Resistant Polypropylene | Green | Indoors     | #10 (M5) Screw  | 100            | 500            |
| <b>TMEH-S10-C109</b> | Polypropylene               | #10 (M5) Screw                  |       |             | 100             | 500            |                |

‡Cable tie cross section sizes: M = Miniature, I = Intermediate, S = Standard, HS = Heavy-Standard, LH = Light-Heavy, H = Heavy, EH = Extra-Heavy and HLM = Miniature Tak-Ty® Hook & Loop Ties.

C1. Wiring Duct

C2. Surface Raceway

C3. Abrasion Protection

C4. Cable Management

## Swivel Mounts

- The two mounts are securely fastened together with a connecting rivet that allows both mounts to rotate
- Separates bundles to avoid abrasion
- Material: Weather Resistant Nylon 6.6
- Can join bundles of cable, tubing, or hoses that may need to move or are not parallel

D1. Terminals

D2. Power Connectors

D3. Grounding Connectors

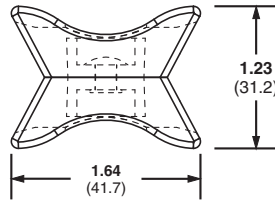

TMEH

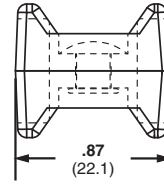
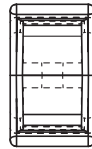

TM3

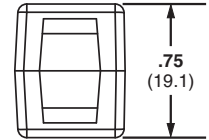

E1. Labeling Systems

E2. Labels

| Part Number        | Used with Cable Ties‡       | Pull Apart Force |         | Color | Environment      | Std. Pkg. Qty. | Std. Ctn. Qty. |
|--------------------|-----------------------------|------------------|---------|-------|------------------|----------------|----------------|
|                    |                             | Lbs.             | g       |       |                  |                |                |
| <b>TM3-X2-C0Y</b>  | M, I, S, HS, LH             | 120              | 54,431  | Black | Indoors/Outdoors | 100            | 1000           |
| <b>TMEH-X2-L0Y</b> | M, I, S, HS, LH, H, EH, HLM | 250              | 113,398 |       |                  | 50             | 500            |

‡Cable tie cross section sizes: M = Miniature, I = Intermediate, S = Standard, HS = Heavy-Standard, LH = Light-Heavy, H = Heavy, EH = Extra-Heavy and HLM = Miniature Tak-Ty® Hook & Loop Ties.

E3. Pre-Printed & Write-On Markers

E4. Permanent Identification

E5. Lockout/Tagout & Safety Solutions

F. Index

## 4-Way Tie Anchor Mounts – Screw Applied

- 4-way cable tie entry makes part orientation fast and easy
- Small overall size allows for use where space is limited

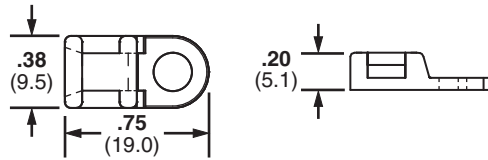
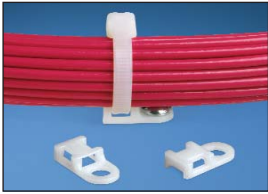

| Part Number      | Used With Cable Ties‡ | Hole Diameter |     | Material                    | Color   | Environment | Mounting Method | Std. Pkg. Qty. | Std. Ctn. Qty. |
|------------------|-----------------------|---------------|-----|-----------------------------|---------|-------------|-----------------|----------------|----------------|
|                  |                       | In.           | mm  |                             |         |             |                 |                |                |
| <b>TA1S8-C</b>   | M, I, S               | 0.17          | 4.3 | Nylon 6.6                   | Natural | Indoors     | #8 (M4) Screw   | 100            | 500            |
| <b>TA1S8-M0</b>  |                       | 0.17          | 4.3 | Weather Resistant Nylon 6.6 | Black   | Outdoors    | #8 (M4) Screw   | 1000           | 5000           |
| <b>TA1S8-M30</b> |                       | 0.17          | 4.3 | Heat Stabilized Nylon 6.6   | Black   | Indoors     | #8 (M4) Screw   | 1000           | 5000           |
| <b>TA1S8-M69</b> |                       | 0.17          | 4.3 | Flame Retardant Nylon 6.6   | Natural | Indoors     | #8 (M4) Screw   | 1000           | 5000           |
| <b>TA1S10-C</b>  |                       | 0.17          | 4.3 | Nylon 6.6                   | Natural | Indoors     | #10 (M5) Screw  | 100            | 500            |
| <b>TA1S10-M0</b> |                       | 0.20          | 5.1 | Weather Resistant Nylon 6.6 | Black   | Outdoors    | #10 (M5) Screw  | 1000           | 5000           |

### Super-Grip® Cable Tie Mounts

|                  |             |      |     |           |         |         |               |     |     |
|------------------|-------------|------|-----|-----------|---------|---------|---------------|-----|-----|
| <b>SGTA1S8-C</b> | SGM,SGI,SGS | 0.17 | 4.3 | Nylon 6.6 | Natural | Indoors | #8 (M4) Screw | 100 | 500 |
|------------------|-------------|------|-----|-----------|---------|---------|---------------|-----|-----|

‡Cable tie cross section sizes: M = Miniature, I = Intermediate, S = Standard, SGM = Super-Grip® Miniature, SGI = Super-Grip® Intermediate, and SGS = Super-Grip® Standard.

## Tie Anchor Mounts – Screw Applied

- Install perpendicular to the wire bundle
- Elongated slot permits cable bundle adjustment in application
- Low profile design keeps bundle close to mounting surface where overhead space is limited
- Material: Nylon 6.6

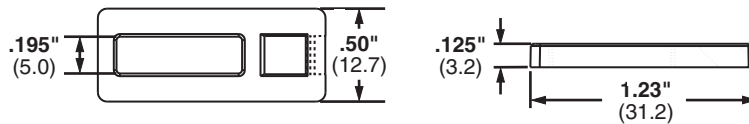
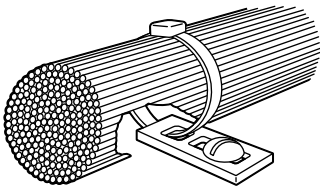

| Part Number  | Used with Cable Ties‡ | Color   | Environment | Mounting Method | Std. Pkg. Qty. | Std. Ctn. Qty. |
|--------------|-----------------------|---------|-------------|-----------------|----------------|----------------|
| <b>TA2-C</b> | M, I, S               | Natural | Indoors     | #10 (M5) Screw  | 100            | 1000           |
| <b>TA2-M</b> |                       |         |             |                 | 1000           | 5000           |

‡Cable tie cross section sizes: M = Miniature, I = Intermediate, and S = Standard.

A.  
System  
Overview

B1.  
Cable Ties

B2.  
Cable  
Accessories

B3.  
Stainless  
Steel Ties

C1.  
Wiring  
Duct

C2.  
Surface  
Raceway

C3.  
Abrasion  
Protection

C4.  
Cable  
Management

D1.  
Terminals

D2.  
Power  
Connectors

D3.  
Grounding  
Connectors

E1.  
Labeling  
Systems

E2.  
Labels

E3.  
Pre-Printed  
& Write-On  
Markers

E4.  
Permanent  
Identification

E5.  
Lockout/  
Tagout  
& Safety  
Solutions

F.  
Index



A. System Overview

## Low Profile Mounts – Screw Applied

- Low profile design keeps bundle close to mounting surface
- Small overall size
- Install with a screw or rivet for a strong, secure installation
- For indoor use only
- Material: Nylon 6.6

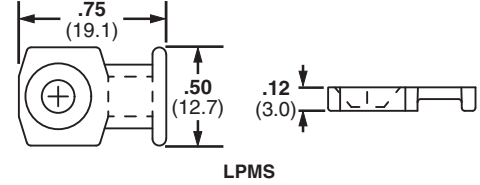
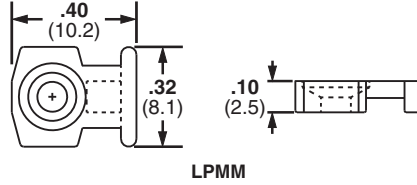

| Part Number      | Used with Cable Ties‡ | Color   | Mounting Method           | Std. Pkg. Qty. | Std. Ctn. Qty. |
|------------------|-----------------------|---------|---------------------------|----------------|----------------|
| <b>LPMM-S2-C</b> | M                     | Natural | #2 (M2) Countersunk Screw | 100            | 1000           |
| <b>LPMM-S5-C</b> | M                     |         | #5 (M3) Countersunk Screw | 100            | 1000           |
| <b>LPMS-S8-C</b> | M, I, S               |         | #8 (M4) Countersunk Screw | 100            | 1000           |

‡Cable tie cross section sizes: M = Miniature, I = Intermediate, and S = Standard.

C1. Wiring Duct

C2. Surface Raceway

C3. Abrasion Protection

C4. Cable Management

D1. Terminals

D2. Power Connectors

D3. Grounding Connectors

E1. Labeling Systems

E2. Labels

E3. Pre-Printed & Write-On Markers

E4. Permanent Identification

E5. Lockout/Tagout & Safety Solutions

F. Index

## Low Profile Mounts – Push Rivet Applied

- Eliminate screws
- Secure wires to any pre-drilled panel
- Can be installed in any panel thickness
- Low profile design keeps bundle close to mounting surface
- For indoor use only
- Material: Nylon 6.6

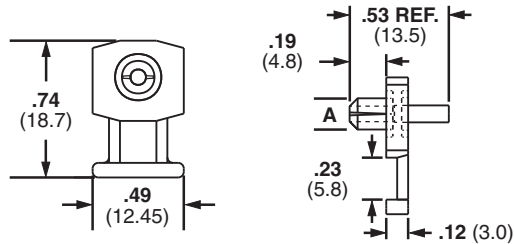
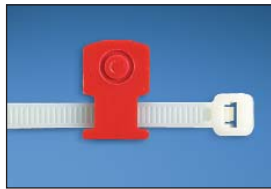

| Part Number         | Used with Cable Ties‡ | Hole Diameter A |     | Color  | Mounting Method     | Std. Pkg. Qty. | Std. Ctn. Qty. |
|---------------------|-----------------------|-----------------|-----|--------|---------------------|----------------|----------------|
|                     |                       | In.             | mm  |        |                     |                |                |
| <b>KIMS-H366-C2</b> | M, I, S               | .144            | 3.7 | Red    | Integral Push Rivet | 100            | 1000           |
| <b>KIMS-H430-C6</b> |                       | .169            | 4.3 | Blue   | Integral Push Rivet | 100            | 1000           |
| <b>KIMS-H500-C4</b> |                       | .196            | 5.0 | Yellow | Integral Push Rivet | 100            | 1000           |

‡Cable tie cross section sizes: M = Miniature, I = Intermediate, and S = Standard.

## Cable Tie Plates

- Slotted mounting hole accommodates various fastener spacing
- Low profile design keeps bundle close to mounting surface
- For indoor use only
- Material: Nylon 6.6

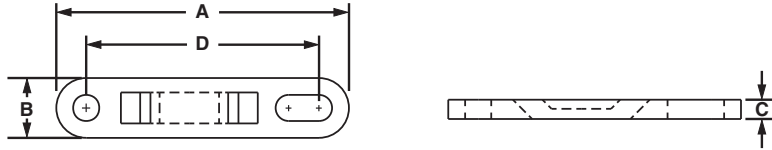
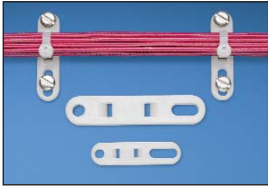

| Part Number | Used with Cable Ties‡ | Length A |      | Width B |      | Height C |     | Hole Spacing D |      | Color   | Mounting Method | Std. Pkg. Qty. | Std. Ctn. Qty. |
|-------------|-----------------------|----------|------|---------|------|----------|-----|----------------|------|---------|-----------------|----------------|----------------|
|             |                       | In.      | mm   | In.     | mm   | In.      | mm  | In.            | mm   |         |                 |                |                |
| TP2-C       | M, I, S               | 1.98     | 50.3 | .50     | 12.7 | .13      | 3.2 | 1.60           | 40.6 | Natural | #10 (M5) Screw  | 100            | 1000           |
| TP4H-C      | M, I, S, HS, LH, H    | 3.08     | 78.2 | .62     | 15.7 | .20      | 5.2 | 2.50           | 63.5 | Natural | 1/4 (M6) Screw  | 100            | 1000           |

‡Cable tie cross section sizes: M = Miniature, I = Intermediate, S = Standard, HS = Heavy-Standard, LH = Light-Heavy and H = Heavy.

## Multiple Tie Plates

- Used to secure closely spaced wire bundles
- Low profile design keeps bundle close to mounting surface
- For indoor use only
- Material: Nylon 6.6

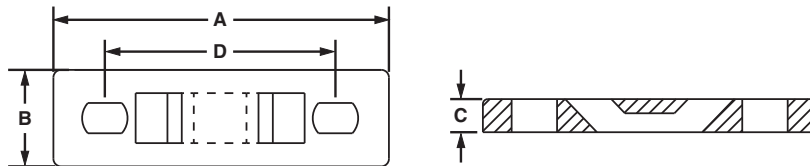

| Part Number | No. of Bundles | Used with Cable Ties‡ | Length A |      | Width B |      | Height C |     | Hole Spacing D |      | Mounting Method | Mil. Std. Part Number | Std. Pkg. Qty. | Std. Ctn. Qty. |
|-------------|----------------|-----------------------|----------|------|---------|------|----------|-----|----------------|------|-----------------|-----------------------|----------------|----------------|
|             |                |                       | In.      | mm   | In.     | mm   | In.      | mm  | In.            | mm   |                 |                       |                |                |
| MTP1S-E6-C  | 1              | M, I, S               | 1.75     | 44.5 | .50     | 12.7 | .13      | 3.2 | 1.25           | 31.8 | #6 (M3) Screw   | MS3339-1-9            | 100            | 1000           |
| MTP1S-E10-C |                |                       | 1.75     | 44.5 | .50     | 12.7 | .13      | 3.2 | 1.25           | 31.8 | #10 (M5) Screw  | —                     | 100            | 1000           |
| MTP1H-E6-C  |                | M, I, S, HS, LH, H    | 2.09     | 53.1 | .63     | 16.0 | .20      | 5.2 | 1.50           | 38.1 | #6 (M3) Screw   | MS3339-6-9            | 100            | 1000           |
| MTP1H-E10-C |                |                       | 2.09     | 53.1 | .63     | 16.0 | .20      | 5.2 | 1.50           | 38.1 | #10 (M5) Screw  | —                     | 100            | 1000           |
| MTP2S-E6-C  | 2              | M, I, S               | 3.00     | 76.2 | .50     | 12.7 | .13      | 3.2 | 2.50           | 63.5 | #6 (M3) Screw   | MS3339-2-9            | 100            | 1000           |
| MTP2S-E10-C |                |                       | 3.00     | 76.2 | .50     | 12.7 | .13      | 3.2 | 2.50           | 63.5 | #10 (M5) Screw  | —                     | 100            | 1000           |
| MTP2H-E6-C  |                | M, I, S, HS, LH, H    | 3.59     | 91.2 | .63     | 16.0 | .20      | 5.2 | 3.00           | 76.2 | #6 (M3) Screw   | MS3339-7-9            | 100            | 1000           |
| MTP2H-E10-C |                |                       | 3.59     | 91.2 | .63     | 16.0 | .20      | 5.2 | 3.00           | 76.2 | #10 (M5) Screw  | —                     | 100            | 1000           |

‡Cable tie cross section sizes: M = Miniature, I = Intermediate, S = Standard, HS = Heavy-Standard, LH = Light-Heavy and H = Heavy.

Table continues on page B2.16

A. System Overview

## Multiple Tie Plates (continued)

B1. Cable Ties

B2. Cable Accessories

B3. Stainless Steel Ties

C1. Wiring Duct

C2. Surface Raceway

C3. Abrasion Protection

C4. Cable Management

D1. Terminals

D2. Power Connectors

D3. Grounding Connectors

E1. Labeling Systems

E2. Labels

E3. Pre-Printed & Write-On Markers

E4. Permanent Identification

E5. Lockout/Tagout & Safety Solutions

F. Index

| Part Number | No. of Bundles | Used with Cable Ties‡ | Length A |       | Width B |      | Height C |     | Hole Spacing D |       | Mounting Method | Mil. Std. Part Number | Std. Pkg. Qty. | Std. Ctn. Qty. |
|-------------|----------------|-----------------------|----------|-------|---------|------|----------|-----|----------------|-------|-----------------|-----------------------|----------------|----------------|
|             |                |                       | In.      | mm    | In.     | mm   | In.      | mm  | In.            | mm    |                 |                       |                |                |
| MTP3S-E6-C  | 3              | M, I, S               | 4.25     | 108.0 | .50     | 12.7 | .13      | 3.2 | 3.75           | 95.3  | #6 (M3) Screw   | MS3339-3-9            | 100            | 1000           |
| MTP3S-E10-C |                |                       | 4.25     | 108.0 | .50     | 12.7 | .13      | 3.2 | 3.75           | 95.3  | #10 (M5) Screw  | —                     | 100            | 1000           |
| MTP3H-E6-C  |                | M, I, S, HS, LH, H    | 5.09     | 129.3 | .63     | 16.0 | .20      | 5.2 | 4.50           | 114.3 | #6 (M3) Screw   | MS339-8-9             | 100            | 1000           |
| MTP3H-E10-C |                |                       | 5.09     | 129.3 | .63     | 16.0 | .20      | 5.2 | 4.50           | 114.3 | #10 (M5) Screw  | —                     | 100            | 1000           |
| MTP4S-E6-C  | 4              | M, I, S               | 5.50     | 139.7 | .50     | 12.7 | .13      | 3.2 | 5.00           | 127.0 | #6 (M3) Screw   | MS3339-4-9            | 100            | 1000           |
| MTP4S-E10-C |                |                       | 5.50     | 139.7 | .50     | 12.7 | .13      | 3.2 | 5.00           | 127.0 | #10 (M5) Screw  | —                     | 100            | 1000           |
| MTP4H-E6-C  |                | M, I, S, HS, LH, H    | 6.59     | 167.4 | .63     | 15.7 | .20      | 5.2 | 6.00           | 152.4 | #6 (M3) Screw   | MS3339-9-9            | 100            | 1000           |
| MTP4H-E10-C |                |                       | 6.59     | 167.4 | .63     | 15.7 | .20      | 5.2 | 6.00           | 152.4 | #10 (M5) Screw  | —                     | 100            | 1000           |
| MTP5S-E6-C  | 5              | M, I, S               | 6.75     | 171.5 | .50     | 12.7 | .13      | 3.2 | 6.25           | 158.8 | #6 (M3) Screw   | MS3339-5-9            | 100            | 1000           |
| MTP5S-E10-C |                |                       | 6.75     | 171.5 | .50     | 12.7 | .13      | 3.2 | 6.25           | 158.8 | #10 (M5) Screw  | —                     | 100            | 1000           |
| MTP5H-E6-C  |                | M, I, S, HS, LH, H    | 8.09     | 205.5 | .63     | 16.0 | .20      | 5.2 | 7.50           | 190.5 | #6 (M3) Screw   | MS3339-10-9           | 100            | 1000           |
| MTP5H-E10-C |                |                       | 8.09     | 205.5 | .63     | 16.0 | .20      | 5.2 | 7.50           | 190.5 | #10 (M5) Screw  | —                     | 100            | 1000           |
| MTP6H-E6-C  | 6              | M, I, S, HS, LH, H    | 9.59     | 243.6 | .63     | 16.0 | .20      | 5.2 | 9.00           | 228.6 | #6 (M3) Screw   | MS3339-11-9           | 100            | 1000           |
| MTP6H-E10-C |                |                       | 9.59     | 243.6 | .63     | 16.0 | .20      | 5.2 | 9.00           | 228.6 | #10 (M5) Screw  | —                     | 100            | 1000           |

‡Cable tie cross section sizes: M = Miniature, I = Intermediate, S = Standard, HS = Heavy-Standard, LH = Light-Heavy and H = Heavy.

## Contour Multiple Tie Plates

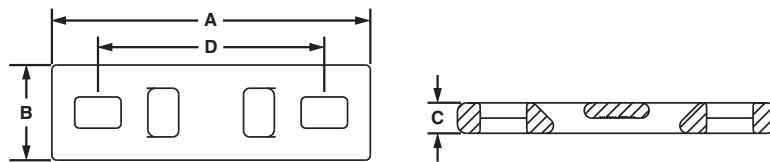

| Part Number    | No. of Bundles | Used with Cable Ties‡ | Length A |       | Width B |      | Height C |     | Hole Spacing D |       | Mounting Method | Mil. Std. Part Number | Std. Pkg. Qty. | Std. Ctn. Qty. |
|----------------|----------------|-----------------------|----------|-------|---------|------|----------|-----|----------------|-------|-----------------|-----------------------|----------------|----------------|
|                |                |                       | In.      | mm    | In.     | mm   | In.      | mm  | In.            | mm    |                 |                       |                |                |
| MTPC1H-E10-C39 | 1              | M, I, S, HS, LH, H    | 2.09     | 53.1  | .63     | 16.0 | .20      | 5.2 | 1.5            | 38.1  | #10 (M5) Screw  | —                     | 100            | 1000           |
| MTPC2H-E10-C39 | 2              |                       | 3.59     | 91.2  | .63     | 16.0 | .20      | 5.2 | 3.0            | 6.2   | #10 (M5) Screw  | —                     | 100            | 1000           |
| MTPC3H-E10-C39 | 3              |                       | 5.09     | 129.3 | .63     | 16.0 | .20      | 5.2 | 4.50           | 114.3 | #10 (M5) Screw  | —                     | 100            | 1000           |
| MTPC4H-E10-C39 | 4              |                       | 6.59     | 167.4 | .63     | 15.7 | .20      | 5.2 | 6.00           | 152.4 | #10 (M5) Screw  | —                     | 100            | 1000           |
| MTPC5H-E10-C39 | 5              |                       | 8.09     | 205.5 | .63     | 16.0 | .20      | 5.2 | 7.50           | 190.5 | #10 (M5) Screw  | —                     | 100            | 1000           |
| MTPC6H-E10-C39 | 6              |                       | 9.59     | 243.6 | .63     | 16.0 | .20      | 5.2 | 9.00           | 228.6 | #10 (M5) Screw  | —                     | 100            | 1000           |

‡Cable tie cross section sizes: M = Miniature, I = Intermediate, S = Standard, HS = Heavy-Standard, LH = Light-Heavy and H = Heavy.

## Right Angle Mounts

- Hold cable bundles away from the sharp edges of bulkheads or cabinet holes
- Can also be used to mount cable bundles adjacent to any surface
- For indoor use only
- Material: Nylon 6.6

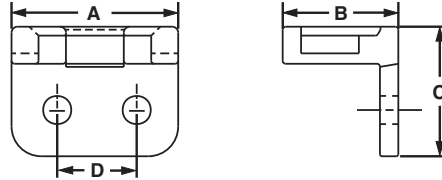

| Part Number | Used with Cable Ties‡ | Length A |      | Width B |      | Height C |      | Hole Spacing D |      | Color   | Mil. Std. Part Number | Mounting Method                     | Std. Pkg. Qty. | Std. Ctn. Qty. |
|-------------|-----------------------|----------|------|---------|------|----------|------|----------------|------|---------|-----------------------|-------------------------------------|----------------|----------------|
|             |                       | In.      | mm   | In.     | mm   | In.      | mm   | In.            | mm   |         |                       |                                     |                |                |
| RAMS-S3-M   | M, I, S               | .56      | 14.2 | .39     | 9.9  | .44      | 11.0 | .28            | 7.1  | Natural | MS3341-2-9            | #3 (M2.5) Screw or 3/32 (2.4) Rivet | 1000           | 5000           |
| RAMH-S6-D   | M, I, S, HS, LH, H    | 1.00     | 25.4 | .75     | 19.1 | 1.00     | 25.4 | .28            | 7.1  |         | MS3341-1-9            | #6 (M3) Screw or 1/8 (3.2) Rivet    | 500            | 5000           |
| RAMH-S10-D  | M, I, S, HS, LH, H    | 1.00     | 25.4 | .75     | 19.1 | 1.00     | 25.4 | .50            | 12.7 |         | —                     | #10 (M5) Screw or 3/16 (4.7) Rivet  | 500            | 5000           |

‡Cable tie cross section sizes: M = Miniature, I = Intermediate, S = Standard, HS = Heavy Standard, LH = Light-Heavy and H = Heavy.

## Lightening Hole Mounts

- Secure cable bundles that run through bulkhead lightening holes
- Protect cable bundles from sharp edges
- For indoor use only
- Material: Nylon 6.6

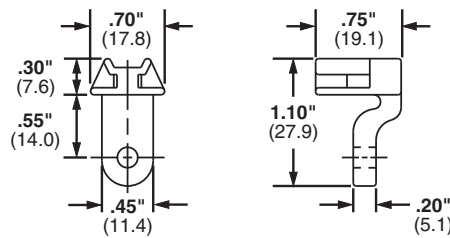

| Part Number | Used with Cable Ties‡ | Color   | Mil. Std. Part Number | Mounting Method                    | Std. Pkg. Qty. | Std. Ctn. Qty. |
|-------------|-----------------------|---------|-----------------------|------------------------------------|----------------|----------------|
| LHMS-S5-D   | M, I, S               | Natural | —                     | #5 (M3) Screw or 1/8 (3.2) Rivet   | 500            | 2500           |
| LHMS-S6-D   |                       |         | MS3340-1-9            | #6 (M3) Screw or 9/64 (3.5) Rivet  | 500            | 2500           |
| LHMS-S10-D  |                       |         | —                     | #10 (M5) Screw or 3/16 (4.7) Rivet | 500            | 2500           |

‡Cable tie cross section sizes: M = Miniature, I = Intermediate, and S = Standard.

A. System Overview

## Stud Tie Mounts

B1. Cable Ties

- Easily applied to bolts or studs with a light hammer blow or turning of the mount
- Material: Impact Modified Weather Resistant Nylon 6.6
- Designed for use with cable ties to route and secure cable bundles, air, water and hydraulic lines

B2. Cable Accessories



B3. Stainless Steel Ties

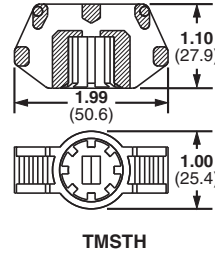
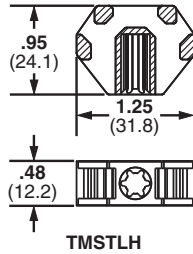

C1. Wiring Duct

C2. Surface Raceway

C3. Abrasion Protection

C4. Cable Management

| Part Number | Used with Cable Ties‡ | Color | Environment | Mounting Method        | Std. Pkg. Qty. | Std. Ctn. Qty. |
|-------------|-----------------------|-------|-------------|------------------------|----------------|----------------|
| TMSTLHS6-M0 | M, I, S, HS, LH       | Black | Outdoors    | 1/4" stud dia. (6mm)   | 1000           | 5000           |
| TMSTLHS8-M0 | M, I, S, HS, LH       |       |             | 5/16" stud dia. (8mm)  | 1000           | 5000           |
| TMSTHS10-D0 | M, I, S, HS, LH, H    |       |             | 3/8" stud dia. (10mm)  | 500            | —              |
| TMSTHS11-D0 | M, I, S, HS, LH, H    |       |             | 7/16" stud dia. (11mm) | 500            | —              |
| TMSTHS12-D0 | M, I, S, HS, LH, H    |       |             | 12mm stud dia.         | 500            | —              |
| TMSTHS13-D0 | M, I, S, HS, LH, H    |       |             | 1/2" stud dia. (13mm)  | 500            | —              |
| TMSTHS16-D0 | M, I, S, HS, LH, H    |       |             | 5/8" stud dia. (16mm)  | 500            | —              |
| TMSTHS19-D0 | M, I, S, HS, LH, H    |       |             | 3/4" stud dia. (19mm)  | 500            | —              |

‡Cable tie cross section sizes: M = Miniature, I = Intermediate, S = Standard, HS = Heavy-Standard, LH = Light-Heavy and H = Heavy.

D1. Terminals

## Metal Clip-On Mounts

D2. Power Connectors

- Clips on sheet metal edges for fast mounting of harness with cable ties
- For indoor use only
- Material: Zinc plated steel
- Allows cable tie entry from all four sides for easy harness orientation

D3. Grounding Connectors

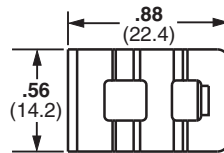

E1. Labeling Systems

E2. Labels

E3. Pre-Printed & Write-On Markers

E4. Permanent Identification

E5. Lockout/Tagout & Safety Solutions

F. Index

| Part Number | Used with Cable Ties‡ | Height A |      | Max. Panel Thickness |     | Mounting Method | Std. Pkg. Qty. | Std. Ctn. Qty. |
|-------------|-----------------------|----------|------|----------------------|-----|-----------------|----------------|----------------|
|             |                       | In.      | mm   | In.                  | mm  |                 |                |                |
| MCMS12-P-C  | M, I, S               | .31      | 8.0  | .13                  | 3.2 | Clip-On         | 100            | 500            |
| MCMS25-P-C  |                       | .46      | 11.5 | .24                  | 6.1 |                 | 100            | 500            |
| MCMS30-P-C  |                       | .55      | 14.0 | .27                  | 6.9 |                 | 100            | 500            |

‡Cable Tie Cross Section Sizes: M = Miniature, I = Intermediate, and S = Standard.

## Metal Screw-On Mount

- Screw applied aluminum mounting base for a secure support in demanding applications

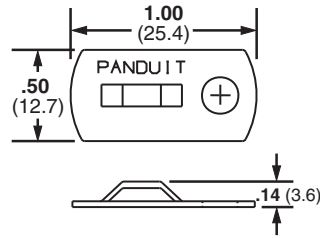

| Part Number | Used with Cable Ties‡ | Material | Environment      | Mounting Method | Max. Static Load |      | Std. Pkg. Qty. | Std. Ctn. Qty. |
|-------------|-----------------------|----------|------------------|-----------------|------------------|------|----------------|----------------|
|             |                       |          |                  |                 | Lbs.             | g    |                |                |
| MBMS-S10-CY | M, I, S               | Aluminum | Indoors/Outdoors | #10 (M5) Screw  | 10.00            | 4540 | 100            | 1000           |

‡Cable Tie Cross Section Sizes: M = Miniature, I = Intermediate, and S = Standard.

## Push Barb Cable Tie Mounts

- Wing provides added stability
- Requires no adhesive or additional mounting hardware
- Can be used where only one side of the panel is accessible

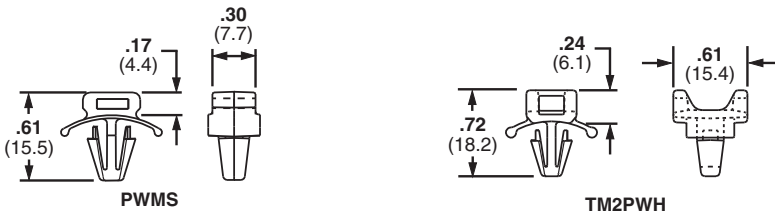

| Part Number | Used with Cable Ties‡ | Max. Panel Thickness |     | Panel Hole Diameter |     | Material                    | Color   | Environment | Mounting Method | Std. Pkg. Qty. | Std. Ctn. Qty. |
|-------------|-----------------------|----------------------|-----|---------------------|-----|-----------------------------|---------|-------------|-----------------|----------------|----------------|
|             |                       | In.                  | mm  | In.                 | mm  |                             |         |             |                 |                |                |
| PWMS-H25-C  | M, I, S               | .11                  | 2.7 | .25                 | 6.5 | Nylon 6.6                   | Natural | Indoors     | Push Barb       | 100            | 1000           |
| PWMS-H25-M0 |                       | .11                  | 2.7 | .25                 | 6.5 | Weather Resistant Nylon 6.6 | Black   | Outdoors    | Push Barb       | 1000           | 5000           |
| TM2PWH25-C  |                       | .10                  | 2.3 | .25                 | 6.5 | Nylon 6.6                   | Natural | Indoors     | Push Barb       | 100            | 500            |

‡Cable tie cross section Sizes: M = Miniature, I = Intermediate, and S = Standard.

A. System Overview

B1. Cable Ties

B2. Cable Accessories

B3. Stainless Steel Ties

C1. Wiring Duct

C2. Surface Raceway

C3. Abrasion Protection

C4. Cable Management

D1. Terminals

D2. Power Connectors

D3. Grounding Connectors

E1. Labeling Systems

E2. Labels

E3. Pre-Printed & Write-On Markers

E4. Permanent Identification

E5. Lockout/Tagout & Safety Solutions

F. Index



A. System Overview

## Push Mounts

- Require no adhesive or additional mounting hardware
- Can be used where only one side of the panel is accessible

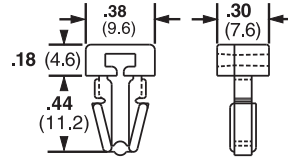

| Part Number | Used with Cable Ties‡ | Max. Panel Thickness |     | Panel Hole Diameter |     | Material                    | Color   | Environment | Mounting Method | Std. Pkg. Qty. | Std. Ctn. Qty. |
|-------------|-----------------------|----------------------|-----|---------------------|-----|-----------------------------|---------|-------------|-----------------|----------------|----------------|
|             |                       | In.                  | mm  | In.                 | mm  |                             |         |             |                 |                |                |
| PM2H25-C    | M, I, S               | .125                 | 3.2 | .250                | 6.4 | Nylon 6.6                   | Natural | Indoors     | Push Barb       | 100            | 500            |
| PM2H25-M0   |                       | .125                 | 3.2 | .250                | 6.4 | Weather Resistant Nylon 6.6 | Black   | Outdoors    |                 | 1000           | 5000           |
| PM2H25-M30  |                       | .125                 | 3.2 | .250                | 6.4 | Heat Stabilized Nylon 6.6   | Black   | Indoors     |                 | 1000           | 5000           |

‡Cable tie cross section sizes: M = Miniature, I = Intermediate, and S = Standard.

C3. Abrasion Protection

## Push Button Mounts

- Require no adhesive or additional mounting hardware
- Designed for use where both sides of the panel are accessible

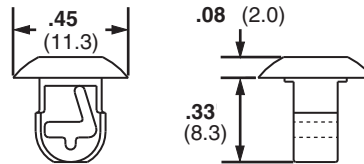

| Part Number   | Used with Cable Ties‡ | Max. Panel Thickness |     | Panel Hole Diameter |     | Material                    | Color   | Environment | Mounting Method | Std. Pkg. Qty. | Std. Ctn. Qty. |
|---------------|-----------------------|----------------------|-----|---------------------|-----|-----------------------------|---------|-------------|-----------------|----------------|----------------|
|               |                       | In.                  | mm  | In.                 | mm  |                             |         |             |                 |                |                |
| PBMS-H25-C    | M, I, S               | .13                  | 3.2 | .25                 | 6.4 | Nylon 6.6                   | Natural | Indoors     | Push Barb       | 100            | 1000           |
| PBMS-H25-C14  |                       | .13                  | 3.2 | .25                 | 6.4 | Nylon 6.6                   | Gray    | Indoors     |                 | 100            | 1000           |
| PBMS-H25-M0   |                       | .13                  | 3.2 | .25                 | 6.4 | Weather Resistant Nylon 6.6 | Black   | Outdoors    |                 | 1000           | 5000           |
| PBMS-H25-M30  |                       | .13                  | 3.2 | .25                 | 6.4 | Heat Stabilized Nylon 6.6   | Black   | Indoors     |                 | 1000           | 5000           |
| PBMSL-H25-C30 |                       | .29                  | 7.2 | .25                 | 6.4 | Heat Stabilized Nylon 6.6   | Black   | Indoors     |                 | 100            | 1000           |
| PBMSL-H25-M30 |                       | .29                  | 7.2 | .25                 | 6.4 | Heat Stabilized Nylon 6.6   | Black   | Indoors     |                 | 1000           | 5000           |

‡Cable tie cross section sizes: M = Miniature, I = Intermediate, and S = Standard.

E4. Permanent Identification

E5. Lockout/Tagout & Safety Solutions

F. Index

## Masonry Push Mounts

- Used to secure wire, cable, or tubing to masonry surfaces
- Installed quickly into pre-drilled holes; design holds bundle securely
- Material: Impact Modified Weather Resistant Nylon 6.6

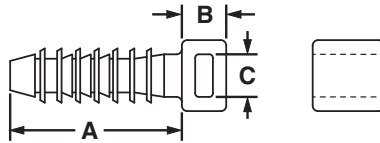

| Part Number                            | Used with Cable Ties‡    | Grip Length A |      | Height B |      | Hole Diameter C |     | Color | Environment          | Mounting Method           | Std. Pkg. Qty. | Std. Ctn. Qty. |
|--|--------------------------|---------------|------|----------|------|-----------------|-----|-------|----------------------|---------------------------|----------------|----------------|
|  |                          | In.           | mm   | In.      | mm   | In.             | mm  |       |                      |                           |                |                |
| <b>Pan-Ty® Masonry Push Mounts</b>     |                          |               |      |          |      |                 |     |       |                      |                           |                |                |
| MPMS19-C0                              | M, I, S                  | 0.97          | 24.6 | 0.25     | 6.4  | 0.19            | 5.0 | Black | Indoors/<br>Outdoors | Fir Tree<br>Hole<br>Mount | 100            | 500            |
| MPMS25-C0                              |                          | 0.97          | 24.6 | 0.27     | 6.9  | 0.25            | 6.4 |       |                      |                           | 100            | 500            |
| MPMH38-L0                              | M, I, S, HS, LH, H, HLM  | 1.25          | 31.8 | 0.30     | 7.5  | 0.38            | 9.5 |       |                      |                           | 50             | 500            |
| MPMWH32-L0                             | M, I, S, HS, LH, H, HLM  | 1.41          | 35.8 | 0.28     | 7.1  | 0.32            | 8.0 |       |                      |                           | 50             | 500            |
| <b>Super-Grip® Masonry Push Mounts</b> |                          |               |      |          |      |                 |     |       |                      |                           |                |                |
| SGMPMS19-C0                            | SGM, SGI, SGS            | 0.97          | 24.6 | 1.19     | 30.2 | 0.19            | 5.0 | Black | Indoors/<br>Outdoors | Fir Tree<br>Hole<br>Mount | 100            | 500            |
| SGMPMS25-C0                            |                          | 0.97          | 24.6 | 1.24     | 31.5 | 0.25            | 6.4 |       |                      |                           | 100            | 500            |
| SGMPMH38-L0                            |                          | 1.25          | 31.8 | 1.49     | 37.8 | 0.38            | 9.5 |       |                      |                           | 50             | 500            |
| SGMPMWH32-L0                           | SGM, SGI, SGS, SGLH, SGH | 1.41          | 35.8 | 0.28     | 7.1  | 0.32            | 8.0 |       |                      |                           | 50             | 500            |
| <b>Hyper-V™ Masonry Push Mounts</b>    |                          |               |      |          |      |                 |     |       |                      |                           |                |                |
| HVMPM32-C0                             | HV                       | 1.41          | 35.8 | 1.63     | 41.4 | 0.31            | 8.0 | Black | Outdoors             | Fir Tree<br>Hole<br>Mount | 100            | 500            |

‡Cable Tie Cross Section Sizes: M = Miniature, I = Intermediate, S = Standard, HS = Heavy-Standard, LH = Light-Heavy, H = Heavy, HLM = Tak-Ty® Miniature, SGM = Super-Grip® Miniature, SGI = Super-Grip® Intermediate, SGS = Super-Grip® Standard, SGLH = Super-Grip® Light-Heavy, SGH = Super-Grip® Heavy, and HV = Hyper-V™.

## Wood Push Mount

- Used to secure wire, cable, or tubing to wood surfaces
- Barbed design holds mount in place – rated for 60 lb. pullout

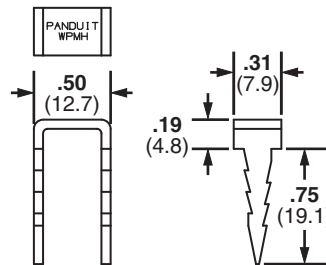

| Part Number | Used with Cable Ties‡   | Material     | Environment      | Mounting Method  | Std. Pkg. Qty. |
|-------------|-------------------------|--------------|------------------|------------------|----------------|
| WPMH-C      | M, I, S, HS, LH, H, HLM | Plated Steel | Indoors/Outdoors | Hammer into wood | 100            |

‡Cable tie cross section sizes: M = Miniature, I = Intermediate, S = Standard, HS = Heavy Standard, LH = Light-Heavy, H = Heavy and HLM = Miniature Tak-Ty® Hook & Loop Ties.

A.  
System  
Overview

## Fir Tree Push Mounts

- Unique alternating barb design
- Lock securely into position
- Umbrella tensiing
- Exclusive contoured anvil head
- Material: Heat Stabilized Nylon 6.6

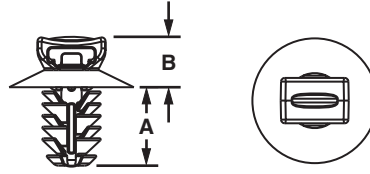
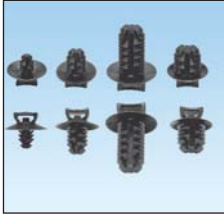

B1.  
Cable Ties

B2.  
Cable  
Accessories

B3.  
Stainless  
Steel Ties

C1.  
Wiring  
Duct

C2.  
Surface  
Raceway

C3.  
Abrasion  
Protection

C4.  
Cable  
Management

D1.  
Terminals

D2.  
Power  
Connectors

D3.  
Grounding  
Connectors

E1.  
Labeling  
Systems

E2.  
Labels

E3.  
Pre-Printed  
& Write-On  
Markers

E4.  
Permanent  
Identification

E5.  
Lockout/  
Tagout/  
& Safety  
Solutions

F.  
Index

| Part Number        | Used with<br>Cable Ties‡ | Head<br>Diameter |      | Panel to Top<br>of Mount |     | Overall<br>Height |      | Panel Hole<br>Diameter Range |            | Panel Thickness<br>Range |            | Std.<br>Pkg.<br>Qty. | Std.<br>Ctn.<br>Qty. |
|--------------------|--------------------------|------------------|------|--------------------------|-----|-------------------|------|------------------------------|------------|--------------------------|------------|----------------------|----------------------|
|                    |                          | In.              | mm   | In.                      | mm  | In.               | mm   | In.                          | mm         | In.                      | mm         |                      |                      |
| <b>PUM-049-M30</b> | M, I, S                  | .67              | 17.0 | .26                      | 6.6 | .54               | 13.8 | .18 – .19                    | 4.6 – 4.9  | .03 – .19                | 0.7 – 3.0  | 1000                 | 5000                 |
| <b>PUM-071-M30</b> | M, I, S                  | .67              | 17.0 | .26                      | 6.5 | .67               | 16.9 | .25 – .28                    | 6.3 – 7.1  | .03 – .28                | 0.8 – 7.0  | 1000                 | 5000                 |
| <b>PUM-100-M30</b> | M, I, S                  | .64              | 16.0 | .26                      | 6.5 | .67               | 16.9 | .35 – .40                    | 9.0 – 10.0 | .03 – .28                | 0.8 – 7.0  | 1000                 | 5000                 |
| <b>PUM-925-M30</b> | M, I, S, LH              | .77              | 20.0 | .30                      | 7.6 | 1.05              | 26.7 | .34 – .36                    | 8.8 – 9.3  | .04 – .62                | 1.0 – 16.0 | 1000                 | 5000                 |

‡Cable Tie Cross Section: M = Miniature, I = Intermediate, S = Standard, and LH = Light-Heavy.

## Fir Tree Push Mount Assemblies

- Cable tie/mount assemblies significantly reduce installation time compared to loose parts
- Fewer parts throughout the manufacturing/assembly process
- Heat Stabilized Nylon 6.6 standard on cable ties and mounts

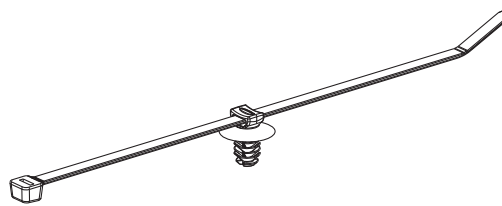
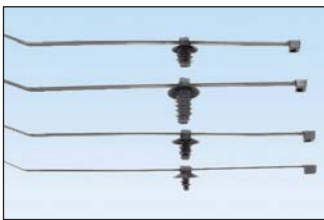

| Part Number‡          | Head<br>Diameter |      | Panel to Top<br>of Mount |     | Overall<br>Height |      | Panel Hole<br>Diameter Range |            | Panel Thickness<br>Range |            | Max. Bundle<br>Diameter |    | Std.<br>Pkg.<br>Qty. | Std.<br>Ctn.<br>Qty. |
|-----------------------|------------------|------|--------------------------|-----|-------------------|------|------------------------------|------------|--------------------------|------------|-------------------------|----|----------------------|----------------------|
|                       | In.              | mm   | In.                      | mm  | In.               | mm   | In.                          | mm         | In.                      | mm         | In.                     | mm |                      |                      |
| <b>PUM-049-2S-D30</b> | 0.67             | 17.0 | 0.26                     | 6.6 | 0.54              | 13.8 | 0.18 - 0.19                  | 4.6 - 4.9  | 0.03 - 0.19              | 0.7 - 3.0  | 1.88                    | 48 | 500                  | 5000                 |
| <b>PUM-071-2S-D30</b> | 0.67             | 17.0 | 0.26                     | 6.6 | 0.67              | 16.9 | 0.25 - 0.28                  | 6.3 - 7.1  | 0.03 - 0.28              | 0.8 - 7.0  |                         |    | 500                  | 5000                 |
| <b>PUM-100-2S-D30</b> | 0.64             | 16.0 | 0.26                     | 6.6 | 0.67              | 16.9 | 0.35 - 0.40                  | 9.0 - 10.0 | 0.03 - 0.28              | 0.8 - 7.0  |                         |    | 500                  | 5000                 |
| <b>PUM-925-3H-T30</b> | 0.77             | 20.0 | 0.30                     | 7.6 | 1.05              | 26.7 | 0.34 – 0.36                  | 8.8 – 9.3  | 0.04 – 0.62              | 1.0 – 16.0 | 3.00                    | 76 | 200                  | 1000                 |

‡Use with PLT2S Cable Ties except PUM-925-3H-T30, use with PLT3H Cable Ties.

## Control Panel Mounts

- Installed behind control panel switch
- Ideal for high strain areas where cable is routed from panel to panel door
- Compatible with most control panel switch designs
- Indoor use only

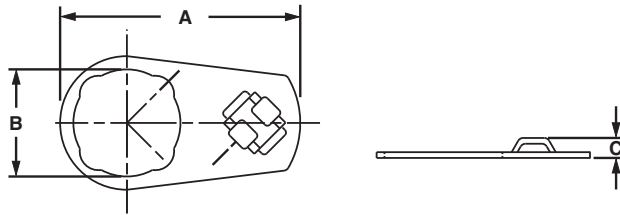

| Part Number | Used with Cable Ties‡ | Length A |      | Width B |      | Height C |     | Material          | Mounting Method      | Std. Pkg. Qty. | Std. Ctn. Qty. |
|-------------|-----------------------|----------|------|---------|------|----------|-----|-------------------|----------------------|----------------|----------------|
|             |                       | In.      | mm   | In.     | mm   | In.      | mm  |                   |                      |                |                |
| CPM87S-C    | M, I, S               | 2.01     | 51.1 | .89     | 22.6 | .17      | 4.3 | Zinc plated steel | Control panel switch | 100            | 1000           |
| CPM122S-C   | M, I, S               | 2.82     | 71.7 | 1.22    | 31.0 | .17      | 4.3 | Zinc plated steel | Control panel switch | 100            | 1000           |

‡Cable tie cross section sizes: M = Miniature, I = Intermediate, and S = Standard.

## Pan-Post™ Standoff

- Supports cable bundles above or away from surface
- For indoor use only
- Material: Nylon 6.6

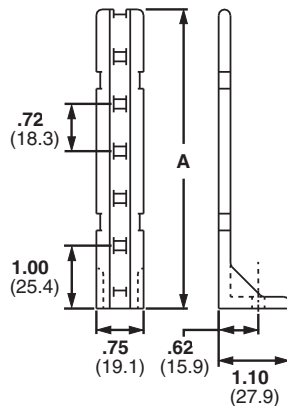

| Part Number | Used with Cable Ties‡ | Height A |       | Color   | Mounting Method  | Std. Pkg. Qty. | Std. Ctn. Qty. |
|-------------|-----------------------|----------|-------|---------|------------------|----------------|----------------|
|             |                       | In.      | mm    |         |                  |                |                |
| PP1S-S10-X  | M, I, S               | 2.00     | 50.8  | Natural | #10 (M5) Screw   | 10             | 100            |
| PP1S-S12-X  |                       | 2.00     | 50.8  |         | #12 (M5.5) Screw | 10             | 100            |
| PP2S-S10-X  |                       | 4.60     | 116.8 |         | #10 (M5) Screw   | 10             | 100            |
| PP2S-S12-X  |                       | 4.60     | 116.8 |         | #12 (M5.5) Screw | 10             | 100            |

‡Cable tie cross section sizes: M = Miniature, I = Intermediate, and S = Standard.

A.  
System  
Overview

B1.  
Cable Ties

B2.  
Cable  
Accessories

B3.  
Stainless  
Steel Ties

C1.  
Wiring  
Duct

C2.  
Surface  
Raceway

C3.  
Abrasion  
Protection

C4.  
Cable  
Management

D1.  
Terminals

D2.  
Power  
Connectors

D3.  
Grounding  
Connectors

E1.  
Labeling  
Systems

E2.  
Labels

E3.  
Pre-Printed  
& Write-On  
Markers

E4.  
Permanent  
Identification

E5.  
Lockout/  
Tagout  
& Safety  
Solutions

F.  
Index

A. System Overview

## Flat Pan-Post™ Standoffs

- Standard EIA hole spacing allows product to be mounted with user supplied screws up to 1/4" diameter
- Organize cables in standard cabinets and racks
- Mounting method: 1/4" (M6) screw
- Use where space is limited
- For indoor use only

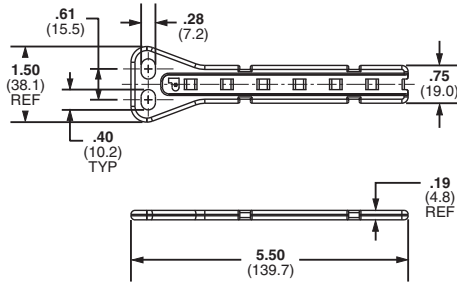

PPF2S

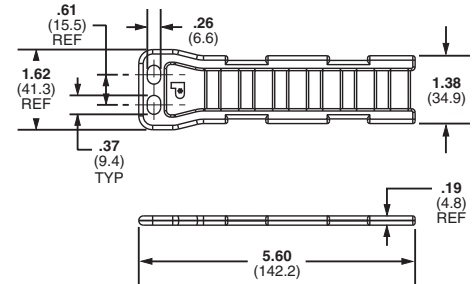

PPF2SV

B1. Cable Ties

B2. Cable Accessories

B3. Stainless Steel Ties

C1. Wiring Duct

C2. Surface Raceway

C3. Abrasion Protection

C4. Cable Management

| Part Number    | Used with Cable Ties‡        | Material                  | Color   | Mounting Method      | Std. Pkg. Qty. | Std. Ctn. Qty. |
|----------------|------------------------------|---------------------------|---------|----------------------|----------------|----------------|
| PPF2S-S25-V    | M, I, S                      | Nylon 6.6                 | Natural | Two 1/4" (M6) screws | 5              | 100            |
| PPF2S-S25-V69  |                              | Flame Retardant Nylon 6.6 |         |                      |                |                |
| PPF2SV-S25-V   | M, I, S, HS, LH, H, HLM, HLS | Nylon 6.6                 |         |                      |                |                |
| PPF2SV-S25-V69 |                              | Flame Retardant Nylon 6.6 |         |                      |                |                |

‡Cable Tie Cross Section Sizes: M = Miniature, I = Intermediate, S = Standard, HS = Heavy-Standard, LH = Light-Heavy, H = Heavy, HLM = Miniature Tak-Ty® Hook & Loop Ties and HLS = Standard Tak-Ty® Hook & Loop Ties .

D1. Terminals

## Right Angle Bases

- Support cable above the mounting surface

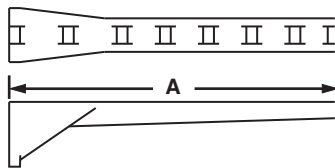

D2. Power Connectors

D3. Grounding Connectors

E1. Labeling Systems

E2. Labels

E3. Pre-Printed & Write-On Markers

E4. Permanent Identification

E5. Lockout/Tagout & Safety Solutions

F. Index

| Part Number   | Used with Cable Ties‡ | Max. Flat Cable Width |      | Length A |      | Material  | Color | Environment | Mounting Method | Std. Pkg. Qty. | Std. Ctn. Qty. |
|---------------|-----------------------|-----------------------|------|----------|------|-----------|-------|-------------|-----------------|----------------|----------------|
|               |                       | In.                   | mm   | In.      | mm   |           |       |             |                 |                |                |
| RAFCB1-S6-C20 | I                     | 1.00                  | 25.4 | 1.75     | 44.4 | Nylon 6.6 | Black | Indoors     | #6 (M3) Screw   | 100            | 1000           |
| RAFCB2-S6-C20 | I                     | 2.00                  | 50.8 | 2.78     | 70.6 |           |       |             |                 |                |                |
| RAFCB3-S6-C20 | I                     | 3.00                  | 76.2 | 3.81     | 96.8 |           |       |             |                 |                |                |

‡Cable tie cross section sizes: I = Intermediate.

## Flat Cable Mounting System – FCB Base and FCPI Plate

- Secures stacked cables, folds, and breakouts, as well as laminated and molded bus bars
- Use one base, one corresponding size plate (FCPI), and one Intermediate cross section cable tie
- For indoor use only
- See also Latching Flat Cable Mounts on page B2.38
- Material: Nylon 6.6

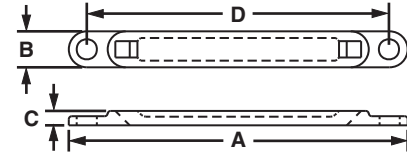
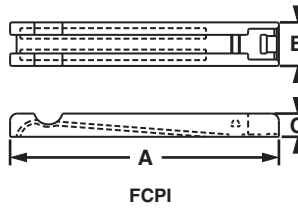

| Part Number   | Max. Flat Cable Width |      | Length A |       | Width B |     | Height C |     | Hole Spacing D |       | Color | Mounting Method        | Std. Pkg. Qty. | Std. Ctn. Qty. |
|---------------|-----------------------|------|----------|-------|---------|-----|----------|-----|----------------|-------|-------|------------------------|----------------|----------------|
|               | In.                   | mm   | In.      | mm    | In.     | mm  | In.      | mm  | In.            | mm    |       |                        |                |                |
| FCBI1-A-C20   | 1.04                  | 26.4 | 2.50     | 63.5  | .38     | 9.5 | .15      | 3.8 | —              | —     | Black | User Supplied Adhesive | 100            | 1000           |
| FCBI2-A-C20   | 2.04                  | 51.8 | 3.50     | 88.9  | .38     | 9.5 | .15      | 3.8 | —              | —     |       | User Supplied Adhesive | 100            | 1000           |
| FCBI3-A-C20   | 3.32                  | 7.72 | 4.52     | 114.8 | .38     | 9.5 | .15      | 3.8 | —              | —     |       | User Supplied Adhesive | 100            | 1000           |
| FCBI1-S10-C20 | 1.04                  | 26.4 | 2.50     | 63.5  | .38     | 9.5 | .15      | 3.8 | 2.08           | 52.8  |       | #10 (M5) Screw         | 100            | 1000           |
| FCBI2-S10-C20 | 2.04                  | 51.8 | 3.50     | 88.9  | .38     | 9.5 | .15      | 3.8 | 3.10           | 78.7  |       | #10 (M5) Screw         | 100            | 1000           |
| FCBI3-S10-C20 | 3.32                  | 77.2 | 4.52     | 114.8 | .38     | 9.5 | .15      | 3.8 | 4.12           | 104.6 |       | #10 (M5) Screw         | 100            | 1000           |
| FCPI1-C20*    | 1.04                  | 26.4 | 1.29     | 32.8  | .38     | 9.5 | .20      | 5.1 | —              | —     |       | Cable Ties             | 100            | 1000           |
| FCPI2-C20*    | 2.04                  | 51.8 | 2.31     | 58.7  | .38     | 9.5 | .20      | 5.1 | —              | —     |       | Cable Ties             | 100            | 1000           |
| FCPI3-C20*    | 3.32                  | 77.2 | 3.32     | 84.3  | .38     | 9.5 | .20      | 5.1 | —              | —     |       | Cable Ties             | 100            | 1000           |

\*Recommend for use with PLT2I cable ties on page B1.8.

A. System Overview

B1. Cable Ties

B2. Cable Accessories

B3. Stainless Steel Ties

C1. Wiring Duct

C2. Surface Raceway

C3. Abrasion Protection

C4. Cable Management

D1. Terminals

D2. Power Connectors

D3. Grounding Connectors

E1. Labeling Systems

E2. Labels

E3. Pre-Printed & Write-On Markers

E4. Permanent Identification

E5. Lockout/Tagout & Safety Solutions

F. Index



A.  
System  
Overview

## Closed Connector Rings

- Connect multiple cable bundles

B1.  
Cable Ties

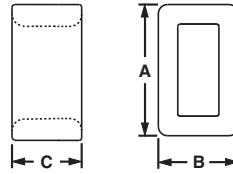
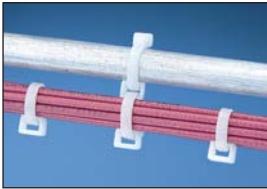

B2.  
Cable  
Accessories

B3.  
Stainless  
Steel Ties

C1.  
Wiring  
Duct

C2.  
Surface  
Raceway

| Part Number    | Used with Cable Ties‡ | Length A |      | Width B |     | Height C |     | Material                    | Color            | Environment | Mounting Method | Std. Pkg. Qty. | Std. Ctn. Qty. |
|----------------|-----------------------|----------|------|---------|-----|----------|-----|-----------------------------|------------------|-------------|-----------------|----------------|----------------|
|                |                       | In.      | mm   | In.     | mm  | In.      | mm  |                             |                  |             |                 |                |                |
| <b>CR2-M</b>   | M, I, S               | 0.33     | 8.4  | 0.20    | 5.1 | 0.20     | 5.0 | Nylon 6.6                   | Natural          | Indoors     | Cable Ties      | 1000           | 10000          |
| <b>CR4H-M</b>  | M, I, S, HS, LH       | 0.57     | 14.5 | 0.36    | 9.1 | 0.30     | 7.6 |                             |                  | Indoors     |                 |                |                |
| <b>CR4H-M0</b> | M, I, S, HS, LH       | 0.57     | 14.5 | 0.36    | 9.1 | 0.30     | 7.6 | Weather Resistant Nylon 6.6 | Indoors/Outdoors |             |                 |                |                |

‡Cable tie cross section sizes: M = Miniature, I = Intermediate, S = Standard, HS = Heavy-Standard and LH = Light-Heavy.

C3.  
Abrasion  
Protection

## Open Connector Ring

- Designed to add on cable bundles without removing cable ties

C4.  
Cable  
Management

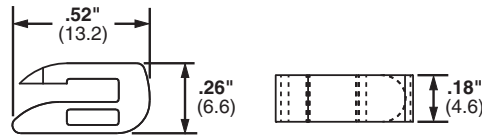

D1.  
Terminals

D2.  
Power  
Connectors

D3.  
Grounding  
Connectors

| Part Number   | Used With Cable Ties‡ | Material  | Color   | Environment | Mounting Method | Std. Pkg. Qty. | Std. Ctn. Qty. |
|---------------|-----------------------|-----------|---------|-------------|-----------------|----------------|----------------|
| <b>CROS-M</b> | M, I, S               | Nylon 6.6 | Natural | Indoors     | Cable Ties      | 1000           | 5000           |

‡Cable tie cross section sizes: M = Miniature, I = Intermediate, and S = Standard.

E1.  
Labeling  
Systems

## Cable Spacers

- Used to separate and/or hang cords, cables, and tubing

E2.  
Labels

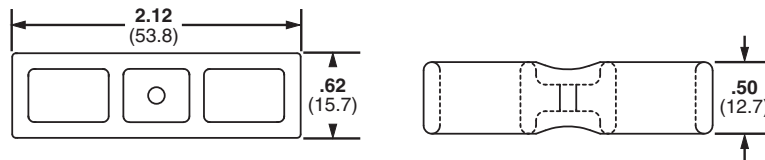

E3.  
Pre-Printed  
& Write-On  
Markers

E4.  
Permanent  
Identification

E5.  
Lockout/  
Tagout  
& Safety  
Solutions

| Part Number    | Used with Cable Ties‡ | Material                    | Color | Environment      | Mounting Method | Std. Pkg. Qty. | Std. Ctn. Qty. |
|----------------|-----------------------|-----------------------------|-------|------------------|-----------------|----------------|----------------|
| <b>CSH-D20</b> | M, I, S, HS, LH, H    | Nylon 6.6                   | Black | Indoors          | Cable Ties      | 500            | 2500           |
| <b>CSH-D0</b>  | M, I, S, HS, LH, H    | Weather Resistant Nylon 6.6 | Black | Indoors/Outdoors | Cable Ties      | 500            | 2500           |

‡Cable tie cross section sizes: M = Miniature, I = Intermediate, S = Standard, HS = Heavy-Standard, LH = Light-Heavy and H = Heavy.

F.  
Index

## Cable Spacer Cross

- Connects two bundles at 90°
- Separates bundles to prevent abrasion
- Dual cradle design stabilizes cable bundle

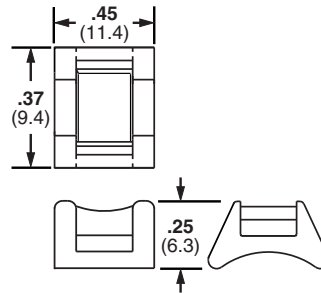

| Part Number | Used with Cable Ties‡ | Material  | Color   | Environment | Mounting Method | Std. Pkg. Qty. | Std. Ctn. Qty. |
|-------------|-----------------------|-----------|---------|-------------|-----------------|----------------|----------------|
| CSCS-M      | M, I, S               | Nylon 6.6 | Natural | Indoors     | Cable Ties      | 1000           | 10000          |

‡Cable tie cross section sizes: M = Miniature, I = Intermediate, and S = Standard.

## Stackable Aerial Cable Spacer

- Greater resistance to damage caused by ultraviolet light – indoor or outdoor use
- Each spacer snaps into another to increase spacer heights by 1/2" increments
- Designed for use in parallel or perpendicular applications
- For use with Dura-Ty™ Cable Ties shown on page B1.53 or Pan-Steel® Self-Locking Ties on page B3.5, B3.6, B3.7.

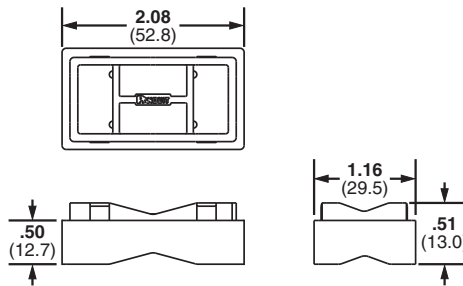

| Part Number | Used with Cable Ties‡ | Material                        | Color | Environment | Mounting Method | Std. Pkg. Qty. | Std. Ctn. Qty. |
|-------------|-----------------------|---------------------------------|-------|-------------|-----------------|----------------|----------------|
| SACS50-T100 | LH, H, EH             | Weather Resistant Polypropylene | Black | Outdoors    | Cable Ties      | 200            | 2000           |

\*Cable tie cross sizes: LH = Light-Heavy, H = Heavy, and EH = Extra-Heavy.

A.  
System  
Overview

B1.  
Cable Ties

B2.  
Cable  
Accessories

B3.  
Stainless  
Steel Ties

C1.  
Wiring  
Duct

C2.  
Surface  
Raceway

C3.  
Abrasion  
Protection

C4.  
Cable  
Management

D1.  
Terminals

D2.  
Power  
Connectors

D3.  
Grounding  
Connectors

E1.  
Labeling  
Systems

E2.  
Labels

E3.  
Pre-Printed  
& Write-On  
Markers

E4.  
Permanent  
Identification

E5.  
Lockout/  
Tagout  
& Safety  
Solutions

F.  
Index

A. System Overview

B1. Cable Ties

B2. Cable Accessories

B3. Stainless Steel Ties

C1. Wiring Duct

C2. Surface Raceway

C3. Abrasion Protection

C4. Cable Management

D1. Terminals

D2. Power Connectors

D3. Grounding Connectors

E1. Labeling Systems

E2. Labels

E3. Pre-Printed & Write-On Markers

E4. Permanent Identification

E5. Lockout/Tagout & Safety Solutions

F. Index

## Aerial Support Ties – Weather Resistant Polypropylene

- Designed to attach coax or telephone cable to the 1/4" (6.4mm) or 5/16" (7.9mm) support strand to form the expansion loop and keep equipment and cables clear of pole hardware
- One-piece construction with integral 1/2" (12.7mm) spacer reduces inventory costs of separate spacer and bands, and installs faster to lower installed cost
- Releasable and re-usable
- Hand install only

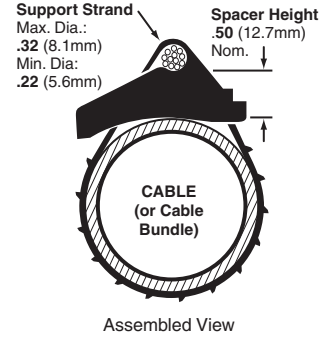
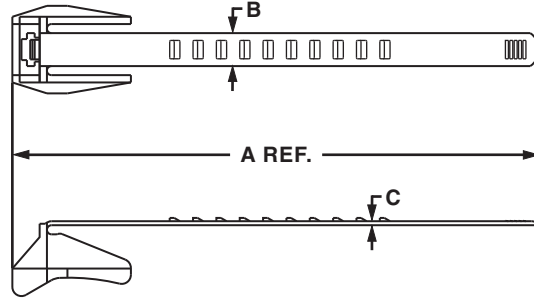

| Part Number         | Length A |     | Width B |      | Thickness C |     | Max. Bundle Diameter |    | Min. Loop Tensile Strength |     | Std. Pkg. Qty. | Std. Ctn. Qty. |
|---------------------|----------|-----|---------|------|-------------|-----|----------------------|----|----------------------------|-----|----------------|----------------|
|                     | In.      | mm  | In.     | mm   | In.         | mm  | In.                  | mm | Lbs.                       | N   |                |                |
| <b>AST10-5-C100</b> | 5.6      | 142 | .448    | 11.4 | .055        | 1.4 | 1.00                 | 25 | 75                         | 334 | 100            | 1000           |
| <b>AST15-5-C100</b> | 6.9      | 175 | .448    | 11.4 | .055        | 1.4 | 1.50                 | 38 | 75                         | 334 | 100            | 1000           |
| <b>AST20-5-C100</b> | 8.4      | 214 | .448    | 11.4 | .055        | 1.4 | 2.00                 | 51 | 75                         | 334 | 100            | 1000           |
| <b>AST25-5-C100</b> | 10.0     | 254 | .448    | 11.4 | .055        | 1.4 | 2.50                 | 64 | 75                         | 334 | 100            | 1000           |

## Permanent Marking Pens

- Fast drying, permanent ink for identification on marker ties (pages B1.34, B1.52, and B1.71), marker plates (page B2.29), or cable marker straps (page B1.80)
- May be used with any label shown in the catalog when a printer is not available



PX-0  
PX-2



PFX-0  
PFX-2



PX-10

| Part Number  | Color | Description  | Std. Pkg. Qty. | Std. Ctn. Qty. |
|--------------|-------|--|----------------|----------------|
| <b>PX-0</b>  | Black | Permanent marking pen – regular tip.                             | 12             | 144            |
| <b>PX-2</b>  | Red   | Permanent marking pen – regular tip.                             | 12             | 144            |
| <b>PFX-0</b> | Black | Permanent marking pen – fine tip.                                | 12             | 144            |
| <b>PFX-2</b> | Red   | Permanent marking pen – fine tip.                                | 12             | 144            |
| <b>PX-10</b> | White | Marking pen for black or other dark colored parts – regular tip. | 12             | 300            |

## Marker Plates – Loose Piece

- Install as flags, tags, or wrap-around identification plates to clearly identify all wire harnesses
- Use with nylon marking pens for an easy and economic alternative to identify wire harnesses
- Available in black or white to match the wire harness
- Thickness: .02 inches (0.5mm)

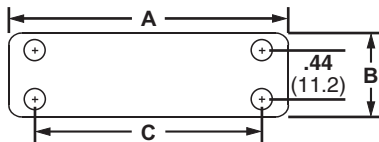

| Part Number                   | Used with Cable Ties‡ | Length A |      | Width B |      | Hole Spacing C |      | Material                    | Color | Environment      | Mounting Method | Std. Pkg. Qty. | Std. Ctn. Qty. |
|-------------------------------|-----------------------|----------|------|---------|------|----------------|------|-----------------------------|-------|------------------|-----------------|----------------|----------------|
|                               |                       | In.      | mm   | In.     | mm   | In.            | mm   |                             |       |                  |                 |                |                |
| <b>Loose Piece</b>            |                       |          |      |         |      |                |      |                             |       |                  |                 |                |                |
| MP150-C                       | M, I, S               | 1.50     | 38.1 | .75     | 19.0 | 1.03           | 26.2 | Nylon 6.6                   | White | Indoors          | Cable Ties      | 100            | 500            |
| MP175-C                       | M, I, S               | 1.75     | 44.4 | .75     | 19.0 | 1.28           | 32.5 |                             |       |                  |                 | 100            | 500            |
| MP200-C                       | M, I, S               | 2.00     | 50.8 | .75     | 19.0 | 1.53           | 38.9 |                             |       |                  |                 | 100            | 500            |
| MP250-C                       | M, I, S               | 2.50     | 63.5 | .75     | 19.0 | 2.03           | 51.6 |                             |       |                  |                 | 100            | 500            |
| MP350-C                       | M, I, S               | 3.50     | 88.9 | .75     | 19.0 | 3.03           | 77.7 |                             |       |                  |                 | 100            | 1000           |
| MP250W175-C                   | M, I, S               | 2.50     | 63.5 | 1.75    | 44.5 | 2.03           | 51.6 |                             |       |                  |                 | 100            | 1000           |
| MP150-C0                      | M, I, S               | 1.50     | 38.1 | .75     | 19.0 | 1.03           | 26.2 | Weather Resistant Nylon 6.6 | Black | Indoors/Outdoors | Cable Ties      | 100            | 500            |
| MP175-C0                      | M, I, S               | 1.75     | 44.4 | .75     | 19.0 | 1.28           | 32.5 |                             |       |                  |                 | 100            | 500            |
| MP200-C0                      | M, I, S               | 2.00     | 50.8 | .75     | 19.0 | 1.53           | 38.9 |                             |       |                  |                 | 100            | 500            |
| MP250-C0                      | M, I, S               | 2.50     | 63.5 | .75     | 19.0 | 2.03           | 51.6 |                             |       |                  |                 | 100            | 500            |
| MP350-C0                      | M, I, S               | 3.50     | 88.9 | .75     | 19.0 | 3.03           | 77.7 |                             |       |                  |                 | 100            | 1000           |
| <b>Marker Plates on Rolls</b> |                       |          |      |         |      |                |      |                             |       |                  |                 |                |                |
| MP150-R                       | M, I, S               | 1.50     | 38.1 | .75     | 19.0 | 1.03           | 26.2 | Nylon 6.6                   | White | Indoors          | Cable Ties      | 1000           | 5000           |
| MP175-R                       | M, I, S               | 1.75     | 44.4 | .75     | 19.0 | 1.28           | 32.5 |                             |       |                  |                 | 1000           | 5000           |
| MP200-R                       | M, I, S               | 2.00     | 50.8 | .75     | 19.0 | 1.53           | 38.9 |                             |       |                  |                 | 1000           | 5000           |
| MP250-R                       | M, I, S               | 2.50     | 63.5 | .75     | 19.0 | 2.03           | 51.6 |                             |       |                  |                 | 1000           | 5000           |

‡Cable tie cross section sizes: M = Miniature, I = Intermediate, and S = Standard.

A. System Overview

## Cable and Wire Mounting Devices (Used without Cable Ties)

B1. Cable Ties

B2. Cable Accessories

B3. Stainless Steel Ties



Wiring accessories are an integral part of the Panduit comprehensive selection of wire management products.

These accessories are one piece solutions that help provide the lowest installed cost for controlling, mounting, and protecting wire and cable. Mounting methods include:

- Adhesive-backed
- Screw applied
- Rivet applied
- Push mounts

C1. Wiring Duct

C2. Surface Raceway

C3. Abrasion Protection

## Adhesive Backed Mounting Devices

### Faster Liner Removal Speeds Installation and Lowers Installed Cost

- The adhesive backed mounts are offered either as one or two mounts per liner
- The 2-up mounts are easily removed by bending the mounts away from the liner
- The individual mounts have a convenient tear tab for quick removal

C4. Cable Management

D1. Terminals

D2. Power Connectors

D3. Grounding Connectors

## Clincher™ Adjustable Releasable Clamp

- Adjustable clamp designed to contain a range of cable bundle diameters
- Latch can be released to provide access to cable bundles
- For indoor use only
- Material: Polypropylene

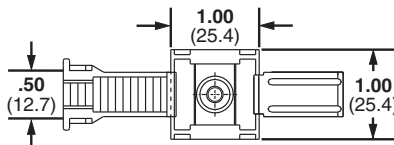

E1. Labeling Systems

E2. Labels

E3. Pre-Printed & Write-On Markers

E4. Permanent Identification

E5. Lockout/Tagout & Safety Solutions

F. Index

| Part Number          | Bundle Diameter Range |            | Color | Mounting Method      | Std. Pkg. Qty. | Std. Ctn. Qty. |
|----------------------|-----------------------|------------|-------|----------------------|----------------|----------------|
|                      | In.                   | mm         |       |                      |                |                |
| <b>ARC.68-A-Q</b>    | 0.19 – 0.68           | 4.8 – 17.3 | White | Rubber Adhesive Tape | 25             | 250            |
| <b>ARC.68-A-Q14</b>  | 0.19 – 0.68           | 4.8 – 17.3 | Gray  | Rubber Adhesive Tape | 25             | 250            |
| <b>ARC.68-S6-Q</b>   | 0.19 – 0.69           | 4.8 – 17.5 | White | #6 (M3) Screw        | 25             | 250            |
| <b>ARC.68-S6-Q14</b> | 0.19 – 0.69           | 4.8 – 17.5 | Gray  | #6 (M3) Screw        | 25             | 250            |

## Adhesive Backed Cord Clips

- Cables are easily snapped into or out of the clips

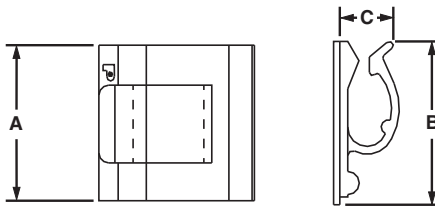

| Part Number               | Max. Bundle Diameter |      | Length A |      | Width B |      | Height C |      | Material                                    | Color                       | Adhesive Type     | Std. Pkg. Qty. | Std. Ctn. Qty. |
|---------------------------|----------------------|------|----------|------|---------|------|----------|------|---|-----------------------------|-------------------|----------------|----------------|
|                           | In.                  | mm   | In.      | mm   | In.     | mm   | In.      | mm   |   |                             |                   |                |                |
| ACC19-A-C                 | 0.19                 | 4.8  | 0.75     | 19.0 | 0.62    | 15.7 | 0.25     | 6.4  | Nylon 6.6                                   | Natural                     | Rubber            | 100            | 500            |
| ACC19-AT-C                | 0.19                 | 4.8  | 0.75     | 19.0 | 0.62    | 15.7 | 0.25     | 6.4  |   | Natural                     | Acrylic           | 100            | 500            |
| ACC19-A-C20               | 0.19                 | 4.8  | 0.75     | 19.0 | 0.62    | 15.7 | 0.25     | 6.4  |   | Black                       | Rubber            | 100            | 500            |
| ACC19-AT-C0               | 0.19                 | 4.8  | 0.75     | 19.0 | 0.62    | 15.7 | 0.25     | 6.4  |   | Weather Resistant Nylon 6.6 | Black             | Acrylic        | 100            |
| <b>NEW!</b> ACC19-AV-M300 | 0.19                 | 4.8  | 0.75     | 19.0 | 0.62    | 15.7 | 0.38     | 6.4  | Heat Stabilized Weather Resistant Nylon 6.6 | Black                       | High Bond Acrylic | 1000           | 5000           |
| ACC38-A-C                 | 0.38                 | 9.7  | 1.00     | 25.4 | 1.00    | 25.4 | 0.38     | 9.7  | Nylon 6.6                                   | Natural                     | Rubber            | 100            | 500            |
| ACC38-AT-C                | 0.38                 | 9.7  | 1.00     | 25.4 | 1.00    | 25.4 | 0.38     | 9.7  |   | Natural                     | Acrylic           | 100            | 500            |
| ACC38-A-C20               | 0.38                 | 9.7  | 1.00     | 25.4 | 1.00    | 25.4 | 0.38     | 9.7  |   | Black                       | Rubber            | 100            | 500            |
| ACC38-AT-C0               | 0.38                 | 9.7  | 1.00     | 25.4 | 1.00    | 25.4 | 0.38     | 9.7  | Weather Resistant Nylon 6.6                 | Black                       | Acrylic           | 100            | 500            |
| <b>NEW!</b> ACC38-AV-M300 | 0.38                 | 9.7  | 1.00     | 25.4 | 1.00    | 25.4 | 0.40     | 10.2 | Heat Stabilized Weather Resistant Nylon 6.6 | Black                       | High Bond Acrylic | 1000           | 5000           |
| ACC62-A-C                 | 0.62                 | 15.7 | 1.24     | 31.5 | 1.12    | 28.4 | 0.63     | 16.0 | Nylon 6.6                                   | Natural                     | Rubber            | 100            | 500            |
| ACC62-AT-C                | 0.62                 | 15.7 | 1.24     | 31.5 | 1.12    | 28.4 | 0.63     | 16.0 |   | Natural                     | Acrylic           | 100            | 500            |
| ACC62-A-C20               | 0.62                 | 15.7 | 1.24     | 31.5 | 1.12    | 28.4 | 0.63     | 16.0 |   | Black                       | Rubber            | 100            | 500            |
| ACC62-AT-C0               | 0.62                 | 15.7 | 1.24     | 31.5 | 1.12    | 28.4 | 0.63     | 16.0 | Weather Resistant Nylon 6.6                 | Black                       | Acrylic           | 100            | 500            |
| <b>NEW!</b> ACC62-AV-D300 | 0.62                 | 15.7 | 1.24     | 31.5 | 1.12    | 28.4 | 0.63     | 16.0 | Heat Stabilized Weather Resistant Nylon 6.6 | Black                       | High Bond Acrylic | 500            | 5000           |

## Push Mount Cord Clip

- Cables are easily snapped into or out of clips
- Winged design holds mount in place even in applications where vibration is present
- Design of wing provides added stability

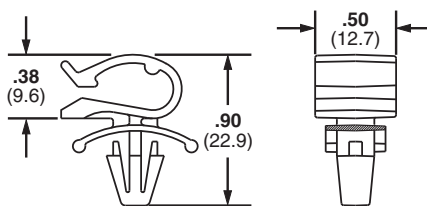

| Part Number  | Max. Bundle Diameter |     | Max. Panel Thickness |     | Panel Hole Diameter |     | Material                    | Color   | Environment | Mounting Method | Std. Pkg. Qty. | Std. Ctn. Qty. |
|--------------|----------------------|-----|----------------------|-----|---------------------|-----|-----------------------------|---------|-------------|-----------------|----------------|----------------|
|              | In.                  | mm  | In.                  | mm  | In.                 | mm  |                             |         |             |                 |                |                |
| PMCC38H25-C  | .38                  | 9.6 | .105                 | 2.7 | .250                | 6.4 | Nylon 6.6                   | Natural | Indoors     | Push Barb       | 100            | 1000           |
| PMCC38H25-M0 | .38                  | 9.6 | .105                 | 2.7 | .250                | 6.4 | Weather Resistant Nylon 6.6 | Black   | Outdoors    | Push Barb       | 1000           | 5000           |



A. System Overview

## "J" Clips

- Low profile clips retain cords, cables, or tubing
- Flexible design allows for easy cord insertion, yet holds bundle tightly
- For indoor use only
- Material: PVC

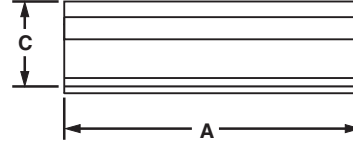
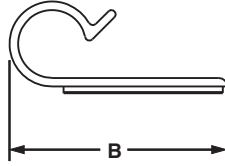
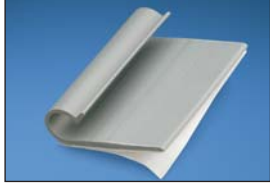

B1. Cable Ties

B2. Cable Accessories

B3. Stainless Steel Ties

C1. Wiring Duct

C2. Surface Raceway

C3. Abrasion Protection

C4. Cable Management

| Part Number | Max. Bundle Diameter |     | Length A |      | Width B |      | Height C |      | Diameter |     | Color      | Adhesive Type        | Std. Pkg. Qty. | Std. Ctn. Qty. |
|-------------|----------------------|-----|----------|------|---------|------|----------|------|----------|-----|------------|----------------------|----------------|----------------|
|             | In.                  | mm  | In.      | mm   | In.     | mm   | In.      | mm   | In.      | mm  |            |                      |                |                |
| AJC12-A-C   | 0.12                 | 3.0 | 1.00     | 25.4 | 0.86    | 21.8 | 0.19     | 4.8  | 0.13     | 3.3 | Light Gray | Rubber Adhesive Tape | 100            | 1000           |
| AJC19-A-C   | 0.19                 | 4.8 | 1.25     | 31.8 | 0.87    | 22.1 | 0.26     | 6.6  | 0.18     | 4.6 |            |                      | 100            | 1000           |
| AJC25-A-C   | 0.25                 | 6.4 | 1.50     | 38.1 | 0.97    | 24.6 | 0.31     | 7.9  | 0.23     | 5.8 |            |                      | 100            | 1000           |
| AJC31-A-C   | 0.31                 | 7.9 | 1.75     | 44.5 | 1.22    | 30.1 | 0.40     | 10.2 | 0.29     | 7.4 |            |                      | 100            | 1000           |
| AJC38-A-C   | 0.38                 | 9.6 | 2.00     | 50.8 | 1.27    | 32.3 | 0.50     | 12.7 | 0.39     | 9.9 |            |                      | 100            | 1000           |

D1. Terminals

- Hold cords, cables, and tubing
- Single rubber adhesive pad for confined areas
- For indoor use only
- Material: PVC

D2. Power Connectors

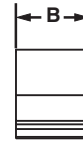
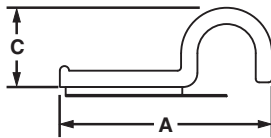

D3. Grounding Connectors

E1. Labeling Systems

E2. Labels

E3. Pre-Printed & Write-On Markers

E4. Permanent Identification

E5. Lockout/Tagout & Safety Solutions

F. Index

| Part Number | Max. Bundle Diameter |      | Length A |      | Width B |      | Height C |      | Color      | Adhesive Type | Std. Pkg. Qty. | Std. Ctn. Qty. |
|-------------|----------------------|------|----------|------|---------|------|----------|------|------------|---------------|----------------|----------------|
|             | In.                  | mm   | In.      | mm   | In.     | mm   | In.      | mm   |            |               |                |                |
| A1C12-A-C8  | 0.12                 | 3.0  | 0.77     | 19.6 | 0.63    | 16.0 | 0.23     | 5.8  | Light Gray | Rubber        | 100            | 1000           |
| A1C25-A-C8  | 0.25                 | 6.4  | 0.91     | 23.1 | 0.63    | 16.0 | 0.38     | 9.7  |            |               | 100            | 1000           |
| A1C38-A-C8  | 0.38                 | 9.5  | 1.04     | 26.4 | 0.63    | 16.0 | 0.51     | 13.0 |            |               | 100            | 1000           |
| A1C50-A-C8  | 0.50                 | 12.7 | 1.17     | 29.7 | 0.63    | 16.0 | 0.64     | 16.3 |            |               | 100            | 1000           |

## A2C Type Clips

- Hold cords, cables, and tubing
- Two rubber adhesive pads for added strength

- For indoor use only
- Material: PVC

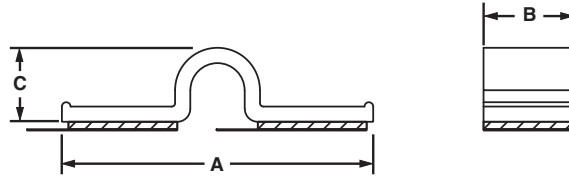

| Part Number | Max. Bundle Diameter |      | Length A |      | Width B |      | Height C |      | Color      | Adhesive Type | Std. Pkg. Qty. | Std. Ctn. Qty. |
|-------------|----------------------|------|----------|------|---------|------|----------|------|------------|---------------|----------------|----------------|
|             | In.                  | mm   | In.      | mm   | In.     | mm   | In.      | mm   |            |               |                |                |
| A2C12-A-C8  | 0.12                 | 3.0  | 1.30     | 33.0 | 0.63    | 16.0 | 0.23     | 5.8  | Light Gray | Rubber        | 100            | 1000           |
| A2C25-A-C8  | 0.25                 | 6.4  | 1.43     | 36.3 | 0.63    | 16.0 | 0.36     | 9.1  |            |               | 100            | 1000           |
| A2C38-A-C8  | 0.38                 | 9.5  | 1.56     | 39.6 | 0.63    | 16.0 | 0.49     | 12.4 |            |               | 100            | 1000           |
| A2C50-A-C8  | 0.50                 | 12.7 | 1.72     | 43.7 | 0.63    | 16.0 | 0.61     | 15.5 |            |               | 100            | 1000           |

## Metal Adhesive Backed Cord Clips

- Can be opened and closed without damaging clip in order to remove or add cables quickly and easily

- For indoor use only

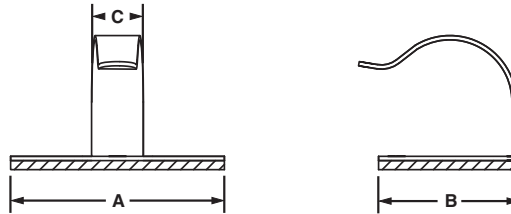

| Part Number | Max. Bundle Diameter |      | Length A |      | Width B |      | Clip Width C |     | Material          | Adhesive Type     | Std. Pkg. Qty. | Std. Ctn. Qty. |
|-------------|----------------------|------|----------|------|---------|------|--------------|-----|-------------------|-------------------|----------------|----------------|
|             | In.                  | mm   | In.      | mm   | In.     | mm   | In.          | mm  |                   |                   |                |                |
| MACC25-A-C  | 0.25                 | 6.4  | 0.77     | 19.6 | 0.54    | 13.7 | 0.29         | 7.4 | Zinc Plated Steel | Rubber            | 100            | 1000           |
| MACC62-A-C  | 0.62                 | 15.7 | 1.18     | 30.0 | 0.78    | 19.7 | 0.29         | 7.4 |                   |                   | 100            | 1000           |
| MACC25-AV-D | 0.25                 | 6.4  | 0.77     | 19.6 | 0.54    | 13.7 | 0.29         | 7.4 |                   | High Bond Acrylic | 500            | 1000           |
| MACC62-AV-C | 0.62                 | 15.7 | 1.18     | 30.0 | 0.78    | 19.7 | 0.29         | 7.4 |                   |                   | 100            | 1000           |



A. System Overview

B1. Cable Ties

B2. Cable Accessories

B3. Stainless Steel Ties

C1. Wiring Duct

C2. Surface Raceway

C3. Abrasion Protection

C4. Cable Management

D1. Terminals

D2. Power Connectors

D3. Grounding Connectors

E1. Labeling Systems

E2. Labels

E3. Pre-Printed & Write-On Markers

E4. Permanent Identification

E5. Lockout/Tagout & Safety Solutions

F. Index

A. System Overview

## Latching Wire Clips

- Route and secure cords and cables
- Convenient releasable latch
- Available in six sizes with releasable latch

- Push barb parts are for use with a max panel thickness of 0.11" (2.7mm) and a hole diameter of .22" (5.6mm)
- For indoor use only
- Material: Nylon 6.6

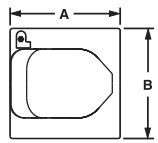
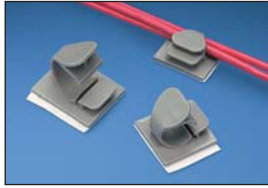

LWC\*\*-A

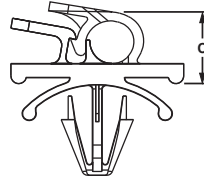

LWC\*\*-H25

B1. Cable Ties

B2. Cable Accessories

B3. Stainless Steel Ties

C1. Wiring Duct

C2. Surface Raceway

C3. Abrasion Protection

C4. Cable Management

D1. Terminals

D2. Power Connectors

D3. Grounding Connectors

E1. Labeling Systems

E2. Labels

E3. Pre-Printed & Write-On Markers

E4. Permanent Identification

E5. Lockout/Tagout & Safety Solutions

F. Index

| Part Number            | Max. Bundle Diameter |      | Length A |      | Width B |      | Height C |      | Color   | Mounting Method | Std. Pkg. Qty. | Std. Ctn. Qty. |      |
|------------------------|----------------------|------|----------|------|---------|------|----------|------|---------|-----------------|----------------|----------------|------|
|                        | In.                  | mm   | In.      | mm   | In.     | mm   | In.      | mm   |         |                 |                |                |      |
| <b>Adhesive Backed</b> |                      |      |          |      |         |      |          |      |         |                 |                |                |      |
| LWC19-A-C              | 0.19                 | 4.8  | 0.85     | 21.6 | 0.61    | 15.5 | 0.39     | 9.9  | Natural | Rubber Adhesive | 100            | 1000           |      |
| LWC19-A-C14            | 0.19                 | 4.8  | 0.85     | 21.6 | 0.61    | 15.5 | 0.39     | 9.9  | Gray    |                 | 100            | 1000           |      |
| LWC19-A-C20            | 0.19                 | 4.8  | 0.85     | 21.6 | 0.61    | 15.5 | 0.39     | 9.9  | Black   |                 | 100            | 1000           |      |
| LWC25-A-C              | 0.25                 | 6.4  | 0.88     | 22.2 | 1.00    | 25.4 | 0.45     | 11.4 | Natural |                 | 100            | 1000           |      |
| LWC25-A-C14            | 0.25                 | 6.4  | 0.88     | 22.2 | 1.00    | 25.4 | 0.45     | 11.4 | Gray    |                 | 100            | 1000           |      |
| LWC25-A-C20            | 0.25                 | 6.4  | 0.88     | 22.2 | 1.00    | 25.4 | 0.45     | 11.4 | Black   |                 | 100            | 1000           |      |
| LWC38-A-C              | 0.38                 | 9.5  | 1.00     | 25.4 | 1.00    | 25.4 | 0.56     | 14.2 | Natural |                 | 100            | 1000           |      |
| LWC38-A-C14            | 0.38                 | 9.5  | 1.00     | 25.4 | 1.00    | 25.4 | 0.56     | 14.2 | Gray    |                 | 100            | 1000           |      |
| LWC38-A-C20            | 0.38                 | 9.5  | 1.00     | 25.4 | 1.00    | 25.4 | 0.56     | 14.2 | Black   |                 | 100            | 1000           |      |
| LWC50-A-L              | 0.50                 | 12.7 | 1.26     | 32.0 | 1.00    | 25.4 | 0.67     | 17.0 | Natural |                 | 50             | 500            |      |
| LWC50-A-L14            | 0.50                 | 12.7 | 1.26     | 32.0 | 1.00    | 25.4 | 0.67     | 17.0 | Gray    |                 | 50             | 500            |      |
| LWC50-A-L20            | 0.50                 | 12.7 | 1.26     | 32.0 | 1.00    | 25.4 | 0.67     | 17.0 | Black   |                 | 50             | 500            |      |
| LWC75-A-L              | 0.75                 | 19.1 | 1.48     | 37.6 | 1.24    | 31.5 | 0.90     | 22.9 | Natural |                 | 50             | 500            |      |
| LWC75-A-L14            | 0.75                 | 19.1 | 1.48     | 37.6 | 1.24    | 31.5 | 0.90     | 22.9 | Gray    |                 | 50             | 500            |      |
| LWC75-A-L20            | 0.75                 | 19.1 | 1.48     | 37.6 | 1.24    | 31.5 | 0.90     | 22.9 | Black   |                 | 50             | 500            |      |
| LWC100-A-L             | 1.00                 | 25.4 | 2.21     | 56.1 | 1.97    | 50.0 | 1.26     | 32.0 | Natural |                 | 50             | 500            |      |
| LWC100-A-L14           | 1.00                 | 25.4 | 2.21     | 56.1 | 1.97    | 50.0 | 1.26     | 32.0 | Gray    |                 | 50             | 500            |      |
| LWC100-A-L20           | 1.00                 | 25.4 | 2.21     | 56.1 | 1.97    | 50.0 | 1.26     | 32.0 | Black   |                 | 50             | 500            |      |
| <b>Push Mount</b>      |                      |      |          |      |         |      |          |      |         |                 |                |                |      |
| LWC19-H25-C            | 0.19                 | 4.8  | 0.85     | 21.6 | 0.51    | 12.8 | 0.41     | 10.4 | Natural |                 | Push Barb      | 100            | 1000 |
| LWC19-H25-C14          | 0.19                 | 4.8  | 0.85     | 21.6 | 0.51    | 12.8 | 0.41     | 10.4 | Gray    | 100             |                | 1000           |      |
| LWC25-H25-C            | 0.25                 | 6.4  | 0.86     | 21.8 | 0.58    | 14.7 | 0.47     | 11.9 | Natural | 100             |                | 1000           |      |
| LWC25-H25-C14          | 0.25                 | 6.4  | 0.86     | 21.8 | 0.58    | 14.7 | 0.47     | 11.9 | Gray    | 100             |                | 1000           |      |
| LWC25-H25-C20          | 0.25                 | 6.4  | 0.86     | 21.8 | 0.58    | 14.7 | 0.47     | 11.9 | Black   | 100             |                | 1000           |      |
| LWC38-H25-C            | 0.38                 | 9.5  | 0.94     | 23.9 | 0.58    | 14.7 | 0.57     | 14.5 | Natural | 100             |                | 1000           |      |
| LWC38-H25-C14          | 0.38                 | 9.5  | 0.94     | 23.9 | 0.58    | 14.7 | 0.57     | 14.5 | Gray    | 100             |                | 1000           |      |
| LWC38-H25-C20          | 0.38                 | 9.5  | 0.94     | 23.9 | 0.58    | 14.7 | 0.57     | 14.5 | Black   | 100             |                | 1000           |      |
| LWC50-H25-L            | 0.50                 | 12.7 | 1.25     | 31.8 | 0.76    | 19.3 | 0.78     | 19.8 | Natural | 50              |                | 500            |      |
| LWC50-H25-L14          | 0.50                 | 12.7 | 1.25     | 31.8 | 0.76    | 19.3 | 0.78     | 19.8 | Gray    | 50              |                | 500            |      |
| LWC50-H25-L20          | 0.50                 | 12.7 | 1.25     | 31.8 | 0.76    | 19.3 | 0.78     | 19.8 | Black   | 50              |                | 500            |      |
| LWC75-H25-L            | 0.75                 | 19.1 | 1.45     | 36.8 | 0.87    | 22.1 | 0.97     | 24.7 | Natural | 50              |                | 500            |      |
| LWC75-H25-L14          | 0.75                 | 19.1 | 1.45     | 36.8 | 0.87    | 22.1 | 0.97     | 24.7 | Gray    | 50              |                | 500            |      |
| LWC75-H25-L20          | 0.75                 | 19.1 | 1.45     | 36.8 | 0.87    | 22.1 | 0.97     | 24.7 | Black   | 50              |                | 500            |      |
| LWC100-H25-L           | 1.00                 | 25.4 | 1.89     | 47.9 | 0.99    | 25.2 | 1.30     | 33.0 | Natural | 50              |                | 500            |      |
| LWC100-H25-L14         | 1.00                 | 25.4 | 1.89     | 47.9 | 0.99    | 25.2 | 1.30     | 33.0 | Gray    | 50              |                | 500            |      |
| LWC100-H25-L20         | 1.00                 | 25.4 | 1.89     | 47.9 | 0.99    | 25.2 | 1.30     | 33.0 | Black   | 50              |                | 500            |      |

## Bevel Entry Clips

- Beveled entry allows for easy insertion of cable bundle

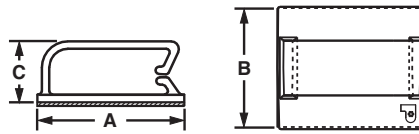

BEC

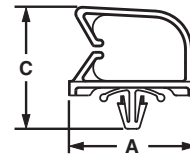

BECP

| Part Number            | Max. Bundle Diameter |      | Length A |      | Width B |      | Height C |      | Material                    | Color   | Environment | Mounting Method  | Std. Pkg. Qty. | Std. Ctn. Qty. |
|------------------------|----------------------|------|----------|------|---------|------|----------|------|-----------------------------|---------|-------------|------------------|----------------|----------------|
|                        | In.                  | mm   | In.      | mm   | In.     | mm   | In.      | mm   |                             |         |             |                  |                |                |
| <b>Adhesive Backed</b> |                      |      |          |      |         |      |          |      |                             |         |             |                  |                |                |
| BEC38-A-L              | 0.38                 | 9.6  | 1.46     | 37.1 | 1.24    | 31.5 | 0.52     | 13.2 | Nylon 6.6                   | Natural | Indoors     | Rubber Adhesive  | 50             | 500            |
| BEC38-A-L20            | 0.38                 | 9.6  | 1.46     | 37.1 | 1.24    | 31.5 | 0.52     | 13.2 |                             | Black   |             | Rubber Adhesive  | 50             | 500            |
| BEC38-AT-L0            | 0.38                 | 9.6  | 1.46     | 37.1 | 1.24    | 31.5 | 0.52     | 13.2 | Weather Resistant Nylon 6.6 | Black   | Outdoors    | Acrylic Adhesive | 50             | 500            |
| BEC62-A-L              | 0.62                 | 15.7 | 1.46     | 37.1 | 1.24    | 31.5 | 0.79     | 20.1 | Nylon 6.6                   | Natural | Indoors     | Rubber Adhesive  | 50             | 500            |
| BEC62-A-L20            | 0.62                 | 15.7 | 1.46     | 37.1 | 1.24    | 31.5 | 0.79     | 20.1 |                             | Black   |             | Rubber Adhesive  | 50             | 500            |
| BEC62-AT-L0            | 0.62                 | 15.7 | 1.46     | 37.1 | 1.24    | 31.5 | 0.79     | 20.1 | Weather Resistant Nylon 6.6 | Black   | Outdoors    | Acrylic Adhesive | 50             | 500            |
| BEC75-A-L              | 0.75                 | 19.0 | 1.46     | 37.1 | 1.49    | 37.8 | 0.89     | 22.6 | Nylon 6.6                   | Natural | Indoors     | Rubber Adhesive  | 50             | 500            |
| BEC75-A-L20            | 0.75                 | 19.0 | 1.46     | 37.1 | 1.49    | 37.8 | 0.89     | 22.6 |                             | Black   |             | Rubber Adhesive  | 50             | 500            |
| BEC75-AT-L0            | 0.75                 | 19.0 | 1.46     | 37.1 | 1.49    | 37.8 | 0.89     | 22.6 | Weather Resistant Nylon 6.6 | Black   | Outdoors    | Acrylic Adhesive | 50             | 500            |
| <b>Push Barb</b>       |                      |      |          |      |         |      |          |      |                             |         |             |                  |                |                |
| BECP38H25-L            | 0.38                 | 9.6  | 1.46     | 37.1 | 0.73    | 18.5 | 1.00     | 25.4 | Nylon 6.6                   | Natural | Indoors     | Push Barb        | 50             | 500            |
| BECP38H25-L20          | 0.38                 | 9.6  | 1.46     | 37.1 | 0.73    | 18.5 | 1.00     | 25.4 |                             | Black   |             |                  | 50             | 500            |
| BECP75H25-L            | 0.75                 | 19.0 | 1.47     | 37.3 | 0.73    | 18.5 | 1.35     | 34.3 |                             | Natural |             |                  | 50             | 500            |
| BECP75H25-L20          | 0.75                 | 19.0 | 1.47     | 37.3 | 0.73    | 18.5 | 1.35     | 34.3 |                             | Black   |             |                  | 50             | 500            |

\*For proper selection of adhesive see page B2.54.

A. System Overview

B1. Cable Ties

B2. Cable Accessories

B3. Stainless Steel Ties

C1. Wiring Duct

C2. Surface Raceway

C3. Abrasion Protection

C4. Cable Management

D1. Terminals

D2. Power Connectors

D3. Grounding Connectors

E1. Labeling Systems

E2. Labels

E3. Pre-Printed & Write-On Markers

E4. Permanent Identification

E5. Lockout/Tagout & Safety Solutions

F. Index

A. System Overview

## Adhesive Backed Dual Cord Clip

- Holds two cables in high temperature applications

B1. Cable Ties

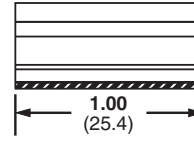
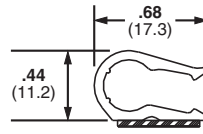

B2. Cable Accessories

B3. Stainless Steel Ties

| Part Number          | Max. Bundle Diameter |     | Material | Color | Environment | Adhesive Type | Std. Pkg. Qty. | Std. Ctn. Qty. |
|----------------------|----------------------|-----|----------|-------|-------------|---------------|----------------|----------------|
|                      | In.                  | mm  |          |       |             |               |                |                |
| <b>ADCC31-AT-C10</b> | 0.33                 | 9.0 | NORYL*   | White | Indoors     | Acrylic       | 100            | 500            |

\*NORYL Thermoplastic Resin is a registered trademark of General Electric Company.

C1. Wiring Duct

C2. Surface Raceway

## Adhesive Backed Mount Cord Clip

- Holds a single cable
- Vertical cable entry for ease of installation
- Funnel entry speeds cable insertion

C3. Abrasion Protection

C4. Cable Management

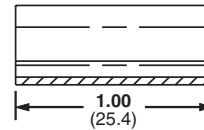
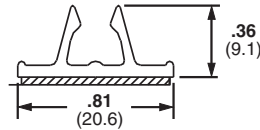

D1. Terminals

D2. Power Connectors

| Part Number         | Max. Bundle Diameter |           | Material | Color | Environment | Adhesive Type | Std. Pkg. Qty. | Std. Ctn. Qty. |
|---------------------|----------------------|-----------|----------|-------|-------------|---------------|----------------|----------------|
|                     | In.                  | mm        |          |       |             |               |                |                |
| <b>AMC25-AT-C10</b> | .22 – .28            | 6.0 – 7.0 | PVC      | White | Indoors     | Acrylic       | 100            | 1000           |

D3. Grounding Connectors

E1. Labeling Systems

## Vertical Cord Clips

- Funnel entry design allows for easy insertion of cords and cables
- Vertical cable entry for ease of installation
- For indoor use only

E2. Labels

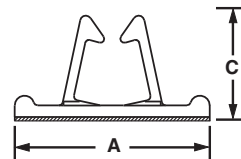
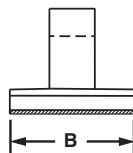
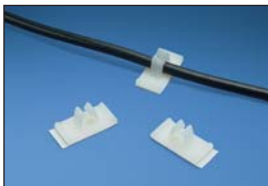

E3. Pre-Printed & Write-On Markers

E4. Permanent Identification

| Part Number      | Max. Bundle Diameter |      | Length A |      | Width B |      | Height C |      | Material  | Color   | Adhesive Type | Std. Pkg. Qty. | Std. Ctn. Qty. |
|------------------|----------------------|------|----------|------|---------|------|----------|------|-----------|---------|---------------|----------------|----------------|
|                  | In.                  | mm   | In.      | mm   | In.     | mm   | In.      | mm   |           |         |               |                |                |
| <b>VCC25-A-C</b> | 0.25                 | 6.4  | 1.00     | 25.4 | 0.50    | 12.7 | 0.44     | 11.2 | Nylon 6.6 | Natural | Rubber        | 100            | 500            |
| <b>VCC50-A-C</b> | 0.50                 | 12.7 | 1.56     | 39.7 | 1.00    | 25.4 | 0.81     | 20.6 |           | Natural |               | 100            | 500            |

E5. Lockout/Tagout & Safety Solutions

F. Index

## Adhesive Backed Latching Clips

- Latching cover withstands vibration

- For indoor use only

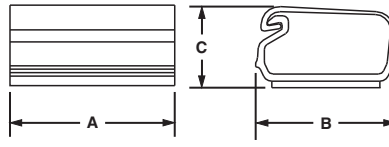

| Part Number | Max. Bundle Diameter |      | Length A |      | Width B |      | Height C |      | Material | Color      | Adhesive Type | Std. Pkg. Qty. | Std. Ctn. Qty. |
|-------------|----------------------|------|----------|------|---------|------|----------|------|----------|------------|---------------|----------------|----------------|
|             | In.                  | mm   | In.      | mm   | In.     | mm   | In.      | mm   |          |            |               |                |                |
| LC3-A-C8    | 0.20                 | 5.0  | 0.75     | 19.1 | 0.75    | 19.0 | 0.47     | 11.9 | PVC      | Light Gray | Rubber        | 100            | 1000           |
| LC5-A-C8    | 0.36                 | 9.1  | 1.01     | 25.7 | 1.01    | 25.7 | 0.61     | 15.5 |          |            |               | 100            | 1000           |
| LC10-A-L8   | 0.93                 | 23.6 | 1.51     | 38.4 | 1.51    | 38.4 | 0.84     | 21.3 |          |            |               | 50             | 500            |

## Cable Holder – Adhesive Backed

- Convenient releasable latch allows easy addition and removal of cables

- Low profile design provides a compact cable routing solution

- For indoor use only

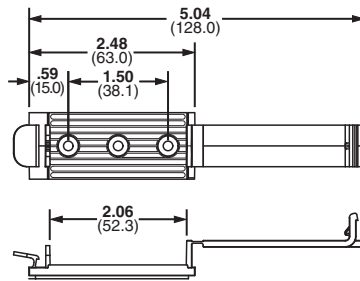

| Part Number  | Cable Width |      | Material  | Color | Mounting Method      | Std. Pkg. Qty. | Std. Ctn. Qty. |
|--------------|-------------|------|-----------|-------|----------------------|----------------|----------------|
|              | In.         | mm   |           |       |                      |                |                |
| CH105-A-C14  | 2.06        | 52.3 | Nylon 6.6 | Gray  | Rubber Adhesive Tape | 100            | 1000           |
| CH105-S6-C14 | 2.06        | 52.3 |           |       | #6 (M3) Screw        | 100            | 1000           |

## Low Profile Flat Cable Mounts

- Three sizes provide a cost effective flat cable containment for stack heights up to .105 inches (2.7mm)

- Low profile design holds wires, cables, and tubing

- For indoor use only

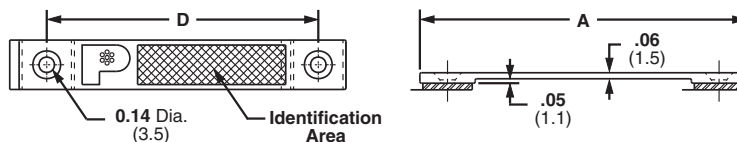
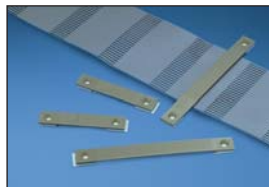

| Part Number   | Cable Width |      | Length A |       | Hole Spacing D |       | Material  | Color | Adhesive Type | Std. Pkg. Qty. | Std. Ctn. Qty. |
|---------------|-------------|------|----------|-------|----------------|-------|-----------|-------|---------------|----------------|----------------|
|               | In.         | mm   | In.      | mm    | In.            | mm    |           |       |               |                |                |
| LPFCM14-A-C14 | 1.44        | 37.0 | 2.56     | 65.0  | 2.00           | 50.8  | Nylon 6.6 | Gray  | Rubber        | 100            | 500            |
| LPFCM22-A-C14 | 2.19        | 56.0 | 3.31     | 84.0  | 2.75           | 69.9  |           |       |               | 100            | 500            |
| LPFCM34-A-C14 | 3.44        | 87.0 | 4.56     | 115.8 | 4.00           | 101.6 |           |       |               | 100            | 500            |



A. System Overview

B1. Cable Ties

B2. Cable Accessories

B3. Stainless Steel Ties

C1. Wiring Duct

C2. Surface Raceway

C3. Abrasion Protection

C4. Cable Management

D1. Terminals

D2. Power Connectors

D3. Grounding Connectors

E1. Labeling Systems

E2. Labels

E3. Pre-Printed & Write-On Markers

E4. Permanent Identification

E5. Lockout/Tagout & Safety Solutions

F. Index

## Latching Flat Cable Mounts

- Available in four sizes with a stack height of .17 inches (4.3mm) to accommodate different flat cable widths
- Low profile design holds wires, cables, and tubing
- Convenient releasable latch
- Large mounting base for high bonding strength
- For indoor use only
- Material: Nylon 6.6

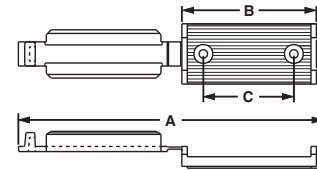
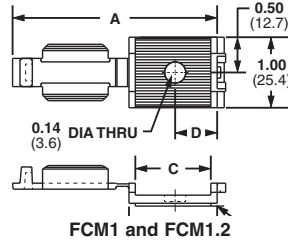

| Part Number            | Cable Width |      | Length A |       | Width B |      | Hole Spacing C |      | Color | Mounting Method | Std. Pkg. Qty. | Std. Ctn. Qty. |
|------------------------|-------------|------|----------|-------|---------|------|----------------|------|-------|-----------------|----------------|----------------|
|                        | In.         | mm   | In.      | mm    | In.     | mm   | In.            | mm   |       |                 |                |                |
| <b>Adhesive Backed</b> |             |      |          |       |         |      |                |      |       |                 |                |                |
| <b>FCM1-A-C14</b>      | 1.05        | 26.7 | 2.90     | 73.7  | 1.05    | 26.7 | —              | —    | Gray  | Rubber Adhesive | 100            | 500            |
| <b>FCM1.2-A-C14</b>    | 1.20        | 30.5 | 3.16     | 80.3  | 1.37    | 34.8 | —              | —    |       |                 | 100            | 1000           |
| <b>FCM2-A-C14</b>      | 2.05        | 52.1 | 5.06     | 128.5 | 2.22    | 56.4 | 1.53           | 38.9 |       |                 | 100            | 500            |
| <b>FCM3.25-A-L14</b>   | 3.38        | 85.9 | 7.30     | 185.4 | 3.38    | 85.9 | 1.50           | 38.1 |       |                 | 50             | 500            |
| <b>Screw Mounted</b>   |             |      |          |       |         |      |                |      |       |                 |                |                |
| <b>FCM1-S6-C14</b>     | 1.05        | 26.7 | 2.90     | 73.7  | 1.00    | 25.4 | —              | —    | Gray  | #6 (M3) Screw   | 100            | 1000           |
| <b>FCM1.2-S6-C14</b>   | 1.20        | 30.5 | 3.16     | 80.3  | 1.37    | 34.8 | —              | —    |       |                 | 100            | 1000           |
| <b>FCM2-S6-C14</b>     | 2.05        | 52.1 | 5.06     | 128.5 | 2.22    | 56.4 | 1.53           | 38.9 |       |                 | 100            | 1000           |
| <b>FCM3.25-S6-L14</b>  | 3.38        | 85.9 | 7.30     | 185.4 | 3.38    | 85.9 | 1.50           | 38.1 |       |                 | 50             | 500            |

## Latching Flat Cable Holders

- Low profile design holds wires, cables, and tubing
- Convenient releasable latch
- Large mounting base for high bonding strength
- For indoor use only
- See also Flat Cable Mounting System on Page B2.25
- Material: Nylon 6.6

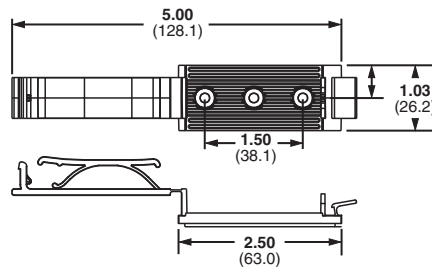

| Part Number        | Length |      | Cable Width |      | Color | Mounting Method | Std. Pkg. Qty. | Std. Ctn. Qty. |
|--------------------|--------|------|-------------|------|-------|-----------------|----------------|----------------|
|                    | In.    | mm   | In.         | mm   |       |                 |                |                |
| <b>FCH2-A-C14</b>  | 2.48   | 63.0 | 2.00        | 50.8 | Gray  | Rubber Adhesive | 100            | 500            |
| <b>FCH2-S6-C14</b> | 2.48   | 63.0 | 2.00        | 50.8 | Gray  | #6 (M3) Screw   | 100            | 500            |

See also Flat Cable Mounting System on Page B2.25.

## Flat Cable Clips

- Use with any width flat cable for a maximum stack height of .17 inches (4.3mm)
- Low profile design holds wires, cables, and tubing
- For indoor use only
- Material: PVC

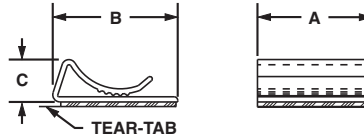
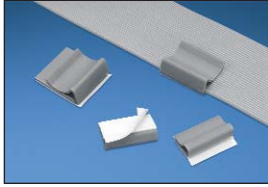

| Part Number | Cable Width          | Length A |      | Width B |      | Height C |     | Color | Mounting Method | Std. Pkg. Qty. | Std. Ctn. Qty. |
|-------------|----------------------|----------|------|---------|------|----------|-----|-------|-----------------|----------------|----------------|
|             |                      | In.      | mm   | In.     | mm   | In.      | mm  |       |                 |                |                |
| FCC5-A-C8   | Any width flat cable | 1.00     | 25.4 | .56     | 14.2 | .29      | 7.4 | Gray  | Rubber          | 100            | 1000           |
| FCC-A-C8    |                      | 1.00     | 25.4 | 1.09    | 27.7 | .38      | 9.7 |       |                 | 100            | 1000           |

## Pan-Clamp™ Heavy Duty Fixed Diameter Clamps

- One-piece design significantly reduces installation time
- Integrated ribs prevent rotation of cable bundles and ensures secure grip on hoses
- Material: Impact modified Weather Resistant Nylon 6.6

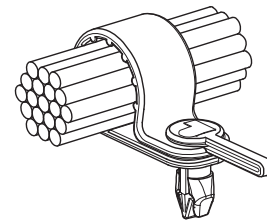
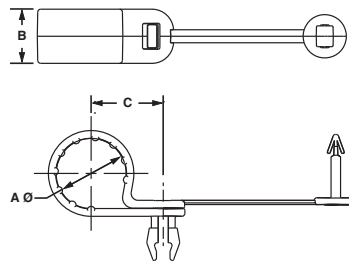

| Part Number   | Max. Bundle Diameter A |      | Width B |      | Bundle Offset C |      | Max. Panel Thickness |     | Panel Hole Diameter |     | Color | Std. Pkg. Qty. | Std. Ctn. Qty. |
|---------------|------------------------|------|---------|------|-----------------|------|----------------------|-----|---------------------|-----|-------|----------------|----------------|
|               | In.                    | mm   | In.     | mm   | In.             | mm   | In.                  | mm  | In.                 | mm  |       |                |                |
| PC038-H25D-C0 | .38                    | 9.5  | .62     | 15.7 | .64             | 16.3 | .13                  | 3.2 | .28                 | 7.1 | Black | 100            | 500            |
| PC050-H25D-C0 | .50                    | 12.7 | .62     | 15.7 | .71             | 17.9 | .13                  | 3.2 | .28                 | 7.1 |       | 100            | 500            |
| PC062-H25D-C0 | .63                    | 15.8 | .62     | 15.7 | .77             | 19.5 | .13                  | 3.2 | .28                 | 7.1 |       | 100            | 500            |
| PC075-H25D-C0 | .75                    | 19.1 | .62     | 15.7 | .83             | 21.1 | .13                  | 3.2 | .28                 | 7.1 |       | 100            | 1000           |
| PC087-H25D-C0 | .88                    | 22.1 | .62     | 15.7 | .89             | 22.7 | .13                  | 3.2 | .28                 | 7.1 |       | 100            | 1000           |
| PC100-H25D-C0 | 1.00                   | 25.4 | .62     | 15.7 | .96             | 24.3 | .13                  | 3.2 | .28                 | 7.1 |       | 100            | 1000           |
| PC112-H25D-C0 | 1.13                   | 28.5 | .62     | 15.7 | 1.02            | 25.8 | .13                  | 3.2 | .28                 | 7.1 |       | 100            | 1000           |
| PC125-H25D-C0 | 1.25                   | 31.8 | .62     | 15.7 | 1.08            | 27.4 | .13                  | 3.2 | .28                 | 7.1 |       | 100            | 1000           |

A.  
System  
Overview

## Fixed Diameter Cable Clamps

- Durable Nylon 6.6 cable clamps

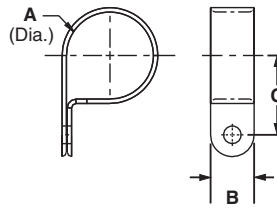

B1.  
Cable Ties

B2.  
Cable  
Accessories

B3.  
Stainless  
Steel Ties

C1.  
Wiring  
Duct

C2.  
Surface  
Raceway

C3.  
Abrasion  
Protection

C4.  
Cable  
Management

D1.  
Terminals

D2.  
Power  
Connectors

D3.  
Grounding  
Connectors

E1.  
Labeling  
Systems

E2.  
Labels

E3.  
Pre-Printed  
& Write-On  
Markers

E4.  
Permanent  
Identification

E5.  
Lockout/  
Tagout  
& Safety  
Solutions

F.  
Index

| Part Number         | Max. Bundle Diameter<br>A |      | Width<br>B |      | Bundle Offset<br>C |      | Mounting Method | Std. Pkg. Qty | Std. Ctn. Qty. |
|---------------------|---------------------------|------|------------|------|--------------------|------|-----------------|---------------|----------------|
|                     | In.                       | mm   | In.        | mm   | In.                | mm   |                 |               |                |
| <b>CCS12-S8-C</b>   | .12                       | 3.1  | .37        | 9.4  | .33                | 8.4  | #8 (M4) Screw   | 100           | 500            |
| <b>CCS19-S8-C</b>   | .19                       | 4.8  | .37        | 9.4  | .43                | 10.9 | #8 (M4) Screw   | 100           | 500            |
| <b>CCS25-S8-C</b>   | .25                       | 6.3  | .37        | 9.4  | .41                | 10.4 | #8 (M4) Screw   | 100           | 500            |
| <b>CCS25-S10-C</b>  | .25                       | 6.3  | .37        | 9.4  | .41                | 10.4 | #10 (M5) Screw  | 100           | 500            |
| <b>CCS31-S8-C</b>   | .31                       | 7.9  | .37        | 9.4  | .49                | 12.4 | #8 (M4) Screw   | 100           | 500            |
| <b>CCS38-S8-C</b>   | .38                       | 9.5  | .37        | 9.4  | .59                | 15.0 |                 | 100           | 500            |
| <b>CCS44-S8-C</b>   | .44                       | 11.1 | .37        | 9.4  | .57                | 14.5 |                 | 100           | 500            |
| <b>CCS50-S8-C</b>   | .50                       | 12.7 | .37        | 9.4  | .60                | 15.2 |                 | 100           | 500            |
| <b>CCH12-S10-C</b>  | .12                       | 3.1  | .50        | 12.7 | .36                | 9.1  | #10 (M5) Screw  | 100           | 500            |
| <b>CCH19-S10-C</b>  | .19                       | 4.8  | .50        | 12.7 | .42                | 10.7 |                 | 100           | 500            |
| <b>CCH25-S10-C</b>  | .25                       | 6.3  | .50        | 12.7 | .46                | 11.7 |                 | 100           | 500            |
| <b>CCH31-S10-C</b>  | .31                       | 7.9  | .50        | 12.7 | .50                | 12.7 |                 | 100           | 500            |
| <b>CCH38-S10-C</b>  | .38                       | 9.5  | .50        | 12.7 | .53                | 13.5 |                 | 100           | 500            |
| <b>CCH44-S10-C</b>  | .44                       | 11.1 | .50        | 12.7 | .56                | 14.2 |                 | 100           | 500            |
| <b>CCH50-S10-C</b>  | .50                       | 12.7 | .50        | 12.7 | .59                | 15.0 |                 | 100           | 500            |
| <b>CCH56-S10-C</b>  | .56                       | 14.2 | .50        | 12.7 | .61                | 15.5 |                 | 100           | 500            |
| <b>CCH62-S10-C</b>  | .62                       | 15.7 | .50        | 12.7 | .65                | 16.5 |                 | 100           | 500            |
| <b>CCH69-S10-C</b>  | .69                       | 17.5 | .50        | 12.7 | .75                | 19.1 |                 | 100           | 500            |
| <b>CCH75-S10-C</b>  | .75                       | 19.1 | .50        | 12.7 | .78                | 19.8 |                 | 100           | 500            |
| <b>CCH81-S10-C</b>  | .81                       | 20.6 | .50        | 12.7 | .81                | 20.6 |                 | 100           | 500            |
| <b>CCH87-S10-C</b>  | .87                       | 22.1 | .50        | 12.7 | .84                | 21.3 |                 | 100           | 500            |
| <b>CCH100-S10-C</b> | 1.00                      | 25.4 | .50        | 12.7 | .91                | 23.1 |                 | 100           | 500            |
| <b>CCH112-S10-C</b> | 1.12                      | 28.4 | .50        | 12.7 | .97                | 24.6 | 100             | 500           |                |
| <b>CCH119-S10-C</b> | 1.19                      | 30.2 | .50        | 12.7 | 1.00               | 25.4 | 100             | 500           |                |
| <b>CCH125-S10-C</b> | 1.25                      | 31.8 | .50        | 12.7 | 1.06               | 26.9 | 100             | 500           |                |
| <b>CCH138-S10-C</b> | 1.37                      | 34.8 | .50        | 12.7 | 1.12               | 28.4 | 100             | 500           |                |
| <b>CCH150-S10-C</b> | 1.50                      | 38.1 | .50        | 12.7 | 1.19               | 30.2 | 100             | 500           |                |

All parts listed are also available in black weather resistant material (add suffix 0). Bulk package only.

## Wire Retainers

- Wires slide into the clip and are held in place by tension
- Low profile design holds wires, cables, and tubing
- Funnel entry design allows for easy insertion of cords and cables

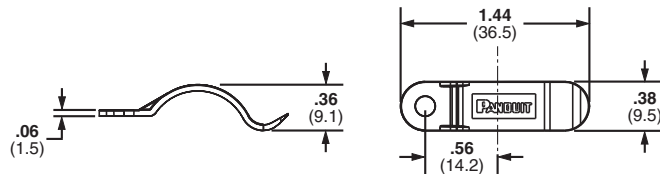

| Part Number | Max. Bundle Diameter |     | Material                    | Color   | Environment | Mounting Method | Std. Pkg. Qty. | Std. Ctn. Qty. |
|-------------|----------------------|-----|-----------------------------|---------|-------------|-----------------|----------------|----------------|
|             | In.                  | mm  |                             |         |             |                 |                |                |
| TWR-C       | 0.38                 | 9.5 | Nylon 6.6                   | Natural | Indoors     | #6 (M3) Screw   | 100            | 500            |
| TWR-C0      | 0.38                 | 9.5 | Weather Resistant Nylon 6.6 | Black   | Outdoors    |                 | 100            | 500            |

## Siding Clips

- Low profile installs without drilling or nailing
- Attach coax cable to buildings having "Pittsburgh Interlok" type aluminum or steel siding
- Will not corrode or stain siding

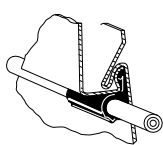

Horizontal Siding Clip

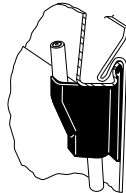

Vertical Siding Clip

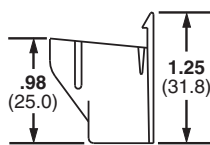

VSC Vertical Clip

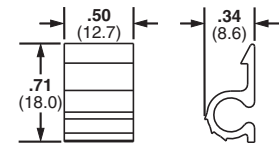
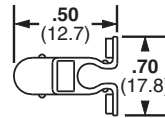

HSC Horizontal Clip

| Part Number | Max. Bundle Diameter |     | Material                        | Color | Mounting Method | Std. Pkg. Qty. | Std. Ctn. Qty. |
|-------------|----------------------|-----|---------------------------------|-------|-----------------|----------------|----------------|
|             | In.                  | mm  |                                 |       |                 |                |                |
| HSC.25-L    | 0.25                 | 6.4 | Nylon 6.6                       | White | Clip            | 50             | 500            |
| HSC.25-L100 | 0.25                 | 6.4 | Weather Resistant Polypropylene | Black |                 | 50             | 500            |
| VSC.25-L    | 0.25                 | 6.4 | Nylon 6.6                       | White |                 | 50             | 500            |
| VSC.25-L100 | 0.25                 | 6.4 | Weather Resistant Polypropylene | Black |                 | 50             | 500            |

A.  
System  
Overview

## Wire Standoffs

B1.  
Cable Ties

- For retaining wires, cable, components or tubing away from panel or conductive chassis
- Design of wing provides added stability
- Material: Nylon 6.6
- Finger grip flanges can be easily locked or unlocked for revisions
- For indoor use only

B2.  
Cable  
Accessories

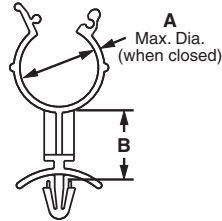

B3.  
Stainless  
Steel Ties

C1.  
Wiring  
Duct

C2.  
Surface  
Raceway

C3.  
Abrasion  
Protection

C4.  
Cable  
Management

D1.  
Terminals

D2.  
Power  
Connectors

D3.  
Grounding  
Connectors

E1.  
Labeling  
Systems

E2.  
Labels

E3.  
Pre-Printed  
& Write-On  
Markers

E4.  
Permanent  
Identification

E5.  
Lockout/  
Tagout  
& Safety  
Solutions

F.  
Index

| Part Number | Max. Bundle Diameter<br>A |      | Standoff Height<br>B |      | Max. Panel Thickness |     | Panel Hole Diameter |     | Color   | Mounting Method | Std. Pkg. Qty. | Std. Ctn. Qty. |
|-------------|---------------------------|------|----------------------|------|----------------------|-----|---------------------|-----|---------|-----------------|----------------|----------------|
|             | In.                       | mm   | In.                  | mm   | In.                  | mm  | In.                 | mm  |         |                 |                |                |
| WS25-25-C   | .25                       | 6.4  | .25                  | 6.4  | .08                  | 2.0 | .19                 | 4.7 | Natural | Push Barb       | 100            | 500            |
| WS25-50-C   | .25                       | 6.4  | .50                  | 12.7 | .08                  | 2.0 | .19                 | 4.7 |         |                 | 100            | 500            |
| WS25-75-C   | .25                       | 6.4  | .75                  | 19.1 | .08                  | 2.0 | .19                 | 4.7 |         |                 | 100            | 500            |
| WS35-25-C   | .35                       | 8.9  | .25                  | 6.4  | .08                  | 2.0 | .19                 | 4.7 |         |                 | 100            | 500            |
| WS35-50-C   | .35                       | 8.9  | .50                  | 12.7 | .08                  | 2.0 | .19                 | 4.7 |         |                 | 100            | 500            |
| WS35-75-C   | .35                       | 8.9  | .75                  | 19.1 | .08                  | 2.0 | .19                 | 4.7 |         |                 | 100            | 500            |
| WS50-25-C   | .47                       | 11.9 | .25                  | 6.4  | .08                  | 2.0 | .19                 | 4.7 |         |                 | 100            | 500            |
| WS50-50-C   | .47                       | 11.9 | .50                  | 12.7 | .08                  | 2.0 | .19                 | 4.7 |         |                 | 100            | 500            |
| WS50-75-C   | .47                       | 11.9 | .75                  | 19.1 | .08                  | 2.0 | .19                 | 4.7 |         |                 | 100            | 500            |
| WS75-25-C   | .78                       | 19.8 | .25                  | 6.4  | .08                  | 2.0 | .19                 | 4.7 |         |                 | 100            | 500            |
| WS75-50-C   | .78                       | 19.8 | .50                  | 12.7 | .08                  | 2.0 | .19                 | 4.7 |         |                 | 100            | 500            |
| WS75-75-C   | .78                       | 19.8 | .75                  | 19.1 | .08                  | 2.0 | .19                 | 4.7 |         |                 | 100            | 500            |

## ® Snap-In Clips

- Clip around bundle to hold securely in place
- Clips are placed on the bundle then attached to the panel
- Material: Nylon 6.6
- For indoor use only

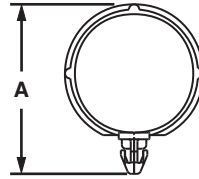

| Part Number | Max. Bundle Diameter |      | Height A |      | Max. Panel Thickness |     | Panel Hole Diameter |     | Color   | Mounting Method | Std. Pkg. Qty. | Std. Ctn. Qty. |
|-------------|----------------------|------|----------|------|----------------------|-----|---------------------|-----|---------|-----------------|----------------|----------------|
|             | In.                  | mm   | In.      | mm   | In.                  | mm  | In.                 | mm  |         |                 |                |                |
| SICH25-C    | .25                  | 6.4  | .40      | 20.9 | .10                  | 2.5 | .25                 | 6.4 | Natural | Push Barb       | 100            | 500            |
| SICH38-C    | .38                  | 9.7  | .54      | 24.9 | .10                  | 2.5 | .25                 | 6.4 |         |                 | 100            | 500            |
| SICH50-C    | .50                  | 12.7 | .67      | 28.2 | .10                  | 2.5 | .25                 | 6.4 |         |                 | 100            | 500            |
| SICH75-C    | .75                  | 19.1 | .96      | 35.6 | .10                  | 2.5 | .25                 | 6.4 |         |                 | 100            | 500            |
| SICH100-C   | 1.00                 | 25.4 | 1.21     | 41.9 | .10                  | 2.5 | .25                 | 6.4 |         |                 | 100            | 500            |
| SICH150-C   | 1.50                 | 38.0 | 1.71     | 54.6 | .10                  | 2.5 | .25                 | 6.4 |         |                 | 100            | 500            |

## ® Wire Saddles

- Funnel entry design for fast insertion of wires and cables
- Available in vertical and horizontal loading configurations
- Design of wing provides added stability
- Material: Nylon 6.6
- For indoor use only

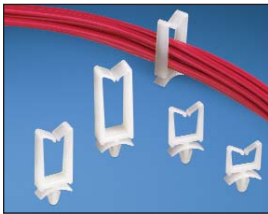

VWS Vertical

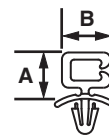

HWS Horizontal

| Part Number | Max. Bundle Capacity |             | Height A |      | Width B |      | Max. Panel Thickness |     | Panel Hole Diameter |     | Color   | Mounting Method | Std. Pkg. Qty. | Std. Ctn. Qty. |
|-------------|----------------------|-------------|----------|------|---------|------|----------------------|-----|---------------------|-----|---------|-----------------|----------------|----------------|
|             | In.                  | mm          | In.      | mm   | In.     | mm   | In.                  | mm  | In.                 | mm  |         |                 |                |                |
| VWS4218-C   | 0.18 x 0.42          | 5.0 x 10.7  | 0.58     | 14.7 | 0.60    | 15.2 | 0.08                 | 2.0 | 0.19                | 4.7 | Natural | Push Barb       | 100            | 500            |
| VWS4238-C   | 0.40 x 0.42          | 10.2 x 10.7 | 0.78     | 19.8 | 0.60    | 15.2 | 0.08                 | 2.0 | 0.19                | 4.7 |         |                 | 100            | 500            |
| VWS4274-C   | 0.74 x 0.42          | 19.0 x 10.7 | 1.14     | 29.0 | 0.60    | 15.2 | 0.08                 | 2.0 | 0.19                | 4.7 |         |                 | 100            | 500            |
| VWS42105-C  | 1.05 x .42           | 27.0 x 10.7 | 1.45     | 36.8 | 0.60    | 15.2 | 0.08                 | 2.0 | 0.19                | 4.7 |         |                 | 100            | 1000           |
| HWS2819-C   | 0.19 x 0.28          | 5.0 x 7.1   | 0.42     | 10.7 | 0.44    | 11.2 | 0.08                 | 2.0 | 0.19                | 4.7 |         |                 | 100            | 500            |



A. System Overview



## Corrugated Tubing Holder with Push Mount

B1. Cable Ties

- Use to secure and route all standard sizes of solid wall or slit corrugated loom tubing
- Ribs prevent lateral movement of corrugated loom tubing along the mount

- Rugged clip prevents accidental disassembly of tubing due to shock or vibration

B2. Cable Accessories

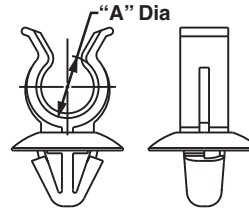

B3. Stainless Steel Ties

C1. Wiring Duct

C2. Surface Raceway

C3. Abrasion Protection

C4. Cable Management

| Part Number  | Nominal Diameter A |    | Max. Panel Thickness |     | Panel Hole Diameter |     | Std. Pkg. Qty. | Std. Ctn. Qty. |
|--------------|--------------------|----|----------------------|-----|---------------------|-----|----------------|----------------|
|              | In.                | mm | In.                  | mm  | In.                 | mm  |                |                |
| CTH19U04-C30 | 0.19               | 5  | 0.125                | 3.2 | 0.386               | 9.8 | 100            | —              |
| CTH35U08-C30 | 0.35               | 9  | 0.125                | 3.2 | 0.386               | 9.8 | 100            | 500            |
| CTH38U10-C30 | 0.38               | 10 | 0.125                | 3.2 | 0.386               | 9.8 | 100            | —              |
| CTH50U13-C30 | 0.50               | 13 | 0.125                | 3.2 | 0.386               | 9.8 | 100            | —              |
| CTH62U17-C30 | 0.62               | 17 | 0.125                | 3.2 | 0.386               | 9.8 | 100            | —              |
| CTH87U22-C30 | 0.87               | 22 | 0.125                | 3.2 | 0.386               | 9.8 | 100            | —              |

D1. Terminals

## Harness Clips

D2. Power Connectors

- Integral "spring" holds wire bundles tightly
- Available in vertical and horizontal loading configurations

- Design of wing provides added stability

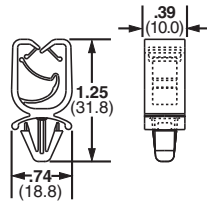

HCMP06B

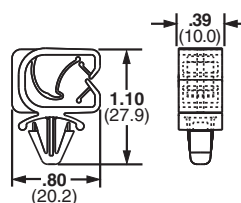

HCMP06C

D3. Grounding Connectors

E1. Labeling Systems

E2. Labels

| Part Number   | Max. Bundle Diameter Range |            | Max. Panel Thickness |     | Panel Hole Diameter |     | Material  | Color | Mounting Method | Std. Pkg. Qty. | Std. Ctn. Qty. |
|---------------|----------------------------|------------|----------------------|-----|---------------------|-----|-----------|-------|-----------------|----------------|----------------|
|               | In.                        | mm         | In.                  | mm  | In.                 | mm  |           |       |                 |                |                |
| HCMP06B12-C20 | .24 - .47                  | 5.9 - 12.5 | .118                 | 3.0 | .25                 | 6.4 | Nylon 6.6 | Black | Push Mount      | 100            | 500            |
| HCMP06C12-C20 | .24 - .47                  | 5.9 - 12.5 | .105                 | 2.7 | .25                 | 6.4 |           |       |                 | 100            | 500            |

E4. Permanent Identification

E5. Lockout/Tagout & Safety Solutions

F. Index

## Optical Fiber Network Saddles

• Use in pre-drilled .18 inch (4.0mm) holes in panels up to .09 inch (2.0mm) thick

• Smooth rounded edges eliminate potential for snagging and stress on cable

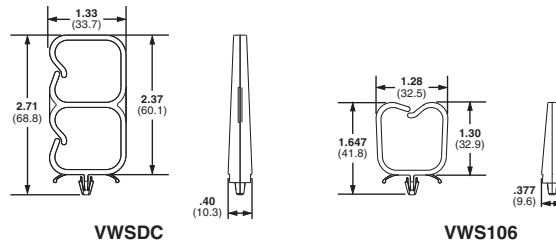

| Part Number | Max. Bundle Diameter |      | Material  | Mounting Method | Color   | Std. Pkg. Qty. | Std. Ctn. Qty. |
|-------------|----------------------|------|-----------|-----------------|---------|----------------|----------------|
|             | In.                  | mm   |           |                 |         |                |                |
| VWSDC-C*    | 1.06                 | 26.9 | Nylon 6.6 | Push Barb       | Natural | 100            | 500            |
| VWSDC-C20*  | 1.06                 | 26.9 | Nylon 6.6 | Push Barb       | Black   | 100            | —              |
| VWS106-C    | 1.06                 | 26.9 | Nylon 6.6 | Push Barb       | Natural | 100            | 500            |
| VWS106-C20  | 1.06                 | 26.9 | Nylon 6.6 | Push Barb       | Black   | 100            | 500            |

\*Accepts two bundles.

## Nylon Edge Clips

• Integral “spring” holds wire bundles tightly  
• Available in vertical and horizontal loading configurations

• Design of wing provides added stability  
• Indoor/Outdoor use

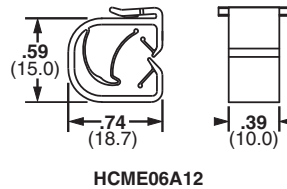

| Part Number    | Max. Bundle Diameter Range |            | Max. Panel Thickness |     | Material                  | Color | Mounting Method | Std. Pkg. Qty. | Std. Ctn. Qty. |
|----------------|----------------------------|------------|----------------------|-----|---------------------------|-------|-----------------|----------------|----------------|
|                | In.                        | mm         | In.                  | mm  |                           |       |                 |                |                |
| HCME04Y09-C30* | 0.16 – 0.35                | 4.0 – 9.0  | 0.16                 | 4.0 | Nylon 6.6 Heat Stabilized | Black | Clip onto Edge  | 100            | —              |
| HCME06A12-C130 | 0.24 – 0.47                | 5.9 – 12.5 | 0.05                 | 1.2 | Acetal Heat Stabilized    |       |                 | 100            | 500            |
| HCME06Y12-C30* | 0.31 – 0.47                | 8.0 – 12.0 | 0.16                 | 4.0 | Nylon 6.6 Heat Stabilized |       |                 | 100            | —              |

\*Bulk packaging size available.

## Wire Bundle Strap

• Securely routes large cable bundles

• Rounded edges prevent damage to cable jackets

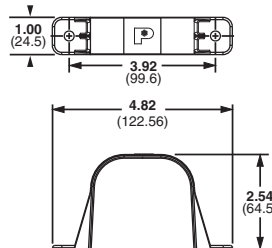

| Part Number | Bundle Retaining Area In. <sup>2</sup> | Material | Color | Mounting Method      | Std. Pkg. Qty. | Std. Ctn. Qty. |
|-------------|--|----------|-------|----------------------|----------------|----------------|
| WBS6-Q      | 6.00                                   | ABS      | White | (2) 1/4" (M6) Screws | 25             | 125            |

A. System Overview

## Circuit Board Posts

B1. Cable Ties

- For board-to-board or board-to-chassis mounting
- Bell flange on bottom end provides greater stability
- Releasable and reusable

- Material: Nylon 6.6
- Color: Natural

B2. Cable Accessories



B3. Stainless Steel Ties

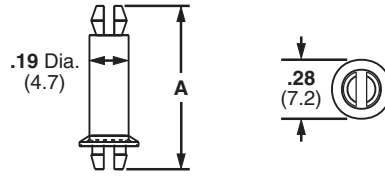

| Part Number     | Standoff Height |      | Height A |      | Panel Hole Diameter |      | Mounting Method | Std. Pkg. Qty. | Std. Ctn. Qty. |
|-----------------|-----------------|------|----------|------|---------------------|------|-----------------|----------------|----------------|
|                 | In.             | mm   | In.      | mm   | In.                 | mm   |                 |                |                |
| <b>CBP12-C</b>  | .12             | 3.0  | .40      | 10.2 | .156                | 3.96 | Push Barb       | 100            | 500            |
| <b>CBP25-C</b>  | .25             | 6.4  | .54      | 13.5 | .156                | 3.96 |                 | 100            | 500            |
| <b>CBP31-C</b>  | .31             | 7.9  | .59      | 15.0 | .156                | 3.96 |                 | 100            | 500            |
| <b>CBP37-C</b>  | .37             | 9.4  | .62      | 15.7 | .156                | 3.96 |                 | 100            | 500            |
| <b>CBP50-C</b>  | .50             | 12.7 | .78      | 19.8 | .156                | 3.96 |                 | 100            | 500            |
| <b>CBP62-C</b>  | .62             | 15.7 | .91      | 23.0 | .156                | 3.96 |                 | 100            | 500            |
| <b>CBP75-C</b>  | .75             | 19.1 | 1.04     | 26.2 | .156                | 3.96 |                 | 100            | 500            |
| <b>CBP87-C</b>  | .87             | 22.1 | 1.15     | 29.2 | .156                | 3.96 |                 | 100            | 500            |
| <b>CBP100-C</b> | 1.00            | 25.4 | 1.28     | 32.5 | .156                | 3.96 |                 | 100            | 500            |

C1. Wiring Duct

C2. Surface Raceway

C3. Abrasion Protection

C4. Cable Management

D1. Terminals

## Circuit Board Locking Supports

D2. Power Connectors

- For board-to-chassis support
- Snap-in design for fast assembly
- Design of wing provides added stability

- Releasable and reusable
- Material: Nylon 6.6

D3. Grounding Connectors

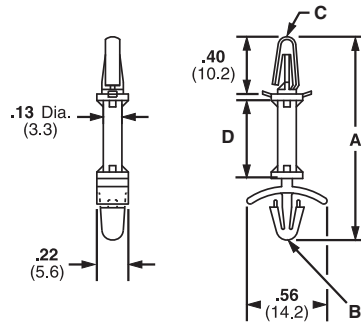

E1. Labeling Systems

E2. Labels

| Part Number     | Height A |      | Panel Hole Diameter B |     | Chassis Panel Hole Diameter C |     | Standoff Height D |      | Color   | Mounting Method | Std. Pkg. Qty. | Std. Ctn. Qty. |
|-----------------|----------|------|-----------------------|-----|-------------------------------|-----|-------------------|------|---------|-----------------|----------------|----------------|
|                 | In.      | mm   | In.                   | mm  | In.                           | mm  | In.               | mm   |         |                 |                |                |
| <b>CBLS18-C</b> | .92      | 23.4 | .19                   | 4.8 | .16                           | 4.0 | .19               | 4.7  | Natural | Push Barb       | 100            | 500            |
| <b>CBLS25-C</b> | .98      | 24.9 | .19                   | 4.8 | .16                           | 4.0 | .25               | 6.4  |         |                 | 100            | 500            |
| <b>CBLS37-C</b> | 1.11     | 28.2 | .19                   | 4.8 | .16                           | 4.0 | .38               | 9.5  |         |                 | 100            | 500            |
| <b>CBLS50-C</b> | 1.23     | 31.2 | .19                   | 4.8 | .16                           | 4.0 | .50               | 12.7 |         |                 | 100            | 500            |
| <b>CBLS62-C</b> | 1.35     | 34.3 | .19                   | 4.8 | .16                           | 4.0 | .63               | 15.9 |         |                 | 100            | 500            |
| <b>CBLS75-C</b> | 1.48     | 37.5 | .19                   | 4.8 | .16                           | 4.0 | .75               | 19.1 |         |                 | 100            | 500            |

E4. Permanent Identification

E5. Lockout/Tagout & Safety Solutions

F. Index

## Harness Board Accessories

Panduit harness board accessories provide fast routing and forming of wires in harness fabrication. They hold the wires off the harness board at a uniform height for easy application of cable ties. The accessories are designed for use with various Panduit cable tie installation tools. To maintain the harness at a uniform height of approx. 1.33 inches (33.8mm) (at the center of the harness) above the board, use RER Elastic Retainers, BR.75-E6 or BR.5-E6, CPH.75-S8, TJF and SHH1-S8 or SHH3-S8 harness board accessories. This height is suitable for use with PAT1M Automatic Cable Tie Installation Tool.



## Elastic Retainers

- Cable bundles are formed as individual wires are inserted
- Completed bundles can be easily removed
- The elastic band is replaceable
- For indoor use only

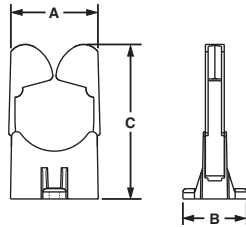

### Replacement Elastic

| Part Number | Pkg. Qty. |
|-------------|-----------|
| RER.5E-X    | 10        |
| RER.75E-X   | 10        |
| RER1.25E-X  | 10        |
| RER2.0E-X   | 10        |

For economy, the elastic band can be replaced in the RER Elastic Retainers without removing the RER base.

| Part Number  | Max. Bundle Diameter |      | Length A |      | Width B |      | Height C |       | Material  | Color                 | Mounting Method    | Std. Pkg. Qty. | Std. Ctn. Qty. |
|--------------|----------------------|------|----------|------|---------|------|----------|-------|-----------|-----------------------|--------------------|----------------|----------------|
|              | In.                  | mm   | In.      | mm   | In.     | mm   | In.      | mm    |           |                       |                    |                |                |
| RER.5-S6-X   | 0.50                 | 12.7 | 1.18     | 30.0 | 0.84    | 21.3 | 1.89     | 48.0  | Nylon 6.6 | Black Base, White Arm | Two #6 (M3) Screws | 10             | 50             |
| RER.75-S6-X  | 0.75                 | 19.0 | 1.18     | 30.0 | 1.12    | 28.4 | 2.21     | 56.1  |           |                       |                    | 10             | 50             |
| RER1.25-S6-X | 1.25                 | 31.8 | 1.18     | 30.0 | 1.64    | 41.7 | 2.86     | 72.6  |           | 10                    |                    | 50             |                |
| RER2.0-S6-X  | 2.00                 | 50.8 | 1.31     | 33.3 | 2.81    | 71.4 | 3.94     | 100.2 |           | Natural               |                    | 10             | 50             |



## Elastic Retainers – ER Type

- Cable bundles are formed as cable bundles are inserted
- Completed bundles can be easily removed
- For indoor use only

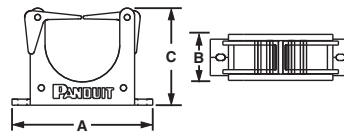

| Part Number | Max. Bundle Diameter |      | Length A |      | Width B |      | Height C |      | Material  | Color | Mounting Method    | Std. Pkg. Qty. | Std. Ctn. Qty. |
|-------------|----------------------|------|----------|------|---------|------|----------|------|-----------|-------|--------------------|----------------|----------------|
|             | In.                  | mm   | In.      | mm   | In.     | mm   | In.      | mm   |           |       |                    |                |                |
| ER.5-E4-X   | .50                  | 12.7 | 1.96     | 49.8 | .56     | 14.2 | 1.00     | 25.4 | Nylon 6.6 | Black | Two #6 (M3) Screws | 10             | 100            |
| ER1.25-E4-X | 1.25                 | 31.8 | 2.90     | 73.7 | .95     | 24.1 | 2.00     | 50.8 |           |       |                    | 10             | 100            |

A. System Overview

B1. Cable Ties

B2. Cable Accessories

B3. Stainless Steel Ties

C1. Wiring Duct

C2. Surface Raceway

C3. Abrasion Protection

C4. Cable Management

D1. Terminals

D2. Power Connectors

D3. Grounding Connectors

E1. Labeling Systems

E2. Labels

E3. Pre-Printed & Write-On Markers

E4. Permanent Identification

E5. Lockout/Tagout & Safety Solutions

F. Index

## Bundle Retainers

- Funnel entry allows fast cable insertion
- Completed bundles can be easily removed
- For indoor use only
- Color: Black

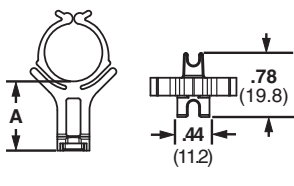

BR.5 and BR.75

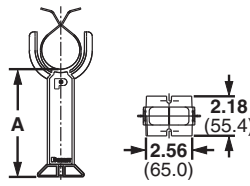

BR2

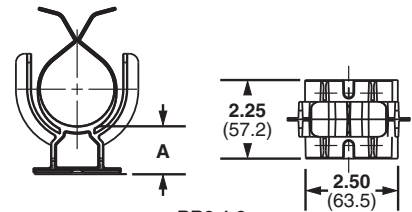

BR2-1.3

| Part Number | Max. Bundle Diameter |      | Standoff Height A |       | Material                   | Mounting Method      | Std. Pkg. Qty. | Std. Ctn. Qty. |
|-------------|----------------------|------|-------------------|-------|----------------------------|----------------------|----------------|----------------|
|             | In.                  | mm   | In.               | mm    |                            |                      |                |                |
| BR.5-E6-C   | 0.50                 | 12.7 | 1.07              | 27.2  | Impact Resistant Nylon 6.6 | Two #6 (M3) Screws   | 100            | 500            |
| BR.75-E6-C  | 0.75                 | 19.0 | 0.95              | 24.1  |                            |                      | 100            | 500            |
| BR2-1.3-X   | 2.00                 | 50.8 | 1.32              | 33.5  | Glass Filled Nylon 6.6     | Two 1/4" (M6) Screws | 10             | 10             |
| BR2-1.3-A-X | 2.00                 | 50.8 | 1.35              | 34.3  |                            | Rubber Adhesive Tape | 10             | 10             |
| BR2-1.5-X   | 2.00                 | 50.8 | 1.59              | 40.4  |                            | Two 1/4" (M6) Screws | 10             | 10             |
| BR2-4-X     | 2.00                 | 50.8 | 4.06              | 103.1 |                            |                      | 10             | 10             |
| BR2-6-X     | 2.00                 | 50.8 | 6.02              | 152.9 |                            | 10                   | 10             |                |

## Corner Posts

- Designed to pre-form tight bundles at harness corners and breakouts
- Top arm rotates upward for easy removal of completed harness
- For indoor use only

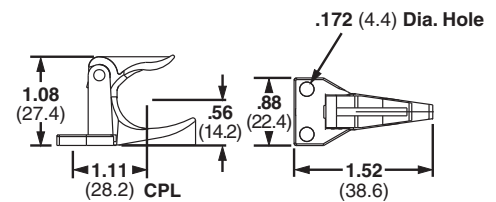
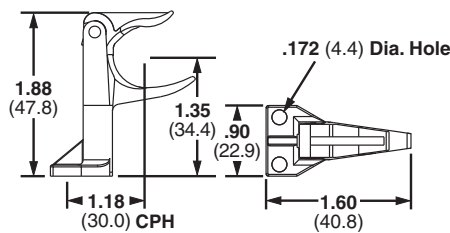

| Part Number | Max. Bundle Diameter |      | Material  | Color | Mounting Method    | Std. Pkg. Qty. | Std. Ctn. Qty. |
|-------------|----------------------|------|-----------|-------|--------------------|----------------|----------------|
|             | In.                  | mm   |           |       |                    |                |                |
| CPH.75-S8-X | .75                  | 19.0 | Nylon 6.6 | Black | Two #8 (M4) Screws | 10             | 100            |
| CPL.75-S8-X |                      |      |           |       |                    |                |                |

## T-Junction Fixture

- Forms cable junctions
- Fixture moves down for easy harness removal
- For indoor use only

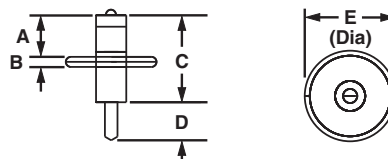

| Part Number | Max. Bundle Diameter |      | Material                          | Color | Mounting Method | Std. Pkg. Qty. | Std. Ctn. Qty. |
|-------------|----------------------|------|-----------------------------------|-------|-----------------|----------------|----------------|
|             | In.                  | mm   |                                   |       |                 |                |                |
| TJF-X       | 1.34                 | 34.0 | Nylon 6.6 and Nickel Plated Steel | Black | Nail            | 10             | 100            |

## Wire End Holder

- Secures wire ends while harness is being fabricated
- Used with #28 thru #16 AWG wires

- For indoor use only

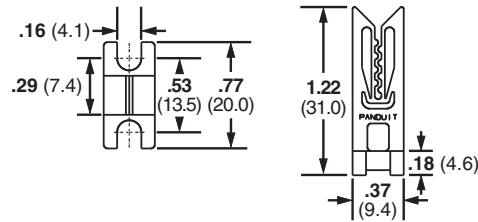
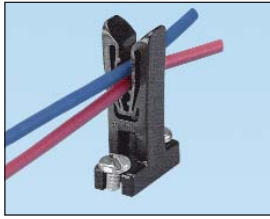

| Part Number | Material | Color | Mounting Method    | Std. Pkg. Qty. | Std. Ctn. Qty. |
|-------------|----------|-------|--------------------|----------------|----------------|
| WEH-E8-C    | Acetal   | Black | Two #8 (M4) Screws | 100            | 1000           |

## Harness Board Nails

- Speed routing of wires
- Uniform driving depth is insured by a collar stop

- Smooth finish on nails prevents abrasion to wire jackets
- For indoor use only

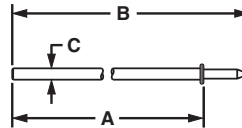

| Part Number | Length A |       | Overall Length B |       | Thickness C |     | Material            | Mounting Method             | Std. Pkg. Qty. | Std. Ctn. Qty. |
|-------------|----------|-------|------------------|-------|-------------|-----|---------------------|-----------------------------|----------------|----------------|
|             | In.      | mm    | In.              | mm    | In.         | mm  |                     |                             |                |                |
| HBN.75-T    | .75      | 19.1  | 1.40             | 35.6  | .07         | 1.9 | Nickel Plated Steel | Hammered into harness board | 200            | 1000           |
| HBN1-T      | 1.00     | 25.4  | 1.65             | 41.9  | .07         | 1.9 |                     |                             | 200            | 1000           |
| HBN1.5-T    | 1.50     | 38.1  | 2.16             | 54.9  | .08         | 2.1 |                     |                             | 200            | 1000           |
| HBN2-T      | 2.00     | 50.8  | 2.66             | 67.6  | .09         | 2.4 |                     |                             | 200            | 1000           |
| HBN2.5-T    | 2.50     | 63.5  | 3.16             | 80.3  | .11         | 2.8 |                     |                             | 200            | 1000           |
| HBN3-T      | 3.00     | 76.2  | 3.67             | 93.2  | .12         | 3.0 |                     |                             | 200            | 1000           |
| HBN4-T      | 4.00     | 101.6 | 4.67             | 118.6 | .14         | 3.7 |                     |                             | 200            | 1000           |



A. System Overview

## Fanning Strip System

- Holds wires in a specific orientation
- No sharp edges to damage wire insulation
- Will accept wires up to 18 AWG
- Fanning strip can remain as part of completed harness

B1. Cable Ties

B2. Cable Accessories

B3. Stainless Steel Ties

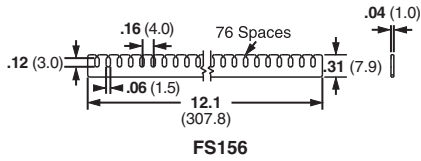

FS156

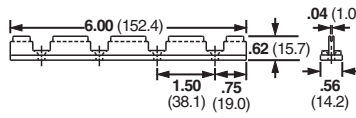

FSH40

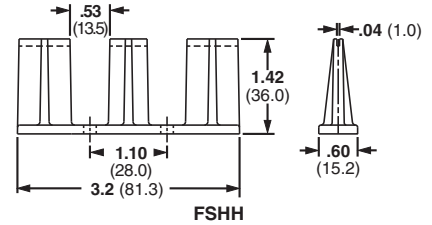

FSHH

C1. Wiring Duct

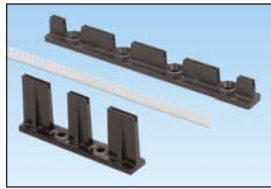

C2. Surface Raceway

| Part Number | Material  | Color   | Mounting Method     | Std. Pkg. Qty. | Std. Ctn. Qty. |
|-------------|-----------|---------|---------------------|----------------|----------------|
| FS156-C     | Nylon 6.6 | Natural | FSH Holder          | 100            | 1000           |
| FSH40-X     | ABS       | Black   | Four #8 (M4) Screws | 10             | 100            |
| FSHH-X      |           |         | Two #8 (M4) Screws  | 10             | 100            |

C3. Abrasion Protection

C4. Cable Management

## Spring Wire Breakout System

- Harness board spring and spring holder holds wire ends secure while harness is being fabricated
- Wires simply pull out from spring when harness is removed
- Each SHH Spring Holder is supplied with one rigid wire piece to hold the spring laterally and two #8 (M4), 2" (50.8mm) hex head wood screws; purchase spring separately

D1. Terminals

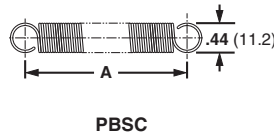
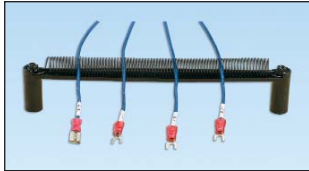

PBSC

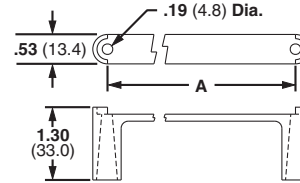

SHH

D2. Power Connectors

D3. Grounding Connectors

| Part Number | Hole Spacing A |       | Material  | Color   | Mounting Method    | Std. Pkg. Qty. | Std. Ctn. Qty. |
|-------------|----------------|-------|-----------|---------|--------------------|----------------|----------------|
|             | In.            | mm    |           |         |                    |                |                |
| PBSC1-X     | 1.00           | 25.4  | Steel     | —       | SHH1 Spring Holder | 10             | 100            |
| PBSC3-X     | 3.00           | 76.2  |           | —       | Two #8 (M4) Screws | 10             | 100            |
| PBSC6-X     | 6.00           | 152.4 |           | —       | SHH3 Spring Holder | 10             | 100            |
| PBSC12-X    | 12.00          | 304.8 |           | —       | Two #8 (M4) Screws | 10             | 100            |
| SHH1-S8-X   | 1.85           | 47.0  | Nylon 6.6 | Natural | Two #8 (M4) Screws | 10             | 100            |
| SHH3-S8-X   | 6.80           | 172.7 |           |         | Two #8 (M4) Screws | 10             | 100            |

E1. Labeling Systems

E2. Labels

E3. Pre-Printed & Write-On Markers

E4. Permanent Identification

E5. Lockout/Tagout & Safety Solutions

F. Index

## Tie Harness Mounts

- Designed to be attached to the wire harness during assembly
- Cable ties can be installed by hand or with Panduit automatic cable tie tools
- Used with harness board standoff posts
- Available with or without corrugated tubing location tab
- Natural nylon material for indoor use
- Heat stabilized nylon material (30) for high temperature applications – indoor use

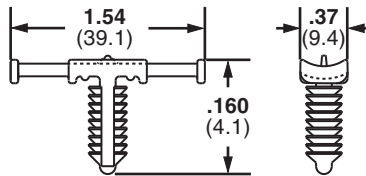

| Part Number | Used with Cable Ties* | Maximum Panel Thickness |    | Panel Hole Diameter |    | Material | Color | Mounting Method | Std. Pkg. Qty. | Std. Ctn. Qty. |
|-------------|-----------------------|-------------------------|----|---------------------|----|----------|-------|-----------------|----------------|----------------|
|             |                       | In.                     | mm | In.                 | mm |          |       |                 |                |                |

**FOR CORRUGATED TUBING – A location tab on the mount shelf aligns with the corrugated tubing grooves to ensure proper mount location during assembly**

|             |         |      |     |               |           |                           |         |           |     |      |
|-------------|---------|------|-----|---------------|-----------|---------------------------|---------|-----------|-----|------|
| THMSP20-C   | M, I, S | .160 | 4.1 | 0.244 – 0.283 | 6.2 – 7.2 | Nylon 6.6                 | Natural | Push Barb | 100 | 1000 |
| THMSP20-C30 | M, I, S | .160 | 4.1 | 0.244 – 0.283 | 6.2 – 7.2 | Heat Stabilized Nylon 6.6 | Black   | Push Barb | 100 | 1000 |
| THMSP25-C   | M, I, S | .230 | 5.8 | 0.244 – 0.283 | 6.2 – 7.2 | Nylon 6.6                 | Natural | Push Barb | 100 | 1000 |
| THMSP25-C30 | M, I, S | .230 | 5.8 | 0.244 – 0.283 | 6.2 – 7.2 | Heat Stabilized Nylon 6.6 | Black   | Push Barb | 100 | 1000 |

**FOR DISCRETE WIRING – No location tab**

|              |         |      |     |               |           |                           |         |           |     |      |
|--------------|---------|------|-----|---------------|-----------|---------------------------|---------|-----------|-----|------|
| THMSP20F-C   | M, I, S | .160 | 4.1 | 0.244 – 0.283 | 6.2 – 7.2 | Nylon 6.6                 | Natural | Push Barb | 100 | 1000 |
| THMSP20F-C30 | M, I, S | .160 | 4.1 | 0.244 – 0.283 | 6.2 – 7.2 | Heat Stabilized Nylon 6.6 | Black   | Push Barb | 100 | 1000 |
| THMSP25F-C   | M, I, S | .230 | 5.8 | 0.244 – 0.283 | 6.2 – 7.2 | Nylon 6.6                 | Natural | Push Barb | 100 | 1000 |
| THMSP25F-C30 | M, I, S | .230 | 5.8 | 0.244 – 0.283 | 6.2 – 7.2 | Heat Stabilized Nylon 6.6 | Black   | Push Barb | 100 | 1000 |

\*Cable tie cross section sizes: M = Miniature, I = Intermediate, S = Standard.

## Harness Board Standoff Posts and Adapter

- Used to hold a push mount accessory or cable tie at a specific location on a harness board

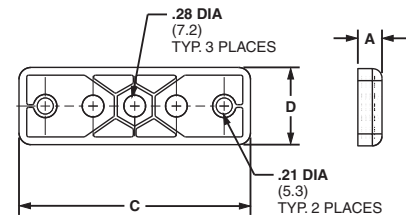
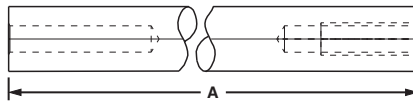
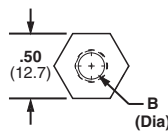

HB2SP

HBUA

| Part Number | Height A |    | Hole Diameter B |    | Length C |    | Width D |    | For Use With | Material | Mounting Method | Std. Pkg. Qty. | Std. Ctn. Qty. |
|-------------|----------|----|-----------------|----|----------|----|---------|----|--------------|----------|-----------------|----------------|----------------|
|             | In.      | mm | In.             | mm | In.      | mm | In.     | mm |              |          |                 |                |                |

### Posts

|           |      |      |     |     |   |   |      |      |                                   |          |                 |    |     |
|-----------|------|------|-----|-----|---|---|------|------|-----------------------------------|----------|-----------------|----|-----|
| HB2SP19-X | 2.00 | 50.8 | .20 | 5.2 | — | — | 0.50 | 12.7 | PLWP, PRWP, WS, VWS, HWS, TPM     | Aluminum | Bolt – Included | 10 | 100 |
| HB2SP25-X | 2.00 | 50.8 | .30 | 7.5 | — | — | 0.50 | 12.7 | PLWP, PRWP, PLP, THMS, HCMP, PMCC | Aluminum | Bolt – Included | 10 | 100 |

### Adapter

|        |     |     |     |     |      |      |      |      |                      |           |                |    |     |
|--------|-----|-----|-----|-----|------|------|------|------|----------------------|-----------|----------------|----|-----|
| HBUA-X | .31 | 7.9 | .28 | 7.1 | 3.00 | 76.2 | 1.00 | 25.4 | HB2SP19-X, HB2SP25-X | Nylon 6.6 | #10 (M5) Screw | 10 | 100 |
|--------|-----|-----|-----|-----|------|------|------|------|----------------------|-----------|----------------|----|-----|

A. System Overview



## Automatic Cable Tie Mounts

B1. Cable Ties

- Multiple sizes work with industry standard panel thickness and hole diameters for greater application flexibility
- Low profile design keeps bundle close to mounting surface, saving space and providing greater protection for bundles in high vibration applications

- Supports Miniature and Intermediate cross section cable ties

B2. Cable Accessories

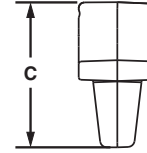
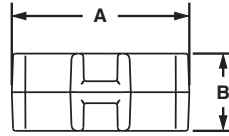

B3. Stainless Steel Ties

C1. Wiring Duct

C2. Surface Raceway

C3. Abrasion Protection

C4. Cable Management

| Part Number  | Used with Cable Ties    | A Length |      | B Width |     | C Height |      | Maximum Panel Thickness |     | Panel Hole Diameter Range |           | Material                  | Color   | Std. Pkg. Qty. | Std. Ctn. Qty. |
|--------------|-------------------------|----------|------|---------|-----|----------|------|-------------------------|-----|---------------------------|-----------|---------------------------|---------|----------------|----------------|
|              |                         | In.      | mm   | In.     | mm  | In.      | mm   | In.                     | mm  | In.                       | mm        |                           |         |                |                |
| ATM-W187-M   | BT1.5M-XMR, PLT1.5M-XMR | 0.80     | 20.5 | 0.35    | 9.0 | 0.58     | 14.6 | 0.12                    | 3.0 | 0.17 – 0.20               | 4.3 – 4.9 | Nylon 6.6                 | Natural | 1000           | 5000           |
| ATM-W187-M20 |                         |          |      |         |     |          |      |                         |     |                           |           |                           | Black   | 1000           | 5000           |
| ATM-W187-M30 |                         |          |      |         |     |          |      |                         |     |                           |           | Heat Stabilized Nylon 6.6 | Black   | 1000           | 5000           |
| ATM-W250-M   |                         |          |      |         |     |          |      |                         |     | 0.23 – 0.26               | 5.7 – 6.6 | Nylon 6.6                 | Natural | 1000           | 5000           |
| ATM-W250-M20 |                         |          |      |         |     |          |      |                         |     |                           |           |                           | Black   | 1000           | 5000           |
| ATM-W250-M30 |                         |          |      |         |     |          |      |                         |     |                           |           | Heat Stabilized Nylon 6.6 | Black   | 1000           | 5000           |

Auto Tie Mounts work with Reel-fed Cable Ties and Automatic Tooling. See page B1.115.

D1. Terminals

D2. Power Connectors

D3. Grounding Connectors

E1. Labeling Systems

E2. Labels

E3. Pre-Printed & Write-On Markers

E4. Permanent Identification

E5. Lockout/Tagout & Safety Solutions

F. Index



## Harness Board Fixtures

- Automatic alignment orients the tool head with the mount for reliable feeding of the cable through the mount to speed installation
- Multiple fixture configurations allow mounting in horizontal, vertical, or 45° orientation

- Integrated switch\* capability enables placement of a switch to detect the mount's presence providing an input to a quality control system
- Activation device on harness board fixture prevents tool from operating unless it is properly engaged in the fixture for operator safety

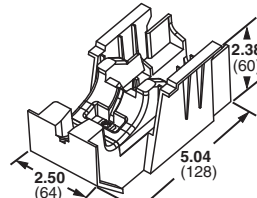

ATMB

| Part Number | Description  | Mounting                                      | Color  | Material | Std. Pkg. Qty. | Std. Ctn. Qty. |
|-------------|--|---|--------|----------|----------------|----------------|
| ATMB        | Base   | Screw base to harness board with 1/4" screws  | Black  | Acetal   | —              | 10             |
| ATMI-W187-X | Insert for ATM-W187 mount  | Snaps into ATMB                               | Yellow |          | 10             | —              |
| ATMI-W250-X | Insert for ATM-W250 mount  | Snaps into ATMB                               | Red    |          | 10             | —              |
| ATMI-XMR-X  | Used for cable tie installations where mounts are NOT required     | Snaps into ATMB                               | Black  |          | 10             | —              |
| ATMC        | Clamp used to secure the ATMB (base) in a vertical or 45° position | Screw clamp to harness board with 1/4" screws | Black  | —        | 10             |                |

\*The Omron Electronics D2SW-3L1HS switch is compatible with the ATM system. Similar switches from other manufacturers may also be suitable. See page B1.115 for Panduit Automatic Cable Tie Installation Systems.

## Physical Properties and Colors of Cable Accessory Materials<sup>‡</sup>

| Design Criteria                           | Flame Retardant Nylon 6.6 | Glass Filled Flame Retardant Nylon 6.6 | General Purpose Polypropylene | Weather Resistant Polypropylene | General Purpose ABS | General Purpose ABS | Weather Resistant ABS | Flame Retardant Polypropylene | Acetal          | PVC            |
|---|---------------------------|--|-------------------------------|---------------------------------|---------------------|---------------------|-----------------------|-------------------------------|-----------------|----------------|
| <b>Color</b>                              | Black, Natural            | Black                                  | Black                         | Black                           | Black               | Natural             | Black                 | Black                         | Black           | Gray, White    |
| <b>Part Number Suffix</b>                 | 60, 69                    | None                                   | None/109                      | 100                             | None                | 20                  | 0                     | None                          | None            | 810            |
| <b>UL Flammability – UL 94</b>            | V-0                       | V-0                                    | HB                            | HB                              | HB                  | HB                  | HB                    | V-0                           | HB              | V-0            |
| <b>Gamma Radiation Resistance</b>         | 1x10 <sup>5</sup> Rads    | N/A                                    | 1x10 <sup>5</sup> Rads        | 1x10 <sup>5</sup> Rads          | N/A                 | N/A                 | N/A                   | N/A                           | N/A             | N/A            |
| <b>Water Absorption</b>                   | 1.1% (24 hrs.)            | 0.7% (24 hrs.)                         | 0.1% (24 hrs.)                | 0.1% (24 hrs.)                  | 0.3% (24 hrs.)      | 0.3% (24 hrs.)      | 0.3% (24 hrs.)        | 0.15% (24 hrs.)               | 0.43% (24 hrs.) | 0.3% (24 hrs.) |
| <b>UV Resistance</b>                      | Poor                      | Poor                                   | Poor                          | Good                            | Poor                | Fair                | Good                  | Good                          | Good            | Poor           |
| <b>Maximum Continuous Use Temperature</b> | 230°F (110°C)             | 230°F (110°C)                          | 221°F (105°C)                 | 221°F (105°C)                   | 185°F (85°C)        | 185°F (85°C)        | 185°F (85°C)          | 257°F (125°C)                 | 194°F (90°C)    | 122°F (50°C)   |
| <b>Minimum Continuous Use Temperature</b> | -40°F (-40°C)             | -40°F (-40°C)                          | -40°F (-40°C)                 | -40°F (-40°C)                   | -40°F (-40°C)       | -40°F (-40°C)       | -40°F (-40°C)         | -40°F (-40°C)                 | -40°F (-40°C)   | -40°F (-40°C)  |

▪TEFZEL is a registered trademark of E.I. du Pont de Nemours and Company.

‡For more detail and additional materials, see Selection Chart on Pages B1.2 – B1.3.

## Application Chart

Since Panduit manufactures adhesive backed mounts with a variety of adhesive types, this chart should be used as a guideline for choosing the best adhesive for often-encountered conditions. Each type of adhesive is rated good, fair or poor for some specific mounting surfaces and/or chemical environments.

## Mount Spacing

To determine the number of mounts to use in a given application, the following formula can be used as a guideline:

$$\frac{\text{Cable or weight (Lbs./ft.)}}{\text{Static Load rating of Mount (Lbs./mt.)}} = \text{Spacing} \frac{\text{Mounts}}{\text{Ft.}}$$

| Surfaces                 | Rubber Based Foam Tape Mounts | Acrylic Based Foam Tape Mounts | Epoxy Applied Adhesive Mounts |
|--------------------------|-------------------------------|--------------------------------|-------------------------------|
| Plastics                 | Good                          | Good                           | Good                          |
| Wood                     | Good                          | Good                           | Good                          |
| Glass                    | Fair                          | Good                           | Good                          |
| Painted Surfaces         | Good                          | Good                           | Fair                          |
| Powder Coating           | Good                          | Fair                           | Good                          |
| Metal                    | Good <sup>1</sup>             | Good <sup>1</sup>              | Good                          |
| Paper                    | Good                          | Good                           | Fair                          |
| Concrete, Stone, Masonry | Not Recommended               | Not Recommended                | Good                          |
| Chemical Resistance      |                               |                                |                               |
| Water                    | Good                          | Good                           | Poor                          |
| Oil                      | Poor                          | Fair <sup>3</sup>              | Good                          |
| Gasoline                 | Poor                          | Fair <sup>3</sup>              | Fair                          |
| Dilute Acids             | Poor                          | Fair <sup>3</sup>              | Fair                          |
| Dilute Alkalis           | Good                          | Fair <sup>3</sup>              | Fair                          |
| Organic Solvents         | Poor                          | Fair <sup>3</sup>              | Not Recommended               |
| Outdoor Exposure         | Not Recommended               | Good                           | Good <sup>2</sup>             |

1. Not recommended for use on copper or brass.

2. Mounts manufactured from outdoor material only. For specific applications, individual testing prior to extensive use is suggested.

3. Depends on concentration, exposure time, and chemical composition.

A. System Overview

B1. Cable Ties

B2. Cable Accessories

B3. Stainless Steel Ties

C1. Wiring Duct

C2. Surface Raceway

C3. Abrasion Protection

C4. Cable Management

D1. Terminals

D2. Power Connectors

D3. Grounding Connectors

E1. Labeling Systems

E2. Labels

E3. Pre-Printed & Write-On Markers

E4. Permanent Identification

E5. Lockout/Tagout & Safety Solutions

F. Index

A.  
System  
Overview

## Selection and Use of Adhesive Mounts

Panduit adhesive mounts provide a quick, economical, and dependable method of supporting, routing, and protecting wires or cables. Some are used with Panduit cable ties and others can be used without cable ties. Adhesive backed mounts adhere to a variety of surfaces. This alternative to mechanical fasteners offers the advantage of lower installed cost with safe, easy to use, quality products.



B1.  
Cable Ties

B2.  
Cable  
Accessories

B3.  
Stainless  
Steel Ties

### Applications

- To route wires in control panels and switchboards
- To support bundles of wires away from moving mechanical devices
- Routing and harnessing cables, both indoors and out, to prevent safety hazards
- To organize flat cables in many locations with low profile construction
- Ideal for supporting wire bundles where holes cannot be made in the substrate
- To separate groups of wires for identification



C1.  
Wiring  
Duct

C2.  
Surface  
Raceway

C3.  
Abrasion  
Protection

### General Mount Guidelines

Panduit pressure sensitive adhesive (foam tape) mounts are intended to secure wire bundles or other light objects to smooth surfaces. These mounts are not designed to support excessive loads and should not be used when the maximum expected load exceeds the rated capacity of the mount.

C4.  
Cable  
Management

### Choosing the Right Adhesive

Panduit offers two standard pressure sensitive foam tapes which are available on most adhesive backed wiring accessories products. The general purpose tape is produced with a rubber based adhesive and is identified by an “-A” in the part number. This tape develops its strength extremely fast and can be used in environments with temperatures ranging from -20°F (-29°C) to 120°F (49°C). It is recommended that rubber based adhesive mounts dwell 2 hours after installation, prior to loading. Rubber based adhesive tape is the best choice for most adhesive mount applications, including powder coated surfaces.

D1.  
Terminals

D2.  
Power  
Connectors

D3.  
Grounding  
Connectors

Acrylic based adhesive tape is also available and is identified by an “-AT” in the part number. This tape is for use in environments where continuous exposure to temperatures ranging from -20°F (-29°C) to 180°F (82°C) is possible. Acrylic based adhesive develops its maximum strength over a longer period of time than rubber based adhesive. It is recommended that acrylic adhesive mounts dwell 8 hours after installation, prior to loading. Acrylic based adhesive tape is a good choice for environments with exposure to UV rays or temperatures above 120°F (49°C).

E1.  
Labeling  
Systems

E2.  
Labels

Panduit adhesive backed cable accessories are also available pre-installed with high bond acrylic-based adhesive. This adhesive can be used in applications with continuous use temperatures ranging from -31°F (-35°C) to 200°F (93°C), though higher temperatures may be possible for short-term exposure. High Bond cable accessories are recommended for use in demanding applications such as where high temperatures are required, or where fatigue loading is expected.

E3.  
Pre-Printed  
& Write-On  
Markers

E4.  
Permanent  
Identification

Panduit also offers a 2-part epoxy for use in applications where excessive loading is required, or where the surface to which the mount must be applied is porous rather than smooth. Panduit EMA adhesive is a 2-part epoxy cement which is packaged in convenient mixer cups containing an equal amount of resin and hardener. Peel the protective covering off and pop the center of the cup in to form a mixing bowl. Each cup is supplied with a mixer stick and contains enough epoxy to properly apply three EMS mounts. The resin and hardener should be thoroughly mixed together until the epoxy is a consistent and uniform color. The mixer stick can then be used to apply the adhesive to the mount. The epoxy should be forced into the grooves on the bottom of the mount to obtain optimum bond performance. The mount should be applied to the surface with light pressure and a back-and-forth twisting motion. Hardening of the epoxy begins five minutes after mixing at room temperature.

E5.  
Lockout/  
Tagout  
& Safety  
Solutions

F.  
Index



## Selection and Use of Adhesive Mounts (continued)

### Surface Preparation

For best results, Panduit adhesive mounts should be applied to clean, dry, grease-free surfaces. We recommend that the surface be cleaned prior to mount installation. For rubber and acrylic based foam tape adhesives, a blend of isopropyl alcohol and water 50/50 may be used to clean most surfaces.

For epoxy type adhesives, especially masonry surfaces, be sure to clean all loose particles away before mount installation. Some surface abrasion is recommended to achieve maximum strength. A light rubbing with medium grit emery cloth or sandpaper is best. Wash after abrading.

### Proper Installation Techniques For Pressure Sensitive Adhesive Mounts

For proper installation of adhesive mounts with foam tape, simply remove the release liner and place the mount in the desired location. Avoid touching the adhesive prior to positioning the mount. Apply firm pressure to the mount for 5 seconds to insure proper adhesion.

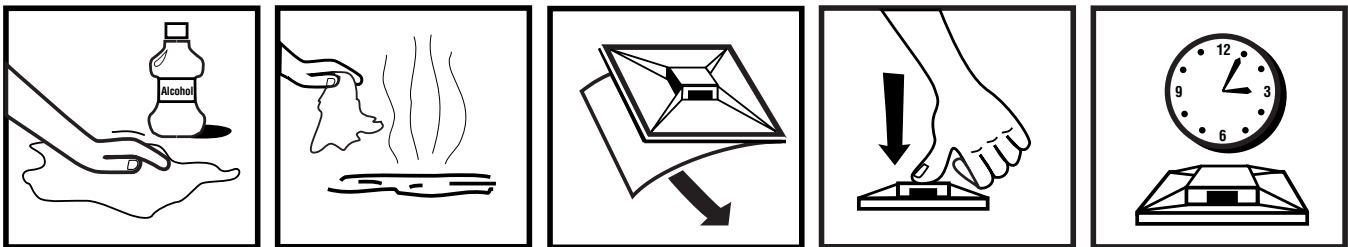

- 1) Clean surface with a clean cloth and isopropyl alcohol.
- 2) Allow surface to air dry.
- 3) Remove the release liner, being careful not to touch the adhesive.
- 4) Apply full thumb pressure for at least 5 seconds.
- 5) Allow mount to properly dwell.

### Proper Storage Conditions

All Panduit adhesive products have an expiration date printed on the package label. Use the following storage guidelines:

1. For rubber and acrylic based foam tape adhesives, store in temperatures of 70°F (21°C) and 45% Relative Humidity (R.H.).
2. For epoxy type adhesives, store in temperatures of 40°F (4°C) to 75°F (25°C) and relative humidity not in excess of 45%. Storage in opened containers is not recommended. Using the guidelines above, the shelf life of foam tape is 3 years. Shelf life of epoxy is 1 year. Deviation from the recommended storage conditions may reduce the shelf life or adhesive strength. In any case, adhesive products should never be stored near heating vents or other heat sources, and storage in lower temperatures than those recommended may increase the shelf life.

### Stock Rotation

Adhesive mount inventory should be rotated in order to insure the quality of the adhesive foam tape. Each package of Panduit adhesive backed mounts has a quality control number and a best-if-used-by date on the package label. The best-if-used-by date provides the customer with an accurate way to control the rotation of inventory, and, as is the case with all Panduit products, the quality control number provides complete traceability for all components that go into a specific production run of product.

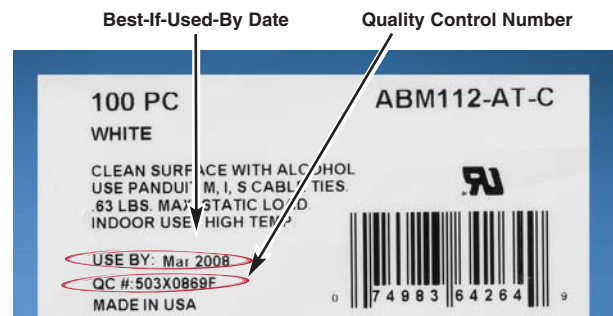

### Mount Removal

There is no simple or easy method for removing Panduit adhesives. A thin wire or razor blade can be moved in between the surfaces when removing foam tape mounts; however, the adhesive residue will remain on the surface. Epoxy adhesives may be removed with a commercial paint stripping solution.

A.  
System  
Overview

B1.  
Cable Ties

B2.  
Cable  
Accessories

B3.  
Stainless  
Steel Ties

C1.  
Wiring  
Duct

C2.  
Surface  
Raceway

C3.  
Abrasion  
Protection

C4.  
Cable  
Management

D1.  
Terminals

D2.  
Power  
Connectors

D3.  
Grounding  
Connectors

E1.  
Labeling  
Systems

E2.  
Labels

E3.  
Pre-Printed  
& Write-On  
Markers

E4.  
Permanent  
Identification

E5.  
Lockout/  
Tagout  
& Safety  
Solutions

F.  
Index



A.  
System  
Overview

B1.  
Cable Ties

B2.  
Cable  
Accessories

B3.  
Stainless  
Steel Ties

C1.  
Wiring  
Duct

C2.  
Surface  
Raceway

C3.  
Abrasion  
Protection

C4.  
Cable  
Management

D1.  
Terminals

D2.  
Power  
Connectors

D3.  
Grounding  
Connectors

E1.  
Labeling  
Systems

E2.  
Labels

E3.  
Pre-Printed  
& Write-On  
Markers

E4.  
Permanent  
Identification

E5.  
Lockout/  
Tagout  
& Safety  
Solutions

F.  
Index

## NOTES

## PAN-STEEL® SYSTEM

The Pan-Steel® System provides a strong, durable method of bundling and mechanical fastening, for all indoor, outdoor, and underground (including direct burial) applications. The ties are designed for use in critical applications where strength, vibration, radiation, weathering, corrosion and temperature extremes are a factor.

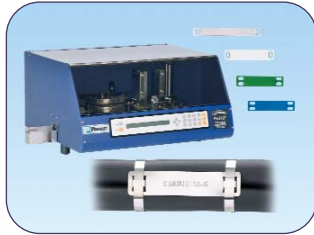
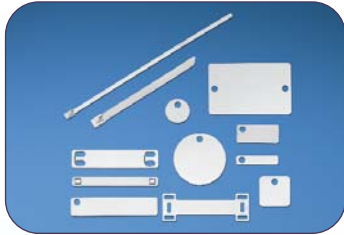
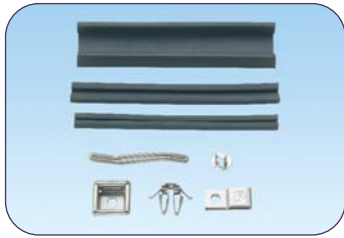
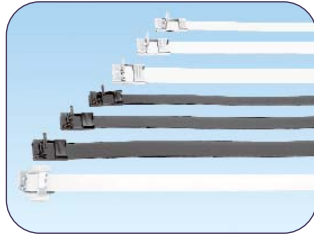
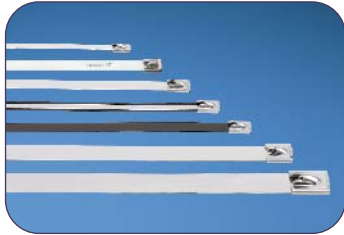

- Patented locking head design assures locking in any position, with a high rated loop tensile strength for a durable solution that delivers an extra margin of safety
- 201, 304, or 316 grade stainless steel provides a strong, long-lasting method of bundling and mechanical fastening in harsh environments
- Accessories available to protect, speed, and simplify the mounting of wires, cable, and tubing with Panduit® Pan-Steel® Stainless Steel Cable Ties
- Complete line of manual and powered installation tools available with controlled tension and automatic cut-off for lower installed cost
- Large selection of stainless steel marker plates, tags, and cable ties to deliver maximum design flexibility to match your specific application requirements; for details, refer to Permanent Identification Section E4

Panduit continues to develop stainless steel solutions for harsh environment applications by solving customer problems with innovative products and reliable tooling to achieve lowest installed cost.

A.  
System  
Overview

B1.  
Cable Ties

B2.  
Cable  
Accessories

B3.  
Stainless  
Steel Ties

C1.  
Wiring  
Duct

C2.  
Surface  
Raceway

C3.  
Abrasion  
Protection

C4.  
Cable  
Management

D1.  
Terminals

D2.  
Power  
Connectors

D3.  
Grounding  
Connectors

E1.  
Labeling  
Systems

E2.  
Labels

E3.  
Pre-Printed  
& Write-On  
Markers

E4.  
Permanent  
Identification

E5.  
Lockout/  
Tagout  
& Safety  
Solutions

F.  
Index

A.  
System  
Overview

## Pan-Steel® Products Overview

B1.  
Cable Ties

### Pan-Steel® Cable Ties

Pages B3.4 – B3.7, B3.11 – B3.13

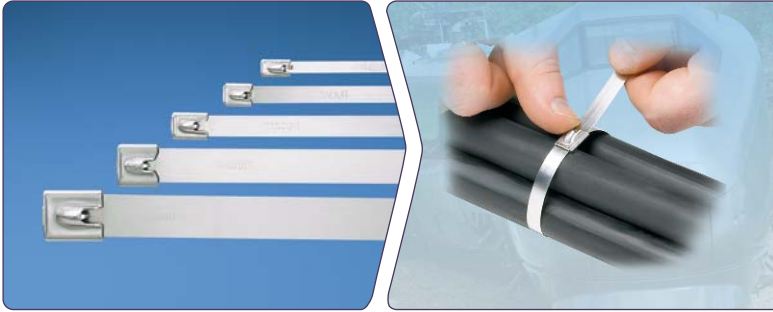

- Designed for use in indoor, outdoor, and underground applications
- Self-locking head design speeds installation
- Strong, durable method of cable bundling
- Rounded edges assure cable protection and worker safety

B2.  
Cable  
Accessories

B3.  
Stainless  
Steel Ties

C1.  
Wiring  
Duct

C2.  
Surface  
Raceway

### Pan-Steel® Coated Cable Ties

Pages B3.8 – B3.9, B3.12 – B3.13



- Designed for use in indoor, outdoor, and underground applications
- Self-locking head design speeds installation
- Provides additional edge protection
- Prevents corrosion between dissimilar metals

C3.  
Abrasion  
Protection

C4.  
Cable  
Management

D1.  
Terminals

D2.  
Power  
Connectors

### Pan-Alum™ Cable Ties

Page B3.10

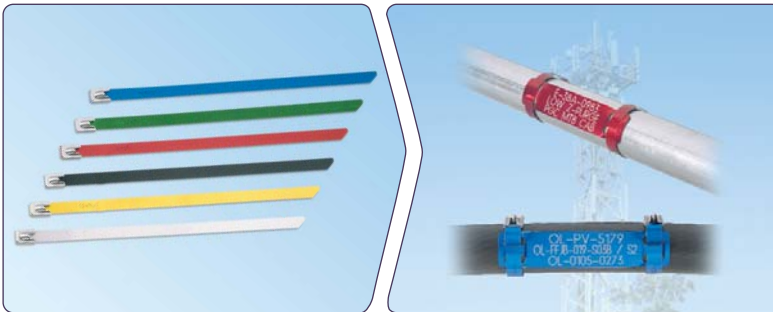

- Ideal for use in permanent identification and color-coding applications
- Five color options in addition to natural aluminum
- Lightweight construction for flexibility and ease of handling
- Used with aluminum marker plates for fast and easy installation

D3.  
Grounding  
Connectors

E1.  
Labeling  
Systems

E2.  
Labels

E3.  
Pre-Printed  
& Write-On  
Markers

### Pan-Steel® Retained Tension Ties

Pages B3.17 – B3.20

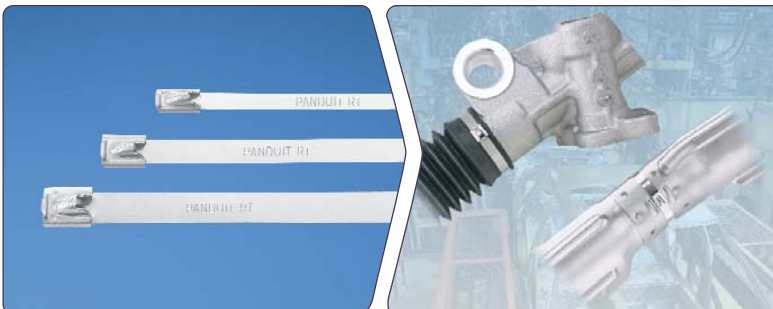

- Designed for use in Industrial, OEM, and Transportation Markets
- Provides tight bundling of armored cables, pipes, conduit and rigid materials
- Locks into place at any length along the tie body
- 360° seal design option eliminates gaps for a completely sealed installation

E4.  
Permanent  
Identification

E5.  
Lockout/  
Tagout  
& Safety  
Solutions

F.  
Index

## Pan-Steel® Products Overview (continued)

### Installation Tools

Pages B3.14 – B3.16, B3.20, B3.26



- Used in production, maintenance, and construction applications
- Full line of lightweight, ergonomic hand tools
- Highest reliability in the industry
- Flush cut-off of ties limits exposure to sharp edges

### Pan-Steel® Strapping

Pages B3.21 – B3.26



- Fold over design provides high retained tension
- Cut end is locked inside low profile buckle – no sharp edges
- Coil-in-box packaging option for job site versatility with minimum inventory
- Coated design option for additional edge protection

### Accessories

Pages B3.26 – B3.29

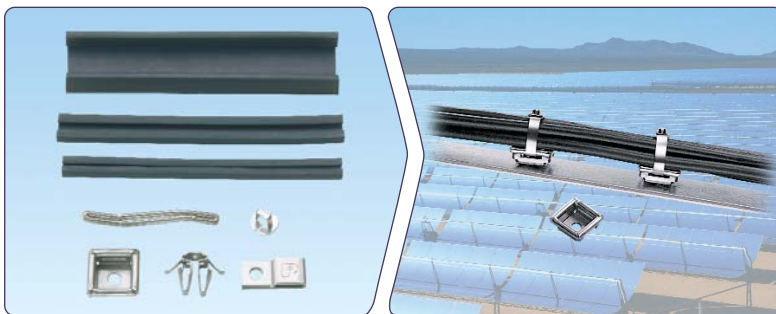

- Cushion sleeving provides full separation between ties and bundles
- Multiple mount options for range of applications and panel thicknesses
- Mounts secure ties to structure quickly and easily

### Permanent Identification Products

Pages E4.1 – E4.6



- Withstand the test of time and provide legibility in harsh environments
- Factory Custom Marking Service creates custom embossed or laser etched metal plates, tags, and ties
- Portable marking tools for quick and easy on-site identification
- Large selection delivers maximum design flexibility

A.  
System  
Overview

B1.  
Cable Ties

B2.  
Cable  
Accessories

B3.  
Stainless  
Steel Ties

C1.  
Wiring  
Duct

C2.  
Surface  
Raceway

C3.  
Abrasion  
Protection

C4.  
Cable  
Management

D1.  
Terminals

D2.  
Power  
Connectors

D3.  
Grounding  
Connectors

E1.  
Labeling  
Systems

E2.  
Labels

E3.  
Pre-Printed  
& Write-On  
Markers

E4.  
Permanent  
Identification

E5.  
Lockout/  
Tagout  
& Safety  
Solutions

F.  
Index



A. System Overview

## Features and Benefits – Pan-Steel® Cable Ties

Panduit® Pan-Steel® Stainless Steel Ties are engineered for safety, productivity, and durability by providing round edges and smooth surfaces, easy threading, high loop tensile strength and tight clamping.

B1. Cable Ties

B2. Cable Accessories

B3. Stainless Steel Ties

### Self-Locking Head Construction

**\*Aggressive locking head**  
Quicker locking, tighter installation

**Unique locking ramp**  
Assures locking in any position

**\*Lead in design**  
Wider entrance for easier threading

**Strengthening ribs**  
Stronger head increases lock strength

**\*Innovative displacement lock**  
Assures superior locking strength

**Extended retaining tab**  
Increases overall tie strength

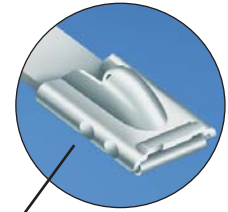
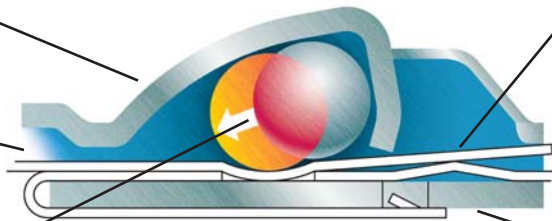

\*Patented

C1. Wiring Duct

C2. Surface Raceway

C3. Abrasion Protection

C4. Cable Management

### Fully Rounded Edges

### Self-Locking for Fast Installation



Panduit tie body



Other manufacturer's tie body

The Pan-Steel® Stainless Steel Cable Tie features fully rounded edges to assure bundle protection and operator safety. Panduit not only removes the burr, but actually passes the material through a secondary process which removes the top and bottom corners of the material.



Self-locking design can be fastened by hand requiring no fold over or additional installation steps.



Pan-Steel® Installation Tools for adjustable tension control and automatic cut-off for quick, consistent, and secure installation.

D1. Terminals

D2. Power Connectors

D3. Grounding Connectors

E1. Labeling Systems

E2. Labels

E3. Pre-Printed & Write-On Markers

E4. Permanent Identification

E5. Lockout/Tagout & Safety Solutions

F. Index



Large selection of installation tools, the proper tool available to meet the requirements of every application. See pages B3.14 – B3.16.



Pan-Steel® System Accessories are used with Pan-Steel® Stainless Steel Cable Ties to speed and simplify the mounting of wires, cables, and tubing. Installation methods include screw mounts and push mounts. See pages B3.26 – B3.29.



Pan-Steel® Permanent Identification Solutions are designed for use with Panduit® Pan-Steel® Stainless Cable Ties and Pan-Alum™ Aluminum Cable Ties for quick and easy on-demand identification in harsh environments. See pages E4.1 – E4.6.

## Part Number System for Pan-Steel® Cable Ties

|                         |                                 |  |   |  |                            |
|-------------------------|---------------------------------|--|---|--|----------------------------|
| <b>MLT</b>              | <b>6</b>                        | <b>S</b>   | — | <b>CP</b>  | —                          |
| Type                    | Bundle Diameter Reference (In.) | Cross Section  |   | Standard Package Size  | Material                   |
| MLT = Metal Locking Tie |                                 | S = Standard<br>LH = Light Heavy<br>H = Heavy<br>EH = Extra-Heavy<br>EH15 = Extra-Heavy-15<br>SH = Super-Heavy |   | Q = 25<br>L* = 50<br>LP** = 50<br>CP = 100<br>*Standard Cross Section<br>**Heavy Cross Section | (blank) = 304<br>316 = 316 |

### Pan-Steel® Self-Locking Cable Ties – MLT Series

- Self-locking head design speeds installation and locks into place at any length along the tie body
- Provides a strong, durable method of cable bundling
- Can be used in a wide range of indoor, outdoor, and underground (including direct burial) applications
- Smooth surfaces and rounded edges assures cable protection and worker safety
- Available in AISI 304 stainless steel for general-purpose applications
- Available in AISI 316 stainless steel for the most corrosive environments



| Part Number | Max. Bundle Diameter |    | Length* |    | Min. Loop Tensile Strength** |   | Min. Bundle Diameter |    | Width |    | Thickness |    | Recommended Installation Tool*** | Std. Pkg. Qty. | Std. Ctn. Qty. |
|-------------|----------------------|----|---------|----|------------------------------|---|----------------------|----|-------|----|-----------|----|----------------------------------|----------------|----------------|
|             | In.                  | mm | In.     | mm | Lbs.                         | N | In.                  | mm | In.   | mm | In.       | mm |                                  |                |                |

#### AISI 304 Stainless Steel – For General Purpose

##### Standard Cross Section

|                   |      |     |      |      |     |     |      |      |      |     |       |      |                           |     |     |
|-------------------|------|-----|------|------|-----|-----|------|------|------|-----|-------|------|---------------------------|-----|-----|
| <b>MLT1S-CP</b>   | 1.0  | 25  | 5.0  | 127  | 200 | 890 | 0.50 | 12.7 | 0.18 | 4.6 | 0.010 | 0.25 | GS4MT, HTMT, PPTMT, ST2MT | 100 | 500 |
| <b>MLT2S-CP</b>   | 2.0  | 51  | 7.9  | 201  | 200 | 890 | 0.50 | 12.7 | 0.18 | 4.6 | 0.010 | 0.25 |                           | 100 | 500 |
| <b>MLT2S-L</b>    | 2.0  | 51  | 7.9  | 201  | 200 | 890 | 0.50 | 12.7 | 0.18 | 4.6 | 0.010 | 0.25 |                           | 50  | 500 |
| <b>MLT2.7S-CP</b> | 2.7  | 69  | 10.2 | 259  | 200 | 890 | 0.50 | 12.7 | 0.18 | 4.6 | 0.010 | 0.25 |                           | 100 | 500 |
| <b>MLT4S-CP</b>   | 4.0  | 102 | 14.3 | 362  | 200 | 890 | 0.50 | 12.7 | 0.18 | 4.6 | 0.010 | 0.25 |                           | 100 | 500 |
| <b>MLT4S-L</b>    | 4.0  | 102 | 14.3 | 362  | 200 | 890 | 0.50 | 12.7 | 0.18 | 4.6 | 0.010 | 0.25 |                           | 50  | 500 |
| <b>MLT6S-CP</b>   | 6.0  | 152 | 20.5 | 521  | 200 | 890 | 0.50 | 12.7 | 0.18 | 4.6 | 0.010 | 0.25 |                           | 100 | 500 |
| <b>MLT8S-CP</b>   | 8.0  | 203 | 26.8 | 679  | 200 | 890 | 0.50 | 12.7 | 0.18 | 4.6 | 0.010 | 0.25 |                           | 100 | 500 |
| <b>MLT10S-CP</b>  | 10.0 | 254 | 33.0 | 838  | 200 | 890 | 0.50 | 12.7 | 0.18 | 4.6 | 0.010 | 0.25 |                           | 100 | 500 |
| <b>MLT12S-Q</b>   | 12.0 | 304 | 39.3 | 998  | 200 | 890 | 0.50 | 12.7 | 0.18 | 4.6 | 0.010 | 0.25 |                           | 25  | 125 |
| <b>MLT14S-Q</b>   | 14.0 | 355 | 45.5 | 1156 | 200 | 890 | 0.50 | 12.7 | 0.18 | 4.6 | 0.010 | 0.25 |                           | 25  | 125 |
| <b>MLT15S-Q</b>   | 15.0 | 380 | 49.2 | 1250 | 200 | 890 | 0.50 | 12.7 | 0.18 | 4.6 | 0.010 | 0.25 |                           | 25  | 125 |

\*Other lengths available, contact Panduit Customer Service.

\*\*Per SAE Standard AS23190/3 (formerly MIL). For additional details, refer to page B3.32.

\*\*\*For information on installation tools, refer to pages B3.14 – B3.16.

Table continued on page B3.6



A. System Overview



## Pan-Steel® Self-Locking Cable Ties – MLT Series (continued)

B1. Cable Ties

B2. Cable Accessories

B3. Stainless Steel Ties

C1. Wiring Duct

C2. Surface Raceway

C3. Abrasion Protection

C4. Cable Management

D1. Terminals

D2. Power Connectors

D3. Grounding Connectors

E1. Labeling Systems

E2. Labels

E3. Pre-Printed & Write-On Markers

E4. Permanent Identification

E5. Lockout/Tagout & Safety Solutions

F. Index

| Part Number   | Max. Bundle Diameter |     | Length* |      | Min. Loop Tensile Strength** |      | Min. Bundle Diameter |      | Width |      | Thickness |      | Recommended Installation Tool*** | Std. Pkg. Qty. | Std. Ctn. Qty. |
|---|----------------------|-----|---------|------|------------------------------|------|----------------------|------|-------|------|-----------|------|----------------------------------|----------------|----------------|
|   | In.                  | mm  | In.     | mm   | Lbs.                         | N    | In.                  | mm   | In.   | mm   | In.       | mm   |                                  |                |                |
| <b>Light-Heavy Cross Section</b>                                    |                      |     |         |      |                              |      |                      |      |       |      |           |      |                                  |                |                |
| MLT2LH-LP   | 2.0                  | 51  | 7.9     | 201  | 250                          | 1112 | 0.50                 | 12.7 | 0.25  | 6.4  | 0.010     | 0.25 | GS4MT, HTMT, PPTMT, ST2MT        | 50             | 250            |
| MLT4LH-LP   | 4.0                  | 102 | 14.3    | 362  | 250                          | 1112 | 0.50                 | 12.7 | 0.25  | 6.4  | 0.010     | 0.25 |                                  | 50             | 250            |
| MLT6LH-LP   | 6.0                  | 152 | 20.5    | 521  | 250                          | 1112 | 0.50                 | 12.7 | 0.25  | 6.4  | 0.010     | 0.25 |                                  | 50             | 250            |
| MLT8LH-LP   | 8.0                  | 203 | 26.8    | 679  | 250                          | 1112 | 0.50                 | 12.7 | 0.25  | 6.4  | 0.010     | 0.25 |                                  | 50             | 250            |
| <b>Heavy Cross Section</b>  |                      |     |         |      |                              |      |                      |      |       |      |           |      |                                  |                |                |
| MLT2H-LP  | 2.0                  | 51  | 7.9     | 201  | 450                          | 2000 | 0.50                 | 12.7 | 0.31  | 7.9  | 0.010     | 0.25 | GS4MT, ST2MT, HTMT, PPTMT, PBTMT | 50             | 250            |
| MLT2.7H-LP  | 2.7                  | 69  | 10.2    | 259  | 450                          | 2000 | 0.50                 | 12.7 | 0.31  | 7.9  | 0.010     | 0.25 |                                  | 50             | 250            |
| MLT4H-LP  | 4.0                  | 102 | 14.3    | 362  | 450                          | 2000 | 0.50                 | 12.7 | 0.31  | 7.9  | 0.010     | 0.25 |                                  | 50             | 250            |
| MLT6H-LP  | 6.0                  | 152 | 20.5    | 521  | 450                          | 2000 | 0.50                 | 12.7 | 0.31  | 7.9  | 0.010     | 0.25 |                                  | 50             | 250            |
| MLT8H-LP  | 8.0                  | 203 | 26.8    | 679  | 450                          | 2000 | 0.50                 | 12.7 | 0.31  | 7.9  | 0.010     | 0.25 |                                  | 50             | 250            |
| MLT10H-LP   | 10.0                 | 254 | 33.0    | 838  | 450                          | 2000 | 0.50                 | 12.7 | 0.31  | 7.9  | 0.010     | 0.25 |                                  | 50             | 250            |
| MLT12H-Q  | 12.0                 | 304 | 39.3    | 998  | 450                          | 2000 | 0.50                 | 12.7 | 0.31  | 7.9  | 0.010     | 0.25 |                                  | 25             | 125            |
| MLT14H-Q  | 14.0                 | 355 | 45.5    | 1156 | 450                          | 2000 | 0.50                 | 12.7 | 0.31  | 7.9  | 0.010     | 0.25 |                                  | 25             | 125            |
| <b>Extra-Heavy Cross Section</b>                                    |                      |     |         |      |                              |      |                      |      |       |      |           |      |                                  |                |                |
| MLT4EH-LP   | 4.0                  | 102 | 17.1    | 434  | 600                          | 2670 | 1.00                 | 25.4 | 0.50  | 12.7 | 0.010     | 0.25 | ST2MT, RT2HT, RT2HTN, PBTMT      | 50             | 250            |
| MLT6EH-LP   | 6.0                  | 152 | 23.4    | 594  | 600                          | 2670 | 1.00                 | 25.4 | 0.50  | 12.7 | 0.010     | 0.25 |                                  | 50             | 250            |
| MLT8EH-LP   | 8.0                  | 203 | 29.7    | 754  | 600                          | 2670 | 1.00                 | 25.4 | 0.50  | 12.7 | 0.010     | 0.25 |                                  | 50             | 250            |
| MLT10EH-LP  | 10.0                 | 254 | 35.9    | 912  | 600                          | 2670 | 1.00                 | 25.4 | 0.50  | 12.7 | 0.010     | 0.25 |                                  | 50             | 250            |
| MLT12EH-Q   | 12.0                 | 305 | 42.2    | 1072 | 600                          | 2670 | 1.00                 | 25.4 | 0.50  | 12.7 | 0.010     | 0.25 |                                  | 25             | 125            |
| MLT4EH15-LP   | 4.0                  | 102 | 17.1    | 434  | 700                          | 3115 | 1.00                 | 25.4 | 0.50  | 12.7 | 0.015     | 0.38 |                                  | 50             | 250            |
| MLT6EH15-LP   | 6.0                  | 152 | 23.4    | 594  | 700                          | 3115 | 1.00                 | 25.4 | 0.50  | 12.7 | 0.015     | 0.38 |                                  | 50             | 250            |
| MLT8EH15-LP   | 8.0                  | 203 | 29.7    | 754  | 700                          | 3115 | 1.00                 | 25.4 | 0.50  | 12.7 | 0.015     | 0.38 |                                  | 50             | 250            |
| MLT10EH15-LP  | 10.0                 | 254 | 35.9    | 912  | 700                          | 3115 | 1.00                 | 25.4 | 0.50  | 12.7 | 0.015     | 0.38 |                                  | 50             | 250            |
| MLT12EH15-Q   | 12.0                 | 305 | 42.2    | 1072 | 700                          | 3115 | 1.00                 | 25.4 | 0.50  | 12.7 | 0.015     | 0.38 |                                  | 25             | 125            |
| <b>Super-Heavy Cross Section</b>                                    |                      |     |         |      |                              |      |                      |      |       |      |           |      |                                  |                |                |
| MLT4SH-LP   | 4.0                  | 102 | 17.1    | 434  | 900                          | 4005 | 1.00                 | 25.4 | 0.63  | 15.9 | 0.015     | 0.38 | RT2HT, RT2HTN, PBTMT             | 50             | 250            |
| MLT6SH-LP   | 6.0                  | 152 | 23.4    | 594  | 900                          | 4005 | 1.00                 | 25.4 | 0.63  | 15.9 | 0.015     | 0.38 |                                  | 50             | 250            |
| MLT8SH-LP   | 8.0                  | 203 | 29.7    | 754  | 900                          | 4005 | 1.00                 | 25.4 | 0.63  | 15.9 | 0.015     | 0.38 |                                  | 50             | 250            |
| MLT10SH-LP  | 10.0                 | 254 | 35.9    | 912  | 900                          | 4005 | 1.00                 | 25.4 | 0.63  | 15.9 | 0.015     | 0.38 |                                  | 50             | 250            |
| MLT12SH-Q   | 12.0                 | 305 | 42.2    | 1072 | 900                          | 4005 | 1.00                 | 25.4 | 0.63  | 15.9 | 0.015     | 0.38 |                                  | 25             | 125            |
| <b>AISI 316 Stainless Steel – For Superior Corrosion Resistance</b> |                      |     |         |      |                              |      |                      |      |       |      |           |      |                                  |                |                |
| <b>Standard Cross Section</b>                                       |                      |     |         |      |                              |      |                      |      |       |      |           |      |                                  |                |                |
| MLT1S-CP316   | 1.0                  | 25  | 5.0     | 127  | 200                          | 890  | 0.50                 | 12.7 | 0.18  | 4.6  | 0.010     | 0.25 | GS4MT, HTMT, PPTMT, ST2MT        | 100            | 500            |
| MLT2S-CP316   | 2.0                  | 51  | 7.9     | 201  | 200                          | 890  | 0.50                 | 12.7 | 0.18  | 4.6  | 0.010     | 0.25 |                                  | 100            | 500            |
| MLT2.7S-CP316   | 2.7                  | 69  | 10.2    | 259  | 200                          | 890  | 0.50                 | 12.7 | 0.18  | 4.6  | 0.010     | 0.25 |                                  | 100            | 500            |
| MLT4S-CP316   | 4.0                  | 102 | 14.3    | 362  | 200                          | 890  | 0.50                 | 12.7 | 0.18  | 4.6  | 0.010     | 0.25 |                                  | 100            | 500            |
| MLT6S-CP316   | 6.0                  | 152 | 20.5    | 521  | 200                          | 890  | 0.50                 | 12.7 | 0.18  | 4.6  | 0.010     | 0.25 |                                  | 100            | 500            |
| MLT8S-CP316   | 8.0                  | 203 | 26.8    | 679  | 200                          | 890  | 0.50                 | 12.7 | 0.18  | 4.6  | 0.010     | 0.25 |                                  | 100            | 500            |
| MLT10S-CP316  | 10.0                 | 254 | 33.0    | 838  | 200                          | 890  | 0.50                 | 12.7 | 0.18  | 4.6  | 0.010     | 0.25 | 100                              | 500            |                |
| <b>Light-Heavy Cross Section</b>                                    |                      |     |         |      |                              |      |                      |      |       |      |           |      |                                  |                |                |
| MLT2LH-LP316  | 2.0                  | 51  | 7.9     | 201  | 250                          | 1112 | 0.50                 | 12.7 | 0.25  | 6.4  | 0.010     | 0.25 | GS4MT, HTMT, PPTMT, ST2MT        | 50             | 250            |
| MLT4LH-LP316  | 4.0                  | 102 | 14.3    | 362  | 250                          | 1112 | 0.50                 | 12.7 | 0.25  | 6.4  | 0.010     | 0.25 |                                  | 50             | 250            |
| MLT6LH-LP316  | 6.0                  | 152 | 20.5    | 521  | 250                          | 1112 | 0.50                 | 12.7 | 0.25  | 6.4  | 0.010     | 0.25 |                                  | 50             | 250            |
| MLT8LH-LP316  | 8.0                  | 203 | 26.8    | 679  | 250                          | 1112 | 0.50                 | 12.7 | 0.25  | 6.4  | 0.010     | 0.25 |                                  | 50             | 250            |

\*Other lengths available, contact Panduit Customer Service.  
 \*\*Per SAE Standard AS23190/3 (formerly MIL). For additional details, refer to page B3.32.  
 \*\*\*For information on installation tools, refer to pages B3.14 – B3.16.



## Pan-Steel® Self-Locking Cable Ties – MLT Series (continued)

| Part Number                      | Max. Bundle Diameter |     | Length* |     | Min. Loop Tensile Strength** |      | Min. Bundle Diameter |      | Width |      | Thickness |      | Recommended Installation Tool*** | Std. Pkg. Qty. | Std. Ctn. Qty. |
|----------------------------------|----------------------|-----|---------|-----|------------------------------|------|----------------------|------|-------|------|-----------|------|----------------------------------|----------------|----------------|
|                                  | In.                  | mm  | In.     | mm  | Lbs.                         | N    | In.                  | mm   | In.   | mm   | In.       | mm   |                                  |                |                |
| <b>Heavy Cross Section</b>       |                      |     |         |     |                              |      |                      |      |       |      |           |      |                                  |                |                |
| MLT2H-LP316                      | 2.0                  | 51  | 7.9     | 201 | 450                          | 2000 | 0.50                 | 12.7 | 0.31  | 7.9  | 0.010     | 0.25 | GS4MT, ST2MT, HTMT, PPTMT, PBTMT | 50             | 250            |
| MLT2.7H-LP316                    | 2.7                  | 69  | 10.2    | 259 | 450                          | 2000 | 0.50                 | 12.7 | 0.31  | 7.9  | 0.010     | 0.25 |                                  | 50             | 250            |
| MLT4H-LP316                      | 4.0                  | 102 | 14.3    | 362 | 450                          | 2000 | 0.50                 | 12.7 | 0.31  | 7.9  | 0.010     | 0.25 |                                  | 50             | 250            |
| MLT6H-LP316                      | 6.0                  | 152 | 20.5    | 521 | 450                          | 2000 | 0.50                 | 12.7 | 0.31  | 7.9  | 0.010     | 0.25 |                                  | 50             | 250            |
| MLT8H-LP316                      | 8.0                  | 203 | 26.8    | 679 | 450                          | 2000 | 0.50                 | 12.7 | 0.31  | 7.9  | 0.010     | 0.25 |                                  | 50             | 250            |
| MLT10H-LP316                     | 10.0                 | 254 | 33.0    | 838 | 450                          | 2000 | 0.50                 | 12.7 | 0.31  | 7.9  | 0.010     | 0.25 |                                  | 50             | 250            |
| <b>Extra-Heavy Cross Section</b> |                      |     |         |     |                              |      |                      |      |       |      |           |      |                                  |                |                |
| MLT4EH-LP316                     | 4.0                  | 102 | 17.1    | 434 | 600                          | 2670 | 1.00                 | 25.4 | 0.50  | 12.7 | 0.010     | 0.25 | ST2MT, RT2HT, RT2HTN, PBTMT      | 50             | 250            |
| MLT6EH-LP316                     | 6.0                  | 152 | 23.4    | 594 | 600                          | 2670 | 1.00                 | 25.4 | 0.50  | 12.7 | 0.010     | 0.25 |                                  | 50             | 250            |
| MLT8EH-LP316                     | 8.0                  | 203 | 29.7    | 754 | 600                          | 2670 | 1.00                 | 25.4 | 0.50  | 12.7 | 0.010     | 0.25 |                                  | 50             | 250            |
| MLT4EH15-LP316                   | 4.0                  | 102 | 17.1    | 434 | 700                          | 3115 | 1.00                 | 25.4 | 0.50  | 12.7 | 0.015     | 0.38 |                                  | 50             | 250            |
| MLT6EH15-LP316                   | 6.0                  | 152 | 23.4    | 594 | 700                          | 3115 | 1.00                 | 25.4 | 0.50  | 12.7 | 0.015     | 0.38 |                                  | 50             | 250            |
| MLT8EH15-LP316                   | 8.0                  | 203 | 29.7    | 754 | 700                          | 3115 | 1.00                 | 25.4 | 0.50  | 12.7 | 0.015     | 0.38 |                                  | 50             | 250            |
| <b>Super-Heavy Cross Section</b> |                      |     |         |     |                              |      |                      |      |       |      |           |      |                                  |                |                |
| MLT4SH-LP316                     | 4.0                  | 102 | 17.1    | 434 | 900                          | 4005 | 1.00                 | 25.4 | 0.63  | 15.9 | 0.015     | 0.38 | RT2HT, RT2HTN, PBTMT             | 50             | 250            |
| MLT6SH-LP316                     | 6.0                  | 152 | 23.4    | 594 | 900                          | 4005 | 1.00                 | 25.4 | 0.63  | 15.9 | 0.015     | 0.38 |                                  | 50             | 250            |
| MLT8SH-LP316                     | 8.0                  | 203 | 29.7    | 754 | 900                          | 4005 | 1.00                 | 25.4 | 0.63  | 15.9 | 0.015     | 0.38 |                                  | 50             | 250            |

\*Other lengths available, contact Panduit Customer Service.

\*\*Per SAE Standard AS23190/3 (formerly MIL). For additional details, refer to page B3.32.

\*\*\*For information on installation tools, refer to pages B3.14 – B3.16.

A.  
System  
Overview

B1.  
Cable Ties

B2.  
Cable  
Accessories

B3.  
Stainless  
Steel Ties

C1.  
Wiring  
Duct

C2.  
Surface  
Raceway

C3.  
Abrasion  
Protection

C4.  
Cable  
Management

D1.  
Terminals

D2.  
Power  
Connectors

D3.  
Grounding  
Connectors

E1.  
Labeling  
Systems

E2.  
Labels

E3.  
Pre-Printed  
& Write-On  
Markers

E4.  
Permanent  
Identification

E5.  
Lockout/  
Tagout  
& Safety  
Solutions

F.  
Index

A. System Overview

B1. Cable Ties

B2. Cable Accessories

B3. Stainless Steel Ties

C1. Wiring Duct

C2. Surface Raceway

C3. Abrasion Protection

C4. Cable Management

D1. Terminals

D2. Power Connectors

D3. Grounding Connectors

E1. Labeling Systems

E2. Labels

E3. Pre-Printed & Write-On Markers

E4. Permanent Identification

E5. Lockout/Tagout & Safety Solutions

F. Index

## Pan-Steel® Polyester Fully Coated Cable Ties – MLTFC Series

- Polyester coating available in six color options provides visual indication for easy identification in color-coding applications (heavy cross section only)
- Self-locking head design speeds installation and locks into place at any length along the tie body
- Polyester coating provides additional edge protection and prevents corrosion between dissimilar metals
- AISI 316 stainless steel for the most corrosive environments
- Available in standard, heavy, extra-heavy and super-heavy cross sections
- UV resistant, low smoke, halogen-free material
- Temperature tolerance -40°F (-40°C) to 302°F (150°C)

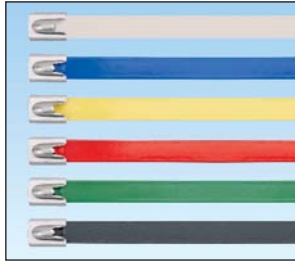

| Part Number                     | Max. Bundle Diameter |     | Length* |     | Color | Min. Loop Tensile Strength** |     | Width |     | Thickness^ |      | Recommended Installation Tool*** | Std. Pkg. Qty. | Std. Ctn. Qty. |
|---------------------------------|----------------------|-----|---------|-----|-------|------------------------------|-----|-------|-----|------------|------|----------------------------------|----------------|----------------|
|                                 | In.                  | mm  | In.     | mm  |       | Lbs.                         | N   | In.   | mm  | In.        | mm   |                                  |                |                |
| <b>Standard Cross Section^^</b> |                      |     |         |     |       |                              |     |       |     |            |      |                                  |                |                |
| MLTFC2S-CP316                   | 2.0                  | 51  | 7.9     | 201 | Black | 100                          | 445 | 0.18  | 4.6 | 0.010      | 0.25 | GS4MT, HTMT, PPTMT, ST2MT        | 100            | 500            |
| MLTFC4S-CP316                   | 4.0                  | 102 | 14.3    | 362 | Black | 100                          | 445 | 0.18  | 4.6 | 0.010      | 0.25 |                                  | 100            | 500            |
| MLTFC6S-CP316                   | 6.0                  | 152 | 20.5    | 521 | Black | 100                          | 445 | 0.18  | 4.6 | 0.010      | 0.25 |                                  | 100            | 500            |
| MLTFC8S-CP316                   | 8.0                  | 203 | 26.8    | 679 | Black | 100                          | 445 | 0.18  | 4.6 | 0.010      | 0.25 |                                  | 100            | 500            |

|                              |     |     |      |     |        |     |      |      |     |       |      |                                  |     |     |
|------------------------------|-----|-----|------|-----|--------|-----|------|------|-----|-------|------|----------------------------------|-----|-----|
| <b>Heavy Cross Section^^</b> |     |     |      |     |        |     |      |      |     |       |      |                                  |     |     |
| MLTFC2H-LP316RD              | 2.0 | 51  | 7.9  | 201 | Red    | 250 | 1112 | 0.31 | 7.9 | 0.010 | 0.25 | GS4MT, ST2MT, HTMT, PPTMT, PBTMT | 50  | 250 |
| MLTFC4H-LP316RD              | 4.0 | 102 | 14.3 | 362 | Red    | 250 | 1112 | 0.31 | 7.9 | 0.010 | 0.25 |                                  | 50  | 250 |
| MLTFC6H-LP316RD              | 6.0 | 152 | 20.5 | 521 | Red    | 250 | 1112 | 0.31 | 7.9 | 0.010 | 0.25 |                                  | 50  | 250 |
| MLTFC2H-LP316YL              | 2.0 | 51  | 7.9  | 201 | Yellow | 250 | 1112 | 0.31 | 7.9 | 0.010 | 0.25 |                                  | 50  | 250 |
| MLTFC4H-LP316YL              | 4.0 | 102 | 14.3 | 362 | Yellow | 250 | 1112 | 0.31 | 7.9 | 0.010 | 0.25 |                                  | 50  | 250 |
| MLTFC6H-LP316YL              | 6.0 | 152 | 20.5 | 521 | Yellow | 250 | 1112 | 0.31 | 7.9 | 0.010 | 0.25 |                                  | 50  | 250 |
| MLTFC2H-LP316GR              | 2.0 | 51  | 7.9  | 201 | Green  | 250 | 1112 | 0.31 | 7.9 | 0.010 | 0.25 |                                  | 50  | 250 |
| MLTFC4H-LP316GR              | 4.0 | 102 | 14.3 | 362 | Green  | 250 | 1112 | 0.31 | 7.9 | 0.010 | 0.25 |                                  | 50  | 250 |
| MLTFC6H-LP316GR              | 6.0 | 152 | 20.5 | 521 | Green  | 250 | 1112 | 0.31 | 7.9 | 0.010 | 0.25 |                                  | 50  | 250 |
| MLTFC2H-LP316BU              | 2.0 | 51  | 7.9  | 201 | Blue   | 250 | 1112 | 0.31 | 7.9 | 0.010 | 0.25 |                                  | 50  | 250 |
| MLTFC4H-LP316BU              | 4.0 | 102 | 14.3 | 362 | Blue   | 250 | 1112 | 0.31 | 7.9 | 0.010 | 0.25 |                                  | 50  | 250 |
| MLTFC6H-LP316BU              | 6.0 | 152 | 20.5 | 521 | Blue   | 250 | 1112 | 0.31 | 7.9 | 0.010 | 0.25 |                                  | 50  | 250 |
| MLTFC2H-LP316WH              | 2.0 | 51  | 7.9  | 201 | White  | 250 | 1112 | 0.31 | 7.9 | 0.010 | 0.25 |                                  | 50  | 250 |
| MLTFC4H-LP316WH              | 4.0 | 102 | 14.3 | 362 | White  | 250 | 1112 | 0.31 | 7.9 | 0.010 | 0.25 |                                  | 50  | 250 |
| MLTFC6H-LP316WH              | 6.0 | 152 | 20.5 | 521 | White  | 250 | 1112 | 0.31 | 7.9 | 0.010 | 0.25 |                                  | 50  | 250 |
| MLTFC2H-LP316                | 2.0 | 51  | 7.9  | 201 | Black  | 250 | 1112 | 0.31 | 7.9 | 0.010 | 0.25 |                                  | 50  | 250 |
| MLTFC4H-LP316                | 4.0 | 102 | 14.3 | 362 | Black  | 250 | 1112 | 0.31 | 7.9 | 0.010 | 0.25 | 50                               | 250 |     |
| MLTFC6H-LP316                | 6.0 | 152 | 20.5 | 521 | Black  | 250 | 1112 | 0.31 | 7.9 | 0.010 | 0.25 | 50                               | 250 |     |
| MLTFC8H-LP316                | 8.0 | 203 | 26.8 | 679 | Black  | 250 | 1112 | 0.31 | 7.9 | 0.010 | 0.25 | 50                               | 250 |     |

|                                    |     |     |      |     |       |     |      |      |      |       |      |                             |    |     |
|------------------------------------|-----|-----|------|-----|-------|-----|------|------|------|-------|------|-----------------------------|----|-----|
| <b>Extra-Heavy Cross Section^^</b> |     |     |      |     |       |     |      |      |      |       |      |                             |    |     |
| MLTFC4EH-LP316                     | 4.0 | 102 | 17.1 | 434 | Black | 300 | 1335 | 0.50 | 12.7 | 0.010 | 0.25 | ST2MT, RT2HT, RT2HTN, PBTMT | 50 | 250 |
| MLTFC6EH-LP316                     | 6.0 | 152 | 23.4 | 594 | Black | 300 | 1335 | 0.50 | 12.7 | 0.010 | 0.25 |                             | 50 | 250 |
| MLTFC8EH-LP316                     | 8.0 | 203 | 29.7 | 754 | Black | 300 | 1335 | 0.50 | 12.7 | 0.010 | 0.25 |                             | 50 | 250 |

|                                    |     |     |      |     |       |     |      |      |      |       |      |                      |    |     |
|------------------------------------|-----|-----|------|-----|-------|-----|------|------|------|-------|------|----------------------|----|-----|
| <b>Super-Heavy Cross Section^^</b> |     |     |      |     |       |     |      |      |      |       |      |                      |    |     |
| MLTFC4SH-LP316                     | 4.0 | 102 | 17.1 | 434 | Black | 450 | 2000 | 0.63 | 15.9 | 0.015 | 0.38 | RT2HT, RT2HTN, PBTMT | 50 | 250 |
| MLTFC6SH-LP316                     | 6.0 | 152 | 23.4 | 594 | Black | 450 | 2000 | 0.63 | 15.9 | 0.015 | 0.38 |                      | 50 | 250 |
| MLTFC8SH-LP316                     | 8.0 | 203 | 29.7 | 754 | Black | 450 | 2000 | 0.63 | 15.9 | 0.015 | 0.38 |                      | 50 | 250 |

\*Other lengths available, contact Panduit Customer Service.  
 \*\*Per SAE Standard AS23190/3 (formerly MIL). For additional details, refer to page B3.32.  
 \*\*\*For information on installation tools, refer to pages B3.14 – B3.16.  
 ^Base material less coating. ^^Minimum bundle diameter is .50"(12.7mm). ^^Minimum bundle diameter is 1.0"(25.4mm).

## Pan-Steel® Nylon 11 Selectively Coated Cable Ties – MLTC Series

- Self-locking head design speeds installation and locks into place at any length along the tie body
- Nylon 11 coating provides additional edge protection and prevents corrosion between dissimilar metals
- AISI 316 stainless steel for the most corrosive environments
- Available in heavy cross section
- UV resistant, low smoke, halogen-free material
- Temperature tolerance -40°F (-40°C) to 285°F (140°C)



| Part Number  | Max. Bundle Diameter |     | Length* |     | Min. Loop Tensile Strength** |      | Min. Bundle Diameter |      | Width |     | Thickness^ |      | Recommended Installation Tool*** | Std. Pkg. Qty. | Std. Ctn. Qty. |
|--|----------------------|-----|---------|-----|------------------------------|------|----------------------|------|-------|-----|------------|------|----------------------------------|----------------|----------------|
|  | In.                  | mm  | In.     | mm  | Lbs.                         | N    | In.                  | mm   | In.   | mm  | In.        | mm   |                                  |                |                |
| <b>AISI 316 Stainless Steel – For Nylon 11 Selectively Coated Cable Ties</b> |                      |     |         |     |                              |      |                      |      |       |     |            |      |                                  |                |                |
| <b>Heavy Cross Section</b>   |                      |     |         |     |                              |      |                      |      |       |     |            |      |                                  |                |                |
| <b>MLTC2H-LP316</b>  | 2.0                  | 51  | 7.9     | 201 | 250                          | 1112 | 0.50                 | 12.7 | 0.31  | 7.9 | 0.010      | 0.25 | GS4MT, ST2MT, HTMT, PPTMT, PBTMT | 50             | 250            |
| <b>MLTC4H-LP316</b>  | 4.0                  | 102 | 14.3    | 362 | 250                          | 1112 | 0.50                 | 12.7 | 0.31  | 7.9 | 0.010      | 0.25 |                                  | 50             | 250            |
| <b>MLTC6H-LP316</b>  | 6.0                  | 152 | 20.5    | 521 | 250                          | 1112 | 0.50                 | 12.7 | 0.31  | 7.9 | 0.010      | 0.25 |                                  | 50             | 250            |
| <b>MLTC8H-LP316</b>  | 8.0                  | 203 | 26.8    | 679 | 250                          | 1112 | 0.50                 | 12.7 | 0.31  | 7.9 | 0.010      | 0.25 |                                  | 50             | 250            |
| <b>MLTC10H-LP316</b>   | 10.0                 | 254 | 33.0    | 838 | 250                          | 1112 | 0.50                 | 12.7 | 0.31  | 7.9 | 0.010      | 0.25 |                                  | 50             | 250            |

\*Other lengths available, contact Panduit Customer Service.  
 \*\*Per SAE Standard AS23190/3 (formerly MIL). For additional details, refer to page B3.32.  
 \*\*\*For information on installation tools, refer to pages B3.14 – B3.16.  
 ^Base material less coating.

- A. System Overview
- B1. Cable Ties
- B2. Cable Accessories
- B3. Stainless Steel Ties
- C1. Wiring Duct
- C2. Surface Raceway
- C3. Abrasion Protection
- C4. Cable Management
- D1. Terminals
- D2. Power Connectors
- D3. Grounding Connectors
- E1. Labeling Systems
- E2. Labels
- E3. Pre-Printed & Write-On Markers
- E4. Permanent Identification
- E5. Lockout/Tagout & Safety Solutions
- F. Index

A.  
System  
Overview

## Pan-Alum™ Aluminum Cable Ties – MLT Series

B1.  
Cable Ties

- Self-locking head design speeds installation and locks into place at any length along the tie body
- Lightweight, aluminum construction for flexibility and ease of handling
- Five color options in addition to natural aluminum finish for color-coding applications
- Smooth surfaces and rounded edges assures cable protection and worker safety
- For use with Pan-Alum™ Marker Plates on page E4.5, for fast installation at the lowest installed cost

B2.  
Cable  
Accessories

B3.  
Stainless  
Steel Ties



C1.  
Wiring  
Duct

C2.  
Surface  
Raceway

C3.  
Abrasion  
Protection

C4.  
Cable  
Management

D1.  
Terminals

D2.  
Power  
Connectors

D3.  
Grounding  
Connectors

E1.  
Labeling  
Systems

E2.  
Labels

E3.  
Pre-Printed  
& Write-On  
Markers

E4.  
Permanent  
Identification

E5.  
Lockout/  
Tagout  
& Safety  
Solutions

F.  
Index

| Part Number         | Max. Bundle Diameter |     | Length |     | Color    | Min. Loop Tensile Strength* |     | Min. Bundle Diameter |      | Width |     | Thickness |      | Recommended Installation Tool** | Std. Pkg. Qty. | Std. Ctn. Qty. |
|---------------------|----------------------|-----|--------|-----|----------|-----------------------------|-----|----------------------|------|-------|-----|-----------|------|---------------------------------|----------------|----------------|
|                     | In.                  | mm  | In.    | mm  |          | Lbs.                        | N   | In.                  | mm   | In.   | mm  | In.       | mm   |                                 |                |                |
| <b>MLT1H-LPALBL</b> | 1.0                  | 25  | 5.5    | 140 | Black    | 50                          | 222 | 0.50                 | 12.7 | 0.31  | 7.9 | 0.012     | 0.03 | ST2MT, HTMT                     | 50             | 250            |
| <b>MLT2H-LPALBL</b> | 2.0                  | 51  | 7.9    | 201 | Black    | 50                          | 222 | 0.50                 | 12.7 | 0.31  | 7.9 | 0.012     | 0.03 |                                 | 50             | 250            |
| <b>MLT4H-LPALBL</b> | 4.0                  | 102 | 14.3   | 362 | Black    | 50                          | 222 | 0.50                 | 12.7 | 0.31  | 7.9 | 0.012     | 0.03 |                                 | 50             | 250            |
| <b>MLT1H-LPALRD</b> | 1.0                  | 25  | 5.5    | 140 | Red      | 50                          | 222 | 0.50                 | 12.7 | 0.31  | 7.9 | 0.012     | 0.03 |                                 | 50             | 250            |
| <b>MLT2H-LPALRD</b> | 2.0                  | 51  | 7.9    | 201 | Red      | 50                          | 222 | 0.50                 | 12.7 | 0.31  | 7.9 | 0.012     | 0.03 |                                 | 50             | 250            |
| <b>MLT4H-LPALRD</b> | 4.0                  | 102 | 14.3   | 362 | Red      | 50                          | 222 | 0.50                 | 12.7 | 0.31  | 7.9 | 0.012     | 0.03 |                                 | 50             | 250            |
| <b>MLT1H-LPALYL</b> | 1.0                  | 25  | 5.5    | 140 | Yellow   | 50                          | 222 | 0.50                 | 12.7 | 0.31  | 7.9 | 0.012     | 0.03 |                                 | 50             | 250            |
| <b>MLT2H-LPALYL</b> | 2.0                  | 51  | 7.9    | 201 | Yellow   | 50                          | 222 | 0.50                 | 12.7 | 0.31  | 7.9 | 0.012     | 0.03 |                                 | 50             | 250            |
| <b>MLT4H-LPALYL</b> | 4.0                  | 102 | 14.3   | 362 | Yellow   | 50                          | 222 | 0.50                 | 12.7 | 0.31  | 7.9 | 0.012     | 0.03 |                                 | 50             | 250            |
| <b>MLT1H-LPALGR</b> | 1.0                  | 25  | 5.5    | 140 | Green    | 50                          | 222 | 0.50                 | 12.7 | 0.31  | 7.9 | 0.012     | 0.03 |                                 | 50             | 250            |
| <b>MLT2H-LPALGR</b> | 2.0                  | 51  | 7.9    | 201 | Green    | 50                          | 222 | 0.50                 | 12.7 | 0.31  | 7.9 | 0.012     | 0.03 |                                 | 50             | 250            |
| <b>MLT4H-LPALGR</b> | 4.0                  | 102 | 14.3   | 362 | Green    | 50                          | 222 | 0.50                 | 12.7 | 0.31  | 7.9 | 0.012     | 0.03 |                                 | 50             | 250            |
| <b>MLT1H-LPALBU</b> | 1.0                  | 25  | 5.5    | 140 | Blue     | 50                          | 222 | 0.50                 | 12.7 | 0.31  | 7.9 | 0.012     | 0.03 |                                 | 50             | 250            |
| <b>MLT2H-LPALBU</b> | 2.0                  | 51  | 7.9    | 201 | Blue     | 50                          | 222 | 0.50                 | 12.7 | 0.31  | 7.9 | 0.012     | 0.03 |                                 | 50             | 250            |
| <b>MLT4H-LPALBU</b> | 4.0                  | 102 | 14.3   | 362 | Blue     | 50                          | 222 | 0.50                 | 12.7 | 0.31  | 7.9 | 0.012     | 0.03 |                                 | 50             | 250            |
| <b>MLT1H-LPAL</b>   | 1.0                  | 25  | 5.5    | 140 | Aluminum | 50                          | 222 | 0.50                 | 12.7 | 0.31  | 7.9 | 0.012     | 0.03 |                                 | 50             | 250            |
| <b>MLT2H-LPAL</b>   | 2.0                  | 51  | 7.9    | 201 | Aluminum | 50                          | 222 | 0.50                 | 12.7 | 0.31  | 7.9 | 0.012     | 0.03 |                                 | 50             | 250            |
| <b>MLT4H-LPAL</b>   | 4.0                  | 102 | 14.3   | 362 | Aluminum | 50                          | 222 | 0.50                 | 12.7 | 0.31  | 7.9 | 0.012     | 0.03 |                                 | 50             | 250            |

\*Per SAE Standard AS23190/3 (formerly MIL). For additional details, refer to page B3.32.

\*\*For information on installation tools, refer to page B3.15.

## Pan-Steel® Double Wrapped Cable Ties – MLTD Series

- Self-locking head design speeds installation and locks into place at any length along the tie body
- Cable tie body passes through the head two times for additional strength
- Available in heavy, extra-heavy, and super-heavy cross sections
- Available in AISI 304 stainless steel for general-purpose applications
- Available in AISI 316 stainless steel for the most corrosive environments
- Super-heavy double wrapped tested for short circuit applications up to 71.5 kA

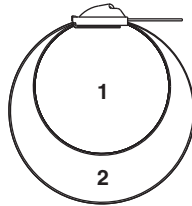

| Part Number | Max. Bundle Diameter |    | Length* |    | Min. Loop Tensile Strength** |   | Min. Bundle Diameter |    | Width |    | Thickness |    | Recommended Installation Tool*** | Std. Pkg. Qty. | Std. Ctn. Qty. |
|-------------|----------------------|----|---------|----|------------------------------|---|----------------------|----|-------|----|-----------|----|----------------------------------|----------------|----------------|
|             | In.                  | mm | In.     | mm | Lbs.                         | N | In.                  | mm | In.   | mm | In.       | mm |                                  |                |                |

### AISI 304 Stainless Steel – MLTD Double Wrapped Ties

#### Heavy Cross Section

|                 |     |     |      |      |     |      |      |      |      |     |       |      |                           |    |     |
|-----------------|-----|-----|------|------|-----|------|------|------|------|-----|-------|------|---------------------------|----|-----|
| <b>MLT2DH-L</b> | 2.0 | 51  | 18.5 | 470  | 600 | 2670 | 1.00 | 25.4 | 0.31 | 7.9 | 0.010 | 0.25 | GS4MT, HTMT, PPTMT, ST2MT | 50 | 250 |
| <b>MLT4DH-L</b> | 4.0 | 102 | 28.0 | 711  | 600 | 2670 | 1.00 | 25.4 | 0.31 | 7.9 | 0.010 | 0.25 |                           | 50 | 250 |
| <b>MLT5DH-L</b> | 5.0 | 127 | 34.0 | 863  | 600 | 2670 | 1.00 | 25.4 | 0.31 | 7.9 | 0.010 | 0.25 |                           | 50 | 250 |
| <b>MLT6DH-Q</b> | 6.0 | 152 | 40.0 | 1016 | 600 | 2670 | 1.00 | 25.4 | 0.31 | 7.9 | 0.010 | 0.25 |                           | 25 | 250 |

#### Extra-Heavy Cross Section

|                    |     |     |      |      |      |      |      |      |      |      |       |      |                             |    |     |
|--------------------|-----|-----|------|------|------|------|------|------|------|------|-------|------|-----------------------------|----|-----|
| <b>MLT4DEH-Q</b>   | 4.0 | 102 | 29.5 | 749  | 800  | 3560 | 1.00 | 25.4 | 0.50 | 12.7 | 0.010 | 0.25 | ST2MT, RT2HT, RT2HTN, PBTMT | 25 | 125 |
| <b>MLT6DEH-Q</b>   | 6.0 | 152 | 41.5 | 1054 | 800  | 3560 | 1.00 | 25.4 | 0.50 | 12.7 | 0.010 | 0.25 |                             | 25 | 125 |
| <b>MLT8DEH-Q</b>   | 8.0 | 203 | 53.5 | 1359 | 800  | 3560 | 1.00 | 25.4 | 0.50 | 12.7 | 0.010 | 0.25 |                             | 25 | 125 |
| <b>MLT4DEH15-Q</b> | 4.0 | 102 | 29.5 | 749  | 1000 | 4450 | 1.00 | 25.4 | 0.50 | 12.7 | 0.015 | 0.38 |                             | 25 | 125 |
| <b>MLT6DEH15-Q</b> | 6.0 | 152 | 41.5 | 1054 | 1000 | 4450 | 1.00 | 25.4 | 0.50 | 12.7 | 0.015 | 0.38 |                             | 25 | 125 |
| <b>MLT8DEH15-Q</b> | 8.0 | 203 | 53.5 | 1359 | 1000 | 4450 | 1.00 | 25.4 | 0.50 | 12.7 | 0.015 | 0.38 |                             | 25 | 125 |

#### Super-Heavy Cross Section

|                  |     |     |      |      |      |      |      |      |      |      |       |      |                      |    |     |
|------------------|-----|-----|------|------|------|------|------|------|------|------|-------|------|----------------------|----|-----|
| <b>MLT4DSH-Q</b> | 4.0 | 102 | 29.5 | 749  | 1200 | 5340 | 1.00 | 25.4 | 0.62 | 15.9 | 0.015 | 0.38 | RT2HT, RT2HTN, PBTMT | 25 | 125 |
| <b>MLT6DSH-Q</b> | 6.0 | 152 | 41.5 | 1054 | 1200 | 5340 | 1.00 | 25.4 | 0.62 | 15.9 | 0.015 | 0.38 |                      | 25 | 125 |
| <b>MLT8DSH-Q</b> | 8.0 | 203 | 53.5 | 1359 | 1200 | 5340 | 1.00 | 25.4 | 0.62 | 15.9 | 0.015 | 0.38 |                      | 25 | 125 |

### AISI 316 Stainless Steel – For MLTD Double Wrapped Ties

#### Extra-Heavy Cross Section

|                       |     |     |      |      |      |      |      |      |      |      |       |      |                             |    |     |
|-----------------------|-----|-----|------|------|------|------|------|------|------|------|-------|------|-----------------------------|----|-----|
| <b>MLT4DEH-Q316</b>   | 4.0 | 102 | 29.5 | 749  | 800  | 3560 | 1.00 | 25.4 | 0.50 | 12.7 | 0.010 | 0.25 | ST2MT, RT2HT, RT2HTN, PBTMT | 25 | 125 |
| <b>MLT6DEH-Q316</b>   | 6.0 | 152 | 41.5 | 1054 | 800  | 3560 | 1.00 | 25.4 | 0.50 | 12.7 | 0.010 | 0.25 |                             | 25 | 125 |
| <b>MLT8DEH-Q316</b>   | 8.0 | 203 | 53.5 | 1359 | 800  | 3560 | 1.00 | 25.4 | 0.50 | 12.7 | 0.010 | 0.25 |                             | 25 | 125 |
| <b>MLT4DEH15-Q316</b> | 4.0 | 102 | 29.5 | 749  | 1000 | 4450 | 1.00 | 25.4 | 0.50 | 12.7 | 0.015 | 0.38 |                             | 25 | 125 |
| <b>MLT6DEH15-Q316</b> | 6.0 | 152 | 41.5 | 1054 | 1000 | 4450 | 1.00 | 25.4 | 0.50 | 12.7 | 0.015 | 0.38 |                             | 25 | 125 |
| <b>MLT8DEH15-Q316</b> | 8.0 | 203 | 53.5 | 1359 | 1000 | 4450 | 1.00 | 25.4 | 0.50 | 12.7 | 0.015 | 0.38 |                             | 25 | 125 |

#### Super-Heavy Cross Section

|                     |     |     |      |      |      |      |      |      |      |      |       |      |                      |    |     |
|---------------------|-----|-----|------|------|------|------|------|------|------|------|-------|------|----------------------|----|-----|
| <b>MLT4DSH-Q316</b> | 4.0 | 102 | 29.5 | 749  | 1200 | 5340 | 1.00 | 25.4 | 0.63 | 15.9 | 0.015 | 0.38 | RT2HT, RT2HTN, PBTMT | 25 | 125 |
| <b>MLT6DSH-Q316</b> | 6.0 | 152 | 41.5 | 1054 | 1200 | 5340 | 1.00 | 25.4 | 0.63 | 15.9 | 0.015 | 0.38 |                      | 25 | 125 |
| <b>MLT8DSH-Q316</b> | 8.0 | 203 | 53.5 | 1359 | 1200 | 5340 | 1.00 | 25.4 | 0.63 | 15.9 | 0.015 | 0.38 |                      | 25 | 125 |

\*Other lengths available, contact Panduit Customer Service.

\*\*Per SAE Standard AS23190/3 (formerly MIL). For additional details, refer to page B3.32.

\*\*\*For information on installation tools, refer to pages B3.14 – B3.16.

A.  
System  
Overview

B1.  
Cable Ties

B2.  
Cable  
Accessories

B3.  
Stainless  
Steel Ties

C1.  
Wiring  
Duct

C2.  
Surface  
Raceway

C3.  
Abrasion  
Protection

C4.  
Cable  
Management

D1.  
Terminals

D2.  
Power  
Connectors

D3.  
Grounding  
Connectors

E1.  
Labeling  
Systems

E2.  
Labels

E3.  
Pre-Printed  
& Write-On  
Markers

E4.  
Permanent  
Identification

E5.  
Lockout/  
Tagout  
& Safety  
Solutions

F.  
Index



A. System Overview

## Pan-Steel® Custom Length Banding – MBS, MBH, MBEH and MBSH Series

B1. Cable Ties

- For applications that require various bundle diameters
- Supplied in reels of 82.50 feet (25.0m), 200.00 feet (60.9m), 250.00 feet (76.2m) or 1000.00 feet (304.8m)
- Provides job site versatility with minimum inventory
- Packaging speeds removal of steel and includes bundle diameter cut-off guide

### Polyester coating (optional):

- Polyester coating provides additional edge protection and prevents corrosion between dissimilar metals
- UV resistant, low smoke, halogen-free material
- Temperature tolerance -40°F (-40°C) to 302°F (150°C)
- AISI 316 stainless steel for the most corrosive environments

B2. Cable Accessories

B3. Stainless Steel Ties



C1. Wiring Duct

C2. Surface Raceway

C3. Abrasion Protection

C4. Cable Management

D1. Terminals

D2. Power Connectors

D3. Grounding Connectors

E1. Labeling Systems

E2. Labels

E3. Pre-Printed & Write-On Markers

E4. Permanent Identification

E5. Lockout/Tagout & Safety Solutions

F. Index

**KNOCK-OUT HANDLE LOCATION (BOTH SIDES)**

**METRIC MEASURE**

**DIAMETER CUT-OFF GUIDE**

**FOLD OVER RETAINER TAB**

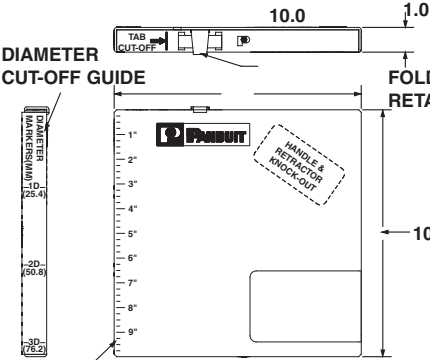
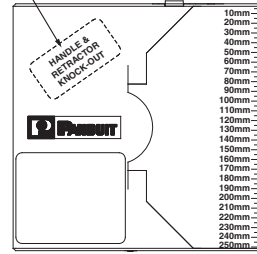

**ENGLISH MEASURE**

| Part Number | Max. Bundle Diameter |    | Length* |   | Min. Loop Tensile Strength** |   | Min. Bundle Diameter |    | Width |    | Thickness^ |    | Recommended Installation Tool*** | Recommended Banding Head | Std. Pkg. Qty.‡ |
|-------------|----------------------|----|---------|---|------------------------------|---|----------------------|----|-------|----|------------|----|----------------------------------|--------------------------|-----------------|
|             | In.                  | mm | Ft.     | m | Lbs.                         | N | In.                  | mm | In.   | mm | In.        | mm |                                  |                          |                 |

### AISI 304 Stainless Steel — For General Purpose Banding

#### Standard Cross Section

|                |     |     |      |     |     |     |      |      |      |     |       |      |                           |        |   |
|----------------|-----|-----|------|-----|-----|-----|------|------|------|-----|-------|------|---------------------------|--------|---|
| <b>MBS-TLR</b> | Any | Any | 250  | 76  | 100 | 445 | 0.50 | 12.7 | 0.18 | 4.4 | 0.010 | 0.25 | GS4MT, ST2MT, HTMT, PPTMT | MTHS-C | 1 |
| <b>MBS-MR</b>  | Any | Any | 1000 | 305 | 100 | 445 | 0.50 | 12.7 | 0.18 | 4.4 | 0.010 | 0.25 | GS4MT, ST2MT, HTMT, PPTMT | MTHS-C | 1 |

#### Heavy Cross Section

|                |     |     |      |     |     |      |      |      |      |     |       |      |                                  |        |   |
|----------------|-----|-----|------|-----|-----|------|------|------|------|-----|-------|------|----------------------------------|--------|---|
| <b>MBH-TLR</b> | Any | Any | 250  | 76  | 250 | 1112 | 0.50 | 12.7 | 0.31 | 7.9 | 0.010 | 0.25 | GS4MT, ST2MT, HTMT, PPTMT, PBTMT | MTHH-C | 1 |
| <b>MBH-MR</b>  | Any | Any | 1000 | 305 | 250 | 1112 | 0.50 | 12.7 | 0.31 | 7.9 | 0.010 | 0.25 |                                  | MTHH-C | 1 |

#### Extra-Heavy Cross Section

|                 |     |     |     |    |     |      |      |      |      |      |       |      |                             |         |   |
|-----------------|-----|-----|-----|----|-----|------|------|------|------|------|-------|------|-----------------------------|---------|---|
| <b>MBEH-TLR</b> | Any | Any | 250 | 76 | 300 | 1335 | 1.00 | 25.4 | 0.50 | 12.7 | 0.010 | 0.25 | ST2MT, RT2HT, RT2HTN, PBTMT | MTHEH-C | 1 |
|-----------------|-----|-----|-----|----|-----|------|------|------|------|------|-------|------|-----------------------------|---------|---|

#### Super-Heavy Cross Section

|                |     |     |     |    |     |      |      |      |      |      |       |      |                      |         |   |
|----------------|-----|-----|-----|----|-----|------|------|------|------|------|-------|------|----------------------|---------|---|
| <b>MBSH-TR</b> | Any | Any | 200 | 61 | 450 | 2000 | 1.00 | 25.4 | 0.63 | 15.9 | 0.015 | 0.38 | RT2HT, RT2HTN, PBTMT | MTHSH-C | 1 |
|----------------|-----|-----|-----|----|-----|------|------|------|------|------|-------|------|----------------------|---------|---|

### AISI 316 Stainless Steel — For Superior Corrosion Resistance

#### Standard Cross Section

|                   |     |     |      |     |     |     |      |      |      |     |       |      |                           |           |   |
|-------------------|-----|-----|------|-----|-----|-----|------|------|------|-----|-------|------|---------------------------|-----------|---|
| <b>MBS-TLR316</b> | Any | Any | 250  | 76  | 100 | 445 | 0.50 | 12.7 | 0.18 | 4.4 | 0.010 | 0.25 | GS4MT, ST2MT, HTMT, PPTMT | MTHS-C316 | 1 |
| <b>MBS-MR316</b>  | Any | Any | 1000 | 305 | 100 | 445 | 0.50 | 12.7 | 0.18 | 4.4 | 0.010 | 0.25 | GS4MT, ST2MT, HTMT, PPTMT | MTHS-C316 | 1 |

#### Heavy Cross Section

|                   |     |     |      |     |     |      |      |      |      |     |       |      |                                  |           |   |
|-------------------|-----|-----|------|-----|-----|------|------|------|------|-----|-------|------|----------------------------------|-----------|---|
| <b>MBH-TLR316</b> | Any | Any | 250  | 76  | 250 | 1112 | 0.50 | 12.7 | 0.31 | 7.9 | 0.010 | 0.25 | GS4MT, ST2MT, HTMT, PPTMT, PBTMT | MTHH-C316 | 1 |
| <b>MBH-MR316</b>  | Any | Any | 1000 | 305 | 250 | 1112 | 0.50 | 12.7 | 0.31 | 7.9 | 0.010 | 0.25 |                                  | MTHH-C316 | 1 |

#### Extra-Heavy Cross Section

|                    |     |     |     |    |     |      |      |      |      |      |       |      |                             |            |   |
|--------------------|-----|-----|-----|----|-----|------|------|------|------|------|-------|------|-----------------------------|------------|---|
| <b>MBEH-TLR316</b> | Any | Any | 250 | 76 | 300 | 1335 | 1.00 | 25.4 | 0.50 | 12.7 | 0.010 | 0.25 | ST2MT, RT2HT, RT2HTN, PBTMT | MTHEH-C316 | 1 |
|--------------------|-----|-----|-----|----|-----|------|------|------|------|------|-------|------|-----------------------------|------------|---|

#### Super-Heavy Cross Section

|                   |     |     |     |    |     |      |      |      |      |      |       |      |                      |            |   |
|-------------------|-----|-----|-----|----|-----|------|------|------|------|------|-------|------|----------------------|------------|---|
| <b>MBSH-TR316</b> | Any | Any | 200 | 61 | 450 | 2000 | 1.00 | 25.4 | 0.63 | 15.9 | 0.015 | 0.38 | RT2HT, RT2HTN, PBTMT | MTHSH-C316 | 1 |
|-------------------|-----|-----|-----|----|-----|------|------|------|------|------|-------|------|----------------------|------------|---|

\*Other lengths available, contact Panduit Customer Service.

\*\*Per SAE Standard AS23190/3 (formerly MIL). For additional details, refer to page B3.32.

\*\*\*For information on installation tools, refer to pages B3.14 – B3.16.

^Base material less coating

‡Order in number of reels required.

## Pan-Steel® Custom Length Banding – MBS, MBH, MBEH and MBSH Series

| Part Number                                      | Max. Bundle Diameter |     | Length* |    | Min. Loop Tensile Strength** |      | Min. Bundle Diameter |      | Width |      | Thickness^ |      | Recommended Installation Tool*** | Recommended Banding Head | Std. Pkg. Qty.‡ |
|--|----------------------|-----|---------|----|------------------------------|------|----------------------|------|-------|------|------------|------|----------------------------------|--------------------------|-----------------|
|  | In.                  | mm  | Ft.     | m  | Lbs.                         | N    | In.                  | mm   | In.   | mm   | In.        | mm   |                                  |                          |                 |
| <b>Polyester Coated AISI 316 Stainless Steel</b> |                      |     |         |    |                              |      |                      |      |       |      |            |      |                                  |                          |                 |
| <b>Heavy Cross Section</b>                       |                      |     |         |    |                              |      |                      |      |       |      |            |      |                                  |                          |                 |
| MBCH-QR316                                       | Any                  | Any | 82      | 25 | 250                          | 1112 | 0.50                 | 12.7 | 0.31  | 7.9  | 0.010      | 0.25 | GS4MT, ST2MT, HTMT, PPTMT, PBTMT | MTHCH-C316               | 1               |
| <b>Extra-Heavy Cross Section</b>                 |                      |     |         |    |                              |      |                      |      |       |      |            |      |                                  |                          |                 |
| MBCEH-QR316                                      | Any                  | Any | 82      | 25 | 300                          | 1335 | 1.00                 | 25.4 | 0.50  | 12.7 | 0.010      | 0.25 | ST2MT, RT2HT, RT2HTN, PBTMT      | MTHCEH-C316              | 1               |
| <b>Super-Heavy Cross Section</b>                 |                      |     |         |    |                              |      |                      |      |       |      |            |      |                                  |                          |                 |
| MBCSH-QR316                                      | Any                  | Any | 82      | 25 | 450                          | 2000 | 1.00                 | 25.4 | 0.63  | 15.9 | 0.015      | 0.38 | RT2HT, RT2HTN, PBTMT             | MTHCSH-C316              | 1               |

\*Other lengths available, contact Panduit Customer Service.  
 \*\*Per SAE Standard AS23190/3 (formerly MIL). For additional details, refer to page B3.32.  
 \*\*\*For information on installation tools, refer to pages B3.14 – B3.16.  
 ^Base material less coating  
 ‡Order in number of reels required.

*To determine the proper amount of banding required, use the following formula:*

|  |  |
|--|--|
| <b>Calculate S and H Cross Section</b>   | Diameter inches (mm) x 3.14 + 3 inches (76mm)    |
| <b>Calculate EH and SH Cross Section</b> | Diameter inches (mm) x 3.14 + 4.5 inches (114mm) |

## Pan-Steel® Custom Length Banding Heads – MTH Series

- Self-locking head design speeds installation and locks into place at any length along the tie body



| Part Number                            | Part Description   | Std. Pkg. Qty. | Std. Ctn. Qty. |
|--|--|----------------|----------------|
| <b>AISI 304 Stainless Steel</b>        |  |                |                |
| MTHS-C                                 | Loose piece banding head for standard cross section banding.           | 100            | 1000           |
| MTHH-C                                 | Loose piece banding head for heavy cross section banding.              | 100            | 1000           |
| MTHEH-C                                | Loose piece banding head for extra-heavy cross section banding.        | 100            | 1000           |
| MTHSH-C                                | Loose piece banding head for super-heavy cross section banding.        | 100            | 1000           |
| <b>AISI 316 Stainless Steel</b>        |  |                |                |
| MTHS-C316                              | Loose piece banding head for standard cross section banding.           | 100            | 1000           |
| MTHH-C316                              | Loose piece banding head for heavy cross section banding.              | 100            | 1000           |
| MTHEH-C316                             | Loose piece banding head for extra-heavy cross section banding.        | 100            | 1000           |
| MTHSH-C316                             | Loose piece banding head for super-heavy cross section banding.        | 100            | 1000           |
| <b>AISI 316 Coated Stainless Steel</b> |  |                |                |
| MTHCH-C316                             | Loose piece coated banding head for heavy cross section banding.       | 100            | 1000           |
| MTHCEH-C316                            | Loose piece coated banding head for extra-heavy cross section banding. | 100            | 1000           |
| MTHCSH-C316                            | Loose piece coated banding head for super-heavy cross section banding. | 100            | 1000           |

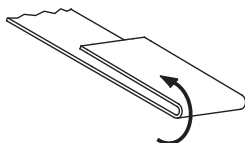

1) Take one end of the cut banding and bend back 1/2" (13mm).

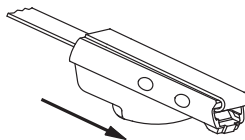

2) Take a self-locking head and slide it the entire length of the band until it reaches the bend.

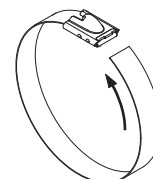

3) Bend tail flat against bottom of banding head to complete assembly.

A.  
System  
Overview

## GS4MT Hand Operated Installation Tool

B1.  
Cable Ties

- Single handle operation for fast installation
- Cable tie side entry for immediate positioning of tie and tool
- Controlled tension, fully adjustable
- Easy removal of excess tie

- Qualified product listed per MIL Standard MS90387-3
- Automatically tensions and cuts off tie when predetermined tension is reached
- Installs standard .18 inch (4.6mm), light-heavy .25 inch (6.4mm) and heavy .31 inch (7.9mm) cross section ties

B2.  
Cable  
Accessories

B3.  
Stainless  
Steel Ties



GS4MT

| Part Number    | Part Description  | Std. Pkg. Qty. |
|----------------|---|----------------|
| <b>GS4MT</b>   | Used with standard, light-heavy, and heavy cross section Pan-Steel® type MLT ties, type MLTC/MLTFC coated ties, and type MLTDH double wrapped ties. | 1              |
| <b>K4M-BLD</b> | Replacement cutter blade for GS4MT.   | 1              |
| <b>K4MTG</b>   | Replacement tension gripper for GS4MT.  | 1              |
| <b>CAMT</b>    | Cut-off accessory. Use this accessory with GS4MT tool to cut MBH or MBS continuous banding. Accessory drops in place for use.                       | 1              |

C1.  
Wiring  
Duct

C2.  
Surface  
Raceway

C3.  
Abrasion  
Protection

C4.  
Cable  
Management



Side Entry



CAMT

D1.  
Terminals

D2.  
Power  
Connectors

## Tool Tension Locking Kits

- For applications requiring a locking device on either the selector knob (one cross section size and tension only) or tension level adjustment (but allow cross section size changes)

D3.  
Grounding  
Connectors

E1.  
Labeling  
Systems



| Part Number  | Part Description   | Std. Pkg. Qty. |
|--------------|--|----------------|
| <b>TTLK3</b> | Tool tension locking kit for GS4MT and PPTMT installation tools. | 1              |

E2.  
Labels

To lock selector knob and tension level.

E3.  
Pre-Printed  
& Write-On  
Markers

E4.  
Permanent  
Identification



To lock fine adjustment.

E5.  
Lockout/  
Tagout  
& Safety  
Solutions

F.  
Index

## ST2MT Installation Tool

- Cable tie side entry for immediate positioning of tie and tool
- One hand operation – lightweight
- Easy removal of excess tie
- Tool tension is controlled by installer – twist action cut-off
- Rugged, lightweight, easy-to-operate pliers-type tool provides mechanical advantage



| Part Number | Part Description  | Std. Pkg. Qty. |
|-------------|---|----------------|
| ST2MT       | Used with standard, light-heavy, heavy and extra-heavy cross section Pan-Steel® type MLT ties, type MLTC/MLTFC coated ties, and type MLTDH double wrapped ties. | 1              |

## RT2HT and RT2HTN Installation Tools

- Cable tie side entry for immediate positioning of tie and tool to speed installation
- Multi-position rear handle provides flexibility for a one or two hand installation
- Narrow nose tool design option available for applications requiring installations in tight confined spaces
- Replacement cutter blade and handle available for RT2HT



RT2HT



RT2HTN

| Part Number | Part Description   | Std. Pkg. Qty. |
|-------------|--|----------------|
| RT2HT       | Used with extra-heavy, extra-heavy 15, and super-heavy cross section Pan-Steel® type MLT and MLTFC ties. Width of tool nose 2.60" (66.0mm).                                  | 1              |
| RT2HTN      | Narrow nose installation tool for use with extra-heavy, extra-heavy 15, and super-heavy cross section Pan-Steel® type MLT and MLTFC ties. Width of tool nose 1.06" (27.0mm). | 1              |

## HTMT Installation Tool

- Economical
- Coiled tie end remaining after tensioning assures a safe end
- Manual tension, no cut-off
- Installs ties parallel to the bundle



| Part Number | Part Description  | Std. Pkg. Qty. |
|-------------|---|----------------|
| HTMT        | Used with standard, light-heavy, and heavy cross section Pan-Steel® type MLT ties, type MLTC/MLTFC coated ties, and type MLTDH double wrapped ties. | 1              |

A.  
System  
Overview

B1.  
Cable Ties

B2.  
Cable  
Accessories

B3.  
Stainless  
Steel Ties

C1.  
Wiring  
Duct

C2.  
Surface  
Raceway

C3.  
Abrasion  
Protection

C4.  
Cable  
Management

D1.  
Terminals

D2.  
Power  
Connectors

D3.  
Grounding  
Connectors

E1.  
Labeling  
Systems

E2.  
Labels

E3.  
Pre-Printed  
& Write-On  
Markers

E4.  
Permanent  
Identification

E5.  
Lockout/  
Tagout  
& Safety  
Solutions

F.  
Index

A. System Overview

## PPTMT Pneumatic Installation Tool

B1. Cable Ties

- Power assisted tool for fast and effortless installation
- Cable tie side entry for immediate positioning of tie and tool
- Controlled tension, fully adjustable
- Automatic cut-off
- One hand operation – lightweight
- Easy removal of excess tie
- Operates 85 PSI (586 KPA Bar) non-lubricated air and requires no special maintenance

B2. Cable Accessories

B3. Stainless Steel Ties



PPTMT

| Part Number    | Part Description   | Std. Pkg. Qty. |
|----------------|--|----------------|
| <b>PPTMT</b>   | Pneumatic hand tool used with Pan-Steel® type MLT ties, type MLTC/MLTFC coated ties, and type MLTDH double wrapped ties. Automatically tensions and cuts off tie when predetermined tension is reached, providing more reliable and consistent installations. Ideal for high production applications. Installs standard .18" (4.6mm), light-heavy .25" (6.4mm), and heavy .31" (7.9mm) cross section ties. | 1              |
| <b>PPH10</b>   | 10.0' (3m) hose assembly (regulator to tool); includes a .13" (3.3mm) NPT male connector (to regulator) and .13" (3.3mm) female quick disconnect (to tool).  | 1              |
| <b>PL289N1</b> | Filter/regulator .5 micron element, regulated range 3 – 100 psig, features .13" (3.3mm) NPT female output port (to hose PPH10) and .25" (6.4mm) male quick disconnect to source air line.  | 1              |
| <b>KPPTMTG</b> | Replacement gripper kit for PPTMT.   | 1              |
| <b>KPPTMTB</b> | Replacement blade kit for PPTMT.   | 1              |

C1. Wiring Duct

C2. Surface Raceway

C3. Abrasion Protection

C4. Cable Management



Side Entry

D1. Terminals

D2. Power Connectors

D3. Grounding Connectors

E1. Labeling Systems

E2. Labels

E3. Pre-Printed & Write-On Markers

E4. Permanent Identification

E5. Lockout/Tagout & Safety Solutions

F. Index

## **NEW!** PBTMT Battery Powered Installation Tool

- Lithium-Ion battery optimizes performance by installing more cable ties per charge
- Ergonomic tool design provides a compact lightweight body, reducing operator fatigue
- Automatic flush cut off enhances productivity with easy one hand installation
- Cable tie side entry allows quick side entry of tie into tool to speed installation
- 360° rotating head allows access to confined spaces
- Controlled tension mechanism provides consistent installations every time
- Battery indicator improves productivity with quick visual identification of battery life
- Variable speed trigger provides increased operator control, for easy installation



PBTMT

| Part Number  | Part Description   | Std. Pkg. Qty. |
|--------------|--|----------------|
| <b>PBTMT</b> | Battery powered installation tool, for use with Pan-Steel® heavy, extra-heavy, and super-heavy cross section MLT style ties, and MLTD double wrapped style ties, 2 – 12 volt Lithium-Ion batteries and 115 volt, 60 Hz charger included. | 1              |



360° Rotating Head

## Features and Benefits – Pan-Steel® Retained Tension Ties – MRT/MRS Series

Panduit® Pan-Steel® Retained Tension Ties are engineered for safety, productivity, and durability by providing round edges and smooth surfaces, easy threading, high loop tensile strength and tight clamping.

### Panduit Retained Tension Tie Technology

#### Features of Retained Tension Ties (MRT and MRS Series)

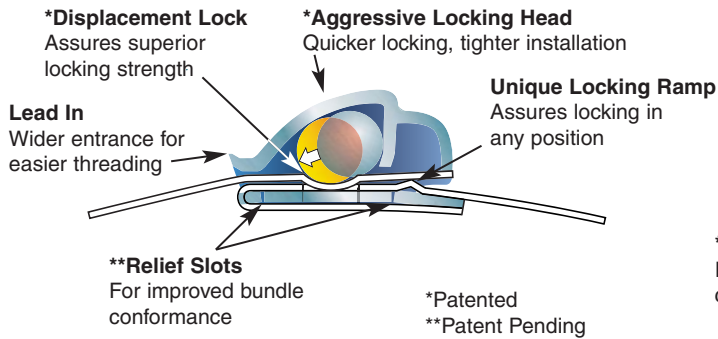

#### Additional Features of 360° Radial Seal Retained Tension Ties (MRS Series Only)

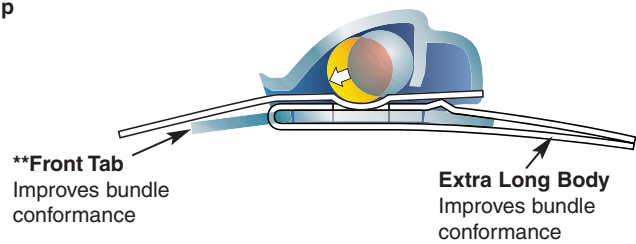

### Retained Tension Performance Comparison\*\*

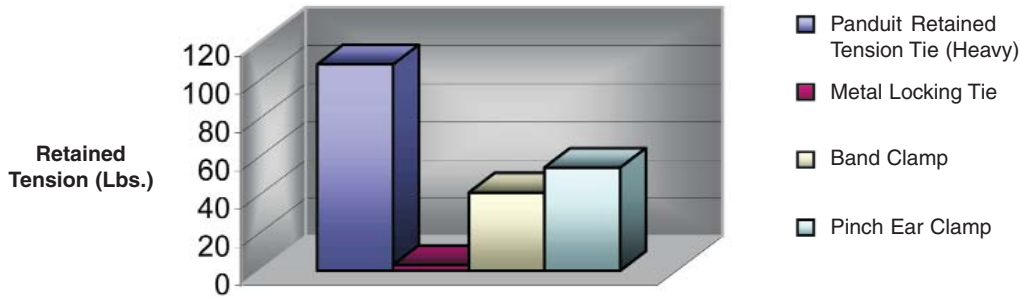

\*\*Representative sample, actual results may vary.

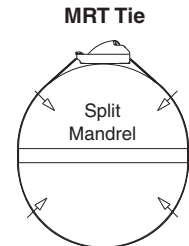

**Retained Tension**  
Split mandrel test fixture measures retained tension of installed tie

- A. System Overview
- B1. Cable Ties
- B2. Cable Accessories
- B3. Stainless Steel Ties
- C1. Wiring Duct
- C2. Surface Raceway
- C3. Abrasion Protection
- C4. Cable Management
- D1. Terminals
- D2. Power Connectors
- D3. Grounding Connectors
- E1. Labeling Systems
- E2. Labels
- E3. Pre-Printed & Write-On Markers
- E4. Permanent Identification
- E5. Lockout/Tagout & Safety Solutions
- F. Index



A. System Overview

## Part Number System for Pan-Steel® Retained Tension Ties – MRT Series

B1. Cable Ties

**MRT**

Type

MRT = Metal Retained Tension Tie

**6**

Bundle Diameter Reference (In.)

**S**

Cross Section

S = Standard  
LH = Light-Heavy  
H = Heavy

—

**C**

Package Qty.

L = 50  
C = 100

**4**

Material

4 = 304

B2. Cable Accessories

B3. Stainless Steel Ties

## **NEW!** Pan-Steel® Retained Tension Ties – MRT Series

- Provide tight bundling of armored cables, pipes, conduit and other rigid materials in harsh conditions for a reliable, easy to install fastening solution

- Self-locking cable tie design locks into place at any length along the tie body, unlike fixed diameter band clamps
- Available in AISI 304 stainless steel with a thickness of 0.010" (0.25mm)



C1. Wiring Duct

C2. Surface Raceway

C3. Abrasion Protection

C4. Cable Management

D1. Terminals

| Part Number | Max. Bundle Diameter |    | Length |    | Min. Loop Tensile Strength |   | Min. Bundle Diameter |    | Width |    | Recommended Installation Tool*** | Std. Pkg. Qty. | Std. Ctn. Qty. |
|-------------|----------------------|----|--------|----|----------------------------|---|----------------------|----|-------|----|----------------------------------|----------------|----------------|
|             | In.                  | mm | In.    | mm | Lbs.                       | N | In.                  | mm | In.   | mm |                                  |                |                |

### AISI 304 Stainless Steel – For General Purpose

#### Standard Cross Section

|                 |     |     |      |     |     |     |      |      |      |     |        |     |     |
|-----------------|-----|-----|------|-----|-----|-----|------|------|------|-----|--------|-----|-----|
| <b>MRT1S-C4</b> | 1.0 | 25  | 9.0  | 229 | 180 | 800 | 0.75 | 19.1 | 0.18 | 4.4 | MTRTLS | 100 | 500 |
| <b>MRT2S-C4</b> | 2.0 | 51  | 12.2 | 310 | 180 | 800 | 0.75 | 19.1 | 0.18 | 4.4 |        | 100 | 500 |
| <b>MRT4S-C4</b> | 4.0 | 102 | 18.5 | 470 | 180 | 800 | 0.75 | 19.1 | 0.18 | 4.4 |        | 100 | 500 |
| <b>MRT6S-C4</b> | 6.0 | 152 | 24.8 | 630 | 180 | 800 | 0.75 | 19.1 | 0.18 | 4.4 |        | 100 | 500 |

#### Light-Heavy Cross Section

|                    |     |     |      |     |     |      |      |      |      |     |        |    |     |
|--------------------|-----|-----|------|-----|-----|------|------|------|------|-----|--------|----|-----|
| <b>MRT1.5LH-L4</b> | 1.5 | 38  | 10.6 | 269 | 225 | 1000 | 1.00 | 25.4 | 0.25 | 6.4 | MTRTLS | 50 | 250 |
| <b>MRT2LH-L4</b>   | 2.0 | 51  | 12.2 | 310 | 225 | 1000 | 1.00 | 25.4 | 0.25 | 6.4 |        | 50 | 250 |
| <b>MRT4LH-L4</b>   | 4.0 | 102 | 18.5 | 470 | 225 | 1000 | 1.00 | 25.4 | 0.25 | 6.4 |        | 50 | 250 |
| <b>MRT6LH-L4</b>   | 6.0 | 152 | 24.8 | 630 | 225 | 1000 | 1.00 | 25.4 | 0.25 | 6.4 |        | 50 | 250 |

#### Heavy Cross Section

|                   |     |     |      |     |     |      |      |      |      |     |       |    |     |
|-------------------|-----|-----|------|-----|-----|------|------|------|------|-----|-------|----|-----|
| <b>MRT1.5H-L4</b> | 1.5 | 38  | 10.6 | 269 | 400 | 1780 | 1.00 | 25.4 | 0.31 | 7.9 | MTRTH | 50 | 250 |
| <b>MRT2H-L4</b>   | 2.0 | 51  | 12.2 | 310 | 400 | 1780 | 1.00 | 25.4 | 0.31 | 7.9 |       | 50 | 250 |
| <b>MRT4H-L4</b>   | 4.0 | 102 | 18.5 | 470 | 400 | 1780 | 1.00 | 25.4 | 0.31 | 7.9 |       | 50 | 250 |
| <b>MRT6H-L4</b>   | 6.0 | 152 | 24.8 | 630 | 400 | 1780 | 1.00 | 25.4 | 0.31 | 7.9 |       | 50 | 250 |

### Double Wrapped – For Additional Strength

#### Standard Cross Section

|                    |     |    |      |     |     |      |      |      |      |     |        |     |     |
|--------------------|-----|----|------|-----|-----|------|------|------|------|-----|--------|-----|-----|
| <b>MRT1.5DS-C4</b> | 1.5 | 38 | 14.4 | 366 | 250 | 1112 | 1.00 | 25.4 | 0.17 | 4.4 | MTRTLS | 100 | 500 |
| <b>MRT2.5DS-C4</b> | 2.5 | 63 | 20.7 | 526 | 250 | 1112 | 1.00 | 25.4 | 0.17 | 4.4 |        | 100 | 500 |

#### Light-Heavy Cross Section

|                     |     |    |      |     |     |      |      |      |      |     |        |    |     |
|---------------------|-----|----|------|-----|-----|------|------|------|------|-----|--------|----|-----|
| <b>MRT2.5DLH-L4</b> | 2.5 | 63 | 20.7 | 526 | 350 | 1556 | 1.00 | 25.4 | 0.25 | 6.4 | MTRTLS | 50 | 250 |
|---------------------|-----|----|------|-----|-----|------|------|------|------|-----|--------|----|-----|

#### Heavy Cross Section

|                  |     |     |      |     |     |      |      |      |      |     |       |    |     |
|------------------|-----|-----|------|-----|-----|------|------|------|------|-----|-------|----|-----|
| <b>MRT2DH-L4</b> | 2.0 | 51  | 18.5 | 470 | 550 | 2447 | 1.00 | 25.4 | 0.31 | 7.9 | MTRTH | 50 | 250 |
| <b>MRT4DH-L4</b> | 4.0 | 102 | 31.1 | 790 | 550 | 2447 | 1.00 | 25.4 | 0.31 | 7.9 |       | 50 | 250 |

\*\*\*For information on installation tools, refer to page B3.20.

D2. Power Connectors

D3. Grounding Connectors

E1. Labeling Systems

E2. Labels

E3. Pre-Printed & Write-On Markers

E4. Permanent Identification

E5. Lockout/Tagout & Safety Solutions

F. Index

## Part Number System for Pan-Steel® 360° Radial Seal Retained Tension Ties – MRS Series

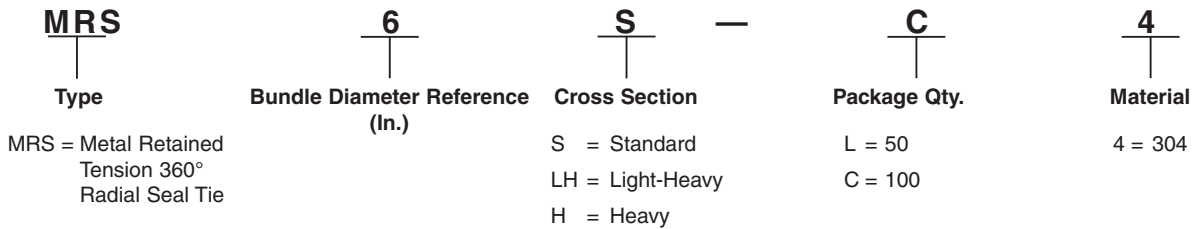

## Pan-Steel® 360° Radial Seal Retained Tension Ties – MRS Series

- 360° radial seal eliminates gaps under the head of the tie to provide a completely sealed installation

- Self-locking cable tie design locks into place at any length along the tie body, unlike fixed diameter band clamps
- Available in AISI 304 stainless steel with a thickness of 0.010" (0.25mm)



| Part Number | Max. Bundle Diameter |    | Length |    | Min. Loop Tensile Strength |   | Min. Bundle Diameter |    | Width |    | Recommended Installation Tool*** | Std. Pkg. Qty. | Std. Ctn. Qty. |
|-------------|----------------------|----|--------|----|----------------------------|---|----------------------|----|-------|----|----------------------------------|----------------|----------------|
|             | In.                  | mm | In.    | mm | Lbs.                       | N | In.                  | mm | In.   | mm |                                  |                |                |

### AISI 304 Stainless Steel – For General Purpose

#### Standard Cross Section

|          |     |     |      |     |     |     |      |      |      |     |        |     |     |
|----------|-----|-----|------|-----|-----|-----|------|------|------|-----|--------|-----|-----|
| MRS1S-C4 | 1.0 | 25  | 9.0  | 229 | 180 | 800 | 0.75 | 19.1 | 0.18 | 4.4 | MTRTLS | 100 | 500 |
| MRS2S-C4 | 2.0 | 51  | 12.2 | 310 | 180 | 800 | 0.75 | 19.1 | 0.18 | 4.4 |        | 100 | 500 |
| MRS4S-C4 | 4.0 | 102 | 18.5 | 470 | 180 | 800 | 0.75 | 19.1 | 0.18 | 4.4 |        | 100 | 500 |
| MRS6S-C4 | 6.0 | 152 | 24.8 | 630 | 180 | 800 | 0.75 | 19.1 | 0.18 | 4.4 |        | 100 | 500 |

#### Light-Heavy Cross Section

|             |     |     |      |     |     |      |      |      |      |     |        |    |     |
|-------------|-----|-----|------|-----|-----|------|------|------|------|-----|--------|----|-----|
| MRS1.5LH-L4 | 1.5 | 38  | 10.6 | 269 | 225 | 1000 | 1.00 | 25.4 | 0.25 | 6.4 | MTRTLS | 50 | 250 |
| MRS2LH-L4   | 2.0 | 51  | 12.2 | 310 | 225 | 1000 | 1.00 | 25.4 | 0.25 | 6.4 |        | 50 | 250 |
| MRS4LH-L4   | 4.0 | 102 | 18.5 | 470 | 225 | 1000 | 1.00 | 25.4 | 0.25 | 6.4 |        | 50 | 250 |
| MRS6LH-L4   | 6.0 | 152 | 24.8 | 630 | 225 | 1000 | 1.00 | 25.4 | 0.25 | 6.4 |        | 50 | 250 |

#### Heavy Cross Section

|            |     |     |      |     |     |      |      |      |      |     |       |    |     |
|------------|-----|-----|------|-----|-----|------|------|------|------|-----|-------|----|-----|
| MRS1.5H-L4 | 1.5 | 38  | 10.6 | 269 | 400 | 1780 | 1.00 | 25.4 | 0.31 | 7.9 | MTRTH | 50 | 250 |
| MRS2H-L4   | 2.0 | 51  | 12.2 | 310 | 400 | 1780 | 1.00 | 25.4 | 0.31 | 7.9 |       | 50 | 250 |
| MRS4H-L4   | 4.0 | 102 | 18.5 | 470 | 400 | 1780 | 1.00 | 25.4 | 0.31 | 7.9 |       | 50 | 250 |
| MRS6H-L4   | 6.0 | 152 | 24.8 | 630 | 400 | 1780 | 1.00 | 25.4 | 0.31 | 7.9 |       | 50 | 250 |

\*\*\*For information on installation tools, refer to page B3.20.

A.  
System  
Overview

B1.  
Cable  
Ties

B2.  
Cable  
Accessories

B3.  
Stainless  
Steel  
Ties

C1.  
Wiring  
Duct

C2.  
Surface  
Raceway

C3.  
Abrasion  
Protection

C4.  
Cable  
Management

D1.  
Terminals

D2.  
Power  
Connectors

D3.  
Grounding  
Connectors

E1.  
Labeling  
Systems

E2.  
Labels

E3.  
Pre-Printed  
& Write-On  
Markers

E4.  
Permanent  
Identification

E5.  
Lockout/  
Tagout  
& Safety  
Solutions

F.  
Index

A.  
System  
Overview

## MTRT Retained Tension Manual Installation Tools

B1.  
Cable Ties

- Adjustable detent mechanism provides user pre-set controlled tension for repeatable installations and maximum reliability
- Smooth cable tie cut-off eliminates burrs or sharp edges after installation to deliver added bundle protection and job site safety

- Tie tensioning mechanism provides improved durability compared to conventional gripper style tools
- Change over kits available to allow for installation of all tie cross sections with one tool

B2.  
Cable  
Accessories

B3.  
Stainless  
Steel Ties

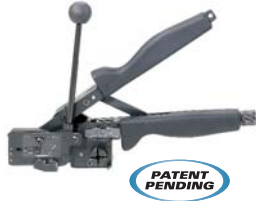

| Part Number    | Part Description   | Std. Pkg. Qty. |
|----------------|--|----------------|
| <b>MTRTH</b>   | Retained tension installation tool for use with Pan-Steel® heavy cross section MRT and MRS style ties and MRT double wrapped style ties.                     | 1              |
| <b>MTRTLS</b>  | Retained tension installation tool for use with Pan-Steel® light-heavy and standard cross section MRT and MRS style ties and MRT double wrapped style ties.  | 1              |
| <b>KMTRTH</b>  | Change over kits allow for installation of heavy cross section MRT and MRS style ties, and MRT double wrapped style ties in MTRTH tools.                     | 1              |
| <b>KMTRTLS</b> | Change over kits allow for installation of light-heavy and standard cross section MRT and MRS style ties, and MRT double wrapped style ties in MTRTLS tools. | 1              |

C1.  
Wiring  
Duct

C2.  
Surface  
Raceway

C3.  
Abrasion  
Protection

C4.  
Cable  
Management

D1.  
Terminals

D2.  
Power  
Connectors

D3.  
Grounding  
Connectors

E1.  
Labeling  
Systems

E2.  
Labels

E3.  
Pre-Printed  
& Write-On  
Markers

E4.  
Permanent  
Identification

E5.  
Lockout/  
Tagout/  
& Safety  
Solutions

F.  
Index

## Features and Benefits – Pan-Steel® Strapping System

The Panduit® Pan-Steel® Stainless Steel Strapping is the ultimate solution for strapping applications. The buckle design and tension controlled installation tool offer a quick and safe installation for all harsh environments. Available in four widths 3/8" (9.5mm), 1/2" (12.7mm), 5/8" (15.9mm) and 3/4" (19.1mm) in base 201 (3/4" width only), 304, or 316 stainless steel with a temperature range of -112°F (-80°C) to 1000°F (538°C).

### Unique Locking Methods Pan-Steel® Stainless Steel Strapping

**\*Hooked Clamping Tab**

Bends strap body within retention area of buckle for increased loop tensile strength and full coverage of cut end of strap

**\*Cross Rib Support**

Enhanced rigidity for higher loop tensile strength

**Buckle Design**

Provides a low finished profile

**\*Concave Cross Section**

Enhanced support to improve tensile strength

**\*Concave Buckle Recess**

Increases body resistance for increased loop tensile strength

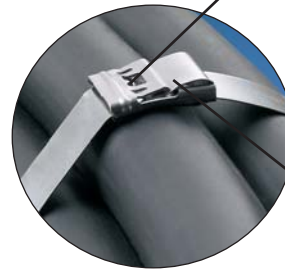
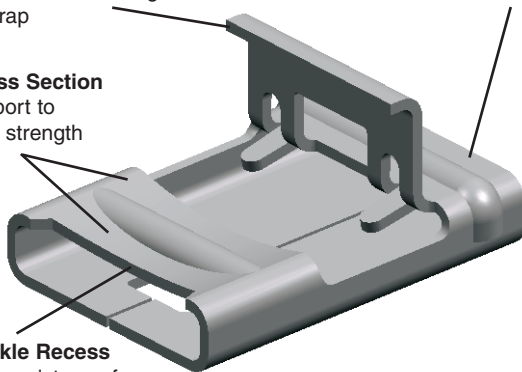

**No Sharp Edges**

After tensioning, cut end is locked inside buckle

### Pan-Steel® Stainless Steel MS75 Strapping

**Hooked Clamping Tab**

Provides full coverage of cut end of strap for enhanced safety

**Buckle Screwdriver Slot**

Allows use of screwdriver for buckle closure for a simple quick installation

**No Sharp Edges**

After tensioning, cut end is locked inside buckle

**Buckle Bridge Teeth**

Deliver additional body slip resistance for optimum strength

**\*\*Buckle Locking Tabs**

Improve locking mechanism for higher strength

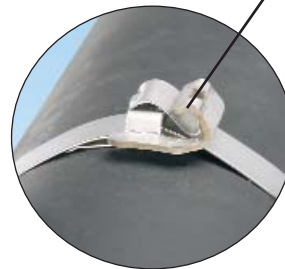
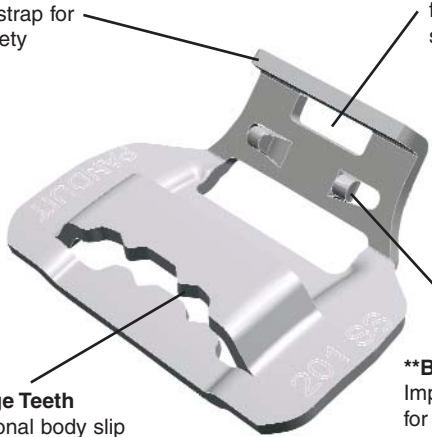

\*Patented  
\*\*Patents Pending



Hand operated installation tools used with Panduit® Pan-Steel® Strapping. Tensions, cuts strapping, and secures the buckle tab. Easy to operate. See page B3.26.



Custom length strapping available for applications that require various bundle diameters, to provide job safety and versatility with minimum inventory. See page B3.25.

A. System Overview

## The Panduit Method Reduces Installation Time

### Pan-Steel® Stainless Steel Strapping

B1. Cable Ties

B2. Cable Accessories

B3. Stainless Steel Ties



1) Place strap around the material, insert tail of strap through buckle. Pull strapping tight and bend up to hold in place. Insert tail of strapping into tool nose section. Squeeze handle to tension.



2) Once proper tension is reached, maintain tension and raise tool 90° – 120° over buckle and pull down on cutter lever, cutting strap.



3) Remove tool, press cut end down and toward retaining tab.

C1. Wiring Duct

C2. Surface Raceway

C3. Abrasion Protection



4) Using the closure lever on the handle of the tool, bend retaining tab down and over cut end.



**Provides finished, safe, and secure closure.**

C4. Cable Management

### Pan-Steel® Stainless Steel MS75 Strapping

D1. Terminals

D2. Power Connectors

D3. Grounding Connectors



1) Place strap around the material, insert tail of strap through buckle. Pull strapping tight and bend up to hold in place.



2) Insert tail of strapping into tool nose section. Rotate handle to tension.

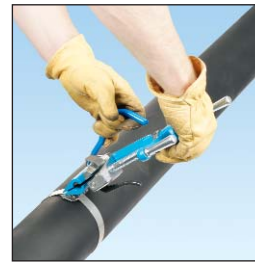

3) After tensioning raise tool 90° – 120° over buckle and pull down on cutter lever, cutting strap.



4) Remove tool, press cut end down toward retaining tab.



5) Using flathead screwdriver, bend retaining tab down and over cut end.



**Provides finished, safe, and secure closure.**

E1. Labeling Systems

E2. Labels

E3. Pre-Printed & Write-On Markers

E4. Permanent Identification

E5. Lockout/Tagout & Safety Solutions

F. Index

### Part Number System for Discrete Length Strapping

| <b>MS</b>                                    | <b>4</b>              | <b>W</b> | <b>38</b>                                    | <b>T</b>  | <b>15</b>                  | <b>L</b>                   | <b>4</b>                               |
|--|-----------------------|----------|--|-----------|----------------------------|----------------------------|--|
| Type   | Bundle Diameter (In.) | Width    | Inches                                       | Thickness | 15 = 0.015"<br>30 = 0.030" | Standard Package Size      | Material                               |
| MS = Metal Strap<br>MSC = Metal Strap Coated |                       |          | 38 = 3/8<br>50 = 1/2<br>63 = 5/8<br>75 = 3/4 |           |                            | L = 50 Pcs.<br>Q = 25 Pcs. | 2 = 201 SS<br>4 = 304 SS<br>6 = 316 SS |

## Pan-Steel® Strapping – MS Series

- Fold over design provides high-retained tension in mechanical fastening and cable bundling applications
- After tensioning, cut end is locked inside low profile buckle – no sharp edges
- Can be used in a wide range of indoor, outdoor, and underground (including direct burial) applications
- Smooth surfaces and rounded edges assures cable protection and worker safety
- Available in AISI 201 (3/4" width only) and 304 stainless steel for general-purpose applications
- Available in AISI 316 stainless steel for the most corrosive environments



| Part Number                     | Max. Bundle Diameter |     | Length* |     | Strap Breaking Strength |       | Min. Bundle Diameter |      | Width |      | Thickness |      | Recommended Installation Tool*** | Std. Pkg. Qty. | Std. Ctn. Qty. |     |
|---------------------------------|----------------------|-----|---------|-----|-------------------------|-------|----------------------|------|-------|------|-----------|------|----------------------------------|----------------|----------------|-----|
|                                 | In.                  | mm  | In.     | mm  | Lbs.                    | N     | In.                  | mm   | In.   | mm   | In.       | mm   |                                  |                |                |     |
| <b>AISI 201 Stainless Steel</b> |                      |     |         |     |                         |       |                      |      |       |      |           |      |                                  |                |                |     |
| MS4W75T30-Q2                    | 4.0                  | 102 | 20.2    | 513 | 2400                    | 10656 | 1.00                 | 25.4 | 0.75  | 19.1 | 0.030     | 0.76 | BT75SDT                          | 25             | 25             |     |
| MS6W75T30-Q2                    | 6.0                  | 152 | 26.5    | 673 | 2400                    | 10656 | 1.00                 | 25.4 | 0.75  | 19.1 | 0.030     | 0.76 |                                  | 25             | 25             |     |
| MS8W75T30-Q2                    | 8.0                  | 203 | 32.7    | 831 | 2400                    | 10656 | 1.00                 | 25.4 | 0.75  | 19.1 | 0.030     | 0.76 |                                  | 25             | 25             |     |
| MS10W75T30-Q2                   | 10.0                 | 254 | 39.0    | 991 | 2400                    | 10656 | 1.00                 | 25.4 | 0.75  | 19.1 | 0.030     | 0.76 |                                  | 25             | 25             |     |
| <b>AISI 304 Stainless Steel</b> |                      |     |         |     |                         |       |                      |      |       |      |           |      |                                  |                |                |     |
| MS2W38T15-L4                    | 2.0                  | 51  | 11.8    | 300 | 502                     | 2229  | 1.00                 | 25.4 | 0.38  | 9.5  | 0.015     | 0.38 | BT2HT                            | 50             | 250            |     |
| MS4W38T15-L4                    | 4.0                  | 102 | 18.0    | 457 | 502                     | 2229  | 1.00                 | 25.4 | 0.38  | 9.5  | 0.015     | 0.38 |                                  | 50             | 250            |     |
| MS6W38T15-L4                    | 6.0                  | 152 | 24.4    | 620 | 502                     | 2229  | 1.00                 | 25.4 | 0.38  | 9.5  | 0.015     | 0.38 |                                  | 50             | 250            |     |
| MS8W38T15-L4                    | 8.0                  | 203 | 30.7    | 780 | 502                     | 2229  | 1.00                 | 25.4 | 0.38  | 9.5  | 0.015     | 0.38 |                                  | 50             | 250            |     |
| MS10W38T15-L4                   | 10.0                 | 254 | 37.0    | 940 | 502                     | 2229  | 1.00                 | 25.4 | 0.38  | 9.5  | 0.015     | 0.38 |                                  | 50             | 250            |     |
| MS4W50T15-L4                    | 4.0                  | 102 | 18.0    | 457 | 671                     | 2979  | 1.00                 | 25.4 | 0.50  | 12.7 | 0.015     | 0.38 |                                  | 50             | 250            |     |
| MS6W50T15-L4                    | 6.0                  | 152 | 24.4    | 620 | 671                     | 2979  | 1.00                 | 25.4 | 0.50  | 12.7 | 0.015     | 0.38 |                                  | 50             | 250            |     |
| MS8W50T15-L4                    | 8.0                  | 203 | 30.7    | 780 | 671                     | 2979  | 1.00                 | 25.4 | 0.50  | 12.7 | 0.015     | 0.38 |                                  | 50             | 250            |     |
| MS10W50T15-L4                   | 10.0                 | 254 | 37.0    | 940 | 671                     | 2979  | 1.00                 | 25.4 | 0.50  | 12.7 | 0.015     | 0.38 |                                  | 50             | 250            |     |
| MS4W63T15-L4                    | 4.0                  | 102 | 18.0    | 457 | 839                     | 3725  | 1.00                 | 25.4 | 0.63  | 15.9 | 0.015     | 0.38 |                                  | 50             | 250            |     |
| MS6W63T15-L4                    | 6.0                  | 152 | 24.4    | 620 | 839                     | 3725  | 1.00                 | 25.4 | 0.63  | 15.9 | 0.015     | 0.38 |                                  | 50             | 250            |     |
| MS8W63T15-L4                    | 8.0                  | 203 | 30.7    | 780 | 839                     | 3725  | 1.00                 | 25.4 | 0.63  | 15.9 | 0.015     | 0.38 |                                  | 50             | 250            |     |
| MS10W63T15-L4                   | 10.0                 | 254 | 37.0    | 940 | 839                     | 3725  | 1.00                 | 25.4 | 0.63  | 15.9 | 0.015     | 0.38 |                                  | 50             | 250            |     |
| <b>AISI 316 Stainless Steel</b> |                      |     |         |     |                         |       |                      |      |       |      |           |      |                                  |                |                |     |
| MS2W38T15-L6                    | 2.0                  | 51  | 11.8    | 300 | 502                     | 2229  | 1.00                 | 25.4 | 0.38  | 9.5  | 0.015     | 0.38 |                                  | BT2HT          | 50             | 250 |
| MS4W38T15-L6                    | 4.0                  | 102 | 18.0    | 457 | 502                     | 2229  | 1.00                 | 25.4 | 0.38  | 9.5  | 0.015     | 0.38 |                                  |                | 50             | 250 |
| MS6W38T15-L6                    | 6.0                  | 152 | 24.4    | 620 | 502                     | 2229  | 1.00                 | 25.4 | 0.38  | 9.5  | 0.015     | 0.38 | 50                               |                | 250            |     |
| MS8W38T15-L6                    | 8.0                  | 203 | 30.7    | 780 | 502                     | 2229  | 1.00                 | 25.4 | 0.38  | 9.5  | 0.015     | 0.38 | 50                               |                | 250            |     |
| MS10W38T15-L6                   | 10.0                 | 254 | 37.0    | 940 | 502                     | 2229  | 1.00                 | 25.4 | 0.38  | 9.5  | 0.015     | 0.38 | 50                               |                | 250            |     |
| MS4W50T15-L6                    | 4.0                  | 102 | 18.0    | 457 | 671                     | 2979  | 1.00                 | 25.4 | 0.50  | 12.7 | 0.015     | 0.38 | 50                               |                | 250            |     |
| MS6W50T15-L6                    | 6.0                  | 152 | 24.4    | 620 | 671                     | 2979  | 1.00                 | 25.4 | 0.50  | 12.7 | 0.015     | 0.38 | 50                               |                | 250            |     |
| MS8W50T15-L6                    | 8.0                  | 203 | 30.7    | 780 | 671                     | 2979  | 1.00                 | 25.4 | 0.50  | 12.7 | 0.015     | 0.38 | 50                               |                | 250            |     |
| MS10W50T15-L6                   | 10.0                 | 254 | 37.0    | 940 | 671                     | 2979  | 1.00                 | 25.4 | 0.50  | 12.7 | 0.015     | 0.38 | 50                               |                | 250            |     |
| MS4W63T15-L6                    | 4.0                  | 102 | 18.0    | 457 | 839                     | 3725  | 1.00                 | 25.4 | 0.63  | 15.9 | 0.015     | 0.38 | 50                               |                | 250            |     |
| MS6W63T15-L6                    | 6.0                  | 152 | 24.4    | 620 | 839                     | 3725  | 1.00                 | 25.4 | 0.63  | 15.9 | 0.015     | 0.38 | 50                               |                | 250            |     |
| MS8W63T15-L6                    | 8.0                  | 203 | 30.7    | 780 | 839                     | 3725  | 1.00                 | 25.4 | 0.63  | 15.9 | 0.015     | 0.38 | 50                               |                | 250            |     |
| MS10W63T15-L6                   | 10.0                 | 254 | 37.0    | 940 | 839                     | 3725  | 1.00                 | 25.4 | 0.63  | 15.9 | 0.015     | 0.38 | 50                               |                | 250            |     |

\*Other lengths available, contact Panduit Customer Service.

\*\*\*For information on installation tool, refer to page B3.26.

A.  
System  
Overview

B1.  
Cable Ties

B2.  
Cable  
Accessories

B3.  
Stainless  
Steel Ties

C1.  
Wiring  
Duct

C2.  
Surface  
Raceway

C3.  
Abrasion  
Protection

C4.  
Cable  
Management

D1.  
Terminals

D2.  
Power  
Connectors

D3.  
Grounding  
Connectors

E1.  
Labeling  
Systems

E2.  
Labels

E3.  
Pre-Printed  
& Write-On  
Markers

E4.  
Permanent  
Identification

E5.  
Lockout/  
Tagout  
& Safety  
Solutions

F.  
Index



A.  
System  
Overview

## Pan-Steel® Nylon 11 Coated Strapping – MSC Series

- Fold over design provides high-retained tension in mechanical fastening and cable bundling applications
- After tensioning, cut end is locked inside low profile buckle – no sharp edges
- AISI 316 stainless steel for the most corrosive environments
- Available in 0.38 inch (9.5mm), 0.50 inch (12.7mm), 0.63 inch (15.9mm) cross sections
- UV resistant, low smoke, halogen-free material
- Temperature tolerance -40°F (-40°C) to 285°F (140°C)

B1.  
Cable Ties

B2.  
Cable  
Accessories

B3.  
Stainless  
Steel Ties



C1.  
Wiring  
Duct

C2.  
Surface  
Raceway

C3.  
Abrasion  
Protection

C4.  
Cable  
Management

D1.  
Terminals

D2.  
Power  
Connectors

D3.  
Grounding  
Connectors

E1.  
Labeling  
Systems

E2.  
Labels

E3.  
Pre-Printed  
& Write-On  
Markers

E4.  
Permanent  
Identification

E5.  
Lockout/  
Tagout  
& Safety  
Solutions

F.  
Index

| Part Number    | Max. Bundle Diameter |     | Length* |     | Strap Breaking Strength |      | Min. Bundle Diameter |      | Width |      | Thickness^ |      | Recommended Installation Tool*** | Std. Pkg. Qty. | Std. Ctn. Qty. |
|----------------|----------------------|-----|---------|-----|-------------------------|------|----------------------|------|-------|------|------------|------|----------------------------------|----------------|----------------|
|                | In.                  | mm  | In.     | mm  | Lbs.                    | N    | In.                  | mm   | In.   | mm   | In.        | mm   |                                  |                |                |
| MSC2W38T15-L6  | 2.0                  | 51  | 11.8    | 300 | 502                     | 2229 | 1.00                 | 25.4 | 0.38  | 9.5  | 0.015      | 0.38 | BT2HT                            | 50             | 250            |
| MSC4W38T15-L6  | 4.0                  | 102 | 18.0    | 457 | 502                     | 2229 | 1.00                 | 25.4 | 0.38  | 9.5  | 0.015      | 0.38 |                                  | 50             | 250            |
| MSC6W38T15-L6  | 6.0                  | 152 | 24.4    | 620 | 502                     | 2229 | 1.00                 | 25.4 | 0.38  | 9.5  | 0.015      | 0.38 |                                  | 50             | 250            |
| MSC8W38T15-L6  | 8.0                  | 203 | 30.7    | 780 | 502                     | 2229 | 1.00                 | 25.4 | 0.38  | 9.5  | 0.015      | 0.38 |                                  | 50             | 250            |
| MSC10W38T15-L6 | 10.0                 | 254 | 37.0    | 940 | 502                     | 2229 | 1.00                 | 25.4 | 0.38  | 9.5  | 0.015      | 0.38 |                                  | 50             | 250            |
| MSC4W50T15-L6  | 4.0                  | 102 | 18.0    | 457 | 671                     | 2979 | 1.00                 | 25.4 | 0.50  | 12.7 | 0.015      | 0.38 |                                  | 50             | 250            |
| MSC6W50T15-L6  | 6.0                  | 152 | 24.4    | 620 | 671                     | 2979 | 1.00                 | 25.4 | 0.50  | 12.7 | 0.015      | 0.38 |                                  | 50             | 250            |
| MSC8W50T15-L6  | 8.0                  | 203 | 30.7    | 780 | 671                     | 2979 | 1.00                 | 25.4 | 0.50  | 12.7 | 0.015      | 0.38 |                                  | 50             | 250            |
| MSC10W50T15-L6 | 10.0                 | 254 | 37.0    | 940 | 671                     | 2979 | 1.00                 | 25.4 | 0.50  | 12.7 | 0.015      | 0.38 |                                  | 50             | 250            |
| MSC4W63T15-L6  | 4.0                  | 102 | 18.0    | 457 | 839                     | 3725 | 1.00                 | 25.4 | 0.63  | 15.9 | 0.015      | 0.38 |                                  | 50             | 250            |
| MSC6W63T15-L6  | 6.0                  | 152 | 24.4    | 620 | 839                     | 3725 | 1.00                 | 25.4 | 0.63  | 15.9 | 0.015      | 0.38 |                                  | 50             | 250            |
| MSC8W63T15-L6  | 8.0                  | 203 | 30.7    | 780 | 839                     | 3725 | 1.00                 | 25.4 | 0.63  | 15.9 | 0.015      | 0.38 |                                  | 50             | 250            |
| MSC10W63T15-L6 | 10.0                 | 254 | 37.0    | 940 | 839                     | 3725 | 1.00                 | 25.4 | 0.63  | 15.9 | 0.015      | 0.38 |                                  | 50             | 250            |

\*Other lengths available, contact Panduit Customer Service.

\*\*\*For information on installation tools, refer to page B3.26.

^Base material less coating.

## Pan-Steel® Custom Length Strapping

- Fold over design provides high retained tension in mechanical fastening and cable bundling applications
- After tensioning, cut end is locked inside low profile buckle – no sharp edges
- For applications that require various bundle diameters
- Supplied in reels of 82.5 feet (25m) (coated) or 100 feet (30.5m) (uncoated)

- Provides job site versatility with minimum inventory
- Packaging speeds removal of steel and includes bundle diameter cut-off guide
- Available in AISI 201 (3/4" width only) and 304 stainless steel for general-purpose applications
- Available in AISI 316 stainless steel for the most corrosive environments



- Nylon 11 coating (optional):**
- Nylon 11 coating provides additional edge protection and prevents corrosion between dissimilar metals
  - UV resistant, low smoke, halogen-free material
  - Temperature tolerance -40°F (-40°C) to 285°F (140°C)
  - AISI 316 stainless steel for the most corrosive environments

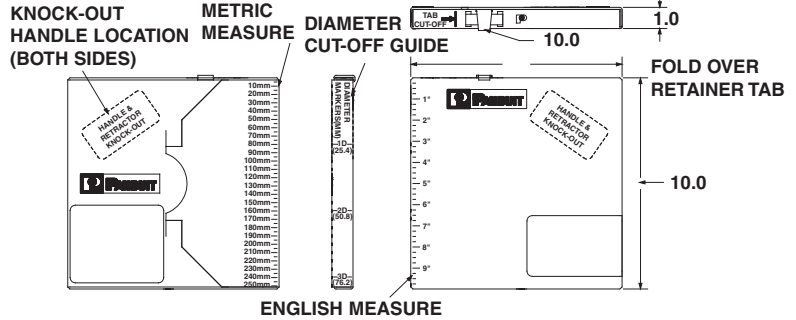

| Part Number                                 | Length* |      | Strap Breaking Strength |       | Width |      | Thickness^ |      | Used with Buckle | Recommended Installation Tool*** | Std. Pkg. Qty.‡ |
|---|---------|------|-------------------------|-------|-------|------|------------|------|------------------|----------------------------------|-----------------|
|   | Ft.     | m    | Lbs.                    | N     | In.   | mm   | In.        | mm   |                  |                                  |                 |
| <b>304 Stainless Steel</b>                  |         |      |                         |       |       |      |            |      |                  |                                  |                 |
| <b>MSW75T30-CR2</b>                         | 100     | 30.5 | 2400                    | 10656 | 0.75  | 19.1 | 0.030      | 0.80 | MSBW75-C2        | BT75SDT                          | 1               |
| <b>304 Stainless Steel</b>                  |         |      |                         |       |       |      |            |      |                  |                                  |                 |
| <b>MSW38T15-CR4</b>                         | 100     | 30.5 | 502                     | 2229  | 0.38  | 9.5  | 0.015      | 0.38 | MSBW38-C4        | BT2HT                            | 1               |
| <b>MSW50T15-CR4</b>                         | 100     | 30.5 | 671                     | 2979  | 0.50  | 12.7 | 0.015      | 0.38 | MSBW50-C4        |                                  | 1               |
| <b>MSW63T15-CR4</b>                         | 100     | 30.5 | 839                     | 3725  | 0.63  | 15.9 | 0.015      | 0.38 | MSBW63-C4        |                                  | 1               |
| <b>316 Stainless Steel</b>                  |         |      |                         |       |       |      |            |      |                  |                                  |                 |
| <b>MSW38T15-CR6</b>                         | 100     | 30.5 | 502                     | 2229  | 0.38  | 9.5  | 0.015      | 0.38 | MSBW38-C6        | BT2HT                            | 1               |
| <b>MSW50T15-CR6</b>                         | 100     | 30.5 | 671                     | 2979  | 0.50  | 12.7 | 0.015      | 0.38 | MSBW50-C6        |                                  | 1               |
| <b>MSW63T15-CR6</b>                         | 100     | 30.5 | 839                     | 3725  | 0.63  | 15.9 | 0.015      | 0.38 | MSBW63-C6        |                                  | 1               |
| <b>Nylon Coated Custom Length Strapping</b> |         |      |                         |       |       |      |            |      |                  |                                  |                 |
| <b>MSCNW38T15-QR6</b>                       | 82.5    | 25.0 | 502                     | 2229  | 0.38  | 9.5  | 0.015      | 0.38 | MSBW38-C6        | BT2HT                            | 1               |
| <b>MSCNW50T15-QR6</b>                       | 82.5    | 25.0 | 671                     | 2979  | 0.50  | 12.7 | 0.015      | 0.38 | MSBW50-C6        |                                  | 1               |
| <b>MSCNW63T15-QR6</b>                       | 82.5    | 25.0 | 839                     | 3725  | 0.63  | 15.9 | 0.015      | 0.38 | MSBW63-C6        |                                  | 1               |

\*Other lengths available, contact Panduit Customer Service. ^Base metal less coating. ‡Order in number of reels required. \*\*\*For information on installation tools, refer to page B3.26.

To determine the proper amount of strapping required, use the following formula:

**Calculate** Diameter inches (mm) x 3.14 + 6 inches (152.4 mm)

## Pan-Steel® Buckles for Custom Length Strapping

- Buckle design provides a low finished profile
- After tensioning cut end is locked inside buckle – no sharp edges



| Part Number                     | Material | Width |      | Part Description  | Std. Pkg. Qty. | Std. Ctn. Qty. |
|---------------------------------|----------|-------|------|---|----------------|----------------|
|                                 |          | In.   | mm   |   |                |                |
| <b>AISI 201 Stainless Steel</b> |          |       |      |   |                |                |
| <b>MSBW75-C2</b>                | 201      | 0.75  | 19.1 | Individual low profile buckles used with metal strapping.         | 100            | —              |
| <b>AISI 304 Stainless Steel</b> |          |       |      |   |                |                |
| <b>MSBW38-C4</b>                | 304      | 0.38  | 9.5  | Individual low profile buckles used with custom length strapping. | 100            | 1000           |
| <b>MSBW50-C4</b>                | 304      | 0.50  | 12.7 |   | 100            | 1000           |
| <b>MSBW63-C4</b>                | 304      | 0.63  | 15.9 |   | 100            | 1000           |
| <b>AISI 316 Stainless Steel</b> |          |       |      |   |                |                |
| <b>MSBW38-C6</b>                | 316      | 0.38  | 9.5  | Individual low profile buckles used with custom length strapping. | 100            | 1000           |
| <b>MSBW50-C6</b>                | 316      | 0.50  | 12.7 |   | 100            | 1000           |
| <b>MSBW63-C6</b>                | 316      | 0.63  | 15.9 |   | 100            | 1000           |



A.  
System  
Overview

## BT2HT Hand Operated Installation Tool for Strapping

B1.  
Cable  
Ties

- Strap side entry
- Multi-position rear handle provides flexibility for a one or two hand installation
- Adjustable tension control
- Easy removal of excess strap
- Installs (3) sizes: 0.38 inch (9.5mm), 0.50 inch (12.7mm), and 0.63 inch (15.9mm)
- Replacement cutter blade and handle available

B2.  
Cable  
Accessories



B3.  
Stainless  
Steel Ties

| Part Number     | Part Description   | Std. Pkg. Qty. |
|-----------------|--|----------------|
| <b>BT2HT</b>    | Installation tool for use with 0.38" (9.5mm), 0.50" (12.7mm), and 0.63" (15.9mm) widths of Panduit® Pan-Steel® Strapping. Tensions, cuts strapping, and secures the buckle tab. Lever cut off. | 1              |
| <b>KRT2BLD</b>  | Replacement cutter blade for RT2HT and BT2HT.  | 1              |
| <b>KRT2HNDL</b> | Replacement cutter handle for RT2HT and BT2HT.   | 1              |

C1.  
Wiring  
Duct

C2.  
Surface  
Raceway

## **NEW!** BT75SDT Hand Operated Installation Tool for MS75 Strapping

C3.  
Abrasion  
Protection

- Screw drive tension mechanism provides high tension with minimal effort, reducing operator fatigue
- Heavy duty construction offers a longer service life
- Strapping side entry allows quick side entry of the strap into tool to speed installation

C4.  
Cable  
Management



D1.  
Terminals

| Part Number    | Part Description   | Std. Pkg. Qty. |
|----------------|--|----------------|
| <b>BT75SDT</b> | Installation tool for use with 0.75" (19.1mm) width strapping only. Tensions and cuts strapping. Screwdriver required for buckle closure (not included). | 1              |

D2.  
Power  
Connectors

D3.  
Grounding  
Connectors

## PCS Cushion Sleeve

E1.  
Labeling  
Systems

- Black neoprene sleeving used with Pan-Steel® Stainless Steel Ties, custom length banding, and MS strap
- Used on applications requiring improved gripping on non-resilient objects
- Can be used indoors or outdoors (excellent ultraviolet resistance, good resistance to petroleum, and many chemicals)
- Isolation between dissimilar metals allows the ties and straps to be used with aluminum cable tray
- Provides full separation between the ties and the bundle
- Operating temperature range -40°F (-40°C) to 200°F (93°C)

E2.  
Labels



E3.  
Pre-Printed  
& Write-On  
Markers

| Part Number        | Used with Pan-Steel® Ties/Strapping | Width |      | Length |      | Std. Pkg. Qty.‡ |
|--------------------|-------------------------------------|-------|------|--------|------|-----------------|
|                    |                                     | In.   | mm   | Ft.    | m    |                 |
| <b>PCSS-B-CR</b>   | MLT/S                               | .33   | 8.4  | 100    | 30.5 | 1               |
| <b>PCSH-B-CR</b>   | MLT/LH/H                            | .47   | 11.9 | 100    | 30.5 | 1               |
| <b>PCSSH-B-CR*</b> | MLT/EH/SH and MS Straps             | .91   | 23.1 | 100    | 30.5 | 1               |

E4.  
Permanent  
Identification



E5.  
Lockout/  
Tagout  
& Safety  
Solutions

F.  
Index

\*Meets MIL-R-6855  
‡Order in number of reels required.  
Pkg. -CR = 100 ft. (30.5m) reel.

## Stainless Steel Tie Mounts

- Low profile
- One hole mounting

- For use with standard, light-heavy, and heavy cross section Pan-Steel® Ties as well as .38 inch (9.5mm) wide strapping
- 304 Stainless Steel

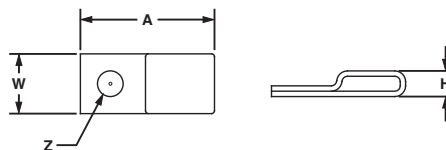

| Part Number      | Used with Pan-Steel® Ties/Strapping      | Mounting Method* | Length A |      | Width W |      | Height H |     | Hole Diameter Z |     | Std. Pkg. Qty. | Std. Ctn. Qty. |
|------------------|--|------------------|----------|------|---------|------|----------|-----|-----------------|-----|----------------|----------------|
|                  |  |                  | In.      | mm   | In.     | mm   | In.      | mm  | In.             | mm  |                |                |
| <b>MTM1H-C</b>   | MLTS/LH/H, MLTC/H, MLTFC/S/LH/H or MSW38 | #8 (4mm) screw   | .90      | 22.6 | .40     | 10.2 | .17      | 4.4 | .17             | 4.4 | 100            | 1000           |
| <b>MTM1H10-C</b> |  | #10 (5mm) screw  | .90      | 22.6 | .40     | 10.2 | .17      | 4.4 | .21             | 5.4 | 100            | 1000           |
| <b>MTM1H25-C</b> |  | 1/4" (6mm) screw | .90      | 22.6 | .40     | 10.2 | .17      | 4.4 | .28             | 7.1 | 100            | 1000           |

\*Stainless steel screws are recommended for fastening to avoid corrosion problems associated with dissimilar metals.

## Stainless Steel Push Mount

- No tapping required
- Used where only one side of the panel is accessible
- Nothing to assemble

- For use with standard, light-heavy, and heavy cross section Pan-Steel® Ties
- 304 Stainless Steel

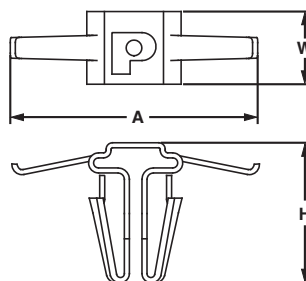

| Part Number       | Used with Pan-Steel® Ties/Strapping | Mounting Method                            | Length A |      | Width W |     | Height H |      | Panel Thickness |          | Std. Pkg. Qty. | Std. Ctn. Qty. |
|-------------------|-------------------------------------|--|----------|------|---------|-----|----------|------|-----------------|----------|----------------|----------------|
|                   |                                     |  | In.      | mm   | In.     | mm  | In.      | mm   | In.             | mm       |                |                |
| <b>MPWM-H56-Q</b> | MLTS/LH/H, MLTC/H or MLTFC/S/LH/H   | Inserted into pre-drilled hole 5/16" (8mm) | .84      | 21.3 | .29     | 7.3 | .56      | 14.2 | .03 – .09       | .8 – 2.4 | 25             | 250            |

A. System Overview

B1. Cable Ties

B2. Cable Accessories

B3. Stainless Steel Ties

C1. Wiring Duct

C2. Surface Raceway

C3. Abrasion Protection

C4. Cable Management

D1. Terminals

D2. Power Connectors

D3. Grounding Connectors

E1. Labeling Systems

E2. Labels

E3. Pre-Printed & Write-On Markers

E4. Permanent Identification

E5. Lockout/Tagout & Safety Solutions

F. Index

A. System Overview

## Stainless Steel Push Button Mount

B1. Cable Ties

- Low profile
- No tapping required
- Designed for use only where both sides of the panel are accessible

- For use with standard cross section Pan-Steel® Ties
- 304 Stainless Steel

B2. Cable Accessories

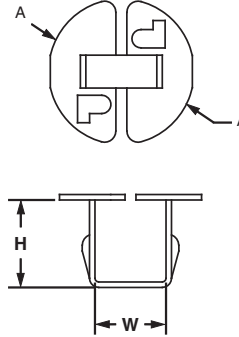
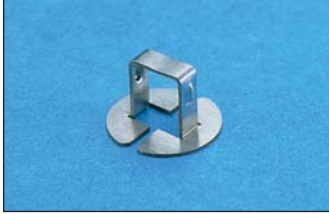

B3. Stainless Steel Ties

C1. Wiring Duct

C2. Surface Raceway

C3. Abrasion Protection

| Part Number      | Used with Pan-Steel® Ties/Strapping | Mounting Method                             | Diameter A |      | Width W |     | Height H |     | Panel Thickness |          | Std. Pkg. Qty. | Std. Ctn. Qty. |
|------------------|-------------------------------------|---|------------|------|---------|-----|----------|-----|-----------------|----------|----------------|----------------|
|                  |                                     |   | In.        | mm   | In.     | mm  | In.      | mm  | In.             | mm       |                |                |
| <b>MBM-H25-Q</b> | MLT/S or MLTFC/S                    | Inserted into pre-drilled hole .25" (6.4mm) | .40        | 10.0 | .20     | 5.0 | .26      | 6.5 | .03 – .12       | .8 – 3.0 | 25             | 250            |

C4. Cable Management

D1. Terminals

## Stainless Steel 2-Way Tie Mount

D2. Power Connectors

- Allows stainless steel cable ties to be inserted from either of two sides
- Low profile
- Single hole center mounting for maximum holding and stability
- Maximum screw head height .09 inches (2.3mm)

- For use with standard, light-heavy, and heavy cross section Pan-Steel® Ties
- 304 Stainless Steel

D3. Grounding Connectors

E1. Labeling Systems

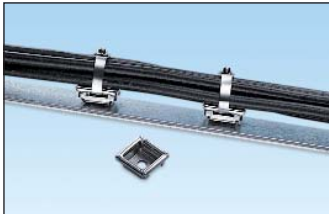

E2. Labels

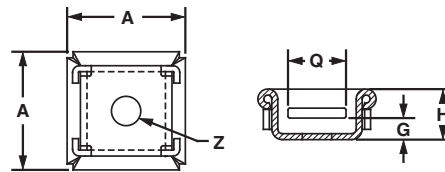

E3. Pre-Printed & Write-On Markers

| Part Number    | Used with Pan-Steel® Ties/Strapping | Mounting Method* | Length A |      | Height H |     | Screw Head Height G |     | Slot Width Q |     | Hole Diameter Z |     | Std. Pkg. Qty. | Std. Ctn. Qty. |
|----------------|-------------------------------------|------------------|----------|------|----------|-----|---------------------|-----|--------------|-----|-----------------|-----|----------------|----------------|
|                |                                     |                  | In.      | mm   | In.      | mm  | In.                 | mm  | In.          | mm  | In.             | mm  |                |                |
| <b>MTM2H-Q</b> | MLTS/LH/H, MLTC/H or MLTFC/S/LH/H   | #8 (4mm) screw   | .71      | 18.0 | .30      | 8.0 | .09                 | 2.3 | .35          | 9.0 | .17             | 4.5 | 25             | 250            |

E4. Permanent Identification

E5. Lockout/Tagout & Safety Solutions

\*Stainless steel screws are recommended for fastening to avoid corrosion problems associated with dissimilar metals.

F. Index

## Stainless Steel Bulkhead Mount

- Zero profile
- Mounts directly to surface
- Used where only one side of the panel is accessible

- Permanent, secure application
- Used with standard, light-heavy, and heavy cross section Pan-Steel® Ties
- 304 Stainless Steel

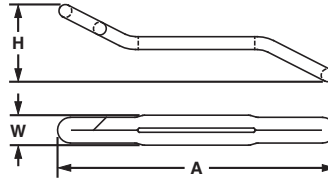

| Part Number | Used with Pan-Steel® Ties/Strapping            | Mounting Method   | Length A |      | Width W |     | Height H |      | Max. Panel Thickness |      | Std. Pkg. Qty. | Std. Ctn. Qty. |
|-------------|--|---|----------|------|---------|-----|----------|------|----------------------|------|----------------|----------------|
|             |  |   | In.      | mm   | In.     | mm  | In.      | mm   | In.                  | mm   |                |                |
| MTMBH-Q     | MLTS/LH/H/EH/SH, MLTC/H, or MLTFC/S/LH/H/EH/SH | Pre-drill hole size standard and light-heavy cross section MLT-S/LH .38" (9.5mm) – .50" (12.7mm).<br>Heavy cross section MLT-H .50" (12.7mm) – .63" (15.9mm). | 1.92     | 48.5 | .21     | 5.3 | .54      | 13.7 | .50                  | 12.7 | 25             | 250            |

### To Install Bulkhead Mount:

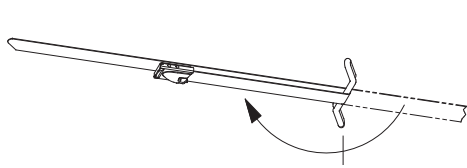

- 1) Insert cable tie through mount slot and fold cable tie.

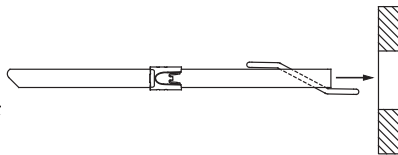

- 2) Insert cable tie and mount through panel/framework hole.

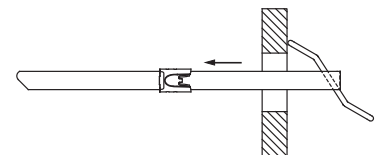

- 3) Pull cable tie back to secure the mount in the panel/framework.

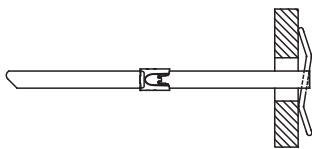

- 4) Mount shown in correct position for installation.

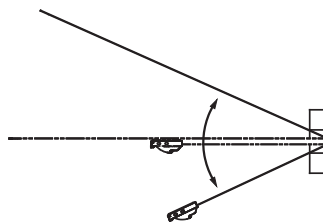

- 5) Separate cable tie to allow for bundling of cables/wires, etc.

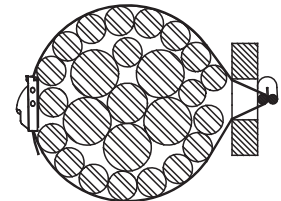

- 6) Install cable tie around bundle and fasten.



A.  
System  
Overview

## Stainless Steel Technical Information

### Physical Characteristics of Stainless Steel and Aluminum

B1.  
Cable Ties

B2.  
Cable  
Accessories

B3.  
Stainless  
Steel Ties

|                                      | Pan-Steel® Stainless Steel MS Strapping and Buckles | Pan-Steel® Stainless Steel Marker Plates, Tags, and Cable Ties | Pan-Alum™ Aluminum Marker Plates and Cable Ties |
|--------------------------------------|---|--|---|
| <b>Material:</b>                     | 201 Grade Stainless Steel                           | 304 and 316 Grade Stainless Steel                              | Aluminum – Natural and Anodized                 |
| <b>Maximum temperature rating:</b>   | 538°C   | 538°C  | 100°C   |
| <b>Minimum temperature rating:</b>   | -80°C   | -80°C  | -80°C   |
| <b>RoHS:</b>                         | Compliant   | Compliant  | Compliant                                       |
| <b>Flammability:</b>                 | Non-Flammable                                       | Non-Flammable  | Non-Flammable                                   |
| <b>Ultraviolet light resistance:</b> | Excellent   | Excellent  | Good  |



C1.  
Wiring  
Duct

## Panduit Stainless Steel Cable Tie and Strapping Approvals

C2.  
Surface  
Raceway

C3.  
Abrasion  
Protection

C4.  
Cable  
Management

D1.  
Terminals

D2.  
Power  
Connectors

D3.  
Grounding  
Connectors

E1.  
Labeling  
Systems

E2.  
Labels

E3.  
Pre-Printed  
& Write-On  
Markers

E4.  
Permanent  
Identification

E5.  
Lockout/  
Tagout  
& Safety  
Solutions

F.  
Index

| Logo (Symbol) | Agency                          | Spec /Approval   | Requirement  | Applicable Products  |
|---------------|---------------------------------|--|--|--|
|               | Underwriters Laboratories, Inc. | Listing E56854   | Dimensional, tensile, temp., cycling, humidity   | MLT-S, MLT-LH, MLT-H, MLTEH15, MLTSH, MLTDEH and MLTDSH in 304, and 316. MSW38T15, MSW50T15, MSW63T15, MSBW38, MSBW50, MSBW63 in both 304 and 316 material. MSCW38T15, MSCW50T15, MSCW63T15, MSCN38T15, MLTFC3, SH, MLTCH, MSCNW50T15, and MSW63T15 in 316 material. |
|               | Conformite European             | Low Voltage Directive 73/23/EEC (amended 93/68/EEC) MLT cable ties and MS straps also meet the requirements from EN50146 | CE Marking is required for products sold within the European Union. CE Marking Directives specify the minimum performance of these products. Applying the CE mark signifies compliance with essential requirements of specific directives. | All MLT, MRT, MRS ties and MS straps.  |
|               | Amer. Bureau of Shipping        | Cert. #03-HS373867-PDA, 04-HS476898-PDA, 05-HS118592C/1-PDA, 06-HS152579-PDA, 05-HS118592A/2-PDA                         | Mechanical   | All MLT ties and MS straps.  |
|               | Bureau Veritas                  | Cert. #04048/D2 BV   | Material specification, dimensional, visual  | All uncoated MLT ties in 304 and 316 material.   |
|               | Det Norske Veritas              | Cert. # E-6540 E-6539  | Salt mist test, tensile test, accelerated aging, vibration tests   | All uncoated MLTS, MLTH, MLTE15, MLTDEH15, MLTSH, and MS strap coated and uncoated 316 material.   |
|               | Germanischer Lloyd              | Cert. # 32666-83HH 51796-89HH  | Mechanical   | All uncoated stainless steel MLT ties and all MS straps.   |
|               | Lloyd's Register of Shipping    | Cert. # 89/60123   | Material specification, tensile test, vibration tests  | All uncoated stainless steel MLT ties and all MS straps.   |
|               | RINA                            | Cert. # ELE71502CS   | Material specification   | All uncoated stainless steel MLT ties and all MS straps.   |
|               | SAE Int'l formerly US MIL       | AS23190 formerly MS23109E  | Dimensional, visual, vibration, temp. cycling, immersion   | MLT-S and MLT-H ties in 304 and 306 material.  |
|               | US Coast Guard                  | File No.16703/46   | Mechanical   | MLT-H series cable ties.   |
|               | US Military                     | MIL-T-81306A/ MS90387-3  | Mechanical   | GS4MT installation tools.  |

## Chemical Resistance at 70°F (21°C) Temperature

| Chemical              | %       | 304 and 316 Stainless Steel* | Chemical            | %       | 304 and 316 Stainless Steel* | Chemical               | %       | 304 and 316 Stainless Steel* | Chemical           | %       | 304 and 316 Stainless Steel* |
|-----------------------|---------|------------------------------|---------------------|---------|------------------------------|------------------------|---------|------------------------------|--------------------|---------|------------------------------|
| Arsenic Acid          | 40      | E                            | Cider               |         | E                            | Methyl Alcohol         | 100     | E                            | Sodium Bisulfate   | 10      | E                            |
| Acetone               | 100     | E                            | Dichloroethane      | 100     | E                            | Methyl Chloride        | 100     | E                            | Sodium Borate      | All     | E                            |
| Aluminum Hydroxide    | AQ C.S. | E                            | Diethyl Ether       | 100     | E                            | Methyl Ethyl Ketone    | 100     | E                            | Sodium Carbonate   | 5       | E                            |
| Ammonium Carbonate    | 5       | E                            | Ethyl Alcohol       | 100     | E                            | Naphtha                | 100     | E                            | Sodium Chlorate    | 25      | E                            |
| Ammonium Hydroxide    | 10      | E                            | Ethyl Chloride      | 100     | E                            | Nitric Acid            | 30 – 70 | E                            | Sodium Chloride    | 2       | E                            |
| Ammonium Nitrate      |         | E                            | Ethyl Glycol        | 100     | E                            | Nitrous Acid           | 5       | E                            | Sodium Fluoride    | 5       | F                            |
| Ammonium Sulfate      | 10      | S                            | Ferric Hydroxide    | All     | E                            | Oleic Acid             | 100     | E                            | Sodium Hydroxide   | 10      | E                            |
| Barium Carbonate      | All     | E                            | Ferric Nitrate      | 10      | E                            | Oxalic Acid            | 10      | E                            | Sodium Hyposulfite | AQ C.S. | E                            |
| Barium Chloride       | 5       | E                            | Ferrous Sulfate     | 10      | E                            | Paraffin               | 100     | E                            | Sodium Nitrate     | 5       | E                            |
| Barium Sulfate        | 10      | E                            | Fuel Oil            | 100     | E                            | Petroleum Ether        | 100     | E                            | Sodium Nitrite     | AQ C.S. | E                            |
| Barium Sulfide        | 10      | E                            | Furfural            | 100     | E                            | Phenol                 | 90      | E                            | Sodium Percolate   | 10      | E                            |
| Benzene               | 100     | E                            | Gallic Acid         | AQ C.S. | E                            | Phosphoric Acid        | 10      | E                            | Sodium Phosphate   | 5       | E                            |
| Benzoic Acid          | 100     | E                            | Gasoline            | 100     | E                            | Picric Acid            | 1       | S                            | Sodium Sulfate     | 5       | E                            |
| Butyric Acid          | 50      | E                            | Glycerine           | 100     | E                            | Potassium Bromide      | AQ C.S. | S                            | Sodium Thiosulfate | 5       | S                            |
| Calcium Carbonate     | AQ C.S. | E                            | Hydrocyanic Acid    | All     | E                            | Potassium Carbonate 1% | —       | E                            | Stearic Acid       | 100     | E                            |
| Calcium Chlorate      | 10      | E                            | Hydrogen Peroxide   | 30      | E                            | Potassium Chlorate     | AQ C.S. | E                            | Sulfur             | 100     | E                            |
| Calcium Hydroxide     | 20      | E                            | Hydrogen Sulfide    | Dry     | E                            | Potassium Dichromate   | 40      | E                            | Sulfur Dioxide     | All     | E                            |
| Calcium Hydrochlorite | 2       | F                            | Iodoform            | 100     | E                            | Potassium Ferrocyanide | 25      | E                            | Sulfuric Acid      | 100     | E                            |
| Calcium Sulfate       | 2       | E                            | Isopropyl Alcohol   | 100     | E                            | Potassium hydroxide    | 5       | E                            | Sulfuric Acid      | 5       | F                            |
| Carbon Tetrachloride  | —       | —                            | Jet Fuel            | 100     | E                            | Potassium Iodide       | All     | E                            | Tannic Acid        | 10      | E                            |
| Chlorine (Wet)        | —       | F                            | Lactic Acid         | 100     | E                            | Potassium Nitrate      | 50      | E                            | Tartaric Acid      | 50      | E                            |
| Chlorine (Dry)        | —       | F                            | Lanolin             | 10      | E                            | Potassium Permanganate | 5       | E                            | Tetrahydrofuran    | 100     | E                            |
| Chloroacetic Acid     | 30      | F                            | Lead Acetate        | 5       | E                            | Potassium Sulfate      | 5       | E                            | Toluene            | 100     | F                            |
| Chloroform            | 100     | E                            | Magnesium Carbonate | All     | E                            | Potassium Sulfide      | AQ C.S. | E                            | Xylene             | 100     | E                            |
| Chromic Acid          | 5       | E                            | Magnesium Chloride  | 10      | F                            | Propyl Alcohol         | 100     | E                            | Zinc Chloride      | 70      | E                            |
| Citric Acid           | 50      | E                            | Magnesium Nitrate   | All     | E                            | Silver Nitrate         | 10      | E                            | Zinc Nitrate       | AQ C.S. | E                            |
| Copper Cyanide        | 10      | E                            | Malic Acid          | AQ C.S. | E                            | Sodium Acetate         | 60      | E                            | Zinc Sulfate       | AQ C.S. | E                            |
| Copper Nitrate        | 50      | E                            | Mercury             | 100     | E                            | Sodium Bicarbonate     | All     | E                            |                    |         |                              |

\* E = Excellent, S = Satisfactory, F = Fair, AQ C.S. = Aqueous Cold Saturated, All = All % Concentrations.

A. System Overview

B1. Cable Ties

B2. Cable Accessories

B3. Stainless Steel Ties

C1. Wiring Duct

C2. Surface Raceway

C3. Abrasion Protection

C4. Cable Management

D1. Terminals

D2. Power Connectors

D3. Grounding Connectors

E1. Labeling Systems

E2. Labels

E3. Pre-Printed & Write-On Markers

E4. Permanent Identification

E5. Lockout/Tagout & Safety Solutions

F. Index

A.  
System  
Overview

## Rigorous Tests and Physical Properties of Stainless Steel

B1.  
Cable Ties

**STRENGTH:** Panduit® Pan-Steel® Stainless Steel Ties and Straps are tested per the SAE Standard AS23190 formerly U.S. Military Specification MIL-S-23190, minimum loop tensile test. This test consists of applying a tie to a split mandrel and then measuring the force required to separate the (two) halves until the tie fails. These minimum loop tensile strengths are given for the various products on pages B3.5 through B3.25.

B2.  
Cable  
Accessories

**TEMPERATURE EXTREMES:** Panduit® Pan-Steel® Stainless Steel Ties and Straps are 100% stainless steel in the alloy provided (locking head, locking ball, and body all provided from the same grade of material ordered).

Various temperature tests have been successfully completed. One such test is the U.S. Military Temperature Cycling Test per Thermal Shock Method 107, Test Condition B of MIL-STD-202. This test exposes the parts from low temperature -85°F (-65°C) to high temperature 275°F (135°C) to low temperature -85°F (-65°C). After exposure, the parts must be free of cracks, distortions, breaks, release of locking device; and meet the minimum loop tensile requirements.



B3.  
Stainless  
Steel Ties

**SHOCK AND VIBRATION:** Panduit® Pan-Steel® Standard and Heavy Cross Section ties have passed the U.S. Military random vibration Test Method 214. Test Condition II, Letter J of MIL-STD-202. This test consists of applying parts to a bundle and then vibrating them with random vibration for 8 hours in each of two mutually perpendicular directions. The parts are then subjected to further temperature testing and finally have to pass the minimum loop tensile strength test.

Panduit® Pan-Steel® Extra Heavy, Super Heavy, MSW50 Strapping and MSW63 Strapping have passed the U.S. Military Shock and Vibration Testing per MIL-STD-167 and MIL-S-901D. The ties were subjected to vibrations in all three planes from 4 – 50 Hz and Shock testing in all three planes utilizing a hammer shock machine.

**SALT SPRAY:** Panduit® Pan-Steel® Stainless Steel Ties and Straps have been subjected to salt spray tests without signs of corrosion or reduction in performance.

**OUTDOOR EXPOSURE:** Panduit® Pan-Steel® Stainless Steel Ties and Straps have been exposed outdoors at New Lenox, Illinois USA since 1985. At the printing of this catalog, there has been no sign of corrosion or loss of performance.

**FLUID IMMERSION:** Panduit® Pan-Steel® Stainless Steel Ties were immersed in: 1-Hydraulic Fluid, 2-Turbine Fuel, 3-Lubricating Oil, and 4-Isopropyl Alcohol for four hours at temperatures of 122°F (50°C). Per SAE Standard AS23190, the parts were then subjected to and passed the minimum loop tensile test.

**RADIATION:** Installed cable ties of various materials have been exposed to different amounts of radiation to determine the maximum acceptable limit. These tests were conducted by Panduit to determine the acceptability for use in various areas of nuclear power plants (accumulated over 40 year life). Radiation resistance is 2x10<sup>8</sup> rads.

C1.  
Wiring  
Duct

C2.  
Surface  
Raceway

C3.  
Abrasion  
Protection

C4.  
Cable  
Management

D1.  
Terminals

D2.  
Power  
Connectors

D3.  
Grounding  
Connectors

E1.  
Labeling  
Systems

E2.  
Labels

E3.  
Pre-Printed  
& Write-On  
Markers

E4.  
Permanent  
Identification

E5.  
Lockout/  
Tagout  
& Safety  
Solutions

F.  
Index

### Military Cross Reference (AS23190)

| Military Standard Part Number | Panduit Part Number |
|-------------------------------|---------------------|
| AS23190/3-1                   | MLT2S-CP            |
| AS23190/3-1                   | MLT2S-CP316         |
| AS23190/3-2                   | MLT4S-CP            |
| AS23190/3-2                   | MLT4S-CP316         |
| AS23190/3-3                   | MLT6S-CP            |
| AS23190/3-3                   | MLT6S-CP316         |
| AS23190/3-4                   | MLT8S-CP            |
| AS23190/3-4                   | MLT8S-CP316         |
| AS23190/3-5                   | MLT2H-LP            |
| AS23190/3-5                   | MLT2H-LP316         |
| AS23190/3-6                   | MLT4H-LP            |
| AS23190/3-6                   | MLT4H-LP316         |
| AS23190/3-7                   | MLT6H-LP            |
| AS23190/3-7                   | MLT6H-LP316         |
| AS23190/3-8                   | MLT8H-LP            |
| AS23190/3-8                   | MLT8H-LP316         |
| AS23190/3-9                   | MLT10H-LP           |
| AS23190/3-9                   | MLT10H-LP316        |

## WIRING DUCT

From the smallest wall mounted panels to the largest integrated turnkey systems Panduit® Panduct® Wiring Duct is the premium wire management solution for routing and concealing wiring in electrical control panels. Panduct® Wiring Duct provide solutions for the original equipment manufacturing, transportation, contract manufacturing, maintenance and repair and communications markets. All Panduct® Wiring Duct are UL Recognized and CSA Certified and most carry the CE mark.

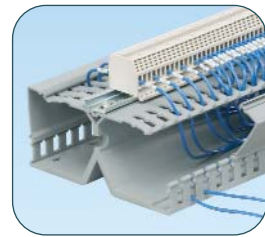
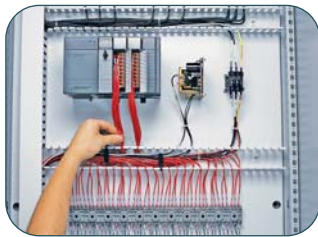
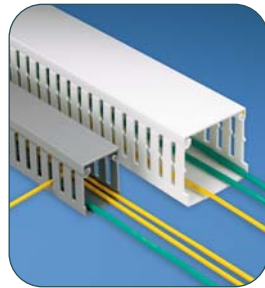
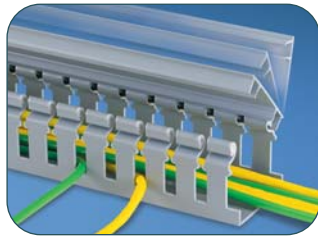

Some of the features and benefits found in Panduct® Wiring Duct include:

- Smooth corners and edges that will not abrade wiring or irritate hands
- Integrated nonskid liners and unique cover designs insure the duct cover will not slide once installed or during vibration
- Specially formulated lead-free PVC material meets the NFPA79: 2007 flame retardancy requirements and carries a UL 94V-0 flammability rating
- Scorelines for easy removal of duct fingers and sidewalls
- Accessories and tools that increase productivity and lower the installed cost

Panduit continues to develop new Panduct® Wiring Duct solutions to satisfy the challenges facing our customers worldwide. Maximize the utilization of enclosure space with PanelMax™ Corner Wiring Duct, DIN Rail Wiring Duct, and Noise Shield. PanelMax™ Corner Wiring Duct fits into unused space in the corner of enclosures providing up to 20% enclosure space savings\*. Integrate component mounting with wire management with PanelMax™ DIN Rail Wiring Duct for up to 30% enclosure space savings. PanelMax™ Noise Shield provides noise mitigation between noisy and sensitive cabling and can reduce air space requirements within the enclosure.

\*Versus panel layouts using conventional wiring duct.

A. System Overview

B1. Cable Ties

B2. Cable Accessories

B3. Stainless Steel Ties

C1. Wiring Duct

C2. Surface Raceway

C3. Abrasion Protection

C4. Cable Management

D1. Terminals

D2. Power Connectors

D3. Grounding Connectors

E1. Labeling Systems

E2. Labels

E3. Pre-Printed & Write-On Markers

E4. Permanent Identification

E5. Lockout/Tagout & Safety Solutions

F. Index



A. System Overview

B1. Cable Ties

B2. Cable Accessories

B3. Stainless Steel Ties

C1. Wiring Duct

C2. Surface Raceway

C3. Abrasion Protection

C4. Cable Management

D1. Terminals

D2. Power Connectors

D3. Grounding Connectors

E1. Labeling Systems

E2. Labels

E3. Pre-Printed & Write-On Markers

E4. Permanent Identification

E5. Lockout/Tagout & Safety Solutions

F. Index

## Wiring Duct for Control Panel Applications

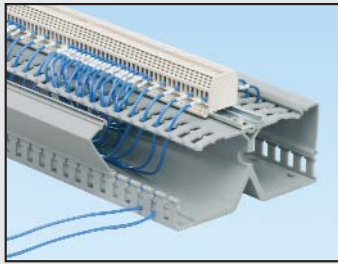

### PanelMax™ DIN Rail Wiring Duct

1

Up to 30% space savings vs. conventional duct/rail layouts.

(pages C1.4 – C1.5)

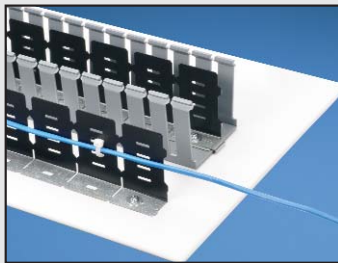

### PanelMax™ Noise Shield

2

Installed separately or within wiring duct.

(pages C1.6 – C1.7)



### PanelMax™ Corner Wiring Duct

3

Up to 20% space savings in layouts with side and back panels

(pages C1.8 – C1.9)

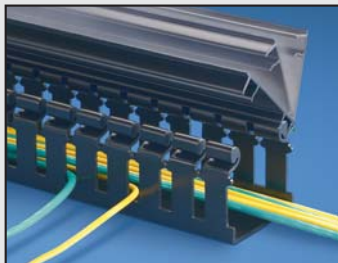

### Hinged Cover Wiring Duct and Raceway

4

Wide slot, narrow slot wiring duct and solid wall raceway with hinging cover.

(pages C1.10 – C1.11)

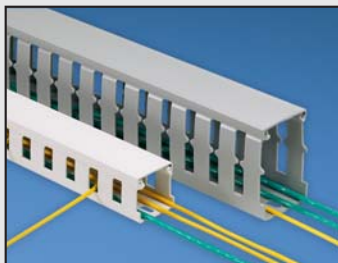

### Halogen Free Wiring Duct

Up to 203°F (95°C) operating temperature.

(pages C1.22 – C1.24)

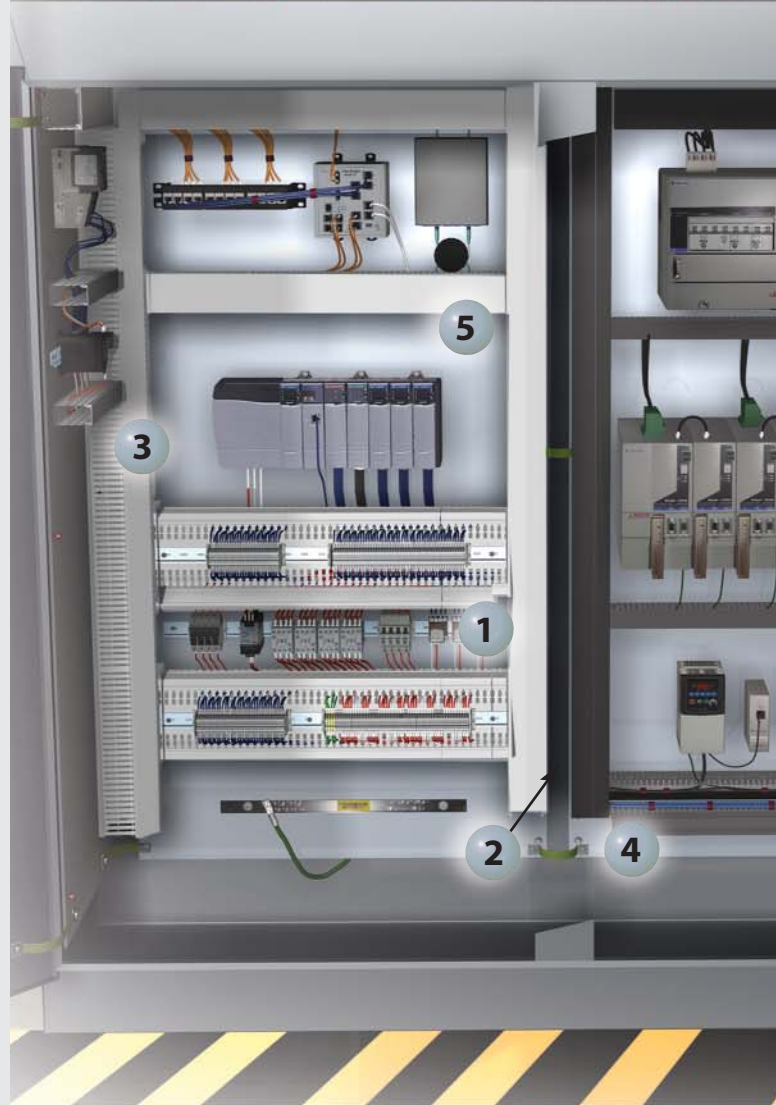
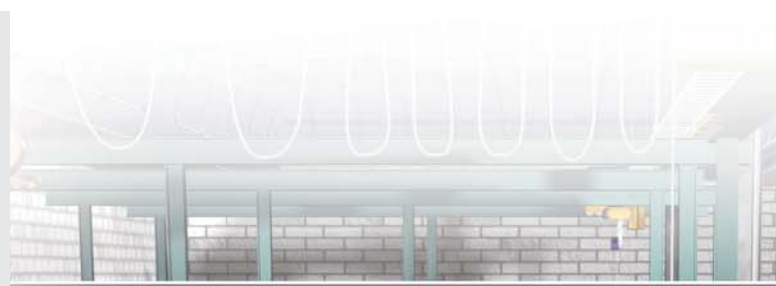



**Tools and Accessories**  
(pages C1.25 – C1.34)

**5** **Type F Narrow Slot Wiring Duct**  
Narrow slot, narrow finger design fits the spacing of high-density terminal blocks.

(pages C1.14 – C1.15)

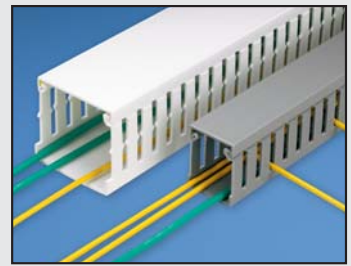

**Type G Wide Slot Wiring Duct**  
Wide slot, wide finger design.

(pages C1.12 – C1.13)

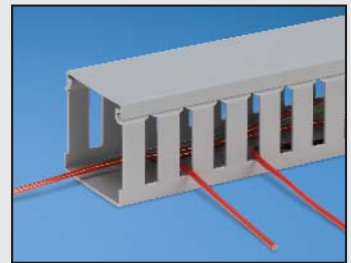

**Type D Round Hole Wiring Duct**  
Multiple rows of holes to retain and support wire of variable heights and positions.

(pages C1.16 – C1.17)

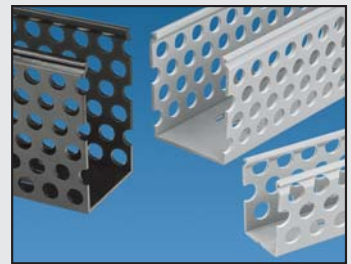

**Type MC Metric Wiring Duct**  
Narrow slot, narrow finger design with DIN 43 659 mounting holes.

(pages C1.18 – C1.19)

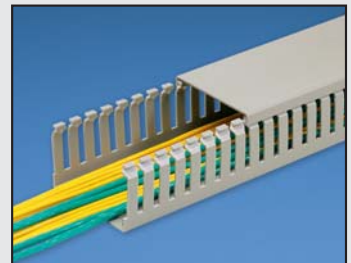

**6** **Type FL Flexible Wiring Duct**  
Solution for door mounted push-button wiring or tight spaces without cover access.

(page C1.26)



A.  
System  
Overview

B1.  
Cable Ties

B2.  
Cable  
Accessories

B3.  
Stainless  
Steel Ties

C1.  
Wiring  
Duct

C2.  
Surface  
Raceway

C3.  
Abrasion  
Protection

C4.  
Cable  
Management

D1.  
Terminals

D2.  
Power  
Connectors

D3.  
Grounding  
Connectors

E1.  
Labeling  
Systems

E2.  
Labels

E3.  
Pre-Printed  
& Write-On  
Markers

E4.  
Permanent  
Identification

E5.  
Lockout/  
Tagout  
& Safety  
Solutions

F.  
Index



A. System Overview

## Features and Benefits – Panduit® PanelMax™ DIN Rail Wiring Duct

B1. Cable Ties

B2. Cable Accessories

B3. Stainless Steel Ties

C1. Wiring Duct

C2. Surface Raceway

C3. Abrasion Protection

C4. Cable Management

**DIN rail and DIN component compatible**

**Unique finger/slot**  
progression for aesthetics and maximum slot capacity

**Hinged and flexible cover**  
acts as ledge for wire installation and flexes for easy opening and increased channel access for maintenance

**Integrated fastener slot**  
accepts supplied screw fasteners to install DIN rail (user supplied rail)

**Locating ribs**  
align and center DIN rail during installation

**Pass-through holes**  
shorten the wiring path between components on the same DIN rail

**Score lines** allow finger removal and base sidewall removal with sidewall notching tool

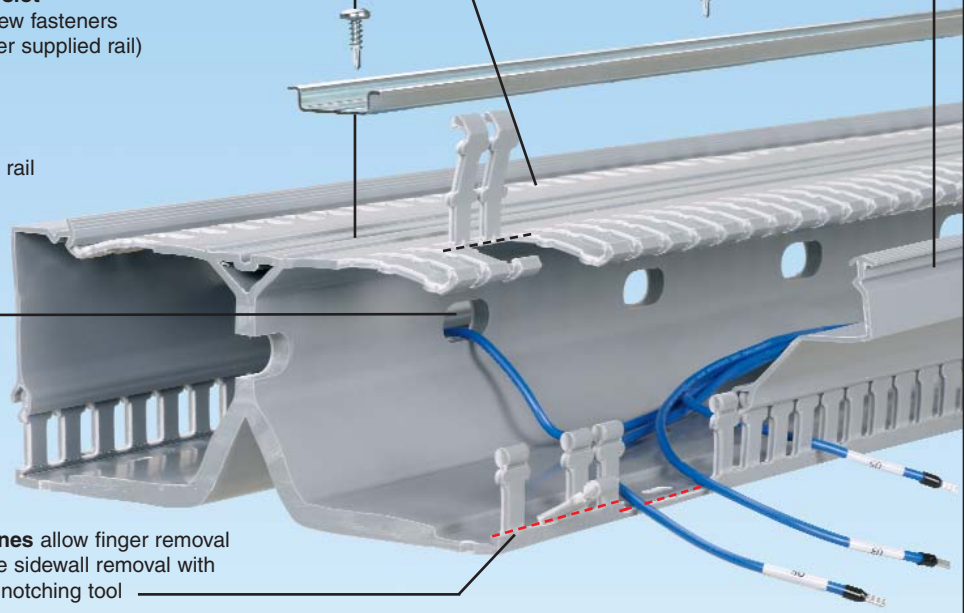

D1. Terminals

### Conventional Wiring Duct Panel Layout:

D2. Power Connectors

D3. Grounding Connectors

E1. Labeling Systems

E2. Labels

E3. Pre-Printed & Write-On Markers

E4. Permanent Identification

E5. Lockout/Tagout & Safety Solutions

F. Index

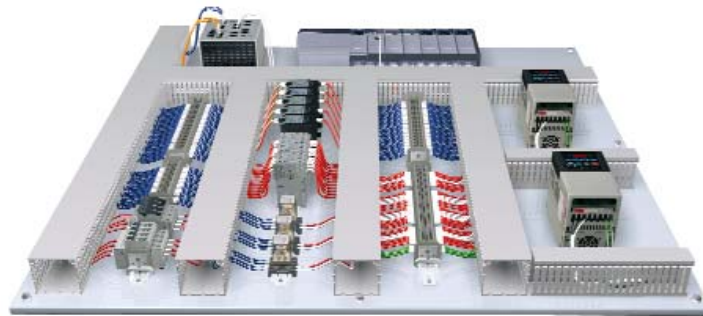

### DIN Rail Wiring Duct Panel Layout with 30% Space Savings:



Panduit® PanelMax™ DIN Rail Wiring Duct positions DIN rail and components off the panel directly above an integrated wire management channel for a 30%+ smaller footprint to the panel layout.

## c Panduct® PanelMax™ DIN Rail Wiring Duct



- Space saving design positions DIN rail and components off the panel directly above an integrated wire management channel for up to a 30% smaller footprint for duct and components; increased design flexibility and component access for easier installation and maintenance
- DIN rail and DIN component compatible with standard 35mm or 15mm rails and many DIN rail mount components for design flexibility
- Integrated DIN rail fastening slot allows the DIN rail to mount directly to product with plastic thread cutting screws for up to 40% faster duct and rail installation and reduced labor costs
- Hinged cover remains attached during maintenance and upgrades preventing lost covers, ensuring panel integrity, safety and aesthetics; L-shaped cover acts as ledge to aid wire installation for ease of use
- Slotted platform (horizontal) manage the wire from channel mounted components, outer sidewall slots (vertical) manage wire from adjacent panel mounted components; unique finger and slot progression for optimal wire management and aesthetics
- Channel pass through slots allows wires to transition internally between channels to ease wire connections to either side of components mounted on the same rail minimizing wire length and reducing material cost
- Optional wire retainer accessory retains cabling with cover opened or removed easing wire installation and future wire additions

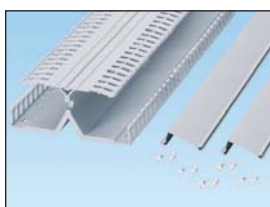

DRD



DRDWR

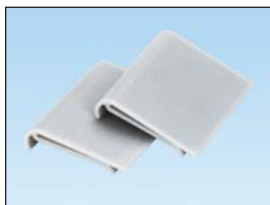

DRDCS

| Part Number | Part Description  | Std. Pkg. Qty. | Std. Ctn. Qty. |
|-------------|---|----------------|----------------|
| DRD22LG6    | 2" height PanelMax™ DIN Rail Wiring Duct with dual wiring channels. Base, covers and DIN rail fasteners included. | 6 Ft.          | 6 Ft.          |
| DRD33LG6    | 3" height PanelMax™ DIN Rail Wiring Duct with dual wiring channels. Base, covers and DIN rail fasteners included. | 6 Ft.          | 6 Ft.          |
| DRD44LG6    | 4" height PanelMax™ DIN Rail Wiring Duct with dual wiring channels. Base, covers and DIN rail fasteners included. | 6 Ft.          | 6 Ft.          |
| DRDC2LG6    | 2" replacement cover for PanelMax™ DIN Rail Wiring Duct.  | 6 Ft.          | 24 Ft.         |
| DRDC3LG6    | 3" replacement cover for PanelMax™ DIN Rail Wiring Duct.  | 6 Ft.          | 24 Ft.         |
| DRDC4LG6    | 4" replacement cover for PanelMax™ DIN Rail Wiring Duct.  | 6 Ft.          | 24 Ft.         |
| DRDSF-C     | Replacement DIN rail fasteners for PanelMax™ DIN Rail Wiring Duct.  | 100            | —              |
| DRDWR2-X    | 2" wire retainer for PanelMax™ DIN Rail Wiring Duct.  | 10             | 100            |
| DRDWR3-X    | 3" wire retainer for PanelMax™ DIN Rail Wiring Duct.  | 10             | 100            |
| DRDWR4-X    | 4" wire retainer for PanelMax™ DIN Rail Wiring Duct.  | 10             | 100            |
| DRDCS2-X    | 2" corner strip for PanelMax™ DIN Rail Wiring Duct.   | 10             | 100            |
| DRDCS3-X    | 3" corner strip for PanelMax™ DIN Rail Wiring Duct.   | 10             | 100            |
| DRDCS4-X    | 4" corner strip for PanelMax™ DIN Rail Wiring Duct.   | 10             | 100            |

Product sold base and cover together in 6 ft. lengths. Replace LG with WH for white color.

A. System Overview

B1. Cable Ties

B2. Cable Accessories

B3. Stainless Steel Ties

C1. Wiring Duct

C2. Surface Raceway

C3. Abrasion Protection

C4. Cable Management

D1. Terminals

D2. Power Connectors

D3. Grounding Connectors

E1. Labeling Systems

E2. Labels

E3. Pre-Printed & Write-On Markers

E4. Permanent Identification

E5. Lockout/Tagout & Safety Solutions

F. Index

A. System Overview

## Features and Benefits – Panduit® PanelMax™ Noise Shield

B1. Cable Ties

B2. Cable Accessories

B3. Stainless Steel Ties

C1. Wiring Duct

C2. Surface Raceway

C3. Abrasion Protection

C4. Cable Management

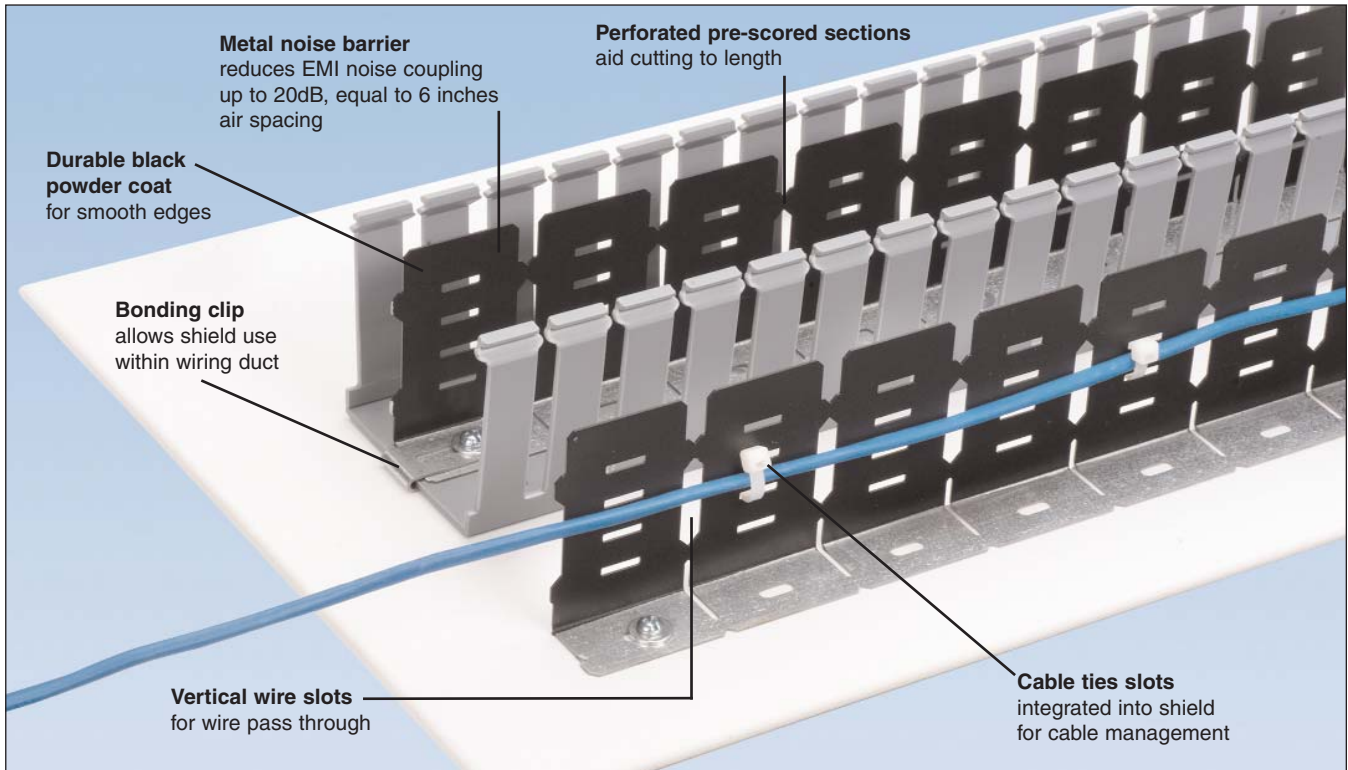

D1. Terminals

D2. Power Connectors

D3. Grounding Connectors



**PanelMax™ Noise Shield** separates drive cables and sensitive communication/signal cables within industrial control panels to reduce electromagnetic interference (EMI) while saving valuable space.

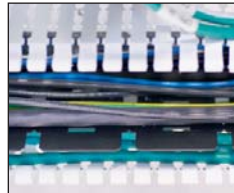

**Metal noise barrier** equivalent to 6 inches of air spacing between power and signal cables, saves valuable panel space.

E1. Labeling Systems

E2. Labels

E3. Pre-Printed & Write-On Markers

E4. Permanent Identification

E5. Lockout/Tagout & Safety Solutions

F. Index



**Perforated and pre-scored sections** make it easy to cut to length with minimal deburring required.



## Panduct® PanelMax™ Noise Shield

- Metal noise barrier reduces EMI noise coupling between noise emitting and sensitive cabling within a control panel; provides up to 20dB reduction in noise which is equivalent to 6 inches of air spacing
- Installs directly to metal panel surface or within 2, 3, or 4 inch height Panduit wiring duct (when shield is installed with supplied bonding clips)
- Perforated and pre-scored sections speed installation by allowing sections of the shield to be snapped off at pre-scored locations to easily cut to length with minimal deburring required

- Vertical wall slots allow wires to cross the barrier at 90° when necessary, providing greater design flexibility
- Horizontal cable tie slots allow cable bundles to be held in place using cable ties so cabling is kept near barrier for greater reliability and optimal aesthetics
- Zinc plated steel surface in contact areas with sub-panel and bonding clip ensures continuity and is corrosion resistant
- Black powder coated vertical surface for smooth edges
- Meets UL 508/508A requirements as a barrier between conductors

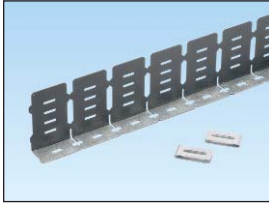

| Part Number | Part Description  | Std. Pkg. Qty. |
|-------------|---|----------------|
| SD2EMI      | EMI Noise Shield kit for 2" height Panduit Wiring Duct; (2) three foot sections, bonding clips, and anti-oxidizing paste. | 1              |
| SD3EMI      | EMI Noise Shield kit for 3" height Panduit Wiring Duct; (2) three foot sections, bonding clips, and anti-oxidizing paste. | 1              |
| SD4EMI      | EMI Noise Shield kit for 4" height Panduit Wiring Duct; (2) three foot sections, bonding clips, and anti-oxidizing paste. | 1              |

## Performance Characteristics

Relative noise reduction in dB over frequency range of the PanelMax™ Noise Shield is shown below.

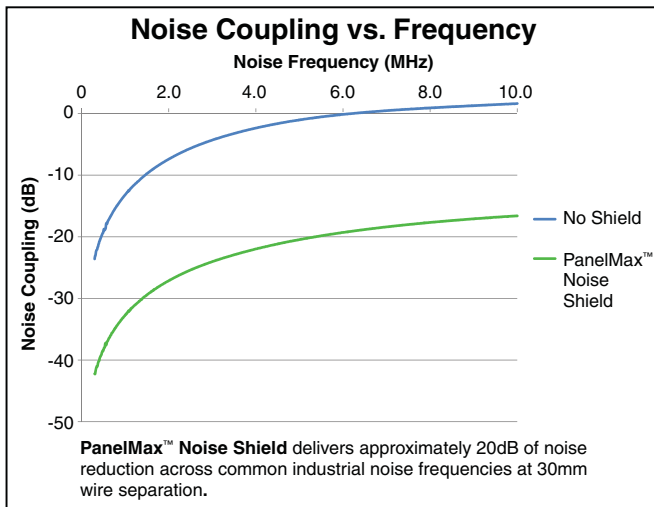

A.  
System  
Overview

B1.  
Cable Ties

B2.  
Cable  
Accessories

B3.  
Stainless  
Steel Ties

C1.  
Wiring  
Duct

C2.  
Surface  
Raceway

C3.  
Abrasion  
Protection

C4.  
Cable  
Management

D1.  
Terminals

D2.  
Power  
Connectors

D3.  
Grounding  
Connectors

E1.  
Labeling  
Systems

E2.  
Labels

E3.  
Pre-Printed  
& Write-On  
Markers

E4.  
Permanent  
Identification

E5.  
Lockout/  
Tagout  
& Safety  
Solutions

F.  
Index



A. System Overview

## Features and Benefits – Panduit® PanelMax™ Corner Wiring Duct

B1. Cable Ties

B2. Cable Accessories

B3. Stainless Steel Ties

C1. Wiring Duct

C2. Surface Raceway

C3. Abrasion Protection

C4. Cable Management

D1. Terminals

D2. Power Connectors

D3. Grounding Connectors

E1. Labeling Systems

E2. Labels

E3. Pre-Printed & Write-On Markers

E4. Permanent Identification

E5. Lockout/Tagout & Safety Solutions

F. Index

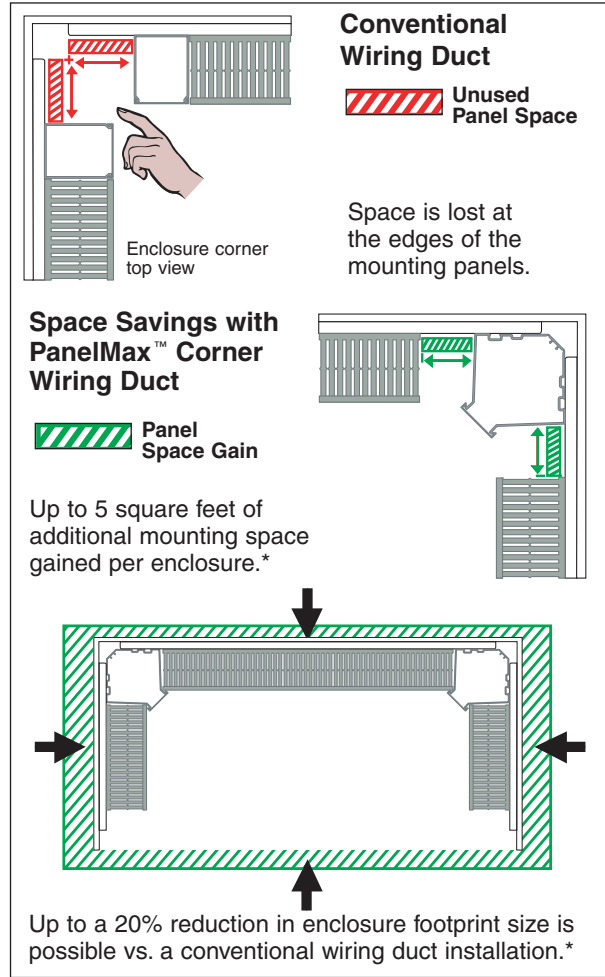
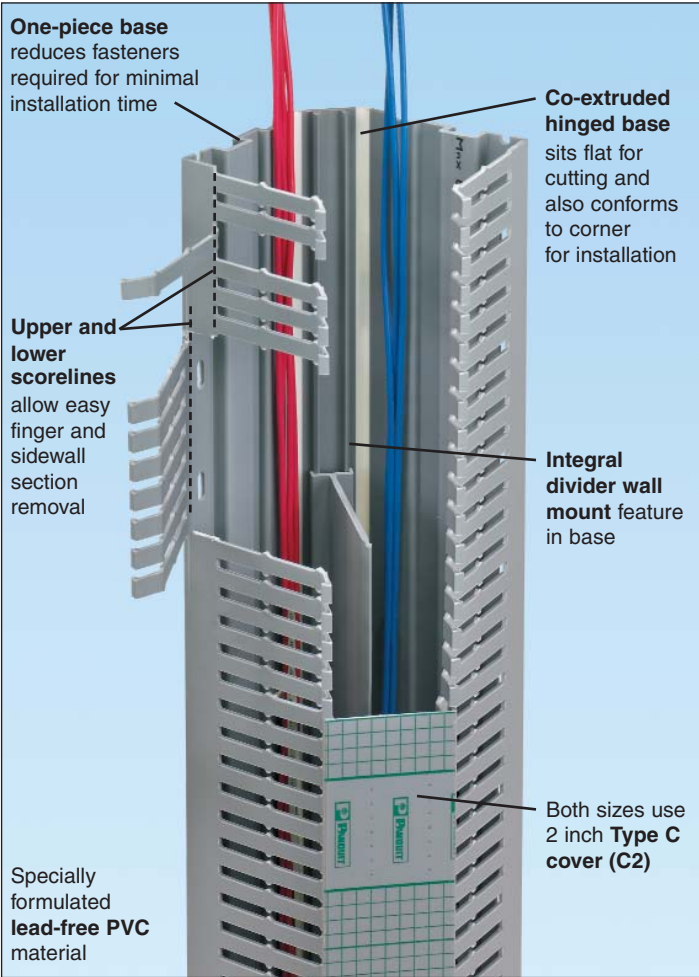

**Panduit® Nylon Rivets**  
Fast, lowest cost mounting method.  
(see page C1.34)



**Panduit® Installation Tools**  
Wide selection of hand tools for cutting and installing wiring duct.  
(see page C1.34)

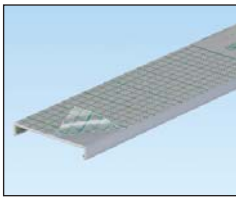

**Panduit® Type C Cover with Protective Film**  
Reduces scrap and labor costs by protecting the surface during storage, handling, and installation.  
(see page C1.9)

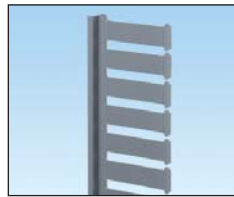

**Panduit® Divider Wall**  
Creates separate wiring channels within the wiring duct base. Available in solid or slotted wall styles.  
(see page C1.26)

\*Actual subpanel space savings will vary depending on wiring duct size, component layout, and enclosure size and type. Footprint savings is based on commercially available enclosures and may not be achievable in some applications.

## PanelMax™ Corner Wiring Duct

- Fits in the unused space in the vertical corner of enclosures, gaining sub-panel space or saving enclosure footprint area
- One-piece base requires less time to install than multi-piece solutions
- Optional quick mount clips engage anywhere along the product base further reducing assembly costs
- Panduit divider wall snaps directly to the integrated mounting feature in the channel to create two separate channels
- Compatible with Panduit 3" and 4" height wiring duct; both product sizes use standard 2 inch wiring duct cover
- Base and cover length is 6 feet.
- Base and covers sold separately



| Base Part Number | Duct Size W x H (In.) | Slot Width |     | Cover Part Number | Std. Pkg. Qty. | Base Ctn. Qty. | Cover Ctn. Qty. |
|------------------|-----------------------|------------|-----|-------------------|----------------|----------------|-----------------|
|                  |                       | In.        | mm  |                   |                |                |                 |
| CWD3LG6          | 4.40 x 3.57           | 0.20       | 5.0 | C2LG6             | 6              | 24             | 120             |
| CWD4LG6          | 5.33 x 4.58           | 0.20       | 5.0 | C2LG6             | 6              | 24             | 120             |
| CWD3WH6          | 4.40 x 3.57           | 0.20       | 5.0 | C2WH6             | 6              | 24             | 120             |
| CWD4WH6          | 5.33 x 4.58           | 0.20       | 5.0 | C2WH6             | 6              | 24             | 120             |

Part number shown in LG (Light Gray) color, also available in WH (White) color. Product available in 6' lengths.

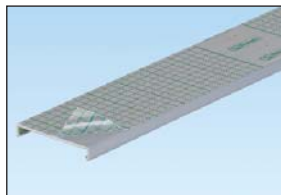
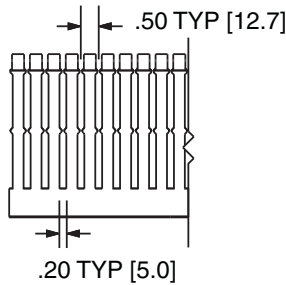
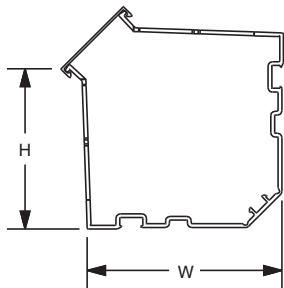

To order cover with protective film add "-F" to part number. 6" cover not available with protective film.



CDLB

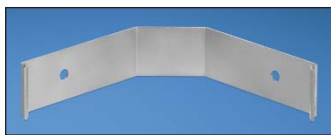

CDCLP

| Part Number              | Part Description   | Fastener Size                | Std. Pkg. Qty. | Std. Ctn. Qty. |
|--------------------------|--|------------------------------|----------------|----------------|
| <b>Quick Mount Clips</b> |  |                              |                |                |
| CDLB3                    | L-bracket with quick mounting clip for installing CWD3 to back panel only. | #10-32 x 1/4 (user supplied) | 16             | —              |
| CDLB4                    | L-bracket with quick mounting clip for installing CWD4 to back panel only. | #10-32 x 1/4 (user supplied) | 16             | —              |
| CDCLP3                   | Quick mounting clip for installing CWD3 corner wiring duct.                | #10-32 x 1/4 (user supplied) | 16             | —              |
| CDCLP4                   | Quick mounting clip for installing CWD4 corner wiring duct.                | #10-32 x 1/4 (user supplied) | 16             | —              |

A. System Overview

B1. Cable Ties

B2. Cable Accessories

B3. Stainless Steel Ties

C1. Wiring Duct

C2. Surface Raceway

C3. Abrasion Protection

C4. Cable Management

D1. Terminals

D2. Power Connectors

D3. Grounding Connectors

E1. Labeling Systems

E2. Labels

E3. Pre-Printed & Write-On Markers

E4. Permanent Identification

E5. Lockout/Tagout & Safety Solutions

F. Index



A. System Overview

## Features and Benefits – Panduit® Type H and HN Hinged Cover Wiring Duct

Available in eight sizes from 1.5" x 2" up to 4" x 4" in light gray, black, and white colors.

B1. Cable Ties

B2. Cable Accessories

B3. Stainless Steel Ties

C1. Wiring Duct

C2. Surface Raceway

C3. Abrasion Protection

C4. Cable Management

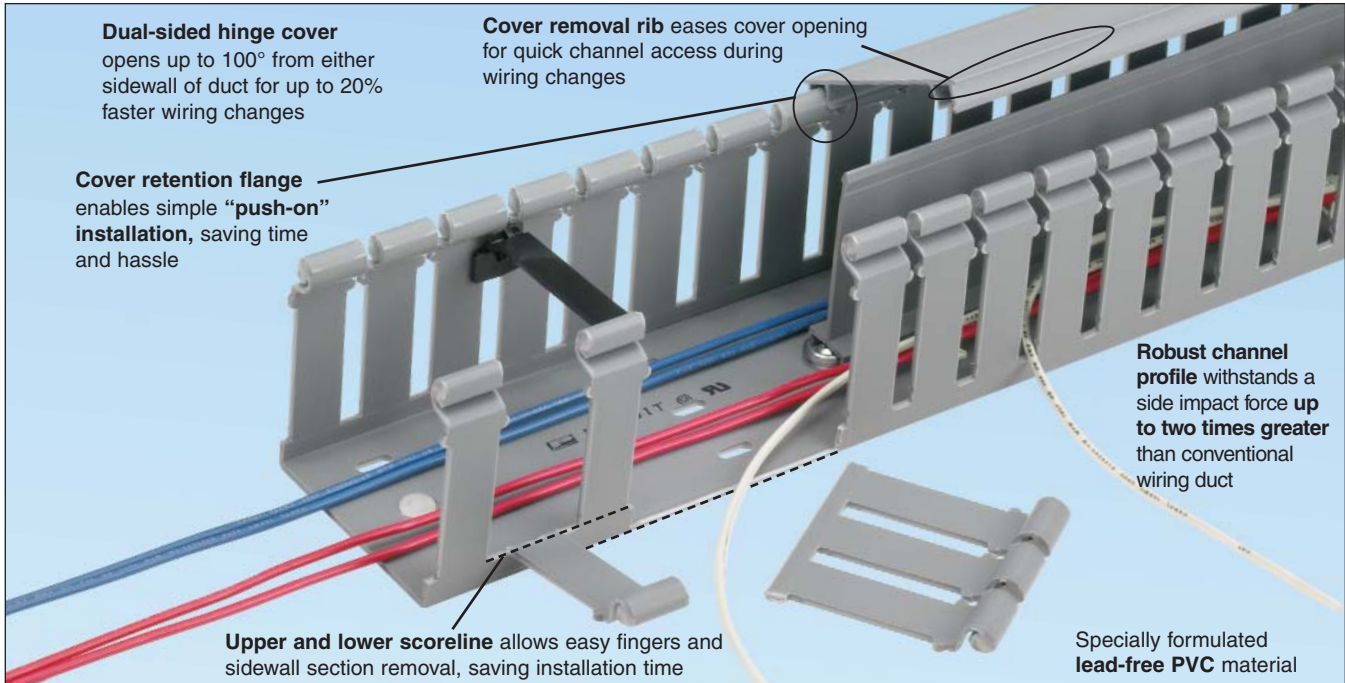

### Labor Savings

- By avoiding the time and hassle in removing and replacing covers, simple wiring changes can be made up to **20% faster** compared to conventional wiring duct installations\*

### Avoid Cover Replacement Costs

- Covers represent 20% of the cost of the wiring duct purchase
- Misplaced covers are a common occurrence after years of use
- Not needing to remove covers during maintenance ensures **better aesthetics and safety** and **avoids the cost to replace lost covers**

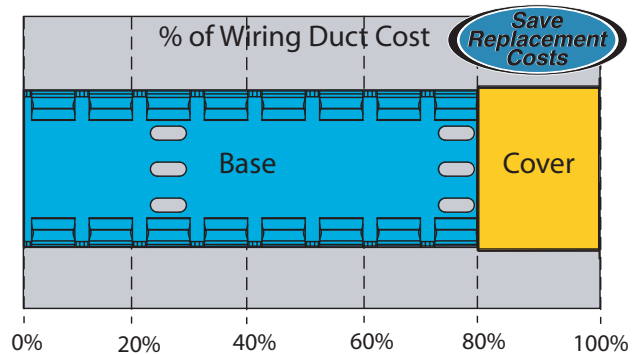

D1. Terminals

D2. Power Connectors

D3. Grounding Connectors

E1. Labeling Systems

E2. Labels

E3. Pre-Printed & Write-On Markers

E4. Permanent Identification

E5. Lockout/Tagout & Safety Solutions

F. Index



**Panduit® Wire Retainers**  
Contain wiring when duct cover is opened. Wire retainers snap easily between duct fingers. (see page C1.28)



**Panduit® Divider Wall**  
Create separate wiring channels within the wiring duct base. Available in solid or slotted wall styles. (see page C1.26)



**Panduit® Installation Tools**  
Wide selection of hand tools for cutting and installing wiring duct. (see page C1.34)



**Panduit® Nylon Rivets**  
Fast, lowest cost mounting method. (see page C1.34)

\*Based on mock panel installations of type H hinged cover wiring duct and other commonly available wiring ducts adding a single component with four wires.

## **UL** Panduct® Type HN Hinged Cover Narrow Slot Wiring Duct

- Narrow slot/finger design provides excellent wire management with smaller wire diameters and high-density components such as terminal blocks, input/output devices, and other hardware
- Material: Lead-free PVC
- UL Recognized continuous use temperature: 122°F (50°C)
- UL 94 flammability rating of V-0
- Conforms with NFPA 79-2007 section 13.3.1 requirement for flame retardant material
- Provided with mounting holes
- Base and cover length is 6 feet

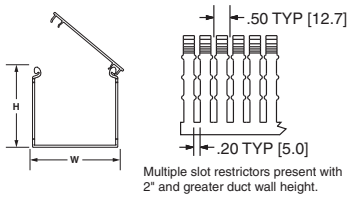
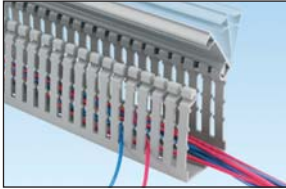

| Base Part Number | Duct Size (W x H)* |               | Slot Width |     | Cover Part Number | Std. Pkg. Qty. | Base Ctn. Qty. | Cover Ctn. Qty. |
|------------------|--------------------|---------------|------------|-----|-------------------|----------------|----------------|-----------------|
|                  | In.                | mm            | In.        | mm  |                   |                |                |                 |
| HN1.5X2LG6       | 1.75 x 1.98        | 44.5 x 50.3   | 0.20       | 5.0 | HC1.5LG6          | 6              | 120            | 120             |
| HN1.5X3LG6       | 1.75 x 3.06        | 44.5 x 77.7   | 0.20       | 5.0 | HC1.5LG6          | 6              | 120            | 120             |
| HN2X2LG6         | 2.17 x 1.98        | 55.1 x 50.3   | 0.20       | 5.0 | HC2LG6            | 6              | 120            | 120             |
| HN2X3LG6         | 2.17 x 3.06        | 55.1 x 77.7   | 0.20       | 5.0 | HC2LG6            | 6              | 60             | 120             |
| HN2X4LG6         | 2.17 x 4.10        | 55.1 x 104.1  | 0.20       | 5.0 | HC2LG6            | 6              | 60             | 120             |
| HN3X3LG6         | 3.25 x 3.06        | 82.6 x 77.7   | 0.20       | 5.0 | HC3LG6            | 6              | 60             | 120             |
| HN3X4LG6         | 3.25 x 4.10        | 82.6 x 104.1  | 0.20       | 5.0 | HC3LG6            | 6              | 60             | 120             |
| HN4X4LG6         | 4.25 x 4.10        | 108.0 x 104.1 | 0.20       | 5.0 | HC4LG6            | 6              | 60             | 60              |

Part Number shown for LG (Light Gray). Available in WH (White).  
Base and cover sold separately.  
\*\*"H" dimension includes duct and cover.

## **UL** Panduct® Type H Hinged Cover Wide Slot Wiring Duct

- Wide slot/finger design provides excellent wire management in general purpose applications and is compatible with a wide range of wire sizes and component types
- Material: Lead-free PVC
- Rated for continuous use temperature: 122°F (50°C)
- UL 94 flammability rating of V-0
- Conforms with NFPA 79-2007 section 13.3.1 requirement for flame retardant material
- Provided with standard mounting holes
- Base and cover length is 6 ft.

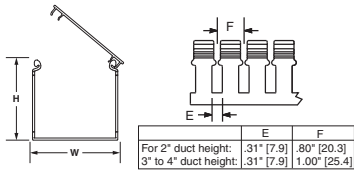
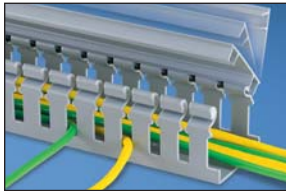

| Base Part Number | Duct Size (W x H)* |               | Slot Width |     | Cover Part Number | Std. Pkg. Qty. | Base Ctn. Qty. | Cover Ctn. Qty. |
|------------------|--------------------|---------------|------------|-----|-------------------|----------------|----------------|-----------------|
|                  | In.                | mm            | In.        | mm  |                   |                |                |                 |
| H1.5X2LG6        | 1.75 x 1.98        | 44.5 x 50.3   | .31        | 7.9 | HC1.5LG6          | 6              | 120            | 120             |
| H1.5X3LG6        | 1.75 x 3.06        | 44.5 x 77.7   | .31        | 7.9 | HC1.5LG6          | 6              | 120            | 120             |
| H2X2LG6          | 2.17 x 1.98        | 55.1 x 50.3   | .31        | 7.9 | HC2LG6            | 6              | 120            | 120             |
| H2X3LG6          | 2.17 x 3.06        | 55.1 x 77.7   | .31        | 7.9 | HC2LG6            | 6              | 60             | 120             |
| H2X4LG6          | 2.17 x 4.10        | 55.1 x 104.1  | .31        | 7.9 | HC2LG6            | 6              | 60             | 120             |
| H3X3LG6          | 3.25 x 3.06        | 82.6 x 77.7   | .31        | 7.9 | HC3LG6            | 6              | 60             | 120             |
| H3X4LG6          | 3.25 x 4.10        | 82.6 x 104.1  | .31        | 7.9 | HC3LG6            | 6              | 60             | 120             |
| H4X4LG6          | 4.25 x 4.10        | 108.0 x 104.1 | .31        | 7.9 | HC4LG6            | 6              | 60             | 60              |

Part Number shown for LG (Light Gray). Available in BL (Black) and WH (White).  
Base and cover sold separately.  
\*\*"H" dimension includes duct and cover.

## **UL** Panduct® Type HS Hinged Cover Solid Wall Raceway

- Solid wall raceway conceals and protects wiring in continuous runs such as in low-voltage cord management applications between control panel stations in conveyor systems
- Material: Lead-free PVC
- UL recognized continuous use temperature: 122°F (50°C)
- UL 94 flammability rating of V-0
- Supplied without mounting holes
- Base and cover length is 6 feet

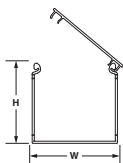
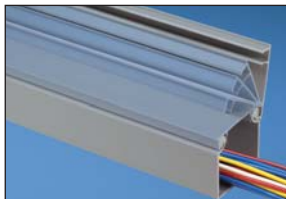

| Base Part Number | Duct Size (W x H)* |               | Cover Part Number | Std. Pkg. Qty. | Base Ctn. Qty. | Cover Ctn. Qty. |
|------------------|--------------------|---------------|-------------------|----------------|----------------|-----------------|
|                  | In.                | mm            |                   |                |                |                 |
| HS1.5X2LG6NM     | 1.75 x 1.98        | 44.5 x 50.3   | HC1.5LG6          | 6              | 120            | 120             |
| HS1.5X3LG6NM     | 1.75 x 3.06        | 44.5 x 77.7   | HC1.5LG6          | 6              | 60             | 120             |
| HS2X2LG6NM       | 2.17 x 1.98        | 55.1 x 50.3   | HC2LG6            | 6              | 120            | 120             |
| HS2X3LG6NM       | 2.17 x 3.06        | 55.1 x 77.7   | HC2LG6            | 6              | 60             | 120             |
| HS2X4LG6NM       | 2.17 x 4.10        | 55.1 x 104.1  | HC2LG6            | 6              | 60             | 120             |
| HS3X3LG6NM       | 3.25 x 3.06        | 82.6 x 77.7   | HC3LG6            | 6              | 60             | 120             |
| HS3X4LG6NM       | 3.25 x 4.10        | 82.6 x 104.1  | HC3LG6            | 6              | 60             | 120             |
| HS4X4LG6NM       | 4.25 x 4.10        | 108.0 x 104.1 | HC4LG6            | 6              | 60             | 60              |

Part Number shown for LG (Light Gray). For BL (Black) and WH (White) colors see color selection guide, page C1.48.  
Base and cover sold separately.  
\*\*"H" dimension includes duct and cover.

A.  
System Overview

B1.  
Cable Ties

B2.  
Cable Accessories

B3.  
Stainless Steel Ties

C1.  
Wiring Duct

C2.  
Surface Raceway

C3.  
Abrasion Protection

C4.  
Cable Management

D1.  
Terminals

D2.  
Power Connectors

D3.  
Grounding Connectors

E1.  
Labeling Systems

E2.  
Labels

E3.  
Pre-Printed & Write-On Markers

E4.  
Permanent Identification

E5.  
Lockout/Tagout & Safety Solutions

F.  
Index

A. System Overview

## Features and Benefits – Panduit® Type G Wide Slot Wiring Duct

Available in 35 sizes from .5" x .5" up to 6" x 4" in a variety of colors.

B1. Cable Ties

B2. Cable Accessories

B3. Stainless Steel Ties

C1. Wiring Duct

C2. Surface Raceway

C3. Abrasion Protection

C4. Cable Management

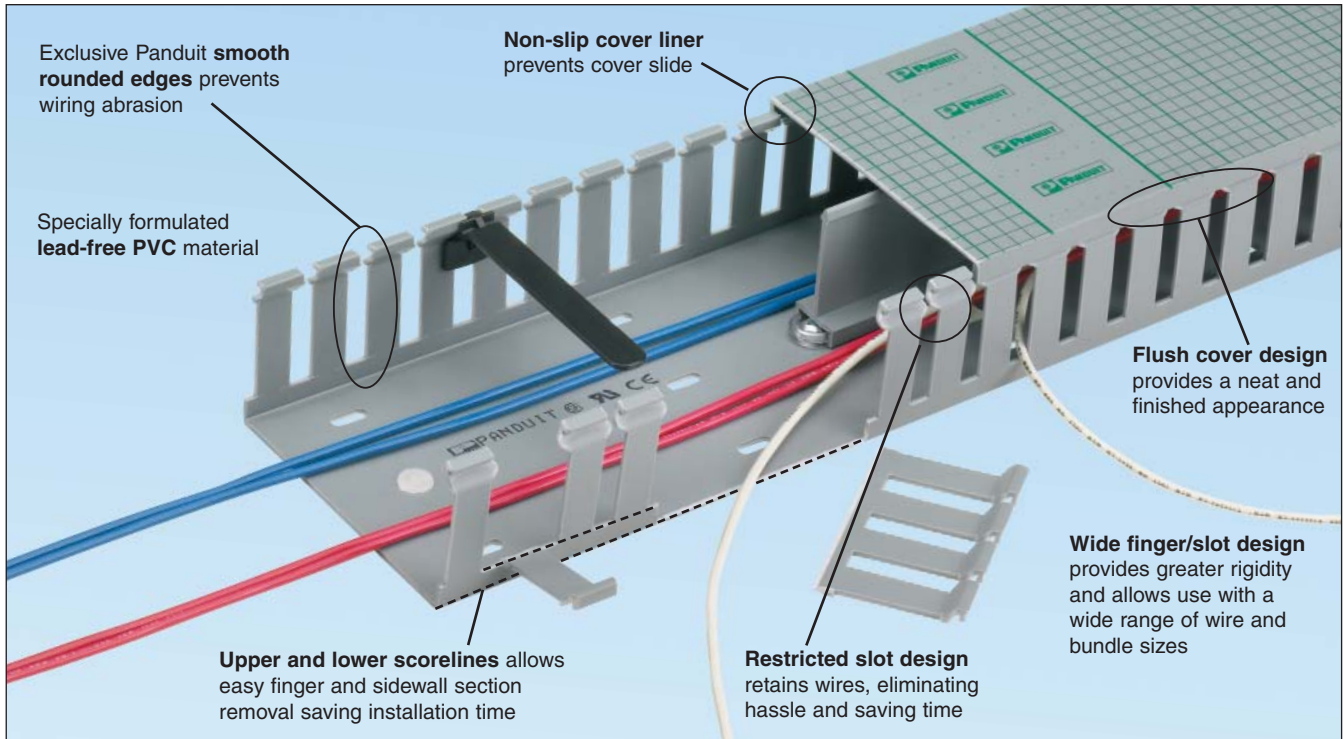

D1. Terminals

D2. Power Connectors

D3. Grounding Connectors

E1. Labeling Systems

E2. Labels

E3. Pre-Printed & Write-On Markers

E4. Permanent Identification

E5. Lockout/Tagout & Safety Solutions

F. Index



**Panduit® Wire Retainers**  
Contain wiring when duct cover is opened. Wire retainers snap easily between duct fingers. See page C1.28.



**Panduit® Divider Wall**  
Create separate wiring channels within the wiring duct base. Available in solid or slotted wall styles. See page C1.26.

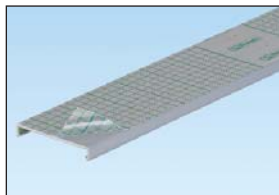

**Panduit® Type C Cover with Protective Film**  
Reduces scrap and labor costs by protecting the surface during storage, handling, and installation. See page C1.13.



**Panduit® Nylon Rivets**  
Fast, lowest cost mounting method. See page C1.34.



**Panduit® Installation Tools**  
Wide selection of hand tools for cutting and installing wiring duct. See page C1.34.



## Panduct® Type G Wide Slot Wiring Duct

- Wide slot/finger design provides greater sidewall rigidity and can be used with a wide range of wire bundle sizes
- Material: Lead-free PVC
- UL recognized continuous use temperature: 122°F (50°C)
- UL 94 flammability rating of V-0
- Conforms with NFPA 79-2007 section 13.3.1 requirement for flame retardant material
- Provided with mounting holes
- Base and cover length is 6 feet

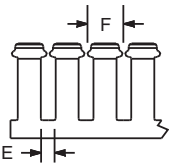
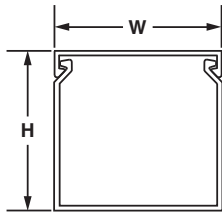
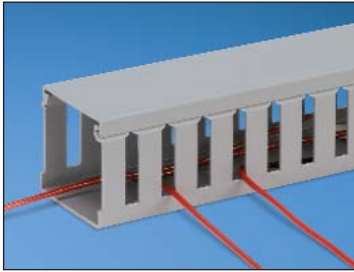

|                          | E           | F            |
|--------------------------|-------------|--------------|
| For .5" duct height:     | 0.37" [9.4] | 0.80" [20.3] |
| 0.75" to 2" duct height: | 0.31" [7.9] | 0.80" [20.3] |
| 3" to 4" duct height:    | 0.31" [7.9] | 1.00" [25.4] |
| 5" duct height:          | 0.38" [9.4] | 1.33" [33.8] |

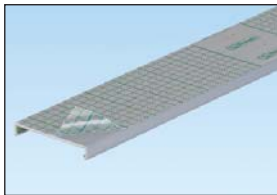

To order cover with protective film add "-F" to part number. 6" cover not available with film.

| Base Part Number | Duct Size (W x H)* |               | Slot Width |     | Cover Part Number | Std. Pkg. Qty. | Base Ctn. Qty. | Cover Ctn. Qty. |
|------------------|--------------------|---------------|------------|-----|-------------------|----------------|----------------|-----------------|
|                  | In.                | mm            | In.        | mm  |                   |                |                |                 |
| G.5X.5LG6        | 0.69 x 0.60        | 17.5 x 15.2   | 0.38       | 9.7 | C.5LG6            | 6              | 120            | 120             |
| G.5X1LG6         | 0.69 x 1.06        | 17.5 x 26.9   | 0.31       | 7.9 | C.5LG6            | 6              | 120            | 120             |
| G.5X2LG6         | 0.69 x 2.03        | 17.5 x 51.6   | 0.31       | 7.9 | C.5LG6            | 6              | 120            | 120             |
| G.75X.75LG6      | 0.93 x 0.82        | 23.6 x 20.8   | 0.31       | 7.9 | C.75LG6           | 6              | 120            | 120             |
| G.75X1LG6        | 0.93 x 1.06        | 23.6 x 26.9   | 0.31       | 7.9 | C.75LG6           | 6              | 120            | 120             |
| G.75X1.5LG6      | 0.93 x 1.57        | 23.6 x 39.9   | 0.31       | 7.9 | C.75LG6           | 6              | 120            | 120             |
| G.75X2LG6        | 0.93 x 2.03        | 23.6 x 51.7   | 0.31       | 7.9 | C.75LG6           | 6              | 120            | 120             |
| G1X1LG6          | 1.26 x 1.12        | 32.0 x 28.4   | 0.31       | 7.9 | C1LG6             | 6              | 120            | 120             |
| G1X1.5LG6        | 1.26 x 1.62        | 32.0 x 41.1   | 0.31       | 7.9 | C1LG6             | 6              | 120            | 120             |
| G1X2LG6          | 1.26 x 2.12        | 32.0 x 53.8   | 0.31       | 7.9 | C1LG6             | 6              | 120            | 120             |
| G1X3LG6          | 1.26 x 3.12        | 32.0 x 79.2   | 0.31       | 7.9 | C1LG6             | 6              | 120            | 120             |
| G1X4LG6          | 1.26 x 4.10        | 32.0 x 104.1  | 0.31       | 7.9 | C1LG6             | 6              | 60             | 120             |
| G1.5X1LG6        | 1.75 x 1.12        | 44.5 x 28.4   | 0.31       | 7.9 | C1.5LG6           | 6              | 120            | 120             |
| G1.5X1.5LG6      | 1.75 x 1.62        | 44.5 x 41.1   | 0.31       | 7.9 | C1.5LG6           | 6              | 120            | 120             |
| G1.5X2LG6        | 1.75 x 2.12        | 44.5 x 53.8   | 0.31       | 7.9 | C1.5LG6           | 6              | 120            | 120             |
| G1.5X3LG6        | 1.75 x 3.12        | 44.5 x 79.2   | 0.31       | 7.9 | C1.5LG6           | 6              | 120            | 120             |
| G1.5X4LG6        | 1.75 x 4.10        | 44.5 x 104.1  | 0.31       | 7.9 | C1.5LG6           | 6              | 60             | 120             |
| G2X1LG6          | 2.25 x 1.12        | 57.2 x 28.4   | 0.31       | 7.9 | C2LG6             | 6              | 120            | 120             |
| G2X1.5LG6        | 2.25 x 1.62        | 57.2 x 41.1   | 0.31       | 7.9 | C2LG6             | 6              | 120            | 120             |
| G2X2LG6          | 2.25 x 2.12        | 57.2 x 53.8   | 0.31       | 7.9 | C2LG6             | 6              | 120            | 120             |
| G2X3LG6          | 2.25 x 3.12        | 57.2 x 79.2   | 0.31       | 7.9 | C2LG6             | 6              | 60             | 120             |
| G2X4LG6          | 2.25 x 4.10        | 57.2 x 104.1  | 0.31       | 7.9 | C2LG6             | 6              | 60             | 120             |
| G2X5LG6          | 2.25 x 5.10        | 57.2 x 129.5  | 0.38       | 9.7 | C2LG6             | 6              | 60             | 120             |
| G2.5X3LG6        | 2.75 x 3.12        | 69.9 x 79.2   | 0.31       | 7.9 | C2.5LG6           | 6              | 120            | 120             |
| G3X1LG6          | 3.25 x 1.12        | 82.6 x 28.4   | 0.31       | 7.9 | C3LG6             | 6              | 120            | 120             |
| G3X2LG6          | 3.25 x 2.12        | 82.6 x 53.8   | 0.31       | 7.9 | C3LG6             | 6              | 120            | 120             |
| G3X3LG6          | 3.25 x 3.12        | 82.6 x 79.2   | 0.31       | 7.9 | C3LG6             | 6              | 60             | 120             |
| G3X4LG6          | 3.25 x 4.10        | 82.6 x 104.1  | 0.31       | 7.9 | C3LG6             | 6              | 60             | 120             |
| G3X5LG6          | 3.25 x 5.10        | 82.6 x 129.5  | 0.38       | 9.7 | C3LG6             | 6              | 60             | 120             |
| G4X1.5LG6        | 4.25 x 1.62        | 108.0 x 41.1  | 0.31       | 7.9 | C4LG6             | 6              | 120            | 120             |
| G4X2LG6          | 4.25 x 2.12        | 108.0 x 53.8  | 0.31       | 7.9 | C4LG6             | 6              | 60             | 120             |
| G4X3LG6          | 4.25 x 3.12        | 108.0 x 79.2  | 0.31       | 7.9 | C4LG6             | 6              | 60             | 120             |
| G4X4LG6          | 4.25 x 4.10        | 108.0 x 104.1 | 0.31       | 7.9 | C4LG6             | 6              | 60             | 120             |
| G4X5LG6          | 4.25 x 5.10        | 108.0 x 129.5 | 0.38       | 9.7 | C4LG6             | 6              | 60             | 120             |
| G6X4LG6          | 6.25 x 4.15        | 158.8 x 105.4 | 0.31       | 7.9 | C6LG6             | 6              | 60             | 120             |

Part number shown for LG (Light Gray). For other color availability see color selection guide, page C1.48. Base and cover sold separately.

\*\*"H" dimension includes duct and cover.

A.  
System  
Overview

B1.  
Cable Ties

B2.  
Cable  
Accessories

B3.  
Stainless  
Steel Ties

C1.  
Wiring  
Duct

C2.  
Surface  
Raceway

C3.  
Abrasion  
Protection

C4.  
Cable  
Management

D1.  
Terminals

D2.  
Power  
Connectors

D3.  
Grounding  
Connectors

E1.  
Labeling  
Systems

E2.  
Labels

E3.  
Pre-Printed  
& Write-On  
Markers

E4.  
Permanent  
Identification

E5.  
Lockout/  
Tagout  
& Safety  
Solutions

F.  
Index

A. System Overview

## Features and Benefits – Panduit® Type F Narrow Slot Wiring Duct

Available in 31 sizes from .5" x .5" up to 6" x 4" in a variety of colors.

B1. Cable Ties

B2. Cable Accessories

B3. Stainless Steel Ties

C1. Wiring Duct

C2. Surface Raceway

C3. Abrasion Protection

C4. Cable Management

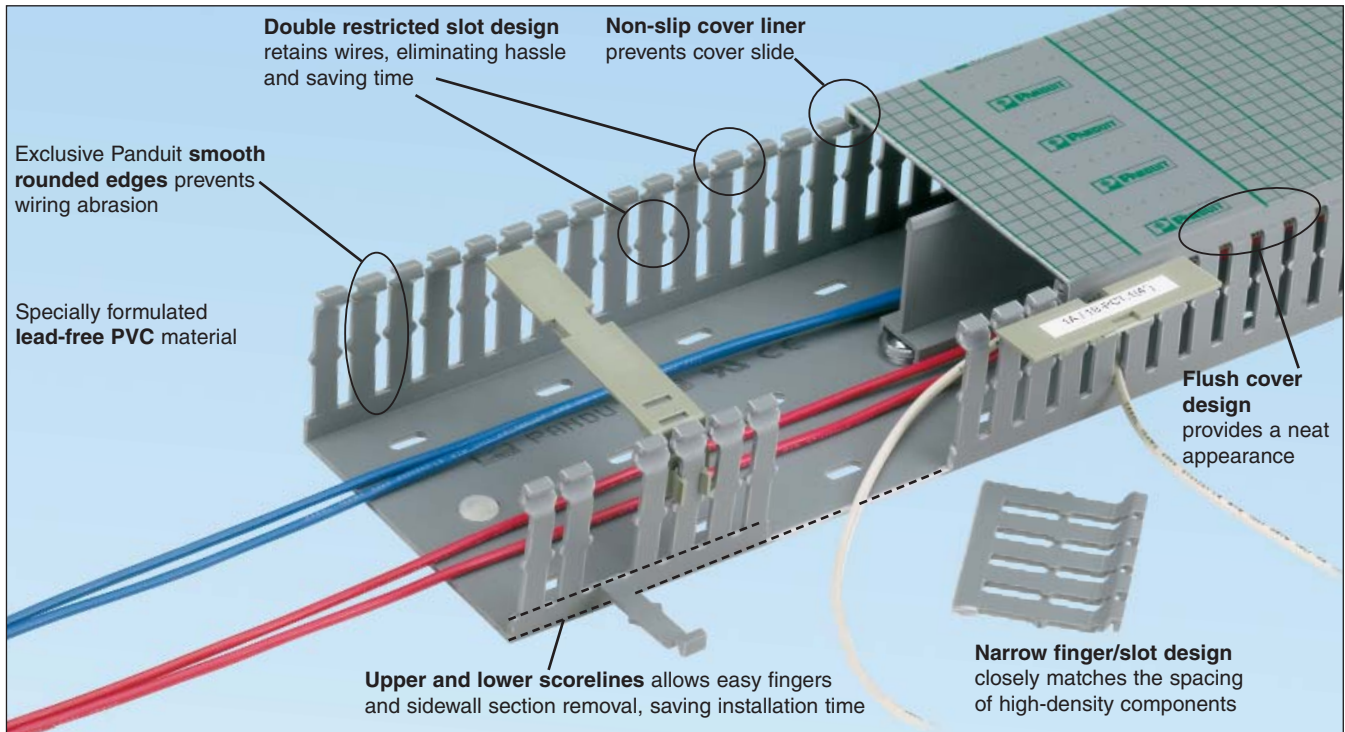

D1. Terminals

D2. Power Connectors

D3. Grounding Connectors

E1. Labeling Systems

E2. Labels

E3. Pre-Printed & Write-On Markers

E4. Permanent Identification

E5. Lockout/Tagout & Safety Solutions

F. Index



**Panduit® Wire Retainers for Type F Wiring Duct**  
Contain wiring when duct cover is opened. Wire retainers snap easily between duct fingers. (see page C1.29)



**Panduit® Divider Wall**  
Create separate wiring channels within the wiring duct base. Available in solid or slotted wall styles. (see page C1.26)

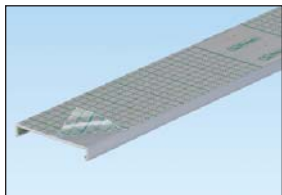

**Panduit® Type C Cover with Protective Film**  
Reduces scrap and labor costs by protecting the surface during storage, handling, and installation. (see page C1.15)



**Panduit® Nylon Rivets**  
Fast, lowest cost mounting method. (see page C1.34)



**Panduit® Installation Tools**  
Wide selection of hand tools for cutting and installing wiring duct. (see page C1.34)

## Panduct® Type F Narrow Slot Wiring Duct

- Narrow slot/finger design provides more slots to fit the spacing of high-density terminal blocks and other hardware
- Material: Lead-free PVC
- UL recognized continuous use temperature: 122°F (50°C)
- UL 94 flammability rating of V-0
- Conforms with NFPA 79-2007 section 13.3.1 requirement for flame retardant material
- Provided with mounting holes
- Base and cover length is 6 feet

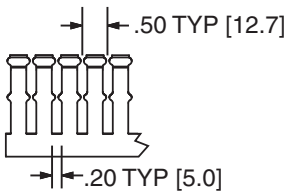
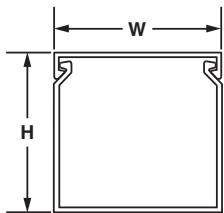
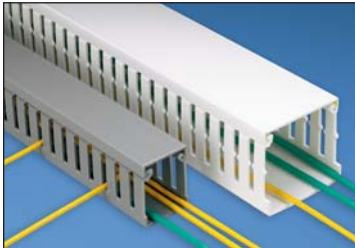

Multiple slot restrictors present with 2" and greater duct wall height.

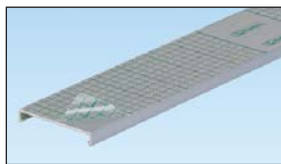

To order cover with protective film add "-F" to part number. 6" cover not available with film.



| Base Part Number | Duct Size (W x H)* |               | Slot Width |     | Cover Part Number | Std. Pkg. Qty. | Base Ctn. Qty. | Cover Ctn. Qty. |
|------------------|--------------------|---------------|------------|-----|-------------------|----------------|----------------|-----------------|
|                  | In.                | mm            | In.        | mm  |                   |                |                |                 |
| F.5X.5LG6        | 0.69 x 0.60        | 17.5 x 15.2   | 0.20       | 5.0 | C.5LG6            | 6              | 120            | 120             |
| F.5X1LG6         | 0.69 x 1.06        | 17.5 x 26.9   | 0.20       | 5.0 | C.5LG6            | 6              | 120            | 120             |
| F.75X.75LG6      | 0.93 x 0.82        | 23.6 x 20.9   | 0.20       | 5.0 | C.75LG6           | 6              | 120            | 120             |
| F.75X1.5LG6      | 0.93 x 1.57        | 23.6 x 39.9   | 0.20       | 5.0 | C.75LG6           | 6              | 120            | 120             |
| F1X1LG6          | 1.26 x 1.13        | 32.0 x 28.7   | 0.20       | 5.0 | C1LG6             | 6              | 120            | 120             |
| F1X1.5LG6        | 1.26 x 1.62        | 32.0 x 41.1   | 0.20       | 5.0 | C1LG6             | 6              | 120            | 120             |
| F1X2LG6          | 1.26 x 2.12        | 32.0 x 53.8   | 0.20       | 5.0 | C1LG6             | 6              | 120            | 120             |
| F1X3LG6          | 1.26 x 3.12        | 32.0 x 79.2   | 0.20       | 5.0 | C1LG6             | 6              | 120            | 120             |
| F1X4LG6          | 1.26 x 4.10        | 32.0 x 104.1  | 0.20       | 5.0 | C1LG6             | 6              | 60             | 120             |
| F1.5X1LG6        | 1.75 x 1.12        | 44.5 x 28.4   | 0.20       | 5.0 | C1.5LG6           | 6              | 120            | 120             |
| F1.5X1.5LG6      | 1.75 x 1.62        | 44.5 x 41.1   | 0.20       | 5.0 | C1.5LG6           | 6              | 120            | 120             |
| F1.5X2LG6        | 1.75 x 2.12        | 44.5 x 53.8   | 0.20       | 5.0 | C1.5LG6           | 6              | 120            | 120             |
| F1.5X3LG6        | 1.75 x 3.12        | 44.5 x 79.2   | 0.20       | 5.0 | C1.5LG6           | 6              | 120            | 120             |
| F1.5X4LG6        | 1.75 x 4.10        | 44.5 x 104.1  | 0.20       | 5.0 | C1.5LG6           | 6              | 60             | 120             |
| F2X1LG6          | 2.25 x 1.12        | 57.2 x 28.4   | 0.20       | 5.0 | C2LG6             | 6              | 120            | 120             |
| F2X1.5LG6        | 2.25 x 1.62        | 57.2 x 41.1   | 0.20       | 5.0 | C2LG6             | 6              | 120            | 120             |
| F2X2LG6          | 2.25 x 2.12        | 57.2 x 53.8   | 0.20       | 5.0 | C2LG6             | 6              | 120            | 120             |
| F2X3LG6          | 2.25 x 3.12        | 57.2 x 79.2   | 0.20       | 5.0 | C2LG6             | 6              | 60             | 120             |
| F2X4LG6          | 2.25 x 4.10        | 57.2 x 104.1  | 0.20       | 5.0 | C2LG6             | 6              | 60             | 120             |
| F2X5LG6          | 2.25 x 5.10        | 57.2 x 129.5  | 0.20       | 5.0 | C2LG6             | 6              | 60             | 120             |
| F2.5X3LG6        | 2.75 x 3.12        | 69.9 x 79.2   | 0.20       | 5.0 | C2.5LG6           | 6              | 120            | 120             |
| F3X1LG6          | 3.25 x 1.12        | 82.6 x 28.4   | 0.20       | 5.0 | C3LG6             | 6              | 120            | 120             |
| F3X2LG6          | 3.25 x 2.12        | 82.6 x 53.8   | 0.20       | 5.0 | C3LG6             | 6              | 120            | 120             |
| F3X3LG6          | 3.25 x 3.12        | 82.6 x 79.2   | 0.20       | 5.0 | C3LG6             | 6              | 60             | 120             |
| F3X4LG6          | 3.25 x 4.10        | 82.6 x 104.1  | 0.20       | 5.0 | C3LG6             | 6              | 60             | 120             |
| F3X5LG6          | 3.25 x 5.10        | 82.6 x 129.5  | 0.20       | 5.0 | C3LG6             | 6              | 60             | 120             |
| F4X2LG6          | 4.25 x 2.12        | 108.0 x 53.8  | 0.20       | 5.0 | C4LG6             | 6              | 60             | 120             |
| F4X3LG6          | 4.25 x 3.12        | 108.0 x 79.2  | 0.20       | 5.0 | C4LG6             | 6              | 60             | 120             |
| F4X4LG6          | 4.25 x 4.10        | 108.0 x 104.1 | 0.20       | 5.0 | C4LG6             | 6              | 60             | 120             |
| F4X5LG6          | 4.25 x 5.10        | 108.0 x 129.5 | 0.20       | 5.0 | C4LG6             | 6              | 60             | 120             |
| F6X4LG6          | 6.25 x 4.15        | 158.8 x 105.4 | 0.20       | 5.0 | C6LG6             | 6              | 60             | 120             |

Part number shown for LG (Light Gray). For other color availability see color selection guide, page C1.48.

Base and cover sold separately.

\*"H" dimension includes duct and cover.

A. System Overview

B1. Cable Ties

B2. Cable Accessories

B3. Stainless Steel Ties

C1. Wiring Duct

C2. Surface Raceway

C3. Abrasion Protection

C4. Cable Management

D1. Terminals

D2. Power Connectors

D3. Grounding Connectors

E1. Labeling Systems

E2. Labels

E3. Pre-Printed & Write-On Markers

E4. Permanent Identification

E5. Lockout/Tagout & Safety Solutions

F. Index



A. System Overview

## Features and Benefits – Panduit® Flush Cover Type D Round Hole Wiring Duct

Available in sixteen sizes from 1" x 2" up to 4" x 4" in a variety of colors.

B1. Cable Ties

B2. Cable Accessories

B3. Stainless Steel Ties

C1. Wiring Duct

C2. Surface Raceway

C3. Abrasion Protection

C4. Cable Management

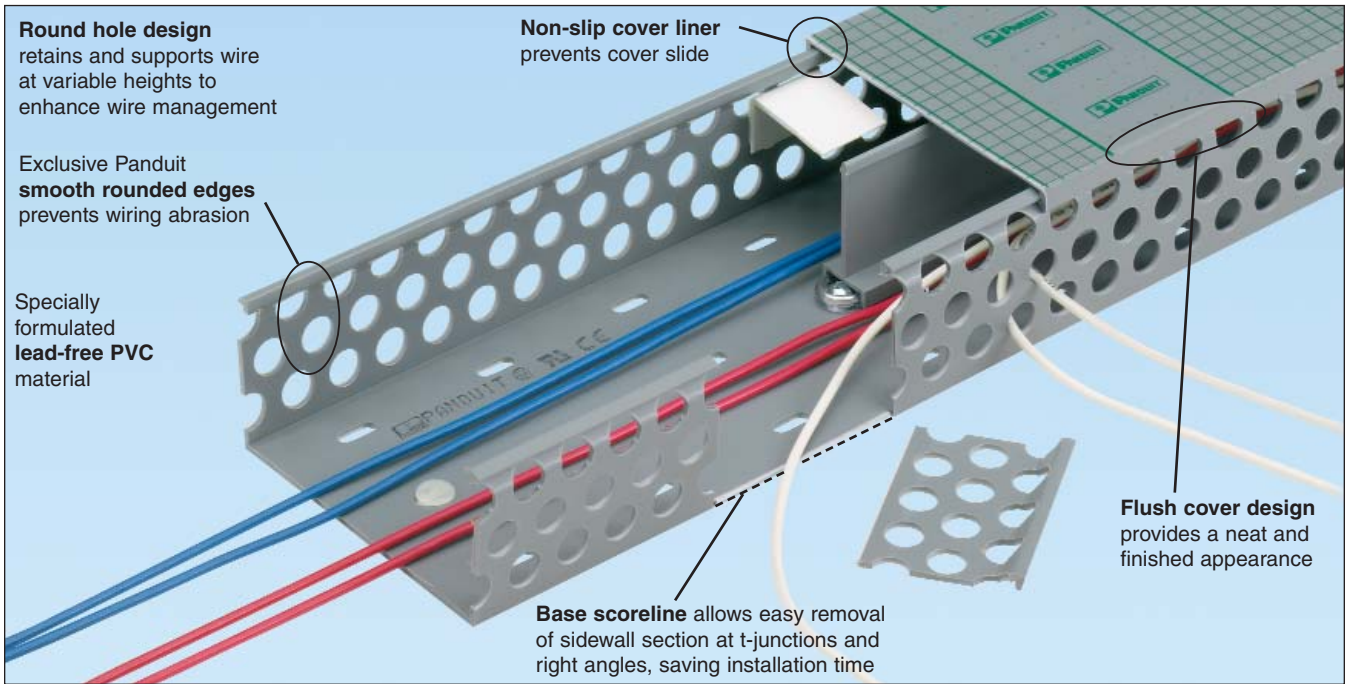

D1. Terminals

D2. Power Connectors

D3. Grounding Connectors

E1. Labeling Systems

E2. Labels

E3. Pre-Printed & Write-On Markers

E4. Permanent Identification

E5. Lockout/Tagout & Safety Solutions

F. Index

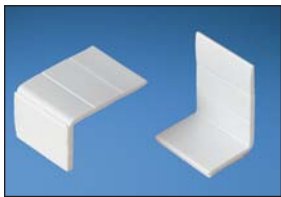

### Panduit® Wire Retainers for Type D Wiring Duct

Contain wiring when duct cover is opened. Wire retainers mount onto walls with pressure sensitive adhesive. (see page C1.28)



### Panduit® Divider Wall

Create separate wiring channels within the wiring duct base. Available in solid or slotted wall styles. (see page C1.26)

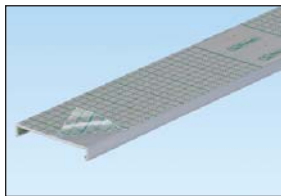

### Panduit® Type C Cover with Protective Film

Reduces scrap and labor costs by protecting the surface during storage, handling, and installation. (see page C1.17)



### Panduit® Nylon Rivets

Fast, lowest cost mounting method. (see page C1.34)



### Panduit® Installation Tools

Wide selection of hand tools for cutting and installing wiring duct. (see page C1.34)

## UL® CE Panduct® Flush Cover Type D Round Hole Wiring Duct

- Round hole design has multiple rows of holes to retain and support wire at variable heights and positions
- Material: Lead-free PVC
- UL recognized continuous use temperature: 122°F (50°C)
- UL 94 flammability rating of V-0
- Conforms with NFPA 79-2007 section 13.3.1 requirement for flame retardant material
- Provided with mounting holes
- Base and cover length is 6 feet

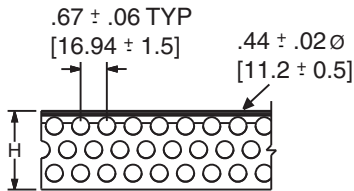
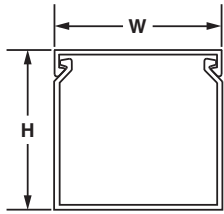
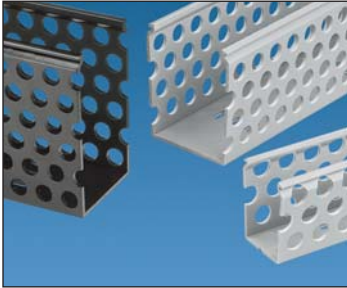

For 2" duct height = 3 rows of holes  
 3" duct height = 4 rows of holes  
 4" duct height = 6 rows of holes

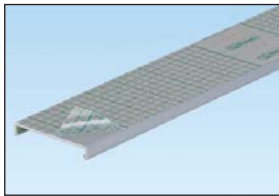

To order cover with protective film add "-F" to part number. 6" cover not available with film.

| Base Part Number | Duct Size (W x H)* |               | Cover Part Number | Std. Pkg. Qty. | Base Ctn. Qty. | Cover Ctn. Qty. |
|------------------|--------------------|---------------|-------------------|----------------|----------------|-----------------|
|                  | In.                | mm            |                   |                |                |                 |
| D1X2LG6          | 1.26 x 2.12        | 32.0 x 53.8   | C1LG6             | 6              | 120            | 120             |
| D1X3LG6          | 1.26 x 3.12        | 32.0 x 79.2   | C1LG6             | 6              | 120            | 120             |
| D1X4LG6          | 1.26 x 4.10        | 32.0 x 104.1  | C1LG6             | 6              | 120            | 120             |
| D1.5X2LG6        | 1.75 x 2.12        | 44.5 x 53.8   | C1.5LG6           | 6              | 120            | 120             |
| D1.5X3LG6        | 1.75 x 3.12        | 44.5 x 79.2   | C1.5LG6           | 6              | 120            | 120             |
| D1.5X4LG6        | 1.75 x 4.10        | 44.5 x 104.1  | C1.5LG6           | 6              | 60             | 120             |
| D2X2LG6          | 2.25 x 2.12        | 57.2 x 53.8   | C2LG6             | 6              | 120            | 120             |
| D2X3LG6          | 2.25 x 3.12        | 57.2 x 79.2   | C2LG6             | 6              | 60             | 120             |
| D2X4LG6          | 2.25 x 4.10        | 57.2 x 104.1  | C2LG6             | 6              | 60             | 120             |
| D2.5X3LG6        | 2.75 x 3.12        | 69.9 x 79.2   | C2.5LG6           | 6              | 120            | 120             |
| D3X2LG6          | 3.25 x 2.12        | 82.6 x 53.8   | C3LG6             | 6              | 120            | 120             |
| D3X3LG6          | 3.25 x 3.12        | 82.6 x 79.2   | C3LG6             | 6              | 60             | 120             |
| D3X4LG6          | 3.25 x 4.10        | 82.6 x 104.1  | C3LG6             | 6              | 60             | 120             |
| D4X2LG6          | 4.25 x 2.12        | 108.0 x 53.8  | C4LG6             | 6              | 60             | 120             |
| D4X3LG6          | 4.25 x 3.12        | 108.0 x 79.2  | C4LG6             | 6              | 60             | 120             |
| D4X4LG6          | 4.25 x 4.10        | 108.0 x 104.1 | C4LG6             | 6              | 60             | 120             |

Part number shown for LG (Light Gray). For other color availability see color selection guide, page C1.48.  
 Base and cover sold separately.  
 \*\*"H" dimension includes duct and cover.

A. System Overview

B1. Cable Ties

B2. Cable Accessories

B3. Stainless Steel Ties

C1. Wiring Duct

C2. Surface Raceway

C3. Abrasion Protection

C4. Cable Management

D1. Terminals

D2. Power Connectors

D3. Grounding Connectors

E1. Labeling Systems

E2. Labels

E3. Pre-Printed & Write-On Markers

E4. Permanent Identification

E5. Lockout/Tagout & Safety Solutions

F. Index

A. System Overview

## Features and Benefits – Panduit® Type MC Metric Narrow Slot Wiring Duct

Available in 20 sizes from 25mm x 25mm up to 100mm x 100mm in international gray and white colors.

B1. Cable Ties

B2. Cable Accessories

B3. Stainless Steel Ties

C1. Wiring Duct

C2. Surface Raceway

C3. Abrasion Protection

C4. Cable Management

D1. Terminals

D2. Power Connectors

D3. Grounding Connectors

E1. Labeling Systems

E2. Labels

E3. Pre-Printed & Write-On Markers

E4. Permanent Identification

E5. Lockout/Tagout & Safety Solutions

F. Index

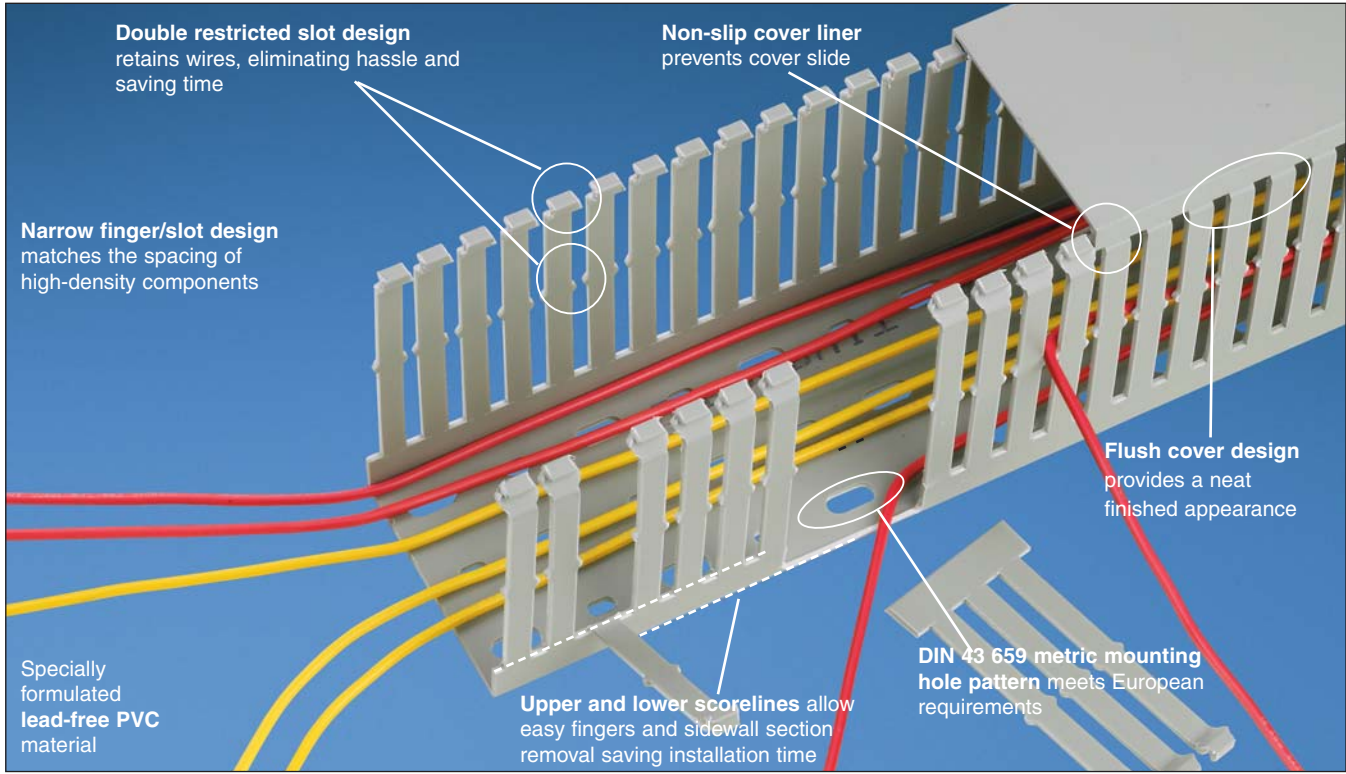

**Panduit® Wire Retainers for Type MC Wiring Duct**  
Contain wiring when duct cover is opened. Wire retainers snap easily between duct fingers. (see page C1.29)



**Panduit® Divider Wall**  
Create separate wiring channels within the wiring duct base. Available in solid or slotted wall styles. (see page C1.26)



**Panduit® Installation Tools**  
Wide selection of hand tools for cutting and installing wiring duct. (see page C1.34)



**Panduit® Nylon Rivets**  
Fast, lowest cost mounting method. (see page C1.34)

## Panduct® Type MC Metric Narrow Slot Wiring Duct

- CE compliant and metric sizing for control panels intended for European applications
- Material: Lead-free PVC
- UL recognized continuous use temperature: 122°F (50°C)
- UL 94 flammability rating of V-0
- Conforms with NFPA 79-2007 section 13.3.1 requirement for flame retardant material
- Provided with DIN 43 659 mounting holes
- Duct and cover packaged together in 2m lengths

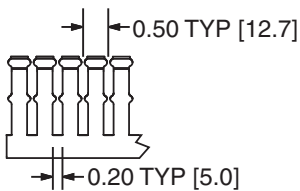
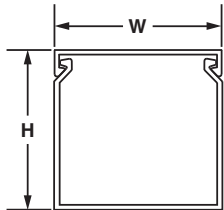
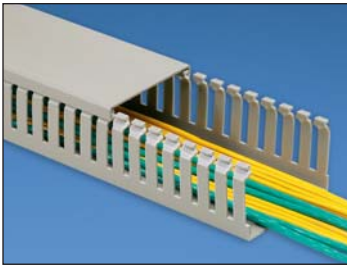

Multiple slot restrictors present with 62mm and greater duct wall height.

| Base and Cover Part Number | Duct Size (W x H)* |             | Slot Width |     | Replacement Cover Part Number | Base and Cover Pkg. Qty. (m) | Replacement Cover Std. Pkg. Qty. |
|----------------------------|--------------------|-------------|------------|-----|-------------------------------|------------------------------|----------------------------------|
|                            | mm                 | In.         | In.        | mm  |                               |                              |                                  |
| MC25X25IG2                 | 24.6 x 23.6        | 0.97 x 0.93 | 0.20       | 5.0 | C25IG2                        | 20                           | 20                               |
| MC25X37IG2                 | 24.6 x 35.8        | 0.97 x 1.41 | 0.20       | 5.0 | C25IG2                        | 20                           | 20                               |
| MC25X50IG2                 | 24.6 x 47.8        | 0.97 x 1.88 | 0.20       | 5.0 | C25IG2                        | 20                           | 20                               |
| MC25X62IG2                 | 24.6 x 59.7        | 0.97 x 2.35 | 0.20       | 5.0 | C25IG2                        | 20                           | 20                               |
| MC25X75IG2                 | 24.6 x 72.4        | 0.97 x 2.85 | 0.20       | 5.0 | C25IG2                        | 20                           | 20                               |
| MC37X37IG2                 | 37.1 x 35.8        | 1.46 x 1.41 | 0.20       | 5.0 | C37IG2                        | 20                           | 20                               |
| MC37X50IG2                 | 37.1 x 47.8        | 1.46 x 1.88 | 0.20       | 5.0 | C37IG2                        | 20                           | 20                               |
| MC37X62IG2                 | 37.1 x 59.7        | 1.46 x 2.35 | 0.20       | 5.0 | C37IG2                        | 20                           | 20                               |
| MC37X75IG2                 | 37.1 x 72.4        | 1.46 x 2.85 | 0.20       | 5.0 | C37IG2                        | 20                           | 20                               |
| MC50X50IG2                 | 49.5 x 47.8        | 1.95 x 1.89 | 0.20       | 5.0 | C50IG2                        | 20                           | 20                               |
| MC50X75IG2                 | 49.5 x 72.4        | 1.95 x 2.85 | 0.20       | 5.0 | C50IG2                        | 10                           | 20                               |
| MC50X100IG2                | 49.5 x 97.8        | 1.95 x 3.85 | 0.20       | 5.0 | C50IG2                        | 10                           | 20                               |
| MC62X62IG2                 | 62.0 x 59.7        | 2.44 x 2.35 | 0.20       | 5.0 | C62IG2                        | 20                           | 20                               |
| MC75X50IG2                 | 74.7 x 48.0        | 2.94 x 1.89 | 0.20       | 5.0 | C75IG2                        | 20                           | 20                               |
| MC75X62IG2                 | 74.7 x 59.7        | 2.94 x 2.35 | 0.20       | 5.0 | C75IG2                        | 20                           | 20                               |
| MC75X75IG2                 | 74.7 x 72.4        | 2.94 x 2.85 | 0.20       | 5.0 | C75IG2                        | 10                           | 20                               |
| MC75X100IG2                | 74.7 x 97.8        | 2.94 x 3.85 | 0.20       | 5.0 | C75IG2                        | 10                           | 20                               |
| MC100X50IG2                | 99.6 x 48.0        | 3.92 x 1.89 | 0.20       | 5.0 | C100IG2                       | 10                           | 20                               |
| MC100X75IG2                | 99.6 x 72.4        | 3.92 x 2.85 | 0.20       | 5.0 | C100IG2                       | 10                           | 20                               |
| MC100X100IG2               | 99.6 x 97.8        | 3.92 x 3.85 | 0.20       | 5.0 | C100IG2                       | 10                           | 20                               |

Available in IG (International Gray) and WH (White) colors.  
Base and cover sold together.  
\*H" dimension includes duct and cover.

A. System Overview

B1. Cable Ties

B2. Cable Accessories

B3. Stainless Steel Ties

C1. Wiring Duct

C2. Surface Raceway

C3. Abrasion Protection

C4. Cable Management

D1. Terminals

D2. Power Connectors

D3. Grounding Connectors

E1. Labeling Systems

E2. Labels

E3. Pre-Printed & Write-On Markers

E4. Permanent Identification

E5. Lockout/Tagout & Safety Solutions

F. Index



A. System Overview

## Features and Benefits – Panduct® Type FS Solid Wall Raceway

Available in 27 sizes from .5" x .5" up to 6" x 4" in a variety of colors.

B1. Cable Ties

B2. Cable Accessories

B3. Stainless Steel Ties

C1. Wiring Duct

C2. Surface Raceway

C3. Abrasion Protection

C4. Cable Management

D1. Terminals

D2. Power Connectors

D3. Grounding Connectors

E1. Labeling Systems

E2. Labels

E3. Pre-Printed & Write-On Markers

E4. Permanent Identification

E5. Lockout/Tagout & Safety Solutions

F. Index

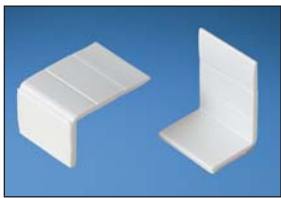
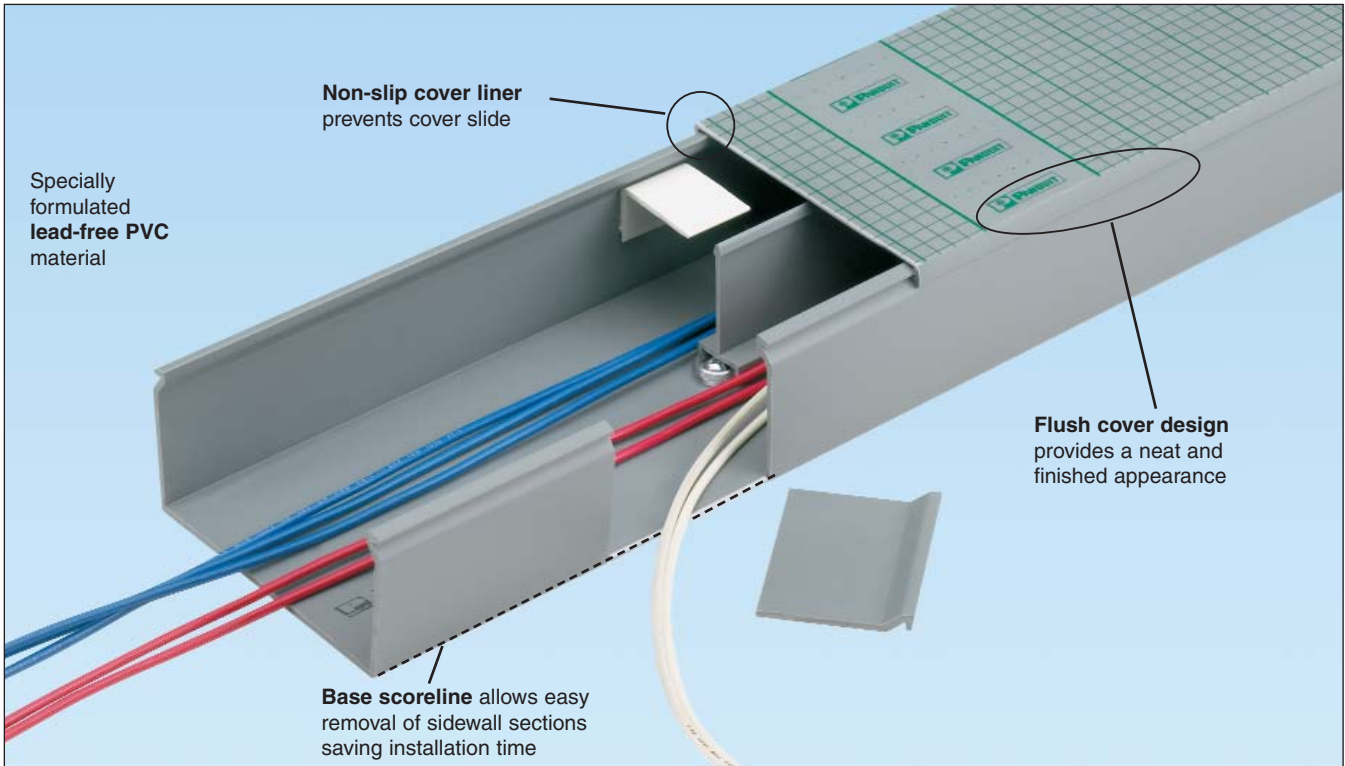

**Panduct® Wire Retainers for Type FS Solid Wall Raceway**  
Contain wiring when duct cover is opened. Wire retainers mount onto walls with pressure sensitive adhesive. (see page C1.28)



**Panduct® Divider Wall**  
Create separate wiring channels within the wiring duct base. Available in solid or slotted wall styles. (see page C1.26)

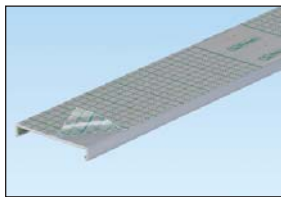

**Panduct® Type C Cover with Protective Film**  
Reduces scrap and labor costs by protecting the surface during storage, handling, and installation. (see page C1.21)



**Panduct® Nylon Rivets**  
Fast, lowest cost mounting method. (see page C1.34)



**Panduct® Installation Tools**  
Wide selection of hand tools for cutting and installing wiring duct. (see page C1.34)

## Panduit® Type FS Solid Wall Raceway

- Solid wall design fully encloses cables providing maximum protection and aesthetics
- Material: Lead-free PVC

- UL recognized continuous use temperature: 122°F (50°C)
- UL 94 flammability rating of V-0
- Base and cover length is 6 feet

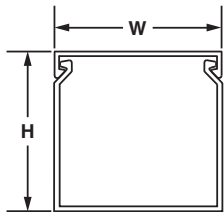
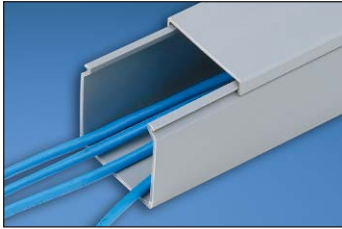

| Base Part Number | Duct Size (W x H)* |               | Cover Part Number | Std. Pkg. Qty. | Base Ctn. Qty. | Cover Ctn. Qty. |
|------------------|--------------------|---------------|-------------------|----------------|----------------|-----------------|
|                  | In.                | mm            |                   |                |                |                 |
| > FS.5X.5LG6NM   | .69 x .60          | 17.5 x 15.2   | C.5LG6            | 6              | 120            | 120             |
| > FS.5X1LG6NM    | .69 x 1.06         | 17.5 x 26.9   | C.5LG6            | 6              | 120            | 120             |
| > FS.75X.75LG6NM | .93 x .82          | 23.6 x 20.8   | C.75LG6           | 6              | 120            | 120             |
| > FS1X1LG6NM     | 1.26 x 1.12        | 32.0 x 28.4   | C1LG6             | 6              | 120            | 120             |
| > FS1X1.5LG6NM   | 1.26 x 1.62        | 32.0 x 41.1   | C1LG6             | 6              | 120            | 120             |
| > FS1X2LG6NM     | 1.26 x 2.12        | 32.0 x 53.8   | C1LG6             | 6              | 120            | 120             |
| > FS1X3LG6NM     | 1.26 x 3.12        | 32.0 x 79.2   | C1LG6             | 6              | 120            | 120             |
| > FS1X4LG6NM     | 1.26 x 4.10        | 32.0 x 104.1  | C1LG6             | 6              | 60             | 120             |
| > FS1.5X1LG6NM   | 1.75 x 1.12        | 44.5 x 28.4   | C1.5LG6           | 6              | 120            | 120             |
| > FS1.5X1.5LG6NM | 1.75 x 1.62        | 44.5 x 41.1   | C1.5LG6           | 6              | 120            | 120             |
| > FS1.5X2LG6NM   | 1.75 x 2.12        | 44.5 x 53.8   | C1.5LG6           | 6              | 120            | 120             |
| > FS1.5X3LG6NM   | 1.75 x 3.12        | 44.5 x 79.2   | C1.5LG6           | 6              | 120            | 120             |
| > FS2X1LG6NM     | 2.25 x 1.12        | 57.2 x 28.4   | C2LG6             | 6              | 120            | 120             |
| > FS2X1.5LG6NM   | 2.25 x 1.62        | 57.2 x 41.1   | C2LG6             | 6              | 120            | 120             |
| > FS2X2LG6NM     | 2.25 x 2.12        | 57.2 x 53.8   | C2LG6             | 6              | 120            | 120             |
| > FS2X3LG6NM     | 2.25 x 3.12        | 57.2 x 79.2   | C2LG6             | 6              | 60             | 120             |
| > FS2X4LG6NM     | 2.25 x 4.10        | 57.2 x 104.1  | C2LG6             | 6              | 60             | 120             |
| > FS3X1LG6NM     | 3.25 x 1.12        | 82.6 x 28.4   | C3LG6             | 6              | 120            | 120             |
| > FS3X2LG6NM     | 3.25 x 2.12        | 82.6 x 53.8   | C3LG6             | 6              | 120            | 120             |
| > FS3X3LG6NM     | 3.25 x 3.12        | 82.6 x 79.2   | C3LG6             | 6              | 60             | 120             |
| > FS3X4LG6NM     | 3.25 x 4.10        | 82.6 x 104.1  | C3LG6             | 6              | 60             | 120             |
| > FS3X5LG6NM     | 3.25 x 5.10        | 82.6 x 129.5  | C3LG6             | 6              | 60             | 120             |
| > FS4X2LG6NM     | 4.25 x 2.12        | 108.0 x 53.8  | C4LG6             | 6              | 60             | 120             |
| > FS4X3LG6NM     | 4.25 x 3.12        | 108.0 x 79.2  | C4LG6             | 6              | 60             | 120             |
| > FS4X4LG6NM     | 4.25 x 4.10        | 108.0 x 104.1 | C4LG6             | 6              | 60             | 120             |
| > FS4X5LG6NM     | 4.25 x 5.10        | 108.0 x 129.5 | C4LG6             | 6              | 60             | 120             |
| > FS6X4LG6NM     | 6.25 x 4.15        | 158.8 x 105.4 | C6LG6             | 6              | 60             | 120             |

>Parts are available with mounting holes. To order with mounting holes, remove NM from part number. Part Number shown for LG (Light Gray). For other color availability see Color Selection Guide, page C1.48. Base and cover sold separately.

\*"H" dimension includes duct and cover.

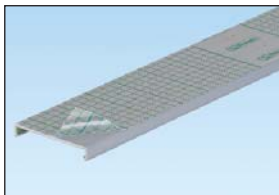

To order cover with protective film add "-F" to part number. 6" cover not available with film.

A. System Overview

B1. Cable Ties

B2. Cable Accessories

B3. Stainless Steel Ties

C1. Wiring Duct

C2. Surface Raceway

C3. Abrasion Protection

C4. Cable Management

D1. Terminals

D2. Power Connectors

D3. Grounding Connectors

E1. Labeling Systems

E2. Labels

E3. Pre-Printed & Write-On Markers

E4. Permanent Identification

E5. Lockout/Tagout & Safety Solutions

F. Index



A. System Overview

## Wiring Duct for Special Environments

B1. Cable Ties

### Features and Benefits – Panduct® Type NNC Halogen-Free Metric Wiring Duct

Available in fourteen sizes from 25mm x 25mm up to 100mm x 100mm in light gray and white.

B2. Cable Accessories

B3. Stainless Steel Ties

C1. Wiring Duct

C2. Surface Raceway

C3. Abrasion Protection

C4. Cable Management

D1. Terminals

D2. Power Connectors

D3. Grounding Connectors

E1. Labeling Systems

E2. Labels

E3. Pre-Printed & Write-On Markers

E4. Permanent Identification

E5. Lockout/Tagout & Safety Solutions

F. Index

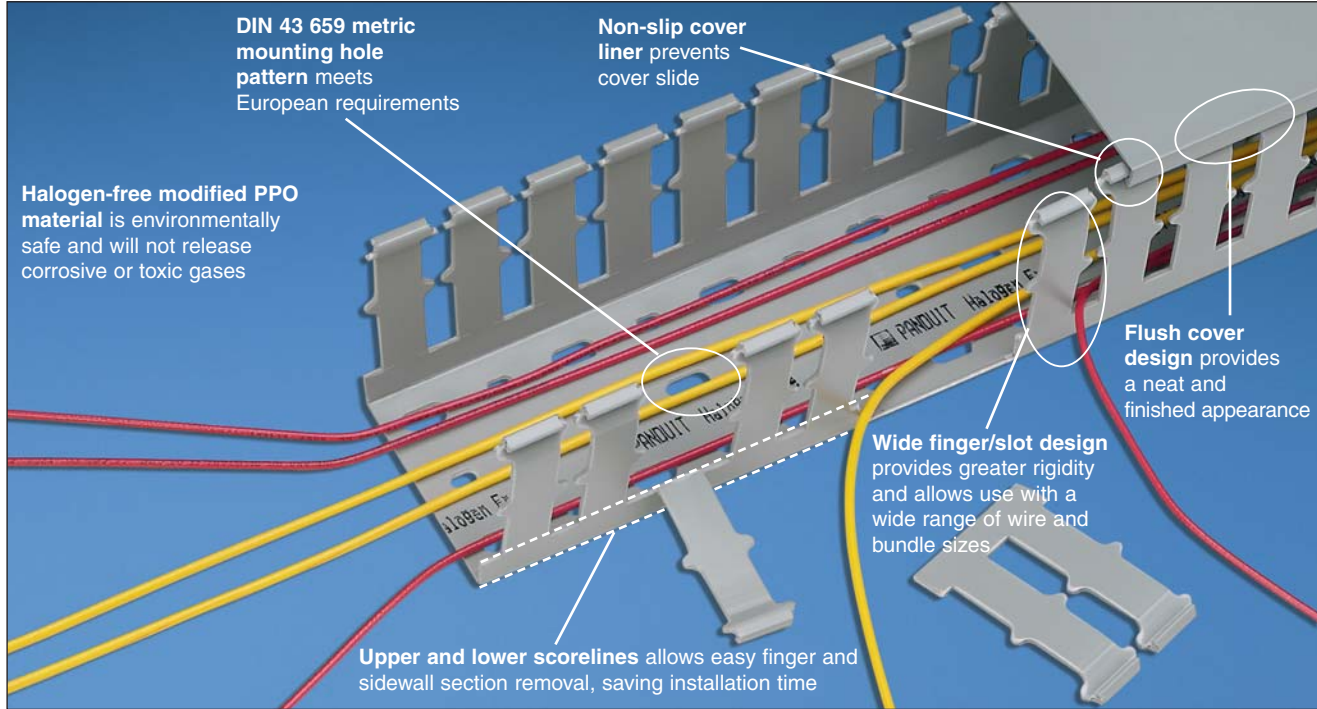

**Panduct® Type NNC Halogen-Free Solid Divider Wall**  
Create separate wiring channels within the wiring duct base. (see page C1.23)



**Panduct® Nylon Rivets**  
Fast, lowest cost mounting method. (see page C1.34)



**Panduct® Installation Tools**  
Wide selection of hand tools for cutting and installing wiring duct. (see page C1.34)

## UL® SP® C E Panduct® Type NNC Halogen-Free Metric Wiring Duct

- Material: Halogen-free modified polyphenylene oxide (mPPO) material as verified with IEC 60754-2 test method (test on gases evolved during combustion of electric cables)
- UL recognized continuous use temperature: 203°F (95°C)
- UL 94 flammability rating of V-0

- Conforms with NFPA 79-2007 section 13.3.1 requirement for flame retardant material
- Provided with DIN 43 659 mounting holes
- Metric sizing and finger progression
- Duct and cover packaged together in two meter lengths

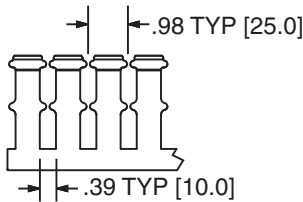
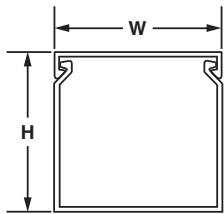
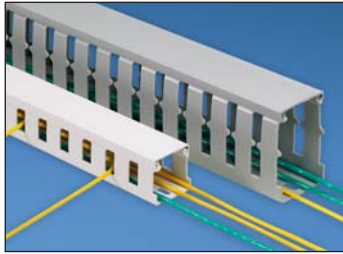

Multiple slot restrictors present with 75mm and greater duct wall height.

| Base and Cover Part Number | Duct Size (W x H)* |             | Slot Width |      | Replacement Cover Part Number | Base and Cover Ctn. Qty. (m) | Replacement Cover Ctn. Qty. (m) |
|----------------------------|--------------------|-------------|------------|------|-------------------------------|------------------------------|---------------------------------|
|                            | mm                 | In.         | In.        | mm   |                               |                              |                                 |
| NNC25X25LG2                | 24.6 x 23.6        | .97 x .93   | .39        | 10.0 | NC25LG2                       | 20                           | 20                              |
| NNC25X37LG2                | 24.6 x 35.8        | .97 x 1.41  | .39        | 10.0 | NC25LG2                       | 20                           | 20                              |
| NNC25X50LG2                | 24.6 x 47.8        | .97 x 1.88  | .39        | 10.0 | NC25LG2                       | 20                           | 20                              |
| NNC25X75LG2                | 24.6 x 72.4        | .97 x 2.85  | .39        | 10.0 | NC25LG2                       | 20                           | 20                              |
| NNC37X37LG2                | 37.1 x 35.8        | 1.46 x 1.41 | .39        | 10.0 | NC37LG2                       | 20                           | 20                              |
| NNC37X50LG2                | 37.1 x 47.8        | 1.46 x 1.88 | .39        | 10.0 | NC37LG2                       | 20                           | 20                              |
| NNC37X75LG2                | 37.1 x 72.4        | 1.46 x 2.85 | .39        | 10.0 | NC37LG2                       | 20                           | 20                              |
| NNC50X50LG2                | 49.5 x 47.8        | 1.95 x 1.88 | .39        | 10.0 | NC50LG2                       | 20                           | 20                              |
| NNC50X75LG2                | 49.5 x 72.4        | 1.95 x 2.85 | .39        | 10.0 | NC50LG2                       | 10                           | 20                              |
| NNC50X100LG2               | 49.5 x 97.8        | 1.95 x 3.85 | .39        | 10.0 | NC50LG2                       | 10                           | 20                              |
| NNC75X75LG2                | 74.7 x 72.4        | 2.94 x 2.85 | .39        | 10.0 | NC75LG2                       | 10                           | 20                              |
| NNC100X50LG2               | 99.6 x 47.8        | 3.92 x 1.88 | .39        | 10.0 | NC100LG2                      | 10                           | 20                              |
| NNC100X75LG2               | 99.6 x 72.4        | 3.92 x 2.85 | .39        | 10.0 | NC100LG2                      | 10                           | 20                              |
| NNC100X100LG2              | 99.6 x 97.8        | 3.92 x 3.85 | .39        | 10.0 | NC100LG2                      | 10                           | 20                              |

Available in LG (Light Gray) and WH (White).

Do not allow cutting, tapping, or cleaning fluids that contain hydrocarbons to come in contact with type NNC wiring duct as it will cause stress cracking. See page C1.49 for a list of chemicals to avoid.

\*"H" dimension includes duct and cover.

## Panduct® Type NNC Divider Wall

- NNC solid divider wall can be mounted inside NNC and NE wiring duct to create multiple channels
- Material: Halogen-free modified polyphenylene oxide (mPPO)

- Simply install the divider wall base when mounting the duct and snap the divider wall onto mounting base, DB-C



| Part Number | Length (m) | For Nominal Duct Height (mm) | Std. Pkg. Qty. | Std. Ctn. Qty. (m) |
|-------------|------------|------------------------------|----------------|--------------------|
| NNC50DWH2   | 2          | 50                           | 2              | 40                 |
| NNC75DWH2   | 2          | 75                           | 2              | 40                 |

Available in WH (White) color only.

NOTE: Must be used with mounting base DB-C (see page C1.26), which is sold separately. Install mounting bases to the duct channel, locate within 2" of each divider wall end and at least every 12" along the length.

A. System Overview

B1. Cable Ties

B2. Cable Accessories

B3. Stainless Steel Ties

C1. Wiring Duct

C2. Surface Raceway

C3. Abrasion Protection

C4. Cable Management

D1. Terminals

D2. Power Connectors

D3. Grounding Connectors

E1. Labeling Systems

E2. Labels

E3. Pre-Printed & Write-On Markers

E4. Permanent Identification

E5. Lockout/Tagout & Safety Solutions

F. Index

A. System Overview

## Panduit® Type NE Halogen-Free Wiring Duct

B1. Cable Ties

- Material: Halogen-free modified polyphenylene oxide (mPPO)
- UL recognized continuous use temperature: 203°F (95°C)
- UL 94 flammability rating of V-0
- Provided with mounting holes
- Base and cover length is 6 feet

B2. Cable Accessories



B3. Stainless Steel Ties

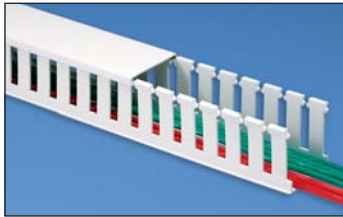

C1. Wiring Duct

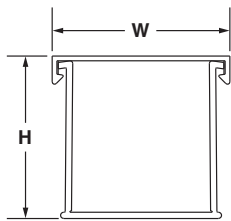

C2. Surface Raceway

C3. Abrasion Protection

C4. Cable Management

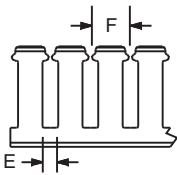

|                       | E          | F            |
|-----------------------|------------|--------------|
| For .5" duct height:  | .37" [9.4] | .80" [20.3]  |
| 1" to 2" duct height: | .31" [7.9] | .80" [20.3]  |
| 3" to 4" duct height: | .31" [7.9] | 1.00" [25.4] |
| 5" duct height:       | .38" [9.4] | 1.33" [33.8] |

D1. Terminals

D2. Power Connectors

D3. Grounding Connectors

E1. Labeling Systems

E2. Labels

E3. Pre-Printed & Write-On Markers

E4. Permanent Identification

E5. Lockout/Tagout & Safety Solutions

F. Index

| Base Part Number | Duct Size (W x H)* |               | Slot Width |     | Cover Part Number | Std. Pkg. Qty. | Base Ctn. Qty. | Cover Ctn. Qty. |
|------------------|--------------------|---------------|------------|-----|-------------------|----------------|----------------|-----------------|
|                  | In.                | mm            | In.        | mm  |                   |                |                |                 |
| NE.5X.5WH6       | .63 x .56          | 16.0 x 14.2   | .38        | 9.7 | NC.5WH6           | 6              | 120            | 120             |
| NE.5X1WH6        | .63 x 1.06         | 16.0 x 26.9   | .31        | 7.9 | NC.5WH6           | 6              | 120            | 120             |
| NE1X1WH6         | 1.14 x 1.06        | 29.0 x 26.9   | .31        | 7.9 | NC1WH6            | 6              | 120            | 120             |
| NE1X1.5WH6       | 1.14 x 1.62        | 29.0 x 41.1   | .31        | 7.9 | NC1WH6            | 6              | 120            | 120             |
| NE1X2WH6         | 1.14 x 2.06        | 29.0 x 52.3   | .31        | 7.9 | NC1WH6            | 6              | 120            | 120             |
| NE1X3WH6         | 1.14 x 3.06        | 29.0 x 77.7   | .31        | 7.9 | NC1WH6            | 6              | 120            | 120             |
| NE1X4WH6         | 1.14 x 4.06        | 29.0 x 103.1  | .31        | 7.9 | NC1WH6            | 6              | 60             | 120             |
| NE1.5X1.5WH6     | 1.64 x 1.62        | 41.7 x 41.1   | .31        | 7.9 | NC1.5WH6          | 6              | 120            | 120             |
| NE1.5X2WH6       | 1.64 x 2.06        | 41.7 x 52.3   | .31        | 7.9 | NC1.5WH6          | 6              | 120            | 120             |
| NE1.5X3WH6       | 1.64 x 3.06        | 41.7 x 77.7   | .31        | 7.9 | NC1.5WH6          | 6              | 120            | 120             |
| NE1.5X4WH6       | 1.64 x 4.06        | 41.7 x 103.1  | .31        | 7.9 | NC1.5WH6          | 6              | 60             | 120             |
| NE2X1WH6         | 2.14 x 1.06        | 54.4 x 26.9   | .31        | 7.9 | NC2WH6            | 6              | 120            | 120             |
| NE2X2WH6         | 2.14 x 2.06        | 54.4 x 52.3   | .31        | 7.9 | NC2WH6            | 6              | 120            | 120             |
| NE2X3WH6         | 2.14 x 3.06        | 54.4 x 77.7   | .31        | 7.9 | NC2WH6            | 6              | 60             | 120             |
| NE2X4WH6         | 2.14 x 4.06        | 54.4 x 103.1  | .31        | 7.9 | NC2WH6            | 6              | 60             | 120             |
| NE3X1WH6         | 3.14 x 1.06        | 79.8 x 26.9   | .31        | 7.9 | NC3WH6            | 6              | 120            | 120             |
| NE3X2WH6         | 3.14 x 2.06        | 79.8 x 52.3   | .31        | 7.9 | NC3WH6            | 6              | 120            | 120             |
| NE3X3WH6         | 3.14 x 3.06        | 79.8 x 77.7   | .31        | 7.9 | NC3WH6            | 6              | 60             | 120             |
| NE3X4WH6         | 3.14 x 4.06        | 79.8 x 103.1  | .31        | 7.9 | NC3WH6            | 6              | 60             | 120             |
| NE3X5WH6         | 3.14 x 5.06        | 79.8 x 128.5  | .38        | 9.7 | NC3WH6            | 6              | 60             | 120             |
| NE4X2WH6         | 4.14 x 2.06        | 105.2 x 52.3  | .31        | 7.9 | NC4WH6            | 6              | 60             | 120             |
| NE4X3WH6         | 4.14 x 3.06        | 105.2 x 77.7  | .31        | 7.9 | NC4WH6            | 6              | 60             | 120             |
| NE4X4WH6         | 4.14 x 4.06        | 105.2 x 103.1 | .31        | 7.9 | NC4WH6            | 6              | 60             | 120             |
| NE4X5WH6         | 4.14 x 5.06        | 105.2 x 128.5 | .38        | 9.7 | NC4WH6            | 6              | 60             | 120             |

Available in WH (White) only.

Do not allow cutting, tapping, or cleaning fluids that contain hydrocarbons to come in contact with type NE wiring duct as it will cause stress cracking. See page C1.49 for list of chemicals to avoid.

Base and cover sold separately.

\*\*H" dimension includes duct and cover.

## WIRING DUCT TOOLS AND ACCESSORIES

Panduit offers a selection of Panduit® Tools and Accessories to aid cutting, modifying, and installing wiring duct.



Some of the features and benefits found in Panduit® Tools and Accessories include:

- Wide selection of hand tools for cutting and installing wiring duct
- Snap-in wire retainers to retain cabling when the cover is removed or during cable installation
- Divider walls that mount within the duct, enabling multiple channels to be created within a duct channel
- Corner strips hold corners rigid at t-junctions in control panel applications
- Mounting clips provide an alternative method to mount the duct and allow the duct to be more easily removed

A.  
System  
Overview

B1.  
Cable Ties

B2.  
Cable  
Accessories

B3.  
Stainless  
Steel Ties

C1.  
Wiring  
Duct

C2.  
Surface  
Raceway

C3.  
Abrasion  
Protection

C4.  
Cable  
Management

D1.  
Terminals

D2.  
Power  
Connectors

D3.  
Grounding  
Connectors

E1.  
Labeling  
Systems

E2.  
Labels

E3.  
Pre-Printed  
& Write-On  
Markers

E4.  
Permanent  
Identification

E5.  
Lockout/  
Tagout  
& Safety  
Solutions

F.  
Index



A. System Overview

## Panduit® Type FL Flexible Wiring Duct

B1. Cable Ties

- Material: Flexible Polypropylene
- UL 94 flammability rating of V-2
- UL Recognized continuous use temperature: 149°F (65°C)
- Factory applied adhesive tape provided for easy mounting

B2. Cable Accessories



B3. Stainless Steel Ties

| Part Number | Duct Size (W x H)* |             | Length |     | Std. Pkg. Qty. |
|-------------|--------------------|-------------|--------|-----|----------------|
|             | In.                | mm          | In.    | mm  |                |
| FL12X12LG-A | .49 x .49          | 12.5 x 12.5 | 19.7   | 500 | 112            |
| FL25X25LG-A | .98 x .98          | 25.0 x 25.0 | 19.7   | 500 | 70             |
| FL50X50LG-A | 1.97 x 1.97        | 50.0 x 50.0 | 19.7   | 500 | 32             |

Available in LG (RAL 7040 Light Gray) color only. Unit of measure is pieces.  
\*\*"H" dimension includes duct and cover.

C1. Wiring Duct

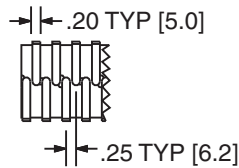
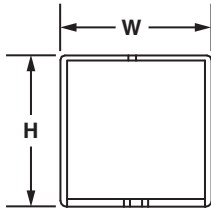

C2. Surface Raceway

C3. Abrasion Protection

## Panduit® Divider Wall

C4. Cable Management

- Wiring duct divider wall can be mounted inside any type of Panduit PVC wiring duct to create multiple channels
- Simply install the divider wall base when mounting the duct and snap the divider wall onto the mounting base
- All versions snap onto DB-C mounting base
- Meets UL508/508A insulation material requirement for barrier between conductors
- UL 94 flammability rating of V-0
- Material: Lead-free PVC
- Divider wall heights 2" and greater have a scoreline feature allowing sections to be removed leaving a smooth edge

D1. Terminals

D2. Power Connectors



DB-C

D3. Grounding Connectors

| Part Number                         | Used with Anchors                      | Std. Pkg. Qty. | Std. Ctn. Qty. |
|-------------------------------------|--|----------------|----------------|
| Panduit® Divider Wall Mounting Base |  |                |                |
| DB-C                                | Panduit NR1 or #8, #10, M4 or M5 screw | 100            | 1000           |

E1. Labeling Systems



D\*H6 and D\*H2

E2. Labels

E3. Pre-Printed & Write-On Markers

E4. Permanent Identification



SD\*H6

E5. Lockout/Tagout & Safety Solutions

F. Index

| Part Number                          | For Nominal Duct Height |     | Length |   | Color      | Std. Pkg. Qty. | Std. Ctn. Qty. |
|--------------------------------------|-------------------------|-----|--------|---|------------|----------------|----------------|
|                                      | In.                     | mm  | Ft.    | m |            |                |                |
| <b>Panduit® Solid Divider Wall</b>   |                         |     |        |   |            |                |                |
| D2H6                                 | 2.00                    | 50  | 6      | — | Light Gray | 6              | 120            |
| D3H6                                 | 3.00                    | 75  | 6      | — | Light Gray | 6              | 120            |
| D4H6                                 | 4.00                    | 100 | 6      | — | Light Gray | 6              | 120            |
| D2HWH6                               | 2.00                    | 50  | 6      | — | White      | 6              | 120            |
| D3HWH6                               | 3.00                    | 75  | 6      | — | White      | 6              | 120            |
| D4HWH6                               | 4.00                    | 100 | 6      | — | White      | 6              | 120            |
| <b>Panduit® Slotted Divider Wall</b> |                         |     |        |   |            |                |                |
| SD2H6                                | 2.00                    | 50  | 6      | — | Light Gray | 6              | 120            |
| SD3H6                                | 3.00                    | 75  | 6      | — | Light Gray | 6              | 120            |
| SD4H6                                | 4.00                    | 100 | 6      | — | Light Gray | 6              | 120            |
| SD2HWH6                              | 2.00                    | 50  | 6      | — | White      | 6              | 120            |
| SD3HWH6                              | 3.00                    | 75  | 6      | — | White      | 6              | 120            |
| SD4HWH6                              | 4.00                    | 100 | 6      | — | White      | 6              | 120            |

Note: Must be used with mounting base, DB-C (see page C1.26) which is sold separately. Install mounting bases to the duct channel, locate within 2" of each divider wall end and at least every 12" along the length.



## Panduct® Type NNC Divider Wall

- NNC solid divider wall can be mounted inside NNC and NE wiring duct to create multiple channels
- Material: Halogen-free modified polyphenylene oxide (mPPO)

- Simply install the divider wall base when mounting the duct and snap the divider wall onto mounting base, DB-C



| Part Number | For Nominal Duct Height |    | Std. Pkg. Qty. | Std. Ctn. Qty. |
|-------------|-------------------------|----|----------------|----------------|
|             | In.                     | mm |                |                |
| NNC50DWH2   | 2.00                    | 50 | 2              | 40             |
| NNC75DWH2   | 3.00                    | 75 | 2              | 40             |

Available in WH (White) color only.

NOTE: Must be used with mounting base DB-C (see page C1.26), which is sold separately. Install mounting bases to the duct channel, locate within 2" of each divider wall end and at least every 12" along the length.

A.  
System  
Overview

B1.  
Cable Ties

B2.  
Cable  
Accessories

B3.  
Stainless  
Steel Ties

C1.  
Wiring  
Duct

C2.  
Surface  
Raceway

C3.  
Abrasion  
Protection

C4.  
Cable  
Management

D1.  
Terminals

D2.  
Power  
Connectors

D3.  
Grounding  
Connectors

E1.  
Labeling  
Systems

E2.  
Labels

E3.  
Pre-Printed  
& Write-On  
Markers

E4.  
Permanent  
Identification

E5.  
Lockout/  
Tagout  
& Safety  
Solutions

F.  
Index

A.  
System  
Overview

## Panduit® Type G and H Wiring Duct Wire Retainers

B1.  
Cable Ties

- Insert between fingers of type G and H to contain wiring when cover is removed
- Adjustable height
- Material: ABS

B2.  
Cable  
Accessories



B3.  
Stainless  
Steel Ties

| Part Number | For Duct Width<br>In. (mm) | For Duct Height<br>In. (mm) | Std.<br>Pkg.<br>Qty. | Std.<br>Ctn.<br>Qty. |
|-------------|----------------------------|-----------------------------|----------------------|----------------------|
| WR2-C       | 2.00 (50.8)                | 2.00 – 4.00 (50.8 – 101.6)  | 100                  | 1000                 |
| WR2H-C      | 2.00 (50.8)                | 2.00 – 4.00 (50.8 – 101.6)  | 100                  | 1000                 |
| WR3-C       | 3.00 (76.2)                | 2.00 – 4.00 (50.8 – 101.6)  | 100                  | 1000                 |
| WR4-C       | 4.00 (101.6)               | 2.00 – 4.00 (50.8 – 101.6)  | 100                  | 1000                 |
| WR5-C       | Use with: 3x5, 4x5, or 6x4 |                             | 100                  | 1000                 |

\*For 2" width type H hinged cover wiring duct use part number WR2H-C.

C1.  
Wiring  
Duct



C2.  
Surface  
Raceway

C3.  
Abrasion  
Protection

## Panduit® Solid Wall Raceway Type FS and Type D Wiring Duct Wire Retainer

C4.  
Cable  
Management

- Mounts onto walls of type FS raceway or type D duct with pressure sensitive adhesive
- One size fits three different duct widths
- Full length is used with 2 inch wide duct; for small widths, break off segments at scorelines
- Material: Lead-free PVC

D1.  
Terminals

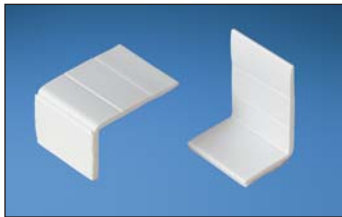

D2.  
Power  
Connectors

| Part Number | For Duct Width<br>In. (mm) | Std.<br>Pkg.<br>Qty. | Std.<br>Ctn.<br>Qty. |
|-------------|----------------------------|----------------------|----------------------|
| WRS-A-C10   | 1.00 (25.4)                | 100                  | 1000                 |
|             | 1.50 (38.1)                |                      |                      |
|             | 2.00 (50.8)                |                      |                      |

Full length is used with 2" wide duct. For smaller widths, break off segments at scorelines.

D3.  
Grounding  
Connectors

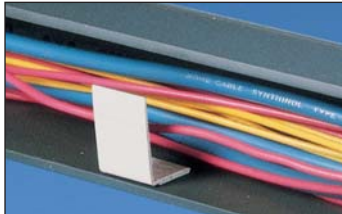

E1.  
Labeling  
Systems

E2.  
Labels

E3.  
Pre-Printed  
& Write-On  
Markers

E4.  
Permanent  
Identification

E5.  
Lockout/  
Tagout  
& Safety  
Solutions

F.  
Index

## Panduit® Type F, HN and MC Duct Wire Retainers/Labeling Device

- Used to contain wiring when cover is removed and can also be used as a labeling device
- FWR-C is compatible with type F and HN duct sizes
- FMWR-C is compatible with type MC duct sizes
- Material: Lead-free PVC



| Part Number | Material  | For Duct Width |              | Std. Pkg. Qty. | Std. Ctn. Qty. |
|-------------|-----------|----------------|--------------|----------------|----------------|
|             |           | In.            | mm           |                |                |
| FWR-C       | Rigid PVC | 1.50 – 4.00    | 37.0 – 76.2  | 100            | 1000           |
| FMWR-C      | Rigid PVC | 1.46 – 3.94    | 37.0 – 100.0 | 100            | 1000           |

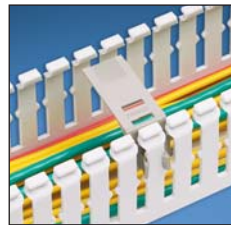

**Labeling Inside Duct –**  
Snaps onto duct fingers. Full length for use with 4" wide duct. For smaller widths, break off segments at scorelines.

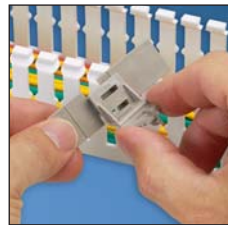

**Labeling Outside Duct –**  
Break off the last segment from wire retainer below 1.5" mark and snap onto the back of the remaining segment. Install label and mount between fingers facing outward.

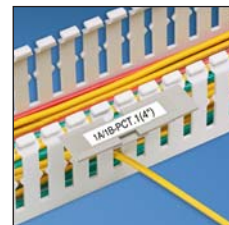

## Panduit® Duct Corner Strip with 1" Bend Radius Control

- Create a strong rigid corner at wiring duct junctions
- Provide bend radius protection for cabling as required in NFPA 79-2007 section 13.1.5.9 and TIA/EIA-568-B and 569-A
- Available in 6 foot lengths that can be cut to size to meet any size requirement
- Easy to install two-piece design
- Compatible with all styles of Panduit wiring duct
- UL 94 flammability rating of V-0
- Material: Lead-free PVC

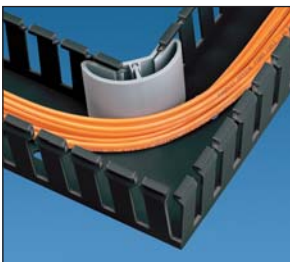

| Part Number | Part Description | For Duct Height |    | Color | Std. Pkg. Qty. | Std. Ctn. Qty. |
|-------------|------------------|-----------------|----|-------|----------------|----------------|
|             |                  | In.             | mm |       |                |                |

### 6' Lengths for use with all Types of PVC Wiring Duct

|                |  |                            |                            |            |   |     |
|----------------|--|----------------------------|----------------------------|------------|---|-----|
| <b>CSC1LG6</b> | Cut-to-size 6 foot corner strip with a 1" bend radius. | All sizes (Cut to height)* | All sizes (Cut to height)* | Light Gray | 6 | 120 |
|----------------|--|----------------------------|----------------------------|------------|---|-----|

Order number of feet required, in multiples of 6' or Standard Package Quantity.  
\*Refer to Cutting Guide on page C1.30.

A.  
System  
Overview

B1.  
Cable Ties

B2.  
Cable  
Accessories

B3.  
Stainless  
Steel Ties

C1.  
Wiring  
Duct

C2.  
Surface  
Raceway

C3.  
Abrasion  
Protection

C4.  
Cable  
Management

D1.  
Terminals

D2.  
Power  
Connectors

D3.  
Grounding  
Connectors

E1.  
Labeling  
Systems

E2.  
Labels

E3.  
Pre-Printed  
& Write-On  
Markers

E4.  
Permanent  
Identification

E5.  
Lockout/  
Tagout  
& Safety  
Solutions

F.  
Index

A. System Overview

## Panduct® Duct Corner Strip

B1. Cable Ties

- Slide onto duct at corner or t-junctions for smooth, round corners
- Available in 6 foot lengths that can be cut to size to meet any requirement
- Easy to install one-piece design
- Compatible with all styles of Panduit wiring duct
- UL 94 flammability rating of V-0
- Material: Lead-free PVC

B2. Cable Accessories



CS1LG6

B3. Stainless Steel Ties

| Part Number   | Part Description                                 | For Nominal Duct Height    |                            | Color      | Std. Pkg. Qty. | Std. Ctn. Qty. |
|---|--|----------------------------|----------------------------|------------|----------------|----------------|
|   |  | In.                        | mm                         |            |                |                |
| <b>6' Lengths for use with all Types of PVC Wiring Duct</b> |  |                            |                            |            |                |                |
| CS1LG6  | 6 foot length is cut by user to fit duct height. | All sizes (Cut to height)* | All sizes (Cut to height)* | Light Gray | 6              | 120            |

\*Refer to Cutting Guide below.

C1. Wiring Duct

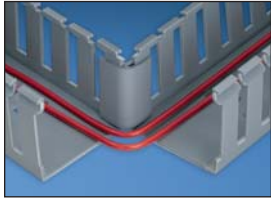

C2. Surface Raceway

C3. Abrasion Protection

C4. Cable Management

## Cutting Guide for Duct Corner Strips (CSC1\*\*6, CS1\*\*6)

D1. Terminals

D2. Power Connectors

D3. Grounding Connectors

| Used with Duct Height | Cut-to-Size*  | Used with Metric Duct Height | Cut-to-Size* |
|-----------------------|---------------|------------------------------|--------------|
| 1 inch                | .47" (11.9)   | 25mm                         | .43" (10.9)  |
| 1.5 inch              | 1.04" (26.4)  | 37mm                         | .91" (23.1)  |
| 2 inch                | 1.23" (31.2)  | 50mm                         | 1.39" (35.3) |
| 2.5 inch              | 1.97" (50.0)  | 62mm                         | 1.85" (47.0) |
| 3 inch                | 2.27" (57.7)  | 75mm                         | 2.38" (60.5) |
| 4 inch                | 3.25" (82.5)  | 100mm                        | 3.35" (85.1) |
| 5 inch                | 4.47" (113.5) |                              |              |

\*Cut-to-size measure fits into the flat area of the duct sidewall.

E1. Labeling Systems

E2. Labels

E3. Pre-Printed & Write-On Markers

E4. Permanent Identification

E5. Lockout/Tagout & Safety Solutions

F. Index

### Panduct® Snap-Clip Mounting Brackets

- Duct easily snaps into bracket
- No mounting holes required in duct
- Ensures no metal is inside the duct
- Snap-clip spacing is not critical
- Simplifies fabrication drawings and panel layout
- Material: Spring steel



| Part Number  | Screw Required              | For Duct Width |       | Std. Pkg. Qty. | Std. Ctn. Qty. |
|--|-----------------------------|----------------|-------|----------------|----------------|
|  |                             | In.            | mm    |                |                |
| <b>Snap-Clip Mounting Brackets for use with Types G, F, FS and D Wiring Duct</b> |                             |                |       |                |                |
| S1F-C  | #8-32 x 1/4 (Provided)      | 1.00           | 25.4  | 100            | 1000           |
| S1.5F-C  | #8-32 x 1/4 (Provided)      | 1.50           | 38.1  | 100            | 1000           |
| S2F-C  | #8-32 x 1/4 (Provided)      | 2.00           | 50.8  | 100            | 1000           |
| S3F-C  | #8-32 x 1/4 (Provided)      | 3.00           | 76.2  | 100            | 1000           |
| S4F-C  | #8-32 x 1/4 (Provided)      | 4.00           | 101.6 | 100            | 1000           |
| <b>Snap-Clip Mounting Brackets for use with Types MC and NNC Wiring Duct</b>     |                             |                |       |                |                |
| SNS25F-C   | #8-32 x 1/4 (User Supplied) | 1.00           | 25    | 100            | 1000           |
| SNS37F-C   | #8-32 x 1/4 (User Supplied) | 1.50           | 37    | 100            | 1000           |
| SNS50F-C   | #8-32 x 1/4 (User Supplied) | 2.00           | 50    | 100            | 1000           |
| SNS62F-C   | #8-32 x 1/4 (User Supplied) | 2.50           | 62    | 100            | 1000           |
| SNS75F-C   | #8-32 x 1/4 (User Supplied) | 3.00           | 75    | 100            | 1000           |

### Panduct® Snap-Clip Mounting Bracket – Type NE Wiring Duct

- Duct easily snaps into bracket
- Ensures no metal is inside the duct
- Snap-clip spacing is not critical
- Simplifies fabrication drawings and panel layout
- Material: Spring steel



| Part Number | Screw Required              | For Duct Width |      | Std. Pkg. Qty. | Std. Ctn. Qty. |
|-------------|-----------------------------|----------------|------|----------------|----------------|
|             |                             | In.            | mm   |                |                |
| SNS.5-C     | #6-32 x 1/4 (User Supplied) | .50            | 12.7 | 100            | 1000           |
| SNS.75-C    | #6-32 x 1/4 (User Supplied) | .75            | 19.1 | 100            | 1000           |
| SNS1-C      | #8-32 x 1/4 (User Supplied) | 1.00           | 25.4 | 100            | 1000           |
| SNS1.5-C    | #8-32 x 1/4 (User Supplied) | 1.50           | 38.1 | 100            | 1000           |
| SNS2-C      | #8-32 x 1/4 (User Supplied) | 2.00           | 50.8 | 100            | 1000           |
| SNS3-C      | #8-32 x 1/4 (User Supplied) | 3.00           | 76.2 | 100            | 1000           |

A.  
System  
Overview

B1.  
Cable Ties

B2.  
Cable  
Accessories

B3.  
Stainless  
Steel Ties

C1.  
Wiring  
Duct

C2.  
Surface  
Raceway

C3.  
Abrasion  
Protection

C4.  
Cable  
Management

D1.  
Terminals

D2.  
Power  
Connectors

D3.  
Grounding  
Connectors

E1.  
Labeling  
Systems

E2.  
Labels

E3.  
Pre-Printed  
& Write-On  
Markers

E4.  
Permanent  
Identification

E5.  
Lockout/  
Tagout/  
& Safety  
Solutions

F.  
Index



A.  
System  
Overview

### Adhesive Tape for Wiring Duct

B1.  
Cable Ties

- Recommended installation temperature is 70°F (21°C)
- Optimum recommended dwell time for acrylic adhesive is 8 hours
- UL Recognized service temperature is 32°F (0°C) to 140°F (60°C)
- Recommended tape load is 1/2 lb. per square inch of tape area

B2.  
Cable  
Accessories



B3.  
Stainless  
Steel Ties

| Duct Size<br>(W x H) | Tape<br>Part<br>Number | Roll<br>Length |      | Std.<br>Pkg.<br>Qty. | Std.<br>Ctn.<br>Qty. |
|----------------------|------------------------|----------------|------|----------------------|----------------------|
|                      |                        | Yds.           | m    |                      |                      |
| .5 x .5 thru 1.5 x 4 | P32W2A2-50-7           | 7.0            | 6.4  | 1                    | 100                  |
|                      | P32W2A2-50-72          | 72.0           | 65.5 | 1                    | 9                    |
| 2 x 1 thru 3 x 3     | P32W2A2-50-7           | 7.0            | 6.4  | 1                    | 100                  |
|                      | P32W2A2-50-72          | 72.0           | 65.5 | 1                    | 9                    |
| 3 x 4 thru 3 x 5     | P32W2A2-75-7           | 7.0            | 6.4  | 1                    | 60                   |
|                      | P32W2A2-75-72          | 72.0           | 65.5 | 1                    | 7                    |
| 4 x 1.5 thru 4 x 3   | P32W2A2-50-7           | 7.0            | 6.4  | 1                    | 100                  |
|                      | P32W2A2-75-72          | 72.0           | 65.5 | 1                    | 9                    |
| 4 x 4 thru 6 x 4     | P32W2A2-75-7           | 7.0            | 6.4  | 1                    | 60                   |
|                      | P32W2A2-75-72          | 72.0           | 65.5 | 1                    | 7                    |

C1.  
Wiring  
Duct

C2.  
Surface  
Raceway

C3.  
Abrasion  
Protection

### Specifications for Factory Applied Tape

C4.  
Cable  
Management

| Duct Size<br>(W x H)    | Rows of<br>Tape | Tape  |      |           |    |
|-------------------------|-----------------|-------|------|-----------|----|
|                         |                 | Width |      | Thickness |    |
|                         |                 | In.   | mm   | In.       | mm |
| .5 x .5 through .75 x 2 | 1               | .50   | 12.7 | .03       | .8 |
| 1 x 1 through 1.5 x 4   | 1               | .75   | 19.1 | .03       | .8 |
| 2 x 1 through 3 x 3     | 2               | .50   | 12.7 | .03       | .8 |
| 3 x 4 through 3 x 5     | 2               | .75   | 19.1 | .03       | .8 |
| 4 x 1.5 through 4 x 3   | 2               | .50   | 12.7 | .03       | .8 |
| 4 x 4 through 6 x 4     | 2               | .75   | 19.1 | .03       | .8 |

D1.  
Terminals

D2.  
Power  
Connectors

D3.  
Grounding  
Connectors

E1.  
Labeling  
Systems

E2.  
Labels

E3.  
Pre-Printed  
& Write-On  
Markers

E4.  
Permanent  
Identification

E5.  
Lockout/  
Tagout  
& Safety  
Solutions

F.  
Index

### Adhesive Tape Guide

Selection of wiring duct part numbers available with factory applied adhesive tape.



| G Duct Light Gray | G Duct White  | G Duct Black | F Duct Light Gray | F Duct White | FS Duct Light Gray | FS Duct White              | FS Duct Black  | NE Duct White |
|-------------------|---------------|--------------|-------------------|--------------|--------------------|----------------------------|----------------|---------------|
| G.5X.5LG6-A       | G.5X.5WH6-A   | —            | F.5X.5LG6-A       | —            | —                  | —                          | —              | —             |
| G.5X1LG6-A        | G.5X1WH6-A    | —            | F.5X1LG6-A        | —            | —                  | —                          | —              | —             |
| G.75X.75LG6-A     | —             | —            | F.75X.75LG6-A     | —            | —                  | —                          | —              | —             |
| G.75X1LG6-A       | G.75X1WH6-A   | —            | —                 | —            | —                  | —                          | —              | —             |
| G.75X1.5LG6-A     | G.75X1.5WH6-A | —            | F.75X1.5LG6-A     | —            | —                  | —                          | —              | —             |
| G.75X2LG6-A       | G.75X2WH6-A   | —            | —                 | —            | —                  | —                          | —              | —             |
| G1X1LG6-A         | G1X1WH6-A     | —            | F1X1LG6-A         | —            | —                  | FS1X1WH6-A<br>FS1X1WH6NM-A | —              | —             |
| G1X1.5LG6-A       | G1X1.5WH6-A   | —            | F1X1.5LG6-A       | —            | FS1X1.5LG6-A       | —                          | —              | —             |
| G1X2LG6-A         | G1X2WH6-A     | —            | F1X2LG6-A         | F1X2WH6-A    | —                  | —                          | —              | —             |
| G1X3LG6-A         | G1X3WH6-A     | G1X3BL6-A    | F1X3LG6-A         | F1X3WH6-A    | —                  | —                          | —              | —             |
| G1X4LG6-A         | G1X4WH6-A     | —            | F1X4LG6-A         | F1X4WH6-A    | —                  | —                          | —              | —             |
| G1.5X1LG6-A       | G1.5X1WH6-A   | —            | F1.5X1LG6-A       | —            | —                  | —                          | —              | —             |
| G1.5X1.5LG6-A     | G1.5X1.5WH6-A | —            | F1.5X1.5LG6-A     | —            | FS1.5X1.5LG6-A     | FS1.5X1.5WH6-A             | FS1.5X1.5BL6-A | —             |
| G1.5X2LG6-A       | G1.5X2WH6-A   | —            | F1.5X2LG6-A       | —            | —                  | —                          | —              | NE1.5X2WH6-A  |
| G1.5X3LG6-A       | G1.5X3WH6-A   | —            | F1.5X3LG6-A       | F1.5X3WH6-A  | —                  | —                          | —              | —             |
| G1.5X4LG6-A       | G1.5X4WH6-A   | —            | F1.5X4LG6-A       | F1.5X4WH6-A  | —                  | —                          | —              | —             |
| G2X1LG6-A         | G2X1WH6-A     | —            | F2X1LG6-A         | —            | —                  | —                          | —              | —             |
| G2X1.5LG6-A       | G2X1.5WH6-A   | —            | F2X1.5LG6-A       | —            | —                  | —                          | —              | —             |
| G2X2LG6-A         | G2X2WH6-A     | G2X2BL6-A    | F2X2LG6-A         | F2X2WH6-A    | —                  | —                          | —              | NE2X2WH6-A    |
| G2X3LG6-A         | G2X3WH6-A     | —            | F2X3LG6-A         | F2X3WH6-A    | —                  | —                          | —              | —             |
| G2X4LG6-A         | G2X4WH6-A     | G2X4BL6-A    | F2X4LG6-A         | F2X4WH6-A    | —                  | —                          | —              | —             |
| G2X5LG6-A         | G2X5WH6-A     | —            | F2X5LG6-A         | —            | —                  | —                          | —              | —             |
| G2.5X3LG6-A       | G2.5X3WH6-A   | —            | —                 | —            | —                  | —                          | —              | —             |
| G3X1LG6-A         | G3X1WH6-A     | —            | F3X1LG6-A         | —            | —                  | —                          | —              | —             |
| G3X2LG6-A         | G3X2WH6-A     | —            | F3X2LG6-A         | —            | —                  | —                          | —              | —             |
| G3X3LG6-A         | G3X3WH6-A     | G3X3BL6-A    | F3X3LG6-A         | F3X3WH6-A    | —                  | —                          | —              | —             |
| G3X4LG6-A         | G3X4WH6-A     | —            | F3X4LG6-A         | F3X4WH6-A    | —                  | —                          | —              | —             |
| G3X5LG6-A         | G3X5WH6-A     | —            | F3X5LG6-A         | —            | —                  | —                          | —              | —             |
| G4X1.5LG6-A       | G4X1.5WH6-A   | —            | —                 | —            | —                  | —                          | —              | —             |
| G4X2LG6-A         | G4X2WH6-A     | —            | F4X2LG6-A         | —            | —                  | —                          | —              | NE4X2WH6-A    |
| G4X3LG6-A         | G4X3WH6-A     | —            | F4X3LG6-A         | F4X3WH6-A    | —                  | —                          | —              | NE4X3WH6-A    |
| G4X4LG6-A         | G4X4WH6-A     | G4X4BL6-A    | F4X4LG6-A         | F4X4WH6-A    | —                  | —                          | —              | NE4X4WH6-A    |
| G4X5LG6-A         | G4X5WH6-A     | —            | F4X5LG6-A         | —            | —                  | —                          | —              | —             |
| —                 | —             | —            | —                 | —            | FS6X4LG6-A         | —                          | —              | —             |

All three sizes of flexible duct come provided with adhesive: FL12X12LG-A, FL25X25LG-A, FL50X50LG-A.

A.  
System  
Overview

B1.  
Cable Ties

B2.  
Cable  
Accessories

B3.  
Stainless  
Steel Ties

C1.  
Wiring  
Duct

C2.  
Surface  
Raceway

C3.  
Abrasion  
Protection

C4.  
Cable  
Management

D1.  
Terminals

D2.  
Power  
Connectors

D3.  
Grounding  
Connectors

E1.  
Labeling  
Systems

E2.  
Labels

E3.  
Pre-Printed  
& Write-On  
Markers

E4.  
Permanent  
Identification

E5.  
Lockout/  
Tagout  
& Safety  
Solutions

F.  
Index

A. System Overview

### Panduit® Installation Tools

B1. Cable Ties

- Panduit® Panduct® Bench Mount Wiring Duct Cutting Tool and Duct Cutting Tool easily cut Panduct® Wiring Duct and Cover
- DNT-100 notches duct sidewalls to bottom scoreline for tees and corner junctions

- TNR installs or removes Panduit nylon rivets, NR1-C and NR1-M, quickly and easily
- DFCT easily removes duct fingers in tight spaces

B2. Cable Accessories

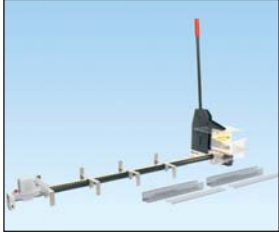

PBDCT

B3. Stainless Steel Ties

C1. Wiring Duct

C2. Surface Raceway



DCT



DFCT

C3. Abrasion Protection

C4. Cable Management



DNT-100



TNR

D1. Terminals



NR1

D2. Power Connectors

D3. Grounding Connectors

E1. Labeling Systems

E2. Labels

E3. Pre-Printed & Write-On Markers

E4. Permanent Identification

E5. Lockout/Tagout & Safety Solutions

F. Index

| Part Number | Part Description | Std. Pkg. Qty |
|-------------|------------------|---------------|
|-------------|------------------|---------------|

#### Duct Cutting Tools

|       |   |   |
|-------|---|---|
| PBDCT | Panduit bench-mount duct cutting tool. Cuts slotted wiring ducts and wiring duct covers with up to 6" width and up to 5" height. Full 78.74" (2 meter) measuring scale. Includes safety guarding. | 1 |
| DCT   | Hand-held duct cutting tool.  | 1 |

#### Replacement Blade Kit (includes blade and nylon insert)

|         |  |   |
|---------|--|---|
| DCT-BLD | Replacement blade kit with blade and nylon insert. | 1 |
|---------|--|---|

#### Replacement Nylon Insert

|        |                           |   |
|--------|---------------------------|---|
| DCT-RI | Replacement nylon insert. | 5 |
|--------|---------------------------|---|

#### Duct Finger Cutting Tool (For use with all wide slotted duct types)

|      |                                     |   |
|------|-------------------------------------|---|
| DFCT | Hand-held duct finger cutting tool. | 1 |
|------|-------------------------------------|---|

#### Duct Notching Tool (For use with all wide slotted duct types)

|         |                                   |   |
|---------|-----------------------------------|---|
| DNT-100 | Hand-held sidewall notching tool. | 1 |
|---------|-----------------------------------|---|

#### Nylon Rivet Installation Tool

|     |  |   |
|-----|--|---|
| TNR | Hand-held nylon rivet installation tool. | 1 |
|-----|--|---|

#### Nylon Rivets

|       |   |      |
|-------|---|------|
| NR1-C | Nylon rivet for use with TNR rivet tool.<br>Mean pull-off force PVC: 90 lbs. Type NE/Type NNC: 70 lbs.<br>Mean shear force: PVC 139 lbs. Type NE/Type NNC: 126 lbs. | 100  |
| NR1-M | Nylon rivet for use with TNR rivet tool.<br>Mean pull-off force PVC: 90 lbs. Type NE/Type NNC: 70 lbs.<br>Mean shear force: PVC 139 lbs. Type NE/Type NNC: 126 lbs. | 1000 |

Always use approved safety goggles when using any tools.

| Total Thickness of Panel and Duct |           | Panel Hole Dia. Needed |     | ANSI Standard Drill Bit |
|-----------------------------------|-----------|------------------------|-----|-------------------------|
| In.                               | mm        | In.                    | mm  |                         |
| .158 – .187                       | 4.0 – 4.7 | .187                   | 4.7 | #15                     |
| .188 – .218                       | 4.8 – 5.5 | .193                   | 4.9 | #11                     |
| .219 – .250                       | 5.6 – 6.4 | .203                   | 5.2 | #7                      |
| .251 – .281                       | 6.5 – 7.1 | .213                   | 5.4 | #4                      |

### Panduit® PanelMax™ DIN Rail Wiring Duct Dimensions

Dimensions are shown for reference only. Contact Panduit Customer Service at 800-777-3300 for specific dimensional needs.

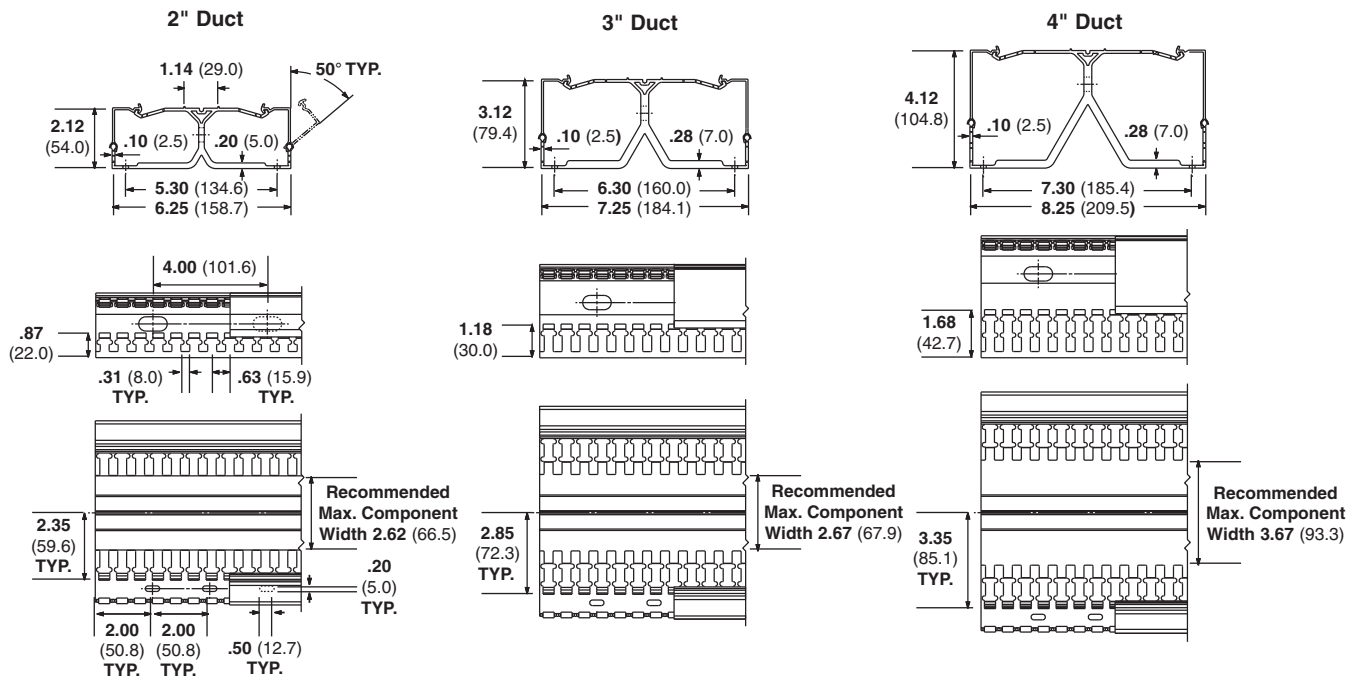

### Panduit® PanelMax™ Noise Shield Dimensions

Dimensions are shown for reference only. Contact Panduit Customer Service at 800-777-3300 for specific dimensional needs.

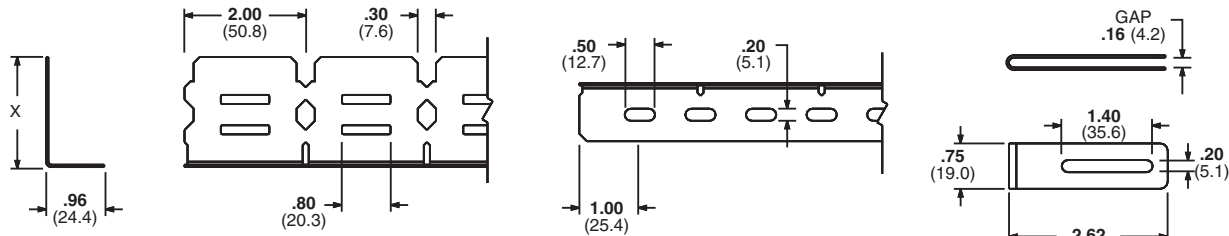

| Part No. | X           |
|----------|-------------|
| SD2EMI   | 1.82 (46.1) |
| SD3EMI   | 2.88 (73.2) |
| SD4EMI   | 3.86 (98.2) |

Sidewall: SD2EMI shown.  
SD3EMI, SD4EMI sidewall feature two pairs of cable tie slots per section.

Bottom view.

Bonding clip (for use with wiring duct).

All dimension shown in inches (mm).

### Panduit® PanelMax™ Corner Wiring Duct Dimensions

Dimensions are shown for reference only. Contact Panduit Customer Service at 800-777-3300 for specific dimensional needs.

| Size | Dimensions – Inches (mm) |             |             |              |              |              |           |              |              |
|------|--------------------------|-------------|-------------|--------------|--------------|--------------|-----------|--------------|--------------|
|      | A                        | C           | D           | G            | H            | K            | T         | W            | Z            |
| CWD3 | 4.98 (126.6)             | 2.25 (57.2) | 2.83 (71.8) | 3.10 (79.1)  | 3.57 (90.7)  | 3.95 (100.4) | .10 (2.4) | 4.40 (111.8) | 5.16 (131.0) |
| CWD4 | 5.94 (150.9)             | 2.25 (57.2) | 3.84 (97.5) | 4.10 (104.1) | 4.58 (115.7) | 4.89 (124.3) | .11 (2.7) | 5.33 (135.3) | 6.54 (166.0) |

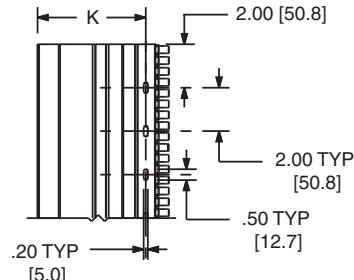
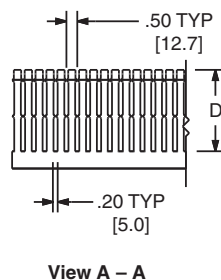
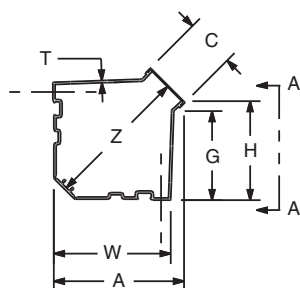

### Panduit® Type G and D Wiring Duct Dimensions

Dimensions are shown for reference only. Contact Panduit Customer Service at 800-777-3300 for specific dimensional needs.

A. System Overview

B1. Cable Ties

B2. Cable Accessories

B3. Stainless Steel Ties

C1. Wiring Duct

C2. Surface Raceway

C3. Abrasion Protection

C4. Cable Management

D1. Terminals

D2. Power Connectors

D3. Grounding Connectors

E1. Labeling Systems

E2. Labels

E3. Pre-Printed & Write-On Markers

E4. Permanent Identification

E5. Lockout/Tagout & Safety Solutions

F. Index

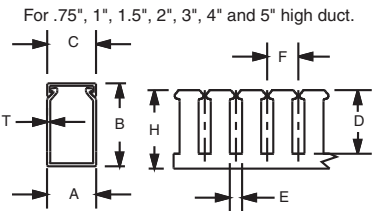
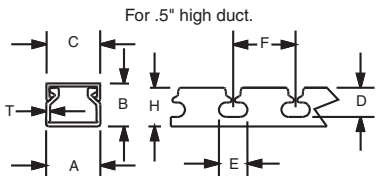

Note: 'A' dimension is measured at base.  
Note: 'K' dimension shown in mounting hole dimensions below.

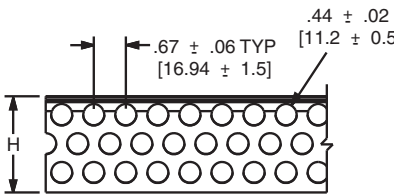

For 2" duct height = 3 rows of holes  
3" duct height = 4 rows of holes  
4" duct height = 6 rows of holes

**Mounting Hole Dimensions**  
For .5", .75", 1", and 1.5" wide duct.

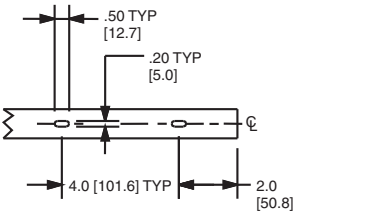

For 2.0", 2.5", 3", 4" and 6" wide duct.

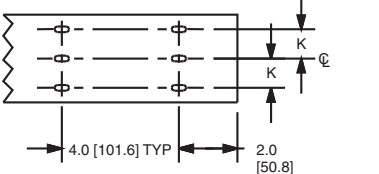

| Duct Size (W x H)            | Dimensions – Inches (mm) |                 |                 |                 |              |                |                 |                |   |              |
|------------------------------|--------------------------|-----------------|-----------------|-----------------|--------------|----------------|-----------------|----------------|---|--------------|
|                              | A                        | B               | C               | D               | E            | F              | H               | K              | T |              |
| .5 x .5<br>(12.7) x (12.7)   | .69<br>(17.5)            | .60<br>(15.2)   | .69<br>(17.5)   | .38<br>(9.5)    | .37<br>(9.3) | .80<br>(20.3)  | .50<br>(12.7)   |                |   | .05<br>(1.3) |
| .5 x 1<br>(12.7) x (25.4)    | .69<br>(17.5)            | 1.06<br>(26.9)  | .69<br>(17.5)   | .75<br>(19.1)   | .31<br>(7.9) | .80<br>(20.3)  | 1.00<br>(25.4)  |                |   | .05<br>(1.3) |
| .5 x 2<br>(12.7) x (50.8)    | .69<br>(17.5)            | 2.03<br>(51.6)  | .69<br>(17.5)   | 1.63<br>(41.3)  | .31<br>(7.9) | .80<br>(20.3)  | 2.00<br>(50.8)  |                |   | .08<br>(2.0) |
| .75 x .75<br>(19.1) x (19.1) | .93<br>(23.6)            | .82<br>(20.8)   | .94<br>(23.9)   | .56<br>(14.3)   | .31<br>(7.9) | .80<br>(20.3)  | 0.75<br>(19.1)  |                |   | .06<br>(1.4) |
| .75 x 1<br>(19.1) x (25.4)   | .93<br>(23.6)            | 1.06<br>(26.9)  | .94<br>(23.9)   | .75<br>(19.1)   | .31<br>(7.9) | .80<br>(20.3)  | 1.00<br>(25.4)  |                |   | .06<br>(1.4) |
| .75 x 1.5<br>(19.1) x (38.1) | .93<br>(23.6)            | 1.57<br>(39.9)  | .94<br>(23.9)   | 1.20<br>(30.5)  | .31<br>(7.9) | .80<br>(20.3)  | 1.50<br>(38.1)  |                |   | .07<br>(1.8) |
| .75 x 2<br>(19.1) x (50.8)   | .93<br>(23.6)            | 2.03<br>(51.6)  | .94<br>(23.9)   | 1.63<br>(41.3)  | .31<br>(7.9) | .80<br>(20.3)  | 2.00<br>(50.8)  |                |   | .08<br>(2.0) |
| 1 x 1<br>(25.4) x (25.4)     | 1.26<br>(32.0)           | 1.12<br>(28.4)  | 1.25<br>(31.8)  | .75<br>(19.1)   | .31<br>(7.9) | .80<br>(20.3)  | 1.00<br>(25.4)  |                |   | .06<br>(1.4) |
| 1 x 1.5<br>(25.4) x (38.1)   | 1.26<br>(32.0)           | 1.62<br>(41.1)  | 1.25<br>(31.8)  | 1.20<br>(30.5)  | .31<br>(7.9) | .80<br>(20.3)  | 1.50<br>(38.1)  |                |   | .07<br>(1.8) |
| 1 x 2<br>(25.4) x (50.8)     | 1.26<br>(32.0)           | 2.12<br>(53.8)  | 1.25<br>(31.8)  | 1.63<br>(41.3)  | .31<br>(7.9) | .80<br>(20.3)  | 2.00<br>(50.8)  |                |   | .08<br>(2.0) |
| 1 x 3<br>(25.4) x (76.2)     | 1.26<br>(32.0)           | 3.12<br>(79.2)  | 1.25<br>(31.8)  | 2.63<br>(66.7)  | .31<br>(7.9) | 1.00<br>(25.4) | 3.00<br>(76.2)  |                |   | .10<br>(2.4) |
| 1 x 4<br>(25.4) x (101.6)    | 1.26<br>(32.0)           | 4.10<br>(104.1) | 1.25<br>(31.8)  | 3.63<br>(92.1)  | .31<br>(7.9) | 1.00<br>(25.4) | 4.00<br>(101.6) |                |   | .11<br>(2.7) |
| 1.5 x 1<br>(38.1) x (25.4)   | 1.75<br>(44.5)           | 1.12<br>(28.4)  | 1.75<br>(44.5)  | .75<br>(19.1)   | .31<br>(7.9) | .80<br>(20.3)  | 1.00<br>(25.4)  |                |   | .06<br>(1.5) |
| 1.5 x 1.5<br>(38.1) x (38.1) | 1.75<br>(44.5)           | 1.62<br>(41.1)  | 1.75<br>(44.5)  | 1.20<br>(30.5)  | .31<br>(7.9) | .80<br>(20.3)  | 1.50<br>(38.1)  |                |   | .07<br>(1.8) |
| 1.5 x 2<br>(38.1) x (50.8)   | 1.75<br>(44.5)           | 2.12<br>(53.8)  | 1.75<br>(44.5)  | 1.63<br>(41.3)  | .31<br>(7.9) | .80<br>(20.3)  | 2.00<br>(50.8)  |                |   | .08<br>(2.0) |
| 1.5 x 3<br>(38.1) x (76.2)   | 1.75<br>(44.5)           | 3.12<br>(79.2)  | 1.75<br>(44.5)  | 2.63<br>(66.7)  | .31<br>(7.9) | 1.00<br>(25.4) | 3.00<br>(76.2)  |                |   | .10<br>(2.4) |
| 1.5 x 4<br>(38.1) x (101.6)  | 1.75<br>(44.5)           | 4.10<br>(104.1) | 1.75<br>(44.5)  | 3.63<br>(92.1)  | .31<br>(7.9) | 1.00<br>(25.4) | 4.00<br>(101.6) |                |   | .11<br>(2.7) |
| 2 x 1<br>(50.8) x (25.4)     | 2.25<br>(57.2)           | 1.12<br>(28.4)  | 2.25<br>(57.2)  | .75<br>(19.1)   | .31<br>(7.9) | .80<br>(20.3)  | 1.00<br>(25.4)  | .50<br>(12.7)  |   | .06<br>(1.5) |
| 2 x 1.5<br>(50.8) x (38.1)   | 2.25<br>(57.2)           | 1.62<br>(41.1)  | 2.25<br>(57.2)  | 1.20<br>(30.5)  | .31<br>(7.9) | .80<br>(20.3)  | 1.50<br>(38.1)  | .50<br>(12.7)  |   | .07<br>(1.8) |
| 2 x 2<br>(50.8) x (50.8)     | 2.25<br>(57.2)           | 2.12<br>(53.8)  | 2.25<br>(57.2)  | 1.63<br>(41.3)  | .31<br>(7.9) | .80<br>(20.3)  | 2.00<br>(50.8)  | .50<br>(12.7)  |   | .08<br>(2.0) |
| 2 x 3<br>(50.8) x (76.2)     | 2.25<br>(57.2)           | 3.12<br>(79.2)  | 2.25<br>(57.2)  | 2.63<br>(66.7)  | .31<br>(7.9) | 1.00<br>(25.4) | 3.00<br>(76.2)  | .50<br>(12.7)  |   | .10<br>(2.4) |
| 2 x 4<br>(50.8) x (101.6)    | 2.25<br>(57.2)           | 4.10<br>(104.1) | 2.25<br>(57.2)  | 3.63<br>(92.1)  | .31<br>(7.9) | 1.00<br>(25.4) | 4.00<br>(101.6) | .50<br>(12.7)  |   | .11<br>(2.7) |
| 2 x 5<br>(50.8) x (127.0)    | 2.25<br>(57.2)           | 5.10<br>(129.5) | 2.25<br>(57.2)  | 4.63<br>(117.5) | .38<br>(9.5) | 1.33<br>(33.9) | 5.00<br>(127.0) | .50<br>(12.7)  |   | .12<br>(2.9) |
| 2.5 x 3<br>(63.5) x (76.2)   | 2.75<br>(69.9)           | 3.12<br>(79.2)  | 2.75<br>(69.9)  | 2.63<br>(66.7)  | .31<br>(7.9) | 1.00<br>(25.4) | 3.00<br>(76.2)  | .73<br>(18.4)  |   | .10<br>(2.5) |
| 3 x 1<br>(76.2) x (25.4)     | 3.25<br>(82.6)           | 1.12<br>(28.4)  | 3.25<br>(82.6)  | .75<br>(19.1)   | .31<br>(7.9) | .80<br>(20.3)  | 1.00<br>(25.4)  | 1.00<br>(25.4) |   | .07<br>(1.8) |
| 3 x 2<br>(76.2) x (50.8)     | 3.25<br>(82.6)           | 2.12<br>(53.8)  | 3.25<br>(82.6)  | 1.63<br>(41.3)  | .31<br>(7.9) | .80<br>(20.3)  | 2.00<br>(50.8)  | 1.00<br>(25.4) |   | .08<br>(2.0) |
| 3 x 3<br>(76.2) x (76.2)     | 3.25<br>(82.6)           | 3.12<br>(79.2)  | 3.25<br>(82.6)  | 2.63<br>(66.7)  | .31<br>(7.9) | 1.00<br>(25.4) | 3.00<br>(76.2)  | 1.00<br>(25.4) |   | .10<br>(2.4) |
| 3 x 4<br>(76.2) x (101.6)    | 3.25<br>(82.6)           | 4.10<br>(104.1) | 3.25<br>(82.6)  | 3.63<br>(92.1)  | .31<br>(7.9) | 1.00<br>(25.4) | 4.00<br>(101.6) | 1.00<br>(25.4) |   | .11<br>(2.7) |
| 3 x 5<br>(76.2) x (127.0)    | 3.25<br>(82.6)           | 5.10<br>(129.5) | 3.25<br>(82.6)  | 4.63<br>(117.5) | .38<br>(9.5) | 1.33<br>(33.9) | 5.00<br>(127.0) | 1.00<br>(25.4) |   | .12<br>(2.9) |
| 4 x 1.5<br>(101.6) x (38.1)  | 4.25<br>(108.0)          | 1.62<br>(41.1)  | 4.25<br>(108.0) | 1.20<br>(30.5)  | .31<br>(7.9) | .80<br>(20.3)  | 1.50<br>(38.1)  | 1.50<br>(38.1) |   | .07<br>(1.8) |
| 4 x 2<br>(101.6) x (50.8)    | 4.25<br>(108.0)          | 2.12<br>(53.8)  | 4.25<br>(108.0) | 1.63<br>(41.3)  | .31<br>(7.9) | 0.80<br>(20.3) | 2.00<br>(50.8)  | 1.50<br>(38.1) |   | .08<br>(2.0) |
| 4 x 3<br>(101.6) x (76.2)    | 4.25<br>(108.0)          | 3.12<br>(79.2)  | 4.25<br>(108.0) | 2.63<br>(66.7)  | .31<br>(7.9) | 1.00<br>(25.4) | 3.00<br>(76.2)  | 1.50<br>(38.1) |   | .10<br>(2.5) |
| 4 x 4<br>(101.6) x (101.6)   | 4.25<br>(108.0)          | 4.10<br>(104.1) | 4.25<br>(108.0) | 3.63<br>(92.1)  | .31<br>(7.9) | 1.00<br>(25.4) | 4.00<br>(101.6) | 1.50<br>(38.1) |   | .11<br>(2.7) |
| 4 x 5<br>(101.6) x (127.0)   | 4.25<br>(108.0)          | 5.10<br>(129.5) | 4.25<br>(108.0) | 4.63<br>(117.5) | .38<br>(9.5) | 1.33<br>(33.9) | 5.00<br>(127.0) | 1.50<br>(38.1) |   | .12<br>(2.9) |
| 6 x 4<br>(152.4) x (101.6)   | 6.25<br>(158.8)          | 4.15<br>(105.4) | 6.25<br>(158.8) | 3.63<br>(92.1)  | .31<br>(7.9) | 1.00<br>(25.4) | 4.00<br>(101.6) | 2.50<br>(63.5) |   | .11<br>(2.8) |

ON CENTERLINE

> Available for type G wiring duct only.  
See page C1.13 and C1.17 for wiring duct color and size availability.



### Panduit® Type F Wiring Duct and FS Raceway Dimensions

Dimensions are shown for reference only. Contact Panduit Customer Service at 800-777-3300 for specific dimensional needs.

A.  
System  
Overview

B1.  
Cable  
Ties

B2.  
Cable  
Accessories

B3.  
Stainless  
Steel Ties

C1.  
Wiring  
Duct

C2.  
Surface  
Raceway

C3.  
Abrasion  
Protection

C4.  
Cable  
Management

D1.  
Terminals

D2.  
Power  
Connectors

D3.  
Grounding  
Connectors

E1.  
Labeling  
Systems

E2.  
Labels

E3.  
Pre-Printed  
& Write-On  
Markers

E4.  
Permanent  
Identification

E5.  
Lockout/  
Tagout  
& Safety  
Solutions

F.  
Index

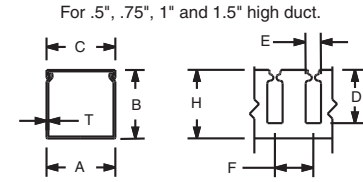

For .5", .75", 1" and 1.5" high duct.

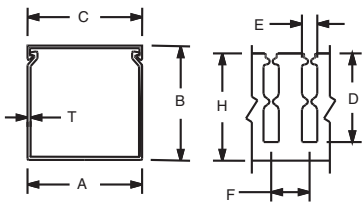

For 2", 3", 4" and 5" high duct.  
Note: 'A' dimension is measured at base.  
Note: 'K' dimension shown in mounting hole dimensions below.

#### Mounting Hole Dimensions

For .5", .75", 1" and 1.5" wide duct.

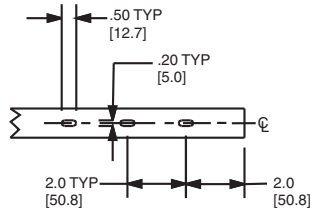

For 2.0", 2.5", 3", 4" and 6" wide duct.

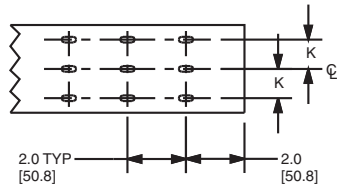

Note: For type FS raceway, no mounting holes is the standard condition; if mounting holes are required, delete NM from the part number.

| Duct Size<br>(W x H)         | Dimensions – Inches (mm) |                 |                 |                 |              |               |                 |               |              |
|------------------------------|--------------------------|-----------------|-----------------|-----------------|--------------|---------------|-----------------|---------------|--------------|
|                              | A                        | B               | C               | D               | E            | F             | H               | K             | T            |
| .5 x .5<br>(12.7) x (12.7)   | .69<br>(17.5)            | .60<br>(15.2)   | .69<br>(17.5)   | .38<br>(9.5)    | .20<br>(5.0) | .50<br>(12.7) | .50<br>(12.7)   | ON CENTERLINE | .05<br>(1.3) |
| .5 x 1<br>(12.7) x (25.4)    | .69<br>(17.5)            | 1.06<br>(26.9)  | .69<br>(17.5)   | .75<br>(19.1)   | .20<br>(5.0) | .50<br>(12.7) | 1.00<br>(25.4)  |               | .05<br>(1.3) |
| .75 x .75<br>(19.1) x (19.1) | .93<br>(23.6)            | .82<br>(20.8)   | .94<br>(23.9)   | .56<br>(14.3)   | .20<br>(5.0) | .50<br>(12.7) | .75<br>(19.1)   |               | .06<br>(1.4) |
| .75 x 1.5<br>(19.1) x (38.1) | .93<br>(23.6)            | 1.57<br>(39.9)  | .94<br>(23.9)   | 1.20<br>(30.5)  | .20<br>(5.0) | .50<br>(12.7) | 1.50<br>(38.1)  |               | .07<br>(1.8) |
| 1 x 1<br>(25.4) x (25.4)     | 1.26<br>(32.0)           | 1.12<br>(28.4)  | 1.25<br>(31.8)  | .75<br>(19.1)   | .20<br>(5.0) | .50<br>(12.7) | 1.00<br>(25.4)  |               | .06<br>(1.4) |
| 1 x 1.5<br>(25.4) x (38.1)   | 1.26<br>(32.0)           | 1.62<br>(41.1)  | 1.25<br>(31.8)  | 1.20<br>(30.5)  | .20<br>(5.0) | .50<br>(12.7) | 1.50<br>(38.1)  |               | .07<br>(1.8) |
| 1 x 2<br>(25.4) x (50.8)     | 1.26<br>(32.0)           | 2.12<br>(53.8)  | 1.25<br>(31.8)  | 1.63<br>(41.3)  | .20<br>(5.0) | .50<br>(12.7) | 2.00<br>(50.8)  |               | .08<br>(2.0) |
| 1 x 3<br>(25.4) x (76.2)     | 1.26<br>(32.0)           | 3.12<br>(79.2)  | 1.25<br>(31.8)  | 2.63<br>(66.7)  | .20<br>(5.0) | .50<br>(12.7) | 3.00<br>(76.2)  |               | .10<br>(2.4) |
| 1 x 4<br>(25.4) x (101.6)    | 1.26<br>(32.0)           | 4.10<br>(104.1) | 1.25<br>(31.8)  | 3.63<br>(92.1)  | .20<br>(5.0) | .50<br>(12.7) | 4.00<br>(101.6) |               | .11<br>(2.7) |
| 1.5 x 1<br>(38.1) x (25.4)   | 1.75<br>(44.5)           | 1.12<br>(28.4)  | 1.75<br>(44.5)  | .75<br>(19.1)   | .20<br>(5.0) | .50<br>(12.7) | 1.00<br>(25.4)  |               | .06<br>(1.5) |
| 1.5 x 1.5<br>(38.1) x (38.1) | 1.75<br>(44.5)           | 1.62<br>(41.1)  | 1.75<br>(44.5)  | 1.20<br>(30.5)  | .20<br>(5.0) | .50<br>(12.7) | 1.50<br>(38.1)  |               | .07<br>(1.8) |
| 1.5 x 2<br>(38.1) x (50.8)   | 1.75<br>(44.5)           | 2.12<br>(53.8)  | 1.75<br>(44.5)  | 1.63<br>(41.3)  | .20<br>(5.0) | .50<br>(12.7) | 2.00<br>(50.8)  |               | .08<br>(2.0) |
| 1.5 x 3<br>(38.1) x (76.2)   | 1.75<br>(44.5)           | 3.12<br>(79.2)  | 1.75<br>(44.5)  | 2.63<br>(66.7)  | .20<br>(5.0) | .50<br>(12.7) | 3.00<br>(76.2)  |               | .10<br>(2.4) |
| 1.5 x 4<br>(38.1) x (101.6)  | 1.75<br>(44.5)           | 4.10<br>(104.1) | 1.75<br>(44.5)  | 3.63<br>(92.1)  | .20<br>(5.0) | .50<br>(12.7) | 4.00<br>(101.6) |               | .11<br>(2.7) |
| 2 x 1<br>(50.8) x (25.4)     | 2.25<br>(57.2)           | 1.12<br>(28.4)  | 2.25<br>(57.2)  | .75<br>(19.1)   | .20<br>(5.0) | .50<br>(12.7) | 1.00<br>(25.4)  |               | .06<br>(1.5) |
| 2 x 1.5<br>(50.8) x (38.1)   | 2.25<br>(57.2)           | 1.62<br>(41.1)  | 2.25<br>(57.2)  | 1.20<br>(30.5)  | .20<br>(5.0) | .50<br>(12.7) | 1.50<br>(38.1)  |               | .07<br>(1.8) |
| 2 x 2<br>(50.8) x (50.8)     | 2.25<br>(57.2)           | 2.12<br>(53.8)  | 2.25<br>(57.2)  | 1.63<br>(41.3)  | .20<br>(5.0) | .50<br>(12.7) | 2.00<br>(50.8)  |               | .08<br>(2.0) |
| 2 x 3<br>(50.8) x (76.2)     | 2.25<br>(57.2)           | 3.12<br>(79.2)  | 2.25<br>(57.2)  | 2.63<br>(66.7)  | .20<br>(5.0) | .50<br>(12.7) | 3.00<br>(76.2)  |               | .10<br>(2.4) |
| 2 x 4<br>(50.8) x (101.6)    | 2.25<br>(57.2)           | 4.10<br>(104.1) | 2.25<br>(57.2)  | 3.63<br>(92.1)  | .20<br>(5.0) | .50<br>(12.7) | 4.00<br>(101.6) |               | .11<br>(2.7) |
| 2 x 5<br>(50.8) x (127.0)    | 2.25<br>(57.2)           | 5.10<br>(129.5) | 2.25<br>(57.2)  | 4.63<br>(117.5) | .20<br>(5.0) | .50<br>(12.7) | 5.00<br>(127.0) |               | .12<br>(2.9) |
| 3 x 1<br>(76.2) x (25.4)     | 3.25<br>(82.6)           | 1.12<br>(28.4)  | 3.25<br>(82.6)  | .75<br>(19.1)   | .20<br>(5.0) | .50<br>(12.7) | 1.00<br>(25.4)  |               | .07<br>(1.7) |
| 3 x 2<br>(76.2) x (50.8)     | 3.25<br>(82.6)           | 2.12<br>(53.8)  | 3.25<br>(82.6)  | 1.63<br>(41.3)  | .20<br>(5.0) | .50<br>(12.7) | 2.00<br>(50.8)  |               | .08<br>(2.0) |
| 3 x 3<br>(76.2) x (76.2)     | 3.25<br>(82.6)           | 3.12<br>(79.2)  | 3.25<br>(82.6)  | 2.63<br>(66.7)  | .20<br>(5.0) | .50<br>(12.7) | 3.00<br>(76.2)  |               | .10<br>(2.4) |
| 3 x 4<br>(76.2) x (101.6)    | 3.25<br>(82.6)           | 4.10<br>(104.1) | 3.25<br>(82.6)  | 3.63<br>(92.1)  | .20<br>(5.0) | .50<br>(12.7) | 4.00<br>(101.6) |               | .11<br>(2.7) |
| 3 x 5<br>(76.2) x (127.0)    | 3.25<br>(82.6)           | 5.10<br>(129.5) | 3.25<br>(82.6)  | 4.63<br>(117.5) | .20<br>(5.0) | .50<br>(12.7) | 5.00<br>(127.0) |               | .12<br>(2.9) |
| 4 x 1.5<br>(101.6) x (38.1)  | 4.25<br>(108.0)          | 1.62<br>(41.1)  | 4.25<br>(108.0) | N/A             | N/A          | N/A           | 1.50<br>(38.1)  |               | .07<br>(1.8) |
| 4 x 2<br>(101.6) x (50.8)    | 4.25<br>(108.0)          | 2.12<br>(53.8)  | 4.25<br>(108.0) | 1.63<br>(41.3)  | .20<br>(5.0) | .50<br>(12.7) | 2.00<br>(50.8)  |               | .08<br>(2.0) |
| 4 x 3<br>(101.6) x (76.2)    | 4.25<br>(108.0)          | 3.12<br>(79.2)  | 4.25<br>(108.0) | 2.63<br>(66.7)  | .20<br>(5.0) | .50<br>(12.7) | 3.00<br>(76.2)  |               | .10<br>(2.4) |
| 4 x 4<br>(101.6) x (101.6)   | 4.25<br>(108.0)          | 4.10<br>(104.1) | 4.25<br>(108.0) | 3.63<br>(92.1)  | .20<br>(5.0) | .50<br>(12.7) | 4.00<br>(101.6) |               | .11<br>(2.7) |
| 4 x 5<br>(101.6) x (127.0)   | 4.25<br>(108.0)          | 5.10<br>(129.5) | 4.25<br>(108.0) | 4.63<br>(117.5) | .20<br>(5.0) | .50<br>(12.7) | 5.00<br>(127.0) |               | .12<br>(2.9) |
| 6 x 4<br>(152.4) x (101.6)   | 6.25<br>(158.8)          | 4.15<br>(105.4) | 6.25<br>(158.8) | 3.63<br>(92.1)  | .20<br>(5.0) | .50<br>(12.7) | 4.00<br>(101.6) |               | .11<br>(2.8) |

> Available for type FS raceway only.  
See page C1.48 for wiring duct color and size availability.

A.  
System  
Overview

### Panduit® Type MC Wiring Duct Dimensions

Dimensions are shown for reference only. Contact Panduit Customer Service at 800-777-3300 for specific dimensional needs.

B1.  
Cable Ties

B2.  
Cable  
Accessories

B3.  
Stainless  
Steel Ties

C1.  
Wiring  
Duct

C2.  
Surface  
Raceway

C3.  
Abrasion  
Protection

C4.  
Cable  
Management

For 25mm, 37.5mm, and 50mm high duct.

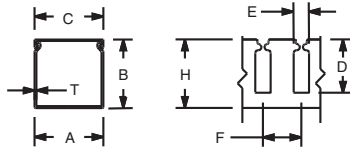

For 62.5mm, 75mm, and 100mm high duct.

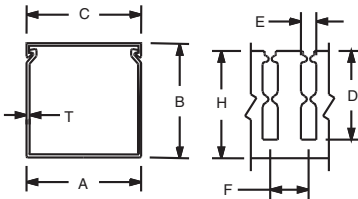

Note: 'A' dimension is measured at base.  
Note: 'K' dimension shown in mounting  
hole dimensions below.

#### Mounting Hole Dimensions

For 25mm, 37.5mm, and 50mm width duct.

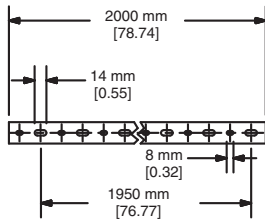

For 75mm and 100mm width duct.

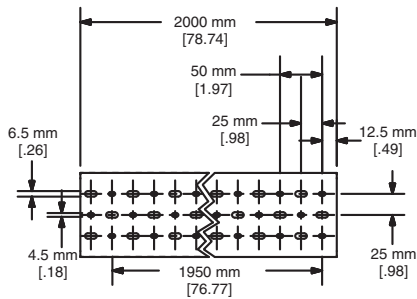

D1.  
Terminals

D2.  
Power  
Connectors

D3.  
Grounding  
Connectors

E1.  
Labeling  
Systems

E2.  
Labels

E3.  
Pre-Printed  
& Write-On  
Markers

E4.  
Permanent  
Identification

E5.  
Lockout/  
Tagout  
& Safety  
Solutions

F.  
Index

| Duct Size<br>(W x H)           | Dimensions – mm (Inches) |                |                |                |              |               |                |              |
|--------------------------------|--------------------------|----------------|----------------|----------------|--------------|---------------|----------------|--------------|
|                                | A                        | B              | C              | D              | E            | F             | H              | T            |
| 25 x 25<br>(.98) x (.98)       | 24.6<br>(.97)            | 23.6<br>(.93)  | 24.6<br>(.97)  | 13.6<br>(.54)  | 5.0<br>(.20) | 12.5<br>(.49) | 20.5<br>(.81)  | 1.4<br>(.06) |
| 25 x 37.5<br>(.98) x (1.48)    | 24.6<br>(.97)            | 35.8<br>(1.41) | 24.6<br>(.97)  | 24.7<br>(.97)  | 5.0<br>(.20) | 12.5<br>(.49) | 33.0<br>(1.30) | 1.4<br>(.06) |
| 25 x 50<br>(.98) x (1.97)      | 24.6<br>(.97)            | 47.8<br>(1.88) | 24.6<br>(.97)  | 34.8<br>(1.37) | 5.0<br>(.20) | 12.5<br>(.49) | 45.5<br>(1.79) | 1.5<br>(.06) |
| 25 x 62.5<br>(.98) x (2.46)    | 24.6<br>(.97)            | 59.7<br>(2.35) | 24.6<br>(.97)  | 45.8<br>(1.80) | 5.0<br>(.20) | 12.5<br>(.49) | 58.0<br>(2.28) | 1.5<br>(.06) |
| 25 x 75<br>(.98) x (2.95)      | 24.6<br>(.97)            | 73.2<br>(2.88) | 24.6<br>(.97)  | 57.6<br>(2.27) | 5.0<br>(.20) | 12.5<br>(.49) | 70.5<br>(2.78) | 1.7<br>(.07) |
| 37.5 x 37.5<br>(1.48) x (1.48) | 37.1<br>(1.46)           | 35.8<br>(1.41) | 37.1<br>(1.46) | 24.7<br>(.97)  | 5.0<br>(.20) | 12.5<br>(.49) | 33.0<br>(1.30) | 1.5<br>(.06) |
| 37.5 x 50<br>(1.48) x (1.97)   | 37.1<br>(1.46)           | 47.8<br>(1.88) | 37.1<br>(1.46) | 34.8<br>(1.37) | 5.0<br>(.20) | 12.5<br>(.49) | 45.5<br>(1.79) | 1.7<br>(.07) |
| 37.5 x 62.5<br>(1.48) x (2.46) | 37.1<br>(1.46)           | 59.7<br>(2.35) | 37.1<br>(1.46) | 45.8<br>(1.80) | 5.0<br>(.20) | 12.5<br>(.49) | 58.0<br>(2.28) | 1.7<br>(.07) |
| 37.5 x 75<br>(1.48) x (2.95)   | 37.1<br>(1.46)           | 72.4<br>(2.85) | 37.1<br>(1.46) | 57.6<br>(2.27) | 5.0<br>(.20) | 12.5<br>(.49) | 70.5<br>(2.78) | 1.8<br>(.07) |
| 50 x 50<br>(1.97) x (1.97)     | 49.5<br>(1.95)           | 48.0<br>(1.89) | 49.6<br>(1.95) | 34.8<br>(1.37) | 5.0<br>(.20) | 12.5<br>(.49) | 45.5<br>(1.79) | 1.7<br>(.07) |
| 50 x 75<br>(1.97) x (2.95)     | 49.5<br>(1.95)           | 72.4<br>(2.85) | 49.6<br>(1.95) | 57.6<br>(2.27) | 5.0<br>(.20) | 12.5<br>(.49) | 70.5<br>(2.78) | 1.9<br>(.08) |
| 50 x 100<br>(1.97) x (3.94)    | 49.5<br>(1.95)           | 97.8<br>(3.85) | 49.6<br>(1.95) | 81.0<br>(3.19) | 5.0<br>(.20) | 12.5<br>(.49) | 95.5<br>(3.76) | 2.2<br>(.09) |
| 62.5 x 62.5<br>(2.46) x (2.46) | 62.0<br>(2.44)           | 59.7<br>(2.35) | 62.1<br>(2.44) | 45.8<br>(1.80) | 5.0<br>(.20) | 12.5<br>(.49) | 58.0<br>(2.28) | 1.8<br>(.07) |
| 75 x 50<br>(2.95) x (1.97)     | 74.7<br>(2.94)           | 48.0<br>(1.89) | 74.6<br>(2.94) | 34.8<br>(1.37) | 5.0<br>(.20) | 12.5<br>(.49) | 45.5<br>(1.79) | 2.0<br>(.08) |
| 75 x 62.5<br>(2.95) x (2.46)   | 74.7<br>(2.94)           | 59.7<br>(2.35) | 74.6<br>(2.94) | 45.8<br>(1.80) | 5.0<br>(.20) | 12.5<br>(.49) | 58.0<br>(2.28) | 2.0<br>(.08) |
| 75 x 75<br>(2.95) x (2.95)     | 74.7<br>(2.94)           | 73.2<br>(2.88) | 74.6<br>(2.94) | 57.6<br>(2.27) | 5.0<br>(.20) | 12.5<br>(.49) | 70.5<br>(2.78) | 2.2<br>(.09) |
| 75 x 100<br>(2.95) x (3.94)    | 74.7<br>(2.94)           | 97.8<br>(3.85) | 74.6<br>(2.94) | 81.0<br>(3.19) | 5.0<br>(.20) | 12.5<br>(.49) | 95.5<br>(3.76) | 2.3<br>(.09) |
| 100 x 50<br>(3.94) x (1.97)    | 99.6<br>(3.92)           | 48.0<br>(1.89) | 99.6<br>(3.92) | 34.8<br>(1.37) | 5.0<br>(.20) | 12.5<br>(.49) | 45.5<br>(1.79) | 2.0<br>(.08) |
| 100 x 75<br>(3.94) x (2.95)    | 99.6<br>(3.92)           | 73.2<br>(2.88) | 99.6<br>(3.92) | 57.6<br>(2.27) | 5.0<br>(.20) | 12.5<br>(.49) | 70.5<br>(2.78) | 2.5<br>(.10) |
| 100 x 100<br>(3.94) x (3.94)   | 99.6<br>(3.92)           | 97.8<br>(3.85) | 99.6<br>(3.92) | 81.0<br>(3.19) | 5.0<br>(.20) | 12.5<br>(.49) | 99.5<br>(3.76) | 2.5<br>(.10) |

### Panduit® Type NNC Wiring Duct Dimensions

Dimensions are shown for reference only. Contact Panduit Customer Service at 800-777-3300 for specific dimensional needs.

For 25mm, 37.5mm, and 50mm high duct.

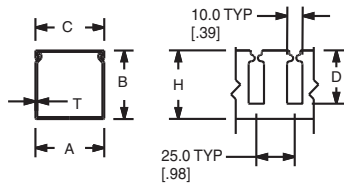

For 75mm and 100mm high duct.

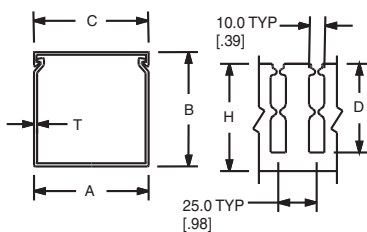

#### Mounting Hole Dimensions

For 25mm, 37.5mm, and 50mm width duct.

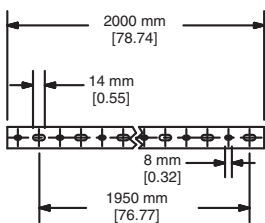

For 75mm and 100mm width duct.

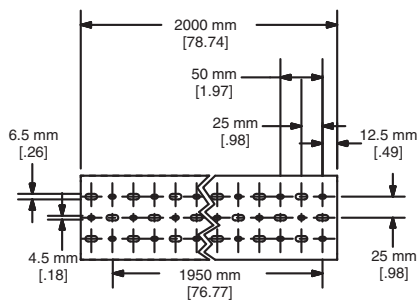

| Duct Size<br>(W x H)           | Dimensions – mm (Inches) |                |                |                |                |              |
|--------------------------------|--------------------------|----------------|----------------|----------------|----------------|--------------|
|                                | A                        | B              | C              | D              | H              | T            |
| 25 x 25<br>(.98) x (.98)       | 24.6<br>(.97)            | 23.6<br>(.93)  | 24.6<br>(.97)  | 13.6<br>(.54)  | 20.3<br>(.80)  | 1.5<br>(.06) |
| 25 x 37<br>(.98) x (1.48)      | 24.6<br>(.97)            | 35.8<br>(1.41) | 24.6<br>(.97)  | 24.6<br>(.97)  | 33.0<br>(1.30) | 1.8<br>(.07) |
| 25 x 50<br>(.98) x (1.97)      | 24.6<br>(.97)            | 47.8<br>(1.88) | 24.6<br>(.97)  | 34.8<br>(1.37) | 45.5<br>(1.79) | 2.0<br>(.08) |
| 25 x 75<br>(.98) x (2.95)      | 24.6<br>(.97)            | 72.4<br>(2.85) | 24.6<br>(.97)  | 57.6<br>(2.27) | 70.6<br>(2.78) | 2.0<br>(.08) |
| 37.5 x 37.5<br>(1.48) x (1.48) | 37.1<br>(1.46)           | 35.8<br>(1.41) | 37.1<br>(1.46) | 24.7<br>(.97)  | 33.0<br>(1.30) | 1.8<br>(.07) |
| 37.5 x 50<br>(1.48) x (1.97)   | 37.1<br>(1.46)           | 47.8<br>(1.88) | 37.1<br>(1.46) | 34.8<br>(1.37) | 45.5<br>(1.79) | 2.0<br>(.08) |
| 37.5 x 75<br>(1.48) x (2.95)   | 37.1<br>(1.46)           | 72.4<br>(2.85) | 37.1<br>(1.46) | 57.6<br>(2.27) | 70.6<br>(2.78) | 2.0<br>(.08) |
| 50 x 50<br>(1.97) x (1.97)     | 49.5<br>(1.95)           | 47.8<br>(1.88) | 49.5<br>(1.95) | 34.8<br>(1.37) | 45.5<br>(1.79) | 2.0<br>(.08) |
| 50 x 75<br>(1.97) x (2.95)     | 49.5<br>(1.95)           | 72.4<br>(2.85) | 49.5<br>(1.95) | 57.6<br>(2.27) | 70.6<br>(2.78) | 2.0<br>(.08) |
| 50 x 100<br>(1.97) x (3.94)    | 49.5<br>(1.95)           | 97.8<br>(3.85) | 49.5<br>(1.95) | 81.0<br>(3.19) | 95.5<br>(3.76) | 2.3<br>(.09) |
| 75 x 75<br>(2.95) x (2.95)     | 74.7<br>(2.94)           | 72.4<br>(2.85) | 74.7<br>(2.94) | 57.6<br>(2.27) | 70.6<br>(2.78) | 2.0<br>(.08) |
| 100 x 50<br>(3.94) x (1.97)    | 99.6<br>(3.92)           | 47.8<br>(1.88) | 99.6<br>(3.92) | 34.8<br>(1.37) | 45.5<br>(1.79) | 2.0<br>(.08) |
| 100 x 75<br>(3.94) x (2.95)    | 99.6<br>(3.92)           | 72.4<br>(2.85) | 99.6<br>(3.92) | 57.6<br>(2.27) | 70.6<br>(2.78) | 2.0<br>(.08) |
| 100 x 100<br>(3.92) x (3.85)   | 99.6<br>(3.92)           | 97.8<br>(3.85) | 99.6<br>(3.92) | 81.0<br>(3.19) | 95.5<br>(3.76) | 2.3<br>(.09) |

A.  
System  
Overview

B1.  
Cable Ties

B2.  
Cable  
Accessories

B3.  
Stainless  
Steel Ties

C1.  
Wiring  
Duct

C2.  
Surface  
Raceway

C3.  
Abrasion  
Protection

C4.  
Cable  
Management

D1.  
Terminals

D2.  
Power  
Connectors

D3.  
Grounding  
Connectors

E1.  
Labeling  
Systems

E2.  
Labels

E3.  
Pre-Printed  
& Write-On  
Markers

E4.  
Permanent  
Identification

E5.  
Lockout/  
Tagout  
& Safety  
Solutions

F.  
Index

### Panduit® Type NE Wiring Duct Dimensions

Dimensions are shown for reference only. Contact Panduit Customer Service at 800-777-3300 for specific dimensional needs.

A.  
System  
Overview

B1.  
Cable Ties

B2.  
Cable  
Accessories

B3.  
Stainless  
Steel Ties

C1.  
Wiring  
Duct

C2.  
Surface  
Raceway

C3.  
Abrasion  
Protection

C4.  
Cable  
Management

D1.  
Terminals

D2.  
Power  
Connectors

D3.  
Grounding  
Connectors

E1.  
Labeling  
Systems

E2.  
Labels

E3.  
Pre-Printed  
& Write-On  
Markers

E4.  
Permanent  
Identification

E5.  
Lockout/  
Tagout  
& Safety  
Solutions

F.  
Index

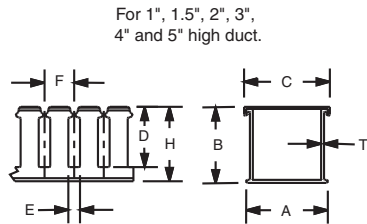
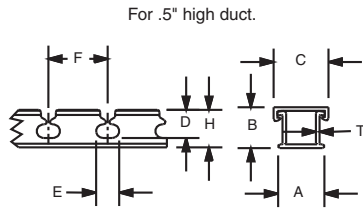

**Mounting Hole Dimensions**  
For .5", .75", 1" and 1.5" wide duct.

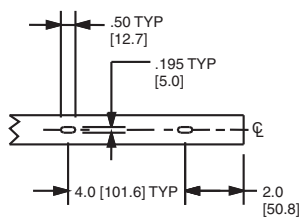

For 2.0", 2.5", 3" and 4" wide duct.

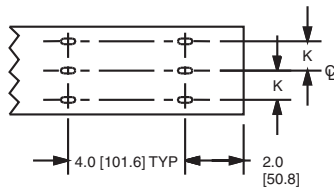

| Duct Size<br>(W x H)         | Dimensions – Inches (mm) |                 |                 |                 |              |                |                 |                |                |              |
|------------------------------|--------------------------|-----------------|-----------------|-----------------|--------------|----------------|-----------------|----------------|----------------|--------------|
|                              | A                        | B               | C               | D               | E            | F              | H               | K              | T              |              |
| .5 x .5<br>(12.7) x (12.7)   | .63<br>(16.0)            | .56<br>(14.2)   | .69<br>(17.5)   | .38<br>(9.7)    | .37<br>(9.4) | .80<br>(20.3)  | .50<br>(12.7)   | ON CENTERLINE  | .05<br>(1.3)   |              |
| .5 x 1<br>(12.7) x (25.4)    | .63<br>(16.0)            | 1.06<br>(26.9)  | .69<br>(17.5)   | .75<br>(19.1)   | .31<br>(7.9) | .80<br>(20.3)  | 1.00<br>(25.4)  |                | .06<br>(1.5)   |              |
| 1 x 1<br>(25.4) x (25.4)     | 1.14<br>(29.0)           | 1.06<br>(26.9)  | 1.25<br>(31.8)  | .75<br>(19.1)   | .31<br>(7.9) | .80<br>(20.3)  | 1.00<br>(25.4)  |                | .06<br>(1.5)   |              |
| 1 x 1.5<br>(25.4) x (38.1)   | 1.14<br>(29.0)           | 1.62<br>(41.1)  | 1.25<br>(31.8)  | 1.20<br>(30.5)  | .31<br>(7.9) | .80<br>(20.3)  | 1.50<br>(38.1)  |                | .07<br>(1.8)   |              |
| 1 x 2<br>(25.4) x (50.8)     | 1.14<br>(29.0)           | 2.06<br>(52.3)  | 1.25<br>(31.8)  | 1.63<br>(41.4)  | .31<br>(7.9) | .80<br>(20.3)  | 2.00<br>(50.8)  |                | .07<br>(1.8)   |              |
| 1 x 3<br>(25.4) x (76.2)     | 1.14<br>(29.0)           | 3.06<br>(77.7)  | 1.25<br>(31.8)  | 2.63<br>(66.8)  | .31<br>(7.9) | 1.00<br>(25.4) | 3.00<br>(76.2)  |                | .07<br>(1.8)   |              |
| 1 x 4<br>(25.4) x (101.6)    | 1.14<br>(29.0)           | 4.06<br>(103.1) | 1.25<br>(31.8)  | 3.63<br>(92.2)  | .31<br>(7.9) | 1.00<br>(25.4) | 4.00<br>(101.6) |                | .08<br>(2.0)   |              |
| 1.5 x 1.5<br>(38.1) x (38.1) | 1.64<br>(41.7)           | 1.62<br>(41.1)  | 1.75<br>(44.5)  | 1.20<br>(30.5)  | .31<br>(7.9) | .80<br>(20.3)  | 1.50<br>(38.1)  |                | .07<br>(1.8)   |              |
| 1.5 x 2<br>(38.1) x (50.8)   | 1.64<br>(41.7)           | 2.06<br>(52.3)  | 1.75<br>(44.5)  | 1.63<br>(41.4)  | .31<br>(7.9) | .80<br>(20.3)  | 2.00<br>(50.8)  |                | .07<br>(1.8)   |              |
| 1.5 x 3<br>(38.1) x (76.2)   | 1.64<br>(41.7)           | 3.06<br>(77.7)  | 1.75<br>(44.5)  | 2.63<br>(66.8)  | .31<br>(7.9) | 1.00<br>(25.4) | 3.00<br>(76.2)  |                | .07<br>(1.8)   |              |
| 1.5 x 4<br>(38.1) x (101.6)  | 1.64<br>(41.7)           | 4.06<br>(103.1) | 1.75<br>(44.5)  | 3.63<br>(92.2)  | .31<br>(7.9) | 1.00<br>(25.4) | 4.00<br>(101.6) |                | .08<br>(2.0)   |              |
| 2 x 1<br>(50.8) x (25.4)     | 2.14<br>(54.4)           | 1.06<br>(26.9)  | 2.25<br>(57.2)  | .75<br>(19.1)   | .31<br>(7.9) | .80<br>(20.3)  | 1.00<br>(25.4)  |                | .50<br>(12.7)  | .06<br>(1.5) |
| 2 x 2<br>(50.8) x (50.8)     | 2.14<br>(54.4)           | 2.06<br>(52.3)  | 2.25<br>(57.2)  | 1.63<br>(41.4)  | .31<br>(7.9) | .80<br>(20.3)  | 2.00<br>(50.8)  |                | .50<br>(12.7)  | .07<br>(1.8) |
| 2 x 3<br>(50.8) x (76.2)     | 2.14<br>(54.4)           | 3.06<br>(77.7)  | 2.25<br>(57.2)  | 2.63<br>(66.8)  | .31<br>(7.9) | 1.00<br>(25.4) | 3.00<br>(76.2)  |                | .50<br>(12.7)  | .07<br>(1.8) |
| 2 x 4<br>(50.8) x (101.6)    | 2.14<br>(54.4)           | 4.06<br>(103.1) | 2.25<br>(57.2)  | 3.63<br>(92.2)  | .31<br>(7.9) | 1.00<br>(25.4) | 4.00<br>(101.6) |                | .50<br>(12.7)  | .08<br>(2.0) |
| 3 x 1<br>(76.2) x (25.4)     | 3.14<br>(79.8)           | 1.06<br>(26.9)  | 3.25<br>(82.6)  | .75<br>(19.1)   | .31<br>(7.9) | .80<br>(20.3)  | 1.00<br>(25.4)  |                | 1.00<br>(25.4) | .06<br>(1.5) |
| 3 x 2<br>(76.2) x (50.8)     | 3.14<br>(79.8)           | 2.06<br>(52.3)  | 3.25<br>(82.6)  | 1.63<br>(41.4)  | .31<br>(7.9) | .80<br>(20.3)  | 2.00<br>(50.8)  |                | 1.00<br>(25.4) | .07<br>(1.7) |
| 3 x 3<br>(76.2) x (76.2)     | 3.14<br>(79.8)           | 3.06<br>(77.7)  | 3.25<br>(82.6)  | 2.63<br>(66.8)  | .31<br>(7.9) | 1.00<br>(25.4) | 3.00<br>(76.2)  |                | 1.00<br>(25.4) | .07<br>(1.8) |
| 3 x 4<br>(76.2) x (101.6)    | 3.14<br>(79.8)           | 4.06<br>(103.1) | 3.25<br>(82.6)  | 3.63<br>(92.2)  | .31<br>(7.9) | 1.00<br>(25.4) | 4.00<br>(101.6) |                | 1.00<br>(25.4) | .08<br>(2.0) |
| 3 x 5<br>(76.2) x (127.0)    | 3.14<br>(79.8)           | 5.06<br>(128.5) | 3.25<br>(82.6)  | 4.63<br>(117.6) | .38<br>(9.7) | 1.33<br>(33.8) | 5.00<br>(127.0) |                | 1.00<br>(25.4) | .09<br>(2.3) |
| 4 x 2<br>(101.6) x (50.8)    | 4.14<br>(105.2)          | 2.06<br>(52.3)  | 4.25<br>(108.0) | 1.63<br>(41.4)  | .31<br>(7.9) | .80<br>(20.3)  | 2.00<br>(50.8)  | 1.50<br>(38.1) | .07<br>(1.8)   |              |
| 4 x 3<br>(101.6) x (76.2)    | 4.14<br>(105.2)          | 3.06<br>(77.7)  | 4.25<br>(108.0) | 2.63<br>(66.8)  | .31<br>(7.9) | 1.00<br>(25.4) | 3.00<br>(76.2)  | 1.50<br>(38.1) | .07<br>(1.8)   |              |
| 4 x 4<br>(101.6) x (101.6)   | 4.14<br>(105.2)          | 4.06<br>(103.1) | 4.25<br>(108.0) | 3.63<br>(92.2)  | .31<br>(7.9) | 1.00<br>(25.4) | 4.00<br>(101.6) | 1.50<br>(38.1) | .08<br>(2.0)   |              |
| 4 x 5<br>(101.6) x (127.0)   | 4.14<br>(105.2)          | 5.06<br>(128.5) | 4.25<br>(108.0) | 4.63<br>(117.6) | .38<br>(9.7) | 1.33<br>(33.8) | 5.00<br>(127.0) | 1.50<br>(38.1) | .09<br>(2.3)   |              |

### Panduit® Type H and HS Wiring Duct Dimensions

Dimensions are shown for reference only. Contact Panduit Customer Service at 800-777-3300 for specific dimensional needs.

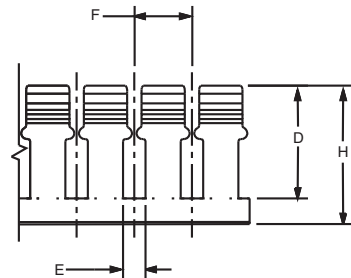
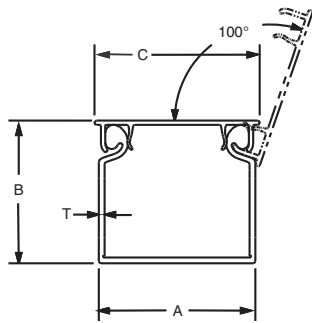

|                       | E          | F            |
|-----------------------|------------|--------------|
| For 2" duct height:   | .31" [7.9] | .80" [20.3]  |
| 3" to 4" duct height: | .31" [7.9] | 1.00" [25.4] |

| Duct Size (W x H)          | Dimensions – Inches (mm) |                |                 |                |              |                |                 |                |                |
|----------------------------|--------------------------|----------------|-----------------|----------------|--------------|----------------|-----------------|----------------|----------------|
|                            | A                        | B              | C               | D              | E            | F              | H               | K              | T              |
| 1.5 x 2<br>(38.1) x (50.8) | 1.75<br>(44.5)           | 1.98<br>(50.3) | 1.88<br>(47.8)  | 1.63<br>(41.4) | .31<br>(7.9) | .80<br>(20.3)  | 1.92<br>(48.8)  | .50<br>(12.7)  | .08<br>(2.0)   |
| 1.5 x 3<br>(38.1) x (76.2) | 1.75<br>(44.5)           | 3.06<br>(77.7) | 1.88<br>(47.8)  | 2.63<br>(66.8) | .31<br>(7.9) | 1.00<br>(25.4) | 3.00<br>(76.2)  |                | .10<br>(2.5)   |
| 2 x 2<br>(50.8) x (50.8)   | 2.17<br>(55.1)           | 1.98<br>(50.3) | 2.29<br>(58.2)  | 1.57<br>(39.9) | .31<br>(7.9) | .80<br>(20.3)  | 1.92<br>(48.8)  | .50<br>(12.7)  | .08<br>(2.0)   |
| 2 x 3<br>(50.8) x (76.2)   | 2.17<br>(55.1)           | 3.06<br>(77.7) | 2.29<br>(58.2)  | 2.63<br>(66.8) | .31<br>(7.9) | 1.00<br>(25.4) | 3.00<br>(76.2)  |                | .10<br>(2.5)   |
| 2 x 4<br>(50.8) x (101.6)  | 2.17<br>(55.1)           | 4.1<br>(104.1) | 4.38<br>(111.3) | 3.63<br>(92.2) | .31<br>(7.9) | 1.00<br>(25.4) | 4.00<br>(101.6) | .50<br>(12.7)  | .10<br>(2.7)   |
| 3 x 3<br>(76.2) x (76.2)   | 3.25<br>(82.6)           | 3.06<br>(77.7) | 3.38<br>(85.9)  | 2.63<br>(66.8) | .31<br>(7.9) | 1.00<br>(25.4) | 3.00<br>(76.2)  |                | 1.00<br>(25.4) |
| 3 x 4<br>(76.2) x (101.6)  | 3.25<br>(82.6)           | 4.1<br>(104.1) | 3.38<br>(85.9)  | 3.63<br>(92.2) | .31<br>(7.9) | 1.00<br>(25.4) | 4.00<br>(101.6) | 1.00<br>(25.4) | .11<br>(2.8)   |
| 4 x 4<br>(101.6) x (101.6) | 4.25<br>(108.0)          | 4.1<br>(104.1) | 4.38<br>(111.3) | 3.63<br>(92.2) | .31<br>(7.9) | 1.00<br>(25.4) | 4.00<br>(101.6) |                | 1.50<br>(38.1) |

For 2", 3", and 4" wide duct.

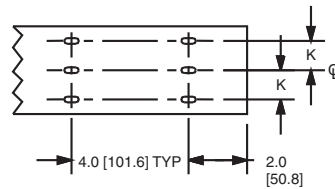

### Panduit® Type HN Wiring Duct Dimensions

Dimensions are shown for reference only. Contact Panduit Customer Service at 800-777-3300 for specific dimensional needs.

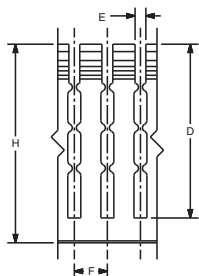
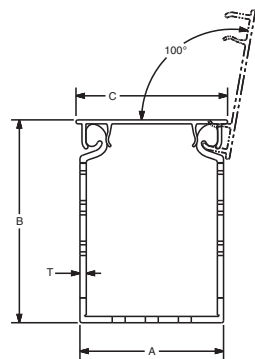

Multiple slot restrictors present with 2" and greater duct wall height.

| Duct Size (W x H)          | Dimensions – Inches (mm) |                |                 |                |              |               |                 |                |                |
|----------------------------|--------------------------|----------------|-----------------|----------------|--------------|---------------|-----------------|----------------|----------------|
|                            | A                        | B              | C               | D              | E            | F             | H               | K              | T              |
| 1.5 x 2<br>(38.1) x (50.8) | 1.75<br>(44.5)           | 1.98<br>(50.3) | 1.88<br>(47.8)  | 1.63<br>(41.4) | .20<br>(5.0) | .50<br>(12.7) | 1.92<br>(48.8)  | .50<br>(12.7)  | .08<br>(2.0)   |
| 1.5 x 3<br>(38.1) x (76.2) | 1.75<br>(44.5)           | 3.06<br>(77.7) | 1.88<br>(47.8)  | 2.63<br>(66.8) | .20<br>(5.0) | .50<br>(12.7) | 3.00<br>(76.2)  |                | .10<br>(2.5)   |
| 2 x 2<br>(50.8) x (50.8)   | 2.17<br>(55.1)           | 1.98<br>(50.3) | 2.29<br>(58.2)  | 1.57<br>(39.9) | .20<br>(5.0) | .50<br>(12.7) | 1.92<br>(48.8)  | .50<br>(12.7)  | .08<br>(2.0)   |
| 2 x 3<br>(50.8) x (76.2)   | 2.17<br>(55.1)           | 3.06<br>(77.7) | 2.29<br>(58.2)  | 2.63<br>(66.8) | .20<br>(5.0) | .50<br>(12.7) | 3.00<br>(76.2)  |                | .50<br>(12.7)  |
| 2 x 4<br>(50.8) x (101.6)  | 2.17<br>(55.1)           | 4.1<br>(104.1) | 4.38<br>(111.3) | 3.63<br>(92.2) | .20<br>(5.0) | .50<br>(12.7) | 4.00<br>(101.6) | .50<br>(12.7)  | .10<br>(2.7)   |
| 3 x 3<br>(76.2) x (76.2)   | 3.25<br>(82.6)           | 3.06<br>(77.7) | 3.38<br>(85.9)  | 2.63<br>(66.8) | .20<br>(5.0) | .50<br>(12.7) | 3.00<br>(76.2)  |                | 1.00<br>(25.4) |
| 3 x 4<br>(76.2) x (101.6)  | 3.25<br>(82.6)           | 4.1<br>(104.1) | 3.38<br>(85.9)  | 3.63<br>(92.2) | .20<br>(5.0) | .50<br>(12.7) | 4.00<br>(101.6) | 1.00<br>(25.4) | .11<br>(2.8)   |
| 4 x 4<br>(101.6) x (101.6) | 4.25<br>(108.0)          | 4.1<br>(104.1) | 4.38<br>(111.3) | 3.63<br>(92.2) | .20<br>(5.0) | .50<br>(12.7) | 4.00<br>(101.6) |                | 1.50<br>(38.1) |

For 2", 3", and 4" wide duct.

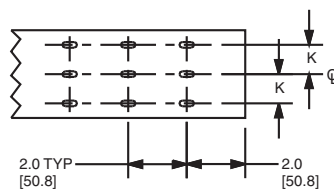

2.0 TYP [50.8]

A.  
System  
Overview

B1.  
Cable Ties

B2.  
Cable  
Accessories

B3.  
Stainless  
Steel Ties

C1.  
Wiring  
Duct

C2.  
Surface  
Raceway

C3.  
Abrasion  
Protection

C4.  
Cable  
Management

D1.  
Terminals

D2.  
Power  
Connectors

D3.  
Grounding  
Connectors

E1.  
Labeling  
Systems

E2.  
Labels

E3.  
Pre-Printed  
& Write-On  
Markers

E4.  
Permanent  
Identification

E5.  
Lockout/  
Tagout  
& Safety  
Solutions

F.  
Index

A. System Overview

### Panduit® Type FL Wiring Duct Dimensions

Dimensions are shown for reference only.

Dimensions are in mm (in.). Contact Panduit Customer Service at 800-777-3300 for specific dimensional needs.

B1. Cable Ties

B2. Cable Accessories

B3. Stainless Steel Ties

C1. Wiring Duct

C2. Surface Raceway

C3. Abrasion Protection

C4. Cable Management

D1. Terminals

D2. Power Connectors

D3. Grounding Connectors

E1. Labeling Systems

E2. Labels

E3. Pre-Printed & Write-On Markers

E4. Permanent Identification

E5. Lockout/Tagout & Safety Solutions

F. Index

Mounting Hole Dimensions  
For FL12X12LG-A

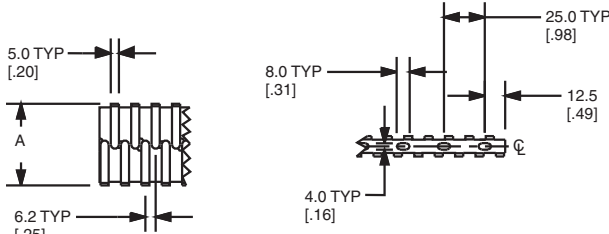

For FL25X25LG-A and FL50X50LG-A

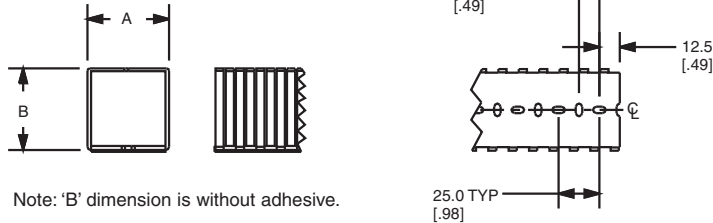

Note: 'B' dimension is without adhesive.

| Nominal Duct Size<br>(W x H)<br>mm | Dimensions –<br>mm (In.) |               |
|------------------------------------|--------------------------|---------------|
|                                    | A                        | B             |
| 12 x 12<br>(.49) x (.49)           | 12.4<br>(.49)            | 12.4<br>(.49) |
| 25 x 25<br>(.98) x (.98)           | 24.9<br>(.98)            | 24.9<br>(.98) |
| 50 x 50<br>(1.97) x (1.97)         | 50<br>(1.97)             | 50<br>(1.97)  |

Note: Type FL wiring duct has factory applied adhesive. For 50 x 50 two strips of tape are used; otherwise, only one strip is centered on the part.

### Panduit® PanelMax™ DIN Rail Wiring Duct – Wirefill Capacity

| Nominal Duct Size<br>(W x H)<br>In. | Area per<br>channel<br>In. <sup>2</sup> | Electrical |      |        |      |        |      |        |      |        |      |        |      |        |        | Communication |        |             |      |      |      |     |
|-------------------------------------|---|------------|------|--------|------|--------|------|--------|------|--------|------|--------|------|--------|--------|---------------|--------|-------------|------|------|------|-----|
|                                     |   | 8 AWG      |      | 10 AWG |      | 12 AWG |      | 14 AWG |      | 16 AWG |      | 18 AWG |      | 22 AWG | 23 AWG | 23/24 AWG     | 24 AWG | Fiber Cable |      |      |      |     |
|                                     |   | .216       | .164 | .130   | .141 | .152   | .111 | .124   | .133 | .096   | .111 | .118   | .084 | .100   | .106   | .085          | .298   | .289        | .250 | .187 | .118 |     |
| DRD22                               | 6.25 x 2.15                             | 4.760      | 51   | 88     | 140  | 119    | 103  | 193    | 154  | 134    | 258  | 193    | 170  | 337    | 238    | 211           | 329    | 26          | 28   | 38   | 68   | 170 |
| DRD33                               | 7.25 x 3.16                             | 6.536      | 70   | 121    | 193  | 164    | 141  | 265    | 212  | 184    | 354  | 265    | 234  | 463    | 326    | 290           | 452    | 36          | 39   | 52   | 93   | 234 |
| DRD44                               | 8.25 x 4.16                             | 9.180      | 98   | 170    | 271  | 230    | 198  | 372    | 298  | 259    | 498  | 372    | 329  | 650    | 459    | 408           | 635    | 51          | 54   | 73   | 131  | 329 |

Table shows maximum wirefill per channel based on 50% of duct internal cross sectional area. Formula = internal area/2.00 x D<sup>2</sup>.

### Panduit® PanelMax™ Corner Wiring Duct – Wirefill Capacity

| Nominal Duct Size<br>(W x H)<br>In. | Area<br>In. <sup>2</sup> | Electrical |      |        |      |        |      |        |      |        |      |        |      |        |        | Communication |        |             |      |      |     |
|-------------------------------------|--------------------------|------------|------|--------|------|--------|------|--------|------|--------|------|--------|------|--------|--------|---------------|--------|-------------|------|------|-----|
|                                     |                          | 8 AWG      |      | 10 AWG |      | 12 AWG |      | 14 AWG |      | 16 AWG |      | 18 AWG |      | 22 AWG | 23 AWG | 23/24 AWG     | 24 AWG | Fiber Cable |      |      |     |
|                                     |                          | .216       | .164 | .130   | .141 | .152   | .111 | .124   | .133 | .096   | .111 | .118   | .084 | .100   | .106   | .085          | .330   | .250        | .190 | .118 |     |
| CWD3                                | 4.4 x 3.6                | 17.580     | 188  | 326    | 520  | 442    | 380  | 713    | 571  | 496    | 953  | 713    | 631  | 1245   | 879    | 782           | 1216   | 80          | 140  | 243  | 630 |
| CWD4                                | 5.4 x 4.6                | 26.920     | 288  | 500    | 796  | 677    | 582  | 1092   | 875  | 760    | 1460 | 1092   | 966  | 1907   | 1346   | 1197          | 1862   | 123         | 215  | 372  | 964 |

Table shows maximum wirefill based on 50% of duct internal cross sectional area. Formula = area/2.00 x D<sup>2</sup>.

### Panduit® Type H, HN, and HS Wiring Duct – Wirefill Capacity

| Nominal Duct Size<br>(W x H)<br>In. | Nominal Area<br>In. <sup>2</sup> | Electrical |      |        |      |        |      |        |      |        |      |        |      |        |        | Communication |        |             |      |      |
|-------------------------------------|----------------------------------|------------|------|--------|------|--------|------|--------|------|--------|------|--------|------|--------|--------|---------------|--------|-------------|------|------|
|                                     |                                  | 8 AWG      |      | 10 AWG |      | 12 AWG |      | 14 AWG |      | 16 AWG |      | 18 AWG |      | 22 AWG | 23 AWG | 23/24 AWG     | 24 AWG | Fiber Cable |      |      |
|                                     |                                  | .216       | .164 | .130   | .141 | .152   | .111 | .124   | .133 | .096   | .111 | .118   | .084 | .100   | .106   | .085          | .330   | .250        | .190 | .118 |
| 1.50 x 2.00                         | 3.000                            | 34         | 60   | 95     | 81   | 70     | 131  | 105    | 91   | 175    | 131  | 116    | 229  | 162    | 144    | 224           | 14     | 25          | 44   | 116  |
| 1.50 x 3.00                         | 4.500                            | 52         | 90   | 143    | 122  | 105    | 197  | 158    | 137  | 263    | 197  | 174    | 344  | 243    | 216    | 336           | 22     | 38          | 67   | 174  |
| 2.00 x 2.00                         | 4.000                            | 46         | 80   | 127    | 108  | 93     | 175  | 140    | 122  | 234    | 175  | 155    | 306  | 216    | 192    | 299           | 19     | 34          | 59   | 154  |
| 2.00 x 3.00                         | 6.000                            | 69         | 120  | 191    | 163  | 140    | 263  | 210    | 183  | 351    | 263  | 232    | 459  | 324    | 288    | 448           | 29     | 51          | 89   | 232  |
| 2.00 x 4.00                         | 8.000                            | 92         | 160  | 255    | 217  | 187    | 350  | 281    | 244  | 469    | 350  | 310    | 612  | 432    | 384    | 598           | 39     | 69          | 119  | 309  |
| 3.00 x 3.00                         | 9.000                            | 104        | 180  | 287    | 244  | 210    | 394  | 316    | 275  | 527    | 394  | 349    | 689  | 486    | 432    | 673           | 44     | 77          | 134  | 348  |
| 3.00 x 4.00                         | 12.000                           | 139        | 241  | 383    | 326  | 280    | 526  | 421    | 366  | 703    | 526  | 465    | 919  | 648    | 577    | 897           | 59     | 103         | 179  | 464  |
| 4.00 x 4.00                         | 16.000                           | 185        | 321  | 511    | 435  | 374    | 701  | 562    | 488  | 938    | 701  | 621    | 1225 | 864    | 769    | 1197          | 79     | 138         | 239  | 619  |

Table shows maximum wirefill based on 50% of duct internal cross sectional area. Formula = nominal area/1.85 x D<sup>2</sup>. See page C1.48 for wiring duct color and size availability. AWG dimensions represent typical outer cable diameter in inches.



### Panduit® Type D, G, F and FS Wiring Duct – Wirefill Capacity

| Nominal Duct Size (W x H) In. | Nominal Area In. <sup>2</sup> | Electrical |      |        |      |      |        |      |      |        |      |      |        |      |      |        | Communication |        |         |        |           |        |             |
|-------------------------------|-------------------------------|------------|------|--------|------|------|--------|------|------|--------|------|------|--------|------|------|--------|---------------|--------|---------|--------|-----------|--------|-------------|
|                               |                               | 8 AWG      |      | 10 AWG |      |      | 12 AWG |      |      | 14 AWG |      |      | 16 AWG |      |      | 18 AWG |               |        | 22 AWG  | 23 AWG | 23/24 AWG | 24 AWG | Fiber Cable |
|                               |                               | .216       | .164 | .13    | .141 | .152 | .111   | .124 | .133 | .096   | .111 | .118 | .084   | .100 | .106 | .085   | .330          | .25    | .190    | .118   |           |        |             |
|                               |                               | THHN       | THHN | THHN   | MTW  | MTW  | THHN   | MTW  | MTW  | TFFN   | MTW  | MTW  | TFFN   | MTW  | MTW  | MTW    | Cat. 6A       | Cat. 6 | Cat. 5e | 3.0 mm |           |        |             |
| 0.50 x 0.50                   | 0.250                         | 3          | 5    | 8      | 7    | 6    | 11     | 9    | 8    | 15     | 11   | 10   | 20     | 14   | 12   | 19     | 1             | 2      | 3       | 10     |           |        |             |
| 0.50 x 1.00                   | 0.500                         | 6          | 10   | 16     | 14   | 12   | 23     | 18   | 16   | 31     | 23   | 20   | 40     | 28   | 25   | 39     | 2             | 4      | 7       | 20     |           |        |             |
| 0.50 x 2.00                   | 1.000                         | 12         | 21   | 33     | 28   | 24   | 46     | 37   | 32   | 62     | 46   | 41   | 80     | 57   | 50   | 79     | 5             | 9      | 15      | 40     |           |        |             |
| 0.75 x 0.75                   | 0.563                         | 6          | 11   | 19     | 16   | 13   | 26     | 20   | 18   | 34     | 26   | 23   | 45     | 32   | 28   | 44     | 2             | 5      | 8       | 23     |           |        |             |
| 0.75 x 1.00                   | 0.750                         | 9          | 15   | 25     | 21   | 18   | 34     | 27   | 24   | 46     | 34   | 30   | 60     | 42   | 38   | 59     | 3             | 6      | 11      | 30     |           |        |             |
| 0.75 x 1.50                   | 1.125                         | 13         | 23   | 38     | 32   | 27   | 52     | 41   | 36   | 69     | 52   | 46   | 91     | 64   | 57   | 88     | 5             | 10     | 17      | 46     |           |        |             |
| 0.75 x 2.00                   | 1.500                         | 18         | 31   | 50     | 43   | 37   | 69     | 55   | 48   | 93     | 69   | 61   | 121    | 85   | 76   | 118    | 7             | 13     | 23      | 61     |           |        |             |
| 1.00 x 1.00                   | 1.000                         | 12         | 21   | 33     | 28   | 24   | 46     | 37   | 32   | 62     | 46   | 41   | 80     | 57   | 50   | 79     | 5             | 9      | 15      | 40     |           |        |             |
| 1.00 x 1.50                   | 1.500                         | 18         | 31   | 50     | 43   | 37   | 69     | 55   | 48   | 93     | 69   | 61   | 121    | 85   | 76   | 118    | 7             | 13     | 23      | 61     |           |        |             |
| 1.00 x 2.00                   | 2.000                         | 24         | 42   | 67     | 57   | 49   | 92     | 74   | 64   | 124    | 92   | 82   | 161    | 114  | 101  | 158    | 10            | 18     | 31      | 81     |           |        |             |
| 1.00 x 3.00                   | 3.000                         | 36         | 63   | 101    | 86   | 74   | 139    | 111  | 96   | 186    | 139  | 123  | 242    | 171  | 152  | 237    | 15            | 27     | 47      | 122    |           |        |             |
| 1.00 x 4.00                   | 4.000                         | 48         | 84   | 135    | 114  | 98   | 185    | 148  | 129  | 248    | 185  | 164  | 323    | 228  | 203  | 316    | 20            | 36     | 63      | 163    |           |        |             |
| 1.50 x 1.00                   | 1.500                         | 18         | 31   | 50     | 43   | 37   | 69     | 55   | 48   | 93     | 69   | 61   | 121    | 85   | 76   | 118    | 7             | 13     | 23      | 61     |           |        |             |
| 1.50 x 1.50                   | 2.250                         | 27         | 47   | 76     | 64   | 55   | 104    | 83   | 72   | 139    | 104  | 92   | 182    | 128  | 114  | 177    | 11            | 20     | 35      | 92     |           |        |             |
| 1.50 x 2.00                   | 3.000                         | 36         | 63   | 101    | 86   | 74   | 139    | 111  | 96   | 186    | 139  | 123  | 242    | 171  | 152  | 237    | 15            | 27     | 47      | 122    |           |        |             |
| 1.50 x 3.00                   | 4.500                         | 55         | 95   | 152    | 129  | 111  | 208    | 167  | 145  | 279    | 208  | 184  | 364    | 257  | 228  | 355    | 23            | 41     | 71      | 184    |           |        |             |
| 1.50 x 4.00                   | 6.000                         | 73         | 127  | 202    | 172  | 148  | 278    | 222  | 193  | 372    | 278  | 246  | 485    | 342  | 305  | 474    | 31            | 54     | 94      | 245    |           |        |             |
| 2.00 x 1.00                   | 2.000                         | 24         | 42   | 67     | 57   | 49   | 92     | 74   | 64   | 124    | 92   | 82   | 161    | 114  | 101  | 158    | 10            | 18     | 31      | 81     |           |        |             |
| 2.00 x 1.50                   | 3.000                         | 36         | 63   | 101    | 86   | 74   | 139    | 111  | 96   | 186    | 139  | 123  | 242    | 171  | 152  | 237    | 15            | 27     | 47      | 122    |           |        |             |
| 2.00 x 2.00                   | 4.000                         | 48         | 84   | 135    | 114  | 98   | 185    | 148  | 129  | 248    | 185  | 164  | 323    | 228  | 203  | 316    | 20            | 36     | 63      | 163    |           |        |             |
| 2.00 x 3.00                   | 6.000                         | 73         | 127  | 202    | 172  | 148  | 278    | 222  | 193  | 372    | 278  | 246  | 485    | 342  | 305  | 474    | 31            | 54     | 94      | 245    |           |        |             |
| 2.00 x 4.00                   | 8.000                         | 97         | 169  | 270    | 229  | 197  | 371    | 297  | 258  | 496    | 371  | 328  | 647    | 457  | 406  | 632    | 41            | 73     | 126     | 327    |           |        |             |
| 2.00 x 5.00                   | 10.000                        | 122        | 212  | 338    | 287  | 247  | 463    | 371  | 323  | 620    | 463  | 410  | 809    | 571  | 508  | 790    | 52            | 91     | 158     | 409    |           |        |             |
| 2.50 x 3.00                   | 7.500                         | 91         | 159  | 253    | 215  | 185  | 347    | 278  | 242  | 465    | 347  | 307  | 607    | 428  | 381  | 593    | 39            | 68     | 118     | 307    |           |        |             |
| 3.00 x 1.00                   | 3.000                         | 36         | 63   | 101    | 86   | 74   | 139    | 111  | 96   | 186    | 139  | 123  | 242    | 171  | 152  | 237    | 15            | 27     | 47      | 122    |           |        |             |
| 3.00 x 2.00                   | 6.000                         | 73         | 127  | 202    | 172  | 148  | 278    | 222  | 193  | 372    | 278  | 246  | 485    | 342  | 305  | 474    | 31            | 54     | 94      | 245    |           |        |             |
| 3.00 x 3.00                   | 9.000                         | 110        | 191  | 304    | 258  | 222  | 417    | 334  | 290  | 558    | 417  | 369  | 728    | 514  | 457  | 711    | 47            | 82     | 142     | 368    |           |        |             |
| 3.00 x 4.00                   | 12.000                        | 146        | 254  | 405    | 344  | 296  | 556    | 445  | 387  | 744    | 556  | 492  | 971    | 685  | 610  | 949    | 62            | 109    | 189     | 491    |           |        |             |
| 3.00 x 5.00                   | 15.000                        | 183        | 318  | 507    | 431  | 370  | 695    | 557  | 484  | 930    | 695  | 615  | 1214   | 857  | 762  | 1186   | 78            | 137    | 237     | 614    |           |        |             |
| 4.00 x 1.50                   | 6.000                         | 73         | 127  | 202    | 172  | 148  | 278    | 222  | 193  | 372    | 278  | 246  | 485    | 342  | 305  | 474    | 31            | 54     | 94      | 245    |           |        |             |
| 4.00 x 2.00                   | 8.000                         | 97         | 169  | 270    | 229  | 197  | 371    | 297  | 258  | 496    | 371  | 328  | 647    | 457  | 406  | 632    | 41            | 73     | 126     | 327    |           |        |             |
| 4.00 x 3.00                   | 12.000                        | 146        | 254  | 405    | 344  | 296  | 556    | 445  | 387  | 744    | 556  | 492  | 971    | 685  | 610  | 949    | 62            | 109    | 189     | 491    |           |        |             |
| 4.00 x 4.00                   | 16.000                        | 195        | 339  | 540    | 459  | 395  | 742    | 594  | 516  | 992    | 742  | 656  | 1295   | 914  | 813  | 1265   | 83            | 146    | 253     | 655    |           |        |             |
| 4.00 x 5.00                   | 20.000                        | 244        | 424  | 676    | 574  | 494  | 927    | 743  | 646  | 1240   | 927  | 820  | 1619   | 1142 | 1017 | 1581   | 104           | 182    | 316     | 819    |           |        |             |
| 6.00 x 4.00                   | 24.000                        | 293        | 509  | 811    | 689  | 593  | 1113   | 891  | 775  | 1488   | 1113 | 984  | 1943   | 1371 | 1220 | 1898   | 125           | 219    | 379     | 983    |           |        |             |

Table shows maximum wirefill based on 50% of duct internal cross sectional area. Formula = nominal area/1.75 x D<sup>2</sup>. See page C1.48 for wiring duct color and size availability. Not all sizes available for each duct type.  
 AWG dimensions represent typical outer cable diameter in inches.

A. System Overview

B1. Cable Ties

B2. Cable Accessories

B3. Stainless Steel Ties

C1. Wiring Duct

C2. Surface Raceway

C3. Abrasion Protection

C4. Cable Management

D1. Terminals

D2. Power Connectors

D3. Grounding Connectors

E1. Labeling Systems

E2. Labels

E3. Pre-Printed & Write-On Markers

E4. Permanent Identification

E5. Lockout/Tagout & Safety Solutions

F. Index

A.  
System  
Overview

### Panduct® Type MC and NNC Wiring Duct – Wirefill Capacity

B1.  
Cable Ties

B2.  
Cable  
Accessories

B3.  
Stainless  
Steel Ties

C1.  
Wiring  
Duct

C2.  
Surface  
Raceway

C3.  
Abrasion  
Protection

C4.  
Cable  
Management

D1.  
Terminals

D2.  
Power  
Connectors

D3.  
Grounding  
Connectors

E1.  
Labeling  
Systems

E2.  
Labels

E3.  
Pre-Printed  
& Write-On  
Markers

E4.  
Permanent  
Identification

E5.  
Lockout/  
Tagout  
& Safety  
Solutions

F.  
Index

| Nominal Duct Size (W x H) mm | Nominal Area mm <sup>2</sup> | Electrical |      |        |     |        |      |     |        |      |     |        |      |        |     |      | Communication |        |           |        |             |
|------------------------------|------------------------------|------------|------|--------|-----|--------|------|-----|--------|------|-----|--------|------|--------|-----|------|---------------|--------|-----------|--------|-------------|
|                              |                              | 8 AWG      |      | 10 AWG |     | 12 AWG |      |     | 14 AWG |      |     | 16 AWG |      | 18 AWG |     |      | 22 AWG        | 23 AWG | 23/24 AWG | 24 AWG | Fiber Cable |
|                              |                              | 5.5        | 4.2  | 3.3    | 3.6 | 3.9    | 2.8  | 3.1 | 3.4    | 2.4  | 2.8 | 3      | 2.1  | 2.5    | 2.7 | 2.2  | 8.4           | 6.4    | 4.8       | 3      |             |
|                              |                              | THHN       | THHN | THHN   | MTW | MTW    | THHN | MTW | MTW    | TFFN | MTW | MTW    | TFFN | MTW    | MTW | MTW  | Cat. 6A       | Cat. 6 | Cat. 5e   | 3.0 mm |             |
| 25 x 25                      | 625                          | 11         | 20   | 32     | 27  | 23     | 44   | 36  | 31     | 60   | 44  | 39     | 78   | 55     | 49  | 76   | 5             | 8      | 15        | 39     |             |
| 25 x 37                      | 925                          | 17         | 30   | 48     | 41  | 35     | 66   | 53  | 46     | 88   | 66  | 58     | 116  | 81     | 72  | 113  | 7             | 13     | 22        | 58     |             |
| 25 x 50                      | 1250                         | 23         | 41   | 65     | 55  | 47     | 89   | 72  | 62     | 120  | 89  | 79     | 156  | 110    | 98  | 153  | 10            | 17     | 30        | 79     |             |
| 25 x 62                      | 1550                         | 29         | 51   | 81     | 69  | 59     | 111  | 89  | 77     | 148  | 111 | 98     | 194  | 137    | 122 | 190  | 12            | 21     | 38        | 98     |             |
| 25 x 75                      | 1875                         | 35         | 61   | 98     | 83  | 71     | 134  | 108 | 93     | 180  | 134 | 119    | 235  | 166    | 147 | 229  | 15            | 26     | 46        | 119    |             |
| 37 x 37                      | 1369                         | 25         | 45   | 71     | 60  | 52     | 98   | 78  | 68     | 131  | 98  | 87     | 171  | 121    | 107 | 167  | 11            | 19     | 33        | 86     |             |
| 37 x 50                      | 1850                         | 35         | 60   | 96     | 82  | 70     | 132  | 106 | 92     | 177  | 132 | 117    | 232  | 163    | 145 | 226  | 15            | 26     | 45        | 117    |             |
| 37 x 62                      | 2294                         | 43         | 75   | 120    | 102 | 87     | 164  | 132 | 114    | 220  | 164 | 145    | 287  | 203    | 180 | 281  | 18            | 32     | 56        | 145    |             |
| 37 x 75                      | 2775                         | 52         | 91   | 145    | 123 | 106    | 199  | 159 | 138    | 266  | 199 | 176    | 348  | 245    | 218 | 340  | 22            | 39     | 68        | 176    |             |
| 50 x 50                      | 2500                         | 47         | 82   | 131    | 111 | 95     | 179  | 144 | 125    | 240  | 179 | 159    | 313  | 221    | 197 | 306  | 20            | 35     | 61        | 158    |             |
| 50 x 75                      | 3750                         | 71         | 123  | 196    | 167 | 143    | 269  | 216 | 187    | 360  | 269 | 238    | 470  | 332    | 295 | 459  | 30            | 53     | 92        | 238    |             |
| 50 x 100                     | 5000                         | 94         | 164  | 262    | 222 | 191    | 359  | 288 | 250    | 480  | 359 | 318    | 627  | 442    | 394 | 612  | 40            | 70     | 122       | 317    |             |
| 62 x 62                      | 3844                         | 72         | 126  | 201    | 171 | 147    | 276  | 221 | 192    | 369  | 276 | 244    | 482  | 340    | 303 | 471  | 31            | 54     | 94        | 244    |             |
| 75 x 50                      | 3750                         | 71         | 123  | 196    | 167 | 143    | 269  | 216 | 187    | 360  | 269 | 238    | 470  | 332    | 295 | 459  | 30            | 53     | 92        | 238    |             |
| 75 x 62                      | 4650                         | 88         | 153  | 243    | 207 | 178    | 334  | 267 | 232    | 446  | 334 | 295    | 583  | 411    | 366 | 570  | 37            | 65     | 114       | 295    |             |
| 75 x 75                      | 5625                         | 106        | 185  | 294    | 250 | 215    | 404  | 324 | 281    | 540  | 404 | 357    | 706  | 498    | 443 | 689  | 45            | 79     | 138       | 357    |             |
| 75 x 100                     | 7500                         | 142        | 246  | 393    | 334 | 287    | 539  | 432 | 375    | 720  | 539 | 477    | 941  | 664    | 591 | 919  | 60            | 106    | 184       | 476    |             |
| 100 x 50                     | 5000                         | 94         | 164  | 262    | 222 | 191    | 359  | 288 | 250    | 480  | 359 | 318    | 627  | 442    | 394 | 612  | 40            | 70     | 122       | 317    |             |
| 100 x 75                     | 7500                         | 142        | 246  | 393    | 334 | 287    | 539  | 432 | 375    | 720  | 539 | 477    | 941  | 664    | 591 | 919  | 60            | 106    | 184       | 476    |             |
| 100 x 100                    | 10000                        | 189        | 329  | 524    | 445 | 383    | 718  | 576 | 500    | 961  | 718 | 636    | 1255 | 885    | 788 | 1225 | 81            | 141    | 245       | 634    |             |

Table shows maximum wirefill based on 50% of duct internal cross sectional area. Formula = nominal area/1.75 x D<sup>2</sup>. See page C1.48 for wiring duct color and size availability. Not all sizes available for each duct type.  
AWG dimensions represent typical outer cable diameter in millimeters.

### Panduct® Type NE Wiring Duct – Wirefill Capacity

| Nominal Duct Size (W x H) In. | Nominal Area In. <sup>2</sup> | Electrical |      |        |      |      |        |      |      |        |      |      |        |      |      |        | Communication |        |         |        |           |        |             |
|-------------------------------|-------------------------------|------------|------|--------|------|------|--------|------|------|--------|------|------|--------|------|------|--------|---------------|--------|---------|--------|-----------|--------|-------------|
|                               |                               | 8 AWG      |      | 10 AWG |      |      | 12 AWG |      |      | 14 AWG |      |      | 16 AWG |      |      | 18 AWG |               |        | 22 AWG  | 23 AWG | 23/24 AWG | 24 AWG | Fiber Cable |
|                               |                               | .216       | .164 | .130   | .141 | .152 | .111   | .124 | .133 | .096   | .111 | .118 | .084   | .100 | .106 | .085   | .330          | .25    | .190    | .118   |           |        |             |
|                               |                               | THHN       | THHN | THHN   | MTW  | MTW  | THHN   | MTW  | MTW  | TFFN   | MTW  | MTW  | TFFN   | MTW  | MTW  | MTW    | Cat. 6A       | Cat. 6 | Cat. 5e | 3.0 mm |           |        |             |
| 0.50 x 0.50                   | 0.250                         | 2          | 4    | 7      | 6    | 5    | 10     | 8    | 7    | 13     | 10   | 8    | 17     | 12   | 11   | 17     | 1             | 2      | 3       | 8      |           |        |             |
| 0.50 x 1.00                   | 0.500                         | 5          | 9    | 14     | 12   | 10   | 20     | 16   | 14   | 27     | 20   | 17   | 35     | 25   | 22   | 34     | 2             | 4      | 6       | 17     |           |        |             |
| 1.00 x 1.00                   | 1.000                         | 10         | 18   | 29     | 25   | 21   | 40     | 32   | 28   | 54     | 40   | 35   | 70     | 50   | 44   | 69     | 4             | 8      | 13      | 35     |           |        |             |
| 1.00 x 1.50                   | 1.500                         | 16         | 27   | 44     | 37   | 32   | 60     | 48   | 42   | 81     | 60   | 53   | 106    | 75   | 66   | 103    | 6             | 12     | 20      | 53     |           |        |             |
| 1.00 x 2.00                   | 2.000                         | 21         | 37   | 59     | 50   | 43   | 81     | 65   | 56   | 108    | 81   | 71   | 141    | 100  | 88   | 138    | 9             | 16     | 27      | 71     |           |        |             |
| 1.00 x 3.00                   | 3.000                         | 32         | 55   | 88     | 75   | 64   | 121    | 97   | 84   | 162    | 121  | 107  | 212    | 150  | 133  | 207    | 13            | 24     | 41      | 107    |           |        |             |
| 1.00 x 4.00                   | 4.000                         | 42         | 74   | 118    | 100  | 86   | 162    | 130  | 113  | 217    | 162  | 143  | 283    | 200  | 177  | 276    | 18            | 32     | 55      | 143    |           |        |             |
| 1.50 x 1.50                   | 2.250                         | 24         | 41   | 66     | 56   | 48   | 91     | 73   | 63   | 122    | 91   | 80   | 159    | 112  | 100  | 155    | 10            | 18     | 31      | 80     |           |        |             |
| 1.50 x 2.00                   | 3.000                         | 32         | 55   | 88     | 75   | 64   | 121    | 97   | 84   | 162    | 121  | 107  | 212    | 150  | 133  | 207    | 13            | 24     | 41      | 107    |           |        |             |
| 1.50 x 3.00                   | 4.500                         | 48         | 83   | 133    | 113  | 97   | 182    | 146  | 127  | 244    | 182  | 161  | 318    | 225  | 200  | 311    | 20            | 36     | 62      | 161    |           |        |             |
| 1.50 x 4.00                   | 6.000                         | 64         | 111  | 177    | 150  | 129  | 243    | 195  | 169  | 325    | 243  | 215  | 425    | 300  | 266  | 415    | 27            | 48     | 83      | 215    |           |        |             |
| 2.00 x 1.00                   | 2.000                         | 21         | 37   | 59     | 50   | 43   | 81     | 65   | 56   | 108    | 81   | 71   | 141    | 100  | 88   | 138    | 9             | 16     | 27      | 71     |           |        |             |
| 2.00 x 2.00                   | 4.000                         | 42         | 74   | 118    | 100  | 86   | 162    | 130  | 113  | 217    | 162  | 143  | 283    | 200  | 177  | 276    | 18            | 32     | 55      | 143    |           |        |             |
| 2.00 x 3.00                   | 6.000                         | 64         | 111  | 177    | 150  | 129  | 243    | 195  | 169  | 325    | 243  | 215  | 425    | 300  | 266  | 415    | 27            | 48     | 83      | 215    |           |        |             |
| 2.00 x 4.00                   | 8.000                         | 85         | 148  | 236    | 201  | 173  | 324    | 260  | 226  | 434    | 324  | 287  | 566    | 400  | 355  | 553    | 36            | 64     | 110     | 286    |           |        |             |
| 3.00 x 1.00                   | 3.000                         | 32         | 55   | 88     | 75   | 64   | 121    | 97   | 84   | 162    | 121  | 107  | 212    | 150  | 133  | 205    | 13            | 24     | 41      | 107    |           |        |             |
| 3.00 x 2.00                   | 6.000                         | 64         | 111  | 177    | 150  | 129  | 243    | 195  | 169  | 325    | 243  | 215  | 425    | 300  | 266  | 415    | 27            | 48     | 83      | 215    |           |        |             |
| 3.00 x 3.00                   | 9.000                         | 96         | 167  | 266    | 226  | 194  | 365    | 292  | 254  | 488    | 365  | 323  | 637    | 450  | 400  | 622    | 41            | 72     | 124     | 322    |           |        |             |
| 3.00 x 4.00                   | 12.000                        | 128        | 223  | 355    | 301  | 259  | 486    | 390  | 339  | 651    | 486  | 430  | 850    | 600  | 533  | 830    | 55            | 96     | 166     | 430    |           |        |             |
| 3.00 x 5.00                   | 15.000                        | 160        | 278  | 443    | 377  | 324  | 608    | 487  | 423  | 813    | 608  | 538  | 1062   | 750  | 667  | 1038   | 68            | 120    | 207     | 537    |           |        |             |
| 4.00 x 2.00                   | 8.000                         | 85         | 148  | 236    | 201  | 173  | 324    | 260  | 226  | 434    | 324  | 287  | 566    | 400  | 355  | 553    | 36            | 64     | 110     | 286    |           |        |             |
| 4.00 x 3.00                   | 12.000                        | 128        | 223  | 355    | 301  | 259  | 486    | 390  | 339  | 651    | 486  | 430  | 850    | 600  | 533  | 830    | 55            | 96     | 166     | 430    |           |        |             |
| 4.00 x 4.00                   | 16.000                        | 171        | 297  | 473    | 402  | 346  | 649    | 520  | 452  | 868    | 649  | 574  | 1133   | 800  | 711  | 1107   | 73            | 128    | 221     | 573    |           |        |             |
| 4.00 x 5.00                   | 20.000                        | 214        | 371  | 591    | 502  | 432  | 811    | 650  | 565  | 1085   | 811  | 718  | 1417   | 1000 | 889  | 1384   | 91            | 160    | 277     | 716    |           |        |             |

Table shows maximum wirefill based on 50% of duct internal cross sectional area. Formula = nominal area/2.00 x D<sup>2</sup>. AWG dimensions represent typical outer cable diameter in inches.

### Panduct® Type FL Wiring Duct – Wirefill Capacity

| Nominal Duct Size (W x H) mm | Nominal Area mm <sup>2</sup> | Electrical |      |        |     |     |        |     |     |        |     |     |        |     |     |        | Communication |        |         |        |           |        |             |
|------------------------------|------------------------------|------------|------|--------|-----|-----|--------|-----|-----|--------|-----|-----|--------|-----|-----|--------|---------------|--------|---------|--------|-----------|--------|-------------|
|                              |                              | 8 AWG      |      | 10 AWG |     |     | 12 AWG |     |     | 14 AWG |     |     | 16 AWG |     |     | 18 AWG |               |        | 22 AWG  | 23 AWG | 23/24 AWG | 24 AWG | Fiber Cable |
|                              |                              | 5.5        | 4.2  | 3.3    | 3.6 | 3.9 | 2.8    | 3.1 | 3.4 | 2.4    | 2.8 | 3.0 | 2.1    | 2.5 | 2.7 | 2.2    | 8.4           | 6.4    | 4.8     | 3.0    |           |        |             |
|                              |                              | THHN       | THHN | THHN   | MTW | MTW | THHN   | MTW | MTW | TFFN   | MTW | MTW | TFFN   | MTW | MTW | MTW    | Cat. 6A       | Cat. 6 | Cat. 5e | 3.0 mm |           |        |             |
| 12 x 12                      | 144                          | 1          | 3    | 5      | 4   | 3   | 7      | 5   | 5   | 9      | 7   | 6   | 12     | 8   | 7   | 12     | 0             | 1      | 2       | 6      |           |        |             |
| 25 x 25                      | 625                          | 8          | 14   | 22     | 19  | 16  | 31     | 25  | 21  | 42     | 31  | 27  | 54     | 38  | 34  | 53     | 3             | 6      | 10      | 27     |           |        |             |
| 50 x 50                      | 2500                         | 33         | 57   | 91     | 77  | 67  | 125    | 100 | 87  | 168    | 125 | 111 | 219    | 155 | 137 | 214    | 14            | 24     | 42      | 111    |           |        |             |

Table shows maximum wirefill based on 50% of duct internal cross sectional area. Formula = nominal area/2.50 x D<sup>2</sup>. AWG dimensions represent typical outer cable diameter in millimeters.

A. System Overview

B1. Cable Ties

B2. Cable Accessories

B3. Stainless Steel Ties

C1. Wiring Duct

C2. Surface Raceway

C3. Abrasion Protection

C4. Cable Management

D1. Terminals

D2. Power Connectors

D3. Grounding Connectors

E1. Labeling Systems

E2. Labels

E3. Pre-Printed & Write-On Markers

E4. Permanent Identification

E5. Lockout/Tagout & Safety Solutions

F. Index

A. System Overview

### Wirefill Formula

B1. Cable Ties

#### General Formula

Panduit Wiring Duct wirefills are calculated using the following general formula:

$$50\% \text{ Wirefill} = 50\% \text{ of } \left( \frac{\text{Usable Duct Area}}{\text{Wire Area}} \right)$$

B2. Cable Accessories

B3. Stainless Steel Ties

#### Why use a 50% Wirefill?

As specified in NFPA79-2007 section 13.5.2, *Percentage Fills of Raceways (Ducts)*, a 50% wirefill is given as the maximum wirefill capacity in all Panduit Wiring Ducts. This helps ensure general safe wiring practices are followed. In actual practice, a 50% wirefill is the maximum amount of wiring the duct can hold given the additional airspace created between cables by non-uniform cable shapes, cable interlacing, and cable packing factors.

C1. Wiring Duct

C2. Surface Raceway

#### What is the Usable Duct Area?

The usable area we define as the calculation of internal area that can be occupied by wires or cables.

##### Calculation of Internal Area

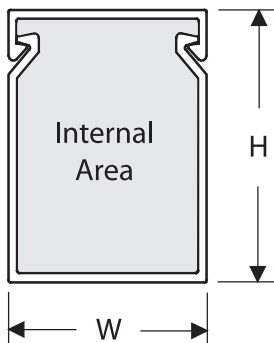

Since we use the outer channel dimensions in our calculation, we make an adjustment in our formula for the thickness of material and for design elements that extend inside the channel.

##### Air Space Allotment

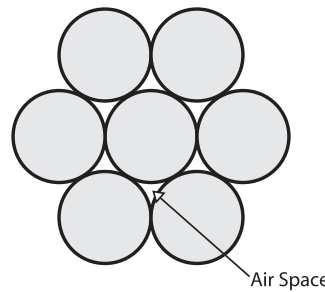

In our wirefill formula an adjustment is made to the channel internal area to account for “unusable” air space that will be present between cables when placed in the channel. Our formula assumes a uniform close packed or high-density cable arrangement (see diagram) (Note 1).

D1. Terminals

D2. Power Connectors

Considering these factors, the usable duct area is equal to an average of 90% of the nominal area, or  $(W \times H) \times .90$ .

D3. Grounding Connectors

#### Wire Area

The wire area formula is converted to allow calculation using the cable diameter:

$$A_{\text{WIRE}} = \pi r^2$$

$$A_{\text{WIRE}} = (\pi/4) \times D^2$$

$$A_{\text{WIRE}} = .785 \times D^2$$

E1. Labeling Systems

E2. Labels

#### Formula Derivation

Inserting the elements from above into the general formula results in the following:

$$50\% \text{ Wirefill} = .50 \left( \frac{(W \times H) \times .90}{.785 \times D^2} \right)$$

Simplifying this formula results in the formula used for wirefill calculation (Note 2):

$$50\% \text{ Wirefill} = \left( \frac{W \times H}{1.75 \times D^2} \right)$$

E3. Pre-Printed & Write-On Markers

E4. Permanent Identification

E5. Lockout/Tagout & Safety Solutions

Note: When calculating wirefill capacity using the above formula, variables W, H, and D must be expressed in same units (i.e. mm or inches).

<sup>1</sup> This calculation does not account for additional airspace created between cables by non-uniform cable shapes, cable interlacing, and cable packing factors.

<sup>2</sup> The resulting formula is used for all Panduit flush cover ducts, this excludes type NE duct which has a different profile design that results in a divisor of  $2.0 \times D^2$  (rather than  $1.75 \times D^2$  as shown here) and type H and HS wiring duct with a profile design that results in a divisor of  $1.85 \times D^2$  and corner wiring duct which uses calculated internal area and a divisor of  $2.0 \times D^2$ .

F. Index

### Panduct® Wiring Duct and Raceway – Material Specifications

| Properties                           | Units             | Test Method | Lead-Free PVC | Halogen-Free Modified PPO (NNC, NE) | Polypropylene (FL) |
|--------------------------------------|-------------------|-------------|---------------|-------------------------------------|--------------------|
| <b>General</b>                       |                   |             |               |                                     |                    |
| Specific gravity                     | g/cc              | ASTM D 792  | 1.45          | 1.09                                | 0.95               |
| Heat deflection temperature @264 psi | °F                | ASTM D 648  | 156           | 215                                 | 117                |
| Thermal expansion                    | 10-5 in/in/°F     | ASTM D 696  | 3.7           | 3.8                                 | N/A                |
| Thermal conductivity                 | (BTU-in/hr-ft²)°F | ASTM C 177  | 1.3           | 1.3                                 | N/A                |
| <b>Burning Characteristics</b>       |                   |             |               |                                     |                    |
| Flammability class                   | —                 | UL 94       | V-0           | V-0                                 | V-2                |
| Smoke density @ 4 minutes            | —                 | ASTM E 662  | 538           | 513                                 | N/A                |
| Limited oxygen index (LOI)           | —                 | ASTM D 2863 | 35            | 30                                  | 25                 |
| Peak heat release rate               | kW/m2             | ASTM E 1354 | N/A           | N/A                                 | N/A                |
| <b>Hardness</b>                      |                   |             |               |                                     |                    |
| Durometer hardness                   | "D"               | ASTM D 2240 | 78            | N/A                                 | N/A                |
| Rockwell hardness                    | "R"               | ASTM D 785  | 111           | 116                                 | N/A                |
| <b>Tensile</b>                       |                   |             |               |                                     |                    |
| Yield Strength                       | psi               | ASTM D 638  | 6,200         | 7,700                               | 3,770              |
| Modulus                              | psi               | ASTM D 638  | 390,000       | 350,000                             | 172,000            |
| <b>Flexural</b>                      |                   |             |               |                                     |                    |
| Yield Strength                       | psi               | ASTM D 790  | 8,700         | 11,500                              | 4,350              |
| Modulus                              | psi               | ASTM D 790  | 325,000       | 340,000                             | 181,250            |
| <b>Impact strength</b>               |                   |             |               |                                     |                    |
| Notched Izod (.125")                 |                   |             |               |                                     |                    |
| 23°C (73°F)                          | ft-lb/in          | ASTM D 256  | 4.0           | 5.0                                 | 1.8                |
| 0°C (32°F)                           | ft-lb/in          |             | 1.6           | 2.0                                 | N/A                |
| <b>Electrical Properties</b>         |                   |             |               |                                     |                    |
| Power factor:                        |                   |             |               |                                     |                    |
| 60 Hz @30°C (86°F)                   | —                 | ASTM D 150  | 2.90          | N/A                                 | N/A                |
| 1 MHz @30°C (86°F)                   | —                 |             | 4.00          | N/A                                 | N/A                |
| Dielectric constant:                 |                   |             |               |                                     |                    |
| 60 Hz @30°C (86°F)                   | —                 | ASTM D 150  | 3.90          | N/A                                 | N/A                |
| 1 MHz @30°C (86°F)                   | —                 |             | 3.30          | N/A                                 | N/A                |
| Dielectric strength:                 |                   |             |               |                                     |                    |
| Unconditioned                        | volts/mil         | ASTM D 149  | 690           | N/A                                 | N/A                |
| Conditioned                          | volts/mil         |             | 700           | N/A                                 | N/A                |

Note: To the best of our knowledge the above information is accurate. Panduit assumes no liability for the accuracy or completeness of this information.

#### Rigid Polyvinyl Chloride (PVC)

A general purpose material for use in indoor applications. PVC has a UL 94 flammability rating of V-0 and is UL Recognized for continuous use temperatures up to 122°F (50°C). PVC is an economical wiring duct material.

#### Halogen-Free (Modified Polyphenylene Oxide)

A special purpose material for use in halogen-free or high temperature applications. Modified PPO has a UL 94 flammability rating of V-0 and is UL Recognized for continuous use temperatures up to 203°F (95°C), and is 20% lighter than PVC.

#### Polypropylene

A flexible material with a UL 94 flammability rating of V-2 and UL Recognized for continuous use temperatures up to 149°F (65°C).

A. System Overview

B1. Cable Ties

B2. Cable Accessories

B3. Stainless Steel Ties

C1. Wiring Duct

C2. Surface Raceway

C3. Abrasion Protection

C4. Cable Management

D1. Terminals

D2. Power Connectors

D3. Grounding Connectors

E1. Labeling Systems

E2. Labels

E3. Pre-Printed & Write-On Markers

E4. Permanent Identification

E5. Lockout/Tagout & Safety Solutions

F. Index





### Installation Tips:

#### Application of Latex Paint on Panduct® Wiring Duct



The following is recommended to properly prepare the surface of the wiring duct/raceway and covers for the best adhesion of latex paint:

1. Clean surface with mild soap and water solution or mineral spirits with a clean lint free towel. Allow to dry.
2. Using a sanding pad (such as synthetic stripping pad or medium/fine steel wool), slightly roughen the surface to be painted.
3. Apply a coat of all-purpose 100% acrylic primer and allow to dry.
4. Apply the desired topcoat of latex paint and allow to dry.
5. Install the wiring duct/raceway and covers.

#### Cutting Wiring Duct and Cover

For small quantities, use the DCT duct cutting tool on page C1.34. For larger quantities use a miter cutting saw blade for clean burr-free cuts. Recommended blade: *Carbide 80T or 100T; .90" thickness, .125 kerf.*

#### Recommended Precaution when Using Type NNC and NE Wiring Duct

Cleaning solvents and cutting fluids that contain any of the following chemical agents should not come in contact with type NNC or type NE wiring duct. These chemicals are known to cause stress cracking in the halogen-free PPO material.

- Hydrocarbons
- Phenols
- Ketones
- Amines
- Ethers
- Organic, inorganic and oxidizing acids
- Petrol

Note: Panduit assumes no liability for the accuracy or completeness of this list.

#### Part Number System for Panduct® Wiring Duct

|                                    |                      |          |                       |                            |               |   |
|------------------------------------|----------------------|----------|-----------------------|----------------------------|---------------|---|
| <b>G</b>                           | <b>.5</b>            | <b>X</b> | <b>.5</b>             | <b>LG</b>                  | <b>6</b>      | <b>-A</b>   |
|                                    |                      |          |                       |                            |               |   |
| <b>Type</b>                        | <b>Nominal Width</b> |          | <b>Nominal Height</b> | <b>Color</b>               | <b>Length</b> |   |
|                                    | In. or mm            |          | In. or mm             |                            | Ft. or m      |   |
| G = Wide Slot<br>Flush Design      |                      |          |                       | LG = Light<br>Gray         |               | -A = Adhesive Backed<br>= Without Adhesive<br>(leave blank) |
| F = Narrow Slot<br>Flush Design    |                      |          |                       | WH = White                 |               | NM = No Mounting Holes                                      |
| FL = Flexible Duct                 |                      |          |                       | BL = Black                 |               |   |
| FS = Solid Wall Flush Design       |                      |          |                       | IB = Intrinsic Blue        |               |   |
| H = Wide Slot Hinged Design        |                      |          |                       | IG = International<br>Gray |               |   |
| HN = Narrow Slot Hinged Design     |                      |          |                       |                            |               |   |
| HS = Solid Wall Hinged Design      |                      |          |                       |                            |               |   |
| D = Round Hole Flush Design        |                      |          |                       |                            |               |   |
| NNC = Halogen-Free Design          |                      |          |                       |                            |               |   |
| NE = Halogen-Free Wide Slot Design |                      |          |                       |                            |               |   |
| MC = Metric Narrow Slot Design     |                      |          |                       |                            |               |   |

A.  
System  
Overview

### Part Number System for Panduct® PanelMax™ DIN Rail Wiring Duct

B1.  
Cable Ties

**DRD**

Type

DRD = DIN Rail Duct

**22**

Size

Capability Height  
22 = 2" Height  
33 = 3" Height  
44 = 4" Height

**LG**

Color

LG = Light  
Gray  
WH = White

**6**

Length

Ft.

B2.  
Cable  
Accessories

B3.  
Stainless  
Steel Ties

C1.  
Wiring  
Duct

### Part Number System for Panduct® PanelMax™ Corner Wiring Duct

**CWD**

Type

CWD = Corner Wiring Duct

**3**

Capability Height

3 = 3" Height  
4 = 4" Height

**LG**

Color

LG = Light  
Gray  
WH = White

**6**

Length

Ft.

C2.  
Surface  
Raceway

C3.  
Abrasion  
Protection

C4.  
Cable  
Management

D1.  
Terminals

D2.  
Power  
Connectors

D3.  
Grounding  
Connectors

E1.  
Labeling  
Systems

E2.  
Labels

E3.  
Pre-Printed  
& Write-On  
Markers

E4.  
Permanent  
Identification

E5.  
Lockout/  
Tagout  
& Safety  
Solutions

F.  
Index

### Panduit Wiring Duct Approvals and Compliances



| Logo (Symbol) | Agency   | Complies with:                       | Requirement  | Applicable Products   |
|---------------|--|--------------------------------------|--|---|
|               | Underwriters Laboratories, Inc.  | File No. E147128                     | UL 1565<br>CSA C22.2 No.18.5-02<br>"Positioning Devices."  | Wiring duct types:<br>H, HS, HN, and DRD                          |
|               | Underwriters Laboratories, Inc.  | File No. E147128                     | UL 1565  | All types of wiring duct  |
|               | Canadian Standards Association   | File No. 016446                      | CSA C22.2 No.18.5-02<br>"Positioning Devices."   | All types of wiring duct<br>(except DRD, H, HN, HS)               |
|               | Conformite European  | Low Voltage Directive<br>2006/95/EEC | EN50085 cable trunking system and cable ducting systems for electrical installations <ul style="list-style-type: none"> <li>• CDS (cable ducting system for impact 2 J)</li> <li>• Minimum storage and transport temperature -5°C</li> <li>• Minimum installation and application temperature -5°C</li> <li>• Maximum application temperature 60°C</li> <li>• Non-flame propagating</li> <li>• Without electrical continuity</li> <li>• Cover removable without a tool</li> </ul>                    | Wiring duct types:<br>H, HS, G, F, D, MC, FS,<br>NNC, NE, and DRD |
| Logo (Symbol) | Agency   | Complies with:                       | Requirement  | Applicable Products   |
|               | DIN (Deutsches Institut für Normung), German Institute for Standardization | DIN 43 659                           | This European standard specifies dimensions for slotted trunkings that will be used in electrical switchgear assemblies and that conform to the corresponding requirements in DIN VDE 060 Part 506. The dimensions specified with the standard include: <ul style="list-style-type: none"> <li>• The channel mounting hole pattern, slot dimensions, pitch, and location</li> <li>• The distance from the first to last like size mounting hole</li> <li>• Minimum overall product length</li> </ul> | Wiring duct types:<br>MC and NNC                                  |
|               | National Fire Protection Agency  | NFPA 79-2007, section 13.3.1         | "Non-metallic ducts shall be permitted (inside enclosures) only when they are made with a flame retardant material." Flame-retardant material is defined in the standard by the IEC 60332-1 test method.   | Wiring duct types:<br>H, G, F, D, MC, NNC,<br>CWD, HN, and NE     |
|               |  | NFPA 79-2007, section 13.5.2         | Panduit wiring duct publishes a maximum percentage wirefill for common wire types equal to 50% of the interior cross-sectional area of the duct.   | All types of wiring duct  |
|               |  | NFPA 79-2007, section 13.1.5.9       | Panduit bend radius control accessories can be mounted at right angle and T junctions created using wiring duct in order to maintain cable bend radius control.  | Duct corner strip with 1" bend radius control                     |

A. System Overview

B1. Cable Ties

B2. Cable Accessories

B3. Stainless Steel Ties

C1. Wiring Duct

C2. Surface Raceway

C3. Abrasion Protection

C4. Cable Management

D1. Terminals

D2. Power Connectors

D3. Grounding Connectors

E1. Labeling Systems

E2. Labels

E3. Pre-Printed & Write-On Markers

E4. Permanent Identification

E5. Lockout/Tagout & Safety Solutions

F. Index

A.  
System  
Overview

### Panduit Wiring Duct Approvals and Compliances (continued)

B1.  
Cable Ties

B2.  
Cable  
Accessories

B3.  
Stainless  
Steel Ties

C1.  
Wiring  
Duct

C2.  
Surface  
Raceway

C3.  
Abrasion  
Protection

C4.  
Cable  
Management

| Logo (Symbol)   | Agency  | Complies with:           | Requirement  | Applicable Products                                 |
|---|---|--------------------------|--|---|
|   | Underwriters Laboratories, Inc.                     | UL 508, section 15       | An insulating barrier material shall comply with the properties indicated in Table 15.1.   | PVC divider wall                                    |
|   |   | UL 508, sections 34, 181 | Shall comply with minimum thickness as required in section 6.3.  | SD*EMI metal barrier                                |
|  | Elevated temperature                                | Panduit logo             | Material is rated for a continuous use temperature above 167°F (75°C).   | Wiring duct types: NNC and NE                       |
|  | Halogen-free IEC 60754-2                            | Panduit logo             | Material contains no fluorine, bromide, or chlorine and will not emit any corrosive or toxic gases when burned, confirmed using IEC 60754-2 test method. | Wiring duct types: NNC and NE                       |
|  | Low flammability UL 94V-0                           | Panduit logo             | Per UL standard, material is self-extinguishing and has excellent fire resistance.   | Wiring duct types: NNC, NE, and all PVC wiring duct |
|  | Low toxicity Boeing and Airbus BSS-7239, ATS 1000.1 | Panduit logo             | Per the Boeing and Airbus test standards, material exceeds the requirements for low levels of toxic gas release.   | Wiring duct type: NNC and NE                        |

D1.  
Terminals

D2.  
Power  
Connectors

D3.  
Grounding  
Connectors

E1.  
Labeling  
Systems

E2.  
Labels

E3.  
Pre-Printed  
& Write-On  
Markers

E4.  
Permanent  
Identification

E5.  
Lockout/  
Tagout/  
& Safety  
Solutions

F.  
Index

## FIBER-DUCT™ ROUTING SYSTEM

Panduit provides leading solutions for cable routing. These routing products are compatible with our cable management solutions increasing your ability to maintain an orderly and clean work environment, implement quick and easy moves, adds, and changes and maintain the integrity of your fiber and copper cabling plant in order to maximize long-term performance.



- Two system sizes available: 2x2 and 4x4
- Minimum 2 inch (50.8mm) bend radius fittings protect against signal loss due to excessive cable bends
- Snap-on non-slip covers
- Compatible with Panduit® FiberRunner® 12x4, 6x4, 4x4 and 2x2 Routing Systems

The 2x2 and 4x4 Fiber-Duct™ Routing Systems are comprised of channel, fittings, and brackets designed to segregate, route, and protect fiber optic and copper cabling to and between racks within the telecommunications room.

A.  
System  
Overview

B1.  
Cable Ties

B2.  
Cable  
Accessories

B3.  
Stainless  
Steel Ties

C1.  
Wiring  
Duct

C2.  
Surface  
Raceway

C3.  
Abrasion  
Protection

C4.  
Cable  
Management

D1.  
Terminals

D2.  
Power  
Connectors

D3.  
Grounding  
Connectors

E1.  
Labeling  
Systems

E2.  
Labels

E3.  
Pre-Printed  
& Write-On  
Markers

E4.  
Permanent  
Identification

E5.  
Lockout/  
Tagout  
& Safety  
Solutions

F.  
Index

A. System Overview

## 2x2 and 4x4 Fiber-Duct™ Routing Systems Roadmap

B1. Cable Ties

B2. Cable Accessories

B3. Stainless Steel Ties

C1. Wiring Duct

C2. Surface Raceway

C3. Abrasion Protection

C4. Cable Management

D1. Terminals

D2. Power Connectors

D3. Grounding Connectors

E1. Labeling Systems

E2. Labels

E3. Pre-Printed & Write-On Markers

E4. Permanent Identification

E5. Lockout/Tagout & Safety Solutions

F. Index

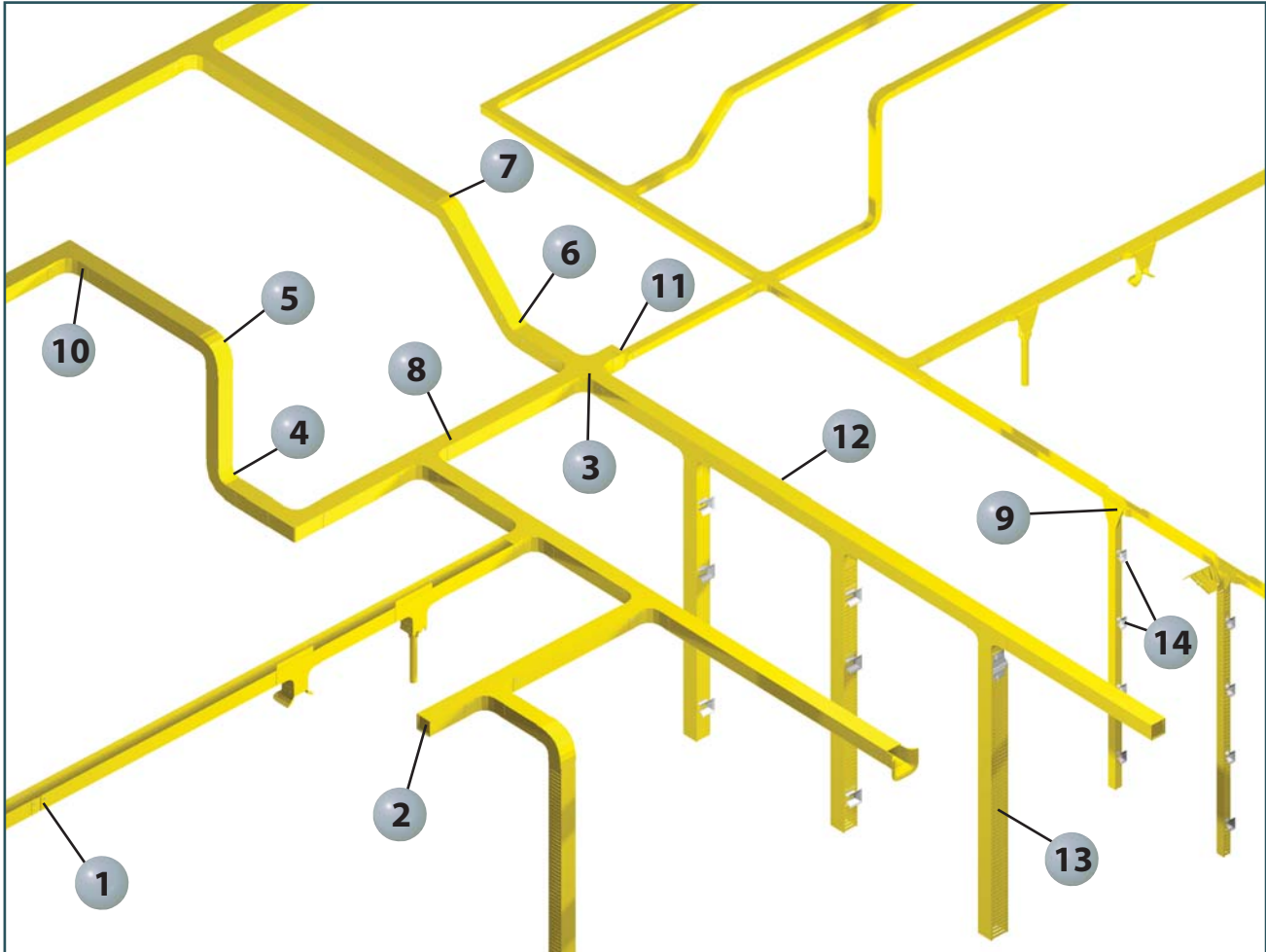

### Fiber-Duct™ Mounting Brackets



**FTRBE12 – Existing Threaded Rod Bracket**  
(page C1.60)



**FTRBN12 – New Threaded Rod Bracket**  
(page C1.60)



**FUSB – Underfloor Pedestal Bracket**  
(page C1.60)



**F2PCLB12 – Two-Piece Ladder Rack Bracket for Attaching Threaded Rod to 1 1/2" – 2" Ladder Rack**  
(page C1.61)



**FLRB – Ladder Rack Bracket**  
(page C1.60)



**FLB – "L" Wall Mount Bracket**  
(page C1.60)



**FZBA1.5X4 – Adjustable "Z" Bracket**  
(page C1.60)



**FZBLP – Low Profile "Z" Bracket**  
(page C1.60)



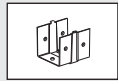

**1** FCF2X2\*\* and FCF4X4\*\* – Coupler Fitting (see page C1.56)



**2** FEC2X2\*\* and FEC4X4\*\* – End Cap Fitting (see page C1.57)

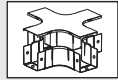

**3** FFWC2X2\*\* and FFWC4X4\*\* – 4-Way Cross Fitting (see page C1.57)

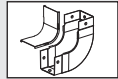

**4** FIVRA2X2\*\* and FIVRA4X4\*\* – Inside Vertical Right Angle (see page C1.57)

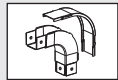

**5** FOVRA2X2\*\* and FOVRA4X4\*\* – Outside Vertical Right Angle (see page C1.57)



**6** FIV452X2\*\* and FIV454X4\*\* – Inside Vertical 45° Angle (see page C1.57)

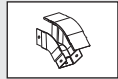

**7** FOV452X2\*\* and FOV454X4\*\* – Outside Vertical 45° Angle (see page C1.57)

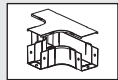

**8** FT2X2\*\* and FT4X4\*\* – Horizontal Tee Fitting (see page C1.57)

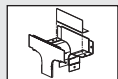

**9** FVT4X4\*\* – 4x4 Vertical Tee (see page C1.58)



**10** FRA2X2\*\* – FRA4X4\*\* – Right Angle Fitting (see page C1.56)

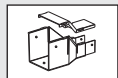

**11** FRF42\*\* – 4x4 to 2x2 Fiber-Duct™ Reducer Fitting (see page C1.57)

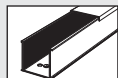

**12** S2X2\*\*6NM and S4X4\*\*6NM Fiber-Duct™ Channel (see page C1.56)



**13** E2X2\*\*6 and E4X4\*\*6 Fiber-Duct™ Slotted Channel (see page C1.56)



**14** TRC2BL and TRC4BL – Bend Radius Control Trumpet (see page C1.59)

\*\*Available colors include: YL (Yellow), OR (Orange), and BL (Black).

A.  
System  
Overview

B1.  
Cable Ties

B2.  
Cable  
Accessories

B3.  
Stainless  
Steel Ties

C1.  
Wiring  
Duct

C2.  
Surface  
Raceway

C3.  
Abrasion  
Protection

C4.  
Cable  
Management

D1.  
Terminals

D2.  
Power  
Connectors

D3.  
Grounding  
Connectors

E1.  
Labeling  
Systems

E2.  
Labels

E3.  
Pre-Printed  
& Write-On  
Markers

E4.  
Permanent  
Identification

E5.  
Lockout/  
Tagout/  
& Safety  
Solutions

F.  
Index

A. System Overview



## 2x2 and 4x4 Fiber-Duct™ Routing Systems

B1. Cable Ties

- Channel, covers, fittings and other non-metallic system components made from V-0 flame class rated material
- Snap-on non-slip covers
- Compatible with Panduit® FiberRunner® 2x2, 4x4, 6x4 and 12x4 Routing Systems

B2. Cable Accessories

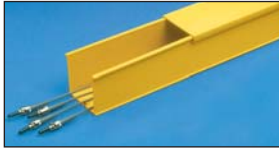

**S2X2  
S4X4**

B3. Stainless Steel Ties

C1. Wiring Duct

C2. Surface Raceway



**E2X2  
E4X4**

C3. Abrasion Protection

C4. Cable Management

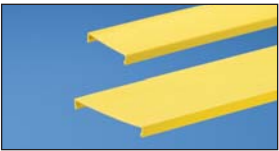

**C2  
C4**

D1. Terminals

D2. Power Connectors

D3. Grounding Connectors

E1. Labeling Systems

E2. Labels

E3. Pre-Printed & Write-On Markers

E4. Permanent Identification

E5. Lockout/Tagout & Safety Solutions

F. Index

| Part Number                | Part Description  | System Size | Std. Pkg. Qty. | Std. Ctn. Qty. |
|----------------------------|---|-------------|----------------|----------------|
| <b>Fiber-Duct™ Channel</b> |   |             |                |                |
| <b>S2X2YL6NM</b>           | Used to carry the cables throughout the Fiber-Duct™ Routing System. Accepts cover C2YL6. Cover sold separately. | 2x2         | 6              | 120            |
| <b>S4X4YL6NM</b>           | Used to carry the cables throughout the Fiber-Duct™ Routing System. Accepts cover C4YL6. Cover sold separately. | 4x4         | 6              | 60             |

| Part Number                        | Part Description   | System Size | Std. Pkg. Qty. | Std. Ctn. Qty. |
|------------------------------------|--|-------------|----------------|----------------|
| <b>Fiber-Duct™ Slotted Channel</b> |  |             |                |                |
| <b>E2X2YL6</b>                     | Used to carry the cables vertically to the front or the back of equipment racks throughout the system. Accepts cover C2YL6. Extra supports required when used in horizontal applications. Cover sold separately. | 2x2         | 6              | 120            |
| <b>E4X4YL6</b>                     | Used to carry the cables vertically to the front or the back of equipment racks throughout the system. Accepts cover C4YL6. Extra supports required when used in horizontal applications. Cover sold separately. | 4x4         | 6              | 60             |

| Part Number              | Part Description   | System Size | Std. Pkg. Qty. | Std. Ctn. Qty. |
|--------------------------|--|-------------|----------------|----------------|
| <b>Fiber-Duct™ Cover</b> |  |             |                |                |
| <b>C2YL6</b>             | Cover for Fiber-Duct™ Channel and Fiber-Duct™ Slotted Channel. Non-slip cover design incorporates integral high friction lining to inhibit cover movement. | 2x2         | 6              | 120            |
| <b>C4YL6</b>             | Cover for Fiber-Duct™ Channel and Fiber-Duct™ Slotted Channel. Non-slip cover design incorporates integral high friction lining to inhibit cover movement. | 4x4         | 6              | 120            |

Note: Available with mounting holes. To order, delete NM from the part number. For fastest installation use NR2WH-L or NR4BL-L snap rivets. For other colors replace YL (Yellow) with OR (Orange) or BL (Black). Order number of feet required, in multiples of standard 6' length increments.

## Fiber-Duct™ System Fittings



**FCF2X2  
FCF4X4**

**FRA2X2  
FRA4X4**

| Part Number                           | Part Description  | System Size | Std. Pkg. Qty. | Std. Ctn. Qty. |
|---------------------------------------|---|-------------|----------------|----------------|
| <b>Coupler Fitting</b>                |   |             |                |                |
| <b>FCF2X2YL</b>                       | Used to join two sections of duct together. Fiber-Duct™ Coupler is not required at each fitting connection. | 2x2         | 1              | 5              |
| <b>FCF4X4YL</b>                       |   | 4x4         | 1              | 5              |
| <b>Horizontal Right Angle Fitting</b> |   |             |                |                |
| <b>FRA2X2YL</b>                       | Attaches to channel to create a 90° horizontal turn from a straight horizontal run. Cover included.         | 2x2         | 1              | 5              |
| <b>FRA4X4YL</b>                       |   | 4x4         | 1              | 5              |

For other colors replace suffix YL (Yellow) with OR (Orange) or BL (Black). Fittings include 5/16" assembly holes for fast mechanical fastening.

## Fiber-Duct™ System Fittings (continued)



FT2X2  
FT4X4



FFWC2X2  
FFWC4X4



FEC2X2  
FEC4X4



FIV452X2  
FIV454X4



FOV452X2  
FOV454X4



FIVRA2X2  
FIVRA4X4



FOVRA2X2  
FOVRA4X4



FRF42

| Part Number                                   | Part Description   | System Size | Std. Pkg. Qty. | Std. Ctn. Qty. |
|---|--|-------------|----------------|----------------|
| <b>Horizontal Tee Fitting</b>                 |  |             |                |                |
| <b>FT2X2YL</b>                                | Attaches to channel to create a 90° horizontal branch from a straight horizontal run. Cover included.  | 2x2         | 1              | 5              |
| <b>FT4X4YL</b>                                |  | 4x4         | 1              | 5              |
| <b>Four Way Cross Fitting</b>                 |  |             |                |                |
| <b>FFWC2X2YL</b>                              | Attaches to channel to create a horizontal four way cross intersection. Cover included.  | 2x2         | 1              | 5              |
| <b>FFWC4X4YL</b>                              |  | 4x4         | 1              | 5              |
| <b>End Cap Fitting</b>                        |  |             |                |                |
| <b>FEC2X2YL</b>                               | Used for closing off open ends of the channel. No coupler required. Push-on installation.  | 2x2         | 1              | 5              |
| <b>FEC4X4YL</b>                               |  | 4x4         | 1              | 5              |
| <b>Inside Vertical 45° Angle Fitting</b>      |  |             |                |                |
| <b>FIV452X2YL</b>                             | Attaches to channel to create a 45° upward angle from a straight horizontal run. Used with outside vertical 45° angle fitting FOV452X2YL or FOV454X4YL to change level of straight horizontal runs. Cover included.  | 2x2         | 1              | 5              |
| <b>FIV454X4YL</b>                             |  | 4x4         | 1              | 5              |
| <b>Outside Vertical 45° Angle Fitting</b>     |  |             |                |                |
| <b>FOV452X2YL</b>                             | Attaches to channel to create a 45° downward angle from a straight horizontal run. Used with inside vertical 45° angle fitting FIV452X2YL or FIV454X4YL to change level of straight horizontal runs. Cover included. | 2x2         | 1              | 5              |
| <b>FOV454X4YL</b>                             |  | 4x4         | 1              | 5              |
| <b>Inside Vertical Right Angle Fitting</b>    |  |             |                |                |
| <b>FIVRA2X2YL</b>                             | Attaches to channel to create a 90° upward angle from a straight horizontal run. Used with outside vertical 90° angle fitting FOVRA2X2YL or FOVRA4X4YL to change level of straight horizontal runs. Cover included.  | 2x2         | 1              | 5              |
| <b>FIVRA4X4YL</b>                             |  | 4x4         | 1              | 5              |
| <b>Outside Vertical Right Angle Fitting</b>   |  |             |                |                |
| <b>FOVRA2X2YL</b>                             | Attaches to channel to create a 90° downward angle from a straight horizontal run. Used with inside vertical 90° angle fitting FIVRA2X2YL or FIVRA4X4YL to change level of straight horizontal runs. Cover included. | 2x2         | 1              | 5              |
| <b>FOVRA4X4YL</b>                             |  | 4x4         | 1              | 5              |
| <b>4x4 to 2x2 Fiber-Duct™ Reducer Fitting</b> |  |             |                |                |
| <b>FRF42YL</b>                                | Joins any 4x4 Fiber-Duct™ Fitting to the 2x2 Fiber-Duct™ Channel, S2X2YL6 or E2X2YL6. Cover included.  | 2x2<br>4x4  | 1              | 5              |

For other colors replace suffix YL (Yellow) with OR (Orange) or BL (Black).  
Fittings include 5/16" assembly holes for fast mechanical fastening.

A.  
System  
Overview

B1.  
Cable Ties

B2.  
Cable  
Accessories

B3.  
Stainless  
Steel Ties

C1.  
Wiring  
Duct

C2.  
Surface  
Raceway

C3.  
Abrasion  
Protection

C4.  
Cable  
Management

D1.  
Terminals

D2.  
Power  
Connectors

D3.  
Grounding  
Connectors

E1.  
Labeling  
Systems

E2.  
Labels

E3.  
Pre-Printed  
& Write-On  
Markers

E4.  
Permanent  
Identification

E5.  
Lockout/  
Tagout  
& Safety  
Solutions

F.  
Index

A. System Overview

## Fiber-Duct™ Spillouts

B1. Cable Ties

B2. Cable Accessories

B3. Stainless Steel Ties

C1. Wiring Duct

C2. Surface Raceway

C3. Abrasion Protection

C4. Cable Management

D1. Terminals

D2. Power Connectors

D3. Grounding Connectors

E1. Labeling Systems

E2. Labels

E3. Pre-Printed & Write-On Markers

E4. Permanent Identification

E5. Lockout/Tagout & Safety Solutions

F. Index



FVTHD2X2



FTR2X2



FIDT2X2



FVT4X4



FTR4X4



FIDT4X4BL

| Part Number   | Part Description   | System Size | Std. Pkg. Qty. | Std. Ctn. Qty. |
|---|--|-------------|----------------|----------------|
| <b>2x2 Vertical Tee</b>   |  |             |                |                |
| <b>FVTHD2X2YL</b>   | Attaches to 2x2 channel to create a 90° vertical drop from a horizontal run. Hinged door included. Accepts channel cover in conjunction with channel. Use QuikLock™ Coupler FBC2X2YL with HS2X2YL6 or H2X2YL6 channels. Use snap rivets NR2WH-L or bolts F14PN-L with S2X2YL6 or E2X2YL6 channels. Also accepts FIDT2X2YL. | 2x2         | 1              | 5              |
| <b>3-Sided BRC Trumpet Spillout for 2x2 Exit</b>                        |  |             |                |                |
| <b>FTR2X2YL</b>   | Used to limit the bend radius of the cable to 2" (50.8mm) when exiting from a spill-over junction with a 2x2 exit or from 2x2 Fiber-Duct™ Channel.   | 2x2         | 1              | 5              |
| <b>1-Port Spillout to 1.5" (38mm) Inside Diameter Corrugated Tubing</b> |  |             |                |                |
| <b>FIDT2X2YL</b>  | Used to route cable into one piece of 1.5" (38mm) diameter split corrugated tubing. Used with a spill-over junction with a 2x2 exit, 2x2 Fiber-Duct™ Fittings, and the 2x2 FiberRunner® Hinged Channel. Securely holds split corrugated tubing to ensure system integrity and easy access to add or remove cables.         | 2x2         | 1              | 5              |
| <b>4x4 Vertical Tee</b>   |  |             |                |                |
| <b>FVT4X4YL</b>   | Attaches to channel to create a 90° vertical drop from a horizontal run. Accepts FIDT4X4BL, FTR4X4YL, S4X4YL6 or E4X4YL6 directly.   | 4x4         | 1              | 5              |
| <b>3-Sided Vertical Tee Trumpet Spillout</b>                            |  |             |                |                |
| <b>FTR4X4YL</b>   | Used to limit the bend radius of the cable to 2" (50.8mm) when exiting from a 4x4 or 6x4 FiberRunner® Vertical Tee and 4x4 Fiber-Duct™ Fittings.   | 4x4         | 1              | 5              |
| <b>2-Port Spillout to 1.5" (38mm) Inside Diameter Corrugated Tubing</b> |  |             |                |                |
| <b>FIDT4X4BL</b>  | Used to route cable into one or two pieces of 1.5" (38mm) diameter split corrugated tubing. Used with FRVT6X4YL, FRVT4X4YL, or FVT4X4YL. Securely holds corrugated split tubing to ensure system integrity and easy access to add or remove cables. Black color only.  | 4x4         | 1              | 5              |

## Fiber-Duct™ Bend Radius Control Trumpets

- Provide method to transition cabling into rack system
- Maintain 1 inch (25.4mm) bend radius control



TRC2BL

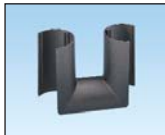

TRC4BL

| Part Number | Part Description  | System Size | Std. Pkg. Qty. | Std. Ctn. Qty. |
|-------------|---|-------------|----------------|----------------|
| TRC2BL      | Bend radius control trumpet for exiting at the sidewall of 2" wall heights of type G, FS, E, or S Fiber-Duct™ Channels. | 2x2         | 1              | 10             |
| TRC4BL      | Bend radius control trumpet for exiting at the sidewall of 4" wall heights of type G, FS, E, or S Fiber-Duct™ Channels. | 4x4         | 1              | 10             |

## Fiber-Duct™ Accessories



NR2WH-L  
NR4BL-L



F14PWN-L



F14PN-L

| Part Number                   | Part Description   | System Size | Std. Pkg. Qty. | Std. Ctn. Qty. |
|-------------------------------|--|-------------|----------------|----------------|
| <b>Snap Rivets</b>            |  |             |                |                |
| NR2WH-L                       | Snap rivet fastens channel and fittings together for added strength and rigidity. Snap rivet mounts flush to surfaces. | 2x2         | 50             | 500            |
| NR4BL-L                       |  | 4x4         | 50             | 500            |
| <b>Plastic Bolts and Nuts</b> |  |             |                |                |
| F14PWN-L                      | 1/4" plastic bolts and wing nuts fastens channel and fittings together for added strength and rigidity.                | 2x2         | 50             | 500            |
| F14PN-L                       |  | 4x4         |                |                |
| <b>Plastic Bolts and Nuts</b> |  |             |                |                |
| F14PN-L                       | 1/4" plastic bolts and hex nuts fastens channel and fittings together for added strength and rigidity.                 | 2x2         | 50             | 500            |
| F14PN-L                       |  | 4x4         |                |                |

A.  
System  
Overview

B1.  
Cable Ties

B2.  
Cable  
Accessories

B3.  
Stainless  
Steel Ties

C1.  
Wiring  
Duct

C2.  
Surface  
Raceway

C3.  
Abrasion  
Protection

C4.  
Cable  
Management

D1.  
Terminals

D2.  
Power  
Connectors

D3.  
Grounding  
Connectors

E1.  
Labeling  
Systems

E2.  
Labels

E3.  
Pre-Printed  
& Write-On  
Markers

E4.  
Permanent  
Identification

E5.  
Lockout/  
Tagout  
& Safety  
Solutions

F.  
Index

A.  
System  
Overview

## Fiber-Duct™ Mounting Brackets

B1.  
Cable Ties

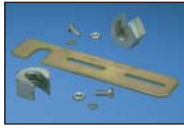

**FTRBE12, FTRBE58  
FTRBE12M**

B2.  
Cable  
Accessories

B3.  
Stainless  
Steel Ties

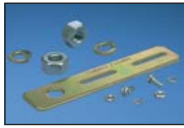

**FTRBN12, FTRBN58  
FTRBN12M**

C1.  
Wiring  
Duct



**FUSB**

C2.  
Surface  
Raceway



**FLRB**

C3.  
Abrasion  
Protection

C4.  
Cable  
Management

D1.  
Terminals

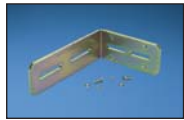

**FLB**

D2.  
Power  
Connectors



**FZBA1.5X4**

D3.  
Grounding  
Connectors

E1.  
Labeling  
Systems



**FZBLP**

E2.  
Labels

E3.  
Pre-Printed  
& Write-On  
Markers

E4.  
Permanent  
Identification

E5.  
Lockout/  
Tagout  
& Safety  
Solutions

F.  
Index

| Part Number   | Part Description  | For Threaded Rod Size | Std. Pkg. Qty. | Std. Ctn. Qty. |
|---|---|-----------------------|----------------|----------------|
| <b>Existing Threaded Rod Bracket for Fiber-Duct™ System</b> |   |                       |                |                |
| <b>FTRBE12</b>  | Used for supporting the 2x2 and 4x4 Fiber-Duct™ Systems from existing threaded rod installations.   | 1/2"                  | 1              | 10             |
| <b>FTRBE58</b>  | Bracket is secured to threaded rod with two split nuts. Contains hardware for attaching to threaded rods and hardware for mounting channel to bracket.  | 5/8"                  | 1              | 10             |
| <b>FTRBE12M</b>   |   | 12mm                  | 1              | 10             |
| <b>New Threaded Rod Bracket for Fiber-Duct™ System</b>      |   |                       |                |                |
| <b>FTRBN12</b>  | Used for supporting the 2x2 and 4x4 Fiber-Duct™ Systems from new threaded rod installations. Bracket is secured to threaded rod with two nuts. Contains hardware for attaching to threaded rods and hardware for mounting channel to bracket. | 1/2"                  | 1              | 10             |
| <b>FTRBN58</b>  |   | 5/8"                  | 1              | 10             |
| <b>FTRBN12M</b>   |   | 12mm                  | 1              | 10             |
| <b>Underfloor Pedestal Bracket for Fiber-Duct™ System</b>   |   |                       |                |                |
| <b>FUSB</b>   | Used to support the 2x2 and 4x4 Fiber-Duct™ Systems by attaching to underfloor pedestal (not included). Use on pedestals up to 1" in diameter. Bracket contains hardware to attach to pedestal and hardware for mounting channel to bracket.  | —                     | 1              | 10             |
| <b>Ladder Rack Bracket for Fiber-Duct™ System</b>           |   |                       |                |                |
| <b>FLRB</b>   | Used to support the 2x2 and 4x4 Fiber-Duct™ Systems attaching directly to any 3/8" (9.5mm) x 1 1/2" (38.1mm) or 3/8" (9.5mm) x 2" (50.8mm) ladder rack rail. No threaded rod required. Contains hardware for mounting channel to bracket.     | —                     | 1              | 10             |
| <b>"L" Wall Mount Bracket for Fiber-Duct™ System</b>        |   |                       |                |                |
| <b>FLB</b>  | Used to support 2x2 and 4x4 Fiber-Duct™ Systems by attaching to a wall or the front or back of an equipment rack. Contains hardware for mounting channel to bracket.  | —                     | 1              | 10             |
| <b>Adjustable "Z" Bracket</b>                               |   |                       |                |                |
| <b>FZBA1.5X4</b>  | Bracket used to offset Fiber-Duct™ System from mounting surface, adjustable from 1.5" (38mm) to 4" (101mm). Typically used on the front of an equipment rack.   | —                     | 1              | 10             |
| <b>Low Profile "Z" Bracket</b>                              |   |                       |                |                |
| <b>FZBLP</b>  | Bracket used to offset 2x2 or 4x4 Fiber-Duct™ System and hinged duct from the front face of an equipment rack. Bracket provides a secure mounting surface .67" (17mm) from the front of an equipment rack.                                    | —                     | 1              | 10             |



## Fiber-Duct™ Mounting Brackets (continued)



F2PCLB12  
F2PCLB58



FRAF58

| Part Number  | Part Description   | For Threaded Rod Size | Std. Pkg. Qty. | Std. Ctn. Qty. |
|--|--|-----------------------|----------------|----------------|
| <b>Two-Piece Ladder Rack Bracket for Attaching Threaded Rod to 1 1/2" – 2" Ladder Rack</b>                   |  |                       |                |                |
| <b>F2PCLB12</b>  | Two-piece bracket attaches to 3/8" (9.5mm) wide x 1 1/2" (38.1mm) or 3/8" (9.5mm) wide x 2" (50.8mm) ladder rack rail. Bracket halves slide into position and clamp together on the ladder rack rail, which allows for a one-handed assembly of the threaded rod (not included). Contains bracket and hardware for attaching bracket to ladder rack. | 1/2"                  | 1              | 10             |
| <b>F2PCLB58</b>  |  | 5/8"                  | 1              | 10             |
| <b>Two-Piece Framing Clip for Attaching 5/8" Threaded Rod to 2" x 9/16" C-Channel Auxiliary Framing Bars</b> |  |                       |                |                |
| <b>FRAF58</b>  | Two-piece framing clip attaches to auxiliary framing bars. Framing clip halves slide into position and interlock on the auxiliary framing bars, allowing easier assembly of the threaded rod to bars. Contains two-piece framing clip and hardware for attaching framing clip to auxiliary framing bars. (5/8" threaded rod not included.)           | 5/8"                  | 1              | 10             |

A.  
System  
Overview

B1.  
Cable Ties

B2.  
Cable  
Accessories

B3.  
Stainless  
Steel Ties

C1.  
Wiring  
Duct

C2.  
Surface  
Raceway

C3.  
Abrasion  
Protection

C4.  
Cable  
Management

D1.  
Terminals

D2.  
Power  
Connectors

D3.  
Grounding  
Connectors

E1.  
Labeling  
Systems

E2.  
Labels

E3.  
Pre-Printed  
& Write-On  
Markers

E4.  
Permanent  
Identification

E5.  
Lockout/  
Tagout  
& Safety  
Solutions

F.  
Index

A. System Overview



## 2x2 and 4x4 Fiber-Duct™ Routing Systems

B1. Cable Ties

### Cable Fills for 2x2 and 4x4 Fiber-Duct™ Cable Routing Systems

The maximum amounts may vary according to the cable fill installation methods, straightness of cables, etc.

B2. Cable Accessories

B3. Stainless Steel Ties

| 2x2 Fiber-Duct™ Cable Routing System |                                |                      |                      |                      |   |                                   |                              |
|--------------------------------------|--------------------------------|----------------------|----------------------|----------------------|---|-----------------------------------|------------------------------|
| Fill/Pile Up                         | Internal Area In. <sup>2</sup> | Diameter 1.6mm .063" | Diameter 2.0mm .079" | Diameter 3.0mm .118" | Fiber Optic Flat Ribbon Interconnect Cable 5.20mm .205" | Category 6A Diameter 7.57mm .298" | Cat. 6 Diameter 6.35mm .250" |
| <b>40% Fill</b>                      |                                |                      |                      |                      |   |                                   |                              |
| 2" Pile Up                           | 3.5                            | 449                  | 288                  | 128                  | 42  | 20                                | 29                           |
| <b>50% Fill</b>                      |                                |                      |                      |                      |   |                                   |                              |
| 2" Pile Up                           | 3.5                            | 562                  | 359                  | 160                  | 53  | 25                                | 36                           |
| <b>60% Fill</b>                      |                                |                      |                      |                      |   |                                   |                              |
| 2" Pile Up                           | 3.5                            | 674                  | 431                  | 192                  | 64  | 30                                | 43                           |

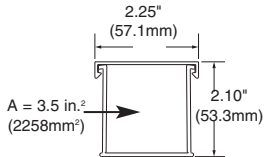

**Channel cutting instructions:** For optimum results, use a miter box and saw. For larger quantities use a plastic cutting saw blade for clean, burr-free cuts. Recommend: Carbide 80T and 100T; .090" thickness, .125" kerf.

C2. Surface Raceway

C3. Abrasion Protection

C4. Cable Management

| 4x4 Fiber-Duct™ Cable Routing System |                                |                      |                      |                      |   |                                   |                              |
|--------------------------------------|--------------------------------|----------------------|----------------------|----------------------|---|-----------------------------------|------------------------------|
| Fill/Pile Up                         | Internal Area In. <sup>2</sup> | Diameter 1.6mm .063" | Diameter 2.0mm .079" | Diameter 3.0mm .118" | Fiber Optic Flat Ribbon Interconnect Cable 5.20mm .205" | Category 6A Diameter 7.57mm .298" | Cat. 6 Diameter 6.35mm .250" |
| <b>40% Fill</b>                      |                                |                      |                      |                      |   |                                   |                              |
| 2" Pile Up                           | 7.6                            | 976                  | 624                  | 277                  | 92  | 44                                | 62                           |
| 3" Pile Up                           | 11.3                           | 1450                 | 928                  | 413                  | 137   | 65                                | 92                           |
| 4" Pile Up                           | 14.6                           | 1874                 | 1199                 | 533                  | 177   | 84                                | 119                          |
| <b>50% Fill</b>                      |                                |                      |                      |                      |   |                                   |                              |
| 2" Pile Up                           | 7.6                            | 1219                 | 780                  | 347                  | 115   | 54                                | 77                           |
| 3" Pile Up                           | 11.3                           | 1813                 | 1160                 | 516                  | 171   | 81                                | 115                          |
| 4" Pile Up                           | 14.6                           | 2343                 | 1499                 | 666                  | 221   | 105                               | 149                          |
| <b>60% Fill</b>                      |                                |                      |                      |                      |   |                                   |                              |
| 2" Pile Up                           | 7.6                            | 1463                 | 936                  | 416                  | 138   | 65                                | 93                           |
| 3" Pile Up                           | 11.3                           | 2176                 | 1392                 | 619                  | 205   | 97                                | 138                          |
| 4" Pile Up                           | 14.6                           | 2811                 | 1799                 | 800                  | 265   | 126                               | 178                          |

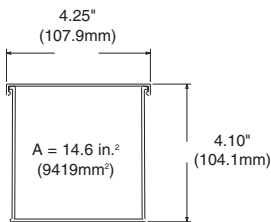

**Channel cutting instructions:** For optimum results, use a miter box and saw. For larger quantities use a plastic cutting saw blade for clean, burr-free cuts. Recommend: Carbide 80T and 100T; .090" thickness, .125" kerf.

D1. Terminals

D2. Power Connectors

D3. Grounding Connectors

E1. Labeling Systems

E2. Labels

E3. Pre-Printed & Write-On Markers

E4. Permanent Identification

E5. Lockout/Tagout & Safety Solutions

F. Index

## PAN-WAY® METAL RACEWAY

Pan-Way® Metal Raceway is a series of single and multi-channel solutions for routing, protecting, concealing and terminating power wire and high performance copper, voice, video or fiber optic cable. Panduit metal raceway is designed with labor saving features to increase productivity and lower installed costs, while incorporating benefits of increased safety and cable protection. Pan-Way® Metal Raceway is an innovative routing solution that offers superior benefits over competitive systems:

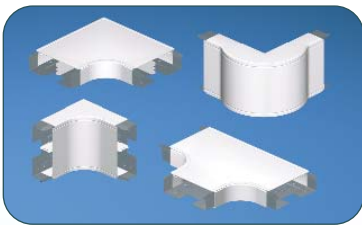

Pan-Way® Metal Raceway systems include a complete assortment of fittings, junction boxes, faceplates and accessories. They are available in white and almond color to match any decor and most popular electrical outlets. Systems are optimized for use with Panduit® Mini-Com® Modules for complete connectivity possibilities.

### PMR5 and PMR7 Single Channel Metal Raceway

- Raceway system features a patent pending bonding design that provides full continuity of the ground path between fittings and channel, for increased electrical safety
- System components incorporate an innovative snap-mount assembly method for fast installations, resulting in measurable contractor labor savings
- Fittings and mounts can be attached using various types and sizes of fasteners, eliminating the requirements of using only flat head style screws
- One-piece channel construction eliminates the problem of channel separation, associated with competitive two-piece designs, saving installation time

### PMR40 Multi-Channel Metal Raceway

- Raceway accepts standard double gang faceplates for increased termination options and reduced number of components
- System includes optional faceplates and fittings to support high performance Category 6A copper and fiber optic cabling terminations
- Full capacity 2 inch bend radius fittings provide necessary cable protection without restricting channel capacity

A.  
System  
Overview

B1.  
Cable Ties

B2.  
Cable  
Accessories

B3.  
Stainless  
Steel Ties

C1.  
Wiring  
Duct

C2.  
Surface  
Raceway

C3.  
Abrasion  
Protection

C4.  
Cable  
Management

D1.  
Terminals

D2.  
Power  
Connectors

D3.  
Grounding  
Connectors

E1.  
Labeling  
Systems

E2.  
Labels

E3.  
Pre-Printed  
& Write-On  
Markers

E4.  
Permanent  
Identification

E5.  
Lockout/  
Tagout  
& Safety  
Solutions

F.  
Index

A.  
System  
Overview

## PMR40 Raceway Roadmap

B1.  
Cable Ties

B2.  
Cable  
Accessories

B3.  
Stainless  
Steel Ties

C1.  
Wiring  
Duct

C2.  
Surface  
Raceway

C3.  
Abrasion  
Protection

C4.  
Cable  
Management

D1.  
Terminals

D2.  
Power  
Connectors

D3.  
Grounding  
Connectors

E1.  
Labeling  
Systems

E2.  
Labels

E3.  
Pre-Printed  
& Write-On  
Markers

E4.  
Permanent  
Identification

E5.  
Lockout/  
Tagout  
& Safety  
Solutions

F.  
Index

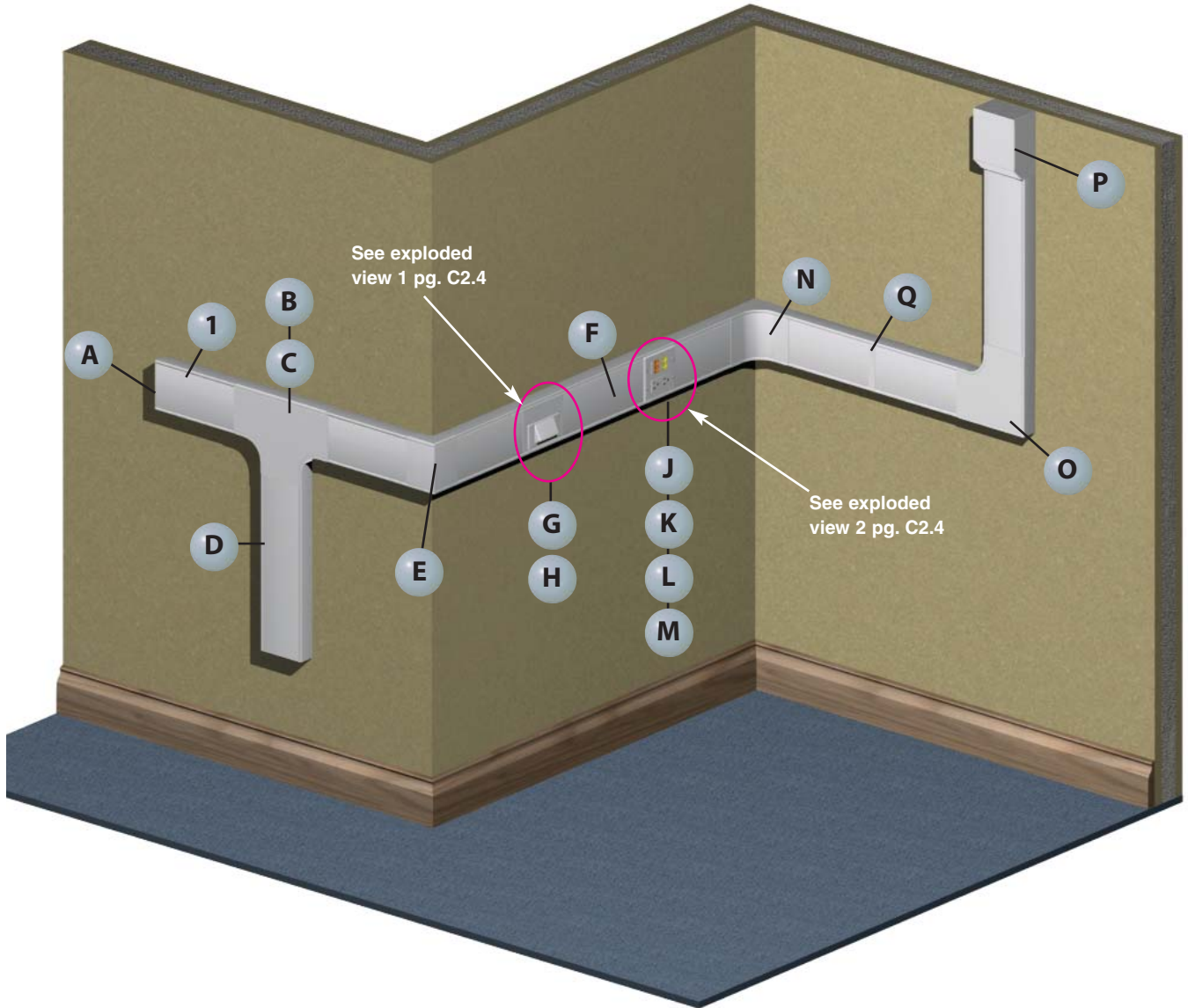



**1** PMR40\*\* – PMR40 Metal Raceway (page C2.5)

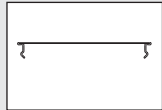

**1** PMR40C\*\* – PMR40 Cover (page C2.5)

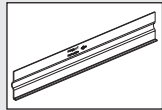

**1** PMR40DW\* – PMR40 Divider Wall (page C2.5)

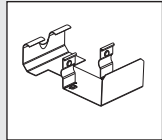

**1** PMR40DC-X – PMR40 Divider Clip (page C2.5)

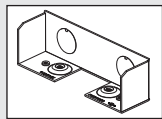

**A** PMR40EC\*\* – End Cap (page C2.6)

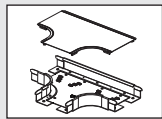

**B** PMR40T\*\* – Tee Fitting (page C2.6)

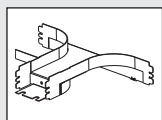

**C** PMR40TD50 – Tee Divider Insert (page C2.6)

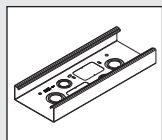

**D** PMR40BF\*\* – Backfeed Fitting (page C2.6)

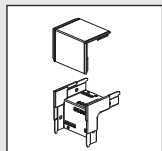

**E** PMR40SOC\*\* – Outside Corner (no bend radius) (page C2.6)

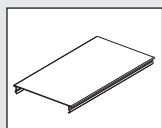

**F** PMR40C\*\*7.75 – Pre-Cut Cover for mounting devices on 12" centers (page C2.5)

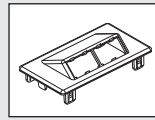

**G** PMR40FH4\*\* – Horizontal Sloped Communication Faceplate (page C2.6)

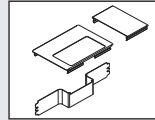

**H** PMR40DP50\*\* – PMR40 50/50 Data Plate (page C2.6)

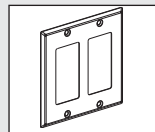

**J** MP2GR\*\* – Double Gang Rectangular Faceplate (page C2.17)

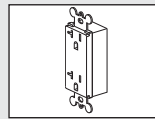

**K** ERU20\*\* – 20 A Specification Grade Rectangular Outlet (page C2.61)

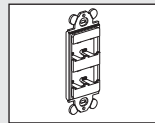

**L** CFG4 – Mini-Com® Frame (see SA-NCCB51)

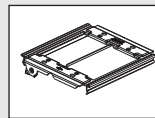

**M** PMR40DB50 – Device Bracket (page C2.6)

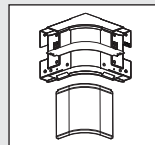

**N** PMR40IC\*\* – Inside Corner (page C2.6)

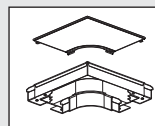

**O** PMR40RA\*\* – Right Angle (page C2.5)

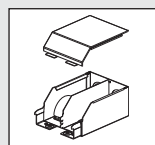

**P** PMR40EE\*\* – Entrance End (page C2.6)

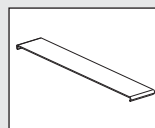

**Q** PMR40SC\*\*-X – Seam Clip (page C2.5)

A. System Overview

B1. Cable Ties

B2. Cable Accessories

B3. Stainless Steel Ties

C1. Wiring Duct

C2. Surface Raceway

C3. Abrasion Protection

C4. Cable Management

D1. Terminals

D2. Power Connectors

D3. Grounding Connectors

E1. Labeling Systems

E2. Labels

E3. Pre-Printed & Write-On Markers

E4. Permanent Identification

E5. Lockout/Tagout & Safety Solutions

F. Index

A.  
System  
Overview

## PMR40 Configurations

B1.  
Cable Ties

### Exploded View 1

|    | Components Required   | See page |
|----|---|----------|
| A. | PMR40FH4 = Horizontal sloped communication faceplate.         | C2.6     |
| B. | PMR40DP50** = PMR40 50/50 data plate and offset divider wall. | C2.6     |
| C. | Mini-Com® Modules.  | —        |

B2.  
Cable  
Accessories

B3.  
Stainless  
Steel Ties

C1.  
Wiring  
Duct

C2.  
Surface  
Raceway

C3.  
Abrasion  
Protection

C4.  
Cable  
Management

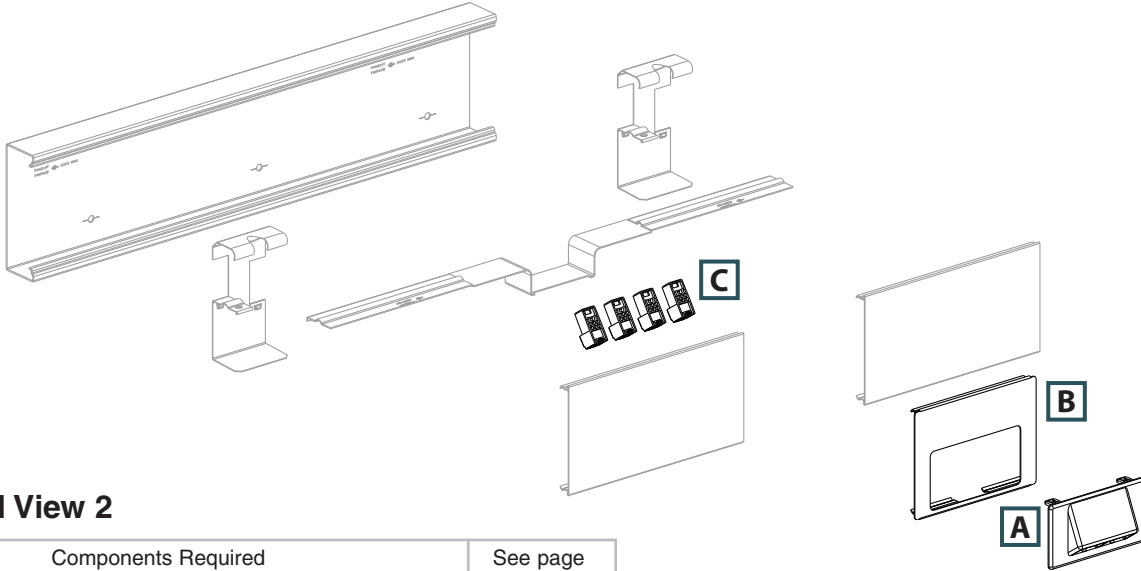

D1.  
Terminals

### Exploded View 2

|    | Components Required                                    | See page |
|----|--|----------|
| A. | MP2GR** = Double gang rectangular faceplate.           | C2.17    |
| B. | ERU20** = 20 V specification grade rectangular outlet. | C2.61    |
| C. | CFG4 = Mini-Com® Frame.                                | —        |
| D. | Mini-Com® Modules.                                     | —        |
| E. | PMR40DB50 = Device bracket.                            | C2.6     |

D2.  
Power  
Connectors

D3.  
Grounding  
Connectors

E1.  
Labeling  
Systems

E2.  
Labels

E3.  
Pre-Printed  
& Write-On  
Markers

E4.  
Permanent  
Identification

E5.  
Lockout/  
Tagout  
& Safety  
Solutions

F.  
Index

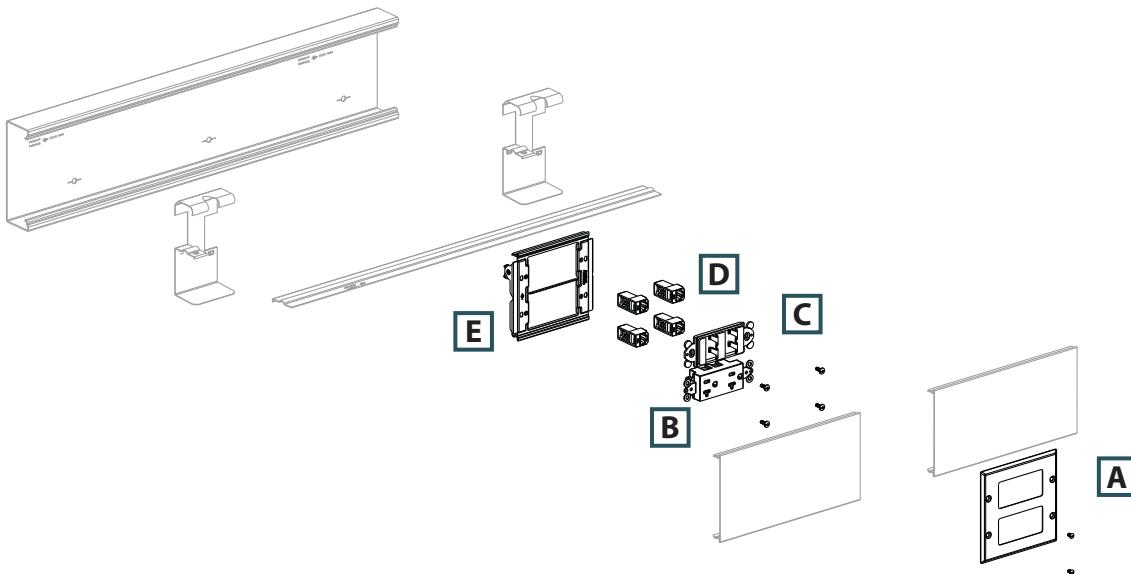



## Pan-Way® PMR40 Metal Raceway System

- c-UL-us listed and rated to 600 V; meets UL 5 and CSA22.2 No. 62-93 safety standards
- Raceway accepts standard double gang faceplates for increased termination options and reduced number of components
- System includes optional faceplates and fittings to support high performance Category 6A copper and fiber optic cabling terminations

- Full capacity 2 inch bend radius fittings provide necessary cable protection without restricting channel capacity
- Supplied with pre-punched mounting holes

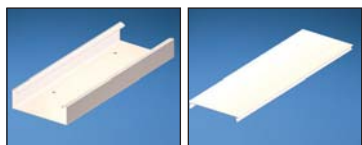
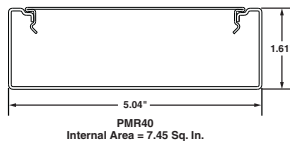

PMR40B

PMR40C

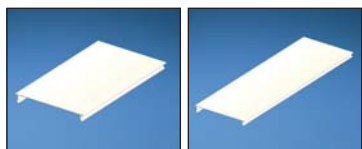

PMR40C\*\*\*

PMR40C\*\*\*

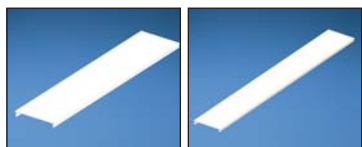

PMR40C\*\*\*

PMR40C\*\*\*



PMR40DW5

PMR40DC

| Part Number                                  | Part Description   | Raceway Size                     | Color‡ | Length Ft. | Std. Pkg. Qty. |
|--|--|----------------------------------|--------|------------|----------------|
| <b>PMR40 Metal Raceway Base</b>              |  |                                  |        |            |                |
| <b>PMR40BWH10</b>                            | PMR40 raceway base available in 10' lengths. Supplied with pre-punched mounting holes.   | 5.04" x 1.61" (128.0mm x 40.9mm) | White  | 10         | 10             |
| <b>PMR40 Metal Raceway Cover</b>             |  |                                  |        |            |                |
| <b>PMR40CWH5</b>                             | PMR40 raceway cover available in 5' lengths.   | —                                | White  | 5          | 5              |
| <b>PMR40 Metal Raceway Pre-cut Covers</b>    |  |                                  |        |            |                |
| <b>PMR40CWH7.75</b>                          | 7.75" pre-cut cover. To be used with PMR40 raceway for mounting devices on 12" centers.  | —                                | White  | —          | 1              |
| <b>PMR40CWH13.75</b>                         | 13.75" pre-cut cover. To be used with PMR40 raceway for mounting devices on 18" centers.   | —                                | White  | —          | 1              |
| <b>PMR40CWH19.75</b>                         | 19.75" pre-cut cover. To be used with PMR40 raceway for mounting devices on 24" centers.   | —                                | White  | —          | 1              |
| <b>PMR40CWH31.75</b>                         | 31.75" pre-cut cover. To be used with PMR40 raceway for mounting devices on 36" centers.   | —                                | White  | —          | 1              |
| <b>PMR40 Metal Raceway Divider Wall</b>      |  |                                  |        |            |                |
| <b>PMR40DW5</b>                              | PMR40 divider wall snaps into PMR40DC-X to create separate channels. Must use wire retainers to ensure channel separation per UL/CSA. Available in 5' lengths. | —                                | Gray   | 5          | 5              |
| <b>PMR40 Metal Raceway Divider Wall Clip</b> |  |                                  |        |            |                |
| <b>PMR40DC-X</b>                             | Divider wall clip. Required for supporting PMR40DW. 30" spacing recommended between clips.   | —                                | Gray   | —          | 10             |

‡For other colors replace WH (White) with AL (Almond). Order number of feet required in multiples of standard carton quantity. Order raceway base and cover separately.

## Pan-Way® PMR40 Metal Raceway Fittings

- PMR40 fittings are designed to exceed the TIA/EIA-568-B and 569-B required minimum bend radius for high performance copper and fiber optic cabling systems

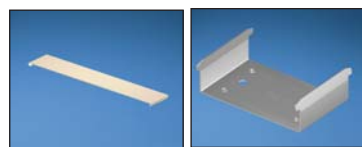

PMR40SCWH-X

PMR40BC



PMR40RA

PMR40SIC

| Part Number        | Part Description   | Color‡ | Std. Pkg. Qty. | Std. Ctn. Qty. |
|--------------------|--|--------|----------------|----------------|
| <b>PMR40SCWH-X</b> | Seam clip. Used to join sections of PMR40 raceway.   | White  | 10             | 100            |
| <b>PMR40BC</b>     | Base coupler. Used to join sections of PMR40 raceway base.   | Gray   | 10             | 100            |
| <b>PMR40RAWH</b>   | Right angle fitting. Used to join sections of PMR40 raceway at right angles.                               | White  | 1              | 10             |
| <b>PMR40SIC</b>    | Inside corner fitting w/out bend radius control. Used to join sections of PMR40 raceway at inside corners. | Gray   | 1              | 10             |

‡For other colors replace WH (White) with AL (Almond).

Table continues on page C2.6

A. System Overview

B1. Cable Ties

B2. Cable Accessories

B3. Stainless Steel Ties

C1. Wiring Duct

C2. Surface Raceway

C3. Abrasion Protection

C4. Cable Management

D1. Terminals

D2. Power Connectors

D3. Grounding Connectors

E1. Labeling Systems

E2. Labels

E3. Pre-Printed & Write-On Markers

E4. Permanent Identification

E5. Lockout/Tagout & Safety Solutions

F. Index

A. System Overview

 **Pan-Way® PMR40 Metal Raceway Fittings (continued)**

B1. Cable Ties



**PMR40IC**



**PMR40I45E**

B2. Cable Accessories

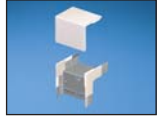

**PMR40SOC**

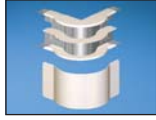

**PMR40OC**

B3. Stainless Steel Ties

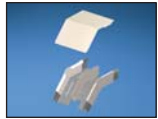

**PMR40E45E**

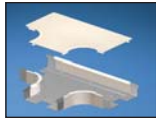

**PMR40T**

C1. Wiring Duct



**PMR40TD50**



**PMR40EC**

C2. Surface Raceway

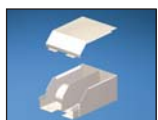

**PMR40EE**



**PMR40TR**

C3. Abrasion Protection

C4. Cable Management

D1. Terminals



**PMR40BF**



**PMR40PC**

D2. Power Connectors



**PMR40ICC**



**PMR40WR**

D3. Grounding Connectors

E1. Labeling Systems

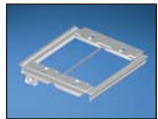

**PMR40DB50**

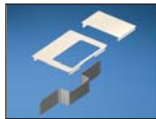

**PMR40DP50**

E2. Labels

E3. Pre-Printed & Write-On Markers

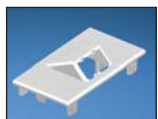

**PMR40FH2**

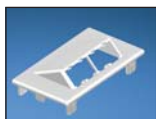

**PMR40FH4**

E4. Permanent Identification



**PMR40KH2**



**PMR40KH4**

E5. Lockout/Tagout & Safety Solutions



**RBFIWH**

F. Index

| Part Number        | Part Description  | Color‡ | Std. Pkg. Qty. | Std. Ctn. Qty. |
|--------------------|---|--------|----------------|----------------|
| <b>PMR40ICWH</b>   | Inside corner fitting. Used to join sections of PMR40 raceway at inside corners.  | White  | 1              | 10             |
| <b>PMR40I45EWH</b> | Internal 45° elbow fitting. Used to join sections of PMR40 raceway at 45° inside corners.   | White  | 1              | 10             |
| <b>PMR40SOCWH</b>  | Outside corner fitting without bend radius control. Used to join sections of PMR40 raceway at outside corners.  | White  | 1              | 10             |
| <b>PMR40OCWH</b>   | Outside corner fitting. Used to join sections of PMR40 raceway at outside corners.  | White  | 1              | 10             |
| <b>PMR40E45EWH</b> | External 45° elbow fitting. Used to join sections of PMR40 raceway at 45° outside corners.  | White  | 1              | 10             |
| <b>PMR40TWH</b>    | Tee fitting. Used to join sections of PMR40 raceway at tee intersections.   | White  | 1              | 10             |
| <b>PMR40TD50</b>   | Tee divider insert for a 50/50 data/power split. Maintains a 50/50 channel separation for power and data applications.  | Gray   | 1              | 10             |
| <b>PMR40ECWH</b>   | End cap fitting. Used to terminate or allow entry into PMR40 raceway. Breakouts for 1/2" conduit.   | White  | 1              | 10             |
| <b>PMR40EEWH</b>   | Entrance end fitting. Breakouts for 3/4", 1", and 1 1/4" conduit which allows entry from ceiling or wall.   | White  | 1              | 10             |
| <b>PMR40TRWH</b>   | WIREMOLD* to PMR40 transition fitting. In-line transition fitting from WIREMOLD* 4000 series to PMR40 raceway.  | White  | 1              | 10             |
| <b>PMR40BFWH</b>   | Backfeed fitting. Allows cable entry through the back of the PMR40 raceway. Two round breakouts for 1/2", 3/4" and 1" conduit, two round breakouts for 3/4", 1", and 1 1/4" conduit and two 1 11/16" X 2 9/16" rectangular breakouts. | White  | 1              | 10             |
| <b>PMR40PCWH</b>   | Panel connector. To connect PMR40 raceway with surface type panel boxes.  | White  | 1              | 10             |
| <b>PMR40ICC</b>    | Internal corner coupling.   | Gray   | 1              | 10             |
| <b>PMR40WR-X</b>   | Wire retainer. Used to hold wires in place during installation.   | Gray   | 10             | 100            |
| <b>PMR40DB50</b>   | Device mounting bracket 50/50 split. Used to mount NEMA standard single gang electrical outlets and communication devices with either screw-on or snap-on single gang faceplates.   | Gray   | 1              | 10             |
| <b>PMR40DP50WH</b> | PMR40 data plate for mounting data faceplates PMR40FH2, PMR40FH4, PMR40KH2 or PMR40KH4 when a 50/50 split channel is used in the PMR40 base. Includes data plate, 2.50" pre-cut cover, and offset divider wall.                       | White  | 1              | 10             |
| <b>PMR40FH2WH</b>  | Snap-on horizontal sloped communication faceplate. Accepts two Panduit® Mini-Com® Modules (not included). Note: Customer needs to purchase PMR40DP50WH.   | White  | 1              | 10             |
| <b>PMR40FH4WH</b>  | Snap-on horizontal sloped communication faceplate. Accepts four Panduit® Mini-Com® Modules (not included). Note: Customer needs to purchase PMR40DP50WH.  | White  | 1              | 10             |
| <b>PMR40KH2WH</b>  | Snap-on horizontal sloped communication faceplate. Accepts two Keystone modules (not included). Note: Customer needs to purchase PMR40DP50WH.   | White  | 1              | 10             |
| <b>PMR40KH4WH</b>  | Snap-on horizontal sloped communication faceplate. Accepts four Keystone modules (not included). Note: Customer needs to purchase PMR40DP50WH.  | White  | 1              | 10             |
| <b>RBFIWH</b>      | Rectangular blank faceplate. Snap-in insert for any NEMA standard rectangular opening in metal raceway faceplates. Reserves the location for future use.  | White  | 1              | 10             |

‡For other colors replace WH (White) with AL (Almond).

\*WIREMOLD is a registered trademark of the Wiremold Co.

## Cable Fill Capacities for PMR40 Metal Raceway

This information is to be used as a guide in selecting the proper size raceway. The maximum amounts may vary according to the cable installation methods, straightness of cables, etc.



**A = 7.45 in.<sup>2</sup>**

**Cable fill #1:** Open channel without devices

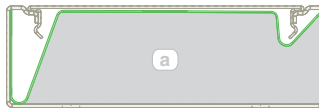

**A = 6.18 in.<sup>2</sup>**

**Cable fill #2:** Undivided, wire retainer only



**A = 2.64 in.<sup>2</sup>**

**B = 3.04 in.<sup>2</sup>**

**Cable fill #3:** Divided with wire retainer

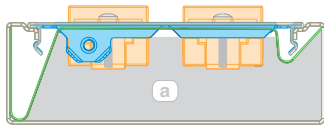

**A = 4.64 in.<sup>2</sup>**

**Cable fill #4:** Undivided with duplex receptacle on two sides

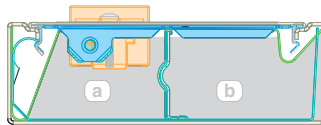

**A = 1.87 in.<sup>2</sup>**

**B = 2.84 in.<sup>2</sup>**

**Cable fill #5:** Divided with duplex receptacle on (A) side

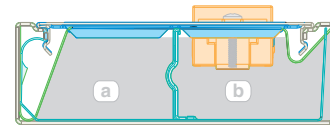

**A = 2.49 in.<sup>2</sup>**

**B = 2.21 in.<sup>2</sup>**

**Cable fill #6:** Divided with duplex receptacle on (B) side

**SPEC = 40% cable fill** – Recommended by TIA/EIA-569-B for design.

**MAX for 60% cable fill** – Recommended by TIA/EIA-569-B for unplanned additions.

**MAX for 40% power cable fill** – Based on available internal area.

| Raceway Type and Configuration                         | Fill Area (in <sup>2</sup> )                           | Electrical Cables |         |         | Data Grade Cables |         | Data Grade Cables |         | Audio/Video  |         |
|--|--|-------------------|---------|---------|-------------------|---------|-------------------|---------|--------------|---------|
|  |  | 14 AWG            | 12 AWG  | 10 AWG  | 24 AWG/UTP CM     |         | 24 AWG/UTP CM     |         | RG6          |         |
|  |  | THHN/T90          |         |         | Cat. 6            |         | Cat. 6A           |         |              |         |
|  |  | 0.111             | 0.130   | 0.164   | DIA. = 0.250      |         | DIA. = 0.330      |         | DIA. = 0.275 |         |
|  |  | FILL              |         |         | FILL              |         | FILL              |         | FILL         |         |
|  |  | MAX 40%           | MAX 40% | MAX 40% | SPEC 40%          | MAX 60% | SPEC 40%          | MAX 60% | SPEC 40%     | MAX 60% |
| 1. PMR40 - Undivided (base and cover)                  | 7.45   | 307               | 224     | 140     | 60                | 91      | 34                | 52      | 50           | 75      |
| 2. PMR40 - Undivided, wire retainer only               | 6.18   | 255               | 186     | 117     | 50                | 75      | 28                | 43      | 41           | 62      |
| 3a. PMR40 - Divided, with wire retainer                | 2.64   | 109               | 79      | 50      | 21                | 32      | 12                | 18      | 17           | 26      |
|  | 3b. PMR40 - Divided, with wire retainer                | 3.04              | 125     | 91      | 57                | 24      | 37                | 14      | 21           | 30      |
| 4. PMR40 - Undivided with duplex receptacle 2 sides    | 4.64   | 191               | 139     | 87      | —                 | —       | —                 | —       | —            | —       |
| 5a. PMR40 - Divided with duplex receptacle on (A) side | 1.87   | 78                | 57      | 36      | —                 | —       | —                 | —       | —            | —       |
|  | 5b. PMR40 - Divided with duplex receptacle on (A) side | 2.84              | —       | —       | —                 | 23      | 34                | 13      | 19           | 19      |
| 6a. PMR40 - Divided with duplex receptacle on (B) side | 2.49   | —                 | —       | —       | 20                | 30      | 11                | 17      | 16           | 25      |
|  | 6b. PMR40 - Divided with duplex receptacle on (B) side | 2.21              | 91      | 66      | 41                | —       | —                 | —       | —            | —       |

AWG dimensions represent typical outer cable diameter in inches.

A.  
System  
Overview

## PMR5/7 Raceway Roadmap

B1.  
Cable Ties

B2.  
Cable  
Accessories

B3.  
Stainless  
Steel Ties

C1.  
Wiring  
Duct

C2.  
Surface  
Raceway

C3.  
Abrasion  
Protection

C4.  
Cable  
Management

D1.  
Terminals

D2.  
Power  
Connectors

D3.  
Grounding  
Connectors

E1.  
Labeling  
Systems

E2.  
Labels

E3.  
Pre-Printed  
& Write-On  
Markers

E4.  
Permanent  
Identification

E5.  
Lockout/  
Tagout  
& Safety  
Solutions

F.  
Index

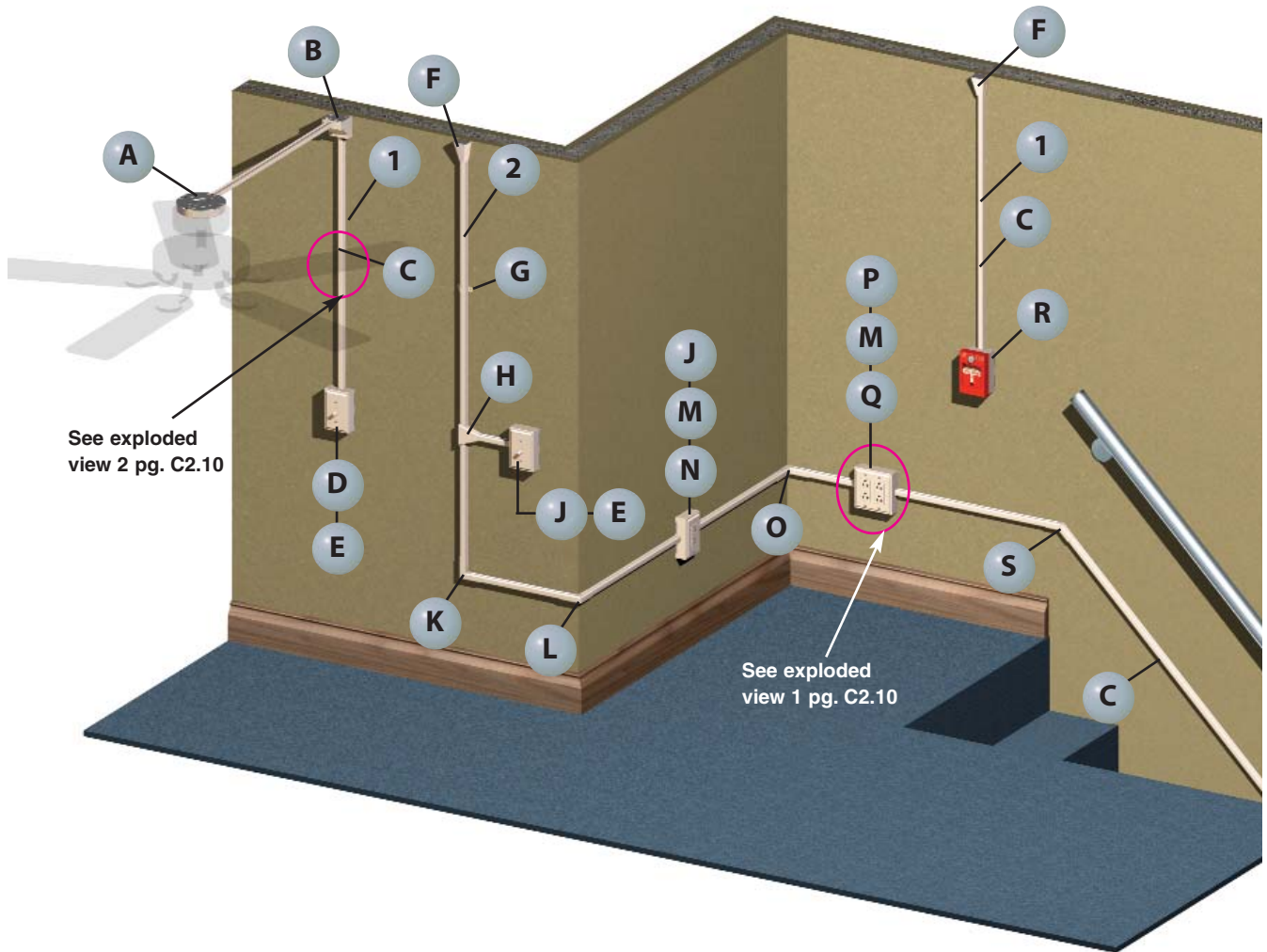



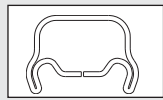

**1** PMR5\*\* – PMR5 Metal Raceway (page C2.11)

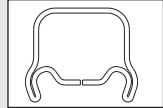

**2** PMR7\*\* – PMR7 Metal Raceway (page C2.11)



**A** PMR5738A\*\* – Round Fan/Fixture Box (page C2.16)

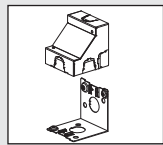

**B** PMR57CB\*\* – Corner Box (page C2.12)

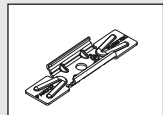

**C** PMR57SC-X – Supporting Clip (page C2.11)

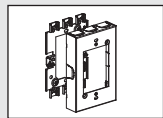

**D** PMR5751\*\* – Single Gang Extension Box (page C2.15)

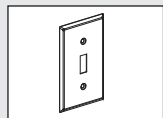

**E** MP1TS\*\* – Single Gang Toggle Switch Faceplate (page C2.17)

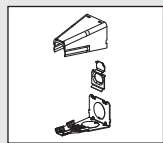

**F** PMR57EE\*\* – Entrance End Fitting (page C2.12)

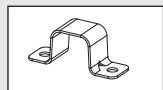

**G** PMR7MS\*\* – Mounting Strap (page C2.11)

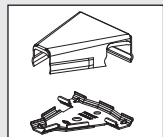

**H** PMR57T\*\* – Tee Fitting (page C2.12)

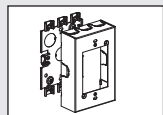

**J** PMR5747\*\* – Single Gang Shallow Outlet Box (page C2.15)

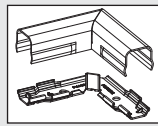

**K** PMR7RA\*\* – Right Angle Fitting (page C2.12)

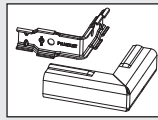

**L** PMR7OC\*\* – Outside Corner Fitting (page C2.12)

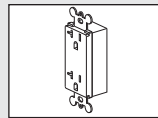

**M** ERU20\*\* – 20 A Specification Grade Rectangular Outlet (page C2.61)

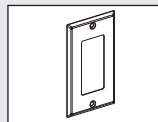

**N** MP1GR\*\* – Single Gang Rectangular Faceplate (page C2.17)

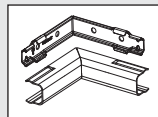

**O** PMR7IC\*\* – Inside Corner Fitting (page C2.12)

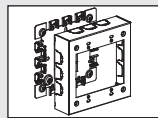

**P** PMR5747-2\*\* – Double Gang Shallow Outlet Box (page C2.15)

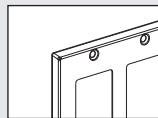

**Q** MP2GR\*\* – Double Gang Rectangular Faceplate (page C2.17)

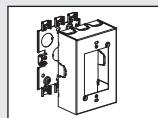

**R** PMR5748\*\* – Single Gang Outlet Box (page C2.15)

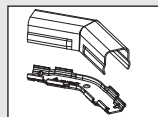

**S** PMR7DA\*\* – Diagonal 45° Angle Fitting (page C2.12)

A. System Overview

B1. Cable Ties

B2. Cable Accessories

B3. Stainless Steel Ties

C1. Wiring Duct

C2. Surface Raceway

C3. Abrasion Protection

C4. Cable Management

D1. Terminals

D2. Power Connectors

D3. Grounding Connectors

E1. Labeling Systems

E2. Labels

E3. Pre-Printed & Write-On Markers

E4. Permanent Identification

E5. Lockout/Tagout & Safety Solutions

F. Index

A.  
System  
Overview

## PMR5/PMR7 Configurations

B1.  
Cable Ties

### Exploded View 1

|    | Components Required                            | See page |
|----|--|----------|
| A. | MP2GR = Double gang rectangular faceplate.     | C2.17    |
| B. | ERU20 = 20 A Specification rectangular outlet. | C2.61    |
| C. | PMR5747-2 = Double gang deep outlet box.       | C2.15    |

B2.  
Cable  
Accessories

B3.  
Stainless  
Steel Ties

C1.  
Wiring  
Duct

C2.  
Surface  
Raceway

C3.  
Abrasion  
Protection

C4.  
Cable  
Management

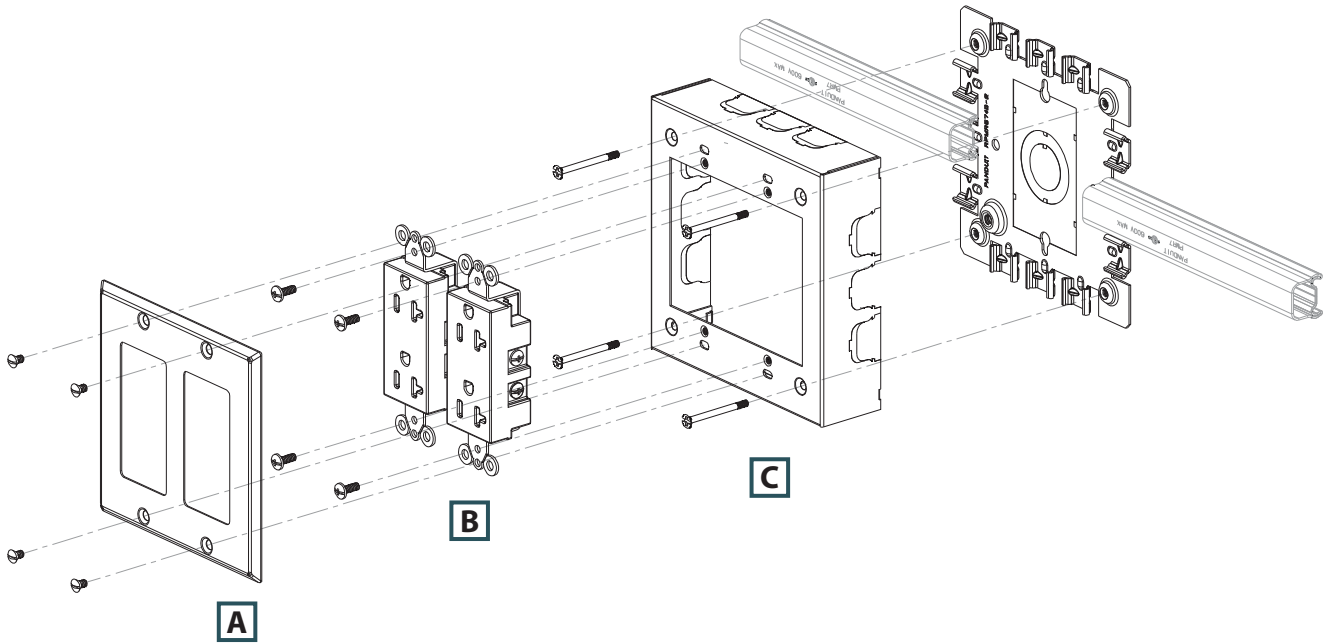

D1.  
Terminals

D2.  
Power  
Connectors

### Exploded View 2

|    | Components Required           | See page |
|----|-------------------------------|----------|
| A. | PMR57SC-X = Supporting clip.  | C2.11    |
| B. | PMR7*** = PMR7 metal raceway. | C2.11    |

D3.  
Grounding  
Connectors

E1.  
Labeling  
Systems

E2.  
Labels

E3.  
Pre-Printed  
& Write-On  
Markers

E4.  
Permanent  
Identification

E5.  
Lockout/  
Tagout  
& Safety  
Solutions

F.  
Index

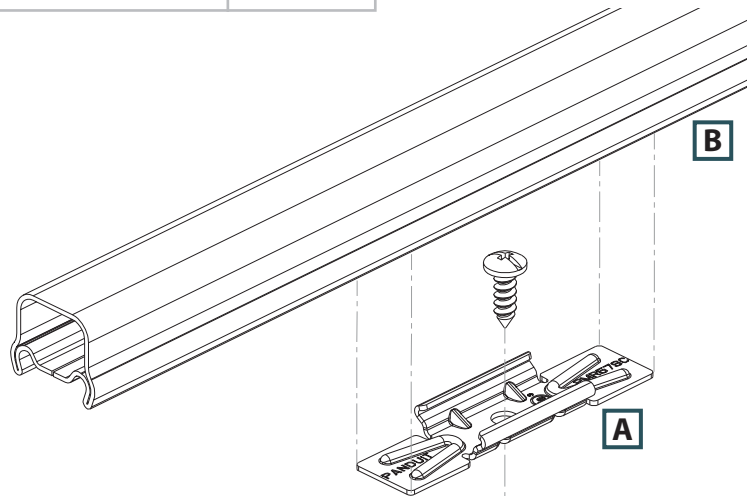



## c-UL-us Pan-Way® PMR5/PMR7 Metal Raceway System

- c-UL-us listed and rated to 600 V; meets UL 5 and CSA22.2 No. 62-93 safety standards
- Raceway system features a patent pending bonding design that provides full continuity of the ground path between fittings and channel, for increased electrical safety
- System components incorporate a unique snap mount assembly method for faster installation

- Fittings and mounts can be attached using various types and sizes of fasteners, eliminating the requirements of using only flat head style screws
- One-piece channel construction eliminates the problem of channel separation, associated with competitive two-piece designs, saving installation time

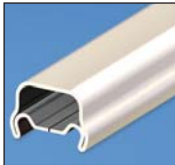
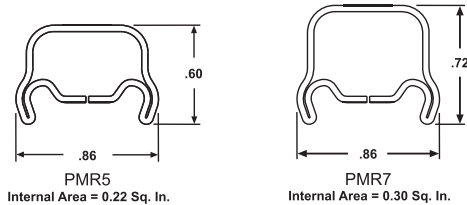

PMR5

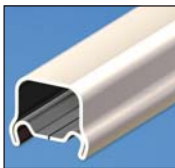

PMR7



PMR57SC

PMR57JC

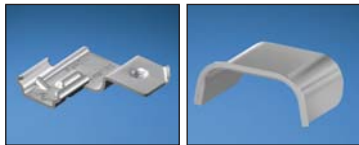

PMR57GC

PMR5WPB  
PMR7WPB



PMR5MS  
PMR7MS

| Part Number               | Part Description  | Raceway Size                       | Color‡ | Length (Ft.) | Std. Pkg. Qty. | Std. Ctn. Qty. |
|---------------------------|---|------------------------------------|--------|--------------|----------------|----------------|
| <b>PMR5 Metal Raceway</b> |   |                                    |        |              |                |                |
| <b>PMR5WH5</b>            | One-piece single channel metal surface raceway. Available in 5' lengths.  | 0.86" x 0.60"<br>(21.8mm x 15.2mm) | White  | 5            | 5              | 50             |
| <b>PMR5WH10</b>           | One-piece single channel metal surface raceway. Available in 10' lengths.   | 0.86" x 0.60"<br>(21.8mm x 15.2mm) | White  | 10           | 10             | 100            |
| <b>PMR7 Metal Raceway</b> |   |                                    |        |              |                |                |
| <b>PMR7WH5</b>            | One-piece single channel metal surface raceway. Available in 5' lengths.  | 0.86" x 0.72"<br>(21.8mm x 18.3mm) | White  | 5            | 5              | 50             |
| <b>PMR7WH10</b>           | One-piece single channel metal surface raceway. Available in 10' lengths.   | 0.86" x 0.72"<br>(21.8mm x 18.3mm) | White  | 10           | 10             | 100            |
| <b>PMR7 Metal Raceway</b> |   |                                    |        |              |                |                |
| <b>PMR57SC-X</b>          | Supporting clip used to support lengths of PMR5 or PMR7 raceway at any desired point.   | —                                  | Gray   | —            | 10             | 100            |
| <b>PMR7 Metal Raceway</b> |   |                                    |        |              |                |                |
| <b>PMR57JC-X</b>          | Joint coupling used to join two lengths of PMR5 or PMR7 raceway.  | —                                  | Gray   | —            | 10             | 100            |
| <b>PMR7 Metal Raceway</b> |   |                                    |        |              |                |                |
| <b>PMR57GC-X</b>          | Ground clip used to provide additional grounding of raceway or to ground remote installations. For use with PMR5 or PMR7 raceway. | —                                  | Gray   | —            | 10             | 100            |
| <b>Supporting Clip</b>    |   |                                    |        |              |                |                |
| <b>PMR5WPB-X</b>          | Bushing used to protect wires from abrasion. For use with PMR5 raceway.   | —                                  | Gray   | —            | 10             | 100            |
| <b>PMR7WPB-X</b>          | Bushing used to protect wires from abrasion. For use with PMR7 raceway.   | —                                  | Gray   | —            | 10             | 100            |
| <b>PMR7 Metal Raceway</b> |   |                                    |        |              |                |                |
| <b>PMR5MSWH-X</b>         | Mounting strap for use with PMR5 raceway.   | —                                  | White  | —            | 10             | 100            |
| <b>PMR7MSWH-X</b>         | Mounting strap for use with PMR7 raceway.   | —                                  | White  | —            | 10             | 100            |

‡For other colors replace WH (White) with AL (Almond).

A.  
System  
Overview

B1.  
Cable  
Ties

B2.  
Cable  
Accessories

B3.  
Stainless  
Steel Ties

C1.  
Wiring  
Duct

C2.  
Surface  
Raceway

C3.  
Abrasion  
Protection

C4.  
Cable  
Management

D1.  
Terminals

D2.  
Power  
Connectors

D3.  
Grounding  
Connectors

E1.  
Labeling  
Systems

E2.  
Labels

E3.  
Pre-Printed  
& Write-On  
Markers

E4.  
Permanent  
Identification

E5.  
Lockout/  
Tagout  
& Safety  
Solutions

F.  
Index



## Pan-Way® PMR5/PMR7 Metal Raceway Fittings

A. System Overview

B1. Cable Ties

B2. Cable Accessories

B3. Stainless Steel Ties

C1. Wiring Duct

C2. Surface Raceway

C3. Abrasion Protection

C4. Cable Management

D1. Terminals

D2. Power Connectors

D3. Grounding Connectors

E1. Labeling Systems

E2. Labels

E3. Pre-Printed & Write-On Markers

E4. Permanent Identification

E5. Lockout/Tagout & Safety Solutions

F. Index

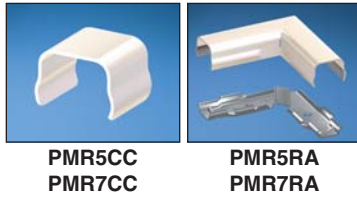

**PMR5CC**  
**PMR7CC**

**PMR5RA**  
**PMR7RA**

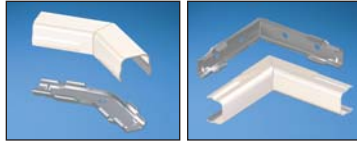

**PMR5DA**  
**PMR7DA**

**PMR5IC**  
**PMR7IC**

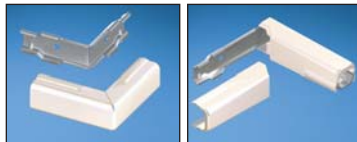

**PMR5OC**  
**PMR7OC**

**PMR57LTE**



**PMR57RTE**

**PMR57T**



**PMR57EE**

**PMR57AOC**



**PMR57CB**

**PMR57TR**  
**PMR7TR**



**PMR57EBC**

**PMR57ECC**



**PMR57JBC50**  
**PMR57JBC75**

**PMR57CC50**  
**PMR57CC75**

| Part Number         | Part Description  | Color‡ | Std. Pkg. Qty. | Std. Ctn. Qty. |
|---------------------|---|--------|----------------|----------------|
| <b>PMR5CCWH-X</b>   | Coupler fitting for use with PMR5 raceway.  | White  | 10             | 100            |
| <b>PMR7CCWH-X</b>   | Coupler fitting for use with PMR7 raceway.  | White  | 10             | 100            |
| <b>PMR5RAWH</b>     | Right angle fitting for use with PMR5 raceway.  | White  | 1              | 10             |
| <b>PMR7RAWH</b>     | Right angle fitting for use with PMR7 raceway.  | White  | 1              | 10             |
| <b>PMR5DAWH</b>     | Diagonal 45° angle fitting for use with PMR5 raceway.   | White  | 1              | 10             |
| <b>PMR7DAWH</b>     | Diagonal 45° angle fitting for use with PMR7 raceway.   | White  | 1              | 10             |
| <b>PMR5ICWH</b>     | Inside corner fitting for use with PMR5 raceway.  | White  | 1              | 10             |
| <b>PMR7ICWH</b>     | Inside corner fitting for use with PMR7 raceway.  | White  | 1              | 10             |
| <b>PMR5OCWH</b>     | Outside corner fitting for use with PMR5 raceway.   | White  | 1              | 10             |
| <b>PMR7OCWH</b>     | Outside corner fitting for use with PMR7 raceway.   | White  | 1              | 10             |
| <b>PMR57LTEWH</b>   | Left twisted elbow for 90° twist with 90° turn. For double turn at right angles from one surface to another, such as a flat run on a sidewall to a flat run on a ceiling. For use with PMR5 and PMR7 raceway.               | White  | 1              | 10             |
| <b>PMR57RTEWH</b>   | Right twisted elbow for 90° twist with 90° turn. For double turn at right angles from one surface to another, such as a flat run on a sidewall to a flat run on a ceiling. For use with PMR5 and PMR7 raceway.              | White  | 1              | 10             |
| <b>PMR57TWH</b>     | Tee fitting for use with PMR5 or PMR7 raceway.  | White  | 1              | 10             |
| <b>PMR57EEWH</b>    | Entrance end fitting. 1/2" conduit breakouts allows entry of PMR5 or PMR7 raceway from a box, the ceiling, or a wall. Spring steel bushing included for use when connecting to a box.                                       | White  | 1              | 10             |
| <b>PMR57AOCWH</b>   | Adjustable offset allows PMR5 or PMR7 to be mounted flush to wall when connected to surface type panel boxes. Adjustable between 5/8" and 1 3/8" from surface to center of conduit. 1/2" chase nipple and locknut included. | White  | 1              | 10             |
| <b>PMR57CBWH</b>    | Corner box for connecting PMR5 or PMR7 raceway. Each leg has 1/2" conduit breakouts and room for splicing.  | White  | 1              | 10             |
| <b>PMR57TRWH</b>    | WIREMOLD* to PMR5 transition fitting. In-line transition fitting from WIREMOLD* 500 series to PMR5 raceway.   | White  | 1              | 10             |
| <b>PMR77TRWH</b>    | WIREMOLD* to PMR7 Transition fitting. In-line transition fitting from WIREMOLD* 700 series to PMR7 raceway.   | White  | 1              | 10             |
| <b>PMR57EBCWH</b>   | Elbow box connector used to connect PMR5 or PMR7 raceway to boxes at a right angle. Breakouts for 1/2" conduit.   | White  | 1              | 10             |
| <b>PMR57ECCWH</b>   | Elbow conduit connector used to connect PMR5 or PMR7 raceway to conduit at a right angle. Breakouts for 1/2" conduit.   | White  | 1              | 10             |
| <b>PMR57JBC50-X</b> | Junction box connector used to connect PMR5 or PMR7 raceway to boxes with 1/2" conduit breakout.  | White  | 10             | 100            |
| <b>PMR57JBC75-X</b> | Junction box connector used to connect PMR5 or PMR7 raceway to boxes with 3/4" conduit breakout.  | White  | 10             | 100            |
| <b>PMR57CC50-X</b>  | Conduit connector used to connect PMR5 or PMR7 raceway to 1/2" conduit.   | White  | 10             | 100            |
| <b>PMR57CC75-X</b>  | Conduit connector used to connect PMR5 or PMR7 raceway to 3/4" conduit.   | White  | 10             | 100            |

‡For other colors replace WH (White) with AL (Almond).

\*WIREMOLD is a registered trademark of the Wiremold Co.

**cUL<sub>us</sub> PMR5 and PMR7 Raceway Accessories**



**PMR57MRT**



**PMRTUP\*\***

| Part Number     | Part Description   | Color | Std. Pkg. Qty. | Std. Ctn. Qty. |
|-----------------|--|-------|----------------|----------------|
| <b>PMR57MRT</b> | Metal raceway tool. To aid in the installation and removal of PMR5 and PMR7 metal raceway base sections. | Black | 1              | 10             |
| <b>PMRTUPAL</b> | Touch-up paint pen. Used to repair areas of metal raceway where paint has been removed or damaged.       | —     | 1              | 10             |
| <b>PMRTUPWH</b> | Touch-up paint pen. Used to repair areas of metal raceway where paint has been removed or damaged.       | —     | 1              | 10             |

A. System Overview

B1. Cable Ties

B2. Cable Accessories

B3. Stainless Steel Ties

C1. Wiring Duct

C2. Surface Raceway

C3. Abrasion Protection

C4. Cable Management

D1. Terminals

D2. Power Connectors

D3. Grounding Connectors

E1. Labeling Systems

E2. Labels

E3. Pre-Printed & Write-On Markers

E4. Permanent Identification

E5. Lockout/Tagout & Safety Solutions

F. Index

A. System Overview

## Cable Fill Capacities for PMR5/PMR7 Metal Raceway

B1. Cable Ties

This information is to be used as a guide in selecting the proper size raceway. The maximum amounts may vary according to the cable installation methods, straightness of cables, etc.

B2. Cable Accessories

B3. Stainless Steel Ties

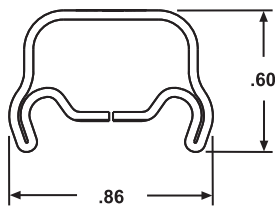

PMR5

$$A = .22 \text{ in.}^2$$

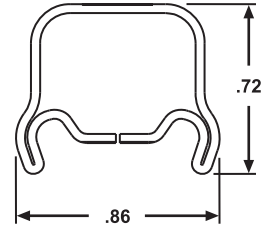

PMR7

$$A = .30 \text{ in.}^2$$

C1. Wiring Duct

C2. Surface Raceway

C3. Abrasion Protection

C4. Cable Management

**SPEC = 40% cable fill** – The recommended design in cable capacity, leaves room for future moves, adds, and changes.

**MAX for Data = 60% cable fill** – The maximum cable quantity based on cable interweaving and packing factors.

D1. Terminals

D2. Power Connectors

D3. Grounding Connectors

| Raceway Type and Configuration | Fill Area (In. <sup>2</sup> ) | Electrical Cables |        |        | Data Grade Cables |     | Data Grade Cables |     | Audio/Video  |     | Fiber Optic Cable |     |
|--------------------------------|-------------------------------|-------------------|--------|--------|-------------------|-----|-------------------|-----|--------------|-----|-------------------|-----|
|                                |                               | 14 AWG            | 12 AWG | 10 AWG | 24 AWG/UTP CM     |     | 24 AWG/UTP CM     |     | RG6          |     | 2 Strand          |     |
|                                |                               | THHN/T90          |        |        | Category 6        |     | Category 6A       |     | Dia. = 0.275 |     | Dia. = 0.175      |     |
|                                |                               | 0.111             | 0.130  | 0.164  | Dia. = 0.250      |     | Dia. = 0.330      |     | FILL         |     | FILL              |     |
|                                |                               | MAX               | MAX    | MAX    | SPEC              | MAX | SPEC              | MAX | SPEC         | MAX | SPEC              | MAX |
| PMR5                           | 0.22                          | 9                 | 6      | 4      | 1                 | 2   | 1                 | 1   | 1            | 2   | 3                 | 5   |
| PMR7                           | 0.30                          | 12                | 8      | 5      | 2                 | 3   | 1                 | 2   | 2            | 3   | 4                 | 7   |

AWG dimensions represent typical outer cable diameter in inches.

E1. Labeling Systems

E2. Labels

E3. Pre-Printed & Write-On Markers

E4. Permanent Identification

E5. Lockout/Tagout & Safety Solutions

F. Index

**UL** **Pan-Way® Metal Raceway Boxes**



PMR5760

PMR5751



PMR5751-2

PMR5751-3

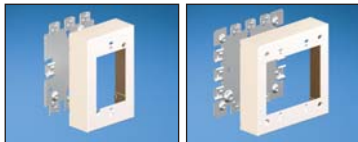

PMR5747

PMR5747-2

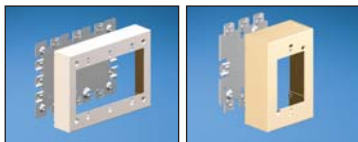

PMR5747-3

PMR5748

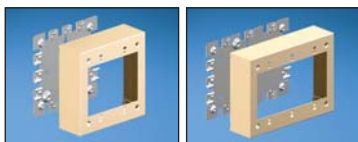

PMR5748-2

PMR5748-3

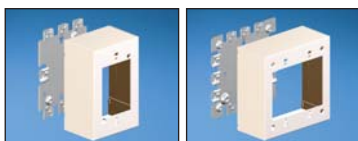

PMR5744S

PMR5744S-2

| Part Number  | Part Description   | Color‡ | Std. Pkg. Qty. | Std. Ctn. Qty. |
|--------------|--|--------|----------------|----------------|
| PMR5760WH    | Single gang blank extension box. For use with Pan-Way® PMR5 or PMR7 Raceway. 4.92"L x 3.17"W x 0.94"H (125.0mm x 80.5mm x 23.8mm)  | White  | 1              | 10             |
| PMR5751WH    | Single gang extension box. Box accepts Pan-Way® Faceplates or any NEMA standard single gang faceplate. For use with Pan-Way® PMR5 or PMR7 Raceway. 4.92"L x 3.17"W x .94"H (125.0mm x 80.5mm x 23.8mm)   | White  | 1              | 10             |
| PMR5751-2WH  | Double gang extension box. Box accepts Pan-Way® Faceplates or any standard double gang faceplate. For use with Pan-Way® PMR5 or PMR7 Raceway. 4.92"L x 4.92"W x .94"H (125.0mm x 125.0mm x 23.8mm)   | White  | 1              | 10             |
| PMR5751-3WH  | Three gang extension box. Box accepts Pan-Way® Faceplates or any standard three gang faceplate. For use with Pan-Way® PMR5 or PMR7 Raceway. 4.92"L x 6.72"W x .94"H (125.0mm x 170.7mm x 23.8mm)   | White  | 1              | 10             |
| PMR5747WH    | Single gang shallow outlet box. Box accepts Pan-Way® Faceplates or any NEMA standard single gang faceplate. For use with Pan-Way® PMR5 or PMR7 Raceway. Breakouts for 1/2" conduit. 4.92"L x 3.17"W x 1.38"H (125.0mm x 80.5mm x 34.9mm)         | White  | 1              | 10             |
| PMR5747-2WH  | Double gang shallow outlet box. Box accepts Pan-Way® Faceplates or any standard double gang faceplate. For use with Pan-Way® PMR5 or PMR7 Raceway. Breakouts for 1/2" and 1" conduit. 4.92"L x 4.92"W x 1.38"H (125.0mm x 125.0mm x 34.9mm)      | White  | 1              | 10             |
| PMR5747-3WH  | Three gang shallow outlet box. Box accepts Pan-Way® Faceplates or any standard three gang faceplate. For use with Pan-Way® PMR5 or PMR7 Raceway. Breakouts for 1/2" conduit. 4.92"L x 6.72"W x 1.38"H (125.0mm x 170.7mm x 34.9mm)               | White  | 1              | 10             |
| PMR5748WH    | Single gang outlet box. Box accepts Pan-Way® Faceplates or any NEMA standard single gang faceplate. For use with Pan-Way® PMR5 or PMR7 Raceway. Breakouts for 1/2" conduit. 4.92"L x 3.17"W x 1.75"H (125.0mm x 80.5mm x 44.5mm)                 | White  | 1              | 10             |
| PMR5748-2WH  | Double gang outlet box. Box accepts Pan-Way® Faceplates or any standard double gang faceplate. For use with Pan-Way® PMR5 or PMR7 Raceway. Breakouts for 1/2" and 1" conduit. 4.92"L x 4.92"W x 1.75"H (125.0mm x 125.0mm x 44.5mm)              | White  | 1              | 10             |
| PMR5748-3WH  | Three gang outlet box. Box accepts Pan-Way® Faceplates or any standard three gang faceplate. For use with Pan-Way® PMR5 or PMR7 Raceway. Breakouts for 1/2" conduit. 4.92"L x 6.72"W x 1.75"H (125.0mm x 170.7mm x 44.5mm)                       | White  | 1              | 10             |
| PMR5744SWH   | Single gang intermediate outlet box. Box accepts Pan-Way® Faceplates or any NEMA standard single gang faceplate. For use with Pan-Way® PMR5 or PMR7 Raceway. Breakouts for 1/2" conduit. 4.92"L x 3.17"W x 2.25"H (125.0mm x 80.5mm x 57.2mm)    | White  | 1              | 10             |
| PMR5744S-2WH | Double gang intermediate outlet box. Box accepts Pan-Way® Faceplates or any standard double gang faceplate. For use with Pan-Way® PMR5 or PMR7 Raceway. Breakouts for 1/2" and 1" conduit. 4.92"L x 4.92"W x 2.25"H (125.0mm x 125.0mm x 57.2mm) | White  | 1              | 10             |

‡For other colors replace WH (White) with AL (Almond).

Table continues on page C2.16

A. System Overview

B1. Cable Ties

B2. Cable Accessories

B3. Stainless Steel Ties

C1. Wiring Duct

C2. Surface Raceway

C3. Abrasion Protection

C4. Cable Management

D1. Terminals

D2. Power Connectors

D3. Grounding Connectors

E1. Labeling Systems

E2. Labels

E3. Pre-Printed & Write-On Markers

E4. Permanent Identification

E5. Lockout/Tagout & Safety Solutions

F. Index



A. System Overview

 **Pan-Way® Metal Raceway Boxes (continued)**

B1. Cable Ties

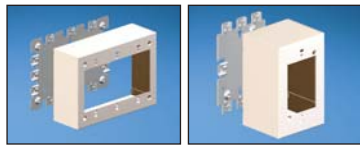

PMR5744S-3

PMR5744

B2. Cable Accessories

B3. Stainless Steel Ties

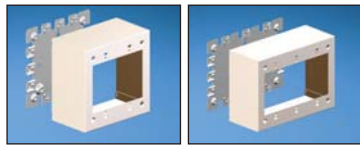

PMR5744-2

PMR5744-3

C1. Wiring Duct

C2. Surface Raceway



PMR5738

PMR5738A

C3. Abrasion Protection

C4. Cable Management



PMR5739

PMR5737

D1. Terminals

D2. Power Connectors



PMR5737A

PMR5739A

D3. Grounding Connectors

E1. Labeling Systems

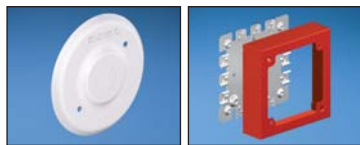

PMR5736

PMR5752

E2. Labels

E3. Pre-Printed & Write-On Markers



PMR5753

E4. Permanent Identification

E5. Lockout/Tagout & Safety Solutions

F. Index

| Part Number  | Part Description   | Color‡ | Std. Pkg. Qty. | Std. Ctn. Qty. |
|--------------|--|--------|----------------|----------------|
| PMR5744S-3WH | Three gang intermediate outlet box. Box accepts Pan-Way® Faceplates or any standard three gang faceplate. For use with Pan-Way® PMR5 or PMR7 Raceway. Breakouts for 1/2" conduit. 4.92"L x 6.72"W x 2.25"H (125.0mm x 170.7mm x 57.2mm)                                      | White  | 1              | 10             |
| PMR5744WH    | Single gang deep outlet box. Box accepts Pan-Way® Faceplates or any NEMA standard single gang faceplate. For use with Pan-Way® PMR5 or PMR7 Raceway. Breakouts for 1/2" conduit. 4.92"L x 3.17"W x 2.75"H (125.0mm x 80.5mm x 69.9mm)  | White  | 1              | 10             |
| PMR5744-2WH  | Double gang deep outlet box. Box accepts Pan-Way® Faceplates or any standard double gang faceplate. For use with Pan-Way® PMR5 or PMR7 Raceway. Breakouts for 1/2" and 1" conduit. 4.92"L x 4.92"W x 2.75"H (125.0mm x 80.5mm x 69.9mm)                                      | White  | 1              | 10             |
| PMR5744-3WH  | Three gang deep outlet box. Box accepts Pan-Way® Faceplates or any standard three gang faceplate. For use with Pan-Way® PMR5 or PMR7 Raceway. Breakouts for 1/2" conduit. 4.92"L x 6.72"W x 2.75"H (125.0mm x 170.7mm x 69.9mm)  | White  | 1              | 10             |
| PMR5738WH    | Round fixture box with solid base is c-UL-us rated to accept devices up to 50 lbs. For use with Pan-Way® PMR5 or PMR7 Raceway. Base has four 1/2" conduit breakouts. Dia.= 4.77"D x 1.00"H (121.2mm x 25.4mm)  | White  | 1              | 10             |
| PMR5738AWH   | Round fan or fixture box with solid base is c-UL-us rated to accept devices up to 50 lbs. For use with Pan-Way® PMR5 or PMR7 Raceway. Base has four 1/2" conduit breakouts. Dia. = 5.53"D x 1.00"H (140.5mm x 25.4mm)  | White  | 1              | 10             |
| PMR5739WH    | Round fixture box with solid base is c-UL-us rated to accept devices up to 50 lbs. For use with Pan-Way® PMR5 or PMR7 Raceway. Base has four 1/2" conduit breakouts. Dia. = 6.37"D x 1.00"H (161.8mm x 25.4mm)   | White  | 1              | 10             |
| PMR5737WH    | Round extension box with open base is c-UL-us rated to accept devices up to 50 lbs. For use with Pan-Way® PMR5 or PMR7 Raceway. Dia. = 4.76"D x 1.00"H (121.0mm x 25.4mm)  | White  | 1              | 10             |
| PMR5737AWH   | Round extension box with open base is c-UL-us rated to accept devices up to 50 lbs. For use with Pan-Way® PMR5 or PMR7 Raceway. Dia. = 5.53"D x 1.00"H (140.5mm x 25.4mm)  | White  | 1              | 10             |
| PMR5739AWH   | Round extension box with open base is c-UL-us rated to accept devices up to 50 lbs. For use with Pan-Way® PMR5 or PMR7 Raceway. Dia. = 6.37"D x 1.00"H (161.8mm x 25.4mm)  | White  | 1              | 10             |
| PMR5736WH    | Round Blank Faceplate for use with Pan-Way PMR5 or PMR7 Round Outlet Boxes: PMR5737, PMR5737A, PMR5738, PMR5738A, PMR5739 and PMR5739A. Knockout for 1/2" conduit. Dia. = 4.25"D x 0.45"H (108.0mm x 11.5mm).  | White  | 1              | 50             |
| PMR5752RD    | Alarm device box. Box accepts alarm devices and safety signals designed to fit 4" square back boxes. For use with Pan-Way® PMR5 or PMR7 Raceway. Breakouts for 1/2" and 1" conduit. 4.92"L x 4.92"W x 1.42" H (125.0mm x 125.0mm x 36.1mm) <b>Available in red only.</b>     | Red    | 1              | 10             |
| PMR5753RD    | Deep alarm device box. Box accepts alarm devices and safety signals designed to fit 4" square back boxes. For use with Pan-Way® PMR5 or PMR7 Raceway. Breakouts for 1/2" and 1" conduit. 4.92"L x 4.92"W x 2.80"H (125.0mm x 125.0mm x 71.0mm) <b>Available in red only.</b> | Red    | 1              | 10             |

‡For other colors replace WH (White) with AL (Almond).





## SB® Pan-Way® Metal Raceway Faceplates

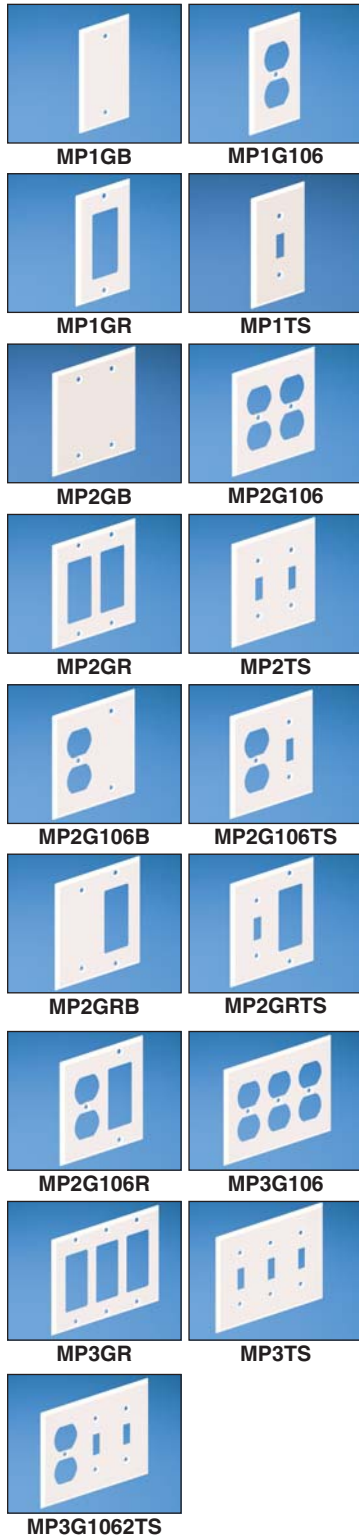

| Part Number  | Part Description   | Color‡ | Std. Pkg. Qty. | Std. Ctn. Qty. |
|--------------|--|--------|----------------|----------------|
| MP1GBWH      | Metal single gang blank faceplate.   | White  | 1              | 10             |
| MP1G106WH    | Metal single gang 106 duplex faceplate. Covers one NEMA standard 106 duplex electrical outlet or one standard 106 communication module frame.  | White  | 1              | 10             |
| MP1GRWH      | Metal single gang rectangular faceplate. Covers one NEMA standard rectangular electrical outlet or one standard rectangular communication module frame.  | White  | 1              | 10             |
| MP1TSWH      | Metal single gang toggle switch faceplate. Covers one NEMA standard toggle switch.   | White  | 1              | 10             |
| MP2GBWH      | Metal double gang blank faceplate.   | White  | 1              | 10             |
| MP2G106WH    | Metal double gang 106 duplex faceplate. Covers two NEMA standard 106 duplex electrical outlets or two standard 106 communication module frames.  | White  | 1              | 10             |
| MP2GRWH      | Metal double gang rectangular faceplate. Covers two NEMA standard rectangular electrical outlets or two standard rectangular communication module frames.  | White  | 1              | 10             |
| MP2TSWH      | Metal double gang toggle switch faceplate. Covers two NEMA standard toggle switches.   | White  | 1              | 10             |
| MP2G106BWH   | Metal double gang 106 duplex/blank faceplate. Covers one NEMA standard 106 duplex electrical outlet or standard 106 communication module frame with opposite side blank.   | White  | 1              | 10             |
| MP2G106TSWH  | Metal double gang 106 duplex/toggle switch faceplate. Covers one NEMA standard 106 duplex outlet or standard 106 communication module frame and one NEMA standard toggle switch.   | White  | 1              | 10             |
| MP2GRBWH     | Metal double gang rectangular/blank faceplate. Covers one NEMA standard rectangular electrical outlet or standard rectangular communication module frame with opposite side blank.   | White  | 1              | 10             |
| MP2GRTSWH    | Metal double gang rectangular/toggle switch faceplate. Covers one NEMA standard rectangular electrical outlet or standard rectangular communication module frame and one NEMA standard toggle switch.                                  | White  | 1              | 10             |
| MP2G106RWH   | Metal double gang 106 duplex/rectangular faceplate. Covers one NEMA standard 106 duplex outlet or standard 106 communication module frame and one NEMA standard rectangular outlet or standard rectangular communication module frame. | White  | 1              | 10             |
| MP3G106WH    | Metal three gang 106 duplex faceplate. Covers three NEMA standard 106 duplex electrical outlets or three standard 106 communication module frames.   | White  | 1              | 10             |
| MP3GRWH      | Metal three gang rectangular faceplate. Covers three NEMA standard rectangular electrical outlets or three standard rectangular communication module frames.   | White  | 1              | 10             |
| MP3TSWH      | Metal three gang toggle switch faceplate. Covers three NEMA standard toggle switches.  | White  | 1              | 10             |
| MP3G1062TSWH | Metal three gang 106 duplex/two toggle switch faceplate. Covers one NEMA standard 106 duplex electrical outlet or one standard 106 communication module frame and two NEMA standard toggle switches.                                   | White  | 1              | 10             |

‡For other colors replace WH (White) with AL (Almond).

A.  
System  
Overview

B1.  
Cable Ties

B2.  
Cable  
Accessories

B3.  
Stainless  
Steel Ties

C1.  
Wiring  
Duct

C2.  
Surface  
Raceway

C3.  
Abrasion  
Protection

C4.  
Cable  
Management

D1.  
Terminals

D2.  
Power  
Connectors

D3.  
Grounding  
Connectors

E1.  
Labeling  
Systems

E2.  
Labels

E3.  
Pre-Printed  
& Write-On  
Markers

E4.  
Permanent  
Identification

E5.  
Lockout/  
Tagout  
& Safety  
Solutions

F.  
Index

A.  
System  
Overview

B1.  
Cable Ties

B2.  
Cable  
Accessories

B3.  
Stainless  
Steel Ties

## PAN-WAY® NON-METALLIC SURFACE RACEWAY

Pan-Way® Non-Metallic Surface Raceways provide maximum flexibility for routing, protecting, concealing and terminating high performance copper, voice, video, fiber optic and power cabling. Panduit surface raceways are designed with attention to function and aesthetics to blend with any décor. Panduit surface raceway systems include transition fittings that facilitate seamless integration of one Panduit surface raceway system to another. Panduit Surface Raceway Systems work with all Panduit® Mini-Com® Modules for complete connectivity possibilities.



- Aesthetically pleasing
- Lightweight
- Tamper resistant
- Bend radius control
- Resists dents and conceals scratches and chips
- Ease of modifications and additions
- Lowest installed cost

C1.  
Wiring  
Duct

C2.  
Surface  
Raceway

C3.  
Abrasion  
Protection

C4.  
Cable  
Management

D1.  
Terminals

D2.  
Power  
Connectors

D3.  
Grounding  
Connectors

E1.  
Labeling  
Systems

Panduit surface raceway provides a variety of choices when selecting data and electrical terminations. All Panduit surface raceways include a full complement of fittings that are designed to maintain the proper bend radius control required for high performance copper and fiber optic cabling systems. All of the raceways accept either NEMA 70mm standard screw-on faceplates or superior Pan-Way® Snap-On Faceplates. Panduit surface raceway systems work with all Panduit® Mini-Com® Modules, for complete connectivity possibilities.

E2.  
Labels

E3.  
Pre-Printed  
& Write-On  
Markers

E4.  
Permanent  
Identification

E5.  
Lockout/  
Tagout  
& Safety  
Solutions

F.  
Index

## PAN-WAY® TG-70 NON-METALLIC SURFACE RACEWAY

Pan-Way® TG-70 Non-Metallic Surface Raceway is a multi-channel raceway, which provides a solution for routing copper, fiber optic, and/or power cabling when maximum cable capacity is required.



- Large raceway channel provides maximum capacity
- Fittings maintain 40mm (1.6 inch) bend radius control
- Multi-channel two-piece design
- Aesthetically pleasing
- Lightweight
- Tamper resistant



The TG-70 raceway system consists of raceway base and cover, fittings, termination hardware and accessories. Pan-Way® TG-70 Raceway can mount NEMA standard screw-on faceplates or superior Pan-Way® Snap-On Faceplates directly to the channel. Fittings for TG-70 are available to transition to Pan-Way® T-45 and LD raceway.

A.  
System  
Overview

B1.  
Cable Ties

B2.  
Cable  
Accessories

B3.  
Stainless  
Steel Ties

C1.  
Wiring  
Duct

C2.  
Surface  
Raceway

C3.  
Abrasion  
Protection

C4.  
Cable  
Management

D1.  
Terminals

D2.  
Power  
Connectors

D3.  
Grounding  
Connectors

E1.  
Labeling  
Systems

E2.  
Labels

E3.  
Pre-Printed  
& Write-On  
Markers

E4.  
Permanent  
Identification

E5.  
Lockout/  
Tagout  
& Safety  
Solutions

F.  
Index



A.  
System  
Overview

## TG-70 Raceway Roadmap

B1.  
Cable Ties

B2.  
Cable  
Accessories

B3.  
Stainless  
Steel Ties

C1.  
Wiring  
Duct

C2.  
Surface  
Raceway

C3.  
Abrasion  
Protection

C4.  
Cable  
Management

D1.  
Terminals

D2.  
Power  
Connectors

D3.  
Grounding  
Connectors

E1.  
Labeling  
Systems

E2.  
Labels

E3.  
Pre-Printed  
& Write-On  
Markers

E4.  
Permanent  
Identification

E5.  
Lockout/  
Tagout  
& Safety  
Solutions

F.  
Index

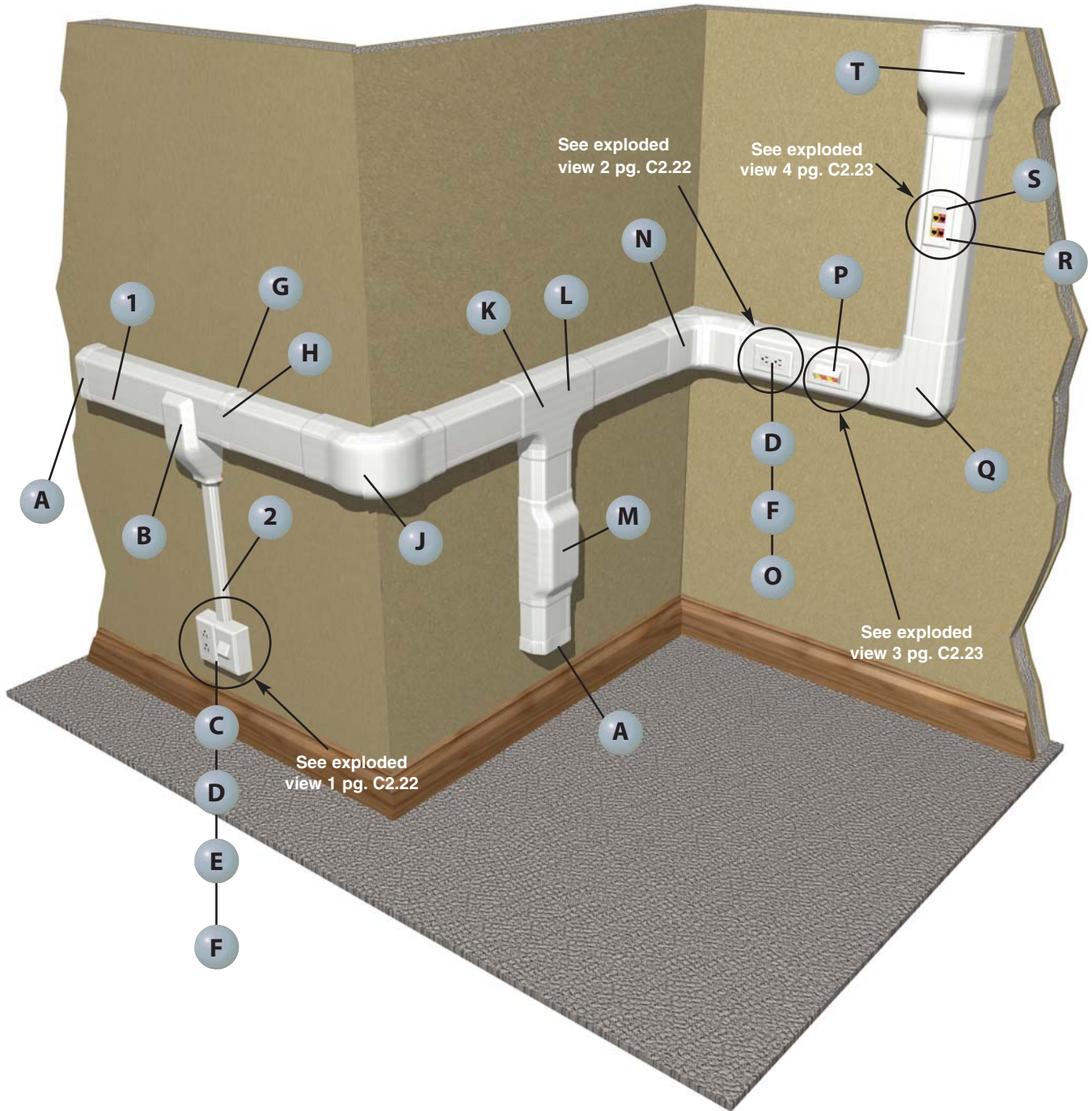

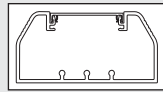

**1** TG-70\*\* – TG-70 Raceway Base and Cover (page C2.24)

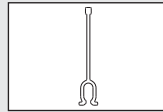

**1** TGDW – TG-70 Raceway Divider Wall (page C2.24)

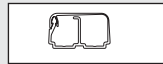

**2** LD2P10\*\* – Raceway (page C2.75)

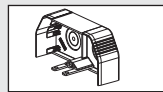

**A** TGEC\*\* – TG-70 End Cap (page C2.25)

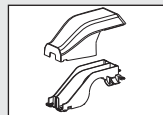

**B** TGTR\*\* – TG-70 Transition Fitting (page C2.25)

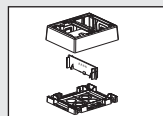

**C** JBP2FS\*\* – Fast-Snap™ Double Gang Power Rated Surface Mount Box (page C2.52)

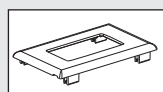

**D** T70PG\*\* – Single Gang Rectangular Electrical/Communication Snap-On Faceplate (page C2.53)

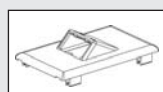

**E** T70FV2\*\* – Vertical Sloped Communication Snap-On Faceplate (page C2.52)

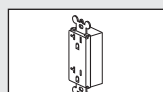

**F** ERU20\*\* – 20 A Rectangular Electrical Outlet (page C2.61)

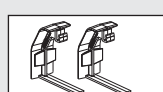

**G** TG70BC\*\* – TG-70 Base Couplers (page C2.25)

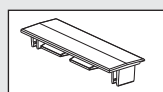

**H** T70CC\*\* – T-70 Cover Couplers (page C2.25)

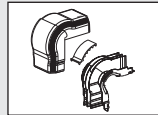

**J** TGOC\*\* – TG-70 Outside Corner Fitting (page C2.25)



**K** TGT\*\* – TG-70 Tee Fitting (page C2.25)

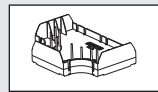

**L** TGTD – TG Tee Divider (page C2.25)

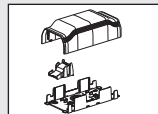

**M** TGBF\*\* – TG-70 Backfeed Fitting (page C2.25)



**N** TGIC\*\* – TG-70 Inside Corner Fitting (page C2.25)

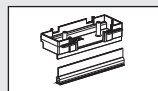

**O** TG70HB3-X – TG-70 Hanging Box with Divider Wall (page C2.26)

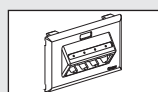

**P** UIT70FH4\*\* – Ultimate ID® Sloped Horizontal Snap-On Faceplate (see SA-NCCB51)

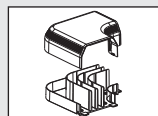

**Q** TGRA\*\* – TG-70 Right Angle Fitting (page C2.25)

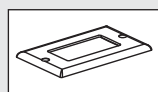

**R** CPG\*\* – Single Gang Rectangular Power and Communication Faceplate (page C2.60)

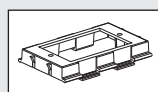

**S** T70DB-X – T-70 Device Mounting Bracket (page C2.26)



**T** TGEE\*\* – TG-70 Entrance End Fitting (page C2.25)

A. System Overview

B1. Cable Ties

B2. Cable Accessories

B3. Stainless Steel Ties

C1. Wiring Duct

C2. Surface Raceway

C3. Abrasion Protection

C4. Cable Management

D1. Terminals

D2. Power Connectors

D3. Grounding Connectors

E1. Labeling Systems

E2. Labels

E3. Pre-Printed & Write-On Markers

E4. Permanent Identification

E5. Lockout/Tagout & Safety Solutions

F. Index

A.  
System  
Overview

## TG-70 Configurations

B1.  
Cable Ties

### Exploded View 1

|    | Components Required   | See page |
|----|---|----------|
| A. | T70FV2 = Vertical sloped communication snap-on faceplate.                   | C2.52    |
| B. | Panduit® Mini-Com® Modules.   | —        |
| C. | T70PG = Single gang rectangular electrical/communication snap-on faceplate. | C2.53    |
| D. | ERU20 = 20 A rectangular electrical outlet (screws included).               | C2.61    |
| E. | JBP2FS = Fast-Snap™ Double Gang Power Rated Surface Mount Outlet Box.       | C2.52    |

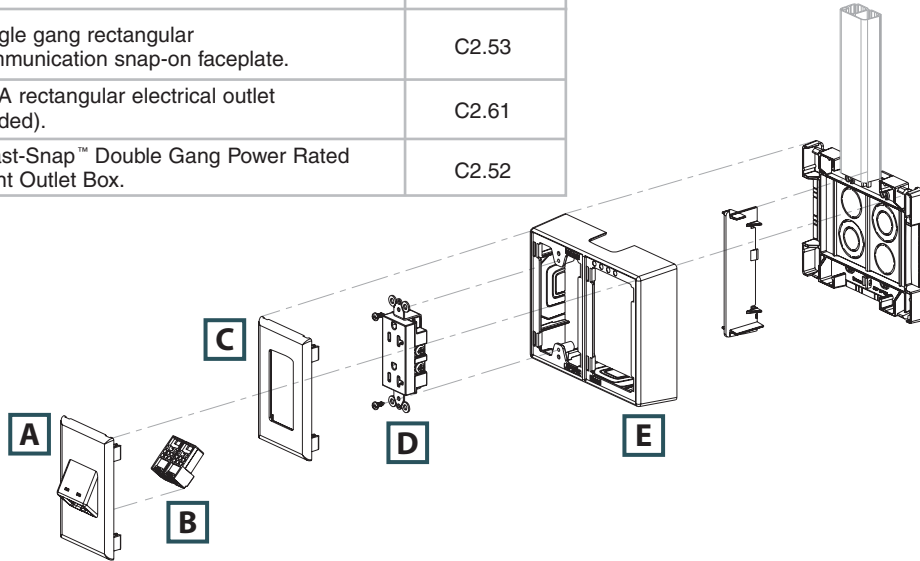

D1.  
Terminals

### Exploded View 2

|    | Components Required   | See page |
|----|---|----------|
| A. | T70PG = Single gang rectangular electrical/communication snap-on faceplate. | C2.53    |
| B. | ERU20 = 20 A rectangular electrical outlet (screws included).               | C2.61    |
| C. | TG70HB3 = TG-70 3-sided hanging box.  | C2.26    |

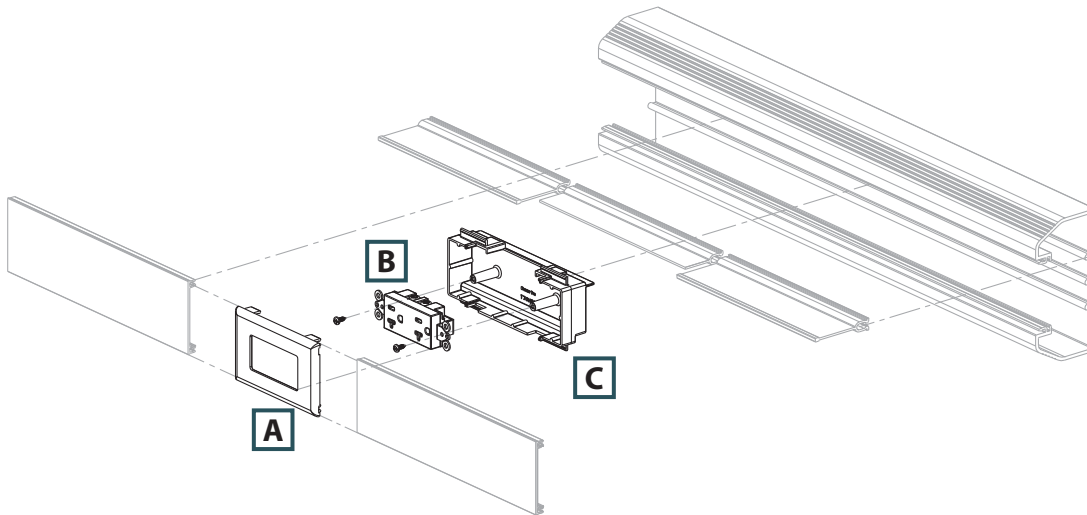

E1.  
Labeling  
Systems

E2.  
Labels

E3.  
Pre-Printed  
& Write-On  
Markers

E4.  
Permanent  
Identification

E5.  
Lockout/  
Tagout  
& Safety  
Solutions

F.  
Index



## TG-70 Configurations (continued)

### Exploded View 3

|    | Components Required   | See page |
|----|---|----------|
| A. | UIT70FH4 = Ultimate ID® Sloped Horizontal Snap-On Faceplate – 4-port. | —        |
| B. | Mini-Com® Modules.  | —        |

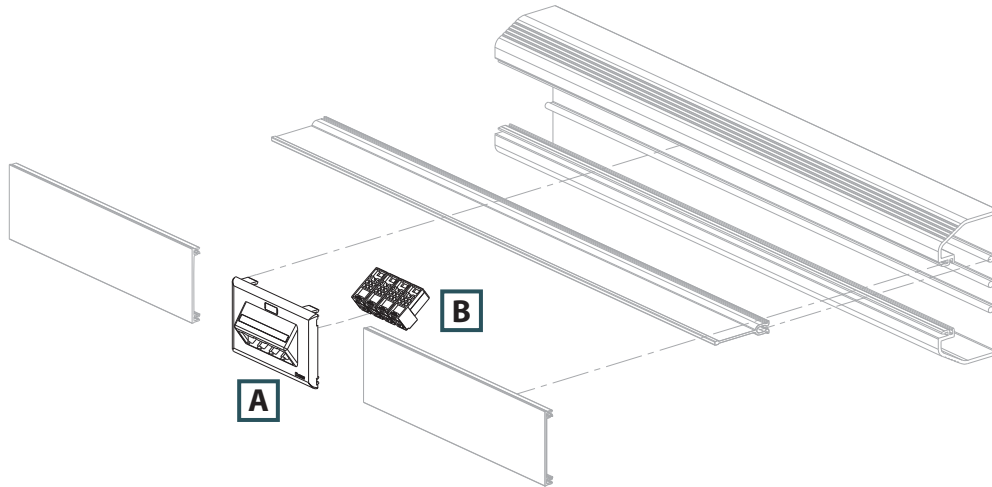

### Exploded View 4

|    | Components Required   | See page |
|----|---|----------|
| A. | CPG = Single gang rectangular screw-on faceplate (screws included). | C2.60    |
| B. | CFG4 = Mini-Com® Module Frame – 4-port.                             | —        |
| C. | Mini-Com® Modules.  | —        |
| D. | T70DB-X = T70 device bracket.                                       | C2.26    |

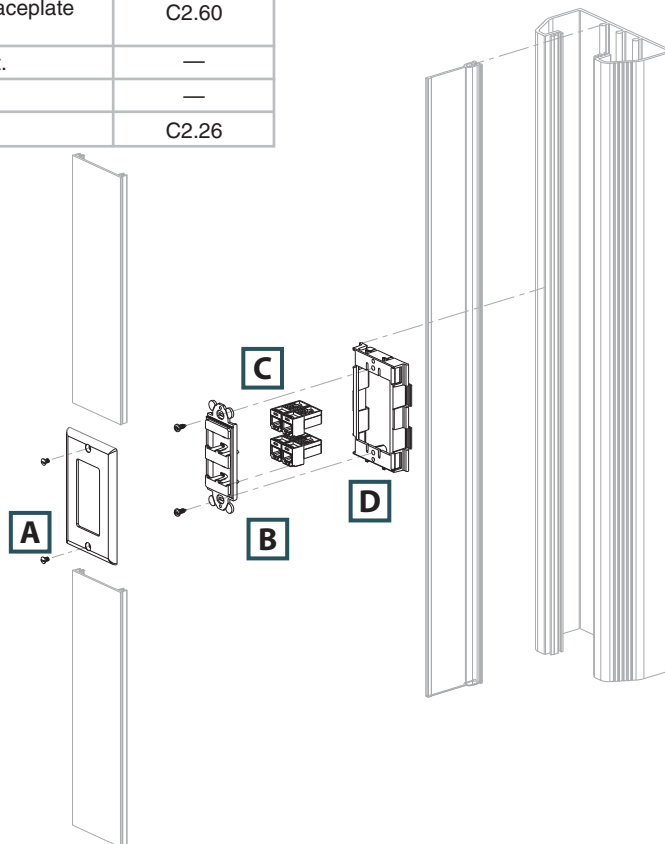

A.  
System  
Overview

B1.  
Cable Ties

B2.  
Cable  
Accessories

B3.  
Stainless  
Steel Ties

C1.  
Wiring  
Duct

C2.  
Surface  
Raceway

C3.  
Abrasion  
Protection

C4.  
Cable  
Management

D1.  
Terminals

D2.  
Power  
Connectors

D3.  
Grounding  
Connectors

E1.  
Labeling  
Systems

E2.  
Labels

E3.  
Pre-Printed  
& Write-On  
Markers

E4.  
Permanent  
Identification

E5.  
Lockout/  
Tagout/  
& Safety  
Solutions

F.  
Index

A. System Overview



## Pan-Way® TG-70 Surface Raceway System

B1. Cable Ties

- UL and CSA rated 600 V; meets UL 5A and CSA C22.2 No. 62.1-03 standards; FT4 rated
- Large cable capacity with aesthetically pleasing design
- Tamper resistant

- Compatible with NEMA standard faceplates or Pan-Way® Classic Series Snap-On Faceplates
- Transitions to Panduit T-45 and LD profile raceway
- Supplied with pre-punched mounting holes

B2. Cable Accessories

B3. Stainless Steel Ties

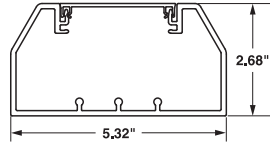

TG-70  
Internal Area = 10.85 Sq. In.

C1. Wiring Duct



TG70

| Part Number   | Part Description  | Raceway Size                        | Color‡    | Length (Ft.) | Std. Ctn. Qty. |
|---|---|-------------------------------------|-----------|--------------|----------------|
| <b>TG-70 Raceway Base and Cover — PACKAGED TOGETHER</b> |   |                                     |           |              |                |
| <b>TG70IW8</b>  | TG-70 raceway base in 8' and 10' lengths. Supplied with pre-punched mounting holes. | 5.32" x 2.68"<br>(135.0mm x 68.0mm) | Off White | 8            | 32             |
| <b>TG70IW10</b>   |   |                                     |           | 10           | 40             |

C2. Surface Raceway

C3. Abrasion Protection



T70C

| <b>T-70/TG-70/Twin-70 Raceway Cover</b> |  |   |           |    |     |
|---|--|---|-----------|----|-----|
| <b>T70CIW8</b>                          | T-70, TG-70, or Twin-70 raceway cover in 8' and 10' lengths. | — | Off White | 8  | 96  |
| <b>T70CIW10</b>                         |  |   |           | 10 | 120 |

C4. Cable Management

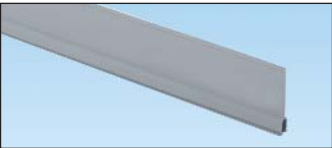

TGDW

| <b>TG Raceway Divider Wall</b> |   |   |      |    |    |
|--------------------------------|---|---|------|----|----|
| <b>TGDW8</b>                   | TG raceway divider wall. Snaps onto rails in TG raceway base to create separate channels. Must use wire retainers to ensure channel separation per UL/CSA. Available in 8' and 10' lengths. | — | Gray | 8  | 64 |
| <b>TGDW10</b>                  |   |   |      | 10 | 80 |

‡For other colors replace IW (Off White) with EI (Electric Ivory).  
Order number of feet required in multiples of standard carton quantity.

D1. Terminals

D2. Power Connectors

D3. Grounding Connectors

E1. Labeling Systems

E2. Labels

E3. Pre-Printed & Write-On Markers

E4. Permanent Identification

E5. Lockout/Tagout & Safety Solutions

F. Index



## Pan-Way® TG-70 Raceway Fittings

- TG-70 fittings are designed to exceed the TIA/EIA-568-B and 569-B required minimum bend radius for high performance copper and fiber optic cabling systems



T70CC



TG70BC

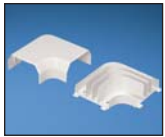

TGRA



TGIC



TGSIC



TGOC



TGSOC



TGT



TGTD



TGEC



TGEE



TGTR



TGBF



TGBFI

| Part Number       | Part Description   | Color‡    | Std. Pkg. Qty. | Std. Ctn. Qty. |
|-------------------|--|-----------|----------------|----------------|
| <b>T70CWIW-X</b>  | T-70 cover coupler fitting: Joins cover sections of T-70, Twin-70, and TG-70. raceway cover together.  | Off White | 10             | 100            |
| <b>TG70BCIW-X</b> | Base coupler fitting. Each piece includes two base coupler halves for joining sections of TG-70 base together.   | Off White | 10             | —              |
| <b>TGRAIW</b>     | Right angle fitting. Used to join sections of TG raceway at 90° flat junctions.  | Off White | 1              | 10             |
| <b>TGICIW</b>     | Inside corner fitting. Used to join sections of TG raceway at inside corners. Fittings adjust from 85° to 135° to adapt to non-square corners.                                       | Off White | 1              | —              |
| <b>TGSICIW</b>    | Inside corner fitting – non-adjustable. Used to join sections of TG raceway at inside corners.   | Off White | 1              | 10             |
| <b>TGOCIW</b>     | Outside corner fitting. Used to join sections of TG raceway at outside corners. Fittings adjust from 85° to 135° to adapt to non-square corners.                                     | Off White | 1              | —              |
| <b>TGSOCIW</b>    | Outside corner fitting – non-adjustable. Used to join sections of TG raceway at inside corners.  | Off White | 1              | 10             |
| <b>TGTIW</b>      | Tee fitting. Used to join sections of TG raceway at tee intersections.   | Off White | 1              | 5              |
| <b>TGTD</b>       | Tee divider insert. Mounts inside TGT tee fitting to maintain channel separation in TG raceway at tee intersections.   | Gray      | 1              | 5              |
| <b>TGECIW</b>     | End cap. Used to terminate or allow entry to TG raceway. Two knockouts each for .50"(12.7mm) and 1"(25.4mm) conduit.   | Off White | 1              | 10             |
| <b>TGEEIW</b>     | Entrance end fitting. Accepts large conduit, (up to 2") in line or at a right angle. Maintains a 40mm bend radius with a removable insert and channel separation.                    | Off White | 1              | 10             |
| <b>TGTRIW</b>     | Transition fitting from TG to T-45. Provides a tee transition from TG raceway to T-45 and LD series size 5 and 10. Use with RF5X3 reducer fitting to transition to LD series size 3. | Off White | 1              | 10             |
| <b>TGBFIW</b>     | Backfeed fitting. Features breakouts to enter through the bottom of the fitting and maintains bend radius control with a removable, bend radius insert and channel separation.       | Off White | 1              | 10             |
| <b>TGBFI</b>      | Backfeed fitting insert. Removable and maintains bend radius control.  | Gray      | 1              | 10             |

‡For other colors replace IW (Off White) with EI (Electric Ivory).

A.  
System  
Overview

B1.  
Cable Ties

B2.  
Cable  
Accessories

B3.  
Stainless  
Steel Ties

C1.  
Wiring  
Duct

C2.  
Surface  
Raceway

C3.  
Abrasion  
Protection

C4.  
Cable  
Management

D1.  
Terminals

D2.  
Power  
Connectors

D3.  
Grounding  
Connectors

E1.  
Labeling  
Systems

E2.  
Labels

E3.  
Pre-Printed  
& Write-On  
Markers

E4.  
Permanent  
Identification

E5.  
Lockout/  
Tagout  
& Safety  
Solutions

F.  
Index

A. System Overview



## Pan-Way® TG-70 Raceway Accessories

B1. Cable Ties

- TG-70 accessories consist of device mounting brackets, standard faceplate brackets for data, wire retainers and fiber spool brackets; the three-sided hanging box is used to mount NEMA standard single gang outlet and communications devices

B2. Cable Accessories

B3. Stainless Steel Ties

C1. Wiring Duct

C2. Surface Raceway

C3. Abrasion Protection

C4. Cable Management

D1. Terminals

D2. Power Connectors

D3. Grounding Connectors

E1. Labeling Systems

E2. Labels

E3. Pre-Printed & Write-On Markers

E4. Permanent Identification

E5. Lockout/Tagout & Safety Solutions

F. Index



**T70DB-X**



**T70SDB-X**

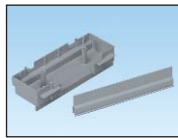

**TG70HB3-X**



**TG70HB3GFCI-X**

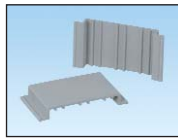

**TG70WR-X**

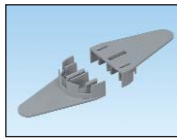

**TGFSB**

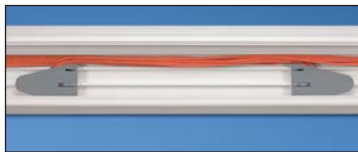

**TGFSB installed in TG-70 raceway**

| Part Number          | Part Description  | Color | Std. Pkg. Qty. | Std. Ctn. Qty. |
|----------------------|---|-------|----------------|----------------|
| <b>T70DB-X</b>       | Device mounting bracket. Used to mount NEMA standard single gang electrical outlets and communication devices with either screw-on or snap-on single gang faceplates. Can be used with T-70, Twin-70, and TG-70 raceway.  | Gray  | 10             | —              |
| <b>T70SDB-X</b>      | Standard faceplate bracket. Used to mount NEMA standard 70mm single gang screw-on faceplates. Can be used with T-70, Twin-70, TG-70 raceway and Pan-Pole™ Communication Pole.   | Gray  | 10             | —              |
| <b>TG70HB3-X</b>     | 3-sided hanging box. Mounts standard electrical outlets or communication devices with either NEMA standard single gang screw-on or Panduit snap-on faceplates. When used with TGDW divider wall, box separates and fully encloses device to provide cabling separation.                                 | Gray  | 10             | —              |
| <b>TG70HB3GFCI-X</b> | GFCI 3-sided hanging box. Accepts single gang U.S. GFCI (ground fault circuit interrupter) standard electrical devices. Provides increased internal area for connections and excess wire.   | Gray  | 10             | —              |
| <b>TG70WR-X</b>      | Wire retainer. Holds wires in place during installation.  | Gray  | 10             | 100            |
| <b>TGFSB</b>         | Fiber spool bracket. Each piece consists of two halves that snap into base of TG raceway. Provides method to contain one meter or more of fiber slack and acts as a strain relief while maintaining a minimum 32mm bend radius. Bracket separation can be adjusted to fit the length of slack required. | Gray  | 1              | 10             |

## Cable Fill Capacities for TG-70 Raceway

This information is to be used as a guide in selecting the proper size raceway. The maximum amounts may vary according to the cable installation methods, straightness of cables, etc.

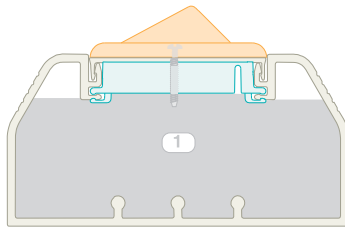

**A = 10.09 in.<sup>2</sup>**

**Cable fill #1:** With data only using screw-on faceplates and devices.

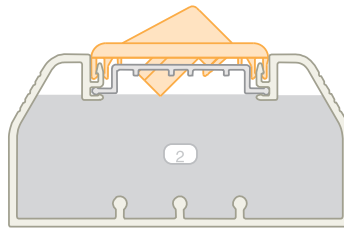

**A = 10.68 in.<sup>2</sup>**

**Cable fill #2:** With data only using snap-on faceplates and wire retainer.

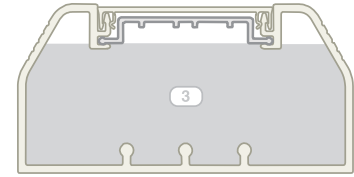

**A = 10.85 in.<sup>2</sup>**

**Cable fill #3:** With wire retainer.

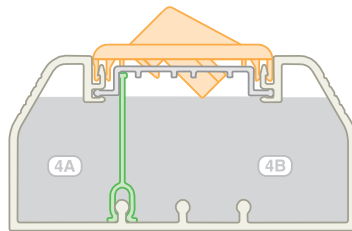

**A = 3.16 in.<sup>2</sup>**

**A = 7.20 in.<sup>2</sup>**

**Cable fill #4:** Divided (see 5A and 5B for power and data applications).

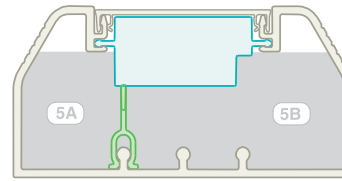

**A = 3.08 in.<sup>2</sup>**

**A = 5.58 in.<sup>2</sup>**

**Cable fill #5:** With Power and data using snap-on faceplates and 3-sided power box.

| Raceway Type and Configuration   | Fill Area (In. <sup>2</sup> ) | Electrical Cables |        |        | Data Grade Cables |               | Data Grade Cables |       | Audio/Video  |       | Fiber Optic Cable |       |
|--|-------------------------------|-------------------|--------|--------|-------------------|---------------|-------------------|-------|--------------|-------|-------------------|-------|
|  |                               | 14 AWG            | 12 AWG | 10 AWG | 24 AWG/UTP CM     | 24 AWG/UTP CM | RG6               |       | 2 Strand     |       |                   |       |
|  |                               | THHN/T90          |        |        | Cat. 6            |               | Cat. 6A           |       | DIA. = 0.275 |       | DIA. = 0.175      |       |
|  |                               | 0.111             | 0.130  | 0.164  | DIA. = 0.250      |               | DIA. = 0.330      |       | DIA. = 0.275 |       | DIA. = 0.175      |       |
|  |                               | FILL              |        |        | FILL              |               | FILL              |       | FILL         |       | FILL              |       |
| MAX  | MAX                           | MAX               | SPEC   | MAX    | SPEC              | MAX           | SPEC              | MAX   | SPEC         | MAX   | MAX               |       |
| (UL Temp Rise Test)  |                               |                   | (40%)  | (60%)  | (40%)             | (60%)         | (40%)             | (60%) | (40%)        | (60%) | (40%)             | (60%) |
| 1. TG70: Data only using screw-on faceplates and devices.                    | 10.09                         | —                 | —      | —      | 82                | 123           | 47                | 70    | 67           | 101   | 167               | 251   |
| 2. TG70: Data only using snap-on faceplates and wire retainer.               | 10.68                         | —                 | —      | —      | 87                | 130           | 49                | 74    | 71           | 107   | 177               | 266   |
| 3. TG70: Wire retainer without devices.                                      | 10.85                         | 40                | 40     | 38     | 88                | 132           | 50                | 76    | 73           | 109   | 180               | 270   |
| 4A. TG70: Divided power and data (A).  | 3.16                          | 28                | 28     | 26     | —                 | —             | —                 | —     | —            | —     | —                 | —     |
| 4B. TG70: Divided power and data (B).  | 7.20                          | —                 | —      | —      | 58                | 88            | 33                | 50    | 48           | 72    | 119               | 179   |
| 5A. TG70: Power and data using snap-on faceplates and 3-sided power box (A). | 3.08                          | 28                | 28     | 26     | —                 | —             | —                 | —     | —            | —     | —                 | —     |
| 5B. TG70: Power and data using snap-on faceplates and 3-sided power box (B). | 5.58                          | —                 | —      | —      | 45                | 68            | 26                | 39    | 37           | 56    | 92                | 139   |

AWG dimensions represent typical outer cable diameter in inches.

A.  
System  
Overview

B1.  
Cable Ties

B2.  
Cable  
Accessories

B3.  
Stainless  
Steel Ties

C1.  
Wiring  
Duct

C2.  
Surface  
Raceway

C3.  
Abrasion  
Protection

C4.  
Cable  
Management

D1.  
Terminals

D2.  
Power  
Connectors

D3.  
Grounding  
Connectors

E1.  
Labeling  
Systems

E2.  
Labels

E3.  
Pre-Printed  
& Write-On  
Markers

E4.  
Permanent  
Identification

E5.  
Lockout/  
Tagout  
& Safety  
Solutions

F.  
Index

# NOTES



## PAN-WAY® T-70 AND TWIN-70 NON-METALLIC SURFACE RACEWAY

Pan-Way® T-70 and Twin-70 Non-Metallic Surface Raceways are multi-channel raceways which provide solutions for routing copper, fiber optic, and/or power cabling along fixed perimeter walls. T-70 features the Workstation Outlet Center™ Offset Box which provides an offset solution to maximize channel capacity and outlet density. Twin-70 offers two totally independent channels maintained throughout the system for independent access to power, copper, and fiber optic cabling.

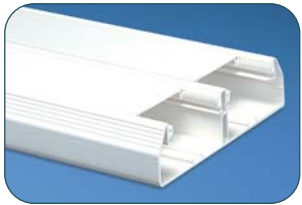

- Aesthetically pleasing
- Lightweight
- Tamper resistant
- Fittings maintain 1 inch bend radius control
- T-70 utilizes a single channel with snap-in divider wall to provide multi-channel capability
- Twin-70 utilizes two independent channels and covers to provide multi-channel capability

The T-70 and Twin-70 raceway systems consist of raceway base and cover, fittings, termination hardware and accessories. Pan-Way® T-70 and Twin-70 Raceway can mount NEMA standard screw-on faceplates or superior Pan-Way® Snap-On Faceplates directly to the channel. Fittings for T-70 and Twin-70 are available to transition to T-70, Twin-70, T-45 and LD raceways.

A.  
System  
Overview

B1.  
Cable Ties

B2.  
Cable  
Accessories

B3.  
Stainless  
Steel Ties

C1.  
Wiring  
Duct

C2.  
Surface  
Raceway

C3.  
Abrasion  
Protection

C4.  
Cable  
Management

D1.  
Terminals

D2.  
Power  
Connectors

D3.  
Grounding  
Connectors

E1.  
Labeling  
Systems

E2.  
Labels

E3.  
Pre-Printed  
& Write-On  
Markers

E4.  
Permanent  
Identification

E5.  
Lockout/  
Tagout  
& Safety  
Solutions

F.  
Index

A.  
System  
Overview

## T-70 Raceway Roadmap

B1.  
Cable Ties

B2.  
Cable  
Accessories

B3.  
Stainless  
Steel Ties

C1.  
Wiring  
Duct

C2.  
Surface  
Raceway

C3.  
Abrasion  
Protection

C4.  
Cable  
Management

D1.  
Terminals

D2.  
Power  
Connectors

D3.  
Grounding  
Connectors

E1.  
Labeling  
Systems

E2.  
Labels

E3.  
Pre-Printed  
& Write-On  
Markers

E4.  
Permanent  
Identification

E5.  
Lockout/  
Tagout  
& Safety  
Solutions

F.  
Index

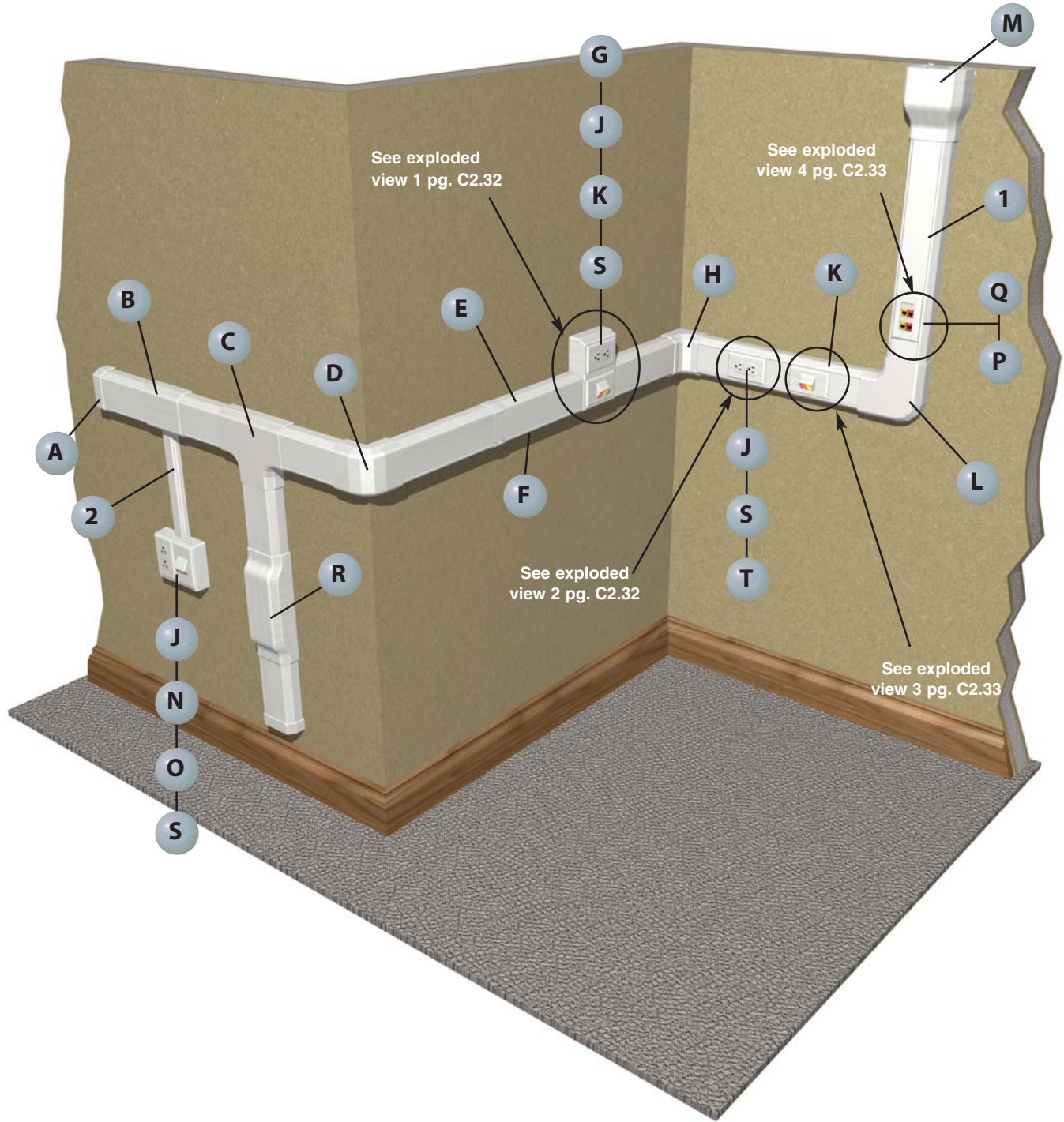

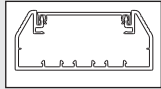

**1** T70B\*\*, T70C\*\* – T-70 Base and Cover (page C2.36)

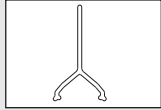

**1** T70DW – T-70 Divider Wall (page C2.36)

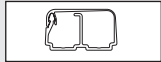

**2** LD2P10\*\* – LD2P10 Raceway (page C2.75)

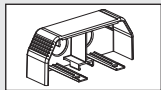

**A** T70EC\*\* – T-70 End Cap Fitting (page C2.37)

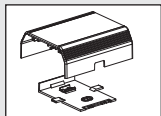

**B** T70TR\*\* – T-70 Transition Fitting (page C2.37)



**C** T70T\*\* – T-70 Tee Fitting  
T70TD – T-70 Tee Divider (page C2.37)

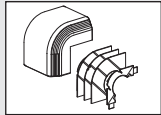
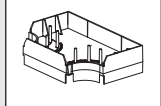

**D** T70OC\*\* – T-70 Outside Corner Fitting (page C2.37)

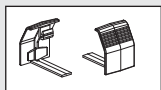

**E** T70BC\*\* – T-70 Base Coupler Fitting (page C2.36)

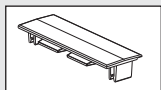

**F** T70CC\*\* – T-70 Cover Coupler Fitting (page C2.36)

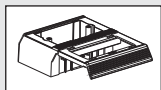

**G** T70WC2\*\* – T-70 Workstation Outlet Center™ Offset Box for Snap-On Faceplates (page C2.37)

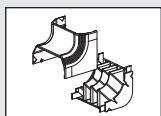

**H** T70IC\*\* – T-70 Inside Corner Fitting (page C2.36)

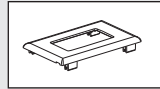

**J** T70PG\*\* – Single Gang Rectangular Electrical/Communication Snap-On Faceplate (page C2.53)

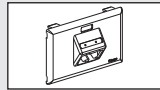

**K** UIT70FH2\*\* – Ultimate ID® Sloped Horizontal Snap-On Faceplate (see SA-NCCB51)

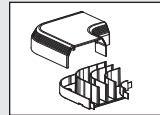

**L** T70RA\*\* – T-70 Right Angle Fitting (page C2.36)



**M** T70EE\*\* – T-70 Entrance End Fitting (page C2.37)

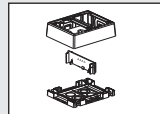

**N** JBP2FS\*\* – Fast-Snap™ Double Gang Power Rated Surface Mount Outlet Box (page C2.52)



**O** T70FV2\*\* – Vertical Sloped Communication Snap-On Faceplate (page C2.52)

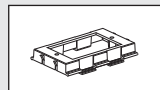

**P** T70DB-X – T-70 Device Bracket (page C2.40)

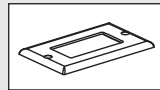

**Q** CPG\*\* – Single Gang Rectangular Screw-On Faceplate (page C2.60)

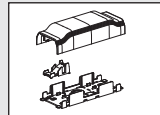

**R** T70BF\*\* – T-70 Backfeed Fitting (page C2.37)

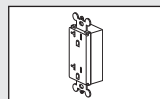

**S** ERU20\*\* – 20 A Rectangular Electrical Outlet (page C2.61)

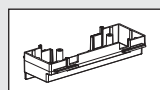

**T** T70HB3-X – 3-Sided Hanging Box (page C2.40)

A. System Overview

B1. Cable Ties

B2. Cable Accessories

B3. Stainless Steel Ties

C1. Wiring Duct

C2. Surface Raceway

C3. Abrasion Protection

C4. Cable Management

D1. Terminals

D2. Power Connectors

D3. Grounding Connectors

E1. Labeling Systems

E2. Labels

E3. Pre-Printed & Write-On Markers

E4. Permanent Identification

E5. Lockout/Tagout & Safety Solutions

F. Index

A.  
System  
Overview

## T-70 Configurations

B1.  
Cable Ties

### Exploded View 1

B2.  
Cable  
Accessories

B3.  
Stainless  
Steel Ties

C1.  
Wiring  
Duct

C2.  
Surface  
Raceway

C3.  
Abrasion  
Protection

C4.  
Cable  
Management

D1.  
Terminals

D2.  
Power  
Connectors

D3.  
Grounding  
Connectors

E1.  
Labeling  
Systems

E2.  
Labels

E3.  
Pre-Printed  
& Write-On  
Markers

E4.  
Permanent  
Identification

E5.  
Lockout/  
Tagout  
& Safety  
Solutions

F.  
Index

|    | Components Required   | See page |
|----|---|----------|
| A. | T70WC2 = T-70 Workstation Outlet Center™ Offset Box for snap-on faceplates. | C2.37    |
| B. | ERU20 = 20 A rectangular electrical outlet (screws included).               | C2.61    |
| C. | Mini-Com® Modules.  | —        |
| D. | T70PG = Single gang rectangular electrical/communication snap-on faceplate. | C2.53    |
| E. | UIT70FH2 = Ultimate ID® Sloped Horizontal Snap-On Faceplate – 2-port.       | —        |

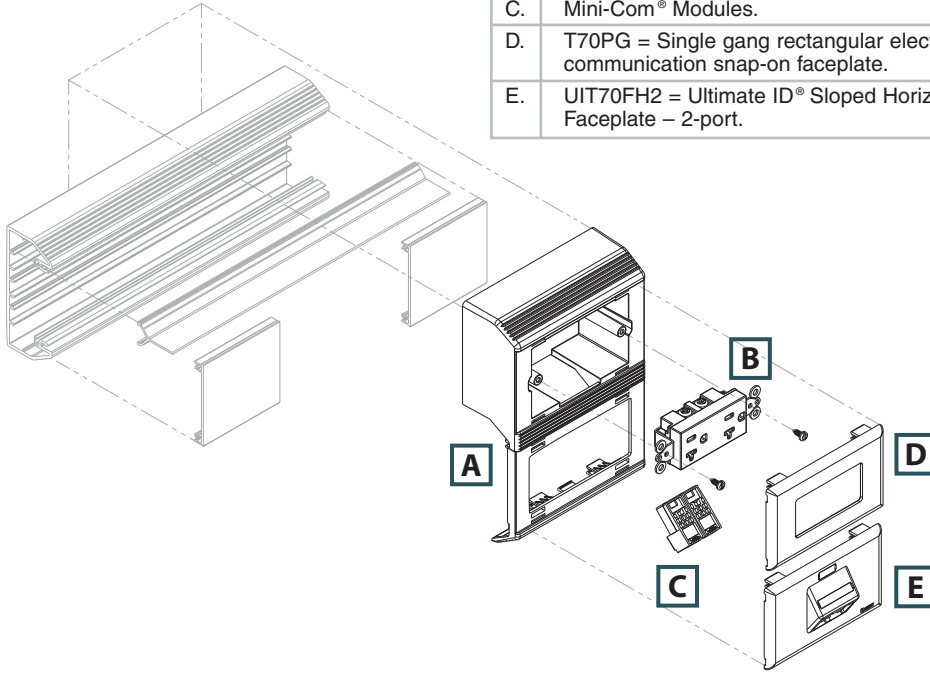

### Exploded View 2

|    | Components Required   | See page |
|----|---|----------|
| A. | T70PG = Single gang rectangular electrical/communication snap-on faceplate. | C2.53    |
| B. | ERU20 = 20 A rectangular electrical outlet (screws included).               | C2.61    |
| C. | T70HB3-X = 3-Sided hanging box.   | C2.40    |

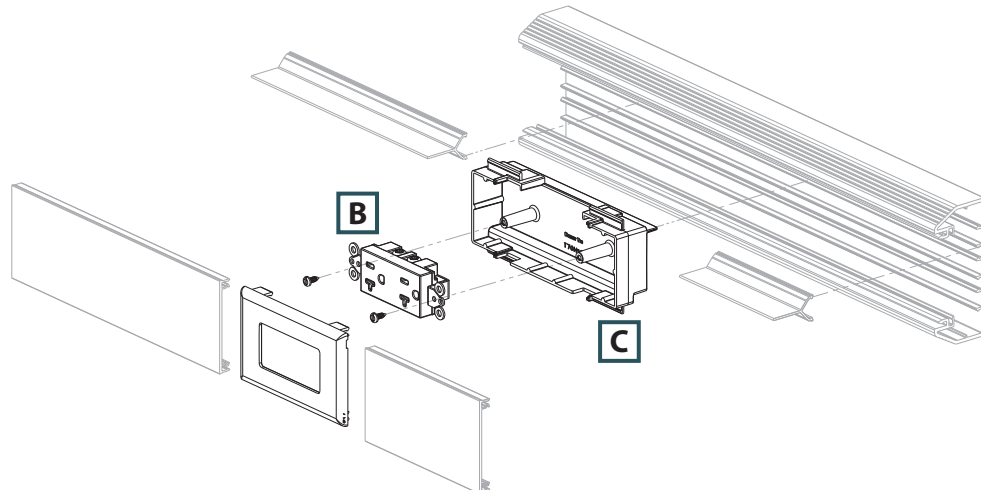



## T-70 Configurations (continued)

### Exploded View 3

|    | Components Required   | See page |
|----|---|----------|
| A. | UIT70FH2 = Ultimate ID® Sloped Horizontal Snap-On Faceplate – 2-port. | —        |
| B. | Mini-Com® Modules.  | —        |

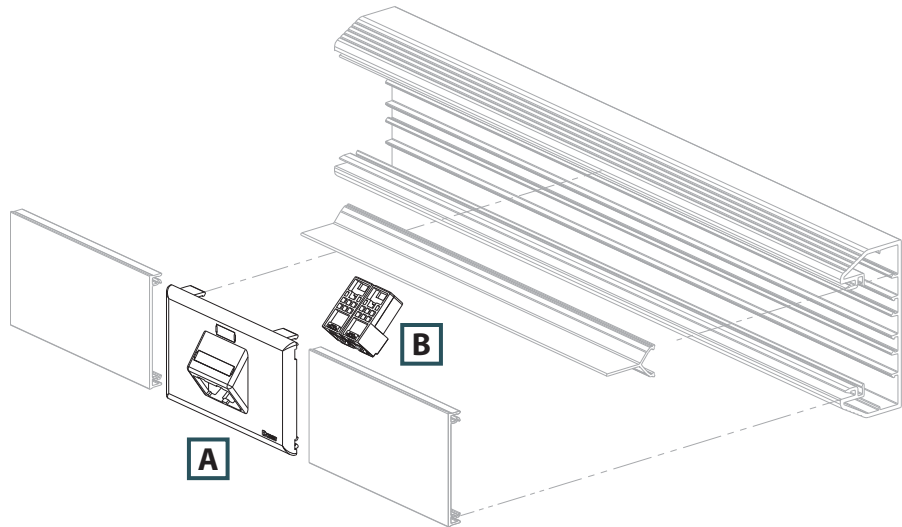

### Exploded View 4

|    | Components Required  | See page |
|----|--|----------|
| A. | CPG = Single gang rectangular screw-on faceplates (screws included). | C2.60    |
| B. | CFP4 = Mini-Com® Module Frame – 4-port.                              | —        |
| C. | Mini-Com® Modules.   | —        |
| D. | T70DB-X = T-70 device bracket.                                       | C2.40    |

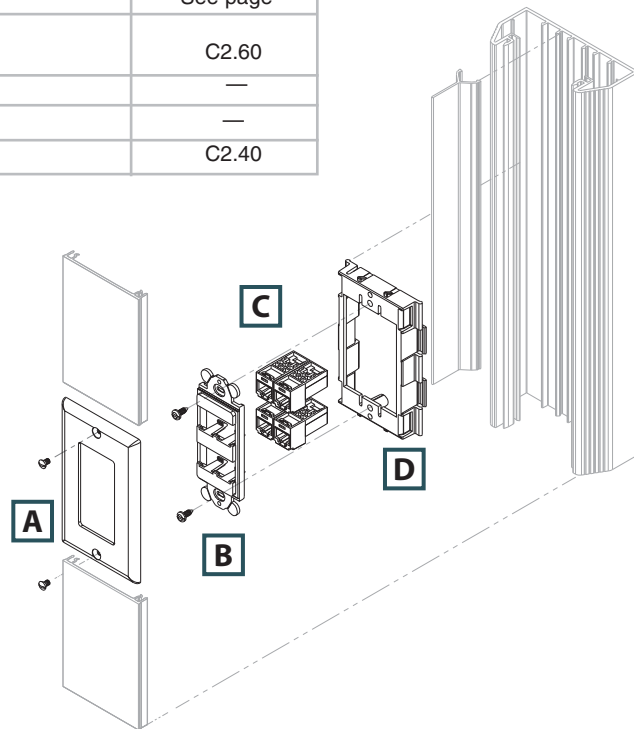

A.  
System  
Overview

B1.  
Cable Ties

B2.  
Cable  
Accessories

B3.  
Stainless  
Steel Ties

C1.  
Wiring  
Duct

C2.  
Surface  
Raceway

C3.  
Abrasion  
Protection

C4.  
Cable  
Management

D1.  
Terminals

D2.  
Power  
Connectors

D3.  
Grounding  
Connectors

E1.  
Labeling  
Systems

E2.  
Labels

E3.  
Pre-Printed  
& Write-On  
Markers

E4.  
Permanent  
Identification

E5.  
Lockout/  
Tagout  
& Safety  
Solutions

F.  
Index

A.  
System  
Overview

## Twin-70 Raceway Roadmap

B1.  
Cable Ties

B2.  
Cable  
Accessories

B3.  
Stainless  
Steel Ties

C1.  
Wiring  
Duct

C2.  
Surface  
Raceway

C3.  
Abrasion  
Protection

C4.  
Cable  
Management

D1.  
Terminals

D2.  
Power  
Connectors

D3.  
Grounding  
Connectors

E1.  
Labeling  
Systems

E2.  
Labels

E3.  
Pre-Printed  
& Write-On  
Markers

E4.  
Permanent  
Identification

E5.  
Lockout/  
Tagout  
& Safety  
Solutions

F.  
Index

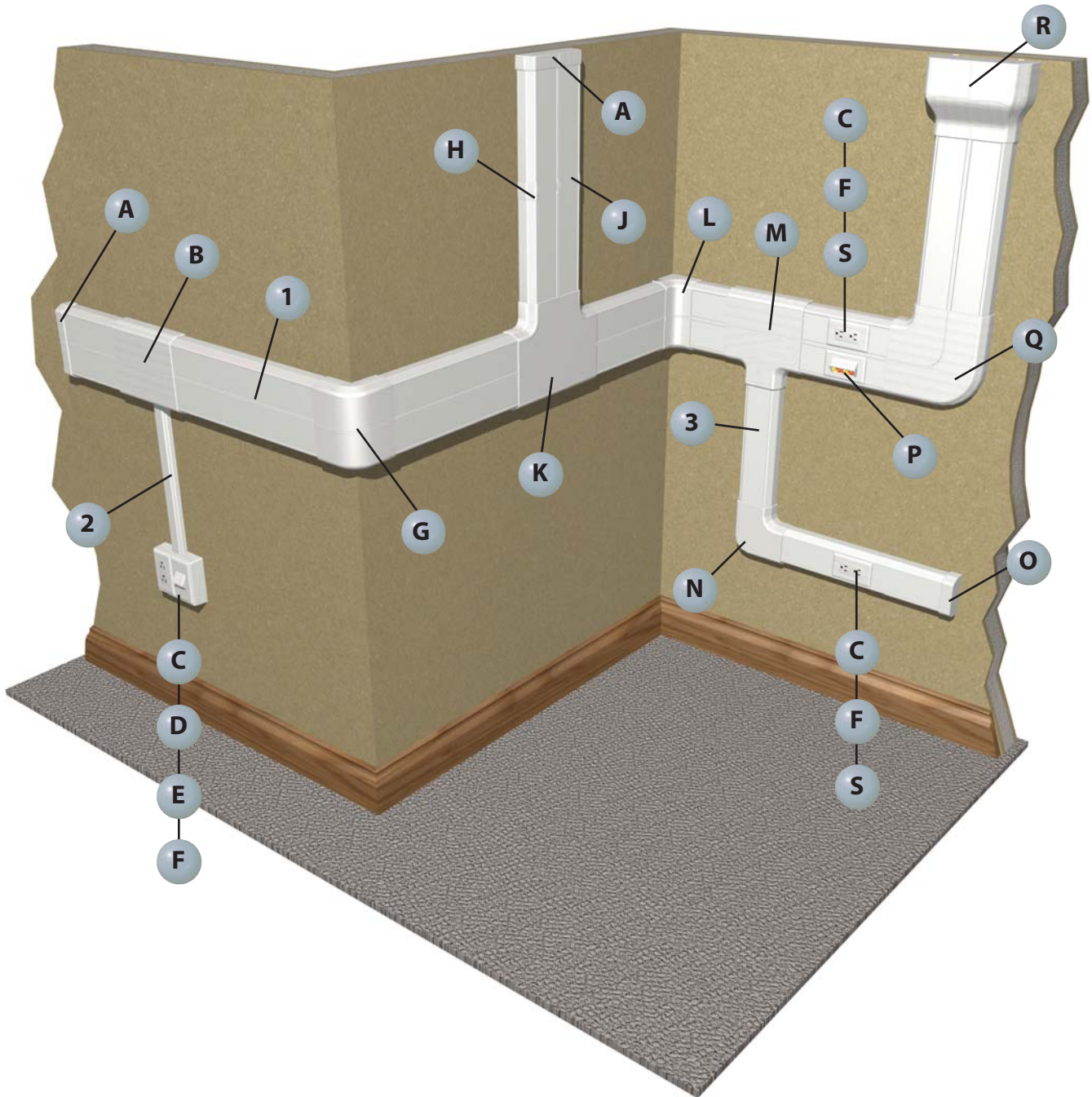





**1** T702B\*\*, T70C\*\* – Twin-70 Raceway Base and Cover (page C2.38)



**2** T45B\*\*, T45C\*\* – T-45 Raceway Base and Cover (page C2.48)



**3** T70B\*\*, T70C\*\* – T-70 Raceway Base and Cover (page C2.36)



**A** T702EC\*\* – Twin-70 End Cap Fitting (page C2.39)



**B** T702TRL\*\* – Twin-70 Transition Fitting (page C2.39)



**C** T70PG\*\* – Single Gang Rectangular Electrical/Communication Snap-On Faceplate (page C2.53)

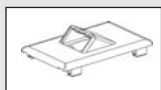

**D** T70FV2\*\* – Vertical Sloped Communication Snap-On Faceplate (page C2.52)



**E** JBP2FS\*\* – Fast-Snap™ Double Gang Power Rated Surface Mount Outlet Box (page C2.52)



**F** ERU20\*\* – 20 A Rectangular Electrical Outlet (page C2.61)



**G** T702OC\*\* – Twin-70 Outside Corner Fitting (page C2.39)



**H** T702BC\*\* – Twin-70 Base Coupler Fitting (page C2.39)

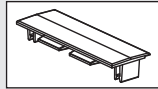

**J** T70CC\*\* – T-70 Cover Coupler Fitting (page C2.39)



**K** T702T\*\* – Twin-70 Tee Fitting (page C2.39)



**L** T702IC\*\* – Twin-70 Inside Corner Fitting (page C2.39)



**M** T702TR\*\* – Twin-70 Transition Fitting (page C2.39)



**N** T702RA\*\* – Twin-70 Right Angle Fitting (page C2.39)

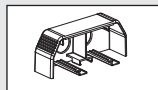

**O** T70EC\*\* – T-70 End Cap Fitting (page C2.37)



**P** UIT70FH4\*\* – Ultimate ID® Sloped Horizontal Snap-On Faceplate (see SA-NCCB51)



**Q** T702RA\*\* – Twin-70 Right Angle Fitting (page C2.39)



**R** T702EE\*\* – Twin-70 Entrance End Fitting (page C2.39)



**S** T70DB-X\*\* – T-70 Device Mounting Bracket (page C2.40)

A. System Overview

B1. Cable Ties

B2. Cable Accessories

B3. Stainless Steel Ties

C1. Wiring Duct

C2. Surface Raceway

C3. Abrasion Protection

C4. Cable Management

D1. Terminals

D2. Power Connectors

D3. Grounding Connectors

E1. Labeling Systems

E2. Labels

E3. Pre-Printed & Write-On Markers

E4. Permanent Identification

E5. Lockout/Tagout & Safety Solutions

F. Index

A. System Overview

## UL<sup>®</sup> SA LISTED SF<sup>®</sup> Pan-Way® T-70 Surface Raceway System

B1. Cable Ties

- UL and CSA rated 600 V; meets UL 5A and CSA C22.2 No. 62.1-03 standards; FT4 rated
- Large cable capacity with aesthetically pleasing design
- Tamper resistant

- Compatible with NEMA standard 70mm faceplates or Pan-Way® Classic Series Snap-On Faceplates
- Transitions to Panduit T-45 and LD profile raceway
- Supplied with pre-punched mounting holes

B2. Cable Accessories

B3. Stainless Steel Ties

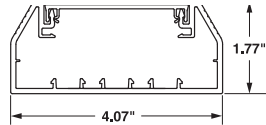

T-70  
Internal Area = 5.15 Sq. In.

C1. Wiring Duct



T70B

C2. Surface Raceway

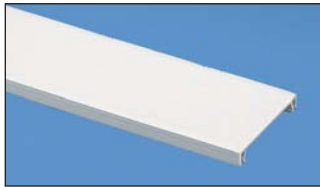

T70C

C3. Abrasion Protection

C4. Cable Management

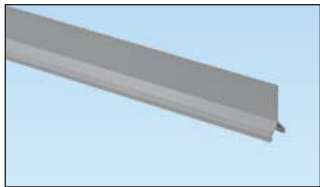

T70DW

| Part Number | Part Description | Raceway Size | Color‡ | Length (Ft.) | Std. Ctn. Qty. |
|-------------|------------------|--------------|--------|--------------|----------------|
|-------------|------------------|--------------|--------|--------------|----------------|

### T-70 Raceway Base

|                 |  |                                     |           |    |    |
|-----------------|--|-------------------------------------|-----------|----|----|
| <b>T70BIW8</b>  | T-70 raceway base in 8' and 10' lengths. Supplied with pre-punched mounting holes. | 4.07" x 1.77"<br>(103.3mm x 45.0mm) | Off White | 8  | 48 |
| <b>T70BIW10</b> |  |                                     |           | 10 | 60 |

### T-70/TG-70/Twin-70 Raceway Cover

|                 |  |   |           |    |     |
|-----------------|--|---|-----------|----|-----|
| <b>T70CIW8</b>  | T-70, TG-70, or Twin-70 raceway cover in 8' and 10' lengths. | — | Off White | 8  | 96  |
| <b>T70CIW10</b> |  |   |           | 10 | 120 |

### T-70/Twin-70 Raceway Divider Wall

|                |   |   |      |    |     |
|----------------|---|---|------|----|-----|
| <b>T70DW8</b>  | T-70/Twin-70 raceway divider wall. Snaps onto rails in T-70/Twin-70 raceway base to create separate channels. Must use wire retainers to ensure channel separation per UL/CSA. Available in 8' and 10' lengths. | — | Gray | 8  | 96  |
| <b>T70DW10</b> |   |   |      | 10 | 120 |

‡For other colors replace IW (Off White) with EI (Electric Ivory), WH (White), BL (Black) or IG (International Gray in 8' lengths ONLY).

Order raceway base and cover separately.

Order number of feet required in multiples of standard carton quantity.

D1. Terminals

D2. Power Connectors

D3. Grounding Connectors

## UL<sup>®</sup> SA LISTED SF<sup>®</sup> Pan-Way® T-70 Raceway Fittings

E1. Labeling Systems

- T-70 fittings are designed to maintain the TIA/EIA-568-B and 569-B required minimum bend radius for high performance copper and fiber optic cabling systems

E2. Labels



T70CC

T70BC

E3. Pre-Printed & Write-On Markers

E4. Permanent Identification

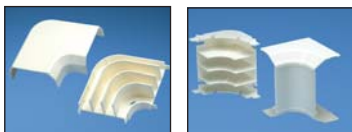

T70RA

T70IC

E5. Lockout/Tagout & Safety Solutions

F. Index

| Part Number      | Part Description  | Color‡    | Std. Pkg. Qty. | Std. Ctn. Qty. |
|------------------|---|-----------|----------------|----------------|
| <b>T70CCIW-X</b> | T-70 cover coupler fitting: Joins cover sections of T-70, Twin-70, and TG-70. raceway cover together. | Off White | 10             | 100            |
| <b>T70BCIW-X</b> | Base coupler fitting. Used to join sections of T-70 raceway base together.                            | Off White | 10             | 0              |
| <b>T70RAIW</b>   | Right angle fitting. Used to join sections of T-70 raceway at right angles.                           | Off White | 1              | 10             |
| <b>T70ICIW</b>   | Inside corner fitting. Used to join sections of T-70 raceway at inside corners.                       | Off White | 1              | 10             |

‡For other colors replace IW (Off White) with EI (Electric Ivory), BL (Black), IG (International Gray), or WH (White).



## Pan-Way® T-70 Raceway Fittings (continued)

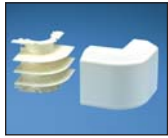

T70OC

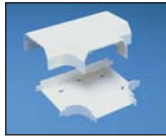

T70T



T70TD



T70EC



T70EE



T70TR  
T70TRC



T70TRI



T70WM40TR



T70BF



T70BFI



T70WC



T70WC2

| Part Number        | Part Description  | Color‡    | Std. Pkg. Qty. | Std. Ctn. Qty. |
|--------------------|---|-----------|----------------|----------------|
| <b>T70OCIW</b>     | Outside corner fitting. Used to join sections of T-70 raceway at outside corners.   | Off White | 1              | 10             |
| <b>T70TIW</b>      | Tee fitting. Used to join sections of T-70 raceway at tee intersections.  | Off White | 1              | 10             |
| <b>T70TD</b>       | T-70 tee fitting divider. Separates power and data within tee fitting. Replaces T70TDB, T70TDC, and T70TDT.   | Gray      | 1              | 10             |
| <b>T70ECIW</b>     | End cap fitting. Used to terminate or allow entry to T-70 raceway with conduit breakouts of 1/2" .  | Off White | 1              | 10             |
| <b>T70EEIW</b>     | Entrance end fitting. Conduit breakouts of 1/2", 3/4", 1" and 1 1/4" which allows entry from ceiling or wall.   | Off White | 1              | 10             |
| <b>T70TRIW</b>     | Transition fitting. Used to transition to any LD profile or T-45 raceway while maintaining channel separation. Fitting includes bend radius insert.   | Off White | 1              | 10             |
| <b>T70TRCIW</b>    | Transition fitting cover. Used to transition to any LD profile or T-45 raceway.   | Off White | 1              | 10             |
| <b>T70TRI</b>      | Divided insert for T-70 to LD2P10. Maintains channel separation within T70TR fitting.   | Gray      | 1              | 10             |
| <b>T70WM40TRIW</b> | WIREMOLD* 4000 to T-70 transition fitting. In-line transition fitting from WIREMOLD 4000 to T-70 raceway.   | Off White | 1              | 10             |
| <b>T70BFIW</b>     | Backfeed fitting. Allows cable entry through the back of the T-70 raceway.  | Off White | 1              | 10             |
| <b>T70BFI</b>      | Backfeed fitting insert. Bend radius insert to be used with T70BF.  | Gray      | 1              | 10             |
| <b>T70WCIW</b>     | Workstation Outlet Center™ Offset Box for screw-on faceplates. Two-piece box and bracket accept any NEMA standard screw-on faceplate.   | Off White | 1              | 10             |
| <b>T70WC2IW</b>    | Workstation Outlet Center™ Offset Box for Pan-Way® Snap-On Faceplates. Two-piece box and bracket accept any standard electrical outlet. Accepts any Pan-Way® Snap-On Electrical/Communication Faceplates. | Off White | 1              | 10             |

‡For other colors replace IW (Off White) with EI (Electric Ivory), BL (Black), IG (International Gray), or WH (White).  
\*WIREMOLD is a registered trademark of the Wiremold Co.

A. System Overview

B1. Cable Ties

B2. Cable Accessories

B3. Stainless Steel Ties

C1. Wiring Duct

C2. Surface Raceway

C3. Abrasion Protection

C4. Cable Management

D1. Terminals

D2. Power Connectors

D3. Grounding Connectors

E1. Labeling Systems

E2. Labels

E3. Pre-Printed & Write-On Markers

E4. Permanent Identification

E5. Lockout/Tagout & Safety Solutions

F. Index

A. System Overview



## Pan-Way® Twin-70 Surface Raceway System

B1. Cable Ties

- UL and CSA rated 600 V; meets UL 5A and CSA C22.2 No. 62.1-03 standards; FT4 rated
- Separate channels allow independent access to power and communication cabling throughout the entire system
- Transitions to Panduit T-70, T-45, and LD profile raceway

- Compatible with NEMA standard 70mm faceplates or Pan-Way® Classic Series Snap-On Faceplates
- Tamper resistant
- Supplied with pre-punched mounting holes

B2. Cable Accessories

B3. Stainless Steel Ties

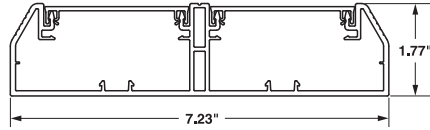

TWIN-70  
Left Internal Area = 4.59 Sq. In.  
Right Internal Area = 4.59 Sq. In.

C1. Wiring Duct



T702B

C2. Surface Raceway

C3. Abrasion Protection

C4. Cable Management



T70C

D1. Terminals

D2. Power Connectors

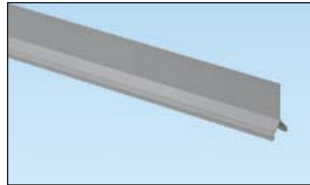

T70DW

D3. Grounding Connectors

E1. Labeling Systems

E2. Labels

E3. Pre-Printed & Write-On Markers

E4. Permanent Identification

E5. Lockout/Tagout & Safety Solutions

F. Index

| Part Number                 | Part Description  | Raceway Size                     | Color‡    | Length (Ft.) | Std. Ctn. Qty. |
|-----------------------------|---|----------------------------------|-----------|--------------|----------------|
| <b>Twin-70 Raceway Base</b> |   |                                  |           |              |                |
| <b>T702BIW8</b>             | Twin-70 raceway base in 8' and 10' lengths. Supplied with pre-punched mounting holes. | 7.23" x 1.77" (184.0mm x 45.0mm) | Off White | 8            | 24             |
| <b>T702BIW10</b>            |   |                                  |           | 10           | 30             |

| <b>T-70/TG-70/Twin-70 Raceway Cover</b> |  |   |           |    |     |
|---|--|---|-----------|----|-----|
| <b>T70CIW8</b>                          | T-70, TG-70, or Twin-70 raceway cover in 8' and 10' lengths. | — | Off White | 8  | 96  |
| <b>T70CIW10</b>                         |  |   |           | 10 | 120 |

| <b>T-70/Twin-70 Raceway Divider Wall</b> |   |   |      |    |     |
|--|---|---|------|----|-----|
| <b>T70DW8</b>                            | T-70/Twin-70 raceway divider wall. Snaps onto rails in T-70/Twin-70 raceway base to create separate channels. Must use wire retainers to ensure channel separation per UL/CSA. Available in 8' and 10' lengths. | — | Gray | 8  | 96  |
| <b>T70DW10</b>                           |   |   |      | 10 | 120 |

‡ For other colors replace IW (Off White) with EI (Electric Ivory) or WH (White).

**2' of cover needed for every 1' of Twin-70 base.**

Order number of feet required in multiples of standard carton quantity.



## Pan-Way® Twin-70 Raceway Fittings

- Twin-70 fittings are designed to maintain the TIA/EIA-568-B and 569-B required minimum bend radius for high performance copper and fiber optic cabling systems



T70CC

T702BC

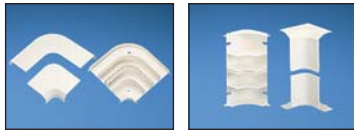

T702RA

T702IC

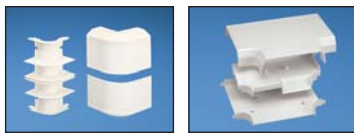

T702OC

T702T



T702EC

T702EE

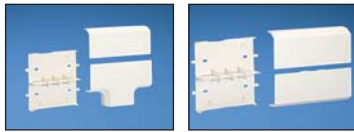

T702TR

T702TRL

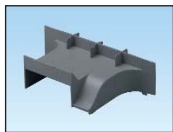

T702TRI

| Part Number       | Part Description  | Color‡    | Std. Pkg. Qty. | Std. Ctn. Qty. |
|-------------------|---|-----------|----------------|----------------|
| <b>T70CCIW-X</b>  | Cover coupler fitting. Used to join sections of cover together.   | Off White | 10             | 100            |
| <b>T702BCIW-X</b> | Base coupler fitting. Used for joining sections of Twin-70 base together.   | Off White | 10             | —              |
| <b>T702RAIW</b>   | Right angle fitting. Used to join sections of Twin-70 raceway at 90° flat junctions.  | Off White | 1              | 10             |
| <b>T702ICIW</b>   | Inside corner fitting. Used to join sections of Twin-70 raceway at inside corners.  | Off White | 1              | 10             |
| <b>T702OCIW</b>   | Outside corner fitting. Used to join sections of Twin-70 raceway at outside corners.  | Off White | 1              | 10             |
| <b>T702TIW</b>    | Tee fitting. Used to join sections of Twin-70 raceway at tee intersections.   | Off White | 1              | 5              |
| <b>T702ECIW</b>   | End cap fitting. Conduit breakouts of 1/2" for entry into raceway channel.  | Off White | 1              | 10             |
| <b>T702EEIW</b>   | Entrance end fitting. Conduit breakouts of 1/2", 3/4", 1", 1 1/4" and 1 1/2" for entry from ceiling or wall.                            | Off White | 1              | 5              |
| <b>T702TRIW</b>   | Transition fitting. Used to transition to T-70 raceway.   | Off White | 1              | 5              |
| <b>T702TRLIW</b>  | Transition fitting. Used to transition to any LD profile or T-45 raceway.   | Off White | 1              | 5              |
| <b>T702TRI</b>    | Transition divider insert for Twin-70 to T-70 or Twin-70 to LD profile. Maintains channel separation within T702TR or T702TRL fittings. | Gray      | 1              | 10             |

‡For other colors replace IW (Off White) with EI (Electric Ivory) or WH (White). T702TRI available in Gray only.

A.  
System  
Overview

B1.  
Cable Ties

B2.  
Cable  
Accessories

B3.  
Stainless  
Steel Ties

C1.  
Wiring  
Duct

C2.  
Surface  
Raceway

C3.  
Abrasion  
Protection

C4.  
Cable  
Management

D1.  
Terminals

D2.  
Power  
Connectors

D3.  
Grounding  
Connectors

E1.  
Labeling  
Systems

E2.  
Labels

E3.  
Pre-Printed  
& Write-On  
Markers

E4.  
Permanent  
Identification

E5.  
Lockout/  
Tagout  
& Safety  
Solutions

F.  
Index



A. System Overview



## Pan-Way® T-70 and Twin-70 Raceway Accessories

B1. Cable Ties

- T-70 and Twin-70 raceway accessories consist of device mounting brackets, snap-on device brackets, hanging boxes and 3-sided hanging boxes used to mount NEMA standard single gang electrical outlets and/or communication devices

B2. Cable Accessories



T70DB-X



T70SDB-X

B3. Stainless Steel Ties



T70HB-X



T70HB3-X

C1. Wiring Duct

C2. Surface Raceway

C3. Abrasion Protection



T70HB3GFCI-X



T70WR-X

C4. Cable Management



T70S-X

D1. Terminals

D2. Power Connectors

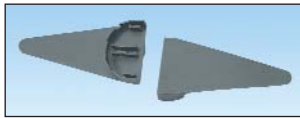

T70FSB

D3. Grounding Connectors

E1. Labeling Systems

E2. Labels

E3. Pre-Printed & Write-On Markers

E4. Permanent Identification

E5. Lockout/Tagout & Safety Solutions

F. Index

| Part Number         | Part Description   | Color | Std. Pkg. Qty. | Std. Ctn. Qty. |
|---------------------|--|-------|----------------|----------------|
| <b>T70DB-X</b>      | Device mounting bracket. Used to mount NEMA standard single gang electrical outlets and communication devices with either screw-on or snap-on single gang faceplates. Can be used with T-70, Twin-70, and TG-70 raceway.   | Gray  | 10             | —              |
| <b>T70SDB-X</b>     | Standard faceplate bracket. Used to mount NEMA standard 70mm single gang screw-on faceplates. Can be used with T-70, Twin-70, TG-70 raceway and Pan-Pole™ Communication Pole.  | Gray  | 10             | —              |
| <b>T70HB-X</b>      | Hanging box. Used to mount NEMA standard single gang electrical outlets and devices with either screw-on or snap-on single gang faceplates when there are communications cables in the raceway. For use in T-70 and Twin-70 raceway only.  | Gray  | 10             | —              |
| <b>T70HB3-X</b>     | 3-sided hanging box. Used to mount NEMA standard single gang electrical outlets and devices with either screw-on or snap-on single gang faceplates when there are communications cables in the raceway. Box is low profile for increased channel capacity and does not require breakout removal. For use with T-70 and Twin-70 raceway only. | Gray  | 10             | —              |
| <b>T70HB3GFCI-X</b> | T70 GFCI 3-sided hanging box. Accepts single gang U.S. GFCI (ground fault circuit interrupter) standard electrical devices. Provides increased internal area for connections and excess wire.  | Gray  | 10             | —              |
| <b>T70WR-X</b>      | Wire retainer. Holds wires in place during installation.   | Gray  | 10             | 100            |
| <b>T70S-X</b>       | Spacer plate. Used to mount the CBX4 surface mount box onto the T70DB-X or T70HB-X/T70HB3-X.   | —     | 10             | —              |
| <b>T70FSB</b>       | Fiber spool bracket. Each piece consists of two halves that snap into base of T-70 or Twin-70 raceway. Provides method to contain one meter or more of fiber slack and acts as a strain relief while maintaining a minimum 30mm bend radius. Bracket separation can be adjusted to fit the length of slack required.                         | Gray  | 1              | 10             |



Use the T70FSB with T-70 or Twin-70 raceway to contain 1m or more of fiber slack while maintaining a 30mm cable bend radius. Brackets are adjustable for slack length.



Use T70S-X spacer plate for mounting the CBX4 surface mount box on T-70 or T702.



## Cable Fill Capacities for T-70 Raceway

This information is to be used as a guide in selecting the proper size raceway. The maximum amounts may vary according to the cable installation methods, straightness of cables, etc.

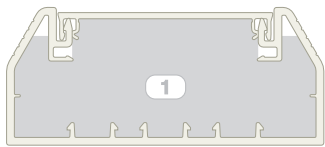

A = 5.15 in.<sup>2</sup>

**Cable fill #1:** Raceway with no devices.

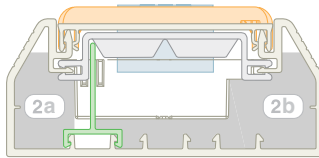

A = .86 in.<sup>2</sup>      A = 1.72 in.<sup>2</sup>

**Cable fill #2:** Power and data using 3-sided hanging box and device bracket.

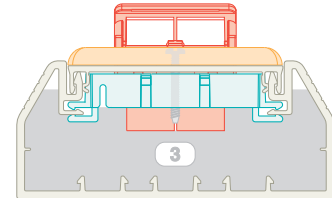

A = 3.67 in.<sup>2</sup>

**Cable fill #3:** Data only using vertical sloped screw-on communication faceplates.

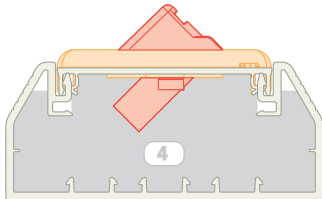

A = 4.71 in.<sup>2</sup>

**Cable fill #4:** Data only using horizontal sloped snap-on communication faceplates.

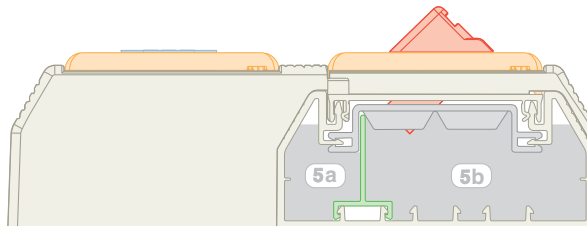

A = .91 in.<sup>2</sup>      A = 3.12 in.<sup>2</sup>

**Cable fill #5:** Power and data using the Workstation Outlet Center™ Offset Box.

**SPEC = 40% cable fill** – The recommended design in cable capacity, leaves room for future moves, adds, and changes.

**MAX for Data = 60% cable fill** – The maximum cable quantity based on cable interweaving and packing factors.

**MAX for Power cable fill** – The maximum of electrical cables based on UL temperature rise test.

| Raceway Type and Configuration   | Fill Area (in. <sup>2</sup> ) | Electrical Cables   |                 |                 | Data Grade Cables            |                                | Data Grade Cables |       | Audio/Video  |       | Fiber Optic Cable |       |     |
|--|-------------------------------|---------------------|-----------------|-----------------|------------------------------|--------------------------------|-------------------|-------|--------------|-------|-------------------|-------|-----|
|  |                               | 14 AWG THHN/T90     | 12 AWG THHN/T90 | 10 AWG THHN/T90 | 24 AWG/UTP CM Cat 6. (4-pr.) | 24 AWG/UTP CM Augmented Cat. 6 | RG6               |       | 2 Strand     |       |                   |       |     |
|  |                               | 0.111               | 0.130           | 0.164           | DIA. = 0.250                 | DIA. = 0.330                   | DIA. = 0.275      |       | DIA. = 0.175 |       |                   |       |     |
|  |                               | FILL                |                 |                 | FILL                         |                                | FILL              |       | FILL         |       | FILL              |       |     |
|  |                               | MAX                 | MAX             | MAX             | SPEC                         | MAX                            | SPEC              | MAX   | SPEC         | MAX   | SPEC              | MAX   | MAX |
|  |                               | (UL Temp Rise Test) |                 |                 | (40%)                        | (60%)                          | (40%)             | (60%) | (40%)        | (60%) | (40%)             | (60%) |     |
| 1. T-70: No devices.   | 5.15                          | 24                  | 20              | 15              | 41                           | 62                             | 24                | 36    | 34           | 52    | 85                | 128   |     |
| 2a. T-70: Power and data using the 3-sided hanging box and device bracket. | 0.86                          | 14                  | 11              | 7               | —                            | —                              | —                 | —     | —            | —     | —                 | —     |     |
| 2b.  | 1.72                          | —                   | —               | —               | 14                           | 21                             | 8                 | 12    | 11           | 17    | 28                | 42    |     |
| 3. T-70: Data only (screw-on faceplates).                                  | 3.67                          | —                   | —               | —               | 29                           | 44                             | 17                | 25    | 24           | 37    | 61                | 91    |     |
| 4. T-70: Data only (snap-on faceplates).                                   | 4.71                          | —                   | —               | —               | 38                           | 57                             | 22                | 33    | 31           | 47    | 78                | 117   |     |
| 5a. T-70: Power and data using the Workstation Outlet Center™ Offset Box.  | 0.91                          | 14                  | 11              | 7               | —                            | —                              | —                 | —     | —            | —     | —                 | —     |     |
| 5b.  | 3.12                          | —                   | —               | —               | 25                           | 38                             | 14                | 21    | 21           | 31    | 51                | 77    |     |

AWG dimensions represent typical outer cable diameter in inches.

A. System Overview

## Cable Fill Capacities for Twin-70 Raceway

B1. Cable Ties

This information is to be used as a guide in selecting the proper size raceway. The maximum amounts may vary according to the cable installation methods, straightness of cables, etc.

B2. Cable Accessories

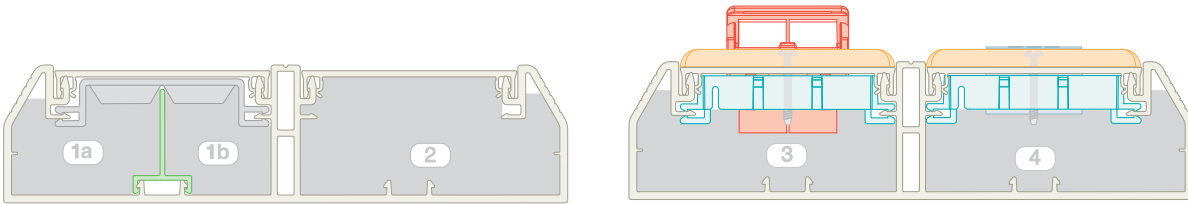

**A = 2.05 in.<sup>2</sup>**      **A = 1.43 in.<sup>2</sup>**      **A = 4.59 in.<sup>2</sup>**      **A = 3.11 in.<sup>2</sup>**      **A = 3.32 in.<sup>2</sup>**

**Cable fill #1:** Power and data with no devices.      **Cable fill #2:** One Twin-70 channel with no devices.      **Cable fill #3:** Data only using vertical sloped screw-on communication faceplates.      **Cable fill #4:** Power using device bracket and NEMA standard 70mm screw-on faceplates.

B3. Stainless Steel Ties

C1. Wiring Duct

C2. Surface Raceway

C3. Abrasion Protection

C4. Cable Management

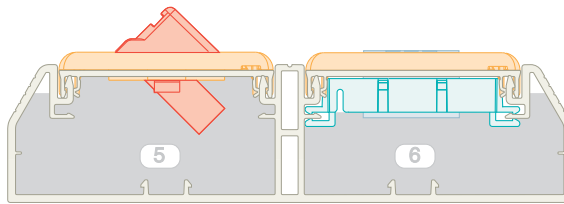

**A = 4.14 in.<sup>2</sup>**      **A = 2.33 in.<sup>2</sup>**

**Cable fill #5:** Data only using horizontal sloped snap-on communication faceplates.      **Cable fill #6:** 20 A TVSS rectangular outlet using device bracket and snap-on electrical/communication faceplate.

D1. Terminals

D2. Power Connectors

D3. Grounding Connectors

E1. Labeling Systems

E2. Labels

E3. Pre-Printed & Write-On Markers

E4. Permanent Identification

E5. Lockout/Tagout & Safety Solutions

F. Index

**SPEC = 40% cable fill** – The recommended design in cable capacity, leaves room for future moves, adds, and changes.

**MAX for Data = 60% cable fill** – The maximum cable quantity based on cable interweaving and packing factors.

**MAX for Power cable fill** – The maximum of electrical cables based on UL temperature rise test.

| Raceway Type and Configuration                | Fill Area (In. <sup>2</sup> ) | Electrical Cables |        |        | Data Grade Cables | Data Grade Cables | Audio/Video      |       | Fiber Optic Cable |       |              |       |
|---|-------------------------------|-------------------|--------|--------|-------------------|-------------------|------------------|-------|-------------------|-------|--------------|-------|
|   |                               | 14 AWG            | 12 AWG | 10 AWG | 24 AWG/UTP CM     | 24 AWG/UTP CM     | RG6              |       | 2 Strand          |       |              |       |
|   |                               | THHN/T90          |        |        | Cat 6. (4-pr.)    |                   | Augmented Cat. 6 |       |                   |       |              |       |
|   |                               | 0.111             | 0.130  | 0.164  | DIA. = 0.250      |                   | DIA. = 0.330     |       | DIA. = 0.275      |       | DIA. = 0.175 |       |
|   |                               | FILL              |        |        | FILL              |                   | FILL             |       | FILL              |       | FILL         |       |
| MAX   | MAX                           | MAX               | SPEC   | MAX    | SPEC              | MAX               | SPEC             | MAX   | SPEC              | MAX   | MAX          |       |
| (UL Temp Rise Test)                           |                               |                   | (40%)  | (60%)  | (40%)             | (60%)             | (40%)            | (60%) | (40%)             | (60%) | (40%)        | (60%) |
| 1a. Twin-70: Power and data, no terminations. | 2.05                          | —                 | —      | —      | 16                | 25                | 9                | 14    | 13                | 20    | 34           | 51    |
| 1b. Twin-70: One channel no devices (data).   | 1.43                          | 16                | 16     | 15     | —                 | —                 | —                | —     | —                 | —     | —            | —     |
| 2. Twin-70: One channel no devices (data).    | 4.59                          | —                 | —      | —      | 37                | 56                | 21               | 32    | 30                | 46    | 76           | 114   |
| 3. Twin-70: Data only (screw-on faceplate).   | 3.11                          | —                 | —      | —      | 25                | 38                | 14               | 21    | 20                | 31    | 51           | 77    |
| 4. Twin-70: Power only (screw-on faceplate).  | 3.32                          | 15                | 13     | 13     | —                 | —                 | —                | —     | —                 | —     | —            | —     |
| 5. Twin-70: Data only (snap-on faceplate).    | 4.14                          | —                 | —      | —      | 33                | 50                | 19               | 29    | 27                | 41    | 68           | 103   |
| 6. Twin-70: TVSS power (snap-on faceplate).   | 2.33                          | 16                | 16     | 14     | —                 | —                 | —                | —     | —                 | —     | —            | —     |

AWG dimensions represent typical outer cable diameter in inches.

## PAN-WAY® T-45 NON-METALLIC SURFACE RACEWAY

Pan-Way® T-45 Non-Metallic Surface Raceway is a multi-channel raceway which provides a solution for routing copper, fiber optic, and/or power cabling along fixed perimeter walls. T-45 surface raceway terminates using the T-45 hinged data and power brackets, T-45 offset box, and select Pan-Way® Surface Mount Outlet Boxes.

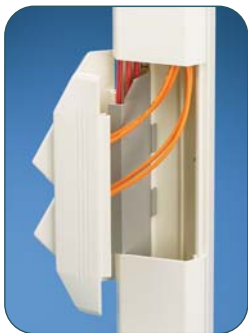

- Multi-directional cover hinge allows cable installation from either side
- Hinged data and power brackets provide easy access for terminating outlets
- Aesthetically pleasing
- Lightweight
- Tamper resistant
- Fittings maintain 1 inch bend radius control

Pan-Way® T-45 Surface Raceway accepts NEMA standard screw-on faceplates for superior Pan-Way® Snap-On Faceplates when terminating with the T-45 offset box and surface mount outlet boxes. Fittings for T-45 are available to transition to Pan-Way® LD Series Raceway.

A.  
System  
Overview

B1.  
Cable Ties

B2.  
Cable  
Accessories

B3.  
Stainless  
Steel Ties

C1.  
Wiring  
Duct

C2.  
Surface  
Raceway

C3.  
Abrasion  
Protection

C4.  
Cable  
Management

D1.  
Terminals

D2.  
Power  
Connectors

D3.  
Grounding  
Connectors

E1.  
Labeling  
Systems

E2.  
Labels

E3.  
Pre-Printed  
& Write-On  
Markers

E4.  
Permanent  
Identification

E5.  
Lockout/  
Tagout  
& Safety  
Solutions

F.  
Index

A.  
System  
Overview

B1.  
Cable Ties

B2.  
Cable  
Accessories

B3.  
Stainless  
Steel Ties

C1.  
Wiring  
Duct

C2.  
Surface  
Raceway

C3.  
Abrasion  
Protection

C4.  
Cable  
Management

D1.  
Terminals

D2.  
Power  
Connectors

D3.  
Grounding  
Connectors

E1.  
Labeling  
Systems

E2.  
Labels

E3.  
Pre-Printed  
& Write-On  
Markers

E4.  
Permanent  
Identification

E5.  
Lockout/  
Tagout  
& Safety  
Solutions

F.  
Index

## T-45 Raceway Roadmap

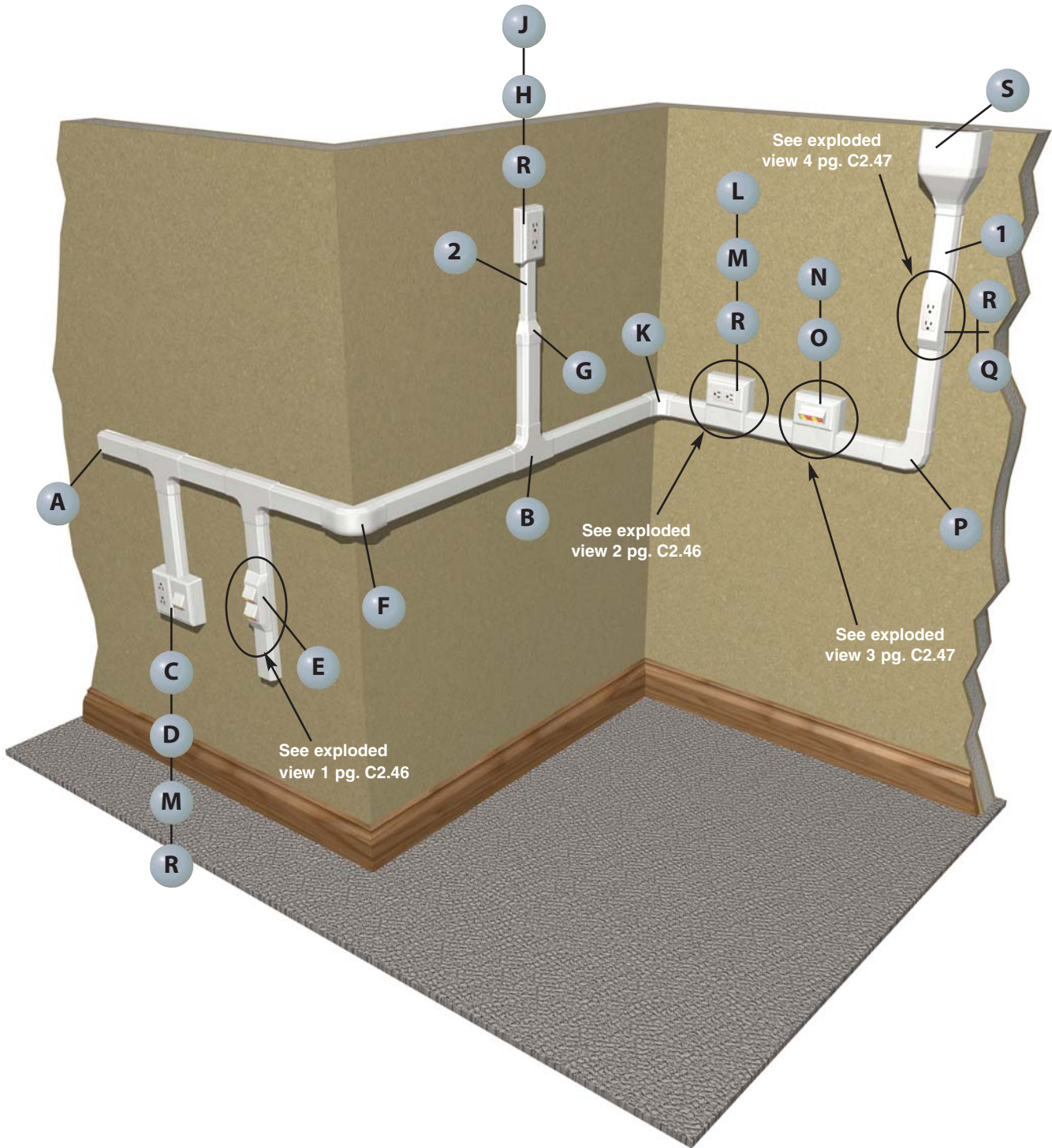

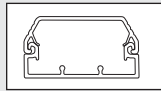

**1** T45B\*\* , T45C\*\* – T-45 Raceway Base and Cover (page C2.48)

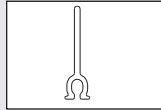

**1** T45DW\*\* – T-45 Divider Wall (page C2.48)

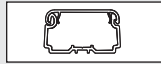

**2** LDPH10\*\* – LDPH Raceway (page C2.77)



**A** T45EC\*\* – T-45 End Cap Fitting (page C2.49)



**B** T45T\*\* and T45TD – T-45 Tee Fitting and Divider (page C2.49)

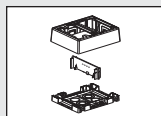

**C** JBP2FS\*\* – Fast-Snap™ Double Gang Power Rated Surface Mount Outlet Box (page C2.52)

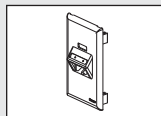

**D** UIT70FV2\*\* – Ultimate ID® Sloped Vertical Snap-On Faceplate (see SA-NCCB51)

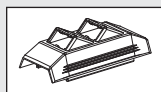

**E** T45HDB\*\* – T-45 Snap-On Hinged Data Bracket (page C2.49)

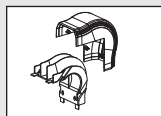

**F** T45OC\*\* – T-45 Outside Corner Fitting (page C2.49)

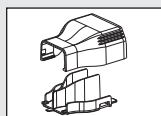

**G** T45RLD\*\* – T-45 Reducer Fitting (page C2.49)

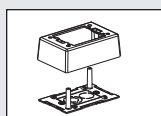

**H** JBP1\*\* – Power Rated Single Gang Two-Piece Box (page C2.58)

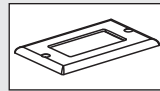

**J** CPG\*\* – Single Gang Rectangular Electrical/Communication Screw-On Faceplate (page C2.60)

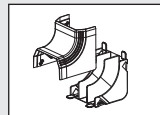

**K** T45IC\*\* – T-45 Inside Corner Fitting (page C2.49)

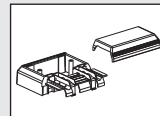

**L** T45WC\*\* – T-45 Offset Box for Screw-On Faceplates/Receptacles (page C2.49)

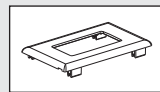

**M** T70PG\*\* – Single Gang Rectangular Electrical/Communication Snap-On Faceplate (page C2.53)

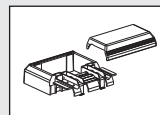

**N** T45WC2\*\* – T-45 Offset Box for Snap-On Faceplates (page C2.49)

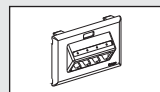

**O** UIT70FH4\*\* – Ultimate ID® Sloped Horizontal Snap-On Faceplate (see SA-NCCB51)

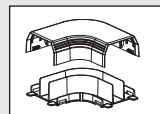

**P** T45RA\*\* – T-45 Right Angle Fitting (page C2.49)

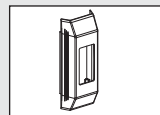

**Q** T45HEGB\*\* – T-45 Electrical Bracket (page C2.49)

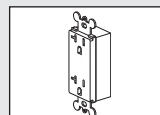

**R** ERU20\*\* – 20 A Rectangular Electrical Outlet (page C2.61)

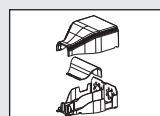

**S** T45EE\*\* – T-45 Entrance End Fitting (page C2.49)

A. System Overview

B1. Cable Ties

B2. Cable Accessories

B3. Stainless Steel Ties

C1. Wiring Duct

C2. Surface Raceway

C3. Abrasion Protection

C4. Cable Management

D1. Terminals

D2. Power Connectors

D3. Grounding Connectors

E1. Labeling Systems

E2. Labels

E3. Pre-Printed & Write-On Markers

E4. Permanent Identification

E5. Lockout/Tagout & Safety Solutions

F. Index



A.  
System  
Overview

## T-45 Configurations

B1.  
Cable Ties

### Exploded View 1

|    | Components Required                        | See page |
|----|--|----------|
| A. | T45HDB = T-45 snap-on hinged data bracket. | C2.49    |
| B. | Mini-Com® Modules.                         | —        |

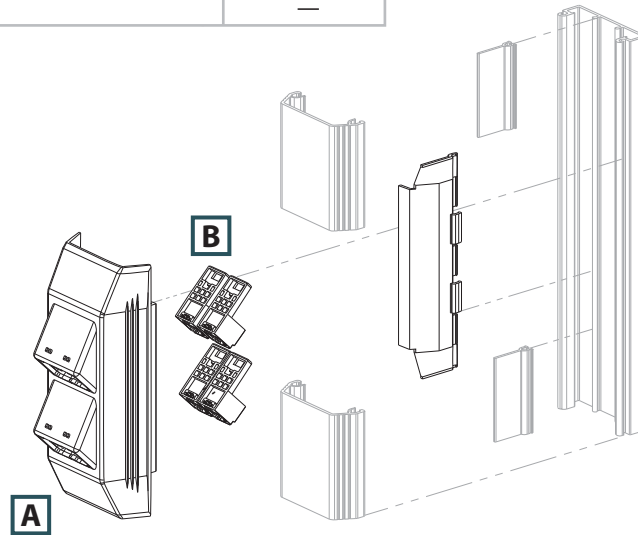

B3.  
Stainless  
Steel Ties

C1.  
Wiring  
Duct

C2.  
Surface  
Raceway

C3.  
Abrasion  
Protection

C4.  
Cable  
Management

### Exploded View 2

|    | Components Required   | See page |
|----|---|----------|
| A. | T70PG = Single gang rectangular electrical/communication snap-on faceplate. | C2.53    |
| B. | ERU20 = 20 A rectangular electrical outlet (screws included).               | C2.61    |
| C. | T45WC = T-45 offset box for screw-on faceplates/receptacles.                | C2.49    |

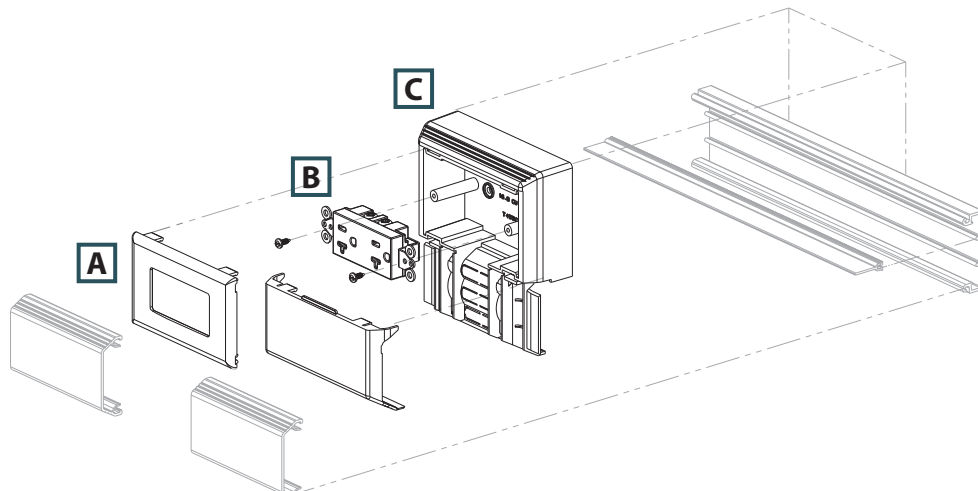

D1.  
Terminals

D2.  
Power  
Connectors

D3.  
Grounding  
Connectors

E1.  
Labeling  
Systems

E2.  
Labels

E3.  
Pre-Printed  
& Write-On  
Markers

E4.  
Permanent  
Identification

E5.  
Lockout/  
Tagout  
& Safety  
Solutions

F.  
Index



## T-45 Configurations (continued)

### Exploded View 3

|    | Components Required  | See page |
|----|--|----------|
| A. | UIT70FH4 = Ultimate ID® Sloped Horizontal Faceplates – 4-Port. | —        |
| B. | Mini-Com® Modules.   | —        |
| C. | T45WC2 = T-45 offset box for snap-on faceplates.               | C2.49    |

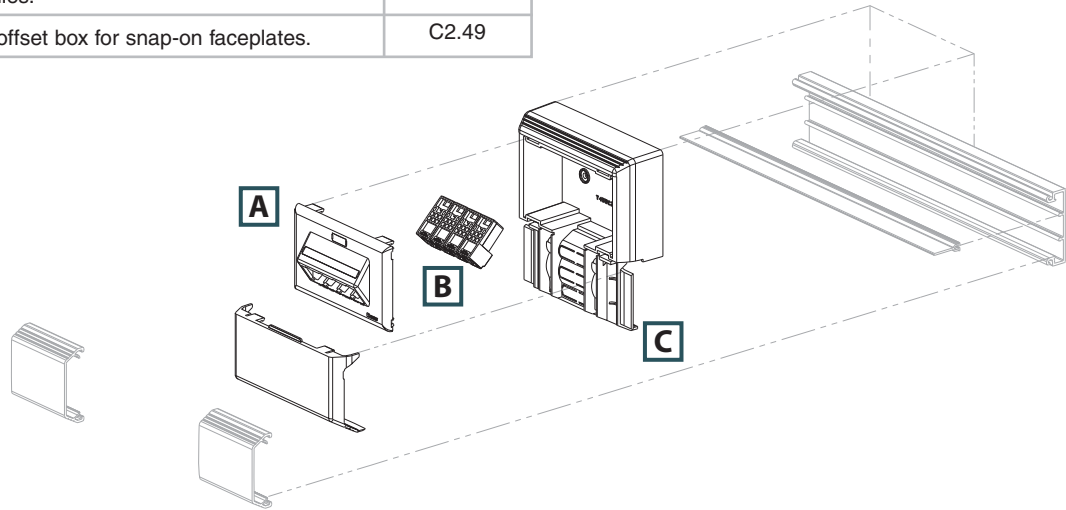

### Exploded View 4

|    | Components Required   | See page |
|----|---|----------|
| A. | T45HEGB = T-45 electrical bracket for rectangular outlet.     | C2.49    |
| B. | ERU20 = 20 A rectangular electrical outlet (screws included). | C2.61    |

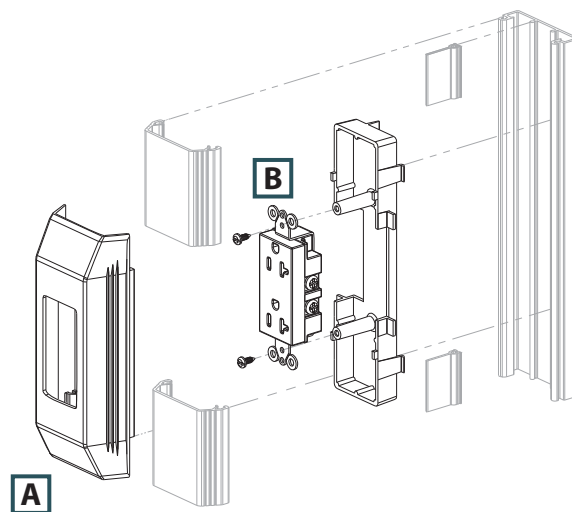

A.  
System  
Overview

B1.  
Cable Ties

B2.  
Cable  
Accessories

B3.  
Stainless  
Steel Ties

C1.  
Wiring  
Duct

C2.  
Surface  
Raceway

C3.  
Abrasion  
Protection

C4.  
Cable  
Management

D1.  
Terminals

D2.  
Power  
Connectors

D3.  
Grounding  
Connectors

E1.  
Labeling  
Systems

E2.  
Labels

E3.  
Pre-Printed  
& Write-On  
Markers

E4.  
Permanent  
Identification

E5.  
Lockout/  
Tagout  
& Safety  
Solutions

F.  
Index

A. System Overview



## Pan-Way® T-45 Surface Raceway System

B1. Cable Ties

- UL and CSA rated 600 V; meets UL 5A and CSA C22.2 No. 62.1-03 standards; FT4 rated
- Hinged cover allows easy access from either side
- Optional factory applied adhesive backing speeds installation

- Supplied with pre-punched mounting holes
- Tamper resistant
- Terminates using the T-45 hinged data or power brackets, offset box, or surface mount outlet box solutions

B2. Cable Accessories

B3. Stainless Steel Ties

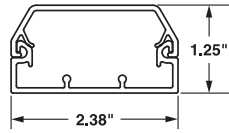

T-45  
Internal Area = 2.12 Sq. In.

| Part Number                               | Part Description  | Raceway Size                       | Color‡    | Length (Ft.) | Std. Ctn. Qty. |
|---|---|------------------------------------|-----------|--------------|----------------|
| <b>T-45 Raceway Base with Adhesive</b>    |   |                                    |           |              |                |
| <b>T45BIW8-A</b>                          | T-45 raceway base in 8' and 10' lengths with adhesive. Supplied with pre-punched mounting holes.  | 2.38" x 1.25"<br>(60.3mm x 32.0mm) | Off White | 8            | 160            |
| <b>T45BIW10-A</b>                         |   |                                    |           | 10           | 200            |
| <b>T-45 Raceway Base without Adhesive</b> |   |                                    |           |              |                |
| <b>T45BIW8</b>                            | T-45 raceway base in 8' and 10' lengths with adhesive. Supplied with pre-punched mounting holes.  | 2.38" x 1.25"<br>(60.3mm x 32.0mm) | Off White | 8            | 160            |
| <b>T45BIW10</b>                           |   |                                    |           | 10           | 200            |
| <b>T-45 Raceway Cover</b>                 |   |                                    |           |              |                |
| <b>T45CIW8</b>                            | T-45 raceway cover in 8' and 10' lengths. Can be hinged open on either side of T-45 base.   | —                                  | Off White | 8            | 160            |
| <b>T45CIW10</b>                           |   |                                    |           | 10           | 200            |
| <b>T-45 Raceway Divider Wall</b>          |   |                                    |           |              |                |
| <b>T45DW8</b>                             | T-45 divider wall. Snaps onto rails in T-45 raceway base to create separate channels. Must use wire retainers to ensure channel separation per UL/CSA. Available in 8' and 10' lengths. | —                                  | Gray      | 8            | 0              |
| <b>T45DW10</b>                            |   |                                    |           | 10           | 200            |

‡For other colors replace IW (Off White) with EI (Electric Ivory) or BL (Black).  
Order base and cover separately.  
Order number of feet required in multiples of standard carton quantity.



T45B



T45C

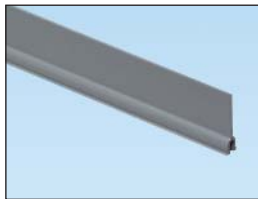

T45DW

C1. Wiring Duct

C2. Surface Raceway

C3. Abrasion Protection

C4. Cable Management

D1. Terminals

D2. Power Connectors

D3. Grounding Connectors

E1. Labeling Systems

E2. Labels

E3. Pre-Printed & Write-On Markers

E4. Permanent Identification

E5. Lockout/Tagout & Safety Solutions

F. Index



## Pan-Way® T-45 Raceway Fittings

- T-45 fittings are designed to maintain the TIA/EIA-568-B and 569-B required minimum bend radius for high performance copper and fiber optic cabling systems



T45CC

T45RA



T45IC

T45OC



T45T

T45TD

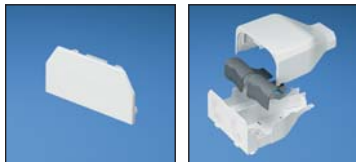

T45EC

T45EE



T45RLD

T45TRI

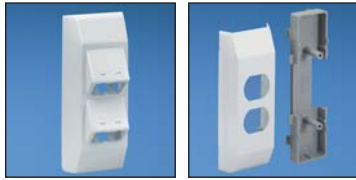

T45HDB

T45HEB

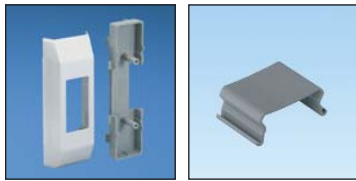

T45HEGB

T45WR-X

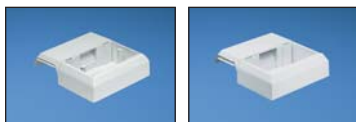

T45WC

T45WC2

| Part Number      | Part Description  | Color‡    | Std. Pkg. Qty. | Std. Ctn. Qty. |
|------------------|---|-----------|----------------|----------------|
| <b>T45CCIW-X</b> | Cover coupler fitting. Used to join two pieces of T-45 cover together.  | Off White | 10             | 100            |
| <b>T45RAIW</b>   | Right angle fitting. Used to join sections of T-45 raceway at 90° flat junction.  | Off White | 1              | 10             |
| <b>T45ICIW</b>   | Inside corner fitting. Used to join T-45 raceway at inside corner.  | Off White | 1              | 10             |
| <b>T45OCIW</b>   | Outside corner fitting. Used to join T-45 raceway at 90° outside corner.  | Off White | 1              | 10             |
| <b>T45TIW</b>    | Tee fitting. Used to join T-45 raceway at tee intersections.  | Off White | 1              | 10             |
| <b>T45TD</b>     | Divided insert. Used to separate power and data within the T45T.  | Gray      | 1              | 10             |
| <b>T45ECIW</b>   | End cap fitting. Used to terminate T-45 raceway.  | Off White | 1              | 10             |
| <b>T45EEIW</b>   | Entrance end fitting. With knockouts for 1/2", 3/4", 1" and 1 1/4" conduit which allows entry from ceiling or wall.   | Off White | 1              | 10             |
| <b>T45RLDIW</b>  | Reducer fitting. Reduces from T-45 to LD10 profile raceway.   | Off White | 1              | 10             |
| <b>T45TRI</b>    | Provides bend radius control at transition from T-70 to T-45 when used with T70TR.  | Gray      | 1              | 10             |
| <b>T45HDBIW</b>  | Snap-on hinged data bracket. Used for mounting Panduit® Mini-Com® Modules vertically inline within T-45 raceway. Can be hinged opened on either side of T-45 base.  | Off White | 1              | 10             |
| <b>T45HEBIW</b>  | Electrical bracket and box. Used for mounting standard duplex electrical outlets.   | Off White | 1              | 10             |
| <b>T45HEGBIW</b> | Electrical bracket and box. Used for mounting standard rectangular style electrical outlets.  | Off White | 1              | 10             |
| <b>T45WR-X</b>   | Wire retainers. Used to hold wires in place during installation.  | Gray      | 10             | 100            |
| <b>T45WCIW</b>   | Offset box. Allows for the mounting of any standard electrical or communication outlet offset from the raceway channel. Box accepts any NEMA standard screw-on faceplate or Pan-Way® Electrical Snap-On Faceplates. | Off White | 1              | 10             |
| <b>T45WC2IW</b>  | Offset box. Box accepts any Pan-Way® Communication Snap-On Faceplates.  | Off White | 1              | 10             |

‡For other colors replace IW (Off White) with EI (Electric Ivory) or BL (Black). T45TD, T45TRI, and T45WR-X available in Gray only.

A. System Overview

B1. Cable Ties

B2. Cable Accessories

B3. Stainless Steel Ties

C1. Wiring Duct

C2. Surface Raceway

C3. Abrasion Protection

C4. Cable Management

D1. Terminals

D2. Power Connectors

D3. Grounding Connectors

E1. Labeling Systems

E2. Labels

E3. Pre-Printed & Write-On Markers

E4. Permanent Identification

E5. Lockout/Tagout & Safety Solutions

F. Index

A. System Overview

## Cable Fill Capacities for T-45 Raceway

This information is to be used as a guide in selecting the proper size raceway. The maximum amounts may vary according to the cable installation methods, straightness of cables, etc.

B1. Cable Ties

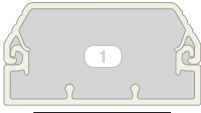

A = 2.13 in.<sup>2</sup>

**Cable fill #1:** T-45 with no devices.

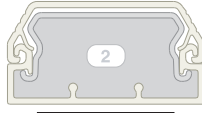

A = 1.72 in.<sup>2</sup>

**Cable fill #2:** T-45 with wire retainer.

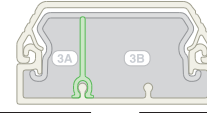

A = 0.44 in.<sup>2</sup>

B = 1.20 in.<sup>2</sup>

**Cable fill #3:** Power and data using a wire retainer and divider wall.

B2. Cable Accessories

B3. Stainless Steel Ties

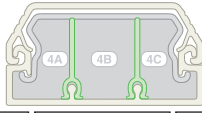

A = 0.44 in.<sup>2</sup>

B = 0.68 in.<sup>2</sup>

C = 0.44 in.<sup>2</sup>

**Cable fill #4:** Power and data using a wire retainer and divider walls.

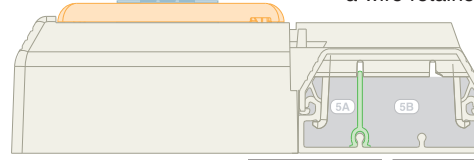

A = 0.41 in.<sup>2</sup>

B = 1.06 in.<sup>2</sup>

**Cable fill #5:** Power and data using the offset box.

C1. Wiring Duct

C2. Surface Raceway

C3. Abrasion Protection

C4. Cable Management

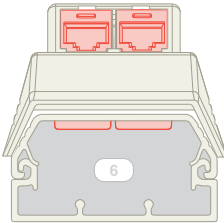

A = 2.00 in.<sup>2</sup>

**Cable fill #6:** Data only using hinged data bracket.

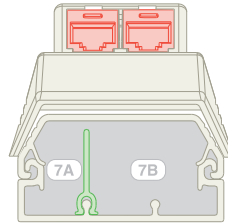

A = 0.52 in.<sup>2</sup>

B = 1.20 in.<sup>2</sup>

**Cable fill #7:** Power and data using hinged data bracket with divider insert.

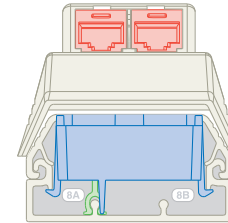

A = 0.22 in.<sup>2</sup>

B = 0.50 in.<sup>2</sup>

**Cable fill #8:** Power and data using electrical bracket/box and hinged data bracket.

D1. Terminals

D2. Power Connectors

D3. Grounding Connectors

E1. Labeling Systems

E2. Labels

E3. Pre-Printed & Write-On Markers

E4. Permanent Identification

E5. Lockout/Tagout & Safety Solutions

F. Index

**SPEC = 40% cable fill** – The recommended design in cable capacity, leaves room for future moves, adds, and changes.

**MAX for Data = 60% cable fill** – The maximum cable quantity based on cable interweaving and packing factors.

**MAX for Power cable fill** – The maximum of electrical cables based on UL temperature rise test.

| Raceway Type and Configuration  | Fill Area (In. <sup>2</sup> ) | Electrical Cables |        |        | Data Grade Cables |            | Data Grade Cables |       | Audio/Video |          | Fiber Optic Cable |       |
|---|-------------------------------|-------------------|--------|--------|-------------------|------------|-------------------|-------|-------------|----------|-------------------|-------|
|   |                               | 14 AWG            | 12 AWG | 10 AWG | 23/24 AWG/UTP     | 23 AWG/UTP | CM                | RG6   |             | 2 Strand |                   |       |
|   |                               | THHN/T90          |        |        | Cat 6. (4-pr.)    |            | Augmented Cat. 6  |       |             |          |                   |       |
|   |                               | 0.111             | 0.130  | 0.164  | DIA. = .250       |            | DIA. = .354       |       | DIA. = .275 |          | DIA. = .175       |       |
|   |                               | FILL              |        |        | FILL              |            | FILL              |       | FILL        |          | FILL              |       |
| MAX   | MAX                           | MAX               | SPEC   | MAX    | SPEC              | MAX        | SPEC              | MAX   | SPEC        | MAX      | SPEC              | MAX   |
| (UL Temp Rise Test)   |                               |                   | (40%)  | (60%)  | (40%)             | (60%)      | (40%)             | (60%) | (40%)       | (60%)    | (40%)             | (60%) |
| 1. T-45: No devices.  | 2.13                          | 36                | 27     | 25     | 17                | 26         | 9                 | 14    | 14          | 21       | 35                | 53    |
| 2. T-45: No devices with wire retainer.   | 1.72                          | 36                | 27     | 25     | 14                | 21         | 8                 | 12    | 11          | 17       | 28                | 42    |
| 3A. T-45: Power and data with wire retainer and divider wall                        | 0.44                          | 12                | 11     | 8      | —                 | —          | —                 | —     | —           | —        | —                 | —     |
| 3B. (2 channels).   | 1.20                          | —                 | —      | —      | 9                 | 14         | 5                 | 8     | 8           | 12       | 19                | 29    |
| 4A. T-45: Power and data with wire retainer and two divider walls (three channels). | 0.44                          | 12                | 11     | 8      | 3                 | 5          | 2                 | 3     | 2           | 4        | 7                 | 10    |
| 4B.   | 0.68                          | —                 | —      | —      | 5                 | 8          | 3                 | 4     | 4           | 6        | 11                | 16    |
| 4C.   | 0.44                          | —                 | —      | —      | 3                 | 5          | 2                 | 3     | 2           | 4        | 7                 | 10    |
| 5A. T-45: Power and data using the offset box.                                      | 0.41                          | 12                | 11     | 8      | —                 | —          | —                 | —     | —           | —        | —                 | —     |
| 5B.   | 1.06                          | —                 | —      | —      | 8                 | 12         | 4                 | 7     | 7           | 10       | 17                | 26    |
| 6. T-45: Data only using data bracket.  | 2.00                          | —                 | —      | —      | 16                | 24         | 9                 | 14    | 13          | 20       | 33                | 49    |
| 7A. T-45: Power and data using hinged data bracket with divider insert.             | 0.52                          | 12                | 11     | 8      | —                 | —          | —                 | —     | —           | —        | —                 | —     |
| 7B.   | 1.20                          | —                 | —      | —      | 9                 | 14         | 5                 | 8     | 8           | 12       | 19                | 29    |
| 8A. T-45: Power and data using electrical bracket and box.                          | 0.22                          | 9                 | 7      | 4      | —                 | —          | —                 | —     | —           | —        | —                 | —     |
| 8B.   | 0.50                          | —                 | —      | —      | 4                 | 6          | 2                 | 3     | 3           | 5        | 8                 | 12    |

AWG dimensions represent typical outer cable diameter in inches.

## PAN-WAY® SNAP-ON FACEPLATES AND SURFACE MOUNT OUTLET BOXES

Pan-Way® Snap-On Faceplates are designed for use with Panduit surface raceway systems and install faster than conventional screw-on faceplates, reducing labor costs and providing a more aesthetic appearance. Pan-Way® Snap-On Communication Faceplates are available in vertical and horizontal orientation and accept Panduit® Mini-Com® Copper and Fiber Optic Modules. Electrical outlets are available in colors to complement Panduit raceway and are available in 20 A, 106 duplex, rectangular, TVSS and GFCI.



- Snap-on faceplates install without the use of screws providing faster installation and superior aesthetics
- Fast-Snap™ Boxes assemble without the use of screws and accept Pan-Way® Snap-On Faceplates
- Snap-on communication faceplates are available in horizontal or vertical sloped outlet configurations
- Snap-on electrical faceplates are available in 106 duplex or rectangular styles

Surface mount outlet boxes are available for both power and communication applications. They are compatible with Pan-Way® LD, LDPH, LD2P10 and T-45 Raceway Systems. Pan-Way® Snap-On Faceplates mount directly to Cove, TG-70, T-70, Twin-70 raceways, Pan-Way® Fast-Snap™ Boxes and Pan-Pole™ Aluminum Outlet Poles.

A.  
System  
Overview

B1.  
Cable Ties

B2.  
Cable  
Accessories

B3.  
Stainless  
Steel Ties

C1.  
Wiring  
Duct

C2.  
Surface  
Raceway

C3.  
Abrasion  
Protection

C4.  
Cable  
Management

D1.  
Terminals

D2.  
Power  
Connectors

D3.  
Grounding  
Connectors

E1.  
Labeling  
Systems

E2.  
Labels

E3.  
Pre-Printed  
& Write-On  
Markers

E4.  
Permanent  
Identification

E5.  
Lockout/  
Tagout  
& Safety  
Solutions

F.  
Index



A. System Overview



## Pan-Way® Fast-Snap™ Surface Mount Outlet Boxes

B1. Cable Ties

- JB1FS and JBP2FS assemble without the use of screws for faster installation
- JB1FS and JBP2FS are supplied with adhesive backing to speed installation

- JB1FS and JBP2FS accept Pan-Way® Snap-on Faceplates for superior aesthetics

B2. Cable Accessories



JB1FS\*\*-A



JBP1FS\*\*

B3. Stainless Steel Ties

C1. Wiring Duct



JBP2FS\*\*

C2. Surface Raceway

C3. Abrasion Protection

C4. Cable Management



## Pan-Way® Classic Series Snap-On Faceplates for Use with Panduit® Mini-Com® Modules

- Can be used with Pan-Way® Cove, TG-70, T-70, Twin-70, T-45 Raceway Systems, Fast-Snap™ Outlet Boxes and Pan-Pole™ Aluminum Outlet Pole

D1. Terminals



T70FH2



T70FH4

D2. Power Connectors

D3. Grounding Connectors



T70FV2



T70FV4

E1. Labeling Systems

E2. Labels

E3. Pre-Printed & Write-On Markers

E4. Permanent Identification

E5. Lockout/Tagout & Safety Solutions

F. Index

| Part Number      | Part Description  | Color‡    | Std. Pkg. Qty. | Std. Ctn. Qty. |
|------------------|---|-----------|----------------|----------------|
| <b>JB1FSIW-A</b> | Single gang two-piece snap together outlet box with adhesive backing. Box accepts Pan-Way® Snap-On Faceplates. For use with Pan-Way® T-45 or LD profile raceway. 5.00"L x 3.26"W x 1.62"H (127.1mm x 82.7mm x 41.1mm). Breakouts for 1/2", 3/4", or 1" diameter conduit.        | Off White | 1              | 10             |
| <b>JBP1FSIW</b>  | Single gang power rated two-piece snap together outlet box. Box accepts Pan-Way® Snap-On Faceplates. For use with Pan-Way® T-45 or LD, LDP, LDPH, LDS profile raceways. 5.00"L x 3.26"W x 1.62"H (127.1mm x 82.7mm x 41.1mm). Breakouts for 1/2", 3/4", or 1" diameter conduit. | Off White | 1              | 10             |
| <b>JBP2FSIW</b>  | Double gang power rated two-piece snap together outlet box. Box accepts Pan-Way® Snap-On Faceplates. For use with Pan-Way® T-45 or LD profile raceway. 5.00"L x 6.14"W x 1.62"H (127.1mm x 155.9mm x 41.1mm). Breakouts for 1/2", 3/4", or 1" diameter conduit.                 | Off White | 1              | 10             |

‡For other colors replace IW (Off White) with EI (Electric Ivory), IG (International Gray), or WH (White). For complete labeling solutions and product information, reference chart below.



| Part Number     | Part Description   | Color‡    | Std. Pkg. Qty. | Std. Ctn. Qty. |
|-----------------|--|-----------|----------------|----------------|
| <b>T70FH2IW</b> | Snap-on horizontal sloped communication faceplate. Accepts two Panduit® Mini-Com® Modules (not included). No additional mounting hardware required.  | Off White | 1              | 10             |
| <b>T70FH4IW</b> | Snap-on horizontal sloped communication faceplate. Accepts four Panduit® Mini-Com® Modules (not included). No additional mounting hardware required. | Off White | 1              | 10             |
| <b>T70FV2IW</b> | Snap-on vertical sloped communication faceplate. Accepts two Panduit® Mini-Com® Modules (not included). No additional mounting hardware required.    | Off White | 1              | 10             |
| <b>T70FV4IW</b> | Snap-on vertical sloped communication faceplate. Accepts four Panduit® Mini-Com® Modules (not included). No additional mounting hardware required.   | Off White | 1              | 10             |

‡For other colors replace IW (Off White) with EI (Electric Ivory), IG (International Gray), or WH (White). For complete labeling solutions and product information, reference chart below.

## Component Labels for Pan-Way® Classic Series Snap-On Faceplates for Use with Panduit® Mini-Com® Modules and Inserts

### Suggested Label Solutions for TIA/EIA-606-A Compliance

| Faceplate Part Number | Laser/Ink Jet Desktop Printer Label | TDP43MY Thermal Transfer Desktop Printer Label | PanTher™ LS8E Hand-Held Printer Label | Cougar™ LS9 Hand-Held Printer Label |
|-----------------------|-------------------------------------|--|---------------------------------------|-------------------------------------|
| T70FH2IW              | C125X030FJJ                         | C125X030YPT                                    | C125X030FJC                           | T031X000FJC-BK                      |
| T70FV2IW              |                                     |  |                                       |                                     |
| T70FV4IW              |                                     |  |                                       |                                     |
| All T70B Parts        |                                     |  |                                       |                                     |
| T70FH4IW              | C252X030FJJ                         | C252X030YPT                                    | C252X030FJC                           | T031X000FJC-BK                      |





## Pan-Way® Classic Series Snap-On Faceplates for Use with Panduit® Mini-Com® Inserts

- Single gang vertical or horizontal sloped communication faceplates accept one or two Panduit® Mini-Com® Inserts
- Can be used with Pan-Way® Cove, TG-70, T-70, Twin-70, T-45 Raceway Systems, Fast-Snap™ Outlet Boxes and Pan-Pole™ Aluminum Outlet Pole



T70BH1



T70BH2



T70B1



T70B2

| Part Number     | Part Description  | Color‡    | Std. Pkg. Qty. | Std. Ctn. Qty. |
|-----------------|---|-----------|----------------|----------------|
| <b>T70BH1IW</b> | Snap-on horizontal communication faceplate. Accepts one 1/2-size Panduit® Mini-Com® Insert and two modules. No additional mounting hardware required.   | Off White | 1              | 10             |
| <b>T70BH2IW</b> | Snap-on horizontal communication faceplate. Accepts two 1/2-size Panduit® Mini-Com® Inserts and four modules. No additional mounting hardware required. | Off White | 1              | 10             |
| <b>T70B1IW</b>  | Snap-on vertical communication faceplate. Holds one 1/2-size Panduit® Mini-Com® Insert and two modules. No additional mounting hardware required.       | Off White | 1              | 10             |
| <b>T70B2IW</b>  | Snap-on vertical communication faceplate. Holds two 1/2-size Panduit® Mini-Com® Inserts and four modules. No additional mounting hardware required.     | Off White | 1              | 10             |

‡For other colors replace IW (Off White) with EI (Electric Ivory), IG (International Gray), or WH (White). For complete labeling solutions and product information, reference chart on previous page.



## Pan-Way® Classic Series Snap-On Faceplates for Communication/Power

- Can be used with Pan-Way® Cove, TG-70, T-70, Twin-70, T-45 Raceway Systems, Fast-Snap™ Outlet Boxes and Pan-Pole™ Aluminum Outlet Pole



T70P



T70PG



T70PS



T70PGS



T70PN

| Part Number     | Part Description  | Color‡    | Std. Pkg. Qty. | Std. Ctn. Qty. |
|-----------------|---|-----------|----------------|----------------|
| <b>T70PIW</b>   | Snap-on single gang 106 duplex electrical/communication faceplate. Used to cover one NEMA standard 106 duplex electrical outlet. In communication applications, covers one standard 106 duplex communication module frame.  | Off White | 1              | 10             |
| <b>T70PGIW</b>  | Snap-on single gang rectangular electrical/communication faceplate. Used to cover one NEMA standard rectangular electrical outlet. In communication applications, covers one standard rectangular communication module frame.   | Off White | 1              | 10             |
| <b>T70PSIW</b>  | Snap-on single gang 106 duplex communication faceplate. Used to cover one NEMA standard 106 duplex communication module frame. Module frame screw mounts directly to underside of snap-on faceplate. No mounting device needed. Supplied with one mounting screw. Note: Not for use with electrical devices.    | Off White | 1              | 10             |
| <b>T70PGSIW</b> | Snap-on single gang rectangular communication faceplate. Used to cover one NEMA standard rectangular communication module frame. Module frame screw mounts directly to underside of snap-on faceplate. No mounting device needed. Supplied with two mounting screws. Note: Not for use with electrical devices. | Off White | 1              | 10             |
| <b>T70PNIW</b>  | Snap-on single gang blank cover faceplate.  | Off White | 1              | 10             |

‡For other colors replace IW (Off White) with EI (Electric Ivory), IG (International Gray), or WH (White). Component Labels for Pan-Way® Classic Series Snap-On Faceplates for Communication and Power, please reference pg. C2.59.

A. System Overview

B1. Cable Ties

B2. Cable Accessories

B3. Stainless Steel Ties

C1. Wiring Duct

C2. Surface Raceway

C3. Abrasion Protection

C4. Cable Management

D1. Terminals

D2. Power Connectors

D3. Grounding Connectors

E1. Labeling Systems

E2. Labels

E3. Pre-Printed & Write-On Markers

E4. Permanent Identification

E5. Lockout/Tagout & Safety Solutions

F. Index

A. System Overview  
 B1. Cable Ties  
 B2. Cable Accessories  
 B3. Stainless Steel Ties  
 C1. Wiring Duct  
 C2. Surface Raceway  
 C3. Abrasion Protection  
 C4. Cable Management  
 D1. Terminals  
 D2. Power Connectors  
 D3. Grounding Connectors  
 E1. Labeling Systems  
 E2. Labels  
 E3. Pre-Printed & Write-On Markers  
 E4. Permanent Identification  
 E5. Lockout/Tagout & Safety Solutions  
 F. Index



## Panduit® NetKey® Snap-On Sloped Keystone Faceplates

- Accept all Panduit® NetKey® Keystone Copper Modules and Duplex Fiber Optic Modules
- Snap into raceway channel, requires no additional mounting hardware or adapters – greatly reducing installation time
- Lowest cost for moves, adds, and changes
- Tamper resistant
- Can be used with Pan-Way® Cove, TG-70, T70, Twin-70, T-45 Raceway Systems, Fast-Snap™ Outlet Boxes, and Pan-Pole™ Aluminum Outlet Poles



NK2HSRF

NK4HSRF



NK4VSRF

| Part Number      | Part Description  | Color‡    | Std. Pkg. Qty. | Std. Ctn. Qty. |
|------------------|---|-----------|----------------|----------------|
| <b>NK2HSRFIW</b> | Snap-on 2-position sloped horizontal faceplate accepts any Panduit® NetKey® Module. Compatible with Panduit® NetKey® Outlet Boxes, Surface Raceway Systems, and Pan-Pole™ Outlet Poles. | Off White | 1              | 10             |
| <b>NK4HSRFIW</b> | Snap-on 4-position sloped horizontal faceplate accepts any Panduit® NetKey® Module. Compatible with Panduit® NetKey® Outlet Boxes, Surface Raceway Systems, and Pan-Pole™ Outlet Poles. | Off White | 1              | 10             |
| <b>NK4VSRFIW</b> | Snap-on 4-position sloped vertical faceplate accepts any Panduit® NetKey® Module. Compatible with Panduit® NetKey® Outlet Boxes, Surface Raceway Systems, and Pan-Pole™ Outlet Poles.   | Off White | 1              | 10             |

Panduit® NetKey® faceplates are NOT compatible with Panduit® Mini-Com® Modules.  
 ‡For other colors replace IW (Off White) with EI (Electric Ivory), IG (International Gray), or WH (White).  
 For complete labeling solutions, reference chart below.



## Panduit® NetKey® Snap-On Flush Universal Keystone Faceplates

- Wider module spacing to accept common manufacturers' keystone modules .900 inches wide or less
- Can be used with Pan-Way® Cove, TG-70, T70, Twin-70, T-45 Raceway Systems, Fast-Snap™ Outlet Boxes, and Pan-Pole™ Aluminum Outlet Poles



T70KW2

T70KW4

| Part Number     | Part Description  | Color‡    | Std. Pkg. Qty. | Std. Ctn. Qty. |
|-----------------|---|-----------|----------------|----------------|
| <b>T70KW2IW</b> | Snap-on 2-position flush mount faceplate accepts any Panduit® NetKey® Module and most other manufacturers' keystone modules. Compatible with Panduit® Fast-Snap™ Outlet Boxes, Surface Raceway Systems, and Pan-Pole™ Outlet Poles. | Off White | 1              | 10             |
| <b>T70KW4IW</b> | Snap-on 4-position flush mount faceplate accepts any Panduit® NetKey® Module and most other manufacturers' keystone modules. Compatible with Panduit® Fast-Snap™ Outlet Boxes, Surface Raceway Systems, and Pan-Pole™ Outlet Poles. | Off White | 1              | 10             |

Panduit® NetKey® faceplates are NOT compatible with Panduit® Mini-Com® Modules.  
 ‡For other colors replace IW (Off White) with EI (Electric Ivory), IG (International Gray), or WH (White).  
 For complete labeling solutions, reference chart below.

### Component Labels for Snap-On “Sloped” (Keystone) Faceplates and Snap-On “Flush” Universal (Keystone) Faceplates

| Suggested Label Solutions for TIA/EIA-606-A Compliance |                                     |                                       |                                     |
|--|-------------------------------------|---------------------------------------|-------------------------------------|
| Faceplate Part Number                                  | Laser/Ink Jet Desktop Printer Label | PanTher™ LS8E Hand-Held Printer Label | Cougar™ LS9 Hand-Held Printer Label |
| NK2HSRFIW<br>T70KW2IW                                  | C125X030FJJ                         | C125X030FJC                           | T031X000FJC-BK                      |
| NK4VSRFIW  | 2-C125X030FJJ                       | 2-C125X030FJC                         |                                     |
| NK4HSRFIW<br>T70KW4IW                                  | C261X030FJJ                         | C125X030FJC                           |                                     |



## Pan-Way® Snap-On Faceplates for SYSTIMAX® Communication Modules

- Can be used with Pan-Way® Cove, TG-70, T70, Twin-70, T-45 Raceway Systems, Fast-Snap™ Outlet Boxes, and Pan-Pole™ Aluminum Outlet Poles



T70L2



T70L4



T70LV2



T70LV4

| Part Number     | Part Description   | Color‡    | Std. Pkg. Qty. | Std. Ctn. Qty. |
|-----------------|--|-----------|----------------|----------------|
| <b>T70L2IW</b>  | Snap-on horizontal communication faceplate designed to accept two SYSTIMAX® communication modules (not included). Can be used with Panduit surface raceway systems and boxes that accept 70mm faceplates. No additional mounting hardware required.  | Off White | 1              | 10             |
| <b>T70L4IW</b>  | Snap-on horizontal communication faceplate designed to accept four SYSTIMAX® communication modules (not included). Can be used with Panduit surface raceway systems and boxes that accept 70mm faceplates. No additional mounting hardware required. | Off White | 1              | 10             |
| <b>T70LV2IW</b> | Snap-on vertical communication faceplate designed to accept two SYSTIMAX® communication modules (not included). Can be used with Panduit surface raceway systems and boxes that accept 70mm faceplates. No additional mounting hardware required.    | Off White | 1              | 10             |
| <b>T70LV4IW</b> | Snap-on vertical communication faceplate designed to accept four SYSTIMAX® communication modules (not included). Can be used with Panduit surface raceway systems and boxes that accept 70mm faceplates. No additional mounting hardware required.   | Off White | 1              | 10             |

‡For other colors replace IW (Off White) with EI (Electric Ivory), IG (International Gray), or WH (White).  
 \*SYSTIMAX is a registered trademark of Commscope, Inc.  
 For complete labeling solutions, reference chart below.

### Component Labels for Pan-Way® Snap-On Faceplates for use with SYSTIMAX® Communication Modules

| Faceplate Part Number | Suggested Label Solutions for TIA/EIA-606-A Compliance |                                       |                                     |
|-----------------------|--|---------------------------------------|-------------------------------------|
|                       | Laser/Ink Jet Desktop Printer Label                    | PanTher™ LS8E Hand-Held Printer Label | Cougar™ LS9 Hand-Held Printer Label |
| T70L2IW<br>T70LV2IW   | C125X030FJJ  | C125X030FJC                           | T031X000FJC-BK                      |
| T70LV4IW              | 2-C125X030FJJ  | 2-C125X030FJC                         |                                     |
| T70L4IW               | C261X030FJJ  | C125X030FJC                           |                                     |

\*SYSTIMAX is a registered trademark of Commscope, Inc.

A. System Overview

B1. Cable Ties

B2. Cable Accessories

B3. Stainless Steel Ties

C1. Wiring Duct

C2. Surface Raceway

C3. Abrasion Protection

C4. Cable Management

D1. Terminals

D2. Power Connectors

D3. Grounding Connectors

E1. Labeling Systems

E2. Labels

E3. Pre-Printed & Write-On Markers

E4. Permanent Identification

E5. Lockout/Tagout & Safety Solutions

F. Index

A. System Overview



## Pan-Way® Snap-On Faceplates for Nordx/CDT\* Communication Modules

B1. Cable Ties

- Can be used with Pan-Way® Cove, TG-70, T70, Twin-70, T-45 Raceway Systems, Fast-Snap™ Outlet Boxes, and Pan-Pole™ Aluminum Outlet Poles

B2. Cable Accessories



T70N2

B3. Stainless Steel Ties



T70N4

C1. Wiring Duct

C2. Surface Raceway



T70NV2

C3. Abrasion Protection

C4. Cable Management



T70NV4

D1. Terminals

D2. Power Connectors

D3. Grounding Connectors

E1. Labeling Systems

E2. Labels

E3. Pre-Printed & Write-On Markers

E4. Permanent Identification

E5. Lockout/Tagout & Safety Solutions

F. Index

| Part Number     | Part Description  | Color‡    | Std. Pkg. Qty. | Std. Ctn. Qty. |
|-----------------|---|-----------|----------------|----------------|
| <b>T70N2IW</b>  | Snap-on horizontal communication faceplate designed to accept two Nordx/CDT* communication modules (not included). Can be used with Panduit surface raceway systems and boxes that accept 70mm faceplates. No additional mounting hardware required.  | Off White | 1              | 10             |
| <b>T70N4IW</b>  | Snap-on horizontal communication faceplate designed to accept four Nordx/CDT* communication modules (not included). Can be used with Panduit surface raceway systems and boxes that accept 70mm faceplates. No additional mounting hardware required. | Off White | 1              | 10             |
| <b>T70NV2IW</b> | Snap-on vertical communication faceplate designed to accept two Nordx/CDT* communication modules (not included). Can be used with Panduit surface raceway systems and boxes that accept 70mm faceplates. No additional mounting hardware required.    | Off White | 1              | 10             |
| <b>T70NV4IW</b> | Snap-on vertical communication faceplate designed to accept two Nordx/CDT* communication modules (not included). Can be used with Panduit surface raceway systems and boxes that accept 70mm faceplates. No additional mounting hardware required.    | Off White | 1              | 10             |

‡For other colors replace IW (Off White) with EI (Electric Ivory).

\*Nordx/CDT is a registered trademark of Nordx/CDT, Inc.

For complete labeling solutions, reference chart below.

### Component Labels for Pan-Way® Snap-On Faceplates for use with Nordx/CDT\* Communication Modules

| Suggested Label Solutions for TIA/EIA-606-A Compliance |                                     |                                       |                                     |
|--|-------------------------------------|---------------------------------------|-------------------------------------|
| Faceplate Part Number                                  | Laser/Ink Jet Desktop Printer Label | PanTher™ LS8E Hand-Held Printer Label | Cougar™ LS9 Hand-Held Printer Label |
| T70N2IW<br>T70NV2IW                                    | C125X030FJJ                         | C125X030FJC                           | T031X000FJC-BK                      |
| T70NV4IW   | 2-C125X030FJJ                       | 2-C125X030FJC                         |                                     |
| T70N4IW  | C261X030FJJ                         | C125X030FJC                           |                                     |

\*Nordx/CDT is a registered trademark of Nordx/CDT, Inc.

For complete labeling solutions, reference charts on pages E2.4 and E2.5.



## Pan-Way® Low Voltage Surface Mount Outlet Boxes

- JBX3510 assembles without the use of screws for faster installation
- JB1 and JB1D are a one-piece design requiring no assembly
- JBX3510, JB1, and JB1D are supplied with adhesive backing to speed installation

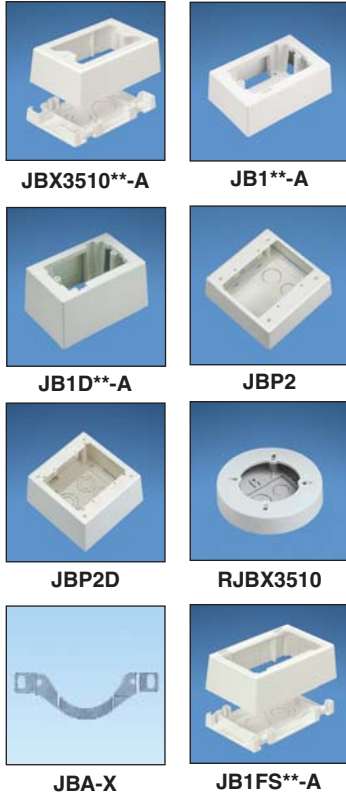

| Part Number        | Part Description  | Color‡    | Std. Pkg. Qty. | Std. Ctn. Qty. |
|--------------------|---|-----------|----------------|----------------|
| <b>JBX3510IW-A</b> | Single gang two-piece snap together outlet box with adhesive backing. Box accepts Pan-Way® Screw-On Faceplates or any NEMA standard single gang faceplate. For use with Pan-Way® T45 or LD profile raceway. 5.00"L x 3.26"W x 1.62"H (127.1mm x 82.7mm x 41.1mm). Breakouts for 1/2", 3/4", or 1" diameter conduit. | Off White | 1              | 10             |
| <b>JB1IW-A</b>     | Single gang one-piece outlet box with adhesive backing. Box accepts Pan-Way® Screw-On Faceplates or any NEMA standard single gang faceplate. For use with Pan-Way® LD profile raceway. 5.09"L x 3.34"W x 1.75"H (129.4mm x 85.0mm x 44.4mm). Breakouts for 1/2", 3/4", or 1" diameter conduit.                      | Off White | 1              | 10             |
| <b>JB1DIW-A</b>    | Single gang one-piece deep outlet box with adhesive backing. Box accepts Pan-Way® Screw-On Faceplates or any NEMA standard single gang faceplate. For use with Pan-Way® LD profile raceway. 5.23"L x 3.48"W x 2.75"H (133.0mm x 88.5mm x 69.8mm). Breakouts for 1/2", 3/4", or 1" diameter conduit.                 | Off White | 1              | 10             |
| <b>JBP2IW</b>      | Double gang two-piece screw together outlet box. Box accepts Pan-Way® Screw-On Faceplates or any NEMA standard double gang faceplates. For use with Pan-Way® LD profile raceway. 5.05"L x 5.05"W x 1.62"H (128.2mm x 128.2mm x 41.1mm). Breakouts for 1/2" or 3/4" diameter conduit.                                | Off White | 1              | 10             |
| <b>JBP2DIW</b>     | Double gang two-piece screw together deep outlet box. Box accepts Pan-Way® Screw-On Faceplates or any NEMA standard double gang faceplate. For use with Pan-Way® T-45 or LD profile raceway. 5.19"L x 5.19"W x 2.75"H (131.9mm x 131.9mm x 69.8mm). Breakouts for 1/2", 3/4", or 1" diameter conduit.               | Off White | 1              | 10             |
| <b>RJBX3510IW</b>  | Single gang two-piece screw together round outlet box. Box accepts UL/CSA devices not to exceed 10 lbs. (5 lbs. per CSA). For use with Pan-Way® LD profile raceway. Dia. = 5.48"D x 1.14"H (139.2mm x 29.0mm). Breakouts for 3/4" or 1" diameter conduit.   | Off White | 1              | 5              |
| <b>JBA-X</b>       | In-wall box adapter. Adapts single gang surface mount outlet boxes to in-wall conduit boxes.  | —         | 10             | 100            |
| <b>JB1FSIW-A</b>   | Single gang two-piece snap together outlet box with adhesive backing. Box accepts Pan-Way® Snap-On Faceplates. For use with Pan-Way® T-45 or LD profile raceway. 5.00"L x 3.26"W x 1.62"H (127.1mm x 82.7mm x 41.1mm). Breakouts for 1/2", 3/4", or 1" diameter conduit.  | Off White | 1              | 10             |

‡For other colors replace IW (Off White) with EI (Electric Ivory), IG (International Gray), or WH (White).

A.  
System  
Overview

B1.  
Cable Ties

B2.  
Cable  
Accessories

B3.  
Stainless  
Steel Ties

C1.  
Wiring  
Duct

C2.  
Surface  
Raceway

C3.  
Abrasion  
Protection

C4.  
Cable  
Management

D1.  
Terminals

D2.  
Power  
Connectors

D3.  
Grounding  
Connectors

E1.  
Labeling  
Systems

E2.  
Labels

E3.  
Pre-Printed  
& Write-On  
Markers

E4.  
Permanent  
Identification

E5.  
Lockout/  
Tagout  
& Safety  
Solutions

F.  
Index



A. System Overview



## Pan-Way® Power Rated Surface Mount Outlet Boxes

B1. Cable Ties

- JBP1FS and JBP2FS assemble without the use of screws for faster installation
- JBP1FS and JBP2FS are supplied with adhesive backing to speed installation
- JBP1FS and JBP2FS accept Pan-Way® Snap-on Faceplates for superior aesthetics

B2. Cable Accessories

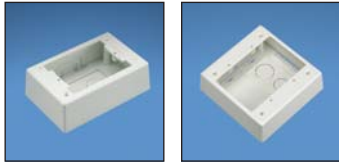

JBP1

JBP2

B3. Stainless Steel Ties

C1. Wiring Duct

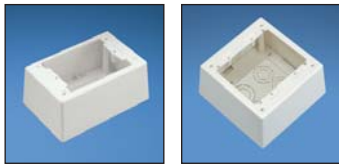

JBP1D

JBP2D

C2. Surface Raceway

C3. Abrasion Protection



JBP1E

JBP1I

C4. Cable Management

D1. Terminals

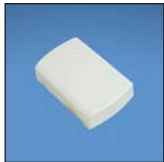

PSJBX

D2. Power Connectors

D3. Grounding Connectors

E1. Labeling Systems

E2. Labels

E3. Pre-Printed & Write-On Markers

E4. Permanent Identification

E5. Lockout/Tagout & Safety Solutions

F. Index

| Part Number    | Part Description  | Color‡    | Std. Pkg. Qty. | Std. Ctn. Qty. |
|----------------|---|-----------|----------------|----------------|
| <b>JBP1IW</b>  | Single gang two-piece screw together outlet box. Box accepts Pan-Way® Screw-On Faceplates or any NEMA standard single gang faceplate. For use with Pan-Way® LD profile raceway. 5.19"L x 3.45"W x 1.75"H (131.9mm x 87.7mm x 44.4mm). Breakouts for 1/2", 3/4", or 1" diameter conduit.   | Off White | 1              | 10             |
| <b>JBP2IW</b>  | Double gang two-piece screw together outlet box. Box accepts Pan-Way® Screw-On Faceplates or any NEMA standard double gang faceplates. For use with Pan-Way® LD profile raceway. 5.05"L x 5.05"W x 1.62"H (128.2mm x 128.2mm x 41.1mm). Breakouts for 1/2" or 3/4" diameter conduit.  | Off White | 1              | 10             |
| <b>JBP1DIW</b> | Single gang two-piece screw together deep outlet box. Box accepts Pan-Way® Screw-On Faceplates or any NEMA standard single gang faceplate. For use with Pan-Way® T-45, LD2P10 (when used with JBD1), or LD profile raceway. 5.19"L x 3.45"W x 2.75"H (131.9mm x 87.7mm x 69.8mm). Breakouts for 1/2", 3/4", or 1" diameter conduit. | Off White | 1              | 10             |
| <b>JBP2DIW</b> | Double gang two-piece screw together deep outlet box. Box accepts Pan-Way® Screw-On Faceplates or any NEMA standard double gang faceplate. For use with Pan-Way® T-45 or LD profile raceway. 5.19"L x 5.19"W x 2.75"H (131.9mm x 131.9mm x 69.8mm). Breakouts for 1/2", 3/4", or 1" diameter conduit.                               | Off White | 1              | 10             |
| <b>JBP1EIW</b> | Single gang two-piece screw together extension outlet box. Box accepts Pan-Way® Screw-On Faceplates or any NEMA standard single gang faceplate. For use with Pan-Way® LD profile raceway. 4.99"L x 3.30"W x 1.00"H (126.7mm x 83.8mm x 25.4mm). Breakouts for 1/2", 3/4", or 1" diameter conduit.                                   | Off White | 1              | 10             |
| <b>JBP1IIW</b> | Single gang two-piece screw together intermediate outlet box. Box accepts Pan-Way® Screw-On Faceplates or any NEMA standard single gang faceplate. For use with Pan-Way® LD profile raceway. 5.12"L x 3.38"W x 2.27"H (130.2mm x 86.0mm x 57.7mm). Breakouts for 1/2" or 3/4" diameter conduit.                                     | Off White | 1              | 10             |
| <b>PSJBXIW</b> | Single gang two-piece snap together power source box. For use with Pan-Way® LDPH3, 5, 10, or LDS3, or 5 profile raceway. 5.02"L x 3.32"W x 1.31"H (127.6mm x 83.0mm x 33.3mm). Breakouts for 1/2", 3/4", or 1" diameter conduit.  | Off White | 1              | 10             |

‡For other colors replace IW (Off White) with EI (Electric Ivory), IG (International Gray), or WH (White).





## Pan-Way® Power Rated Surface Mount Outlet Boxes (continued)



JBD1



JBP2S



JBD2



JBP1FS



JBP2FS



JBP1MR20



JBP1MD20



RJBX3510

| Part Number       | Part Description  | Color‡    | Std. Pkg. Qty. | Std. Ctn. Qty. |
|-------------------|---|-----------|----------------|----------------|
| <b>JBD1</b>       | Single gang pass-through divider. Allows power and communication outlets to be routed in series. For use with JBP1 or JBP1D when installing LD2P10 raceway.   | Off White | 1              | 10             |
| <b>JBP2SIW</b>    | Double gang two-piece screw together divided outlet box. Box accepts Pan-Way® Screw-On Faceplates or any NEMA standard double gang faceplate. For use with Pan-Way® T-45 or LD profile raceway. 5.05"L x 5.05"W x 1.62"H (128.2mm x 128.2mm x 41.1mm). Breakouts for 1/2" or 3/4" diameter conduit. | Off White | 1              | 10             |
| <b>JBD2</b>       | Double gang pass-through divider. Allows power and communication outlets to be routed in series. For use with JBP2D when installing LD2P10 raceway.   | Off White | 1              | 10             |
| <b>JBP1FSIW</b>   | Single gang power rated two-piece snap together outlet box. Box accepts Pan-Way® Snap-On Faceplates. For use with Pan-Way® T-45 or LD, LDP, LDPH, LDS profile raceways. 5.00"L x 3.26"W x 1.62"H (127.1mm x 82.7mm x 41.1mm). Breakouts for 1/2", 3/4", or 1" diameter conduit.                     | Off White | 1              | 10             |
| <b>JBP2FSIW</b>   | Double gang power rated two-piece snap together outlet box. Box accepts Pan-Way® Snap-On Faceplates. For use with Pan-Way® T-45 or LD profile raceway. 5.00"L x 6.14"W x 1.62"H (127.1mm x 155.9mm x 41.1mm). Breakouts for 1/2", 3/4", or 1" diameter conduit.                                     | Off White | 1              | 10             |
| <b>JBP1MR20IW</b> | Single gang two-piece power rated low profile snap together outlet box. Includes 20A U.S. style rectangular electrical outlet. For use with Pan-Way® LDPH3, 5, 10 or LDS3 or 5 profile raceway only. 4.84"L x 2.90"W x 1.20"H (122.9mm x 73.6mm x 30.4mm).  | Off White | 1              | 10             |
| <b>JBP1MD20IW</b> | Single gang two-piece power rated low profile snap together outlet box. Includes 20A U.S. style 106 duplex electrical outlet. For use with Pan-Way® LDPH3, 5, 10 or LDS3 or 5 profile raceway only. 4.84"L x 2.90"W x 1.22"H (122.9mm x 73.6mm x 30.9mm).   | Off White | 1              | 10             |
| <b>RJBX3510IW</b> | Single gang two-piece screw together round outlet box. Box accepts UL/CSA devices not to exceed 10lbs. (5lbs. per CSA). For use with Pan-Way® LD profile raceway. Dia. = 5.48"D x 1.14"H (139.2mm x 29.0mm). Breakouts for 3/4" or 1" diameter conduit.   | Off White | 1              | 5              |

‡For other colors replace IW (Off White) with EI (Electric Ivory), IG (International Gray), or WH (White).

A.  
System  
Overview

B1.  
Cable Ties

B2.  
Cable  
Accessories

B3.  
Stainless  
Steel Ties

C1.  
Wiring  
Duct

C2.  
Surface  
Raceway

C3.  
Abrasion  
Protection

C4.  
Cable  
Management

D1.  
Terminals

D2.  
Power  
Connectors

D3.  
Grounding  
Connectors

E1.  
Labeling  
Systems

E2.  
Labels

E3.  
Pre-Printed  
& Write-On  
Markers

E4.  
Permanent  
Identification

E5.  
Lockout/  
Tagout  
& Safety  
Solutions

F.  
Index

A. System Overview



## Pan-Way® Classic Series Faceplates for Power and Communication Applications

B1. Cable Ties

- For use with JBP2S or JBP2D outlet boxes

B2. Cable Accessories



FP2DC



FP2RC

B3. Stainless Steel Ties

C1. Wiring Duct



CP106



CP106\*\*-2G

C2. Surface Raceway

C3. Abrasion Protection



CPG



CPG\*\*-2G

C4. Cable Management

D1. Terminals



CPN



CPN\*\*-2G

D2. Power Connectors

D3. Grounding Connectors

E1. Labeling Systems

E2. Labels

E3. Pre-Printed & Write-On Markers

E4. Permanent Identification

E5. Lockout/Tagout & Safety Solutions

F. Index

| Part Number       | Part Description   | Color‡    | Std. Pkg. Qty. | Std. Ctn. Qty. |
|-------------------|--|-----------|----------------|----------------|
| <b>FP2DCIW</b>    | Covers one NEMA standard 106 duplex electrical receptacle and accepts Panduit® Mini-Com® 1/2-size, 1/3-size, and 2/3-size Inserts. For product application, please reference LD profile raceway section.               | Off White | 1              | 10             |
| <b>FP2RCIW</b>    | Covers one NEMA standard rectangular electrical receptacle and accepts Panduit® Mini-Com® 1/2-size, 1/3-size, and 2/3-size Inserts. For product application, please reference LD profile raceway section.              | Off White | 1              | 10             |
| <b>CP106IW</b>    | Screw-on single gang 106 duplex faceplate. Covers one NEMA standard 106 duplex electrical outlet or one standard 106 communication module frame.   | Off White | 1              | 10             |
| <b>CP106IW-2G</b> | Screw-on double gang 106 duplex faceplate. Covers two NEMA standard 106 duplex electrical outlets or two standard 106 communication module frames.   | Off White | 1              | 10             |
| <b>CPGIW</b>      | Screw-on single gang rectangular faceplate. Covers one NEMA standard rectangular electrical outlet or one standard rectangular communication module frame.   | Off White | 1              | 10             |
| <b>CPGIW-2G</b>   | Screw-on double gang rectangular faceplate. Covers two NEMA standard rectangular electrical outlets or two standard rectangular communication module frames.   | Off White | 1              | 10             |
| <b>CPNIW</b>      | Screw-on single gang blank cover faceplate. Can be used with Pan-Way® Cove, TG-70, T-70, Twin-70, T-45 Raceway Systems, Fast-Snap™ Outlet Boxes and Pan-Pole™ Aluminum Outlet Pole. Supplied with two mounting screws. | Off White | 1              | 10             |
| <b>CPNIW-2G</b>   | Screw-on double gang blank cover faceplate. For use with Pan-Way® Surface Mount Outlet Boxes. Supplied with four mounting screws.  | Off White | 1              | 10             |

‡For other colors replace suffix IW (Off White) with EI (Electric Ivory), IG (International Gray), WH (White), or AL (Almond).

All faceplates supplied with mounting screws.

For complete labeling solutions, reference label chart below.

### Component Labels for Pan-Way® Classic Series Faceplates for Power and Communication Applications

| Faceplate Part Number | Suggested Label Solutions for TIA/EIA-606-A Compliance |  |                                       |                                     |
|-----------------------|--|--|---------------------------------------|-------------------------------------|
|                       | Laser/Ink Jet Desktop Printer Label                    | TDP43MY Thermal Transfer Desktop Printer Label | PanTher™ LS8E Hand-Held Printer Label | Cougar™ LS9 Hand-Held Printer Label |
| <b>CPGIW T70PGS</b>   | C125X030FJJ  | C125X030YPT                                    | C125X030FJC                           | T031X000FJC-BK                      |
| <b>CPGIW-2G FP2RC</b> | 2-C125X030FJJ  | 2-C125X030YPT                                  | 2-C125X030FJC                         | T031X000FJC-BK                      |
| <b>T70PG</b>          | C261X030FJJ  | T031X000FJT                                    | C261X030FJC                           | T031X000FJC-BK                      |

**UL LISTED SP® Pan-Way® Stainless Steel Faceplates**



WPS-20

WPS-202

| Part Number    | Part Description   | Std. Pkg. Qty. | Std. Ctn. Qty. |
|----------------|--|----------------|----------------|
| <b>WPS-20</b>  | Stainless steel single gang 106 duplex screw-on faceplate. Covers one NEMA standard 106 duplex electrical outlet or one standard 106 communication module frame.   | 1              | 10             |
| <b>WPS-202</b> | Stainless steel double gang 106 duplex screw-on faceplate. Covers two NEMA standard 106 duplex electrical outlets or two standard 106 communication module frames. | 1              | 10             |

All faceplates supplied with mounting screws.

**UL LISTED Pan-Way® Electrical Outlets**

- Electrical outlets are standard electrical devices that fit into Pan-Way® Outlet Boxes or any NEMA standard outlet boxes



EDU20

ERU20

ETU20

EGU20

| Part Number      | Part Description   | Color‡    | Std. Pkg. Qty. |
|------------------|--|-----------|----------------|
| <b>EDU20IW-X</b> | 20 A specification grade 106 duplex outlet.  | Off White | 10             |
| <b>ERU20IW-X</b> | 20 A specification grade rectangular outlet.   | Off White | 10             |
| <b>ETU20IW-X</b> | 20 A specification grade TVSS rectangular outlet (transient voltage surge suppressor). | Off White | 10             |
| <b>EGU20IW-X</b> | 20 A specification grade GFCI rectangular outlet (ground fault circuit interrupter).   | Off White | 10             |

‡For other colors, replace IW (Off White) with EI (Electric Ivory).  
All outlets supplied with mounting screws.

**UL SA LISTED SP® Pan-Way® Surface Mount Outlet Box with 20 A Electrical Outlet**

- Supplied with a 20 A U.S. style rectangular electrical outlet and a 20 A 106 duplex electrical outlet.



JBP1MR20



JBP1MD20

| Part Number       | Part Description  | Color‡    | Std. Pkg. Qty. | Std. Ctn. Qty. |
|-------------------|---|-----------|----------------|----------------|
| <b>JBP1MR20IW</b> | Single gang two-piece power rated low profile snap together outlet box. Includes 20 A U.S. style rectangular electrical outlet. For use with Pan-Way® LDPH3, 5, 10 or LDS3 or 5 profile raceway only. 4.84"L x 2.90"W x 1.20"H (122.9mm x 73.6mm x 30.4mm). | Off White | 1              | 10             |
| <b>JBP1MD20IW</b> | Single gang two-piece power rated low profile snap together outlet box. Includes 20 A U.S. style 106 duplex electrical outlet. For use with Pan-Way® LDPH3, 5, 10 or LDS3 or 5 profile raceway only. 4.84"L x 2.90"W x 1.22"H (122.9mm x 73.6mm x 30.9mm).  | Off White | 1              | 10             |

‡For other color replace IW (Off White) with EI (Electric Ivory).

A.  
System  
Overview

B1.  
Cable Ties

B2.  
Cable  
Accessories

B3.  
Stainless  
Steel Ties

C1.  
Wiring  
Duct

C2.  
Surface  
Raceway

C3.  
Abrasion  
Protection

C4.  
Cable  
Management

D1.  
Terminals

D2.  
Power  
Connectors

D3.  
Grounding  
Connectors

E1.  
Labeling  
Systems

E2.  
Labels

E3.  
Pre-Printed  
& Write-On  
Markers

E4.  
Permanent  
Identification

E5.  
Lockout/  
Tagout  
& Safety  
Solutions

F.  
Index

## Selection Chart for using Pan-Way® Surface Raceway with Pan-Way® Surface Mount Outlet Boxes

How to use this chart:

1. Locate the desired Pan-Way® Raceway in the left column.
2. Locate the desired Pan-Way® Outlet Box in the top row.
3. Match up the raceway with the outlet box to see if they are compatible (Y = yes, N = no).
4. Select correct surface mount outlet box.

| Pan-Way® Surface Mount Outlet Boxes                     |                                    |      |       |          |               |                          |                      |       |   |
|---|------------------------------------|------|-------|----------|---------------|--------------------------|----------------------|-------|---|
| Low Voltage or Fiber Optic ONLY                         | Power, Low Voltage, or Fiber Optic |      |       |          |               |                          |                      |       |   |
| JB1, JB1D<br>JB1FS<br>JBX3510                           | RJBX3510                           | JBP1 | JBP1D | JBP1E    | JBP1I<br>JBP2 | JBP2S<br>JBP2D<br>JBP2FS | JBP1MR20<br>JBP1MD20 | PSJBX |   |
| <b>Type LD (Low Voltage, or Fiber Optic ONLY)</b>       |                                    |      |       |          |               |                          |                      |       |   |
| LD3   | Y                                  | Y    | Y     | Y        | Y             | Y                        | Y                    | N     | Y |
| LD5   | Y                                  | Y    | Y     | Y        | Y             | Y                        | Y                    | N     | Y |
| LD10  | Y                                  | Y    | Y     | Y        | Y             | Y                        | Y                    | N     | Y |
| <b>Type LDPH (Power, Low Voltage, or Fiber Optic)</b>   |                                    |      |       |          |               |                          |                      |       |   |
| LDPH3   | Y                                  | Y    | Y     | Y        | Y             | Y                        | Y                    | Y     | Y |
| LDPH5   | Y                                  | Y    | Y     | Y        | Y             | Y                        | Y                    | Y     | Y |
| LDPH10  | Y                                  | Y    | Y     | Y        | Y             | Y                        | Y                    | Y     | Y |
| <b>Type LDS (Power, Low Voltage, or Fiber Optic)</b>    |                                    |      |       |          |               |                          |                      |       |   |
| LDS3  | Y                                  | Y    | Y     | Y        | Y             | Y                        | Y                    | Y     | Y |
| LDS5  | Y                                  | Y    | Y     | Y        | Y             | Y                        | Y                    | Y     | Y |
| <b>Type LD2P10 (Power, Low Voltage, or Fiber Optic)</b> |                                    |      |       |          |               |                          |                      |       |   |
| LD2P10  | N                                  | N    | N     | Y w/JBD1 | N             | N                        | Y                    | N     | N |
| <b>Type T-45 (Power, Low Voltage, or Fiber Optic)</b>   |                                    |      |       |          |               |                          |                      |       |   |
| T-45  | Y (JB1FS and JBX3510)              | N    | N     | Y        | N             | N                        | Y                    | N     | N |

## PAN-WAY® LD PROFILE NON-METALLIC SURFACE RACEWAY



Pan-Way® LD Profile Raceway is available in single and multi-channel styles to provide a solution for routing copper, fiber optic, and power cabling along fixed perimeter walls.

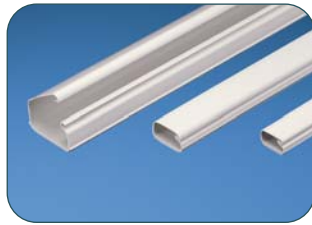

Pan-Way® LD Profile Raceways include a full complement of fittings for standard, bend radius control, power rated and multi-channel use, and transition easily to other Panduit raceway such as Cove, TG-70, T-70, Twin-70 and T-45.

- LD2P10 features one-piece multi-channel design for both power and data applications
- LDPH is a tamper resistant two-piece latching surface raceway supplied with pre-applied adhesive backed tape
- LD features one-piece single channel design for data routing
- LDS features one-piece single channel tamper resistant design with maximum security for power OR data applications

A.  
System  
Overview

B1.  
Cable Ties

B2.  
Cable  
Accessories

B3.  
Stainless  
Steel Ties

C1.  
Wiring  
Duct

C2.  
Surface  
Raceway

C3.  
Abrasion  
Protection

C4.  
Cable  
Management

D1.  
Terminals

D2.  
Power  
Connectors

D3.  
Grounding  
Connectors

E1.  
Labeling  
Systems

E2.  
Labels

E3.  
Pre-Printed  
& Write-On  
Markers

E4.  
Permanent  
Identification

E5.  
Lockout/  
Tagout  
& Safety  
Solutions

F.  
Index



A.  
System  
Overview

## LD2P10 Profile Raceway Roadmap

B1.  
Cable Ties

B2.  
Cable  
Accessories

B3.  
Stainless  
Steel Ties

C1.  
Wiring  
Duct

C2.  
Surface  
Raceway

C3.  
Abrasion  
Protection

C4.  
Cable  
Management

D1.  
Terminals

D2.  
Power  
Connectors

D3.  
Grounding  
Connectors

E1.  
Labeling  
Systems

E2.  
Labels

E3.  
Pre-Printed  
& Write-On  
Markers

E4.  
Permanent  
Identification

E5.  
Lockout/  
Tagout  
& Safety  
Solutions

F.  
Index

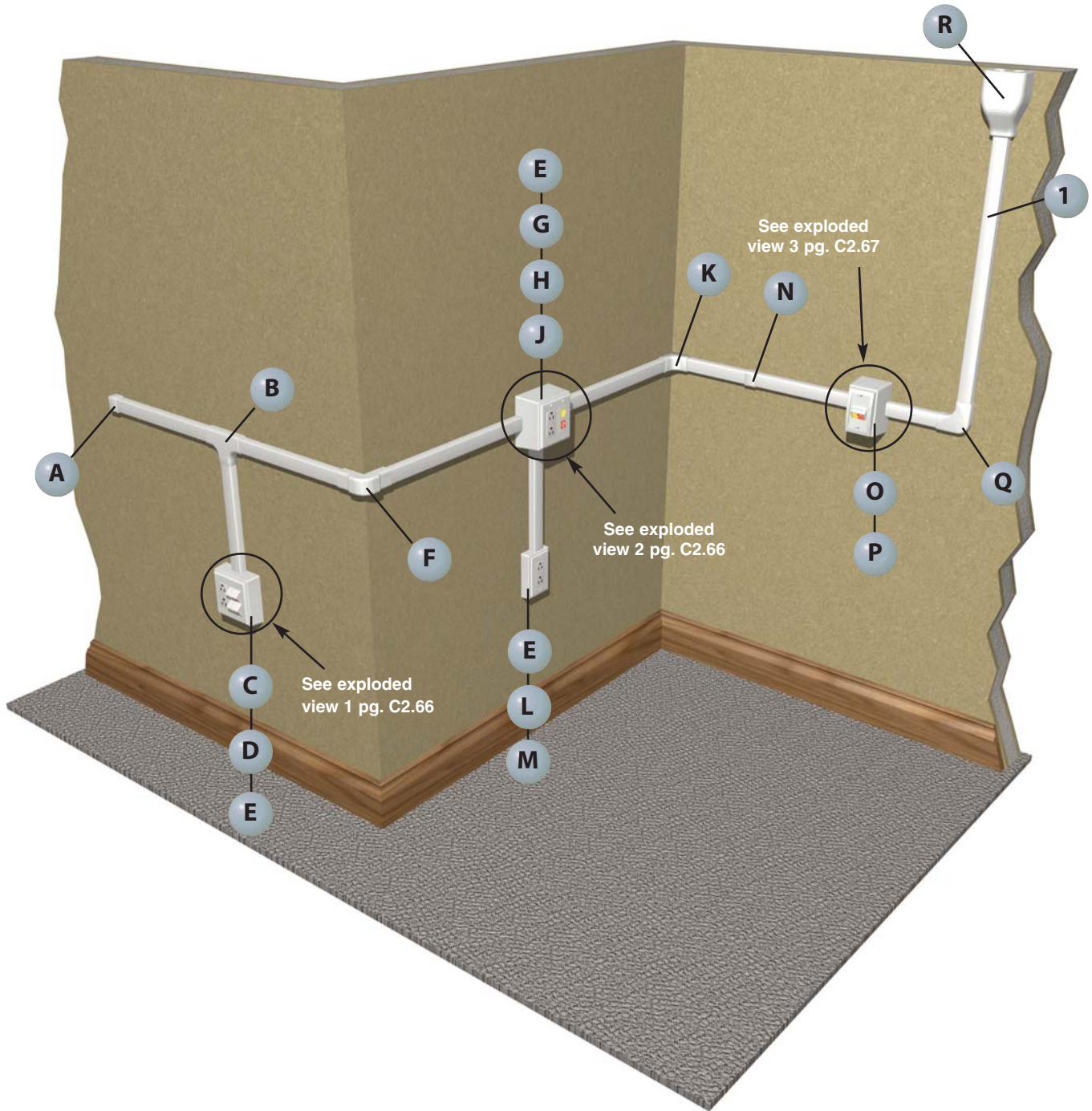



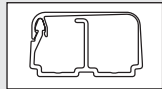

**1** LD2P10\*\* – Raceway  
(page C2.75)

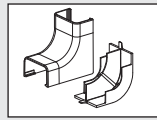

**K** ICFX10\*\* – Power Rated Inside  
Corner Fitting (page C2.75)

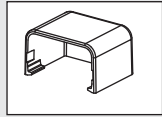

**A** ECFX10\*\* – Power Rated End Cap  
Fitting (page C2.75)

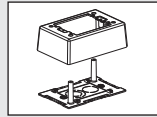

**L** JBP1\*\* – Power Rated Single  
Gang Two-Piece Box (page C2.58)

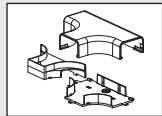

**B** TFXD10\*\* – 1 Inch Bend Radius  
Tee Fitting (page C2.75)

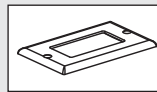

**M** CPG\*\* – Single Gang Rectangular  
Screw-On Faceplate (page C2.60)

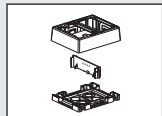

**C** JBP2S\*\* – Power Rated Double  
Gang Two-Piece Divided Box  
(page C2.59)

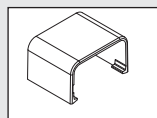

**N** CFX10\*\* – Power Rated Coupler  
Fitting (page C2.75)

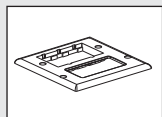

**D** FP2RC\*\* – Double Gang  
Rectangular Electrical and Two  
Communication Insert Faceplate  
(page C2.60)

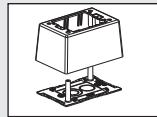

**O** JBP1D\*\* – Single Gang  
Two-Piece Deep Box (page C2.58)

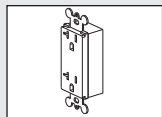

**E** ERU20\*\* – 20 A Rectangular  
Electrical Outlet (page C2.61)

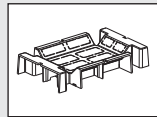

**P** JBD1 – Single Gang Pass Through  
Divider for LD2P10 Raceway  
(page C2.59)

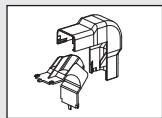

**F** OCFX10\*\* – 1 Inch Bend Radius  
Outside Corner Fitting  
(page C2.75)

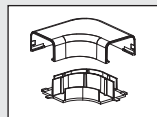

**Q** RAFX10\*\* – Power Rated Right  
Angle Fitting (page C2.75)

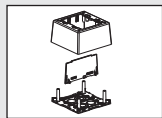

**G** JBP2D\*\* – Power Rated Double  
Gang Two-Piece Deep Box  
(page C2.58)

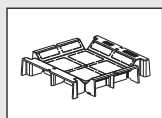

**H** JBD2 – Double Gang Pass  
Through and Divider for LD2P10  
Raceway (page C2.59)

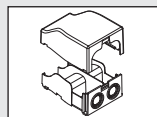

**R** EEFX\*\* – Power Rated/1 Inch  
Bend Radius Entrance End Fitting  
(page C2.75)

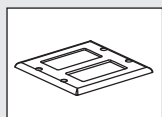

**J** CPG\*\*-2G – Double Gang  
Rectangular Screw-On Faceplate  
(page C2.60)

A.  
System  
Overview

B1.  
Cable Ties

B2.  
Cable  
Accessories

B3.  
Stainless  
Steel Ties

C1.  
Wiring  
Duct

C2.  
Surface  
Raceway

C3.  
Abrasion  
Protection

C4.  
Cable  
Management

D1.  
Terminals

D2.  
Power  
Connectors

D3.  
Grounding  
Connectors

E1.  
Labeling  
Systems

E2.  
Labels

E3.  
Pre-Printed  
& Write-On  
Markers

E4.  
Permanent  
Identification

E5.  
Lockout/  
Tagout  
& Safety  
Solutions

F.  
Index

A.  
System  
Overview

## LD2P10 Configurations

B1.  
Cable Ties

### Exploded View 1

|    | Components Required  | See page |
|----|--|----------|
| A. | Panduit® Mini-Com® Modules.  | —        |
| B. | FP2RC = Double gang rectangular electrical and two communication insert faceplate (screws included). | C2.60    |
| C. | ERU20 = 20 A rectangular electrical outlet (screws included).  | C2.61    |
| D. | JBP2S = Power rated double gang three-piece divided box (screws included).                           | C2.59    |

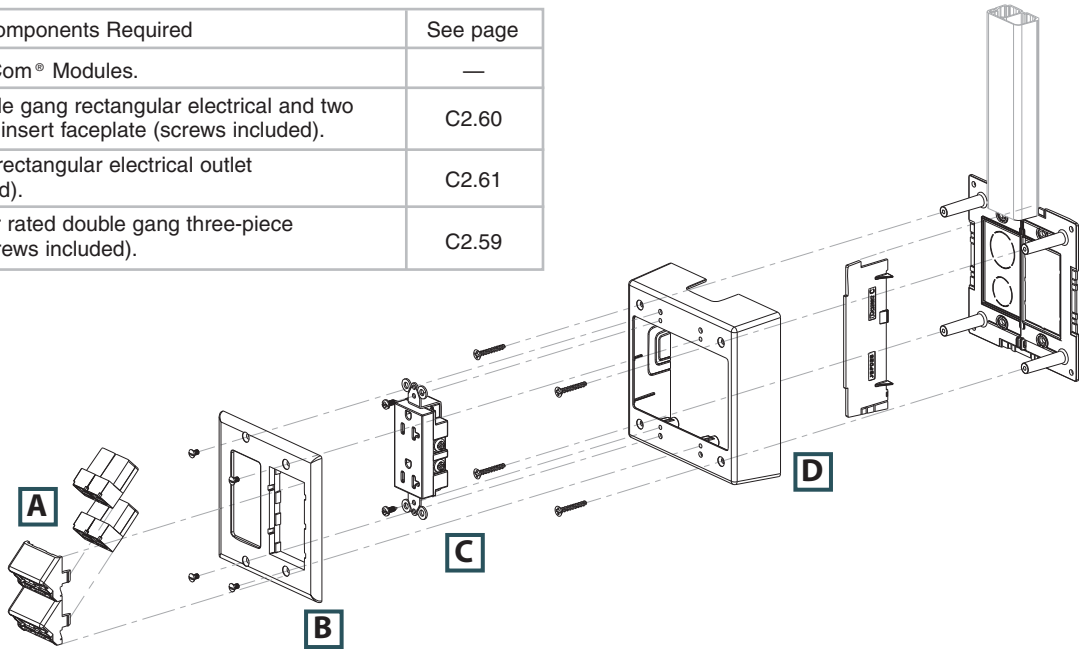

C1.  
Wiring  
Duct

C2.  
Surface  
Raceway

C3.  
Abrasion  
Protection

C4.  
Cable  
Management

D1.  
Terminals

### Exploded View 2

|    | Components Required   | See page |
|----|---|----------|
| A. | JBD2 = Double gang pass-through divider for LD2P10 raceway.           | C2.59    |
| B. | JBP2D = Power rated double gang two-piece deep box.                   | C2.58    |
| C. | ERU20 = 20 A rectangular electrical outlet (screws included).         | C2.61    |
| D. | Panduit® Mini-Com® Modules.   | —        |
| E. | CPG2G = Double gang rectangular screw-on faceplate (screws included). | C2.60    |

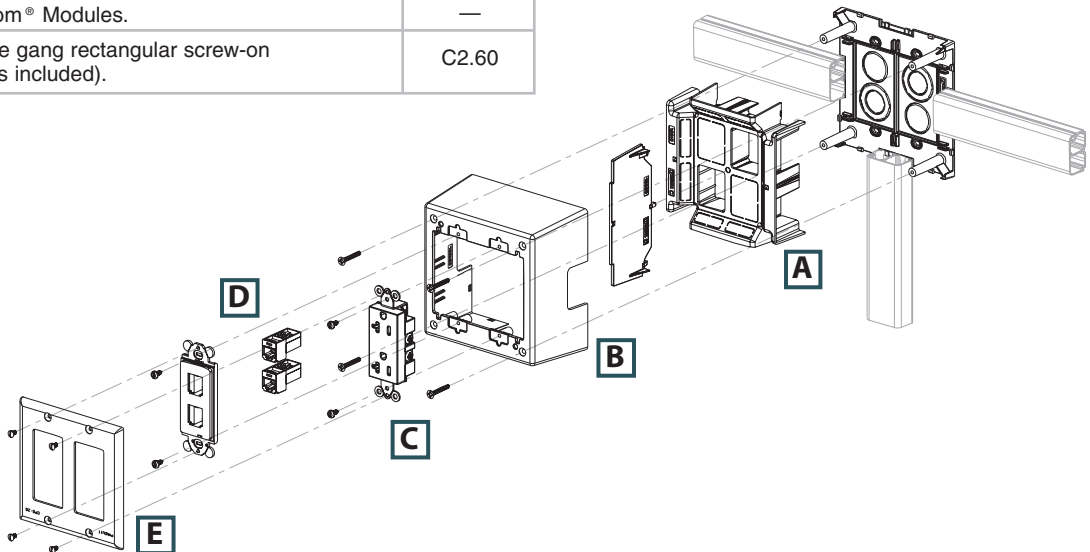

E2.  
Labels

E3.  
Pre-Printed  
& Write-On  
Markers

E4.  
Permanent  
Identification

E5.  
Lockout/  
Tagout  
& Safety  
Solutions

F.  
Index

## LD2P10 Configurations (continued)

### Exploded View 3

|    | Components Required   | See page |
|----|---|----------|
| A. | UICFPSE2 = Ultimate ID® Two-Position Executive Sloped Faceplate.      | —        |
| B. | Mini-Com® Modules.  | —        |
| C. | JBP1D = Power rated single gang two-piece deep box (screws included). | C2.58    |
| D. | JBD1 = Single gang pass-through divider for LD2P10 raceway.           | C2.59    |

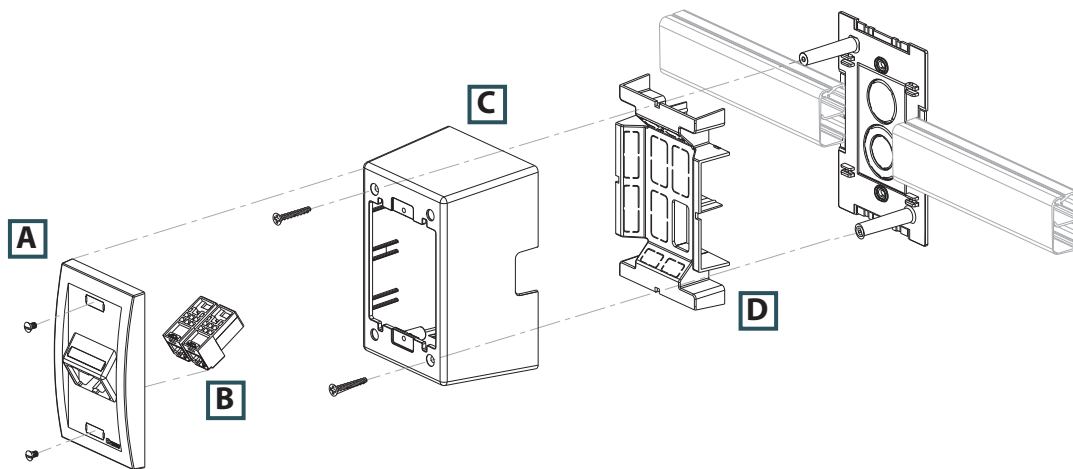

A.  
System  
Overview

B1.  
Cable Ties

B2.  
Cable  
Accessories

B3.  
Stainless  
Steel Ties

C1.  
Wiring  
Duct

C2.  
Surface  
Raceway

C3.  
Abrasion  
Protection

C4.  
Cable  
Management

D1.  
Terminals

D2.  
Power  
Connectors

D3.  
Grounding  
Connectors

E1.  
Labeling  
Systems

E2.  
Labels

E3.  
Pre-Printed  
& Write-On  
Markers

E4.  
Permanent  
Identification

E5.  
Lockout/  
Tagout  
& Safety  
Solutions

F.  
Index

A.  
System  
Overview

## LD Profile Raceway Roadmap

B1.  
Cable Ties

B2.  
Cable  
Accessories

B3.  
Stainless  
Steel Ties

C1.  
Wiring  
Duct

C2.  
Surface  
Raceway

C3.  
Abrasion  
Protection

C4.  
Cable  
Management

D1.  
Terminals

D2.  
Power  
Connectors

D3.  
Grounding  
Connectors

E1.  
Labeling  
Systems

E2.  
Labels

E3.  
Pre-Printed  
& Write-On  
Markers

E4.  
Permanent  
Identification

E5.  
Lockout/  
Tagout  
& Safety  
Solutions

F.  
Index

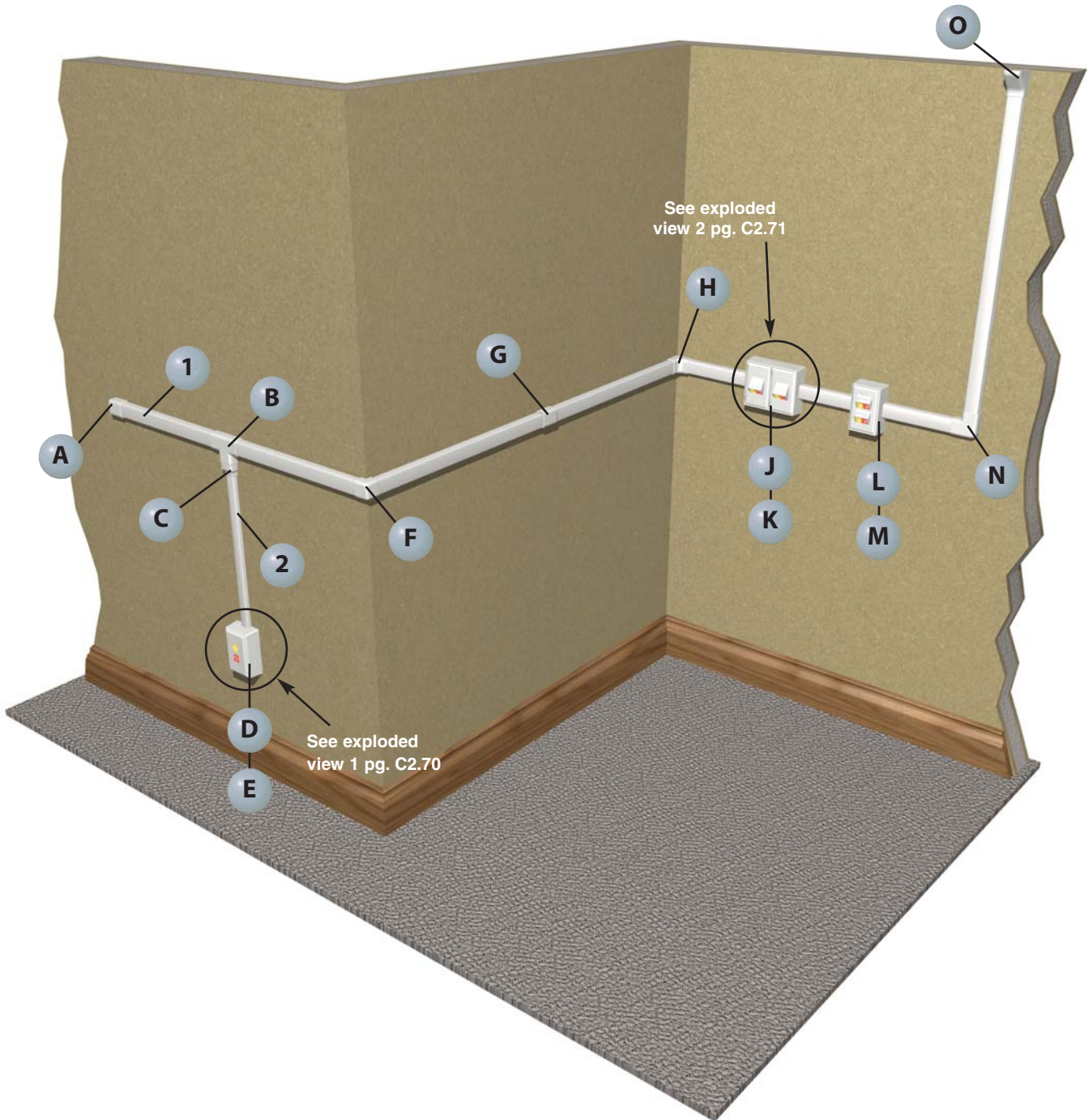

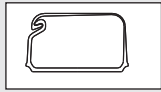

**1** LD10\*\* – Raceway (page C2.76)

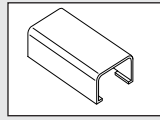

**G** CF10\*\* – Coupler Fitting (page C2.79)



**2** LD5\*\* – Raceway (page C2.76)

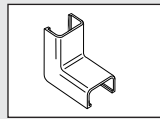

**H** ICF10\*\* – Inside Corner Fitting (page C2.79)

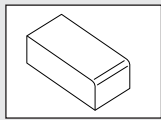

**A** ECF10\*\* – End Cap Fitting (page C2.79)

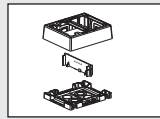

**J** JBP2FS\*\* – Fast-Snap™ Double Gang Power Rated Surface Mount Outlet Box (page C2.52)

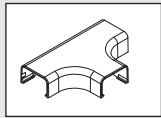

**B** TF10\*\* – Tee Fitting (page C2.79)

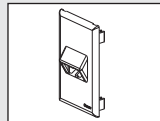

**K** T70FV2\*\* – Snap-On Vertical Sloped Communication Faceplate (page C2.52)

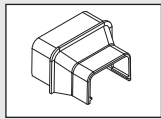

**C** RF10X5\*\* – Reducer Fitting (page C2.79)

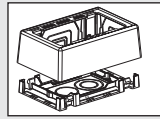

**L** JB1FS\*\* – Fast-Snap™ Single Gang Surface Mount Outlet Box (page C2.52)

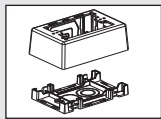

**D** JBX3510\*\* – Single Gang Two-Piece Snap-Together Box (page C2.57)

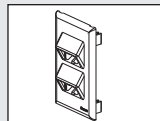

**M** T70FV4\*\* – Snap-On Vertical Sloped Communication Faceplate (page C2.52)

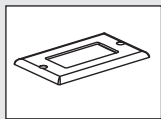

**E** CPG\*\* – Single Gang Rectangular Screw-On Faceplate (page C2.60)

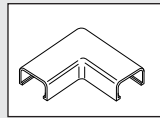

**N** RAF10\*\* – Right Angle Fitting (page C2.79)

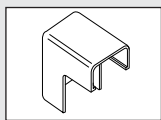

**F** OCF10\*\* – Outside Corner Fitting (page C2.79)

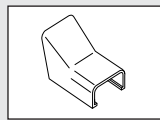

**O** DCF10\*\* – Drop Ceiling/Entrance End Fitting (page C2.79)

A. System Overview

B1. Cable Ties

B2. Cable Accessories

B3. Stainless Steel Ties

C1. Wiring Duct

C2. Surface Raceway

C3. Abrasion Protection

C4. Cable Management

D1. Terminals

D2. Power Connectors

D3. Grounding Connectors

E1. Labeling Systems

E2. Labels

E3. Pre-Printed & Write-On Markers

E4. Permanent Identification

E5. Lockout/Tagout & Safety Solutions

F. Index

A.  
System  
Overview

## LD Configurations

B1.  
Cable Ties

### Exploded View 1

B2.  
Cable  
Accessories

|    | Components Required   | See page |
|----|---|----------|
| A. | CPG = Single gang rectangular screw-on faceplate (screws included). | C2.60    |
| B. | CFG2 = Mini-Com® Module Frame – 2-port.                             | —        |
| C. | Mini-Com® Modules.  | —        |
| D. | JBX3510 = Single gang two-piece snap together box.                  | C2.57    |

B3.  
Stainless  
Steel Ties

C1.  
Wiring  
Duct

C2.  
Surface  
Raceway

C3.  
Abrasion  
Protection

C4.  
Cable  
Management

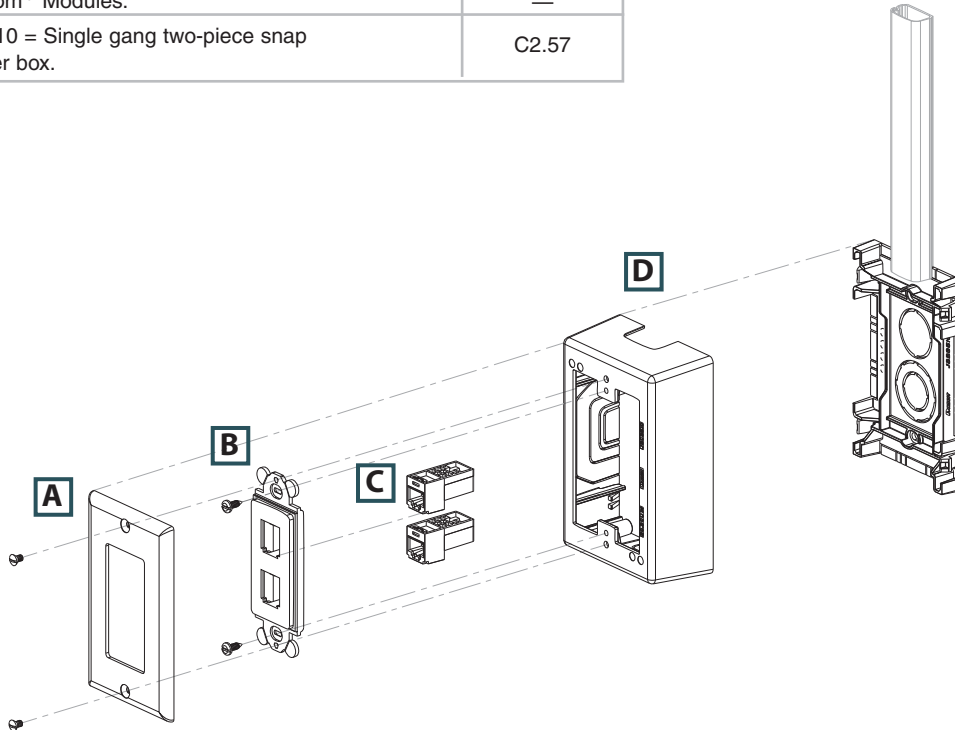

D1.  
Terminals

D2.  
Power  
Connectors

D3.  
Grounding  
Connectors

E1.  
Labeling  
Systems

E2.  
Labels

E3.  
Pre-Printed  
& Write-On  
Markers

E4.  
Permanent  
Identification

E5.  
Lockout/  
Tagout  
& Safety  
Solutions

F.  
Index



## LD Configurations (continued)

### Exploded View 2

|    | Components Required   | See page |
|----|---|----------|
| A. | T70FV2 = Snap-on vertical sloped communication faceplate – 2-port.    | C2.52    |
| B. | Panduit® Mini-Com® Modules.   | —        |
| C. | JBP2FS = Fast-Snap™ double gang power rated surface mount outlet box. | C2.52    |

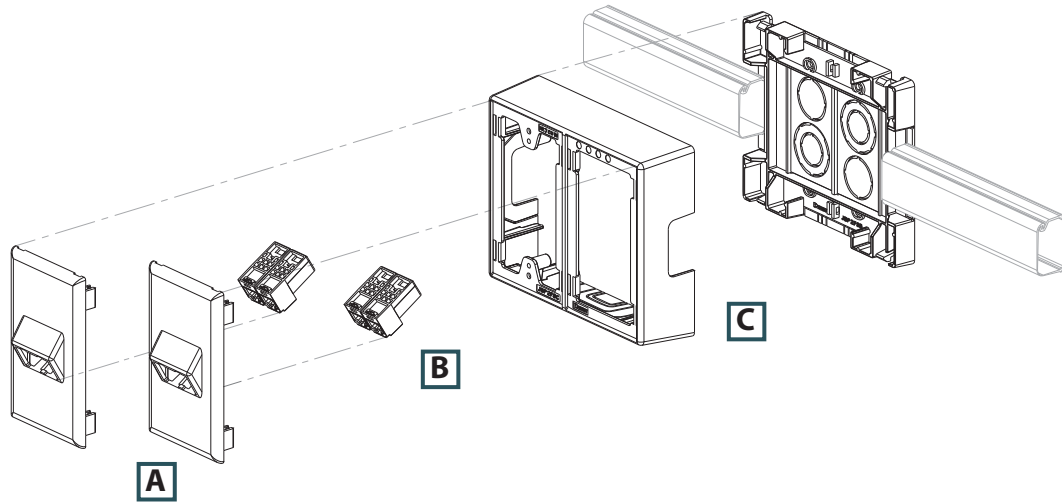

A.  
System  
Overview

B1.  
Cable Ties

B2.  
Cable  
Accessories

B3.  
Stainless  
Steel Ties

C1.  
Wiring  
Duct

C2.  
Surface  
Raceway

C3.  
Abrasion  
Protection

C4.  
Cable  
Management

D1.  
Terminals

D2.  
Power  
Connectors

D3.  
Grounding  
Connectors

E1.  
Labeling  
Systems

E2.  
Labels

E3.  
Pre-Printed  
& Write-On  
Markers

E4.  
Permanent  
Identification

E5.  
Lockout/  
Tagout  
& Safety  
Solutions

F.  
Index

A.  
System  
Overview

## LDPH Profile Raceway Roadmap

B1.  
Cable Ties

B2.  
Cable  
Accessories

B3.  
Stainless  
Steel Ties

C1.  
Wiring  
Duct

C2.  
Surface  
Raceway

C3.  
Abrasion  
Protection

C4.  
Cable  
Management

D1.  
Terminals

D2.  
Power  
Connectors

D3.  
Grounding  
Connectors

E1.  
Labeling  
Systems

E2.  
Labels

E3.  
Pre-Printed  
& Write-On  
Markers

E4.  
Permanent  
Identification

E5.  
Lockout/  
Tagout  
& Safety  
Solutions

F.  
Index

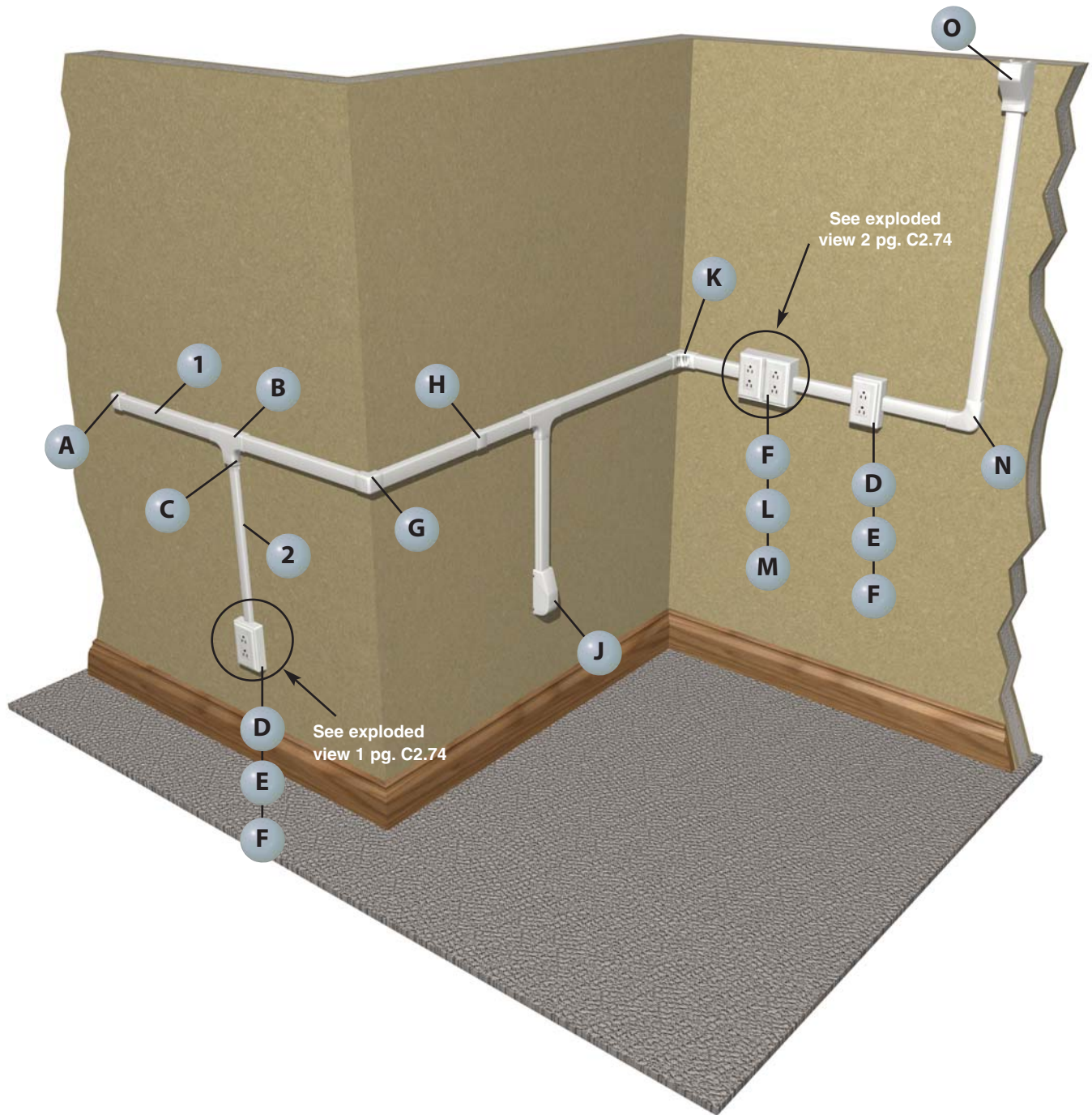

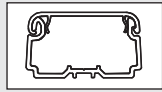

**1** LDPH10\*\* – Raceway  
(page C2.77)

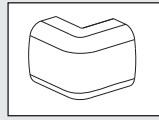

**G** OCFC10\*\* – Power Rated Outside  
Corner Fitting  
(page C2.81)

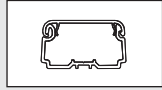

**2** LDPH5\*\* – Raceway (page C2.77)

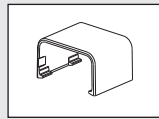

**H** CFX10\*\* – Power Rated/1 Inch  
Bend Radius Coupler Fitting  
(page C2.80)

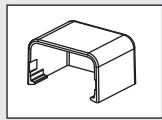

**A** ECFX10\*\* – Power Rated/1 Inch  
Bend Radius End Cap Fitting  
(page C2.80)

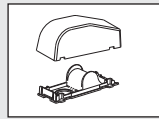

**J** RAEFX\*\* – Power Rated/1 Inch  
Bend Radius Right Angle  
Entrance End Fitting  
(page C2.81)

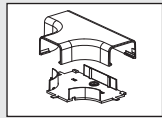

**B** TFX10\*\* – Power Rated  
Tee Fitting (page C2.81)

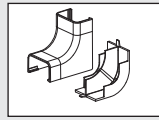

**K** ICFX10\*\* – Power Rated Inside  
Corner Fitting  
(page C2.81)

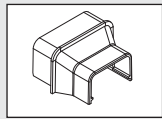

**C** RFX105\*\* – Power Rated/1 Inch  
Bend Radius Reducer Fitting  
(page C2.80, C2.81)

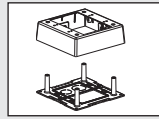

**L** JBP2\*\* – Power Rated Double  
Gang Two-Piece Box  
(page C2.58)

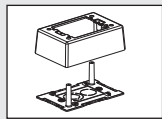

**D** JBP1\*\* – Power Rated Single  
Gang Two-Piece Box  
(page C2.58)

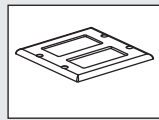

**M** CPG\*\*-2G – Double Gang  
Rectangular Screw-On Faceplates  
(page C2.60)

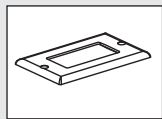

**E** CPG\*\* – Single Gang Rectangular  
Screw-On Faceplate  
(page C2.60)

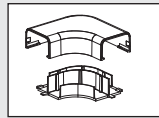

**N** RAFX10\*\* – Power Rated Right  
Angle Fitting  
(page C2.81)

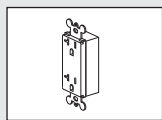

**F** ERU20\*\* – 20 A Rectangular  
Electrical Outlet  
(page C2.61)

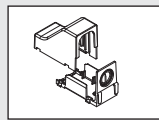

**O** DCEFX\*\* – Power Rated/1 Inch  
Bend Radius Drop Ceiling  
Entrance End Fitting  
(page C2.80)

A.  
System  
Overview

B1.  
Cable Ties

B2.  
Cable  
Accessories

B3.  
Stainless  
Steel Ties

C1.  
Wiring  
Duct

C2.  
Surface  
Raceway

C3.  
Abrasion  
Protection

C4.  
Cable  
Management

D1.  
Terminals

D2.  
Power  
Connectors

D3.  
Grounding  
Connectors

E1.  
Labeling  
Systems

E2.  
Labels

E3.  
Pre-Printed  
& Write-On  
Markers

E4.  
Permanent  
Identification

E5.  
Lockout/  
Tagout  
& Safety  
Solutions

F.  
Index

A.  
System  
Overview

## LDPH Configurations

B1.  
Cable Ties

### Exploded View 1

|    | Components Required   | See page |
|----|---|----------|
| A. | CPG = Single gang rectangular screw-on faceplate (screws included). | C2.60    |
| B. | ERU20 = 20 A rectangular electrical outlet (screws included).       | C2.61    |
| C. | JBP1 = Power rated single gang two-piece box (screws included).     | C2.58    |

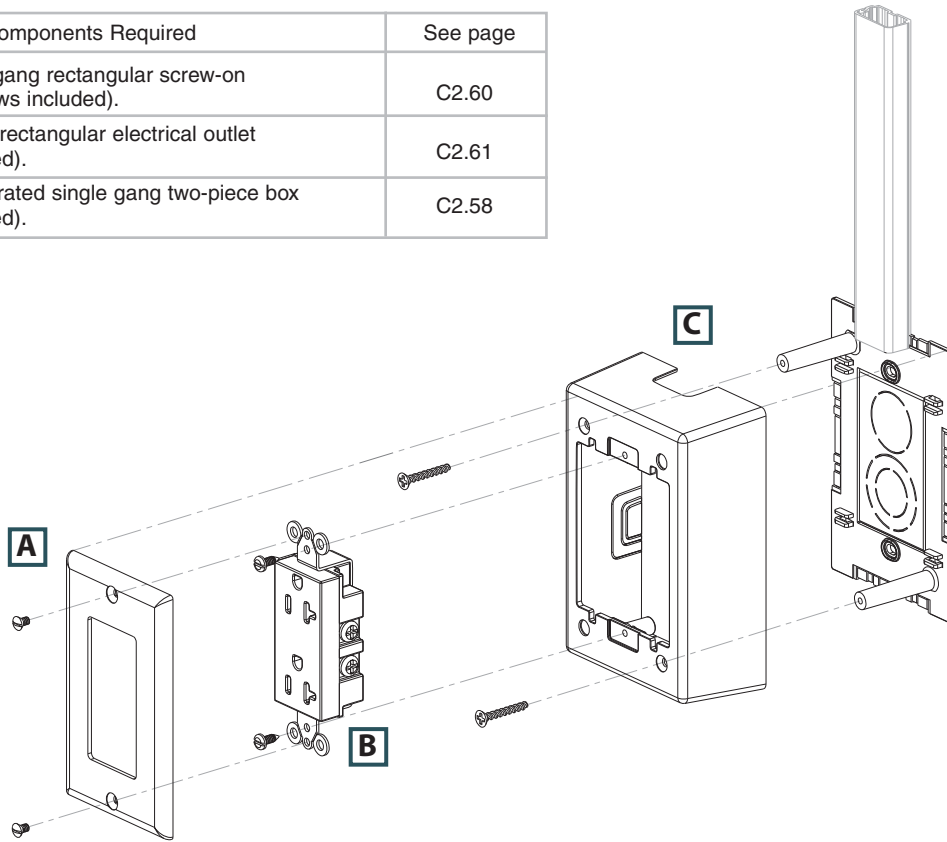

C1.  
Wiring  
Duct

C2.  
Surface  
Raceway

C3.  
Abrasion  
Protection

C4.  
Cable  
Management

D1.  
Terminals

D2.  
Power  
Connectors

### Exploded View 2

|    | Components Required   | See page |
|----|---|----------|
| A. | CPG**2G = Double gang rectangular screw-on faceplate (screws included). | C2.60    |
| B. | ERU20 = 20 A rectangular electrical outlet (screws included).           | C2.61    |
| C. | JBP2 = Power rated double gang two-piece box (screws included).         | C2.58    |

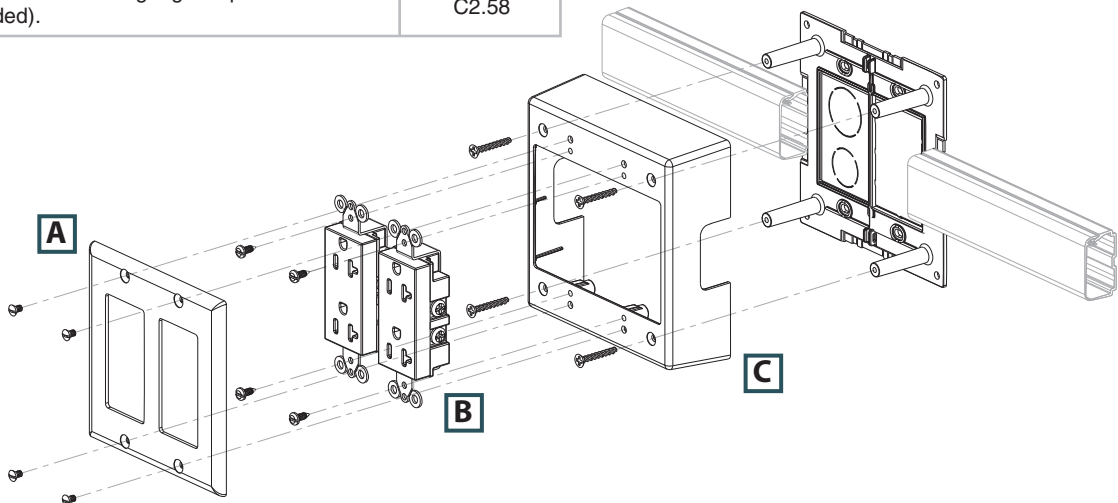

E2.  
Labels

E3.  
Pre-Printed  
& Write-On  
Markers

E4.  
Permanent  
Identification

E5.  
Lockout/  
Tagout  
& Safety  
Solutions

F.  
Index



## Pan-Way® Type LD2P10 Multi-Channel Surface Raceway System

- UL and CSA rated 600 V; meets UL 5A and CSA C22.2 No. 62.1-03 standards; FT4 rated
- Routes power and data together
- One-piece hinged design allows cables to be laid in
- Tamper resistant

- Factory applied adhesive backing speeds installation
- Terminates using JBP1D, JBP2D, JBP2FS or JBP2S surface mount outlet box solutions

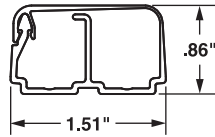

Left Internal Area = .43 Sq. In.  
Right Internal Area = .50 Sq. In.



| Part Number         | Part Description  | Raceway Size                      | Color‡    | Length (Ft.) | Std. Ctn. Qty. |
|---------------------|---|-----------------------------------|-----------|--------------|----------------|
| <b>LD2P10IW8-A</b>  | Two channel tamper resistant one-piece latching surface raceway. Supplied with pre-applied adhesive backed tape. Available in 8' and 10' lengths. | 1.52" x .86"<br>(39.0mm x 22.0mm) | Off White | 8            | 160            |
| <b>LD2P10IW10-A</b> |   |                                   |           | 10           | 200            |

LD2P raceway requires screw mounting if it is being used for power cabling applications. Order number of feet required in multiples of standard length increments.

‡For other colors replace IW (Off White) with EI (Electric Ivory), IG (International Gray), or WH (White).



## Multi-Channel Fittings for LD2P10

- Multi-channel fittings for LD2P10 are designed to maintain the TIA/EIA-568-B and 569-B required minimum bend radius for high performance copper and fiber optic cabling systems



| Part Number       | Part Description   | Color‡    | Std. Pkg. Qty. |
|-------------------|--|-----------|----------------|
| <b>CFX10IW-X</b>  | Coupler fitting for use with LD10, LDPH10, and LD2P10 raceway.   | Off White | 10             |
| <b>RAFX10IW-X</b> | Right angle fitting for use with LDPH10 and LD2P10 raceway.  | Off White | 10             |
| <b>ICFX10IW-X</b> | Inside corner fitting for use with LDPH10 and LD2P10 raceway.  | Off White | 10             |
| <b>OCFX10IW-X</b> | Outside corner fitting for use with LDPH10 and LD2P10 raceway.   | Off White | 10             |
| <b>TFXD10IW-X</b> | Tee fitting with divided insert to maintain separation of power and data cabling. For use with LD2P10 raceway. | Off White | 10             |
| <b>ECFX10IW-X</b> | End cap fitting for use with LDPH10 and LD2P10 raceway.  | Off White | 10             |
| <b>EEFX10IW</b>   | Entrance end fitting for LD2P10 raceway. Breakouts for 1/2" and 3/4" diameter conduit.                         | Off White | 1              |

‡For other colors replace IW (Off White) with EI (Electric Ivory), IG (International Gray), or WH (White).

A.  
System  
Overview

B1.  
Cable Ties

B2.  
Cable  
Accessories

B3.  
Stainless  
Steel Ties

C1.  
Wiring  
Duct

C2.  
Surface  
Raceway

C3.  
Abrasion  
Protection

C4.  
Cable  
Management

D1.  
Terminals

D2.  
Power  
Connectors

D3.  
Grounding  
Connectors

E1.  
Labeling  
Systems

E2.  
Labels

E3.  
Pre-Printed  
& Write-On  
Markers

E4.  
Permanent  
Identification

E5.  
Lockout/  
Tagout  
& Safety  
Solutions

F.  
Index



A. System Overview

## Pan-Way® LD Surface Raceway System

B1. Cable Ties

- For routing data and low voltage cabling
- One-piece hinged design allows cables to be laid in
- Factory applied adhesive backing speeds installation

- FT4 rated
- Terminates using surface mount outlet box solutions or Panduit® Mini-Com® Surface Mount Boxes

B2. Cable Accessories

B3. Stainless Steel Ties

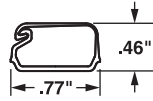

**LD3**  
Internal Area = .21 Sq. In.

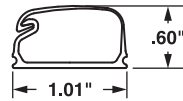

**LD5**  
Internal Area = .38 Sq. In.

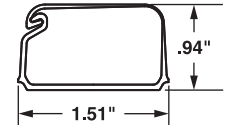

**LD10**  
Internal Area = 1.00 Sq. In.



**LD3**



**LD5**



**LD10**

C1. Wiring Duct

C2. Surface Raceway

C3. Abrasion Protection

C4. Cable Management

| Part Number                   | Part Description  | Raceway Size                      | Color‡    | Length (Ft.) | Std. Ctn. Qty. |
|-------------------------------|---|-----------------------------------|-----------|--------------|----------------|
| <b>LD3 – Surface Raceway</b>  |   |                                   |           |              |                |
| <b>LD3IW6-A</b>               | One-piece latching surface raceway. Supplied with pre-applied adhesive backed tape. Available in 6', 8', and 10' lengths. | .77" x .46"<br>(20.0mm x 12.0mm)  | Off White | 6            | 120            |
| <b>LD3IW8-A</b>               |   |                                   |           | 8            | 160            |
| <b>LD3IW10-A</b>              |   |                                   |           | 10           | 200            |
| <b>LD5 – Surface Raceway</b>  |   |                                   |           |              |                |
| <b>LD5IW6-A</b>               | One-piece latching surface raceway. Supplied with pre-applied adhesive backed tape. Available in 6', 8', and 10' lengths. | 1.01" x .58"<br>(26.0mm x 15.0mm) | Off White | 6            | 120            |
| <b>LD5IW8-A</b>               |   |                                   |           | 8            | 160            |
| <b>LD5IW10-A</b>              |   |                                   |           | 10           | 200            |
| <b>LD10 – Surface Raceway</b> |   |                                   |           |              |                |
| <b>LD10IW6-A</b>              | One-piece latching surface raceway. Supplied with pre-applied adhesive backed tape. Available in 6', 8', and 10' lengths. | 1.51" x .94"<br>(38.4mm x 24.0mm) | Off White | 6            | 120            |
| <b>LD10IW8-A</b>              |   |                                   |           | 8            | 160            |
| <b>LD10IW10-A</b>             |   |                                   |           | 10           | 200            |

‡For other colors replace IW (Off White) with EI (Electric Ivory), IG (International Gray), or WH (White).  
Order number of feet required in multiples of standard length increments.

D1. Terminals

D2. Power Connectors

D3. Grounding Connectors

E1. Labeling Systems

E2. Labels

E3. Pre-Printed & Write-On Markers

E4. Permanent Identification

E5. Lockout/Tagout & Safety Solutions

F. Index

## Pan-Way® LDPH Surface Raceway System

- UL and CSA rated 600 V; meets UL 5A and CSA C22.2 No. 62.1-03 standards; FT4 rated
- Two-piece hinged design allows cables to be laid in
- Tamper resistant
- Factory applied adhesive backing speeds installation
- Terminates using surface mount outlet box solutions or Panduit® Mini-Com® Surface Mount Boxes

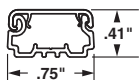

**LDPH3**  
Internal Area = .17 Sq. In.

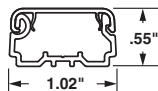

**LDPH5**  
Internal Area = .33 Sq. In.

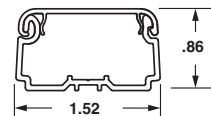

**LDPH10**  
Internal Area = .89 Sq. In.



**LDPH3**



**LDPH5**



**LDPH10**

| Part Number                     | Part Description  | Raceway Size                      | Color†    | Length (Ft.) | Std. Ctn. Qty. |
|---------------------------------|---|-----------------------------------|-----------|--------------|----------------|
| <b>LDPH3 – Surface Raceway</b>  |   |                                   |           |              |                |
| <b>LDPH3IW8-A</b>               | Tamper resistant one-piece latching surface raceway. Supplied with pre-applied adhesive backed tape. Available in 8' and 10' lengths. | .75" x .41"<br>(20.0mm x 10.4mm)  | Off White | 8            | 160            |
| <b>LDPH3IW10-A</b>              |   |                                   |           | 10           | 200            |
| <b>LDPH5 – Surface Raceway</b>  |   |                                   |           |              |                |
| <b>LDPH5IW8-A</b>               | Tamper resistant one-piece latching surface raceway. Supplied with pre-applied adhesive backed tape. Available in 8' and 10' lengths. | 1.02" x .55"<br>(26.0mm x 14.0mm) | Off White | 8            | 160            |
| <b>LDPH5IW10-A</b>              |   |                                   |           | 10           | 200            |
| <b>LDPH10 – Surface Raceway</b> |   |                                   |           |              |                |
| <b>LDPH10IW8-A</b>              | Tamper resistant two-piece latching surface raceway. Supplied with pre-applied adhesive backed tape. Available in 8' and 10' lengths. | 1.52" x .86"<br>(39.0mm x 22.0mm) | Off White | 8            | 160            |
| <b>LDPH10IW10-A</b>             |   |                                   |           | 10           | 200            |

LDPH raceway requires screw mounting for power cabling applications. Order number of feet required in multiples of standard length increments.

†For other colors replace IW (Off White) with EI (Electric Ivory), IG (International Gray), or WH (White).

A.  
System  
Overview

B1.  
Cable Ties

B2.  
Cable  
Accessories

B3.  
Stainless  
Steel Ties

C1.  
Wiring  
Duct

C2.  
Surface  
Raceway

C3.  
Abrasion  
Protection

C4.  
Cable  
Management

D1.  
Terminals

D2.  
Power  
Connectors

D3.  
Grounding  
Connectors

E1.  
Labeling  
Systems

E2.  
Labels

E3.  
Pre-Printed  
& Write-On  
Markers

E4.  
Permanent  
Identification

E5.  
Lockout/  
Tagout  
& Safety  
Solutions

F.  
Index

A. System Overview



## Pan-Way® LDS Surface Raceway System

B1. Cable Ties

- UL and CSA rated 600 V; meets UL 5A and CSA C22.2 No. 62.1-03 standards; FT4 rated

- LDS raceway requires screw mounting using the LMD mounting straps for power cabling installations

B2. Cable Accessories

- Tamper resistant non-hinged design

- Terminates using surface mount outlet box solutions or Panduit® Mini-Com® Surface Mount Boxes

B3. Stainless Steel Ties

- Type LDS is **the only non-metallic raceway that is bendable** in low voltage applications to route around and over obstructions

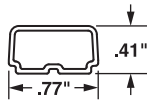

**LDS3**  
Internal Area = .21 Sq. In.

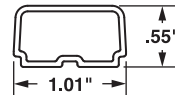

**LDS5**  
Internal Area = .38 Sq. In.

C1. Wiring Duct

C2. Surface Raceway



**LDS3**

C3. Abrasion Protection

C4. Cable Management



**LDS5**

D1. Terminals

D2. Power Connectors



**LMD3**  
**LMD5**

D3. Grounding Connectors

E1. Labeling Systems

E2. Labels

E3. Pre-Printed & Write-On Markers

E4. Permanent Identification

E5. Lockout/Tagout & Safety Solutions

F. Index

| Part Number                   | Part Description  | Raceway Size                      | Color‡    | Length (Ft.) | Std. Ctn. Qty. |
|-------------------------------|---|-----------------------------------|-----------|--------------|----------------|
| <b>LDS3 – Surface Raceway</b> |   |                                   |           |              |                |
| <b>LDS3IW10-A</b>             | Tamper resistant one-piece surface raceway. Supplied with pre-applied adhesive backed tape. Available in 10' lengths. | .77" x .41"<br>(20.0mm x 10.4mm)  | Off White | 10           | 200            |
| <b>LDS5 – Surface Raceway</b> |   |                                   |           |              |                |
| <b>LDS5IW10-A</b>             | Tamper resistant one-piece surface raceway. Supplied with pre-applied adhesive backed tape. Available in 10' lengths. | 1.01" x .55"<br>(26.0mm x 14.0mm) | Off White | 10           | 200            |
| <b>Mounting Straps</b>        |   |                                   |           |              |                |
| <b>LMD3IW-Q</b>               | For use with LDS3 raceway.  | Size 3                            | Off White | —            | 100            |
| <b>LMD5IW-Q</b>               | For use with LDS5 raceway.  | Size 5                            | Off White | —            | 100            |

‡For other colors replace IW (Off White) with EI (Electric Ivory), IG (International Gray), or WH (White).  
Order number of feet required in multiples of standard length increments.

### Method for Bending Type LDS Raceway (Low Voltage Applications)



1) Slide 18" to 30" section of LDS Raceway into PVC pipe heating blanket.  
\*(Recommended blanket designed for bending 1/2" to 1 1/2" PVC conduit.)



2) Allow section to heat approximately 2 – 3 minutes. Raceway will be soft and pliable, but should not stretch. (Time will vary with blanket temperature and raceway size.)



3) Remove raceway section from blanket and hold in desired position until the raceway cools. Install mounting straps immediately.

\*Heating blanket not offered by Panduit.

## Standard Fittings for Low Voltage Applications

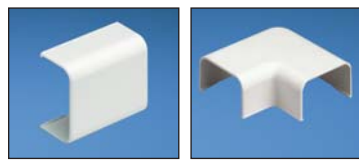

CF

RAF

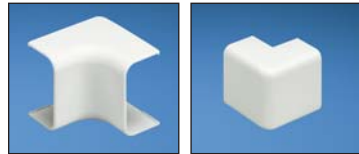

ICF

OCF

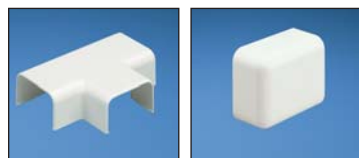

TF

ECF

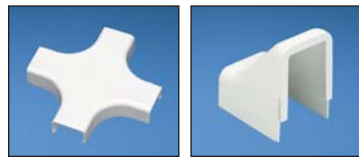

CRFC

DCF

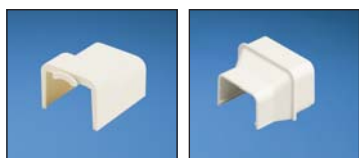

FBA

RF

| Part Number       | Part Description   | Color‡    | Std. Pkg. Qty. |
|-------------------|--|-----------|----------------|
| <b>CF3IW-E</b>    | Coupler fitting for use with LD3 raceway.  | Off White | 20             |
| <b>CF5IW-E</b>    | Coupler fitting for use with LD5 raceway.  | Off White | 20             |
| <b>CF10IW-X</b>   | Coupler fitting for use with LD10 raceway.   | Off White | 10             |
| <b>RAF3IW-E</b>   | Right angle fitting for use with LD3 raceway.  | Off White | 20             |
| <b>RAF5IW-E</b>   | Right angle fitting for use with LD5 raceway.  | Off White | 20             |
| <b>RAF10IW-X</b>  | Right angle fitting for use with LD10 raceway.   | Off White | 10             |
| <b>ICF3IW-E</b>   | Inside corner fitting for use with LD3 raceway.  | Off White | 20             |
| <b>ICF5IW-E</b>   | Inside corner fitting for use with LD5 raceway.  | Off White | 20             |
| <b>ICF10IW-X</b>  | Inside corner fitting for use with LD10 raceway.   | Off White | 10             |
| <b>OCF3IW-E</b>   | Outside corner fitting for use with LD3 raceway.   | Off White | 20             |
| <b>OCF5IW-E</b>   | Outside corner fitting for use with LD5 raceway.   | Off White | 20             |
| <b>OCF10IW-X</b>  | Outside corner fitting for use with LD10 raceway.  | Off White | 10             |
| <b>TF3IW-E</b>    | Tee fitting for use with LD3 raceway.  | Off White | 20             |
| <b>TF5IW-E</b>    | Tee fitting for use with LD5 raceway.  | Off White | 20             |
| <b>TF10IW-X</b>   | Tee fitting for use with LD10 raceway.   | Off White | 10             |
| <b>ECF3IW-E</b>   | End cap fitting for use with LD3 raceway.  | Off White | —              |
| <b>ECF5IW-E</b>   | End cap fitting for use with LD5 raceway.  | Off White | —              |
| <b>ECF10IW-X</b>  | End cap fitting for use with LD10 raceway.   | Off White | —              |
| <b>CRFC5IW-X</b>  | 4-way cross fitting for use with LD5, LDPH5, and LDS5 raceway.   | Off White | 10             |
| <b>DCF3IW-X</b>   | Drop ceiling/entrance end fitting for use with LD3 raceway.  | Off White | 10             |
| <b>DCF5IW-X</b>   | Drop ceiling/entrance end fitting for use with LD5 raceway.  | Off White | 10             |
| <b>DCF10IW-X</b>  | Drop ceiling/entrance end fitting for use with LD10 raceway.   | Off White | 10             |
| <b>FBA5IW-X</b>   | Fire box adapter for use with LD5/LDPH5 profile raceway. Note: For low voltage applications only.                                    | Off White | 10             |
| <b>FBA10IW-X</b>  | Fire box adapter for use with LD10/LDPH10 profile raceway. Note: For low voltage applications only.                                  | Off White | 10             |
| <b>RF5X3IW-E</b>  | Reducer fitting for LD raceway from size 5 to size 3. For use with LD5 and LD3 raceway. For in-line terminations, use with CF5**.    | Off White | 20             |
| <b>RF10X3IW-X</b> | Reducer fitting for LD raceway from size 10 to size 3. For use with LD3 and LD10 raceway. For in-line terminations, use with CF10**. | Off White | 10             |
| <b>RF10X5IW-X</b> | Reducer fitting for LD raceway from size 10 to size 5. For use with LD5 and LD10 raceway. For in-line terminations, use with CF10**. | Off White | 10             |

‡For other colors replace IW (Off White) with EI (Electric Ivory), IG (International Gray), or WH (White).

A. System Overview

B1. Cable Ties

B2. Cable Accessories

B3. Stainless Steel Ties

C1. Wiring Duct

C2. Surface Raceway

C3. Abrasion Protection

C4. Cable Management

D1. Terminals

D2. Power Connectors

D3. Grounding Connectors

E1. Labeling Systems

E2. Labels

E3. Pre-Printed &amp; Write-On Markers

E4. Permanent Identification

E5. Lockout/Tagout &amp; Safety Solutions

F. Index

A. System Overview



## One Inch Bend Radius Fittings for TIA/EIA Compliance

B1. Cable Ties

- 1 inch bend radius fittings are designed to maintain the TIA/EIA-568-B and 569-B required minimum bend radius for high performance copper and fiber optic cabling systems

B2. Cable Accessories

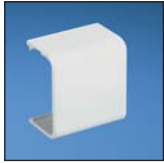

**CFX**

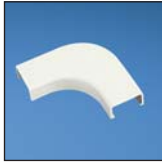

**RAFC**

B3. Stainless Steel Ties

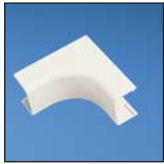

**ICFC**



**OCFX**

C1. Wiring Duct

C2. Surface Raceway



**TFC**



**CRFC5**

C3. Abrasion Protection

C4. Cable Management



**ECFX**

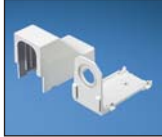

**DCEFX**

D1. Terminals

D2. Power Connectors



**RAEFX**



**RFX**

D3. Grounding Connectors

E1. Labeling Systems

E2. Labels

E3. Pre-Printed & Write-On Markers

E4. Permanent Identification

E5. Lockout/Tagout & Safety Solutions

F. Index

| Part Number       | Part Description  | Color‡    | Std. Pkg. Qty. |
|-------------------|---|-----------|----------------|
| <b>CFX3IW-X</b>   | Coupler fitting for use with LD3, LDPH3, and LDS3 raceway.  | Off White | 10             |
| <b>CFX5IW-X</b>   | Coupler fitting for use with LD5, LDPH5, and LDS5 raceway.  | Off White | 10             |
| <b>CFX10IW-X</b>  | Coupler fitting for use with LD10, LDPH10, and LD2P10 raceway.  | Off White | 10             |
| <b>RAFC3IW-X</b>  | Right angle fitting for use with LD3, LDPH3, and LDS3 raceway.  | Off White | 10             |
| <b>RAFC5IW-X</b>  | Right angle fitting for use with LD5, LDPH5, and LDS5 raceway.  | Off White | 10             |
| <b>RAFC10IW-X</b> | Right angle fitting for use with LD10 and LDPH10 raceway.   | Off White | 10             |
| <b>ICFC3IW-X</b>  | Inside corner fitting for use with LD3, LDPH3, and LDS3 raceway.  | Off White | 10             |
| <b>ICFC5IW-X</b>  | Inside corner fitting for use with LD5, LDPH5, and LDS5 raceway.  | Off White | 10             |
| <b>ICFC10IW-X</b> | Inside corner fitting for use with LD10 and LDPH10 raceway.   | Off White | 10             |
| <b>OCFX3IW-X</b>  | Outside corner fitting for use with LDPH3 and LDS3 raceway.   | Off White | 10             |
| <b>OCFX5IW-X</b>  | Outside corner fitting for use with LDPH5 and LDS5 raceway.   | Off White | 10             |
| <b>OCFX10IW-X</b> | Outside corner fitting for use with LDPH10 and LD2P10 raceway.  | Off White | 10             |
| <b>TFC3IW-X</b>   | Tee fitting for use with LD3, LDPH3, and LDS3 raceway.  | Off White | 10             |
| <b>TFC5IW-X</b>   | Tee fitting for use with LD5, LDPH5, and LDS5 raceway.  | Off White | 10             |
| <b>TFC10IW-X</b>  | Tee fitting for use with LD10 and LDPH10 raceway.   | Off White | 10             |
| <b>CRFC5IW-X</b>  | 4-way cross fitting for use with LD5, LDPH5, and LDS5 raceway.  | Off White | 10             |
| <b>ECFX3IW-X</b>  | End cap fitting for use with LDPH3 and LDS3 raceway.  | Off White | 10             |
| <b>ECFX5IW-X</b>  | End cap fitting for use with LDPH5 and LDS5 raceway.  | Off White | 10             |
| <b>ECFX10IW-X</b> | End cap fitting for use with LDPH10 and LD2P10 raceway.   | Off White | 10             |
| <b>DCEFXIW-X</b>  | Drop ceiling/entrance end fitting for use with LD3, LDPH3, LDS3, LD5, LDPH5, LDS5, LD10 and LDPH10 raceway. Use CA3 or CA5 adapters for LD3 or LD5 profile raceway. | Off White | 10             |
| <b>RAEFXIW-X</b>  | Right angle/entrance end fitting for use with LD3, LDPH3, LDS3, LD5, LDPH5, LDS5, LD10 and LDPH10 raceway. CA3 or CA5 adapters for LD3 or LD5 profile raceway.      | Off White | 10             |
| <b>RFX53IW-X</b>  | Reducer fitting for use with LD3, LDPH3, LDS3, LD5, LDPH5 and LDS5 raceway. For in-line terminations, use with CFX5**.  | Off White | 10             |
| <b>RFX103IW-X</b> | Reducer fitting for use with LD3, LDPH3, LD10 and LDPH10 raceway. For in-line terminations, use with CFX10**.   | Off White | 10             |
| <b>RFX105IW-X</b> | Reducer fitting for use with LD5, LDPH5, LDS5, LD10 and LDPH10 raceway. For in-line terminations, use with CFX10**.   | Off White | 10             |

‡For other colors replace IW (Off White) with EI (Electric Ivory), IG (International Gray), or WH (White).





## Power Rated Fittings for Power to 600 V – LDPH/LDS/LD2P Raceway Only

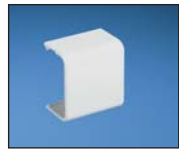

CFX

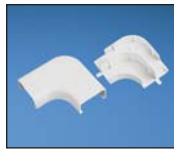

RAFX

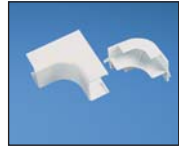

ICFX



OCFC



TFX



CRFX



CEFX



ECFX



DCEFX



RAEFX



RFX

| Part Number       | Part Description   | Color‡    | Std. Pkg. Qty. |
|-------------------|--|-----------|----------------|
| <b>CFX3IW-X</b>   | Coupler fitting for use with LD3, LDPH3, and LDS3 raceway.   | Off White | 10             |
| <b>CFX5IW-X</b>   | Coupler fitting for use with LD5, LDPH5, and LDS5 raceway.   | Off White | 10             |
| <b>CFX10IW-X</b>  | Coupler fitting for use with LD10, LDPH10, and LD2P10 raceway.   | Off White | 10             |
| <b>RAFX3IW-X</b>  | Right angle fitting for use with LDPH3 and LDS3 raceway.   | Off White | 10             |
| <b>RAFX5IW-X</b>  | Right angle fitting for use with LDPH5 and LDS5 raceway.   | Off White | 10             |
| <b>RAFX10IW-X</b> | Right angle fitting for use with LDPH10 and LD2P10 raceway.  | Off White | 10             |
| <b>ICFX3IW-X</b>  | Inside corner fitting for use with LDPH3 and LDS3 raceway.   | Off White | 10             |
| <b>ICFX5IW-X</b>  | Inside corner fitting for use with LDPH5 and LDS5 raceway.   | Off White | 10             |
| <b>ICFX10IW-X</b> | Inside corner fitting for use with LDPH10 and LD2P10 raceway.  | Off White | 10             |
| <b>OCFC3IW-X</b>  | Outside corner fitting for use with LDPH3 and LDS3 raceway.  | Off White | 10             |
| <b>OCFC5IW-X</b>  | Outside corner fitting for use with LDPH5 and LDS5 raceway.  | Off White | 10             |
| <b>OCFC10IW-X</b> | Outside corner fitting for use with LDPH10 raceway only.   | Off White | 10             |
| <b>TFX3IW-X</b>   | Tee fitting for use with LDPH3 and LDS3 raceway.   | Off White | 10             |
| <b>TFX5IW-X</b>   | Tee fitting for use with LDPH5 and LDS5 raceway.   | Off White | 10             |
| <b>TFX10IW-X</b>  | Tee fitting for use with LDPH10 raceway only.  | Off White | 10             |
| <b>CRFX5IW-X</b>  | 4-way cross fitting for use with LD5, LDPH5, and LDS5 raceway.   | Off White | 10             |
| <b>CEFXIW-X</b>   | Conduit entrance end fitting. This power rated two-piece fitting is designed to accommodate the entrance of 1/2" conduit or align with knockouts on surface mount electrical boxes. For use with LD3/LDPH3 and has breakouts available to work with LD5/LDPH5 and LD10/LDPH10. Cover and base snap together – no hardware is required. | Off White | 10             |
| <b>ECFX3IW-X</b>  | End cap fitting for use with LDPH3 and LDS3 raceway.   | Off White | 10             |
| <b>ECFX5IW-X</b>  | End cap fitting for use with LDPH5 and LDS5 raceway.   | Off White | 10             |
| <b>ECFX10IW-X</b> | End cap fitting for use with LDPH10 and LD2P10 raceway.  | Off White | 10             |
| <b>DCEFXIW-X</b>  | Drop ceiling/entrance end fitting for use with LD3, LDPH3, LDS3, LD5, LDPH5, LDS5, LD10 and LDPH10 raceway. Use CA3 or CA5 adapters for LD3 or LD5 profile raceway.  | Off White | 10             |
| <b>RAEFXIW-X</b>  | Right angle/entrance end fitting for use with LD3, LDPH3, LDS3, LD5, LDPH5, LDS5, LD10 and LDPH10 raceway. CA3 or CA5 adapters for LD3 or LD5 profile raceway.   | Off White | 10             |
| <b>RFX53IW-X</b>  | Reducer fitting for use with LD3, LDPH3, LDS3, LD5, LDPH5 and LDS5 raceway. For in-line terminations, use with CFX5**.   | Off White | 10             |
| <b>RFX103IW-X</b> | Reducer fitting for use with LD3, LDPH3, LD10 and LDPH10 raceway. For in-line terminations, use with CFX10**.  | Off White | 10             |
| <b>RFX105IW-X</b> | Reducer fitting for use with LD5, LDPH5, LDS5, LD10 and LDPH10 raceway. For in-line terminations, use with CFX10**.  | Off White | 10             |

‡For other colors replace IW (Off White) with EI (Electric Ivory), IG (International Gray), or WH (White).

A. System Overview

B1. Cable Ties

B2. Cable Accessories

B3. Stainless Steel Ties

C1. Wiring Duct

C2. Surface Raceway

C3. Abrasion Protection

C4. Cable Management

D1. Terminals

D2. Power Connectors

D3. Grounding Connectors

E1. Labeling Systems

E2. Labels

E3. Pre-Printed & Write-On Markers

E4. Permanent Identification

E5. Lockout/Tagout & Safety Solutions

F. Index

A. System Overview

## Raceway Adapters for LD Raceway

B1. Cable Ties

- Fit into universal breakout of DCEFX or RAEFX fittings
- For use with types LD3, LDPH3, LDS3, LD5, LDPH5 and LDS5 raceway

B2. Cable Accessories



CA3  
CA5

B3. Stainless Steel Ties

| Part Number    | Part Description   | Color‡    | Std. Pkg. Qty. | Std. Ctn. Qty. |
|----------------|--|-----------|----------------|----------------|
| <b>CA3IW-X</b> | Adapter fits into universal breakout of DCEFX or RAEFX fittings. For use LD3, LDPH3, and LDS3 raceway. | Off White | 10             | 50             |
| <b>CA5IW-X</b> | Adapter fits into universal breakout of DCEFX or RAEFX fittings. For use LD5, LDPH5, and LDS5 raceway. | Off White | 10             | 50             |

‡For other colors replace IW (Off White) with EI (Electric Ivory), IG (International Gray), or WH (White).

C1. Wiring Duct

C2. Surface Raceway

## Cable Fill Capacities for LD Profile Raceway

This information is to be used as a guide in selecting the proper size raceway. The maximum amounts may vary according to the cable installation methods, straightness of cables, etc.

C3. Abrasion Protection

C4. Cable Management



| LD3                  | LD5                  | LD10                  |
|----------------------|----------------------|-----------------------|
| .21 in. <sup>2</sup> | .38 in. <sup>2</sup> | 1.00 in. <sup>2</sup> |



| LDPH3                | LDPH5                | LDPH10               |
|----------------------|----------------------|----------------------|
| .17 in. <sup>2</sup> | .33 in. <sup>2</sup> | .98 in. <sup>2</sup> |



| LD2P10 – Left        | LDP210 – Right       |
|----------------------|----------------------|
| .43 in. <sup>2</sup> | .50 in. <sup>2</sup> |



| LDS3                 | LDS5                 |
|----------------------|----------------------|
| .21 in. <sup>2</sup> | .38 in. <sup>2</sup> |

D1. Terminals

D2. Power Connectors

**SPEC = 40% cable fill** – The recommended design in cable capacity, leaves room for future moves, adds, and changes.

**MAX for Data = 60% cable fill** – The maximum cable quantity based on cable interweaving and packing factors.

**MAX for Power cable fill** – The maximum of electrical cables based on UL temperature rise test.

D3. Grounding Connectors

E1. Labeling Systems

E2. Labels

E3. Pre-Printed & Write-On Markers

E4. Permanent Identification

E5. Lockout/Tagout & Safety Solutions

F. Index

| Raceway Type and Configuration | Fill Area (In. <sup>2</sup> ) | Electrical Cables |        |        | Data Grade Cables  |       | Data Grade Cables    |       | Audio/Video  |       | Fiber Optic Cable |       |
|--------------------------------|-------------------------------|-------------------|--------|--------|--------------------|-------|----------------------|-------|--------------|-------|-------------------|-------|
|                                |                               | 14 AWG            | 12 AWG | 10 AWG | 23/24 AWG/UTP      |       | 23 AWG/UTP CM        |       | RG6          |       | 2 Strand          |       |
|                                |                               | THHN/T90          |        |        | Category 6 (4-pr.) |       | Augmented Category 6 |       |              |       |                   |       |
|                                |                               | 0.111             | 0.130  | 0.164  | Dia. = 0.250       |       | Dia. = 0.354         |       | Dia. = 0.275 |       | Dia. = 0.175      |       |
|                                |                               | FILL              |        |        | FILL               |       | FILL                 |       | FILL         |       | FILL              |       |
| MAX                            | MAX                           | MAX               | SPEC   | MAX    | SPEC               | MAX   | SPEC                 | MAX   | SPEC         | MAX   | SPEC              |       |
| (UL Temp Rise Test)            |                               |                   | (40%)  | (60%)  | (40%)              | (60%) | (40%)                | (60%) | (40%)        | (60%) | (40%)             | (60%) |
| <b>LD3</b>                     | 0.21                          | —                 | —      | —      | 1                  | 2     | 0                    | 1     | 1            | 2     | 3                 | 5     |
| <b>LD5</b>                     | 0.38                          | —                 | —      | —      | 3                  | 4     | 1                    | 2     | 2            | 3     | 6                 | 9     |
| <b>LD10</b>                    | 1.00                          | —                 | —      | —      | 8                  | 12    | 4                    | 7     | 6            | 10    | 16                | 24    |
| <b>LDPH3</b>                   | 0.17                          | 9                 | 7      | 4      | 1                  | 2     | 0                    | 1     | 1            | 1     | 2                 | 4     |
| <b>LDPH5</b>                   | 0.33                          | 14                | 12     | 8      | 2                  | 4     | 1                    | 2     | 2            | 3     | 5                 | 8     |
| <b>LDPH10</b>                  | 0.89                          | 18                | 18     | 16     | 7                  | 10    | 4                    | 6     | 5            | 8     | 14                | 22    |
| <b>LD2P10 – Left channel</b>   | 0.43                          | 14                | 11     | 8      | —                  | —     | —                    | —     | —            | —     | —                 | —     |
| <b>LD2P10 – Right channel</b>  | 0.50                          | —                 | —      | —      | 4                  | 6     | 2                    | 3     | 3            | 5     | 8                 | 12    |
| <b>LDS3</b>                    | 0.21                          | 9                 | 6      | 4      | 1                  | 2     | 0                    | 1     | 1            | 2     | 3                 | 5     |
| <b>LDS5</b>                    | 0.38                          | 10                | 8      | 5      | 3                  | 4     | 1                    | 2     | 2            | 3     | 6                 | 9     |

AWG dimensions represent typical outer cable diameter in inches.



## Floor Guard

- Accessory to route cables over carpet, concrete, or tile to prevent tripping
- Flexible vinyl material can be easily cut to specific lengths
- Cables route through underside of product



FG1  
FG3  
FG5

| Part Number | Part Description   | Color‡         | Std. Pkg. Qty. |
|-------------|--|----------------|----------------|
| FG1EI5.0-A  | Flexible vinyl material used to route cabling over carpet, tile, and concrete. Product available in 5' strips. | Electric Ivory | 5              |
| FG1EI50.0-A | Flexible vinyl material used to route cabling over carpet, tile, and concrete. Product available in 50' rolls. | Electric Ivory | 50             |
| FG3EI5.0-A  | Flexible vinyl material used to route cabling over carpet, tile, and concrete. Product available in 5' strips. | Electric Ivory | 5              |
| FG3EI50.0-A | Flexible vinyl material used to route cabling over carpet, tile, and concrete. Product available in 50' rolls. | Electric Ivory | 50             |
| FG5EI5.0-A  | Flexible vinyl material used to route cabling over carpet, tile, and concrete. Product available in 5' strips. | Electric Ivory | 5              |
| FG5EI25.0-A | Flexible vinyl material used to route cabling over carpet, tile, and concrete. Product available in 25' rolls. | Electric Ivory | 25             |

Standard Package Quantity listed is in Feet.

‡For other colors replace EI (Electric Ivory) with BR (Brown), YL (Safety Yellow), or BL (Black).

## Pan-Way® Surface Raceway Cutting Tool



| Part Number | Part Description   | Std. Pkg. Qty. | Std. Ctn. Qty. |
|-------------|--|----------------|----------------|
| SRT         | Used to cut all LD profile raceway. Leaves a clean burr-free finish on raceway. Can also be used to cut plastic conduit. | 1              | 10             |

A.  
System  
Overview

B1.  
Cable Ties

B2.  
Cable  
Accessories

B3.  
Stainless  
Steel Ties

C1.  
Wiring  
Duct

C2.  
Surface  
Raceway

C3.  
Abrasion  
Protection

C4.  
Cable  
Management

D1.  
Terminals

D2.  
Power  
Connectors

D3.  
Grounding  
Connectors

E1.  
Labeling  
Systems

E2.  
Labels

E3.  
Pre-Printed  
& Write-On  
Markers

E4.  
Permanent  
Identification

E5.  
Lockout/  
Tagout  
& Safety  
Solutions

F.  
Index

A.  
System  
Overview

## Foam Tape

B1.  
Cable Ties

• Acrylic foam tape – Recommended for high temperature and outdoor applications (180°F) and exposure to UV light

• Rubber foam tape – Excellent quick tack designed for long term shear loads in indoor applications up to 120°F

B2.  
Cable  
Accessories



**P32W2A2**  
**P32W2R1**

B3.  
Stainless  
Steel Ties

C1.  
Wiring  
Duct

C2.  
Surface  
Raceway

C3.  
Abrasion  
Protection

C4.  
Cable  
Management

D1.  
Terminals

D2.  
Power  
Connectors

D3.  
Grounding  
Connectors

E1.  
Labeling  
Systems

E2.  
Labels

E3.  
Pre-Printed  
& Write-On  
Markers

E4.  
Permanent  
Identification

E5.  
Lockout/  
Tagout  
& Safety  
Solutions

F.  
Index

| Part Number                               | Part Description   | Color | Std. Pkg. Qty. | Std. Ctn. Qty. |
|---|--|-------|----------------|----------------|
| <b>1/32" Thick White Acrylic Adhesive</b> |  |       |                |                |
| <b>P32W2A2-50-7</b>                       | Foam tape, 1/32" (thick) x .50" (wide) x 7 yards, acrylic adhesive.  | White | 1              | 100            |
| <b>P32W2A2-75-7</b>                       | Foam tape, 1/32" (thick) x .75" (wide) x 7 yards, acrylic adhesive.  | White | 1              | 60             |
| <b>P32W2A2-100-7</b>                      | Foam tape, 1/32" (thick) x 1" (wide) x 7 yards, acrylic adhesive.    | White | 1              | 50             |
| <b>P32W2A2-50-72</b>                      | Foam tape, 1/32" (thick) x .50" (wide) x 72 yards, acrylic adhesive. | White | 1              | 9              |
| <b>P32W2A2-75-72</b>                      | Foam tape, 1/32" (thick) x .75" (wide) x 72 yards, acrylic adhesive. | White | 1              | 7              |
| <b>P32W2A2-100-72</b>                     | Foam tape, 1/32" (thick) x 1" (wide) x 72 yards, acrylic adhesive.   | White | 1              | 5              |
| <b>1/32" Thick White Rubber Adhesive</b>  |  |       |                |                |
| <b>P32W2R1-50-7</b>                       | Foam tape, 1/32" (thick) x .50" (wide) x 7 yards, rubber adhesive.   | White | 1              | 100            |
| <b>P32W2R1-75-7</b>                       | Foam tape, 1/32" (thick) x .75" (wide) x 7 yards, rubber adhesive.   | White | 1              | 60             |
| <b>P32W2R1-100-7</b>                      | Foam tape, 1/32" (thick) x 1" (wide) x 7 yards, rubber adhesive.     | White | 1              | 50             |
| <b>P32W2R1-50-72</b>                      | Foam tape, 1/32" (thick) x .50" (wide) x 72 yards, rubber adhesive.  | White | 1              | 9              |
| <b>P32W2R1-75-72</b>                      | Foam tape, 1/32" (thick) x .75" (wide) x 72 yards, rubber adhesive.  | White | 1              | 7              |
| <b>P32W2R1-100-72</b>                     | Foam tape, 1/32" (thick) x 1" (wide) x 72 yards, rubber adhesive.    | White | 1              | 5              |
| <b>P32W2R1-150-72</b>                     | Foam tape, 1/32" (thick) x 1.5" (wide) x 72 yards, rubber adhesive.  | White | 1              | 4              |

## PAN-WAY® COVE RACEWAY

Pan-Way® Cove Raceway is a full line of NEC and TIA/EIA compliant raceway, which has the appearance of architectural molding; that allows you to route, conceal, protect and terminate copper, voice, video, fiber optic or power cabling. This offering adds elegance to any room or work area by softening the horizontal angles between the wall and ceiling or the vertical angles between two walls.



- UL and CSA rated 600 V
- Bend radius control is maintained throughout the entire system as required by TIA/EIA-568-B and 569-B
- Product mounts high out of reach for increased tamper resistance
- Divided channel system allows for routing and terminations of both power and data cabling
- Raceway and fitting covers may be painted to match any décor



Pan-Way® Cove Raceway includes a full complement of fittings and transitions easily to other Panduit raceway such as LD, LDPH, LD2P10, T-45 and T-70.

A.  
System  
Overview

B1.  
Cable Ties

B2.  
Cable  
Accessories

B3.  
Stainless  
Steel Ties

C1.  
Wiring  
Duct

C2.  
Surface  
Raceway

C3.  
Abrasion  
Protection

C4.  
Cable  
Management

D1.  
Terminals

D2.  
Power  
Connectors

D3.  
Grounding  
Connectors

E1.  
Labeling  
Systems

E2.  
Labels

E3.  
Pre-Printed  
& Write-On  
Markers

E4.  
Permanent  
Identification

E5.  
Lockout/  
Tagout  
& Safety  
Solutions

F.  
Index



A.  
System  
Overview

B1.  
Cable Ties

B2.  
Cable  
Accessories

B3.  
Stainless  
Steel Ties

C1.  
Wiring  
Duct

C2.  
Surface  
Raceway

C3.  
Abrasion  
Protection

C4.  
Cable  
Management

D1.  
Terminals

D2.  
Power  
Connectors

D3.  
Grounding  
Connectors

E1.  
Labeling  
Systems

E2.  
Labels

E3.  
Pre-Printed  
& Write-On  
Markers

E4.  
Permanent  
Identification

E5.  
Lockout/  
Tagout  
& Safety  
Solutions

F.  
Index

## Cove Raceway Roadmap

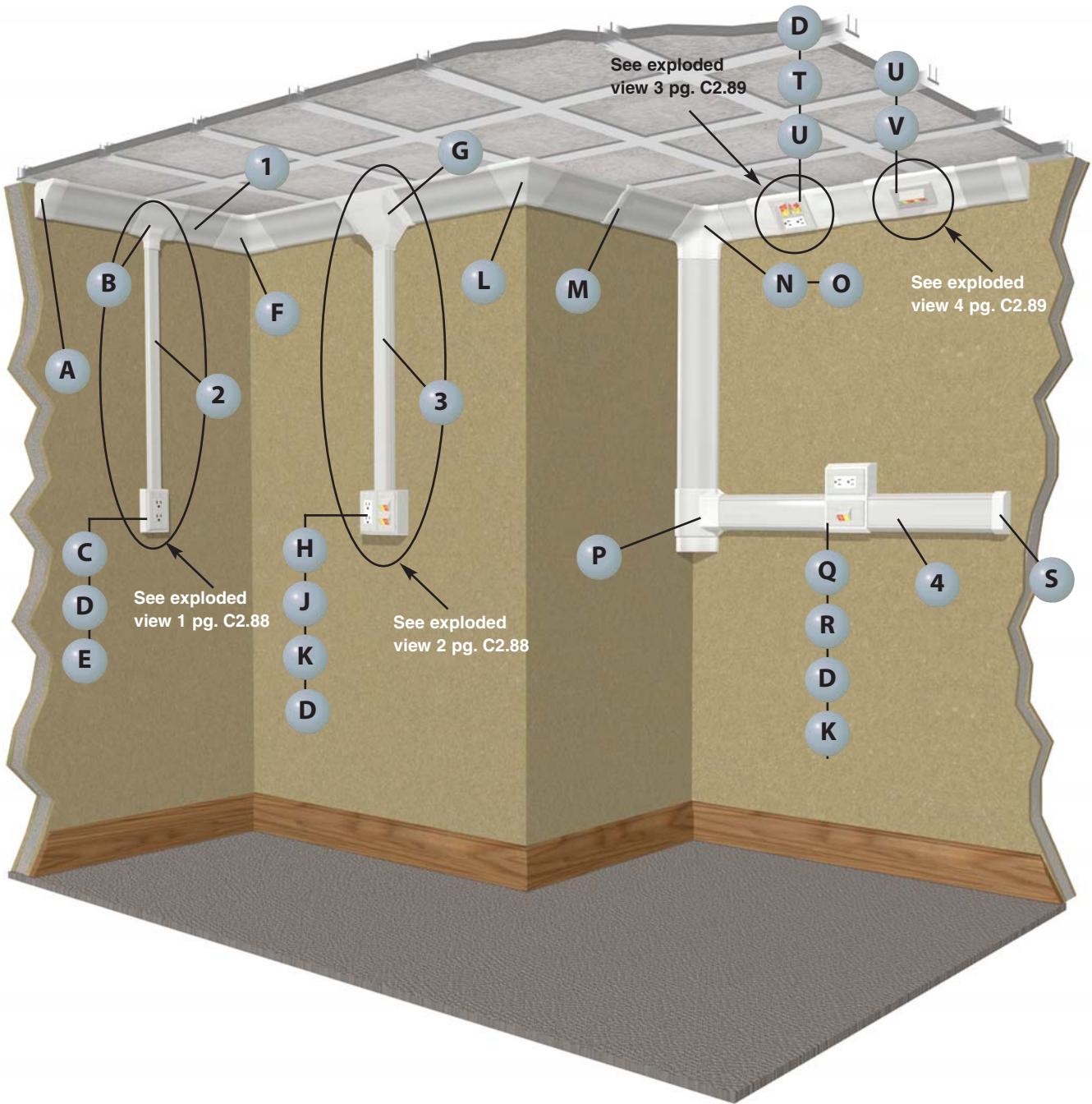

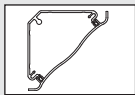

**1** WCM35BIW, WCM35CIW – Cove Raceway Base and Cover (page C2.90)

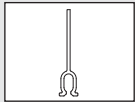

**1** WCM35DW – Cove Raceway Divider Wall (page C2.90)

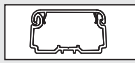

**2** LDPH10\*\* – LDPH10 Raceway (page C2.77)

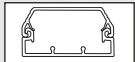

**3** T45B\*\*, T45C\*\* – T-45 Raceway Base and Cover (page C2.48)

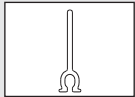

**3** T45DW – T-45 Raceway Divider Wall (page C2.48)

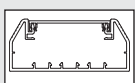

**4** T70B\*\*, T70C\*\* – T-70 Raceway Base and Cover (page C2.36)

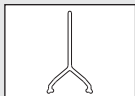

**4** T70DW – T-70 Raceway Divider Wall (page C2.36)

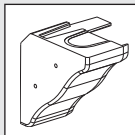

**A** WCM35ECIW – Cove Raceway End Cap (page C2.91)

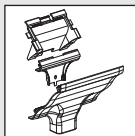

**B** WCM35TR10IW – Cove Raceway Low Profile Transition Fitting for LD/LDPH10 Raceway (page C2.91)

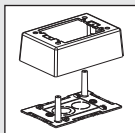

**C** JBP1\*\* – Power Rated Single Gang Two-Piece Box (page C2.58)

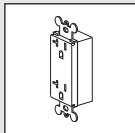

**D** ERU20\*\* – 20 A Rectangular Outlet (page C2.61)

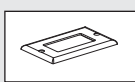

**E** CPG\*\* – Single Gang Rectangular Electrical/Communication Screw-On Faceplate (page C2.60)

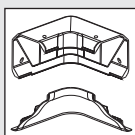

**F** WCM35ICIW – Cove Raceway Inside Corner Fitting (page C2.91)

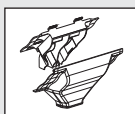

**G** WCM35TRIW – Cove Raceway Transition Fitting for T-45 and LD Series Raceways (page C2.91)

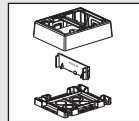

**H** JBP2F5\*\* – Fast-Snap™ Double Gang Power Rated Surface Mount Outlet Box (page C2.52)

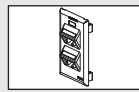

**J** UIT70FV4\*\* – Ultimate ID® Sloped Vertical Snap-On Faceplate (see SA-NCCB51)

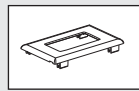

**K** T70PG\*\* – Single Gang Rectangular Electrical/Communication Snap-On Faceplate (page C2.53)

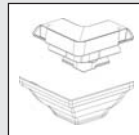

**L** WCM35OCIW – Cove Raceway Outside Corner Fitting (page C2.91)



**M** WCM35CCIW – Cove Raceway Cover Coupler Fitting (page C2.91)

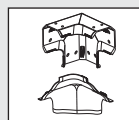

**N** WCM35TIW – Cove Raceway Tee Fitting (page C2.91)

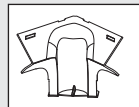

**O** WCM35TI – Cove Raceway Tee Fitting Insert (page C2.91)



**P** WCM35TR70IW – Cove Raceway Low Profile Transition Fitting for T-70 Raceway (page C2.91)



**Q** T70WC2\*\* – T-70 Workstation Outlet Center™ Offset Box for Snap-On Faceplates (page C2.37)

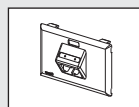

**R** UIT70FH2\*\* – Ultimate ID® Horizontal Snap-On Faceplate (see SA-NCCB51)



**S** T70EC\*\* – T70 Raceway End Cap Fitting (page C2.37)

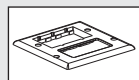

**T** FP2RC\*\* – Double Gang Rectangular Electrical and Communication Faceplate (page C2.60)

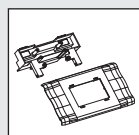

**U** WCM35DBFIW – Cove Raceway Device Box and Faceplate Adapter (page C2.91)

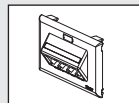

**V** UIT70FH4\*\* – Ultimate ID® Horizontal Snap-On Faceplate (see SA-NCCB51)

A.  
System  
Overview

## Cove Configurations

B1.  
Cable Ties

### Exploded View 1

|    | Components Required   | See page |
|----|---|----------|
| A. | WCM35TR10 = Cove raceway low profile transition fitting for LD/LDP10 raceway. | C2.91    |
| B. | JBP1 = Power rated single gang two-piece box.                                 | C2.58    |
| C. | ERU20 = 20 A rectangular electrical outlet (screws included).                 | C2.61    |
| D. | CPG = Screw-on single gang rectangular faceplate.                             | C2.60    |

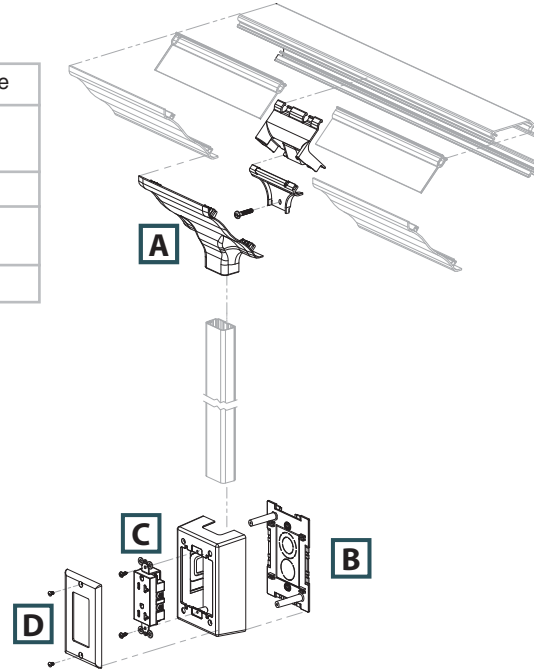

C1.  
Wiring  
Duct

C2.  
Surface  
Raceway

C3.  
Abrasion  
Protection

C4.  
Cable  
Management

### Exploded View 2

|    | Components Required   | See page |
|----|---|----------|
| A. | WCM35TR = Cove raceway transition fitting.                                  | C2.91    |
| B. | JBP2FS = Fast-Snap™ Double Gang Power Rated Surface Mount Outlet Box.       | C2.52    |
| C. | Mini-Com® Modules.  | —        |
| D. | T70PG = Single gang rectangular electrical/communication snap-on faceplate. | C2.53    |
| E. | UIT70FV4 = Ultimate ID® Sloped Vertical Snap-On Faceplate.                  | —        |
| F. | ERU20 = 20 A rectangular electrical outlet (screws included).               | C2.61    |

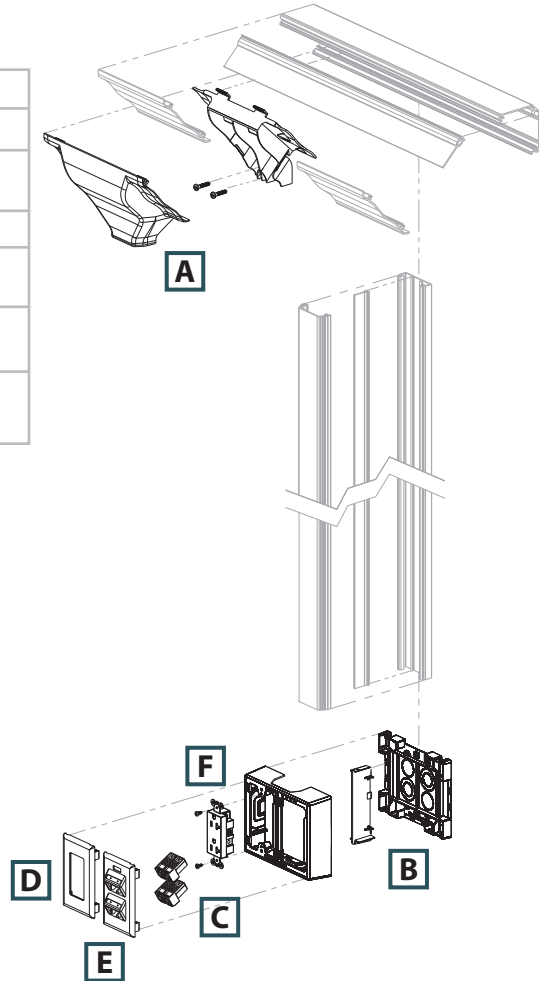

D1.  
Terminals

D2.  
Power  
Connectors

D3.  
Grounding  
Connectors

E1.  
Labeling  
Systems

E2.  
Labels

E3.  
Pre-Printed  
& Write-On  
Markers

E4.  
Permanent  
Identification

E5.  
Lockout/  
Tagout  
& Safety  
Solutions

F.  
Index

## Cove Configurations (continued)

### Exploded View 3

|    | Components Required   | See page |
|----|---|----------|
| A. | WCM35DBF = Cove raceway device box and faceplate adapter.               | C2.91    |
| B. | FP2RC = Pan-Way® Classic Series Faceplates for power and communication. | C2.60    |
| C. | Mini-Com® Modules.  | —        |
| D. | ERU20 = 20 A rectangular electrical outlet (screws included).           | C2.61    |

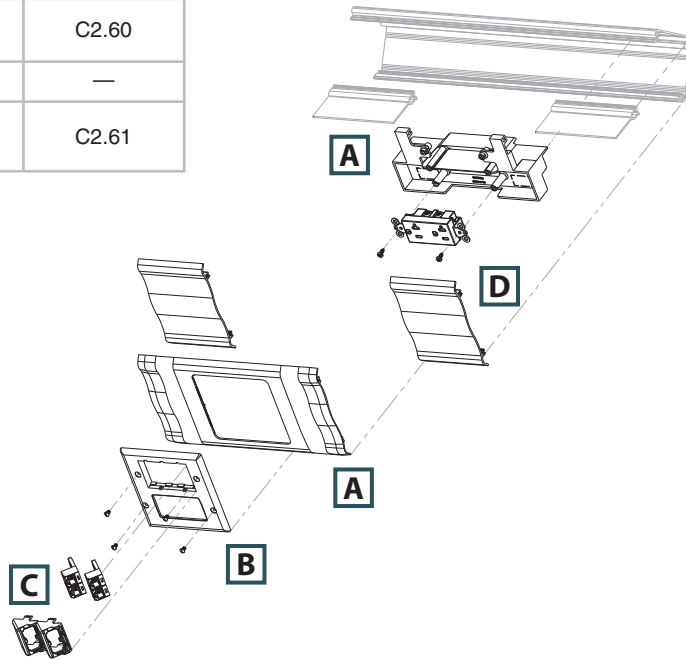

### Exploded View 4

|    | Components Required                                       | See page |
|----|---|----------|
| A. | WCM35DBF = Cove raceway device box and faceplate adapter. | C2.91    |
| B. | Mini-Com® Modules.  | —        |
| C. | UIT70FH4 = Ultimate ID® Horizontal Snap-On Faceplate.     | —        |

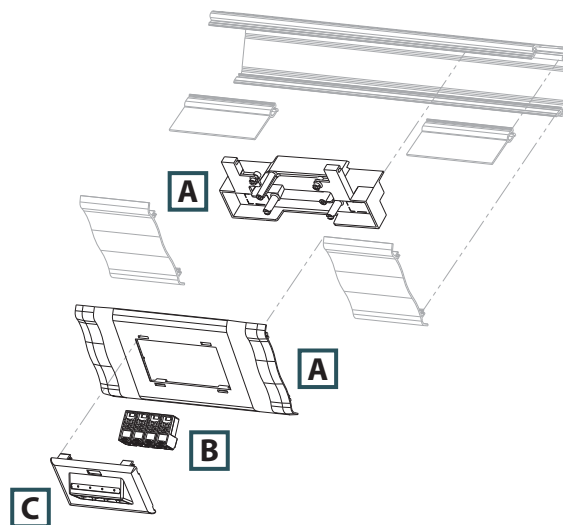

A.  
System  
Overview

B1.  
Cable Ties

B2.  
Cable  
Accessories

B3.  
Stainless  
Steel Ties

C1.  
Wiring  
Duct

C2.  
Surface  
Raceway

C3.  
Abrasion  
Protection

C4.  
Cable  
Management

D1.  
Terminals

D2.  
Power  
Connectors

D3.  
Grounding  
Connectors

E1.  
Labeling  
Systems

E2.  
Labels

E3.  
Pre-Printed  
& Write-On  
Markers

E4.  
Permanent  
Identification

E5.  
Lockout/  
Tagout  
& Safety  
Solutions

F.  
Index

A. System Overview



## Pan-Way® Cove Raceway System

B1. Cable Ties

- UL and CSA rated 600 V; meets UL 5A and CSA C22.2 No. 62.1-03 standards; FT4 rated
- Bend radius control is maintained throughout the entire cove raceway system as required by TIA/EIA-568-B and 569-B

- Tamper resistant
- Transitions to Panduit T-70, T-45, and LD profile raceway
- Cove raceway and fittings may be painted to blend with any decor
- Supplied with pre-punched mounting holes

B2. Cable Accessories

B3. Stainless Steel Ties

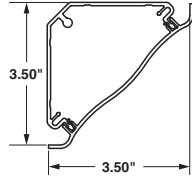

COVE RACEWAY  
Internal Area = 5.40 Sq. In.  
(3484 Sq. mm)

C1. Wiring Duct

C2. Surface Raceway



WCM35B

C3. Abrasion Protection

C4. Cable Management



WCM35C

D1. Terminals

D2. Power Connectors

D3. Grounding Connectors

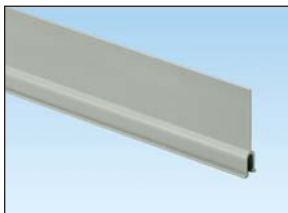

WCM35DW

E1. Labeling Systems

E2. Labels

E3. Pre-Printed & Write-On Markers

E4. Permanent Identification

E5. Lockout/Tagout & Safety Solutions

F. Index

| Part Number                      | Part Description  | Raceway Size                    | Color†    | Length (Ft.) | Std. Ctn. Qty. |
|----------------------------------|---|---------------------------------|-----------|--------------|----------------|
| <b>Cove Raceway Base</b>         |   |                                 |           |              |                |
| <b>WCM35BIW8</b>                 | Cove raceway base is available in 8' lengths and is used for mounting in the horizontal corner between the ceiling and wall or vertical corner between walls.                           | 3.50" x 3.50" (89.0mm x 89.0mm) | Off White | 8            | 64             |
| <b>Cove Raceway Cover</b>        |   |                                 |           |              |                |
| <b>WCM35CIW8</b>                 | Cove raceway cover available in 8' lengths.   | —                               | Off White | 8            | 64             |
| <b>Cove Raceway Divider Wall</b> |   |                                 |           |              |                |
| <b>WCM35DW8</b>                  | Cove raceway divider wall. Snaps onto rails in cove raceway base to create separate channels. Must use wire retainers to ensure channel separation per UL/CSA. Available in 8' lengths. | —                               | Gray      | 8            | 64             |







†All parts available in IW (Off White) only except for WCM35DW8 which is available in gray only.  
Order number of feet required in multiples of standard carton quantity.  
Order raceway base and cover separately.



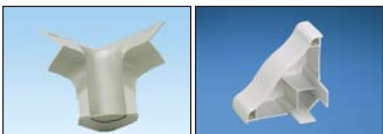
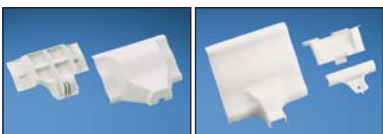

## Pan-Way® Cove Raceway Fittings

- Cove raceway fittings are designed to maintain the TIA/EIA-568-B and 569-B required minimum bend radius for high performance copper and fiber optic cabling systems

| Part Number   | Part Description  | Color‡    | Std. Pkg. Qty. | Std. Ctn. Qty. |
|---|---|-----------|----------------|----------------|
|  <p><b>WCM35CC</b>      <b>WCM35IC</b></p>       | <b>WCM35CCIW-X</b> Cover coupler fittings. Used to join two pieces of cove raceway cover together.  | Off White | 10             | 100            |
|  <p><b>WCM35ICIW</b>      <b>WCM35OCIW</b></p>   | <b>WCM35ICIW</b> Inside corner fitting. Used to join cove raceway at inside corners. Maintains a minimum 1" bend radius of cabling.   | Off White | 1              | 10             |
|  <p><b>WCM35OC</b>      <b>WCM35T</b></p>        | <b>WCM35OCIW</b> Outside corner fitting. Used to join cove raceway at outside corners. Maintains a minimum 1" bend radius of cabling.   | Off White | 1              | 10             |
|  <p><b>WCM35TI</b>      <b>WCM35EC</b></p>      | <b>WCM35TIW</b> Tee fitting. Used to join sections of cove raceway to form a "tee" junction. Maintains a minimum 1" bend radius of cabling.   | Off White | 1              | 10             |
|  <p><b>WCM35TR</b>      <b>WCM35TR5</b></p>    | <b>WCM35TI</b> Tee fitting insert. Mounts inside cove raceway tee fitting to maintain channel separation at tee junctions. Maintains a minimum 1" bend radius of cabling.   | Gray      | 1              | 10             |
|  <p><b>WCM35TR10</b>      <b>WCM35TR70</b></p> | <b>WCM35ECIW</b> End cap fitting. Used to terminate or enter cove raceway. Includes breakouts for 1/2" and 3/4" conduit.  | Off White | 1              | 10             |
|  <p><b>WCM35TR</b>      <b>WCM35TR5</b></p>    | <b>WCM35TRIW</b> Transition fitting. Used to transition from cove raceway to Pan-Way® T-45 raceway or LD profile raceway.   | Off White | 1              | 10             |
|  <p><b>WCM35TR10</b>      <b>WCM35TR70</b></p> | <b>WCM35TR5IW</b> Low profile transition fitting. Used to transition from cove raceway to LD/LDPH5.   | Off White | 1              | 10             |
|   | <b>WCM35TR10IW</b> Low profile transition fitting. Used to transition from cove raceway to LD/LDPH10.   | Off White | 1              | 10             |
|   | <b>WCM35TR70IW</b> Low profile transition fitting. Used to transition from cove raceway to T-70.  | Off White | 1              | 10             |
|   | <b>WCM35DBFIW</b> Device box and faceplate adapter. Used in cove raceway to install single or double gang power and/or data devices in-line. Will accept snap-on or screw-on single gang faceplate or screw-on double gang faceplate. Note: Will accept GFCI or TVSS outlets in single gang configuration only. | Off White | 1              | 10             |
|   | <b>WCM35BFIW</b> Backfeed fitting. Inserts allow cable entry and exit through the back of the raceway and conduit. Breakouts include 1/2", 3/4", and 1".  | Off White | 1              | 10             |
|   | <b>WCM35WR-X</b> Wire retainer. Holds wires in place. Will not interfere with cover installation.   | Gray      | 10             | —              |

‡All parts available in IW (Off White) only except WCM35WR-X and WCM35TI which are available in gray only.

A. System Overview

B1. Cable Ties

B2. Cable Accessories

B3. Stainless Steel Ties

C1. Wiring Duct

C2. Surface Raceway

C3. Abrasion Protection

C4. Cable Management

D1. Terminals

D2. Power Connectors

D3. Grounding Connectors

E1. Labeling Systems

E2. Labels

E3. Pre-Printed & Write-On Markers

E4. Permanent Identification

E5. Lockout/Tagout & Safety Solutions

F. Index

A. System Overview

## Cable Fill Capacities for Cove Raceway

This information is to be used as a guide in selecting the proper size raceway. The maximum amounts may vary according to the cable installation methods, straightness of cables, etc.

B1. Cable Ties

B2. Cable Accessories

B3. Stainless Steel Ties

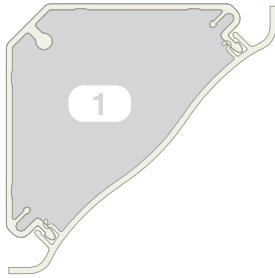

A = 5.4 in.²

**Cable fill #1:** Open channel without devices.



A = 5.0 in.²

**Cable fill #2:** Open channel with wire retainer.



3A = 2.4 in.²    3B = 2.4 in.²

**Cable fill #3:** Divided channel (power and data) with wire retainer and divider wall.

C2. Surface Raceway

C3. Abrasion Protection

C4. Cable Management

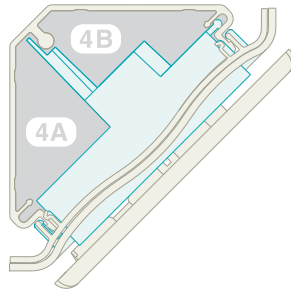

A = 1.6 in.²

A = 1.4 in.²

**Cable fill #4:** Divided channel (power and data) with device box and faceplate.



A = 1.8 in.²

A = 2.4 in.²

**Cable fill #5:** Divided channel (power and data) with low profile transition insert.

D1. Terminals

D2. Power Connectors

D3. Grounding Connectors

**SPEC = 40% cable fill** – The recommended design in cable capacity, leaves room for future moves, adds, and changes.

**MAX for Data = 60% cable fill** – The maximum cable quantity based on cable interweaving and packing factors.

**MAX for Power cable fill** – The maximum of electrical cables based on UL temperature rise test.

E1. Labeling Systems

E2. Labels

E3. Pre-Printed & Write-On Markers

E4. Permanent Identification

E5. Lockout/Tagout & Safety Solutions

F. Index

| Raceway Type and Configuration                                    | Fill Area (In.²) | Electrical Cables |        |        | Data Grade Cables |     | Data Grade Cables |     | Audio/Video  |     | Fiber Optic Cable |     |
|---|------------------|-------------------|--------|--------|-------------------|-----|-------------------|-----|--------------|-----|-------------------|-----|
|   |                  | 14 AWG            | 12 AWG | 10 AWG | 24 AWG/UTP CM     |     | 24 AWG/UTP CM     |     | RG6          |     | 2 Strand          |     |
|   |                  | THHN/T90          |        |        | Category 6        |     | Category 6A       |     |              |     |                   |     |
|   |                  | 0.111             | 0.130  | 0.164  | Dia. = 0.250      |     | Dia. = 0.330      |     | Dia. = 0.275 |     | Dia. = 0.175      |     |
|   |                  | FILL              |        |        | FILL              |     | FILL              |     | FILL         |     | FILL              |     |
|   |                  | MAX               | MAX    | MAX    | SPEC              | MAX | SPEC              | MAX | SPEC         | MAX | SPEC              | MAX |
| 1. WCM35: No devices.   | 5.4              | 50                | 40     | 30     | 44                | 66  | 25                | 37  | 36           | 54  | 89                | 134 |
| 2. WCM35: Using wire retainer – no devices.                       | 5.0              | 50                | 40     | 30     | 40                | 61  | 23                | 35  | 33           | 50  | 83                | 124 |
| 3A. WCM35: Power and data using wire retainer and divider wall.   | 2.4              | —                 | —      | —      | 19                | 29  | 11                | 16  | 16           | 24  | 39                | 59  |
| 3B.   | 2.4              | 30                | 25     | 20     | —                 | —   | —                 | —   | —            | —   | —                 | —   |
| 4A. WCM35: Power and data using device box and faceplate adapter. | 1.6              | —                 | —      | —      | 13                | 19  | 7                 | 11  | 10           | 16  | 26                | 39  |
| 4B.   | 1.4              | 25                | 25     | 20     | —                 | —   | —                 | —   | —            | —   | —                 | —   |
| 5A. WCM35: Power and data using low profile transition insert.    | 1.8              | 25                | 25     | 20     | —                 | —   | —                 | —   | —            | —   | —                 | —   |
| 5B.   | 2.4              | —                 | —      | —      | 20                | 30  | 11                | 17  | 16           | 25  | 41                | 62  |

AWG dimensions represent typical outer cable diameter in inches.

## PAN-WAY® OFFICE FURNITURE RACEWAY

Pan-Way® Office Furniture Raceway is a one-piece single channel system designed to route data cabling along the top of office furniture partitions. Outlets can be positioned at any point along the partition at desk level or in the corner at the intersection of two partitions. Office furniture raceway has a tamper resistant closure design, which protects sensitive cabling from accidental damage and discourages unauthorized access, yet the system is accessible by a qualified installer for moves, adds, and changes.



- Designed for desktop terminations which utilize the typically unused area of the cubicle
- Fittings meet TIA/EIA bend radius requirements preventing cable performance degradation, yet maintain original aesthetic "squared corner" styling of furniture
- Designed to work with major office furniture manufacturer's panels (such as STEELCASE\*, HERMAN MILLER™ and others)
- Robust design includes a one-piece hinge and tamper resistant closure design which increases product stability and reduces inadvertent or unauthorized access to data cabling
- Designed for use with Panduit connectivity; also accepts common manufacturers' connectivity with use of a NEMA standard 70mm faceplate or module frame

The system includes a full complement of fittings, accessories, and termination options. Pan-Way® Office Furniture Raceway is available in four popular colors to blend with most office furniture systems and creates a virtually invisible cost effective routing solution.

\*STEELCASE is a registered trademark of Steelcase Development, Inc.

™HERMAN MILLER is a registered trademark of Herman Miller, Inc., Zeeland MI.

A.  
System  
Overview

B1.  
Cable Ties

B2.  
Cable  
Accessories

B3.  
Stainless  
Steel Ties

C1.  
Wiring  
Duct

C2.  
Surface  
Raceway

C3.  
Abrasion  
Protection

C4.  
Cable  
Management

D1.  
Terminals

D2.  
Power  
Connectors

D3.  
Grounding  
Connectors

E1.  
Labeling  
Systems

E2.  
Labels

E3.  
Pre-Printed  
& Write-On  
Markers

E4.  
Permanent  
Identification

E5.  
Lockout/  
Tagout  
& Safety  
Solutions

F.  
Index

A.  
System  
Overview

## Office Furniture Raceway Roadmap

B1.  
Cable Ties

B2.  
Cable  
Accessories

B3.  
Stainless  
Steel Ties

C1.  
Wiring  
Duct

C2.  
Surface  
Raceway

C3.  
Abrasion  
Protection

C4.  
Cable  
Management

D1.  
Terminals

D2.  
Power  
Connectors

D3.  
Grounding  
Connectors

E1.  
Labeling  
Systems

E2.  
Labels

E3.  
Pre-Printed  
& Write-On  
Markers

E4.  
Permanent  
Identification

E5.  
Lockout/  
Tagout  
& Safety  
Solutions

F.  
Index



Note: Office furniture raceway is designed to blend with its environment. Shown in white on office slate furniture for illustration purposes only.



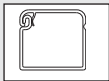

**1** OFR20\*\*6 – Office Furniture Raceway  
(page C2.98)

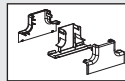

**L** OFR20MPT\*\* – Mid Panel Tee Fitting  
(page C2.100)

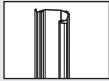

**A** OFCR70\*\*6 – Corner Raceway Base  
(page C2.98)

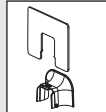

**M** OFR20WE\*\* – Wall Entrance Fitting  
(page C2.100)

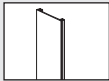

**B** OFCRC70\*\*6 – Corner Raceway Cover  
(page C2.98)

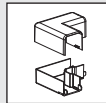

**N** OFR20RA\*\* – Right Angle Fitting  
(page C2.100)

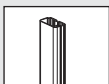

**C** OFVR5\*\*6 – Vertical Raceway  
(page C2.98)

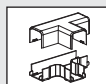

**O** OFR20T\*\* – Tee Fitting (page C2.100)

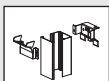

**D** OFR20CP\*\*8 – Communication Pole  
(page C2.99)

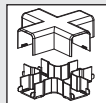

**P** OFR20CR\*\* – Cross Fitting  
(page C2.100)

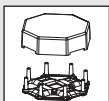

**E** OFR20OFCR70\*\*4 – Four Cubicle Drop  
Fitting (page C2.99)

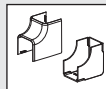

**Q** OFR20IC\*\* – Inside Corner Fitting  
(page C2.101)

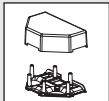

**F** OFR20OFCR70\*\*2 – Two Cubicle Drop  
Fitting (page C2.99)

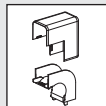

**R** OFR20OC\*\* – Outside Corner Fitting  
(page C2.101)

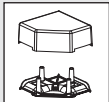

**G** OFR20OFCR70\*\*1 – One Cubicle Drop  
Fitting (page C2.99)



**S** OFR20CC\*\* – Coupler Fitting  
(page C2.101)

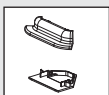

**H** OFCR70EC\*\* – End Cap Fitting  
(page C2.100)

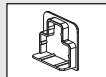

**T** OFR20EC\*\* – End Cap Fitting  
(page C2.101)

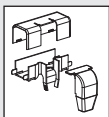

**J** OFR20SO\*\* – Spill-Over Fitting  
(page C2.100)

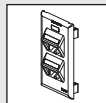

**U** OF70FV4\*\* – Vertical Sloped  
Communication Snap-On Faceplate  
(page C2.101)

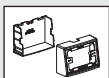

**K** OFR20DMB\*\* – Desk Mount Box  
(page C2.100)

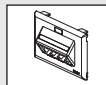

**V** OF70FH4\*\* – Horizontal Sloped  
Communication Snap-On Faceplate  
(page C2.101)



A.  
System  
Overview

## Office Furniture Configurations

B1.  
Cable Ties

### Exploded View 1

B2.  
Cable  
Accessories

|    | Components Required  | See page |
|----|--|----------|
| A. | OFR20OFCR70**4 = Four cubicle drop fitting.                | C2.99    |
| B. | OFCR70**6 = Corner raceway base.                           | C2.98    |
| C. | OFCR70EC = End cap fitting.                                | C2.100   |
| D. | OF70FV4 = Vertical sloped communication snap-on faceplate. | C2.100   |
| E. | Mini-Com® Modules.   | —        |
| F. | OFCRC70**6 = Corner raceway cover.                         | C2.98    |

B3.  
Stainless  
Steel Ties

C1.  
Wiring  
Duct

C2.  
Surface  
Raceway

C3.  
Abrasion  
Protection

C4.  
Cable  
Management

D1.  
Terminals

D2.  
Power  
Connectors

D3.  
Grounding  
Connectors

E1.  
Labeling  
Systems

E2.  
Labels

E3.  
Pre-Printed  
& Write-On  
Markers

E4.  
Permanent  
Identification

E5.  
Lockout/  
Tagout  
& Safety  
Solutions

F.  
Index

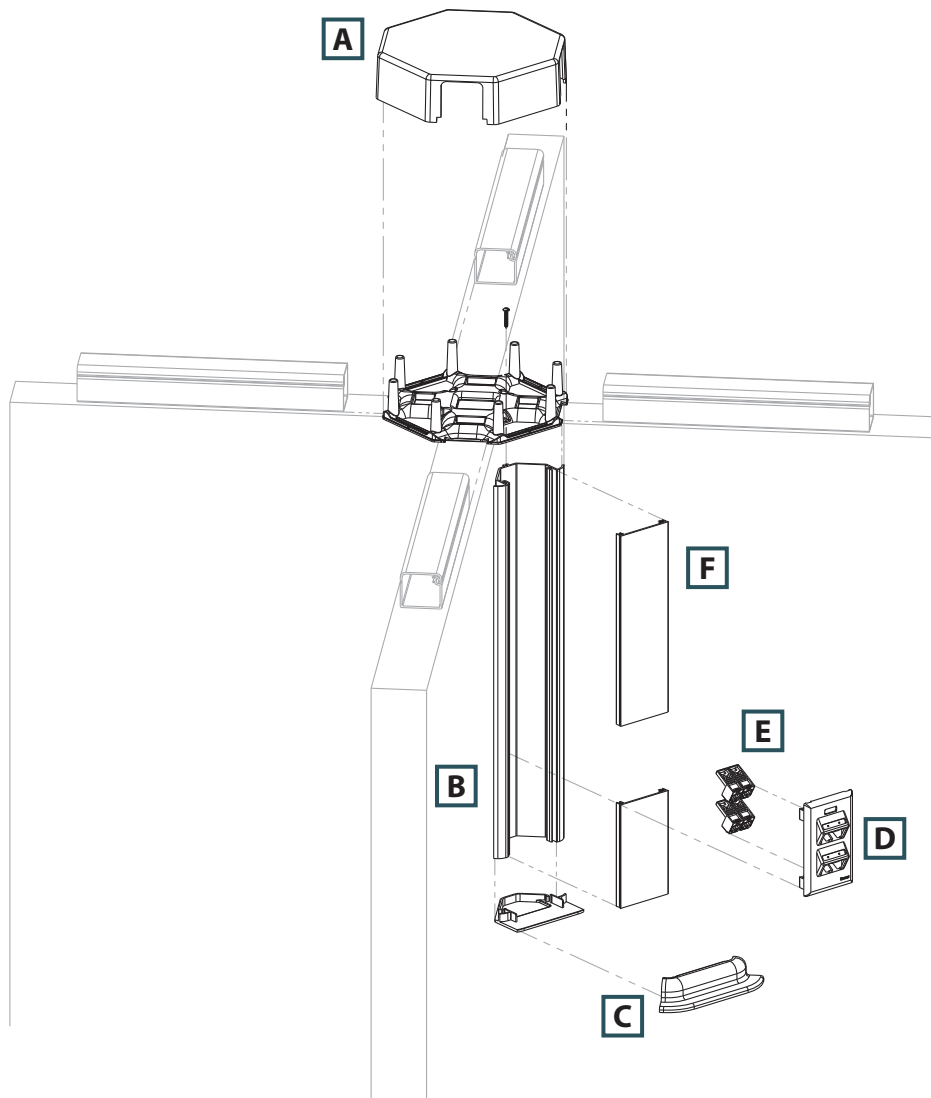

## Office Furniture Configurations (continued)

### Exploded View 2

|    | Components Required  | See page |
|----|--|----------|
| A. | OFR20SO** = Spill-over fitting.                                | C2.100   |
| B. | OFVR5**6 = Vertical raceway.                                   | C2.98    |
| C. | OFR20DMB = Desk mount box.                                     | C2.100   |
| D. | Mini-Com® Modules.   | —        |
| E. | OF70FH4** = Horizontal sloped communication snap-on faceplate. | C2.101   |

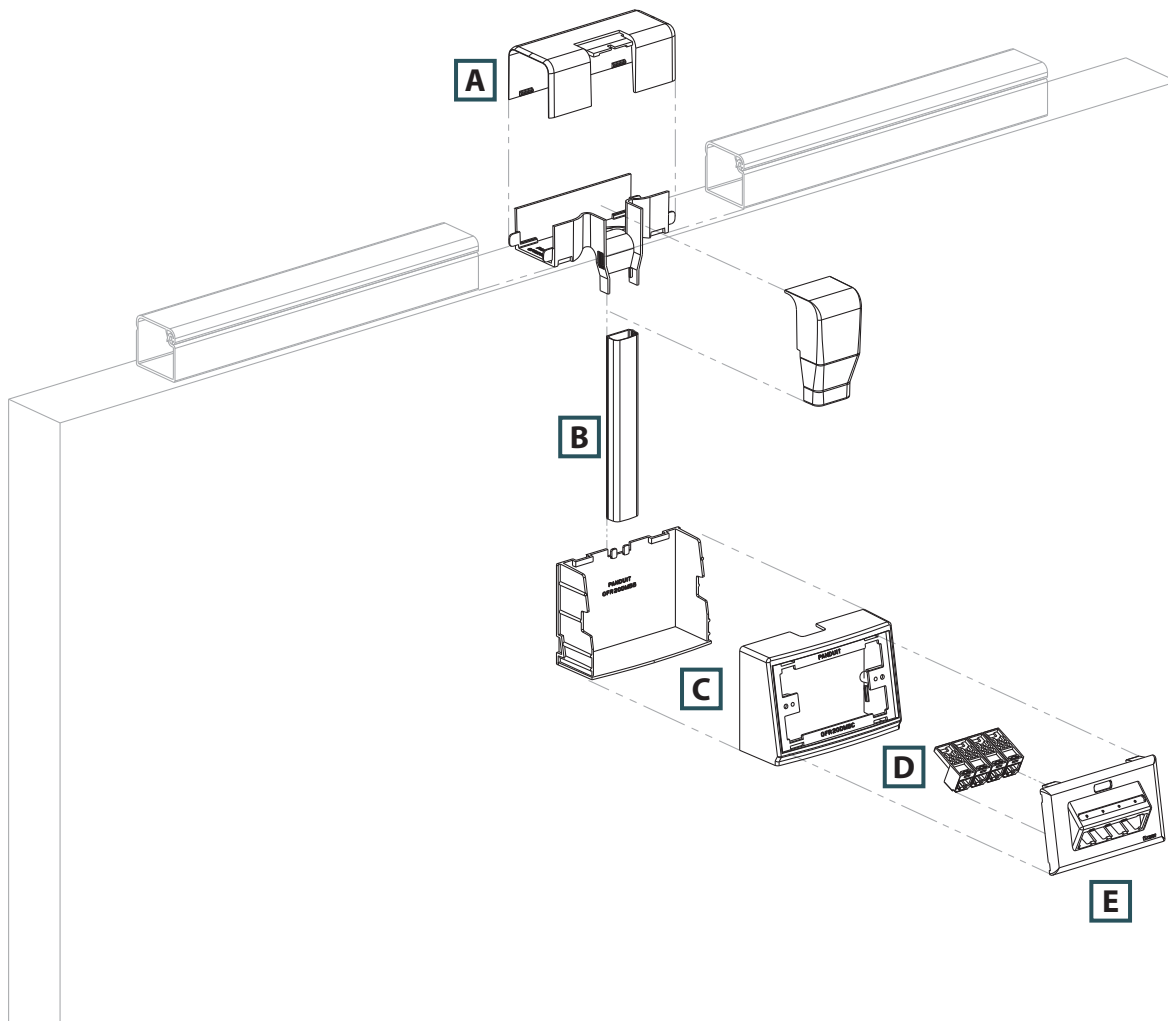

A.  
System  
Overview

B1.  
Cable Ties

B2.  
Cable  
Accessories

B3.  
Stainless  
Steel Ties

C1.  
Wiring  
Duct

C2.  
Surface  
Raceway

C3.  
Abrasion  
Protection

C4.  
Cable  
Management

D1.  
Terminals

D2.  
Power  
Connectors

D3.  
Grounding  
Connectors

E1.  
Labeling  
Systems

E2.  
Labels

E3.  
Pre-Printed  
& Write-On  
Markers

E4.  
Permanent  
Identification

E5.  
Lockout/  
Tagout  
& Safety  
Solutions

F.  
Index

A. System Overview

## Pan-Way® Office Furniture Raceway System

B1. Cable Ties

B2. Cable Accessories

B3. Stainless Steel Ties

C1. Wiring Duct

C2. Surface Raceway

C3. Abrasion Protection

C4. Cable Management

D1. Terminals

D2. Power Connectors

D3. Grounding Connectors

E1. Labeling Systems

E2. Labels

E3. Pre-Printed & Write-On Markers

E4. Permanent Identification

E5. Lockout/Tagout & Safety Solutions

F. Index

- UL listed in accordance with UL 5C requirements for Class 2 Communication Cable Management Systems
- Maintains bend radius control throughout the entire office furniture raceway system as required by TIA/EIA-568-B and 569-B
- Faceplates are compliant with the labeling requirements of the TIA/EIA-606-A standard
- Robust design and tamper resistant closure increases product stability and prevents damage to cabling during and after installation
- Product supplied with adhesive backing for fast and easy installation
- Creates a virtually invisible solution for routing data cables on panels from all common manufacturers with a top cap width between 1.88 and 2.30 inches
- Designed for use with Pan-Net® Connectivity, also accepts all common manufacturers' connectivity with use of a NEMA standard 70mm faceplate or module frame

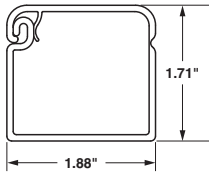

OFFICE FURNITURE RACEWAY  
Internal Area = 2.31 Sq. In.



Office Beige (OB)



Office Gray (OG)



Office Slate (OS)



Medium Tone (MT)



OFR20

| Part Number     | Part Description   | Raceway Size                    | Color‡       | Length (Ft.) | Std. Pkg. Qty. | Std. Ctn. Qty. |
|-----------------|--|---------------------------------|--------------|--------------|----------------|----------------|
| <b>OFR20OB6</b> | One-piece single channel low voltage raceway with adhesive tape backing for data cable routing along top of modular furniture partitions. Available in 6' lengths. | 1.88" x 1.71" (48.0mm x 44.0mm) | Office Beige | 6            | 6              | 48             |
| <b>OFR20OB8</b> | One-piece single channel low voltage raceway with adhesive tape backing for data cable routing along top of modular furniture partitions. Available in 8' lengths. | 1.88" x 1.71" (48.0mm x 44.0mm) | Office Beige | 8            | 8              | 64             |

‡For other colors, replace OB (Office Beige) with OS (Office Slate), OG (Office Gray), or MT (Medium Tone). Order number of feet required in multiples of standard carton quantity.

## Pan-Way® Office Furniture Raceway Fittings

- Office furniture raceway fittings have been designed to maintain the TIA/EIA required 1 inch minimum bend radius for high performance copper and fiber optic cabling systems



OFCR70



OFCRC70



OFVR5

| Part Number       | Part Description  | Labels Required | Color‡       | Std. Pkg. Qty. | Std. Ctn. Qty. |
|-------------------|---|-----------------|--------------|----------------|----------------|
| <b>OFCR70OB6</b>  | Office furniture corner raceway base. Used to terminate low voltage data cabling in the corner at the intersection of modular office furniture panels. Accepts 70mm standard faceplates. Available in 6' lengths. | —               | Office Beige | 6              | 48             |
| <b>OFCRC70OB6</b> | Office furniture corner raceway cover. Available in 6' lengths.   | —               | Office Beige | 6              | 48             |
| <b>OFVR5OB6</b>   | Office furniture vertical raceway. One-piece single channel raceway used to connect OFR20*6 or OFR20*8 to desk mount box (OFR20DMB**) and must be used with OFR20SO** or OFR20DSO**.                              | —               | Office Beige | 6              | 120            |

‡For other colors, replace OB (Office Beige) with OS (Office Slate), OG (Office Gray), or MT (Medium Tone). Computer printable labels found on pages E2.4 and E2.5



## Pan-Way® Office Furniture Raceway Fittings (continued)

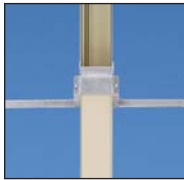

OFR20CP



OFR20OFCR70\*\*4



OFR20OFCR70\*\*2



OFR20OFCR70\*\*1



OFR20OFCR70\*\*1P



OFR20OFCR70\*\*2P



OFR20OFCR70\*\*4P

| Part Number            | Part Description   | Labels Required | Color‡       | Std. Pkg. Qty. | Std. Ctn. Qty. |
|------------------------|--|-----------------|--------------|----------------|----------------|
| <b>OFR20CPOB8</b>      | Communication pole. Allows for data cable entry into office furniture raceway from suspended ceiling. 8' pole allows maximum 7' distance from top of furniture partition to ceiling. Must be used with OFR20MPT**.<br>Note: Not intended for use at intersection of furniture panels.  | —               | Office Beige | 1              | —              |
| <b>OFR20OFCR70OB4</b>  | Four cubicle drop fitting. Allows the transition from office furniture raceway run horizontally along partition wall to office furniture corner raceway mounted vertically in four cubicles at the intersection of partitions. Fitting maintains 1" minimum bend radius of cabling. Supplied with adhesive tape.   | —               | Office Beige | 1              | 10             |
| <b>OFR20OFCR70OB2</b>  | Two cubicle drop fitting. Allows the transition from office furniture raceway run horizontally along partition wall to office furniture corner raceway mounted vertically in two cubicles at the intersection of partitions. Fitting maintains 1" minimum bend radius of cabling. Supplied with adhesive tape.   | —               | Office Beige | 1              | 10             |
| <b>OFR20OFCR70OB1</b>  | One cubicle drop fitting. Allows the transition from office furniture raceway run horizontally along partition wall to office furniture corner raceway mounted vertically in one cubicle at the intersection of partitions. Fitting maintains 1" minimum bend radius of cabling. Supplied with adhesive tape.  | —               | Office Beige | 1              | 10             |
| <b>OFR20OFCR70OB1P</b> | One cubicle drop bypass fitting. Allows the transition from office furniture raceway run horizontally along partition wall, around existing furniture pole, to office furniture corner raceway mounted vertically in one cubicle at the intersection of partitions. Fitting maintains 1" minimum bend radius of cabling. Supplied with adhesive tape.    | —               | Office Beige | 1              | 10             |
| <b>OFR20OFCR70OB2P</b> | Two cubicle drop bypass fitting. Allows the transition from office furniture raceway run horizontally along partition wall, around existing furniture pole, to office furniture corner raceway mounted vertically in two cubicles at the intersection of partitions. Fitting maintains 1" minimum bend radius of cabling. Supplied with adhesive tape.   | —               | Office Beige | 1              | 10             |
| <b>OFR20OFCR70OB4P</b> | Four cubicle drop bypass fitting. Allows the transition from office furniture raceway run horizontally along partition wall, around existing furniture pole, to office furniture corner raceway mounted vertically in four cubicles at the intersection of partitions. Fitting maintains 1" minimum bend radius of cabling. Supplied with adhesive tape. | —               | Office Beige | 1              | 10             |

‡For other colors, replace OB (Office Beige) with OS (Office Slate), OG (Office Gray), or MT (Medium Tone).  
Computer printable labels found on pages E2.4 and E2.5

Table continues on page C2.100

A.  
System  
Overview

B1.  
Cable Ties

B2.  
Cable  
Accessories

B3.  
Stainless  
Steel Ties

C1.  
Wiring  
Duct

C2.  
Surface  
Raceway

C3.  
Abrasion  
Protection

C4.  
Cable  
Management

D1.  
Terminals

D2.  
Power  
Connectors

D3.  
Grounding  
Connectors

E1.  
Labeling  
Systems

E2.  
Labels

E3.  
Pre-Printed  
& Write-On  
Markers

E4.  
Permanent  
Identification

E5.  
Lockout/  
Tagout/  
& Safety  
Solutions

F.  
Index

A. System Overview



## Pan-Way® Office Furniture Raceway Fittings (continued)

B1. Cable Ties



**OFRCR70EC**

B2. Cable Accessories



**OFR20SO**

B3. Stainless Steel Ties



**OFR20DSO**

C1. Wiring Duct



**OFR20DMB**

C2. Surface Raceway



**OFR20MPT**

C3. Abrasion Protection

C4. Cable Management

D1. Terminals

D2. Power Connectors

D3. Grounding Connectors

E1. Labeling Systems

E2. Labels

E3. Pre-Printed & Write-On Markers

E4. Permanent Identification

E5. Lockout/Tagout & Safety Solutions

F. Index

| Part Number       | Part Description  | Labels Required | Color‡       | Std. Pkg. Qty. | Std. Ctn. Qty. |
|-------------------|---|-----------------|--------------|----------------|----------------|
| <b>OFCR70ECOB</b> | Corner raceway end cap fitting. Opening allows cord passage through fitting such as monitor and keyboard cables. Supplied with adhesive tape.   | —               | Office Beige | 1              | 10             |
| <b>OFR20SOOB</b>  | Spill-over fitting. Allows transition from office furniture raceway run horizontally along partition wall to office furniture vertical raceway in one location. Adjustable fitting maintains 1" minimum bend radius of cabling and works with various panel widths between 1.88"– 2.30" (47.7mm - 58mm). Supplied with adhesive tape. | —               | Office Beige | 1              | 10             |
| <b>OFR20DSOOB</b> | Double spill-over fitting. Fitting is used to spill over both sides of the furniture partitions at the same location. Incorporates a built-in, yet removable end cap that eliminates the need for additional raceway and fittings to terminate the pathway.   | —               | Office Beige | 1              | 10             |
| <b>OFR20DMBOB</b> | Desk mount box. Box accepts office furniture snap-on faceplates as well as 70mm NEMA standard screw-on faceplates. Designed for use with OFVR5**6 raceway and OFR20SO**, OFR20DSO** spill-over fittings. Supplied with adhesive tape.   | —               | Office Beige | 1              | 10             |
| <b>OFR20MPTOB</b> | Mid-panel tee fitting. Used to connect communication pole to office furniture raceway run horizontally along partition wall. Supplied with adhesive tape.<br>Note: not intended for use at intersection of furniture panels.  | —               | Office Beige | 1              | 10             |
| <b>OFR20WEOB</b>  | Wall entrance fitting. Allows entry from wall to office furniture raceway run horizontally along partition walls. Fitting includes bend radius protection and trim plate to cover wall opening. Requires minimum wall opening of 4.5"W x 3.0"H (114.3mm x 76.2mm). Supplied with adhesive tape.                                       | —               | Office Beige | 1              | 10             |
| <b>OFR20RAOB</b>  | Right angle fitting. Used to join sections of office furniture raceway at 90° flat junction. Supplied with adhesive tape.   | —               | Office Beige | 1              | 10             |
| <b>OFR20TOB</b>   | Tee fitting. Used to create an undivided tee junction between sections of office furniture raceway. Supplied with adhesive tape.  | —               | Office Beige | 1              | 10             |
| <b>OFR20CROB</b>  | Cross fitting. Used to join sections of office furniture raceway at four corners. Supplied with adhesive tape.  | —               | Office Beige | 1              | 10             |

‡For other colors, replace OB (Office Beige) with OS (Office Slate), OG (Office Gray), or MT (Medium Tone).  
Computer printable labels found on pages E2.4 and E2.5





## Pan-Way® Office Furniture Raceway Fittings (continued)

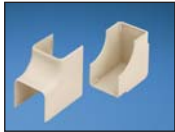

OFR20IC



OFR20OC



OFR20CC

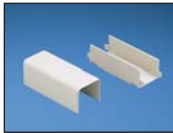

OFR20LC



OFR20EC



OF70FH2



OF70FV2



OF70FH4



OF70FV4



T70SDB-X

| Part Number        | Part Description   | Labels Required           | Color‡       | Std. Pkg. Qty. | Std. Ctn. Qty. |
|--------------------|--|---------------------------|--------------|----------------|----------------|
| <b>OFR20ICOB</b>   | Inside corner fitting. Used to join sections of office furniture raceway at inside corner. Supplied with adhesive tape.  | —                         | Office Beige | 1              | 10             |
| <b>OFR20OCOB</b>   | Outside corner fitting. Used to join sections of office furniture raceway at outside corner. Supplied with adhesive tape.  | —                         | Office Beige | 1              | 10             |
| <b>OFR20CCOB-X</b> | Coupler fitting. For use with office furniture raceway.  | —                         | Office Beige | 10             | 100            |
| <b>OFR20LCOB</b>   | Long coupler fitting (with base). Used to bridge office furniture raceway between panel sections. Can also be used to fill void left by spill-over fitting, when furniture partitions are reconfigured. Supplied with adhesive tape. | —                         | Office Beige | 1              | 10             |
| <b>OFR20ECOB</b>   | End cap fitting. Used to terminate office furniture raceway. Supplied with adhesive tape.  | —                         | Office Beige | 1              | 10             |
| <b>OF70FH2OB</b>   | Snap-on single gang horizontal sloped communication faceplate. Accepts up to two Panduit® Mini-Com® Modules (not included). No additional mounting hardware required. TIA/EIA-606-A compliant.                                       | 1-One Port<br>1-Two Port  | Office Beige | 1              | 10             |
| <b>OF70FV2OB</b>   | Snap-on single gang vertical sloped communication faceplate. Accepts up to two Panduit® Mini-Com® Modules (not included). No additional mounting hardware required. TIA/EIA-606-A compliant.   | 1-One Port<br>1-Two Port  | Office Beige | 1              | 10             |
| <b>OF70FH4OB</b>   | Snap-on single gang horizontal sloped communication faceplate. Accepts up to four Panduit® Mini-Com® Modules (not included). No additional mounting hardware required. TIA/EIA-606-A compliant.                                      | 1-One Port<br>1-Four Port | Office Beige | 1              | 10             |
| <b>OF70FV4OB</b>   | Snap-on single gang vertical sloped communication faceplate. Accepts up to four Panduit® Mini-Com® Modules (not included). No additional mounting hardware required. TIA/EIA-606-A compliant.  | 1-One Port<br>2-Two Port  | Office Beige | 1              | 10             |
| <b>T70SDB-X</b>    | Standard faceplate bracket. Used to mount NEMA standard 70mm single gang screw-on faceplates. Can be used with T-70, Twin-70, TG-70 raceway and Pan-Pole™ Communication Pole.  | —                         | Gray         | 10             | —              |

‡For other colors, replace OB (Office Beige) with OS (Office Slate), OG (Office Gray), or MT (Medium Tone).  
Computer printable labels found on pages E2.4 and E2.5

A.  
System  
Overview

B1.  
Cable Ties

B2.  
Cable  
Accessories

B3.  
Stainless  
Steel Ties

C1.  
Wiring  
Duct

C2.  
Surface  
Raceway

C3.  
Abrasion  
Protection

C4.  
Cable  
Management

D1.  
Terminals

D2.  
Power  
Connectors

D3.  
Grounding  
Connectors

E1.  
Labeling  
Systems

E2.  
Labels

E3.  
Pre-Printed  
& Write-On  
Markers

E4.  
Permanent  
Identification

E5.  
Lockout/  
Tagout  
& Safety  
Solutions

F.  
Index

A.  
System  
Overview

## Cable Fill Capacities for Office Furniture Raceway

B1.  
Cable Ties

This information is to be used as a guide in selecting the proper size raceway. The maximum amounts may vary according to the cable installation methods, straightness of cables, etc.

B2.  
Cable  
Accessories

B3.  
Stainless  
Steel Ties

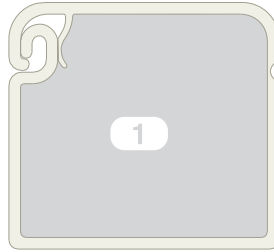

**A = 2.31 in.<sup>2</sup>**

**Cable fill #1:** Open channel without devices

C1.  
Wiring  
Duct

C2.  
Surface  
Raceway

C3.  
Abrasion  
Protection

**SPEC = 40% cable fill** – The recommended design in cable capacity, leaves room for future moves, adds, and changes.

**MAX for Data = 60% cable fill** – The maximum cable quantity based on cable interweaving and packing factors.

C4.  
Cable  
Management

D1.  
Terminals

D2.  
Power  
Connectors

D3.  
Grounding  
Connectors

E1.  
Labeling  
Systems

E2.  
Labels

E3.  
Pre-Printed  
& Write-On  
Markers

E4.  
Permanent  
Identification

E5.  
Lockout/  
Tagout  
& Safety  
Solutions

F.  
Index

| Raceway Type and Configuration | Fill Area (In. <sup>2</sup> ) | Electrical Cables |        |        | Data Grade Cables |               | Data Grade Cables |     | Audio/Video  |     | Fiber Optic Cable |     |
|--------------------------------|-------------------------------|-------------------|--------|--------|-------------------|---------------|-------------------|-----|--------------|-----|-------------------|-----|
|                                |                               | 14 AWG            | 12 AWG | 10 AWG | 24 AWG/UTP CM     | 24 AWG/UTP CM | RG6               |     | 2 Strand     |     |                   |     |
|                                |                               | THHN/T90          |        |        | Cat. 6            |               | Cat. 6A           |     | DIA. = 0.275 |     | DIA. = 0.175      |     |
|                                |                               | 0.111             | 0.130  | 0.164  | DIA. = 0.250      |               | DIA. = 0.330      |     | DIA. = 0.275 |     | DIA. = 0.175      |     |
|                                |                               | FILL              |        |        | FILL              |               | FILL              |     | FILL         |     | FILL              |     |
|                                |                               | MAX               | MAX    | MAX    | SPEC              | MAX           | SPEC              | MAX | SPEC         | MAX | SPEC              | MAX |
|                                |                               | 40%               | 40%    | 40%    | 40%               | 60%           | 40%               | 60% | 40%          | 60% | 40%               | 60% |
| <b>OFR20</b>                   | 2.3                           | —                 | —      | —      | 18                | 28            | 10                | 16  | 15           | 23  | 38                | 57  |

AWG dimensions represent typical outer cable diameter in inches.

## PAN-POLE™ POWER AND COMMUNICATION POLES

Pan-Pole™ Power and Communication Poles provide industry-leading solutions for cable routing in the open office environment. Available with pre-terminated electrical outlets with divided channel for power and communication applications or as an open channel communication pole.



- Tamper resistant cover
- Bend radius control fitting (above ceiling) as required by TIA/EIA-568-B and 569-B.
- Complete with ceiling and floor mounting hardware

Pan-Pole™ Power and Communication Poles accept NEMA standard 70mm screw-on faceplates or superior Pan-Way® Snap-On Faceplates.

A.  
System  
Overview

B1.  
Cable Ties

B2.  
Cable  
Accessories

B3.  
Stainless  
Steel Ties

C1.  
Wiring  
Duct

C2.  
Surface  
Raceway

C3.  
Abrasion  
Protection

C4.  
Cable  
Management

D1.  
Terminals

D2.  
Power  
Connectors

D3.  
Grounding  
Connectors

E1.  
Labeling  
Systems

E2.  
Labels

E3.  
Pre-Printed  
& Write-On  
Markers

E4.  
Permanent  
Identification

E5.  
Lockout/  
Tagout  
& Safety  
Solutions

F.  
Index

A. System Overview



## Pan-Pole™ Power Pole

B1. Cable Ties

- Dual channel aluminum pole is equipped with pre-terminated electrical outlets and provides channel separation for the installation of communication cabling and modules

B2. Cable Accessories

- UL and CSA rated 600 V
- Available in 11 or 13 foot lengths and supplied with a non-metallic cover
- Electrical outlets are pre-wired

B3. Stainless Steel Ties

Pre-installed components include:

1. Blank non-metallic cover
2. Two 20 A factory wired rectangular outlets with wiring fed through power channel to base of power entry box

C1. Wiring Duct

C2. Surface Raceway

C3. Abrasion Protection

C4. Cable Management

D1. Terminals

D2. Power Connectors

D3. Grounding Connectors

E1. Labeling Systems

E2. Labels

E3. Pre-Printed & Write-On Markers

E4. Permanent Identification

E5. Lockout/Tagout & Safety Solutions

F. Index

3. Power entry with 1/2" and 3/4" conduit breakouts
4. Removable plate for power wiring connections
5. Ground screw pre-mounted behind removable plate

Supplied mounting hardware includes:

1. Entry end bend radius fitting
2. Ceiling T-bar bracket
3. Ceiling tile trim plate
4. End cap
5. End cap floor grip pad

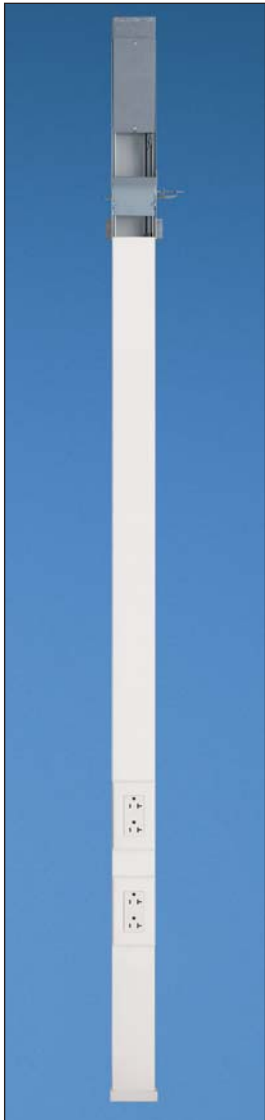

**PCPA11R20**  
**PCPA13R20**

| Part Number        | Part Description  | Color‡    | Std. Pkg. Qty. |
|--------------------|---|-----------|----------------|
| <b>PCPA11R20IW</b> | Pan-Pole™ Power Pole assembly is supplied in 11' length for maximum ceiling height of 10'. Dual channel design allows for the installation of communication outlets.  | Off White | 1              |
| <b>PCPA13R20IW</b> | Pan-Pole™ Power Pole assembly is supplied in 13' length for maximum ceiling heights of 12'. Dual channel design allows for the installation of communication outlets. | Off White | 1              |

Communication components sold separately.

‡For other colors replace IW (Off White) with EI (Electric Ivory).

## Installation of Communication Outlets on Pan-Pole™ Power Pole

### Utilizing Standard Screw-On Faceplates

|    | Components Required   | See page |
|----|---|----------|
| A. | CPG** = Single gang rectangular screw-on faceplate (screws included). | C2.60    |
| B. | CFG2** = Mini-Com® Module Frame – 2-port.                             | —        |
| C. | Mini-Com® Modules.  | —        |
| D. | T70SDB-X = Standard faceplate bracket.                                | C2.40    |
| E. | PCPA**R20 power pole.   | C2.104   |

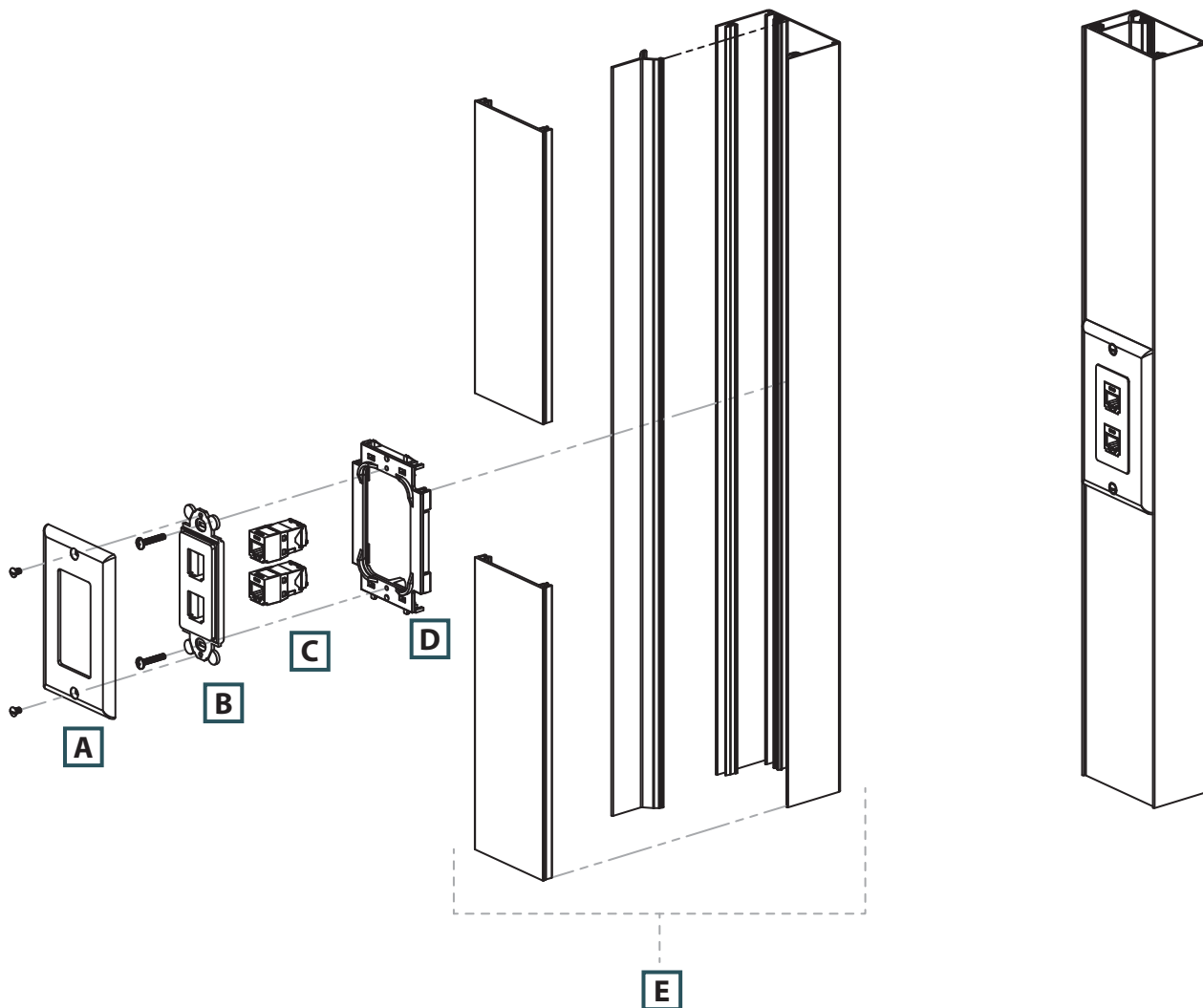

A.  
System  
Overview

B1.  
Cable Ties

B2.  
Cable  
Accessories

B3.  
Stainless  
Steel Ties

C1.  
Wiring  
Duct

C2.  
Surface  
Raceway

C3.  
Abrasion  
Protection

C4.  
Cable  
Management

D1.  
Terminals

D2.  
Power  
Connectors

D3.  
Grounding  
Connectors

E1.  
Labeling  
Systems

E2.  
Labels

E3.  
Pre-Printed  
& Write-On  
Markers

E4.  
Permanent  
Identification

E5.  
Lockout/  
Tagout  
& Safety  
Solutions

F.  
Index



A.  
System  
Overview

## Installation of Communication Outlets on Pan-Pole™ Power Pole (continued)

B1.  
Cable Ties

### Utilizing Panduit Snap-On Faceplates

B2.  
Cable  
Accessories

|    | Components Required   | See page |
|----|---|----------|
| A. | UIT70FV2** = Single gang vertical sloped communication snap-on faceplate. | —        |
| B. | Mini-Com® Modules.  | —        |
| C. | PCPA**R20 power pole.   | C2.104   |

B3.  
Stainless  
Steel Ties

C1.  
Wiring  
Duct

C2.  
Surface  
Raceway

C3.  
Abrasion  
Protection

C4.  
Cable  
Management

D1.  
Terminals

D2.  
Power  
Connectors

D3.  
Grounding  
Connectors

E1.  
Labeling  
Systems

E2.  
Labels

E3.  
Pre-Printed  
& Write-On  
Markers

E4.  
Permanent  
Identification

E5.  
Lockout/  
Tagout  
& Safety  
Solutions

F.  
Index

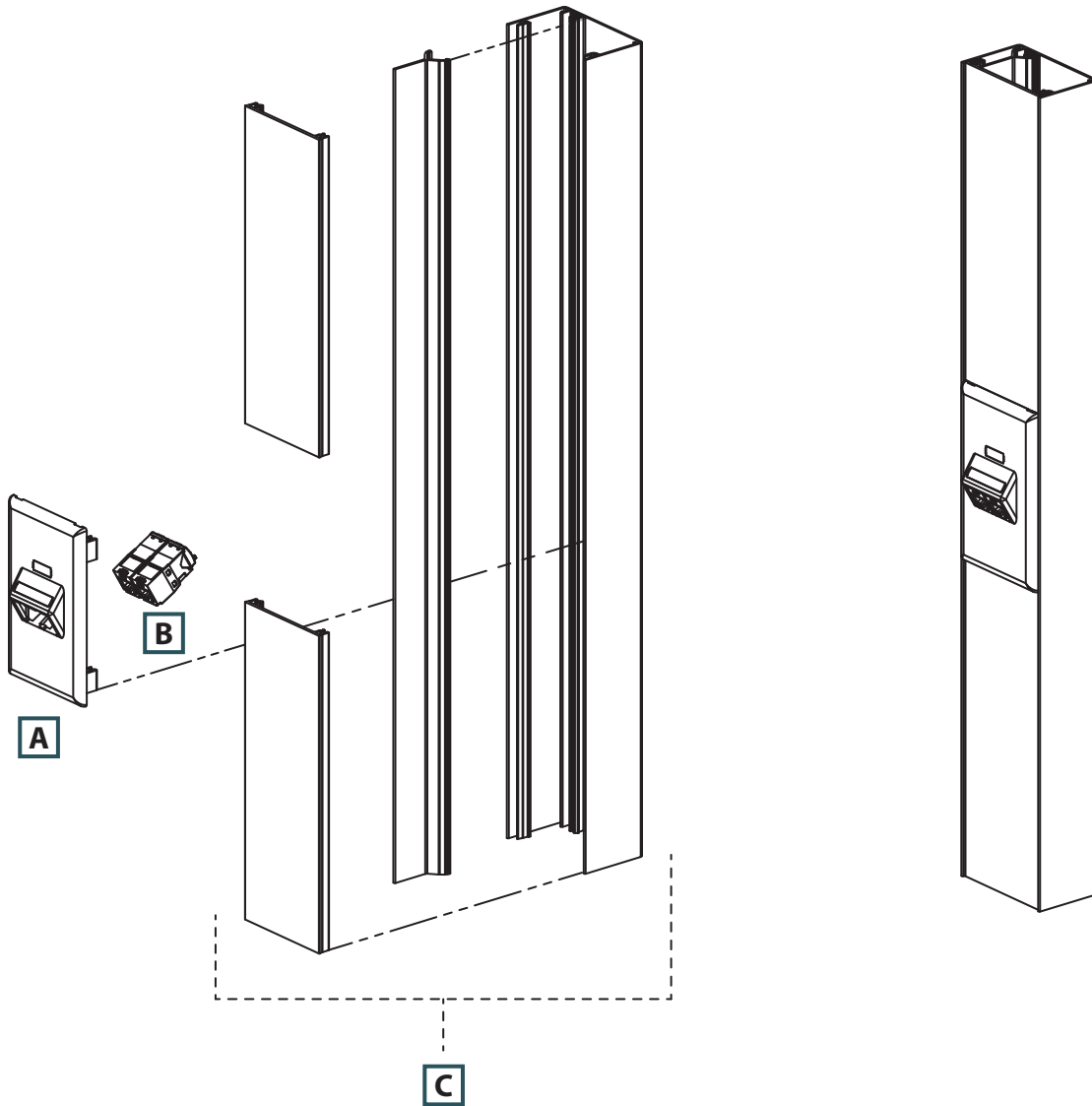

## Pan-Pole™ Communication Pole

- Single channel aluminum pole for routing low voltage communication cabling only
- Poles are available in 11 or 13 foot lengths and are supplied with a non-metallic cover

Supplied mounting hardware includes:

1. Entry end bend radius fitting
2. Ceiling T-bar bracket
3. Ceiling tile trim plate
4. End cap
5. End cap floor grip pad

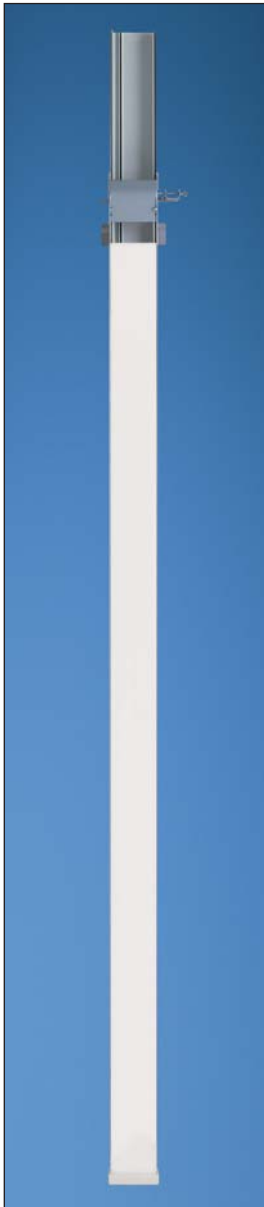

PCPA11  
PCPA13

| Part Number     | Part Description   | Color‡    | Std. Pkg. Qty. |
|-----------------|--|-----------|----------------|
| <b>PCPA11IW</b> | Pan-Pole™ Communication Pole assembly is supplied in 11' length for maximum ceiling height of 10'. | Off White | 1              |
| <b>PCPA13IW</b> | Pan-Pole™ Communication Pole assembly is supplied in 13' length for maximum ceiling height of 12'. | Off White | 1              |

Communication components sold separately.

‡For other colors replace IW (Off White) with EI (Electric Ivory).

A.  
System  
Overview

B1.  
Cable Ties

B2.  
Cable  
Accessories

B3.  
Stainless  
Steel Ties

C1.  
Wiring  
Duct

C2.  
Surface  
Raceway

C3.  
Abrasion  
Protection

C4.  
Cable  
Management

D1.  
Terminals

D2.  
Power  
Connectors

D3.  
Grounding  
Connectors

E1.  
Labeling  
Systems

E2.  
Labels

E3.  
Pre-Printed  
& Write-On  
Markers

E4.  
Permanent  
Identification

E5.  
Lockout/  
Tagout  
& Safety  
Solutions

F.  
Index

A.  
System  
Overview

## Installation of Communication Outlets on Pan-Pole™ Communication Pole

B1.  
Cable Ties

### Utilizing Standard Screw-On Faceplates

B2.  
Cable  
Accessories

|    | Components Required   | See page |
|----|---|----------|
| A. | CPG** = Single gang rectangular screw-on faceplate (screws included). | C2.60    |
| B. | CFG2** = Mini-Com® Module Frame – 2-port.                             | —        |
| C. | Mini-Com® Modules.  | —        |
| D. | T70SDB-X = Standard faceplate bracket.                                | C2.40    |
| E. | PCPA** = Communication pole.  | C2.107   |

B3.  
Stainless  
Steel Ties

C1.  
Wiring  
Duct

C2.  
Surface  
Raceway

C3.  
Abrasion  
Protection

C4.  
Cable  
Management

D1.  
Terminals

D2.  
Power  
Connectors

D3.  
Grounding  
Connectors

E1.  
Labeling  
Systems

E2.  
Labels

E3.  
Pre-Printed  
& Write-On  
Markers

E4.  
Permanent  
Identification

E5.  
Lockout/  
Tagout  
& Safety  
Solutions

F.  
Index

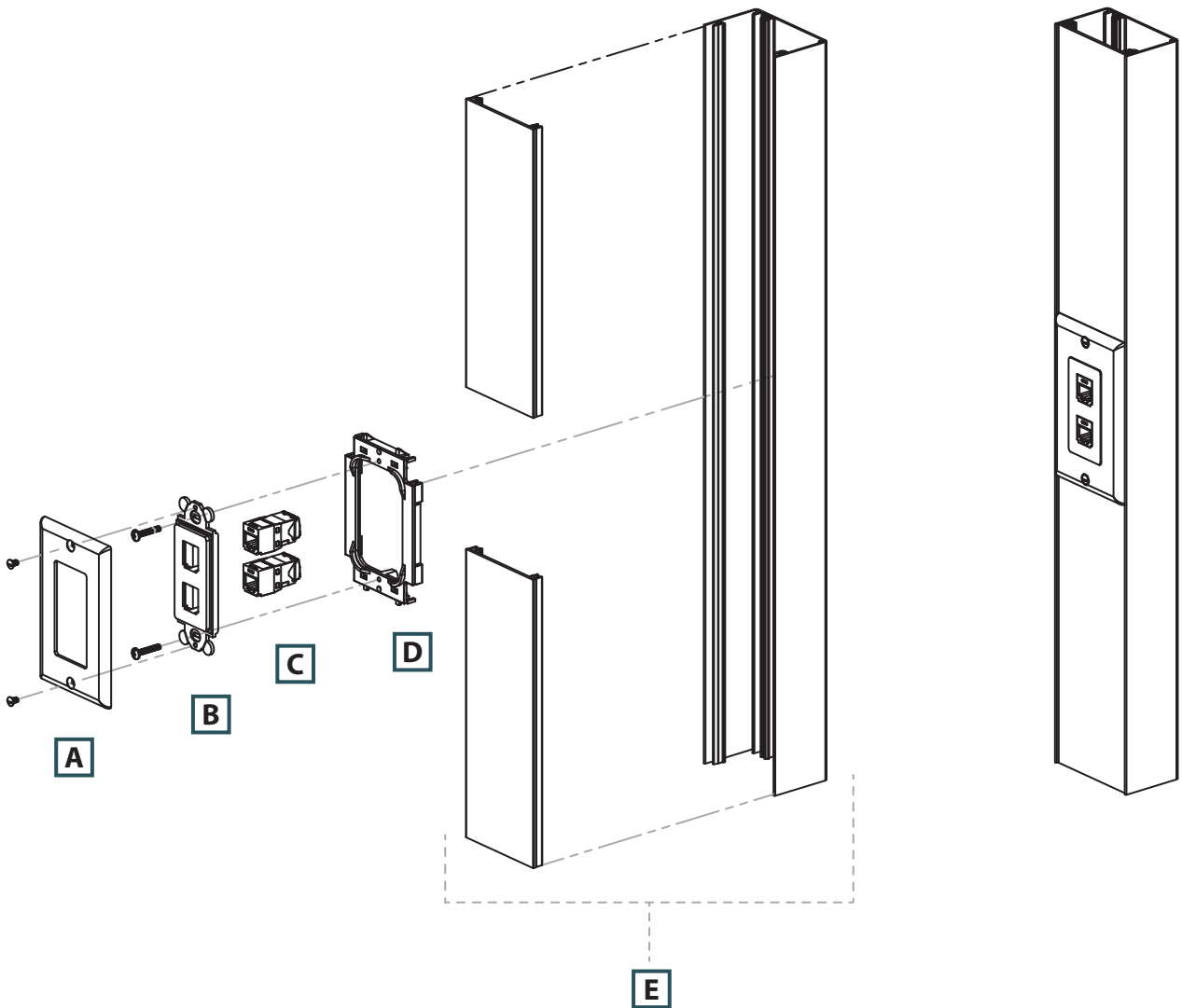

## Installation of Communication Outlets on Pan-Pole™ Communication Pole (continued)

### Utilizing Panduit Snap-On Faceplates

|    | Components Required   | See page |
|----|---|----------|
| A. | UIT70FV2** = Single gang vertical sloped communication snap-on faceplate. | —        |
| B. | Mini-Com® Modules.  | —        |
| C. | PCPA** = Communication pole.  | C2.107   |

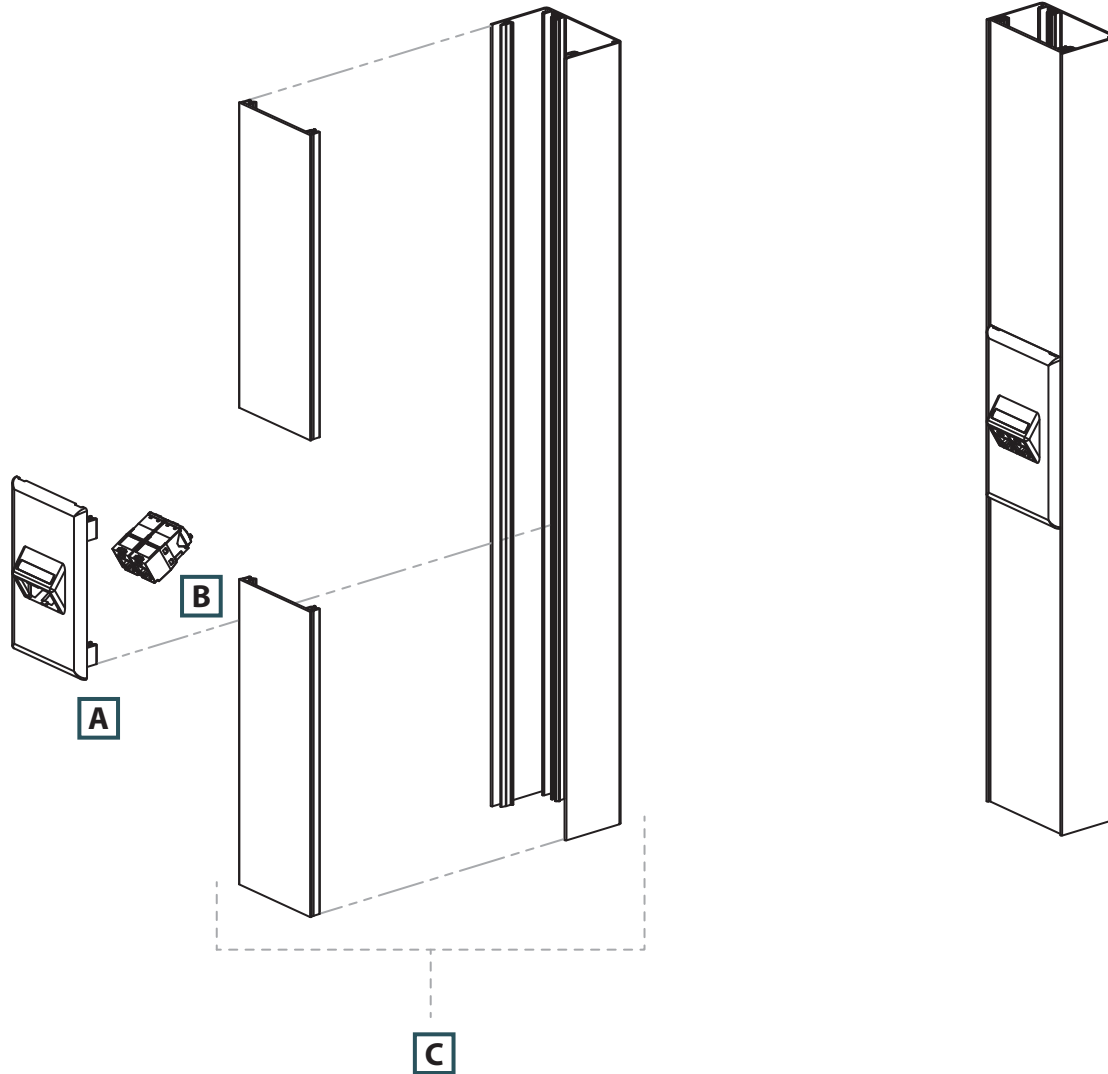

A.  
System  
Overview

B1.  
Cable  
Ties

B2.  
Cable  
Accessories

B3.  
Stainless  
Steel  
Ties

C1.  
Wiring  
Duct

C2.  
Surface  
Raceway

C3.  
Abrasion  
Protection

C4.  
Cable  
Management

D1.  
Terminals

D2.  
Power  
Connectors

D3.  
Grounding  
Connectors

E1.  
Labeling  
Systems

E2.  
Labels

E3.  
Pre-Printed  
& Write-On  
Markers

E4.  
Permanent  
Identification

E5.  
Lockout/  
Tagout  
& Safety  
Solutions

F.  
Index

A. System Overview



## Pan-Pole™ Extension Kits

B1. Cable Ties

B2. Cable Accessories

B3. Stainless Steel Ties

C1. Wiring Duct

C2. Surface Raceway

C3. Abrasion Protection

C4. Cable Management

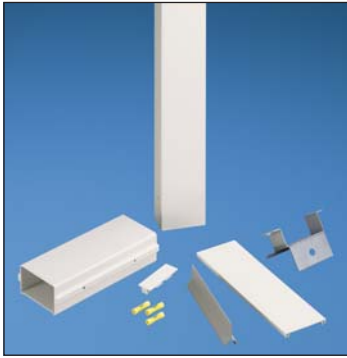

**PCPAK22**  
**PCPAK16**

| Part Number      | Part Description  | Color‡    | Std. Pkg. Qty. |
|------------------|---|-----------|----------------|
| <b>PCPAK22IW</b> | Pan-Pole™ Extension Kit. To extend the 11' pole to 22'. Extension kit includes: Fully assembled 11' pole with brace/coupler, additional wiring, and screws.<br>Note: Customer needs to purchase a separate standard 11' pole to make the required length. | Off White | 1              |
| <b>PCPAK16IW</b> | Pan-Pole™ Extension Kit. To extend the 13' pole to 16'. Extension kit includes: fully assembled 3' pole with brace/coupler, additional wiring, and screws.<br>Note: Customer needs to purchase a separate standard 13' pole to make the required length.  | Off White | 1              |

‡All product color is (IW) Off White.



## Pan-Pole™ Power Addition Kits and Standard Faceplate Bracket

- Power addition kits (UL listed for field installation) provide for the addition of power outlets
- Allow for the installation of up to three additional duplex outlets (five outlets max.)

- Outlets may be added to the existing factory wired circuit or one additional circuit may be added



**PCPAKR20**

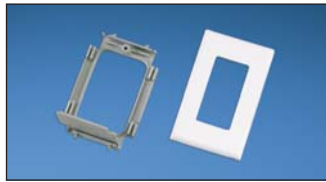

**PCPAKR**



**T70SDB-X**

| Part Number       | Part Description  | Color‡    | Std. Pkg. Qty. | Std. Ctn. Qty. |
|-------------------|---|-----------|----------------|----------------|
| <b>PCPAKR20IW</b> | Power addition kit includes 20 A rectangular outlet with two mounting screws, outlet mounting bracket with one mounting screw, and snap-on faceplate.                         | Off White | 1              | 10             |
| <b>PCPAKR1W</b>   | Power addition kit includes outlet mounting bracket with one mounting screw and snap-on faceplate.<br><i>Rectangular power outlet purchased separately.</i>                   | Off White | 1              | 10             |
| <b>T70SDB-X</b>   | Standard faceplate bracket. Used to mount NEMA standard 70mm single gang screw-on faceplates. Can be used with T-70, Twin-70, TG-70 raceway and Pan-Pole™ Communication Pole. | Gray      | 10             | —              |

‡For other colors replace IW (Off White) with EI (Electric Ivory).

When purchasing power addition kit with 20A outlet, use with Pan-Pole™ Power Pole, PCPA11R20IW and PCPA13R20IW.

When purchasing power addition it without outlet, rectangular power outlet needs to be purchased separately. Use with Pan-Pole™ Power Pole, PCPA11R20EI and PCPA13R20EI.

D1. Terminals

D2. Power Connectors

D3. Grounding Connectors

E1. Labeling Systems

E2. Labels

E3. Pre-Printed & Write-On Markers

E4. Permanent Identification

E5. Lockout/Tagout & Safety Solutions

F. Index





## Pan-Pole™ Replacement Parts

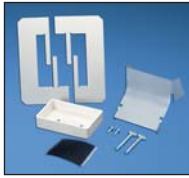

PCPKIT



PCPTP

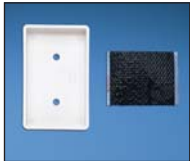

PCPEC



PCPBRC

| Part Number     | Part Description  | Color     | Std. Pkg. Qty. | Std. Ctn. Qty. |
|-----------------|---|-----------|----------------|----------------|
| <b>PCPKITIW</b> | Replacement parts include: bend radius control ramp, two thumb screws, one two-piece ceiling trim plate and one end cap with floor grip pad. Also available in EI (Electric Ivory). | Off White | 1              | 5              |
| <b>PCPTPIW</b>  | Replacement ceiling trim plate.   | Off White | 1              | —              |
| <b>PCPECIW</b>  | Replacement end cap with floor grip pad. Also available in EI (Electric Ivory).   | Off White | 1              | —              |
| <b>PCPBRC</b>   | Replacement bend radius control ramp with T-bar bracket for attaching pole to T-bar. Includes mounting screws.  | Gray      | 1              | —              |

A. System Overview

B1. Cable Ties

B2. Cable Accessories

B3. Stainless Steel Ties

C1. Wiring Duct

C2. Surface Raceway

C3. Abrasion Protection

C4. Cable Management

D1. Terminals

D2. Power Connectors

D3. Grounding Connectors

E1. Labeling Systems

E2. Labels

E3. Pre-Printed & Write-On Markers

E4. Permanent Identification

E5. Lockout/Tagout & Safety Solutions

F. Index

## Cable Fill Capacities for Pan-Pole™ Power and Communication Poles

The maximum amounts may vary according to the cable installation methods, straightness of cables, etc.

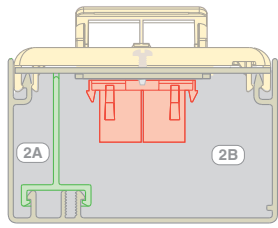

**A = .47 in.<sup>2</sup>    A = 2.75 in.<sup>2</sup>**

**Cable fill #1:** Power pole with data terminals using vertical sloped snap-on communication faceplate.

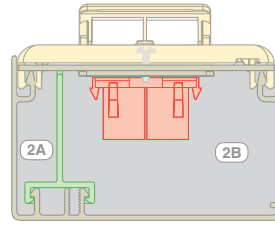

**A = .43 in.<sup>2</sup>    A = 2.15 in.<sup>2</sup>**

**Cable fill #2:** Power pole with data terminals using sloped screw-on communication faceplate.

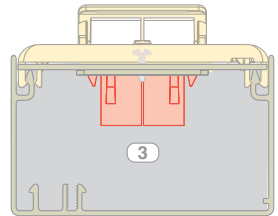

**A = 3.47 in.<sup>2</sup>**

**Cable fill #3:** Communication pole using vertical sloped snap-on communication faceplate.

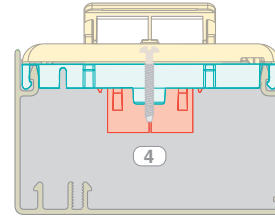

**A = 2.83 in.<sup>2</sup>**

**Cable fill #4:** communication pole using sloped screw-on communication faceplate.

**SPEC = 40% cable fill** – The recommended design in cable capacity, leaves room for future moves, adds, and changes.

**MAX for Data = 60% cable fill** – The maximum cable quantity based on cable interweaving and packing factors.

**MAX for Power cable fill** – The maximum of electrical cables based on UL temperature rise test.

| Raceway Type and Configuration                            | Fill Area (In. <sup>2</sup> ) | Electrical Cables |        |        | Data Grade Cables |       | Data Grade Cables |       | Audio/Video  |       | Fiber Optic Cable |       |
|---|-------------------------------|-------------------|--------|--------|-------------------|-------|-------------------|-------|--------------|-------|-------------------|-------|
|   |                               | 14 AWG            | 12 AWG | 10 AWG | 24 AWG/UTP CM     |       | 24 AWG/UTP CM     |       | RG6          |       | 2 Strand          |       |
|   |                               | THHN/T90          |        |        | Cat. 6 (4-pr.)    |       | Augmented Cat. 6  |       |              |       |                   |       |
|   |                               | 0.111             | 0.130  | 0.164  | DIA. = 0.250      |       | DIA. = 0.354      |       | DIA. = 0.275 |       | DIA. = 0.175      |       |
|   |                               | FILL              |        |        | FILL              |       | FILL              |       | FILL         |       | FILL              |       |
| MAX   | MAX                           | MAX               | SPEC   | MAX    | SPEC              | MAX   | SPEC              | MAX   | SPEC         | MAX   | SPEC              | MAX   |
| (UL Temp Rise Test)                                       |                               |                   | (40%)  | (60%)  | (40%)             | (60%) | (40%)             | (60%) | (40%)        | (60%) | (40%)             | (60%) |
| 1A. Power and communication: snap-on faceplates (power).  | 0.47                          | —                 | 11     | —      | —                 | —     | —                 | —     | 32           | 4     | 7                 | 11    |
| 1B. Communication.  | 2.75                          | —                 | —      | —      | 22                | 33    | 12                | 19    | 18           | 27    | 45                | 68    |
| 2A. Power and communication: Screw-on faceplates (power). | 0.43                          | —                 | 11     | —      | —                 | —     | —                 | —     | 2            | 4     | 7                 | 10    |
| 2B. Communication.  | 2.15                          | —                 | —      | —      | 17                | 26    | 10                | 15    | 14           | 21    | 35                | 53    |
| 3. Communication only Snap-on faceplate.                  | 3.47                          | —                 | —      | —      | 28                | 42    | 16                | 24    | 23           | 35    | 57                | 86    |
| 4. Communication only: Screw-on faceplates.               | 2.83                          | —                 | —      | —      | 23                | 34    | 13                | 19    | 19           | 28    | 47                | 70    |

AWG dimensions represent typical outer cable diameter in inches.

## ABRASION PROTECTION

Panduit abrasion protection products provide an economical and easy way to insulate, protect, bundle and color-code components and cable. A wide variety of sizes and materials are available to meet a broad range of indoor and outdoor applications. To help assure optimum quality, Panduit abrasion protection products are designed and manufactured to meet applicable quality standards including International, UL, Military, ISO, and Aerospace.



- **Pan-Wrap™ Split Harness Wrap** features a patented slot pattern to improve flexibility and abrasion protection
- **Spiral wrap** bundles and protects wire and cable while providing the largest variety of colors, materials, and sizes to meet a variety of needs
- **Grommet edging** protects wire and cable from damage caused by sharp panel edges
- **Heat shrink** is available in many different materials and sizes to meet a variety of needs
- **Corrugated loom tubing** is crush, impact, and abrasion resistant to reduce the risk of damage to wire and cable
- **Braided expandable sleeving** provides continuous abrasion resistance and lightweight durable protection, with a flexible open weave that will not trap heat or humidity

Panduit abrasion protection products provide quality at the lowest installed cost. With a continued focus on new product development, Panduit continues to meet customer needs.

A.  
System  
Overview

B1.  
Cable Ties

B2.  
Cable  
Accessories

B3.  
Stainless  
Steel Ties

C1.  
Wiring  
Duct

C2.  
Surface  
Raceway

C3.  
Abrasion  
Protection

C4.  
Cable  
Management

D1.  
Terminals

D2.  
Power  
Connectors

D3.  
Grounding  
Connectors

E1.  
Labeling  
Systems

E2.  
Labels

E3.  
Pre-Printed  
& Write-On  
Markers

E4.  
Permanent  
Identification

E5.  
Lockout/  
Tagout  
& Safety  
Solutions

F.  
Index

A. System Overview

B1. Cable Ties

B2. Cable Accessories

B3. Stainless Steel Ties

C1. Wiring Duct

C2. Surface Raceway

C3. Abrasion Protection

C4. Cable Management

D1. Terminals

D2. Power Connectors

D3. Grounding Connectors

E1. Labeling Systems

E2. Labels

E3. Pre-Printed & Write-On Markers

E4. Permanent Identification

E5. Lockout/Tagout & Safety Solutions

F. Index

## Part Number System for Pan-Wrap™

|                |   |   |   |  |  |
|----------------|---|---|---|--|--|
| <b>PW</b>      | <b>50</b>   | <b>F</b>  | - | <b>C</b>   | <b>20</b>  |
| Type           | Outside Diameter  | Material  |   | Package Size   | Color Suffix   |
| PW = Pan-Wrap™ | 38 = 3/8"<br>50 = 1/2"<br>75 = 3/4"<br>100 = 1"<br>150 = 1 1/2" | F = Polyethylene<br>FR = Flame Retardant Polyethylene |   | L = 50' (15.2m)<br>C = 100' (30.5m)<br>T = 200' (61.0m)<br>TL = 250' (76.2m) | Leave Blank = Natural<br>20 = Black Polyethylene<br>3 = Orange<br>4 = Yellow |

## Pan-Wrap™ Split Harness Wrap



- Patented slot pattern provides improved flexibility and abrasion protection in any application
- Unique wall design provides for easy cable breakouts
- Innovative design maintains uniform bundle protection in dynamic applications
- Considerably reduces installation time
- Large overlap accommodates a wide range of bundle diameters
- Packaged on a reel for easy handling and dispensing of product

| Part Number  | Material                     | Color   | Length Per Reel |      | Max. Bundle Diameter |      | Min. Bundle Diameter‡ |      | Temperature Range               | Nominal I.D. |      | Std. Pkg. Qty.* |
|--------------|------------------------------|---------|-----------------|------|----------------------|------|-----------------------|------|---------------------------------|--------------|------|-----------------|
|              |                              |         | Ft.             | m    | In.                  | mm   | In.                   | mm   |                                 | In.          | mm   |                 |
| PW38F-TL     | Polyethylene                 | Natural | 250             | 76.2 | 0.43                 | 10.9 | 0.25                  | 6.4  | -40°F – 122°F<br>(-40°C – 50°C) | 0.38         | 9.5  | 1               |
| PW38F-TL20   | Polyethylene                 | Black   | 250             | 76.2 | 0.43                 | 10.9 | 0.25                  | 6.4  |                                 | 0.38         | 9.5  | 1               |
| PW38FR-TLY   | Flame Retardant Polyethylene | Natural | 250             | 76.2 | 0.43                 | 10.9 | 0.25                  | 6.4  | -4°F – 167°F<br>(-20°C – 75°C)  | 0.38         | 9.5  | 1               |
| PW38FR-TL20Y | Flame Retardant Polyethylene | Black   | 250             | 76.2 | 0.43                 | 10.9 | 0.25                  | 6.4  |                                 | 0.38         | 9.5  | 1               |
| PW50F-T      | Polyethylene                 | Natural | 200             | 61.0 | 0.55                 | 14.0 | 0.43                  | 10.9 | -40°F – 122°F<br>(-40°C – 50°C) | 0.50         | 12.7 | 1               |
| PW50F-T20    | Polyethylene                 | Black   | 200             | 61.0 | 0.55                 | 14.0 | 0.43                  | 10.9 |                                 | 0.50         | 12.7 | 1               |
| PW50F-T3     | Polyethylene                 | Orange  | 200             | 61.0 | 0.55                 | 14.0 | 0.43                  | 10.9 |                                 | 0.50         | 12.7 | 1               |
| PW50F-T4     | Polyethylene                 | Yellow  | 200             | 61.0 | 0.55                 | 14.0 | 0.43                  | 10.9 |                                 | 0.50         | 12.7 | 1               |
| PW50FR-TY    | Flame Retardant Polyethylene | Natural | 200             | 61.0 | 0.55                 | 14.0 | 0.43                  | 10.9 | -4°F – 167°F<br>(-20°C – 75°C)  | 0.50         | 12.7 | 1               |
| PW50FR-T20Y  | Flame Retardant Polyethylene | Black   | 200             | 61.0 | 0.55                 | 14.0 | 0.43                  | 10.9 |                                 | 0.50         | 12.7 | 1               |
| PW75F-C      | Polyethylene                 | Natural | 100             | 30.5 | 0.81                 | 20.6 | 0.55                  | 14.0 | -40°F – 122°F<br>(-40°C – 50°C) | 0.75         | 19.1 | 1               |
| PW75F-C20    | Polyethylene                 | Black   | 100             | 30.5 | 0.81                 | 20.6 | 0.55                  | 14.0 |                                 | 0.75         | 19.1 | 1               |
| PW75F-C3     | Polyethylene                 | Orange  | 100             | 30.5 | 0.81                 | 20.6 | 0.55                  | 14.0 |                                 | 0.75         | 19.1 | 1               |
| PW75F-C4     | Polyethylene                 | Yellow  | 100             | 30.5 | 0.81                 | 20.6 | 0.55                  | 14.0 |                                 | 0.75         | 19.1 | 1               |
| PW75FR-CY    | Flame Retardant Polyethylene | Natural | 100             | 30.5 | 0.81                 | 20.6 | 0.55                  | 14.0 | -4°F – 167°F<br>(-20°C – 75°C)  | 0.75         | 19.1 | 1               |
| PW75FR-C20Y  | Flame Retardant Polyethylene | Black   | 100             | 30.5 | 0.81                 | 20.6 | 0.55                  | 14.0 |                                 | 0.75         | 19.1 | 1               |
| PW100F-C     | Polyethylene                 | Natural | 100             | 30.5 | 1.13                 | 28.6 | 0.81                  | 20.6 | -40°F – 122°F<br>(-40°C – 50°C) | 1.00         | 25.4 | 1               |
| PW100F-C20   | Polyethylene                 | Black   | 100             | 30.5 | 1.13                 | 28.6 | 0.81                  | 20.6 |                                 | 1.00         | 25.4 | 1               |
| PW100F-C3    | Polyethylene                 | Orange  | 100             | 30.5 | 1.13                 | 28.6 | 0.81                  | 20.6 |                                 | 1.00         | 25.4 | 1               |
| PW100F-C4    | Polyethylene                 | Yellow  | 100             | 30.5 | 1.13                 | 28.6 | 0.81                  | 20.6 |                                 | 1.00         | 25.4 | 1               |
| PW100FR-CY   | Flame Retardant Polyethylene | Natural | 100             | 30.5 | 1.13                 | 28.6 | 0.81                  | 20.6 | -4°F – 167°F<br>(-20°C – 75°C)  | 1.00         | 25.4 | 1               |
| PW100FR-C20Y | Flame Retardant Polyethylene | Black   | 100             | 30.5 | 1.13                 | 28.6 | 0.81                  | 20.6 |                                 | 1.00         | 25.4 | 1               |
| PW150F-L     | Polyethylene                 | Natural | 50              | 15.2 | 1.63                 | 41.3 | 1.13                  | 28.6 | -40°F – 122°F<br>(-40°C – 50°C) | 1.50         | 38.1 | 1               |
| PW150F-L20   | Polyethylene                 | Black   | 50              | 15.2 | 1.63                 | 41.3 | 1.13                  | 28.6 |                                 | 1.50         | 38.1 | 1               |
| PW150F-L3    | Polyethylene                 | Orange  | 50              | 15.2 | 1.63                 | 41.3 | 1.13                  | 28.6 |                                 | 1.50         | 38.1 | 1               |
| PW150F-L4    | Polyethylene                 | Yellow  | 50              | 15.2 | 1.63                 | 41.3 | 1.13                  | 28.6 |                                 | 1.50         | 38.1 | 1               |
| PW150FR-LY   | Flame Retardant Polyethylene | Natural | 50              | 15.2 | 1.63                 | 41.3 | 1.13                  | 28.6 | -4°F – 167°F<br>(-20°C – 75°C)  | 1.50         | 38.1 | 1               |
| PW150FR-L20Y | Flame Retardant Polyethylene | Black   | 50              | 15.2 | 1.63                 | 41.3 | 1.13                  | 28.6 |                                 | 1.50         | 38.1 | 1               |

‡Diameter can be further reduced with the use of Panduit cable ties.

\*Order number of reels required.

## Pan-Wrap™ Installation Tools

- Patented installation tool with 180° opening allows easy loading of maximum bundle diameters to speed installation, providing the lowest installed cost



| Part Number | Color | For Use With   | Std. Pkg. Qty.** |
|-------------|-------|----------------|------------------|
| PWT38       | White | PW38F- Series  | 1                |
| PWT50       | White | PW50F- Series  | 1                |
| PWT75       | White | PW75F- Series  | 1                |
| PWT100      | White | PW100F- Series | 1                |
| PWT150      | White | PW150F- Series | 1                |

\*\*Order number of tools required.

## Part Number System for Spiral Wrap

| T               | 25   | F  | - | C  | 16              |
|-----------------|--|--|---|--|-----------------|
| Type            | Outside Diameter   | Material   |   | Package Size   | Color Suffix    |
| T = Spiral Wrap | 12 = 1/8"<br>19 = 3/16"<br>25 = 1/4"<br>38 = 3/8"<br>50 = 1/2"<br>62 = 5/8"<br>75 = 3/4"<br>100 = 1" | F = Polyethylene<br>R = Fire Resistant Polyethylene<br>FR = Flame Retardant Polyethylene<br>N = Nylon<br>T = TFE <sup>^</sup><br>P = Weather Resistant Polypropylene |   | X = 10'<br>Q = 25'<br>L = 50'<br>C = 100'<br>T = 200'<br>TL = 250'<br>D = 500'<br>M = 1,000' | See Table Below |

| Color                   | Color Suffix             | Material Availability |                             |                              |           |                                 |                     |
|-------------------------|--------------------------|-----------------------|-----------------------------|------------------------------|-----------|---------------------------------|---------------------|
|                         |                          | Polyethylene          | Fire Resistant Polyethelene | Flame Retardant Polyethelene | Nylon 6.6 | Weather Resistant Polypropylene | TEFLON <sup>^</sup> |
| Natural*                | No Suffix Will be Listed | ✓                     | ✓                           | ✓                            | ✓         |                                 | ✓                   |
| Weather Resistant Black | 0                        | ✓                     |                             |                              | ✓         | ✓                               |                     |
| Brown                   | 1                        | ✓                     |                             |                              |           |                                 |                     |
| Red                     | 2                        | ✓                     |                             |                              |           |                                 |                     |
| Orange                  | 3                        | ✓                     |                             |                              |           |                                 |                     |
| Yellow                  | 4                        | ✓                     |                             |                              |           |                                 |                     |
| Green                   | 5                        | ✓                     |                             |                              |           |                                 |                     |
| Blue                    | 6                        | ✓                     |                             |                              |           |                                 |                     |
| Purple                  | 7                        | ✓                     |                             |                              |           |                                 |                     |
| Gray                    | 8                        | ✓                     |                             |                              |           |                                 |                     |
| White                   | 10                       | ✓                     |                             |                              |           |                                 |                     |
| Pink                    | 16                       | ✓                     |                             |                              |           |                                 |                     |
| Black                   | 20                       | ✓                     | ✓                           | ✓                            | ✓         |                                 |                     |

<sup>^</sup>TFE is Polytetrafluorethylene material.

\*Natural can range from transparent, opaque, to white.

A. System Overview

**RU** Spiral Wrap

B1. Cable Ties



B2. Cable Accessories

B3. Stainless Steel Ties

C1. Wiring Duct

C2. Surface Raceway

C3. Abrasion Protection

C4. Cable Management

D1. Terminals

D2. Power Connectors

D3. Grounding Connectors

E1. Labeling Systems

E2. Labels

E3. Pre-Printed & Write-On Markers

E4. Permanent Identification

E5. Lockout/Tagout & Safety Solutions

F. Index

- Harness multiple cables into a single manageable bundle
- Allows breakouts of single/multiple cables
- Provides abrasion protection for wire, cables, hoses, and tubing
- Multiple colors allow easy identification of cable bundles
- Installation tool supplied in each package
- Available in multiple materials
- Reusable

| Part Number | Material*    | Color   | Length Per Reel |       | Bundle Diameter Range |             | Outside Diameter |      | Temperature Range               | Wall Thickness |      | Std. Pkg. Qty.‡ |
|-------------|--------------|---------|-----------------|-------|-----------------------|-------------|------------------|------|---------------------------------|----------------|------|-----------------|
|             |              |         | Ft.             | m     | In.                   | mm          | In.              | mm   |                                 | In.            | mm   |                 |
| T12F-C      | Polyethylene | Natural | 100             | 30.5  | 1/16 – 1/2            | 1.6 – 12.7  | 0.12             | 3.2  | -40°F – 122°F<br>(-40°C – 50°C) | 0.030          | 0.76 | 1               |
| T12F-D      | Polyethylene | Natural | 500             | 152.4 | 1/16 – 1/2            | 1.6 – 12.7  | 0.12             | 3.2  | -40°F – 122°F<br>(-40°C – 50°C) | 0.030          | 0.76 | 1               |
| T19F-C      | Polyethylene | Natural | 100             | 30.5  | 1/8 – 1               | 3.2 – 25.4  | 0.19             | 4.8  | -40°F – 122°F<br>(-40°C – 50°C) | 0.035          | 0.89 | 1               |
| T19F-M      | Polyethylene | Natural | 1,000           | 304.8 | 1/8 – 1               | 3.2 – 25.4  | 0.19             | 4.8  | -40°F – 122°F<br>(-40°C – 50°C) | 0.035          | 0.89 | 1               |
| T25F-C      | Polyethylene | Natural | 100             | 30.5  | 3/16 – 2              | 4.8 – 50.8  | 0.25             | 6.4  | -40°F – 122°F<br>(-40°C – 50°C) | 0.040          | 1.02 | 1               |
| T25F-C1     | Polyethylene | Brown   | 100             | 30.5  | 3/16 – 2              | 4.8 – 50.8  | 0.25             | 6.4  | -40°F – 122°F<br>(-40°C – 50°C) | 0.040          | 1.02 | 1               |
| T25F-C2     | Polyethylene | Red     | 100             | 30.5  | 3/16 – 2              | 4.8 – 50.8  | 0.25             | 6.4  | -40°F – 122°F<br>(-40°C – 50°C) | 0.040          | 1.02 | 1               |
| T25F-C3Y    | Polyethylene | Orange  | 100             | 30.5  | 3/16 – 2              | 4.8 – 50.8  | 0.25             | 6.4  | -40°F – 122°F<br>(-40°C – 50°C) | 0.040          | 1.02 | 1               |
| T25F-C4Y    | Polyethylene | Yellow  | 100             | 30.5  | 3/16 – 2              | 4.8 – 50.8  | 0.25             | 6.4  | -40°F – 122°F<br>(-40°C – 50°C) | 0.040          | 1.02 | 1               |
| T25F-C5     | Polyethylene | Green   | 100             | 30.5  | 3/16 – 2              | 4.8 – 50.8  | 0.25             | 6.4  | -40°F – 122°F<br>(-40°C – 50°C) | 0.040          | 1.02 | 1               |
| T25F-C6     | Polyethylene | Blue    | 100             | 30.5  | 3/16 – 2              | 4.8 – 50.8  | 0.25             | 6.4  | -40°F – 122°F<br>(-40°C – 50°C) | 0.040          | 1.02 | 1               |
| T25F-C7     | Polyethylene | Purple  | 100             | 30.5  | 3/16 – 2              | 4.8 – 50.8  | 0.25             | 6.4  | -40°F – 122°F<br>(-40°C – 50°C) | 0.040          | 1.02 | 1               |
| T25F-C8     | Polyethylene | Gray    | 100             | 30.5  | 3/16 – 2              | 4.8 – 50.8  | 0.25             | 6.4  | -40°F – 122°F<br>(-40°C – 50°C) | 0.040          | 1.02 | 1               |
| T25F-C10    | Polyethylene | White   | 100             | 30.5  | 3/16 – 2              | 4.8 – 50.8  | 0.25             | 6.4  | -40°F – 122°F<br>(-40°C – 50°C) | 0.040          | 1.02 | 1               |
| T25F-C16    | Polyethylene | Pink    | 100             | 30.5  | 3/16 – 2              | 4.8 – 50.8  | 0.25             | 6.4  | -40°F – 122°F<br>(-40°C – 50°C) | 0.040          | 1.02 | 1               |
| T25F-M      | Polyethylene | Natural | 1,000           | 304.8 | 3/16 – 2              | 4.8 – 50.8  | 0.25             | 6.4  | -40°F – 122°F<br>(-40°C – 50°C) | 0.040          | 1.02 | 1               |
| T38F-C      | Polyethylene | Natural | 100             | 30.5  | 5/16 – 3              | 7.9 – 76.2  | 0.38             | 9.5  | -40°F – 122°F<br>(-40°C – 50°C) | 0.055          | 1.40 | 1               |
| T38F-TL     | Polyethylene | Natural | 250             | 76.2  | 5/16 – 3              | 7.9 – 76.2  | 0.38             | 9.5  | -40°F – 122°F<br>(-40°C – 50°C) | 0.055          | 1.40 | 1               |
| T50F-X      | Polyethylene | Natural | 10              | 3.1   | 3/8 – 4               | 9.5 – 101.6 | 0.50             | 12.7 | -40°F – 122°F<br>(-40°C – 50°C) | 0.060          | 1.52 | 1               |
| T50F-C      | Polyethylene | Natural | 100             | 30.5  | 3/8 – 4               | 9.5 – 101.6 | 0.50             | 12.7 | -40°F – 122°F<br>(-40°C – 50°C) | 0.060          | 1.52 | 1               |
| T50F-C1     | Polyethylene | Brown   | 100             | 30.5  | 3/8 – 4               | 9.5 – 101.6 | 0.50             | 12.7 | -40°F – 122°F<br>(-40°C – 50°C) | 0.060          | 1.52 | 1               |
| T50F-C2     | Polyethylene | Red     | 100             | 30.5  | 3/8 – 4               | 9.5 – 101.6 | 0.50             | 12.7 | -40°F – 122°F<br>(-40°C – 50°C) | 0.060          | 1.52 | 1               |
| T50F-C3Y    | Polyethylene | Orange  | 100             | 30.5  | 3/8 – 4               | 9.5 – 101.6 | 0.50             | 12.7 | -40°F – 122°F<br>(-40°C – 50°C) | 0.060          | 1.52 | 1               |
| T50F-C4Y    | Polyethylene | Yellow  | 100             | 30.5  | 3/8 – 4               | 9.5 – 101.6 | 0.50             | 12.7 | -40°F – 122°F<br>(-40°C – 50°C) | 0.060          | 1.52 | 1               |
| T50F-C5     | Polyethylene | Green   | 100             | 30.5  | 3/8 – 4               | 9.5 – 101.6 | 0.50             | 12.7 | -40°F – 122°F<br>(-40°C – 50°C) | 0.060          | 1.52 | 1               |
| T50F-C6     | Polyethylene | Blue    | 100             | 30.5  | 3/8 – 4               | 9.5 – 101.6 | 0.50             | 12.7 | -40°F – 122°F<br>(-40°C – 50°C) | 0.060          | 1.52 | 1               |
| T50F-C7     | Polyethylene | Purple  | 100             | 30.5  | 3/8 – 4               | 9.5 – 101.6 | 0.50             | 12.7 | -40°F – 122°F<br>(-40°C – 50°C) | 0.060          | 1.52 | 1               |
| T50F-C8     | Polyethylene | Gray    | 100             | 30.5  | 3/8 – 4               | 9.5 – 101.6 | 0.50             | 12.7 | -40°F – 122°F<br>(-40°C – 50°C) | 0.060          | 1.52 | 1               |
| T50F-C10    | Polyethylene | White   | 100             | 30.5  | 3/8 – 4               | 9.5 – 101.6 | 0.50             | 12.7 | -40°F – 122°F<br>(-40°C – 50°C) | 0.060          | 1.52 | 1               |
| T50F-C16    | Polyethylene | Pink    | 100             | 30.5  | 3/8 – 4               | 9.5 – 101.6 | 0.50             | 12.7 | -40°F – 122°F<br>(-40°C – 50°C) | 0.060          | 1.52 | 1               |

\*Flame retardant products are manufactured from a material that is rated UL 94V-0.

‡Reel packaging may contain splices. Contact Panduit Customer Service for further information.



## Spiral Wrap (continued)

| Part Number | Material                       | Color   | Length Per Reel |       | Bundle Diameter Range |              | Outside Diameter |      | Temperature Range               | Wall Thickness |      | Std. Pkg. Qty.‡ |
|-------------|--------------------------------|---------|-----------------|-------|-----------------------|--------------|------------------|------|---------------------------------|----------------|------|-----------------|
|             |                                |         | Ft.             | m     | In.                   | mm           | In.              | mm   |                                 | In.            | mm   |                 |
| T50F-TL     | Polyethylene                   | Natural | 250             | 76.2  | 3/8 – 4               | 9.5 – 101.6  | 0.50             | 12.7 | -40°F – 122°F<br>(-40°C – 50°C) | 0.060          | 1.52 | 1               |
| T50F-TL4Y   | Polyethylene                   | Yellow  | 250             | 76.2  | 3/8 – 4               | 9.5 – 101.6  | 0.50             | 12.7 | -40°F – 122°F<br>(-40°C – 50°C) | 0.060          | 1.52 | 1               |
| T62F-C      | Polyethylene                   | Natural | 100             | 30.5  | 1/2 – 4 1/2           | 12.7 – 114.3 | 0.62             | 15.9 | -40°F – 122°F<br>(-40°C – 50°C) | 0.062          | 1.57 | 1               |
| T62F-TL     | Polyethylene                   | Natural | 250             | 76.2  | 1/2 – 4 1/2           | 12.7 – 114.3 | 0.62             | 15.9 | -40°F – 122°F<br>(-40°C – 50°C) | 0.062          | 1.57 | 1               |
| T75F-C      | Polyethylene                   | Natural | 100             | 30.5  | 5/8 – 5               | 15.9 – 127.0 | 0.75             | 19.1 | -40°F – 122°F<br>(-40°C – 50°C) | 0.065          | 1.65 | 1               |
| T75F-T      | Polyethylene                   | Natural | 200             | 61.0  | 5/8 – 5               | 15.9 – 127.0 | 0.75             | 19.1 | -40°F – 122°F<br>(-40°C – 50°C) | 0.065          | 1.65 | 1               |
| T100F-C     | Polyethylene                   | Natural | 100             | 30.5  | 7/8 – 6               | 22.2 – 152.4 | 1.00             | 25.4 | -40°F – 122°F<br>(-40°C – 50°C) | 0.070          | 1.78 | 1               |
| T12F-C0     | Weather Resistant Polyethylene | Black   | 100             | 30.5  | 1/16 – 1/2            | 1.6 – 12.7   | 0.12             | 3.2  | -40°F – 122°F<br>(-40°C – 50°C) | 0.030          | 0.76 | 1               |
| T12F-D0     | Weather Resistant Polyethylene | Black   | 500             | 152.4 | 1/16 – 1/2            | 1.6 – 12.7   | 0.12             | 3.2  | -40°F – 122°F<br>(-40°C – 50°C) | 0.030          | 0.76 | 1               |
| T19F-C0     | Weather Resistant Polyethylene | Black   | 100             | 30.5  | 1/8 – 1               | 3.2 – 25.4   | 0.19             | 4.8  | -40°F – 122°F<br>(-40°C – 50°C) | 0.035          | 0.89 | 1               |
| T25F-X0     | Weather Resistant Polyethylene | Black   | 10              | 3.1   | 3/16 – 2              | 4.8 – 50.8   | 0.25             | 6.4  | -40°F – 122°F<br>(-40°C – 50°C) | 0.040          | 1.02 | 1               |
| T25F-C0     | Weather Resistant Polyethylene | Black   | 100             | 30.5  | 3/16 – 2              | 4.8 – 50.8   | 0.25             | 6.4  | -40°F – 122°F<br>(-40°C – 50°C) | 0.040          | 1.02 | 1               |
| T25F-M0     | Weather Resistant Polyethylene | Black   | 1,000           | 304.8 | 3/16 – 2              | 4.8 – 50.8   | 0.25             | 6.4  | -40°F – 122°F<br>(-40°C – 50°C) | 0.040          | 1.02 | 1               |
| T38F-C0     | Weather Resistant Polyethylene | Black   | 100             | 30.5  | 5/16 – 3              | 7.9 – 76.2   | 0.38             | 9.5  | -40°F – 122°F<br>(-40°C – 50°C) | 0.055          | 1.40 | 1               |
| T38F-TL0    | Weather Resistant Polyethylene | Black   | 250             | 76.2  | 5/16 – 3              | 7.9 – 76.2   | 0.38             | 9.5  | -40°F – 122°F<br>(-40°C – 50°C) | 0.055          | 1.40 | 1               |
| T50F-X0     | Weather Resistant Polyethylene | Black   | 10              | 3.1   | 3/8 – 4               | 9.5 – 101.6  | 0.50             | 12.7 | -40°F – 122°F<br>(-40°C – 50°C) | 0.060          | 1.52 | 1               |
| T50F-C0     | Weather Resistant Polyethylene | Black   | 100             | 30.5  | 3/8 – 4               | 9.5 – 101.6  | 0.50             | 12.7 | -40°F – 122°F<br>(-40°C – 50°C) | 0.060          | 1.52 | 1               |
| T50F-TL0    | Weather Resistant Polyethylene | Black   | 250             | 76.2  | 3/8 – 4               | 9.5 – 101.6  | 0.50             | 12.7 | -40°F – 122°F<br>(-40°C – 50°C) | 0.060          | 1.52 | 1               |
| T62F-C0     | Weather Resistant Polyethylene | Black   | 100             | 30.5  | 1/2 – 4 1/2           | 12.7 – 114.3 | 0.62             | 15.9 | -40°F – 122°F<br>(-40°C – 50°C) | 0.062          | 1.57 | 1               |
| T62F-TL0    | Weather Resistant Polyethylene | Black   | 250             | 76.2  | 1/2 – 4 1/2           | 12.7 – 114.3 | 0.62             | 15.9 | -40°F – 122°F<br>(-40°C – 50°C) | 0.062          | 1.57 | 1               |
| T75F-C0     | Weather Resistant Polyethylene | Black   | 100             | 30.5  | 5/8 – 5               | 15.9 – 127.0 | 0.75             | 19.1 | -40°F – 122°F<br>(-40°C – 50°C) | 0.065          | 1.65 | 1               |
| T75F-T0     | Weather Resistant Polyethylene | Black   | 200             | 61.0  | 5/8 – 5               | 15.9 – 127.0 | 0.75             | 19.1 | -40°F – 122°F<br>(-40°C – 50°C) | 0.065          | 1.65 | 1               |
| T100F-C0    | Weather Resistant Polyethylene | Black   | 100             | 30.5  | 7/8 – 6               | 22.2 – 152.4 | 1.00             | 25.4 | -40°F – 122°F<br>(-40°C – 50°C) | 0.070          | 1.78 | 1               |
| T12R-CY     | Fire Resistant Polyethylene    | Natural | 100             | 30.5  | 1/16 – 1/2            | 1.6 – 12.7   | 0.12             | 3.2  | -40°F – 122°F<br>(-40°C – 50°C) | 0.030          | 0.76 | 1               |
| T19R-CY     | Fire Resistant Polyethylene    | Natural | 100             | 30.5  | 1/8 – 1               | 3.2 – 25.4   | 0.19             | 4.8  | -40°F – 122°F<br>(-40°C – 50°C) | 0.035          | 0.89 | 1               |
| T25R-CY     | Fire Resistant Polyethylene    | Natural | 100             | 30.5  | 3/16 – 2              | 4.8 – 50.8   | 0.25             | 6.4  | -40°F – 122°F<br>(-40°C – 50°C) | 0.040          | 1.02 | 1               |
| T25R-C20Y   | Fire Resistant Polyethylene    | Black   | 100             | 30.5  | 3/16 – 2              | 4.8 – 50.8   | 0.25             | 6.4  | -40°F – 122°F<br>(-40°C – 50°C) | 0.040          | 1.02 | 1               |

\*Flame retardant products are manufactured from a material that is rated UL 94V-0.

‡Reel packaging may contain splices. Contact Panduit Customer Service for further information.

Table continues on page C3.6

A. System Overview

## Spiral Wrap (continued)

B1. Cable Ties

B2. Cable Accessories

B3. Stainless Steel Ties

C1. Wiring Duct

C2. Surface Raceway

C3. Abrasion Protection

C4. Cable Management

D1. Terminals

D2. Power Connectors

D3. Grounding Connectors

E1. Labeling Systems

E2. Labels

E3. Pre-Printed & Write-On Markers

E4. Permanent Identification

E5. Lockout/Tagout & Safety Solutions

F. Index

| Part Number | Material*                    | Color   | Length Per Reel |       | Bundle Diameter Range |              | Outside Diameter |      | Temperature Range               | Wall Thickness |      | Std. Pkg. Qty.‡ |
|-------------|------------------------------|---------|-----------------|-------|-----------------------|--------------|------------------|------|---------------------------------|----------------|------|-----------------|
|             |                              |         | Ft.             | m     | In.                   | mm           | In.              | mm   |                                 | In.            | mm   |                 |
| T25R-MY     | Fire Resistant Polyethylene  | Natural | 1,000           | 304.8 | 3/16 – 2              | 4.8 – 50.8   | 0.25             | 6.4  | -40°F – 122°F<br>(-40°C – 50°C) | 0.040          | 1.02 | 1               |
| T25R-M20Y   | Fire Resistant Polyethylene  | Black   | 1,000           | 304.8 | 3/16 – 2              | 4.8 – 50.8   | 0.25             | 6.4  | -40°F – 122°F<br>(-40°C – 50°C) | 0.040          | 1.02 | 1               |
| T38R-CY     | Fire Resistant Polyethylene  | Natural | 100             | 30.5  | 5/16 – 3              | 7.9 – 76.2   | 0.38             | 9.5  | -40°F – 122°F<br>(-40°C – 50°C) | 0.055          | 1.40 | 1               |
| T38R-TLY    | Fire Resistant Polyethylene  | Natural | 250             | 76.2  | 5/16 – 3              | 7.9 – 76.2   | 0.38             | 9.5  | -40°F – 122°F<br>(-40°C – 50°C) | 0.055          | 1.40 | 1               |
| T50R-CY     | Fire Resistant Polyethylene  | Natural | 100             | 30.5  | 3/8 – 4               | 9.5 – 101.6  | 0.50             | 12.7 | -40°F – 122°F<br>(-40°C – 50°C) | 0.060          | 1.52 | 1               |
| T50R-TLY    | Fire Resistant Polyethylene  | Natural | 250             | 76.2  | 3/8 – 4               | 9.5 – 101.6  | 0.50             | 12.7 | -40°F – 122°F<br>(-40°C – 50°C) | 0.060          | 1.52 | 1               |
| T62R-CY     | Fire Resistant Polyethylene  | Natural | 100             | 30.5  | 1/2 – 4 1/2           | 12.7 – 114.3 | 0.62             | 15.9 | -40°F – 122°F<br>(-40°C – 50°C) | 0.062          | 1.57 | 1               |
| T75R-CY     | Fire Resistant Polyethylene  | Natural | 100             | 30.5  | 5/8 – 5               | 15.9 – 127.0 | 0.75             | 19.1 | -40°F – 122°F<br>(-40°C – 50°C) | 0.065          | 1.65 | 1               |
| T100R-CY    | Fire Resistant Polyethylene  | Natural | 100             | 30.5  | 7/8 – 6               | 22.2 – 152.4 | 1.00             | 25.4 | -40°F – 122°F<br>(-40°C – 50°C) | 0.070          | 1.78 | 1               |
| T12FR-CY    | Flame Retardant Polyethylene | Natural | 100             | 30.5  | 1/16 – 1/2            | 1.6 – 12.7   | 0.12             | 3.2  | -4°F – 167°F<br>(-20°C – 75°C)  | 0.030          | 0.76 | 1               |
| T12FR-C20Y  | Flame Retardant Polyethylene | Black   | 100             | 30.5  | 1/16 – 1/2            | 1.6 – 12.7   | 0.12             | 3.2  | -4°F – 167°F<br>(-20°C – 75°C)  | 0.030          | 0.76 | 1               |
| T19FR-CY    | Flame Retardant Polyethylene | Natural | 100             | 30.5  | 1/8 – 1               | 3.2 – 25.4   | 0.19             | 4.8  | -4°F – 167°F<br>(-20°C – 75°C)  | 0.035          | 0.89 | 1               |
| T19FR-C20Y  | Flame Retardant Polyethylene | Black   | 100             | 30.5  | 1/8 – 1               | 3.2 – 25.4   | 0.19             | 4.8  | -4°F – 167°F<br>(-20°C – 75°C)  | 0.035          | 0.89 | 1               |
| T25FR-CY    | Flame Retardant Polyethylene | Natural | 100             | 30.5  | 3/16 – 2              | 4.8 – 50.8   | 0.25             | 6.4  | -4°F – 167°F<br>(-20°C – 75°C)  | 0.040          | 1.02 | 1               |
| T25FR-C20Y  | Flame Retardant Polyethylene | Black   | 100             | 30.5  | 3/16 – 2              | 4.8 – 50.8   | 0.25             | 6.4  | -4°F – 167°F<br>(-20°C – 75°C)  | 0.040          | 1.02 | 1               |
| T25FR-MY    | Flame Retardant Polyethylene | Natural | 1,000           | 304.8 | 3/16 – 2              | 4.8 – 50.8   | 0.25             | 6.4  | -4°F – 167°F<br>(-20°C – 75°C)  | 0.040          | 1.02 | 1               |
| T25FR-M20Y  | Flame Retardant Polyethylene | Black   | 1,000           | 304.8 | 3/16 – 2              | 4.8 – 50.8   | 0.25             | 6.4  | -4°F – 167°F<br>(-20°C – 75°C)  | 0.040          | 1.02 | 1               |
| T38FR-CY    | Flame Retardant Polyethylene | Natural | 100             | 30.5  | 5/16 – 3              | 7.9 – 76.2   | 0.38             | 9.5  | -4°F – 167°F<br>(-20°C – 75°C)  | 0.055          | 1.40 | 1               |
| T38FR-C20Y  | Flame Retardant Polyethylene | Black   | 100             | 30.5  | 5/16 – 3              | 7.9 – 76.2   | 0.38             | 9.5  | -4°F – 167°F<br>(-20°C – 75°C)  | 0.055          | 1.40 | 1               |
| T38FR-TLY   | Flame Retardant Polyethylene | Natural | 250             | 76.2  | 5/16 – 3              | 7.9 – 76.2   | 0.38             | 9.5  | -4°F – 167°F<br>(-20°C – 75°C)  | 0.055          | 1.40 | 1               |
| T50FR-CY    | Flame Retardant Polyethylene | Natural | 100             | 30.5  | 3/8 – 4               | 9.5 – 101.6  | 0.50             | 12.7 | -4°F – 167°F<br>(-20°C – 75°C)  | 0.060          | 1.52 | 1               |
| T50FR-C20Y  | Flame Retardant Polyethylene | Black   | 100             | 30.5  | 3/8 – 4               | 9.5 – 101.6  | 0.50             | 12.7 | -4°F – 167°F<br>(-20°C – 75°C)  | 0.060          | 1.52 | 1               |
| T50FR-TLY   | Flame Retardant Polyethylene | Natural | 250             | 76.2  | 3/8 – 4               | 9.5 – 101.6  | 0.50             | 12.7 | -4°F – 167°F<br>(-20°C – 75°C)  | 0.060          | 1.52 | 1               |
| T62FR-CY    | Flame Retardant Polyethylene | Natural | 100             | 30.5  | 1/2 – 4 1/2           | 12.7 – 114.3 | 0.62             | 15.9 | -4°F – 167°F<br>(-20°C – 75°C)  | 0.062          | 1.57 | 1               |
| T62FR-C20Y  | Flame Retardant Polyethylene | Black   | 100             | 30.5  | 1/2 – 4 1/2           | 12.7 – 114.3 | 0.62             | 15.9 | -4°F – 167°F<br>(-20°C – 75°C)  | 0.062          | 1.57 | 1               |
| T75FR-CY    | Flame Retardant Polyethylene | Natural | 100             | 30.5  | 5/8 – 5               | 15.9 – 127.0 | 0.75             | 19.1 | -4°F – 167°F<br>(-20°C – 75°C)  | 0.065          | 1.65 | 1               |
| T75FR-C20Y  | Flame Retardant Polyethylene | Black   | 100             | 30.5  | 5/8 – 5               | 15.9 – 127.0 | 0.75             | 19.1 | -4°F – 167°F<br>(-20°C – 75°C)  | 0.065          | 1.65 | 1               |
| T75FR-TY    | Flame Retardant Polyethylene | Natural | 200             | 61.0  | 5/8 – 5               | 15.9 – 127.0 | 0.75             | 19.1 | -4°F – 167°F<br>(-20°C – 75°C)  | 0.065          | 1.65 | 1               |
| T100FR-CY   | Flame Retardant Polyethylene | Natural | 100             | 30.5  | 7/8 – 6               | 22.2 – 152.4 | 1.00             | 25.4 | -4°F – 167°F<br>(-20°C – 75°C)  | 0.070          | 1.78 | 1               |
| T100FR-C20Y | Flame Retardant Polyethylene | Black   | 100             | 30.5  | 7/8 – 6               | 22.2 – 152.4 | 1.00             | 25.4 | -4°F – 167°F<br>(-20°C – 75°C)  | 0.070          | 1.78 | 1               |

\*Flame retardant products are manufactured from a material that is rated UL 94V-0.

‡Reel packaging may contain splices. Contact Panduit Customer Service for further information.

## Spiral Wrap (continued)

| Part Number | Material*                       | Color   | Length Per Reel |      | Bundle Diameter Range |              | Outside Diameter |      | Temperature Range                  | Wall Thickness |      | Std. Pkg. Qty.‡ |
|-------------|---------------------------------|---------|-----------------|------|-----------------------|--------------|------------------|------|------------------------------------|----------------|------|-----------------|
|             |                                 |         | Ft.             | m    | In.                   | mm           | In.              | mm   |                                    | In.            | mm   |                 |
| T12N-C      | Nylon 6.6                       | Natural | 100             | 30.5 | 1/16 – 1/2            | 1.6 – 12.7   | 0.12             | 3.2  | -40°F – 149°F<br>(-40°C – 65°C)    | 0.015          | 0.38 | 1               |
| T19N-C      | Nylon 6.6                       | Natural | 100             | 30.5 | 1/8 – 1               | 3.2 – 25.4   | 0.19             | 4.8  | -40°F – 149°F<br>(-40°C – 65°C)    | 0.020          | 0.51 | 1               |
| T25N-C      | Nylon 6.6                       | Natural | 100             | 30.5 | 3/16 – 2              | 4.8 – 50.8   | 0.25             | 6.4  | -40°F – 149°F<br>(-40°C – 65°C)    | 0.023          | 0.58 | 1               |
| T38N-C      | Nylon 6.6                       | Natural | 100             | 30.5 | 5/16 – 3              | 7.9 – 76.2   | 0.38             | 9.5  | -40°F – 149°F<br>(-40°C – 65°C)    | 0.030          | 0.76 | 1               |
| T50N-C      | Nylon 6.6                       | Natural | 100             | 30.5 | 3/8 – 4               | 9.5 – 101.6  | 0.50             | 12.7 | -40°F – 149°F<br>(-40°C – 65°C)    | 0.032          | 0.81 | 1               |
| T62N-C      | Nylon 6.6                       | Natural | 100             | 30.5 | 1/2 – 4 1/2           | 12.7 – 114.3 | 0.62             | 15.9 | -40°F – 149°F<br>(-40°C – 65°C)    | 0.035          | 0.89 | 1               |
| T75N-C      | Nylon 6.6                       | Natural | 100             | 30.5 | 5/8 – 5               | 15.9 – 127.0 | 0.75             | 19.1 | -40°F – 149°F<br>(-40°C – 65°C)    | 0.040          | 1.02 | 1               |
| T100N-C     | Nylon 6.6                       | Natural | 100             | 30.5 | 7/8 – 6               | 22.2 – 152.4 | 1.00             | 25.4 | -40°F – 149°F<br>(-40°C – 65°C)    | 0.045          | 1.14 | 1               |
| T12N-C0     | Weather Resistant Nylon 6.6     | Black   | 100             | 30.5 | 1/16 – 1/2            | 1.6 – 12.7   | 0.12             | 3.2  | -40°F – 149°F<br>(-40°C – 65°C)    | 0.015          | 0.38 | 1               |
| T19N-C0     | Weather Resistant Nylon 6.6     | Black   | 100             | 30.5 | 1/8 – 1               | 3.2 – 25.4   | 0.19             | 4.8  | -40°F – 149°F<br>(-40°C – 65°C)    | 0.020          | 0.51 | 1               |
| T25N-C0     | Weather Resistant Nylon 6.6     | Black   | 100             | 30.5 | 3/16 – 2              | 4.8 – 50.4   | 0.25             | 6.4  | -40°F – 149°F<br>(-40°C – 65°C)    | 0.023          | 0.58 | 1               |
| T38N-C0     | Weather Resistant Nylon 6.6     | Black   | 100             | 30.5 | 5/16 – 3              | 7.9 – 76.2   | 0.38             | 9.5  | -40°F – 149°F<br>(-40°C – 65°C)    | 0.030          | 0.76 | 1               |
| T50N-C0     | Weather Resistant Nylon 6.6     | Black   | 100             | 30.5 | 3/8 – 4               | 9.5 – 101.6  | 0.50             | 12.7 | -40°F – 149°F<br>(-40°C – 65°C)    | 0.032          | 0.81 | 1               |
| T62N-C0     | Weather Resistant Nylon 6.6     | Black   | 100             | 30.5 | 1/2 – 4 1/2           | 12.7 – 114.3 | 0.62             | 15.9 | -40°F – 149°F<br>(-40°C – 65°C)    | 0.035          | 0.89 | 1               |
| T75N-C0     | Weather Resistant Nylon 6.6     | Black   | 100             | 30.5 | 5/8 – 5               | 15.9 – 127.0 | 0.75             | 19.1 | -40°F – 149°F<br>(-40°C – 65°C)    | 0.040          | 1.02 | 1               |
| T100N-C0    | Weather Resistant Nylon 6.6     | Black   | 100             | 30.5 | 7/8 – 6               | 22.2 – 152.4 | 1.00             | 25.4 | -40°F – 149°F<br>(-40°C – 65°C)    | 0.045          | 1.14 | 1               |
| T38P-C0     | Weather Resistant Polypropylene | Black   | 100             | 30.5 | 5/16 – 3              | 7.9 – 76.2   | 0.38             | 9.5  | -40°F – 239°F<br>(-40°C – 115°C)   | 0.030          | 0.76 | 1               |
| T50P-C0     | Weather Resistant Polypropylene | Black   | 100             | 30.5 | 3/8 – 4               | 9.5 – 101.6  | 0.50             | 12.7 | -40°F – 239°F<br>(-40°C – 115°C)   | 0.030          | 0.76 | 1               |
| T100P-C0    | Weather Resistant Polypropylene | Black   | 100             | 30.5 | 7/8 – 6               | 22.2 – 152.4 | 1.00             | 25.4 | -40°F – 239°F<br>(-40°C – 115°C)   | 0.030          | 0.76 | 1               |
| T12T-C      | TFE^                            | Natural | 100             | 30.5 | 1/16 – 1/2            | 1.6 – 12.7   | 0.12             | 3.2  | -454°F – 500°F<br>(-270°C – 260°C) | 0.020          | 0.51 | 1               |
| T19T-C      | TFE^                            | Natural | 100             | 30.5 | 1/8 – 1               | 3.2 – 25.4   | 0.19             | 4.8  | -454°F – 500°F<br>(-270°C – 260°C) | 0.030          | 0.76 | 1               |
| T25T-L      | TFE^                            | Natural | 50              | 15.2 | 3/16 – 2              | 4.8 – 50.8   | 0.25             | 6.4  | -454°F – 500°F<br>(-270°C – 260°C) | 0.030          | 0.76 | 1               |
| T25T-L0     | TFE^                            | Black   | 50              | 15.2 | 3/16 – 2              | 4.8 – 50.8   | 0.25             | 6.4  | -40°F – 500°F<br>(-40°C – 260°C)   | 0.030          | 0.76 | 1               |
| T38T-L      | TFE^                            | Natural | 50              | 15.2 | 5/16 – 3              | 7.9 – 76.2   | 0.38             | 9.5  | -40°F – 500°F<br>(-40°C – 260°C)   | 0.030          | 0.76 | 1               |
| T50T-Q      | TFE^                            | Natural | 25              | 7.6  | 3/8 – 4               | 9.5 – 101.6  | 0.50             | 12.7 | -454°F – 500°F<br>(-270°C – 260°C) | 0.030          | 0.76 | 1               |
| T62T-Q      | TFE^                            | Natural | 25              | 7.6  | 1/2 – 4 1/2           | 12.7 – 114.3 | 0.62             | 15.9 | -454°F – 500°F<br>(-270°C – 260°C) | 0.030          | 0.76 | 1               |
| T75T-X      | TFE^                            | Natural | 10              | 3.1  | 5/8 – 5               | 15.9 – 127.0 | 0.75             | 19.1 | -454°F – 500°F<br>(-270°C – 260°C) | 0.030          | 0.76 | 1               |
| T100T-X     | TFE^                            | Natural | 10              | 3.1  | 7/8 – 6               | 22.2 – 152.4 | 1.00             | 25.4 | -454°F – 500°F<br>(-270°C – 260°C) | 0.040          | 1.02 | 1               |

\*Flame retardant products are manufactured from a material that is rated UL 94V-0.

‡Reel packaging may contain splices. Contact Panduit Customer Service for further information.

^TFE is Polytetrafluorethylene material.

A.  
System  
Overview

B1.  
Cable  
Ties

B2.  
Cable  
Accessories

B3.  
Stainless  
Steel Ties

C1.  
Wiring  
Duct

C2.  
Surface  
Raceway

C3.  
Abrasion  
Protection

C4.  
Cable  
Management

D1.  
Terminals

D2.  
Power  
Connectors

D3.  
Grounding  
Connectors

E1.  
Labeling  
Systems

E2.  
Labels

E3.  
Pre-Printed  
& Write-On  
Markers

E4.  
Permanent  
Identification

E5.  
Lockout/  
Tagout  
& Safety  
Solutions

F.  
Index

A. System Overview

## Part Number System for Grommet Edging

B1. Cable Ties

**GEE**

**36**

**F**

**-**

**A**

**-**

**C**

**0**

B2. Cable Accessories

**Type**

**Max. Panel Thickness**

**Material**

**Adhesive**

**Package Size**

**Color Suffix**

GE = Grommet Edging Strips  
 36 = 0.036" thickness  
 62 = 0.062" thickness  
 GEE = Slotted Grommet Edging  
 99 = 0.099" thickness  
 GES = Solid Grommet Edging  
 144 = 0.144" thickness  
 189 = 0.189" thickness

F = Polyethylene  
 N = Nylon 6.6  
 FR = Flame Retardant Polyethylene

A = Adhesive Lined  
 Leave Blank = Non-Adhesive

Q = 25'  
 L = 50'  
 C = 100'

0 = Weather Resistant Black  
 Leave Blank = Natural

B3. Stainless Steel Ties

C1. Wiring Duct

C2. Surface Raceway

C3. Abrasion Protection

## Grommet Edging

- Use slotted product on irregularly shaped and round panel holes
- Solid product is used only on straight edges
- Provided in 0.030" (0.8mm) thick material making it highly flexible

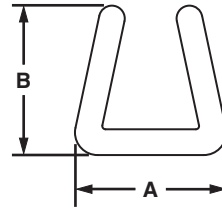

C4. Cable Management

D1. Terminals

D2. Power Connectors

D3. Grounding Connectors

| Part Number    | Width A |     | Height B |     | Panel Thickness Range |           | Material                       | Color   | Temperature Range               | Std. Pkg. Qty.‡ |
|----------------|---------|-----|----------|-----|-----------------------|-----------|--------------------------------|---------|---------------------------------|-----------------|
|                | In.     | mm  | In.      | mm  | In.                   | mm        |                                |         |                                 |                 |
| <b>Slotted</b> |         |     |          |     |                       |           |                                |         |                                 |                 |
| GEE36F-C       | 0.11    | 2.7 | 0.12     | 3.0 | 0.026 – 0.036         | 0.7 – 0.9 | Polyethylene                   | Natural | -40°F – 122°F<br>(-40°C – 50°C) | 1               |
| GEE36F-C0      | 0.11    | 2.7 | 0.12     | 3.0 | 0.026 – 0.036         | 0.7 – 0.9 | Weather Resistant Polyethylene | Black   |                                 | 1               |
| GEE62F-C       | 0.13    | 3.3 | 0.16     | 4.1 | 0.036 – 0.062         | 0.9 – 1.6 | Polyethylene                   | Natural |                                 | 1               |
| GEE62F-C0      | 0.13    | 3.3 | 0.16     | 4.1 | 0.036 – 0.062         | 0.9 – 1.6 | Weather Resistant Polyethylene | Black   |                                 | 1               |
| GEE99F-C       | 0.17    | 4.3 | 0.19     | 4.7 | 0.062 – 0.099         | 1.6 – 2.5 | Polyethylene                   | Natural |                                 | 1               |
| GEE99F-C0      | 0.17    | 4.3 | 0.19     | 4.7 | 0.062 – 0.099         | 1.6 – 2.5 | Weather Resistant Polyethylene | Black   |                                 | 1               |
| GEE144F-C      | 0.21    | 5.4 | 0.22     | 5.6 | 0.099 – 0.144         | 2.5 – 3.7 | Polyethylene                   | Natural |                                 | 1               |
| GEE144F-C0     | 0.21    | 5.4 | 0.22     | 5.6 | 0.099 – 0.144         | 2.5 – 3.7 | Weather Resistant Polyethylene | Black   |                                 | 1               |

‡Reel packaging may contain splices. Contact Panduit Customer Service for further information.

E5. Lockout/Tagout & Safety Solutions

F. Index

## Grommet Edging (continued)

| Part Number  | Width A |     | Height B |     | Panel Thickness Range |           | Material                       | Color   | Temperature Range               | Std. Pkg. Qty.‡ |
|--|---------|-----|----------|-----|-----------------------|-----------|--------------------------------|---------|---------------------------------|-----------------|
|  | In.     | mm  | In.      | mm  | In.                   | mm        |                                |         |                                 |                 |
| <b>Solid – Use on straight edges only</b>                |         |     |          |     |                       |           |                                |         |                                 |                 |
| GES36F-C   | 0.11    | 2.7 | 0.12     | 3.0 | 0.026 – 0.036         | 0.7 – 0.9 | Polyethylene                   | Natural | -40°F – 122°F<br>(-40°C – 50°C) | 1               |
| GES36F-C0  | 0.11    | 2.7 | 0.12     | 3.0 | 0.026 – 0.036         | 0.7 – 0.9 | Weather Resistant Polyethylene | Black   |                                 | 1               |
| GES62F-C   | 0.13    | 3.3 | 0.16     | 4.1 | 0.036 – 0.062         | 0.9 – 1.6 | Polyethylene                   | Natural |                                 | 1               |
| GES62F-C0  | 0.13    | 3.3 | 0.16     | 4.1 | 0.036 – 0.062         | 0.9 – 1.6 | Weather Resistant Polyethylene | Black   |                                 | 1               |
| GES99F-C   | 0.17    | 4.3 | 0.19     | 4.7 | 0.062 – 0.099         | 1.6 – 2.5 | Polyethylene                   | Natural |                                 | 1               |
| GES99F-C0  | 0.17    | 4.3 | 0.19     | 4.7 | 0.062 – 0.099         | 1.6 – 2.5 | Weather Resistant Polyethylene | Black   |                                 | 1               |
| GES144F-C  | 0.21    | 5.4 | 0.22     | 5.6 | 0.099 – 0.144         | 2.5 – 3.7 | Polyethylene                   | Natural |                                 | 1               |
| GES144F-C0   | 0.21    | 5.4 | 0.22     | 5.6 | 0.099 – 0.144         | 2.5 – 3.7 | Weather Resistant Polyethylene | Black   |                                 | 1               |
| GES189F-C  | 0.30    | 7.6 | 0.30     | 7.6 | 0.144 – 0.189         | 3.7 – 4.8 | Polyethylene                   | Natural |                                 | 1               |
| GES189F-C0   | 0.30    | 7.6 | 0.30     | 7.6 | 0.144 – 0.189         | 3.7 – 4.8 | Weather Resistant Polyethylene | Black   |                                 | 1               |
| <b>Slotted Adhesive Lined</b>                            |         |     |          |     |                       |           |                                |         |                                 |                 |
| GEE62F-A-C   | 0.13    | 3.3 | 0.16     | 4.1 | 0.036 – 0.062         | 0.9 – 1.6 | Polyethylene                   | Natural | -40°F – 122°F<br>(-40°C – 50°C) | 1               |
| GEE62F-A-C0  | 0.13    | 3.3 | 0.16     | 4.1 | 0.036 – 0.062         | 0.9 – 1.6 | Weather Resistant Polyethylene | Black   |                                 | 1               |
| GEE99F-A-C   | 0.17    | 4.3 | 0.19     | 4.7 | 0.062 – 0.099         | 1.6 – 2.5 | Polyethylene                   | Natural |                                 | 1               |
| GEE99F-A-C0  | 0.17    | 4.3 | 0.19     | 4.7 | 0.062 – 0.099         | 1.6 – 2.5 | Weather Resistant Polyethylene | Black   |                                 | 1               |
| GEE144F-A-C  | 0.21    | 5.4 | 0.22     | 5.6 | 0.099 – 0.144         | 2.5 – 3.7 | Polyethylene                   | Natural |                                 | 1               |
| GEE144F-A-C0   | 0.21    | 5.4 | 0.22     | 5.6 | 0.099 – 0.144         | 2.5 – 3.7 | Weather Resistant Polyethylene | Black   |                                 | 1               |
| <b>Solid Adhesive Lined – Use on straight edges only</b> |         |     |          |     |                       |           |                                |         |                                 |                 |
| GES62F-A-C   | 0.13    | 3.3 | 0.16     | 4.1 | 0.036 – 0.062         | 0.9 – 1.6 | Polyethylene                   | Natural | -40°F – 122°F<br>(-40°C – 50°C) | 1               |
| GES62F-A-C0  | 0.13    | 3.3 | 0.16     | 4.1 | 0.036 – 0.062         | 0.9 – 1.6 | Weather Resistant Polyethylene | Black   |                                 | 1               |
| GES99F-A-C   | 0.17    | 4.3 | 0.19     | 4.7 | 0.062 – 0.099         | 1.6 – 2.5 | Polyethylene                   | Natural |                                 | 1               |
| GES99F-A-C0  | 0.17    | 4.3 | 0.19     | 4.7 | 0.062 – 0.099         | 1.6 – 2.5 | Weather Resistant Polyethylene | Black   |                                 | 1               |
| GES144F-A-C  | 0.21    | 5.4 | 0.22     | 5.6 | 0.099 – 0.144         | 2.5 – 3.7 | Polyethylene                   | Natural |                                 | 1               |
| GES144F-A-C0   | 0.21    | 5.4 | 0.22     | 5.6 | 0.099 – 0.144         | 2.5 – 3.7 | Weather Resistant Polyethylene | Black   |                                 | 1               |
| <b>Slotted Flame Retardant</b>                           |         |     |          |     |                       |           |                                |         |                                 |                 |
| GEE36FR-CY   | 0.11    | 2.7 | 0.12     | 3.0 | 0.026 – 0.036         | 0.7 – 0.9 | Flame Retardant Polyethylene   | Natural | -4°F – 167°F<br>(-20°C – 75°C)  | 1               |
| GEE62FR-CY   | 0.13    | 3.3 | 0.16     | 4.1 | 0.036 – 0.062         | 0.9 – 1.6 | Flame Retardant Polyethylene   | Natural |                                 | 1               |
| GEE99FR-CY   | 0.17    | 4.3 | 0.19     | 4.7 | 0.062 – 0.099         | 1.6 – 2.5 | Flame Retardant Polyethylene   | Natural |                                 | 1               |
| GEE144FR-CY  | 0.21    | 5.4 | 0.22     | 5.6 | 0.099 – 0.144         | 2.5 – 3.7 | Flame Retardant Polyethylene   | Natural |                                 | 1               |

‡Reel packaging may contain splices. Contact Panduit Customer Service for further information.

Table continues on page C3.10

A.  
System  
Overview

B1.  
Cable  
Ties

B2.  
Cable  
Accessories

B3.  
Stainless  
Steel Ties

C1.  
Wiring  
Duct

C2.  
Surface  
Raceway

C3.  
Abrasion  
Protection

C4.  
Cable  
Management

D1.  
Terminals

D2.  
Power  
Connectors

D3.  
Grounding  
Connectors

E1.  
Labeling  
Systems

E2.  
Labels

E3.  
Pre-Printed  
& Write-On  
Markers

E4.  
Permanent  
Identification

E5.  
Lockout/  
Tagout  
& Safety  
Solutions

F.  
Index

A.  
System  
Overview

## Grommet Edging (continued)

B1.  
Cable Ties

| Part Number | Width<br>A |    | Height<br>B |    | Panel Thickness Range |    | Material | Color | Temperature<br>Range | Std.<br>Pkg.<br>Qty.‡ |
|-------------|------------|----|-------------|----|-----------------------|----|----------|-------|----------------------|-----------------------|
|             | In.        | mm | In.         | mm | In.                   | mm |          |       |                      |                       |

B2.  
Cable  
Accessories

### Solid Flame Retardant – Used on straight edges only

|             |      |     |      |     |               |           |                              |         |                                |   |
|-------------|------|-----|------|-----|---------------|-----------|------------------------------|---------|--------------------------------|---|
| GES36FR-CY  | 0.11 | 2.7 | 0.12 | 3.0 | 0.026 – 0.036 | 0.7 – 0.9 | Flame Retardant Polyethylene | Natural | -4°F – 167°F<br>(-20°C – 75°C) | 1 |
| GES62FR-CY  | 0.13 | 3.3 | 0.16 | 4.1 | 0.036 – 0.062 | 0.9 – 1.6 | Flame Retardant Polyethylene | Natural |                                | 1 |
| GES99FR-CY  | 0.17 | 4.3 | 0.19 | 4.7 | 0.062 – 0.099 | 1.6 – 2.5 | Flame Retardant Polyethylene | Natural |                                | 1 |
| GES144FR-CY | 0.21 | 5.4 | 0.22 | 5.6 | 0.099 – 0.144 | 2.5 – 3.7 | Flame Retardant Polyethylene | Natural |                                | 1 |

B3.  
Stainless  
Steel Ties

C1.  
Wiring  
Duct

### Slotted Nylon

|           |      |     |      |     |               |           |         |         |                                 |   |
|-----------|------|-----|------|-----|---------------|-----------|---------|---------|---------------------------------|---|
| GEE47N-C  | 0.13 | 3.2 | 0.14 | 3.6 | 0.039 – 0.055 | 1.0 – 1.4 | Nylon 6 | Natural | -40°F – 149°F<br>(-40°C – 65°C) | 1 |
| GEE55N-C  | 0.13 | 3.4 | 0.14 | 3.6 | 0.047 – 0.063 | 1.2 – 1.6 | Nylon 6 | Natural |                                 | 1 |
| GEE71N-C  | 0.15 | 3.8 | 0.14 | 3.6 | 0.063 – 0.079 | 1.6 – 2.0 | Nylon 6 | Natural |                                 | 1 |
| GEE98N-C  | 0.18 | 4.6 | 0.14 | 3.6 | 0.091 – 0.106 | 2.3 – 2.7 | Nylon 6 | Natural |                                 | 1 |
| GEE134N-C | 0.21 | 5.3 | 0.14 | 3.6 | 0.126 – 0.142 | 3.2 – 3.6 | Nylon 6 | Natural |                                 | 1 |

C2.  
Surface  
Raceway

C3.  
Abrasion  
Protection

C4.  
Cable  
Management

### Military Standard MS21266 in 12 3/4" Lengths

|            |      |      |      |     |               |            |                           |         |                                 |     |
|------------|------|------|------|-----|---------------|------------|---------------------------|---------|---------------------------------|-----|
| GE52-C     | 0.15 | 3.8  | 0.16 | 3.9 | 0.015 – 0.052 | 0.4 – 1.3  | Nylon 6.6                 | Natural | -40°F – 149°F<br>(-40°C – 65°C) | 100 |
| GE52-C69*  | 0.15 | 3.8  | 0.16 | 3.9 | 0.015 – 0.052 | 0.4 – 1.3  | Flame Retardant Nylon 6.6 | Natural |                                 | 100 |
| GE85-C     | 0.18 | 4.5  | 0.16 | 3.9 | 0.052 – 0.085 | 1.3 – 2.2  | Nylon 6.6                 | Natural |                                 | 100 |
| GE85-C69*  | 0.18 | 4.5  | 0.16 | 3.9 | 0.052 – 0.085 | 1.3 – 2.2  | Flame Retardant Nylon 6.6 | Natural |                                 | 100 |
| GE128-C    | 0.22 | 5.6  | 0.16 | 3.9 | 0.085 – 0.128 | 2.2 – 3.3  | Nylon 6.6                 | Natural |                                 | 100 |
| GE128-C69* | 0.22 | 5.6  | 0.16 | 3.9 | 0.085 – 0.128 | 2.2 – 3.3  | Flame Retardant Nylon 6.6 | Natural |                                 | 100 |
| GE192-L    | 0.33 | 8.3  | 0.23 | 5.8 | 0.128 – 0.192 | 3.3 – 4.9  | Nylon 6.6                 | Natural |                                 | 50  |
| GE192-L69* | 0.33 | 8.3  | 0.23 | 5.8 | 0.128 – 0.192 | 3.3 – 4.9  | Flame Retardant Nylon 6.6 | Natural |                                 | 50  |
| GE255-L    | 0.39 | 9.8  | 0.24 | 6.1 | 0.192 – 0.255 | 4.9 – 6.5  | Nylon 6.6                 | Natural |                                 | 50  |
| GE318-L    | 0.46 | 11.3 | 0.26 | 6.5 | 0.255 – 0.318 | 6.5 – 8.1  | Nylon 6.6                 | Natural |                                 | 50  |
| GE380-Q    | 0.52 | 13.1 | 0.26 | 6.5 | 0.318 – 0.380 | 8.1 – 9.7  | Nylon 6.6                 | Natural | 25                              |     |
| GE510-Q    | 0.64 | 16.3 | 0.26 | 6.5 | 0.380 – 0.510 | 9.7 – 13.0 | Nylon 6.6                 | Natural | 25                              |     |

‡Reel packaging may contain splices. Contact Panduit Customer Service for further information.

\*This material is not listed under Military Standard MS21266.

E4.  
Permanent  
Identification

E5.  
Lockout/  
Tagout/  
& Safety  
Solutions

F.  
Index



## Part Number System for Corrugated Loom Tubing

| CLT                                  | 100   | N   | - | C  | 630  |
|--------------------------------------|---|---|---|--|--|
| Type                                 | Bundle Diameter   | Material                                      |   | Package Size   | Color Suffix   |
| CLT = Slit Wall<br>CLTS = Solid Wall | 25 = 1/4"<br>35 = 5/16"<br>38 = 3/8"<br>50 = 1/2"<br>62 = 5/8"<br>75 = 3/4"<br>100 = 1"<br>125 = 1 1/4"<br>150 = 1 1/2"<br>188 = 1 7/8" | N = Heat Stabilized Nylon<br>F = Polyethylene |   | X = 10'<br>L = 50'<br>C = 100'<br>T = 200'<br>D = 500'<br>.75M = 750'<br>125M = 1,250'<br>2M = 2,000'<br>2.5M = 2,500'<br>4M = 4,000'<br>5M = 5,000'<br>7M = 7,000'<br>10M = 10,000' | 630 = Heat Stabilized Black Nylon 6<br>20 = Black Polyethylene<br>3 = Orange Polyethylene<br>4 = Yellow Polyethylene |

## Corrugated Loom Tubing – Slit



- Provides protection for cables
- Packaged on a reel for easy handling and dispensing of product
- For indoor use only
- Available in Nylon or Polyethylene, this product features a lengthwise slit which makes it easy to install onto a bundle of wires or a pre-assembled harness assembly
- Crush, impact and abrasion resistant

| Part Number      | Material     | Color  | Length Per Reel |        | Inside Diameter |      | Outside Diameter |      | Temperature Range            | Std. Pkg. Qty.* |
|------------------|--------------|--------|-----------------|--------|-----------------|------|------------------|------|------------------------------|-----------------|
|                  |              |        | Ft.             | m      | In.             | mm   | In.              | mm   |                              |                 |
| <b>Slit Wall</b> |              |        |                 |        |                 |      |                  |      |                              |                 |
| CLT25F-C3        | Polyethylene | Orange | 100             | 30.5   | 0.28            | 7.0  | 0.40             | 10.1 | -40°F – 122°F (-40°C – 50°C) | 1               |
| CLT25F-C4        | Polyethylene | Yellow | 100             | 30.5   | 0.28            | 7.0  | 0.40             | 10.1 | -40°F – 122°F (-40°C – 50°C) | 1               |
| CLT25F-C20       | Polyethylene | Black  | 100             | 30.5   | 0.28            | 7.0  | 0.40             | 10.1 | -40°F – 122°F (-40°C – 50°C) | 1               |
| CLT25F-10M20     | Polyethylene | Black  | 10,000          | 3048.0 | 0.28            | 7.0  | 0.40             | 10.1 | -40°F – 122°F (-40°C – 50°C) | 1               |
| CLT35F-C3        | Polyethylene | Orange | 100             | 30.5   | 0.35            | 8.9  | 0.50             | 12.7 | -40°F – 122°F (-40°C – 50°C) | 1               |
| CLT35F-C4        | Polyethylene | Yellow | 100             | 30.5   | 0.35            | 8.9  | 0.50             | 12.7 | -40°F – 122°F (-40°C – 50°C) | 1               |
| CLT35F-C20       | Polyethylene | Black  | 100             | 30.5   | 0.35            | 8.9  | 0.50             | 12.7 | -40°F – 122°F (-40°C – 50°C) | 1               |
| CLT35F-7M20      | Polyethylene | Black  | 7,000           | 2133.6 | 0.35            | 8.9  | 0.50             | 12.7 | -40°F – 122°F (-40°C – 50°C) | 1               |
| CLT38F-C3        | Polyethylene | Orange | 100             | 30.5   | 0.42            | 10.5 | 0.56             | 14.1 | -40°F – 122°F (-40°C – 50°C) | 1               |
| CLT38F-C4        | Polyethylene | Yellow | 100             | 30.5   | 0.42            | 10.5 | 0.56             | 14.1 | -40°F – 122°F (-40°C – 50°C) | 1               |
| CLT38F-C20       | Polyethylene | Black  | 100             | 30.5   | 0.42            | 10.5 | 0.56             | 14.1 | -40°F – 122°F (-40°C – 50°C) | 1               |
| CLT38F-5M20      | Polyethylene | Black  | 5,000           | 1524.0 | 0.42            | 10.5 | 0.56             | 14.1 | -40°F – 122°F (-40°C – 50°C) | 1               |
| CLT50F-C3        | Polyethylene | Orange | 100             | 30.5   | 0.51            | 12.8 | 0.67             | 17.0 | -40°F – 122°F (-40°C – 50°C) | 1               |
| CLT50F-C4        | Polyethylene | Yellow | 100             | 30.5   | 0.51            | 12.8 | 0.67             | 17.0 | -40°F – 122°F (-40°C – 50°C) | 1               |
| CLT50F-C20       | Polyethylene | Black  | 100             | 30.5   | 0.51            | 12.8 | 0.67             | 17.0 | -40°F – 122°F (-40°C – 50°C) | 1               |
| CLT50F-4M20      | Polyethylene | Black  | 4,000           | 1219.2 | 0.51            | 12.8 | 0.67             | 17.0 | -40°F – 122°F (-40°C – 50°C) | 1               |
| CLT62F-C3        | Polyethylene | Orange | 100             | 30.5   | 0.65            | 16.5 | 0.82             | 20.7 | -40°F – 122°F (-40°C – 50°C) | 1               |
| CLT62F-C4        | Polyethylene | Yellow | 100             | 30.5   | 0.65            | 16.5 | 0.82             | 20.7 | -40°F – 122°F (-40°C – 50°C) | 1               |
| CLT62F-C20       | Polyethylene | Black  | 100             | 30.5   | 0.65            | 16.5 | 0.82             | 20.7 | -40°F – 122°F (-40°C – 50°C) | 1               |
| CLT62F-2.5M20    | Polyethylene | Black  | 2,500           | 762.0  | 0.65            | 16.5 | 0.82             | 20.7 | -40°F – 122°F (-40°C – 50°C) | 1               |
| CLT75F-C3        | Polyethylene | Orange | 100             | 30.5   | 0.76            | 19.3 | 0.94             | 23.8 | -40°F – 122°F (-40°C – 50°C) | 1               |

\*Reel packaging may contain splices. Contact Panduit Customer Service for further information.

Table continues on page C3.12

A.  
System  
Overview

## Corrugated Loom Tubing – Slit (continued)

B1.  
Cable Ties

B2.  
Cable  
Accessories

B3.  
Stainless  
Steel Ties

C1.  
Wiring  
Duct

C2.  
Surface  
Raceway

C3.  
Abrasion  
Protection

C4.  
Cable  
Management

| Part Number    | Material     | Color  | Length Per Reel |       | Inside Diameter |      | Outside Diameter |      | Temperature Range            | Std. Pkg. Qty.* |
|----------------|--------------|--------|-----------------|-------|-----------------|------|------------------|------|------------------------------|-----------------|
|                |              |        | Ft.             | m     | In.             | mm   | In.              | mm   |                              |                 |
| CLT75F-C4      | Polyethylene | Yellow | 100             | 30.5  | 0.76            | 19.3 | 0.94             | 23.8 | -40°F – 122°F (-40°C – 50°C) | 1               |
| CLT75F-C20     | Polyethylene | Black  | 100             | 30.5  | 0.76            | 19.3 | 0.94             | 23.8 | -40°F – 122°F (-40°C – 50°C) | 1               |
| CLT75F-2M20    | Polyethylene | Black  | 2,000           | 609.6 | 0.76            | 19.3 | 0.94             | 23.8 | -40°F – 122°F (-40°C – 50°C) | 1               |
| CLT100F-X4     | Polyethylene | Yellow | 10              | 3.1   | 0.92            | 23.2 | 1.09             | 27.7 | -40°F – 122°F (-40°C – 50°C) | 1               |
| CLT100F-C3     | Polyethylene | Orange | 100             | 30.5  | 0.92            | 23.2 | 1.09             | 27.7 | -40°F – 122°F (-40°C – 50°C) | 1               |
| CLT100F-C4     | Polyethylene | Yellow | 100             | 30.5  | 0.92            | 23.2 | 1.09             | 27.7 | -40°F – 122°F (-40°C – 50°C) | 1               |
| CLT100F-C20    | Polyethylene | Black  | 100             | 30.5  | 0.92            | 23.2 | 1.09             | 27.7 | -40°F – 122°F (-40°C – 50°C) | 1               |
| CLT100F-125M20 | Polyethylene | Black  | 1,250           | 381.0 | 0.92            | 23.2 | 1.09             | 27.7 | -40°F – 122°F (-40°C – 50°C) | 1               |
| CLT125F-L3     | Polyethylene | Orange | 50              | 15.2  | 1.29            | 32.8 | 1.50             | 38.1 | -40°F – 122°F (-40°C – 50°C) | 1               |
| CLT125F-L4     | Polyethylene | Yellow | 50              | 15.2  | 1.29            | 32.8 | 1.50             | 38.1 | -40°F – 122°F (-40°C – 50°C) | 1               |
| CLT125F-L20    | Polyethylene | Black  | 50              | 15.2  | 1.29            | 32.8 | 1.50             | 38.1 | -40°F – 122°F (-40°C – 50°C) | 1               |
| CLT125F-.75M20 | Polyethylene | Black  | 750             | 228.6 | 1.29            | 32.8 | 1.50             | 38.1 | -40°F – 122°F (-40°C – 50°C) | 1               |
| CLT150F-X3     | Polyethylene | Orange | 10              | 3.1   | 1.48            | 37.6 | 1.73             | 43.9 | -40°F – 122°F (-40°C – 50°C) | 1               |
| CLT150F-X4     | Polyethylene | Yellow | 10              | 3.1   | 1.48            | 37.6 | 1.73             | 43.9 | -40°F – 122°F (-40°C – 50°C) | 1               |
| CLT150F-T20    | Polyethylene | Black  | 200             | 61.0  | 1.48            | 37.6 | 1.73             | 43.9 | -40°F – 122°F (-40°C – 50°C) | 1               |
| CLT150F-D3     | Polyethylene | Orange | 500             | 152.4 | 1.48            | 37.6 | 1.73             | 43.9 | -40°F – 122°F (-40°C – 50°C) | 1               |
| CLT150F-D4     | Polyethylene | Yellow | 500             | 152.4 | 1.48            | 37.6 | 1.73             | 43.9 | -40°F – 122°F (-40°C – 50°C) | 1               |
| CLT150F-D20    | Polyethylene | Black  | 500             | 152.4 | 1.48            | 37.6 | 1.73             | 43.9 | -40°F – 122°F (-40°C – 50°C) | 1               |
| CLT188F-X3     | Polyethylene | Orange | 10              | 3.1   | 1.88            | 47.8 | 2.17             | 55.1 | -40°F – 122°F (-40°C – 50°C) | 1               |
| CLT188F-X4     | Polyethylene | Yellow | 10              | 3.1   | 1.88            | 47.8 | 2.17             | 55.1 | -40°F – 122°F (-40°C – 50°C) | 1               |
| CLT188F-X20    | Polyethylene | Black  | 10              | 3.1   | 1.88            | 47.8 | 2.17             | 55.1 | -40°F – 122°F (-40°C – 50°C) | 1               |

### Solid Wall

|                |              |        |        |        |      |      |      |      |                              |   |
|----------------|--------------|--------|--------|--------|------|------|------|------|------------------------------|---|
| CLTS25F-C      | Polyethylene | Black  | 100    | 30.5   | 0.28 | 7.0  | 0.40 | 10.1 | -40°F – 122°F (-40°C – 50°C) | 1 |
| CLTS25F-C3     | Polyethylene | Orange | 100    | 30.5   | 0.28 | 7.0  | 0.40 | 10.1 | -40°F – 122°F (-40°C – 50°C) | 1 |
| CLTS25F-10M    | Polyethylene | Black  | 10,000 | 3048.0 | 0.28 | 7.0  | 0.40 | 10.1 | -40°F – 122°F (-40°C – 50°C) | 1 |
| CLTS35F-C      | Polyethylene | Black  | 100    | 30.5   | 0.35 | 8.9  | 0.50 | 12.7 | -40°F – 122°F (-40°C – 50°C) | 1 |
| CLTS35F-C3     | Polyethylene | Orange | 100    | 30.5   | 0.35 | 8.9  | 0.50 | 12.7 | -40°F – 122°F (-40°C – 50°C) | 1 |
| CLTS38F-C      | Polyethylene | Black  | 100    | 30.5   | 0.42 | 10.5 | 0.56 | 14.1 | -40°F – 122°F (-40°C – 50°C) | 1 |
| CLTS38F-C3     | Polyethylene | Orange | 100    | 30.5   | 0.42 | 10.5 | 0.56 | 14.1 | -40°F – 122°F (-40°C – 50°C) | 1 |
| CLTS50F-C      | Polyethylene | Black  | 100    | 30.5   | 0.51 | 12.8 | 0.67 | 17.0 | -40°F – 122°F (-40°C – 50°C) | 1 |
| CLTS50F-C3     | Polyethylene | Orange | 100    | 30.5   | 0.51 | 12.8 | 0.67 | 17.0 | -40°F – 122°F (-40°C – 50°C) | 1 |
| CLTS62F-C      | Polyethylene | Black  | 100    | 30.5   | 0.65 | 16.5 | 0.82 | 20.7 | -40°F – 122°F (-40°C – 50°C) | 1 |
| CLTS62F-C3     | Polyethylene | Orange | 100    | 30.5   | 0.65 | 16.5 | 0.82 | 20.7 | -40°F – 122°F (-40°C – 50°C) | 1 |
| CLTS75F-C      | Polyethylene | Black  | 100    | 30.5   | 0.76 | 19.3 | 0.94 | 23.8 | -40°F – 122°F (-40°C – 50°C) | 1 |
| CLTS75F-C3     | Polyethylene | Orange | 100    | 30.5   | 0.76 | 19.3 | 0.94 | 23.8 | -40°F – 122°F (-40°C – 50°C) | 1 |
| CLTS75F-2M     | Polyethylene | Black  | 2,000  | 609.6  | 0.76 | 19.3 | 0.94 | 23.8 | -40°F – 122°F (-40°C – 50°C) | 1 |
| CLTS100F-C     | Polyethylene | Black  | 100    | 30.5   | 0.92 | 23.2 | 1.09 | 27.7 | -40°F – 122°F (-40°C – 50°C) | 1 |
| CLTS100F-C3    | Polyethylene | Orange | 100    | 30.5   | 0.92 | 23.2 | 1.09 | 27.7 | -40°F – 122°F (-40°C – 50°C) | 1 |
| CLTS100F-1.25M | Polyethylene | Black  | 1,250  | 381.0  | 0.92 | 23.2 | 1.09 | 27.7 | -40°F – 122°F (-40°C – 50°C) | 1 |
| CLTS150F-D     | Polyethylene | Black  | 500    | 152.4  | 1.48 | 37.6 | 1.73 | 43.9 | -40°F – 122°F (-40°C – 50°C) | 1 |
| CLTS150F-D3    | Polyethylene | Orange | 500    | 152.4  | 1.48 | 39.1 | 1.73 | 43.9 | -40°F – 122°F (-40°C – 50°C) | 1 |

\*Reel packaging may contain splices. Contact Panduit Customer Service for further information.

E4.  
Permanent  
Identification

E5.  
Lockout/  
Tagout  
& Safety  
Solutions

F.  
Index

## Corrugated Loom Tubing – Slit (continued)

| Part Number        | Material                | Color | Length Per Reel |        | Inside Diameter |      | Outside Diameter |      | Temperature Range             | Std. Pkg. Qty.* |
|--------------------|-------------------------|-------|-----------------|--------|-----------------|------|------------------|------|-------------------------------|-----------------|
|                    |                         |       | Ft.             | m      | In.             | mm   | In.              | mm   |                               |                 |
| <b>Nylon Slit</b>  |                         |       |                 |        |                 |      |                  |      |                               |                 |
| CLT25N-C630        | Heat Stabilized Nylon 6 | Black | 100             | 30.5   | 0.28            | 7.0  | 0.40             | 10.1 | -40°F – 230°F (-40°C – 110°C) | 1               |
| CLT25N-10M630      | Heat Stabilized Nylon 6 | Black | 10,000          | 3048.0 | 0.28            | 7.0  | 0.40             | 10.1 | -40°F – 230°F (-40°C – 110°C) | 1               |
| CLT35N-C630        | Heat Stabilized Nylon 6 | Black | 100             | 30.5   | 0.35            | 8.9  | 0.50             | 12.7 | -40°F – 230°F (-40°C – 110°C) | 1               |
| CLT38N-C630        | Heat Stabilized Nylon 6 | Black | 100             | 30.5   | 0.42            | 10.5 | 0.56             | 14.1 | -40°F – 230°F (-40°C – 110°C) | 1               |
| CLT38N-5M630       | Heat Stabilized Nylon 6 | Black | 5,000           | 1524.0 | 0.42            | 10.5 | 0.56             | 14.1 | -40°F – 230°F (-40°C – 110°C) | 1               |
| CLT50N-C630        | Heat Stabilized Nylon 6 | Black | 100             | 30.5   | 0.51            | 12.8 | 0.67             | 17.0 | -40°F – 230°F (-40°C – 110°C) | 1               |
| CLT50N-4M630       | Heat Stabilized Nylon 6 | Black | 4,000           | 1219.2 | 0.51            | 12.8 | 0.67             | 17.0 | -40°F – 230°F (-40°C – 110°C) | 1               |
| CLT62N-C630        | Heat Stabilized Nylon 6 | Black | 100             | 30.5   | 0.65            | 16.5 | 0.82             | 20.7 | -40°F – 230°F (-40°C – 110°C) | 1               |
| CLT62N-2.5M630     | Heat Stabilized Nylon 6 | Black | 2,500           | 762.0  | 0.65            | 16.5 | 0.82             | 20.7 | -40°F – 230°F (-40°C – 110°C) | 1               |
| CLT75N-C630        | Heat Stabilized Nylon 6 | Black | 100             | 30.5   | 0.76            | 19.3 | 0.94             | 23.8 | -40°F – 230°F (-40°C – 110°C) | 1               |
| CLT75N-2M630       | Heat Stabilized Nylon 6 | Black | 2,000           | 609.6  | 0.76            | 19.3 | 0.94             | 23.8 | -40°F – 230°F (-40°C – 110°C) | 1               |
| CLT100N-C630       | Heat Stabilized Nylon 6 | Black | 100             | 30.5   | 0.92            | 23.2 | 1.09             | 27.7 | -40°F – 230°F (-40°C – 110°C) | 1               |
| CLT100N-125M630    | Heat Stabilized Nylon 6 | Black | 1,250           | 381.0  | 0.92            | 23.2 | 1.09             | 27.7 | -40°F – 230°F (-40°C – 110°C) | 1               |
| CLT125N-L630       | Heat Stabilized Nylon 6 | Black | 50              | 15.2   | 1.29            | 32.8 | 1.50             | 38.1 | -40°F – 230°F (-40°C – 110°C) | 1               |
| CLT125N-.75M630    | Heat Stabilized Nylon 6 | Black | 750             | 228.6  | 1.29            | 32.8 | 1.50             | 38.1 | -40°F – 230°F (-40°C – 110°C) | 1               |
| CLT150N-D630       | Heat Stabilized Nylon 6 | Black | 500             | 152.4  | 1.48            | 37.6 | 1.73             | 43.9 | -40°F – 230°F (-40°C – 110°C) | 1               |
| CLT188N-6C630      | Heat Stabilized Nylon 6 | Black | 600             | 182.9  | 1.88            | 47.8 | 2.17             | 55.1 | -40°F – 230°F (-40°C – 110°C) | 1               |
| <b>Nylon Solid</b> |                         |       |                 |        |                 |      |                  |      |                               |                 |
| CLTS25N-C          | Heat Stabilized Nylon 6 | Black | 100             | 30.5   | 0.28            | 7.0  | 0.40             | 10.1 | -40°F – 230°F (-40°C – 110°C) | 1               |
| CLTS25N-10M        | Heat Stabilized Nylon 6 | Black | 10,000          | 3048.0 | 0.28            | 7.0  | 0.40             | 10.1 | -40°F – 230°F (-40°C – 110°C) | 1               |
| CLTS35N-C          | Heat Stabilized Nylon 6 | Black | 100             | 30.5   | 0.35            | 8.9  | 0.50             | 12.7 | -40°F – 230°F (-40°C – 110°C) | 1               |
| CLTS38N-C          | Heat Stabilized Nylon 6 | Black | 100             | 30.5   | 0.42            | 10.5 | 0.56             | 14.1 | -40°F – 230°F (-40°C – 110°C) | 1               |
| CLTS50N-C          | Heat Stabilized Nylon 6 | Black | 100             | 30.5   | 0.51            | 12.8 | 0.67             | 17.0 | -40°F – 230°F (-40°C – 110°C) | 1               |
| CLTS62N-C          | Heat Stabilized Nylon 6 | Black | 100             | 30.5   | 0.65            | 16.5 | 0.82             | 20.7 | -40°F – 230°F (-40°C – 110°C) | 1               |
| CLTS75N-C          | Heat Stabilized Nylon 6 | Black | 100             | 30.5   | 0.76            | 19.3 | 0.94             | 23.8 | -40°F – 230°F (-40°C – 110°C) | 1               |
| CLTS75N-2M         | Heat Stabilized Nylon 6 | Black | 2,000           | 609.6  | 0.76            | 19.3 | 0.94             | 23.8 | -40°F – 230°F (-40°C – 110°C) | 1               |
| CLTS100N-C         | Heat Stabilized Nylon 6 | Black | 100             | 30.5   | 0.92            | 23.2 | 1.09             | 27.7 | -40°F – 230°F (-40°C – 110°C) | 1               |
| CLTS125N-L         | Heat Stabilized Nylon 6 | Black | 50              | 15.2   | 1.29            | 32.8 | 1.50             | 38.1 | -40°F – 230°F (-40°C – 110°C) | 1               |

\*Reel packaging may contain splices. Contact Panduit Customer Service for further information.

A.  
System  
Overview

B1.  
Cable  
Ties

B2.  
Cable  
Accessories

B3.  
Stainless  
Steel Ties

C1.  
Wiring  
Duct

C2.  
Surface  
Raceway

C3.  
Abrasion  
Protection

C4.  
Cable  
Management

D1.  
Terminals

D2.  
Power  
Connectors

D3.  
Grounding  
Connectors

E1.  
Labeling  
Systems

E2.  
Labels

E3.  
Pre-Printed  
& Write-On  
Markers

E4.  
Permanent  
Identification

E5.  
Lockout/  
Tagout  
& Safety  
Solutions

F.  
Index

A.  
System  
Overview

## Corrugated Loom Tubing Fittings

B1.  
Cable Ties

- Provide a secure way to join CLT at junctions and breakouts while improving the appearance of wire harnesses
- Color: Black
- Material: Polypropylene

B2.  
Cable  
Accessories



B3.  
Stainless  
Steel Ties

| Part Number | Branch Diameter |      | Trunk Diameter |     | Std. Pkg. Qty. | Std. Ctn. Qty. |
|-------------|-----------------|------|----------------|-----|----------------|----------------|
|             | In.             | mm   | In.            | mm  |                |                |
| CF382538F-Q | 0.38            | 9.5  | 0.25           | 6.4 | 25             | 100            |
| CF502550F-Q | 0.50            | 12.7 | 0.25           | 6.4 | 25             | 100            |
| CF503850F-Q | 0.50            | 12.7 | 0.38           | 9.5 | 25             | 100            |
| CF752575F-Q | 0.75            | 19.1 | 0.25           | 6.4 | 25             | 100            |
| CF753875F-Q | 0.75            | 19.1 | 0.38           | 9.5 | 25             | 100            |

C1.  
Wiring  
Duct

C2.  
Surface  
Raceway

C3.  
Abrasion  
Protection

C4.  
Cable  
Management

## Part Number System for Braided Expandable Sleeving

D1.  
Terminals

|                                       | <u>SE</u>                | <u>25</u>   | <u>PFR</u>  | - | <u>M</u>   | <u>R</u> | <u>0</u>                            |
|---------------------------------------|--------------------------|---|---|---|--|----------|-------------------------------------|
|                                       | Type                     | Nominal I.D. Size   | Material  |   | Package Size   | R = Reel | Color Suffix                        |
| D2. Power Connectors                  | SE = Sleeving Expandable | 12 = 1/8" (3.2mm)<br>25 = 1/4" (6.4mm)<br>38 = 3/8" (9.5mm)   | P = Polyethylene Terephthalate (PET)<br>PFR = Polyethylene Terephthalate (PET) Flame Retardant<br>PSC = Fray Resistant Polyethylene Terephthalate (PET) |   | L = 50' (15.2m)<br>C = 100' (30.5m)<br>T = 200' (61.0m)<br>D = 500' (152.4m)<br>M = 1000' (304.8m) |          | 0 = Black<br>8 = Gray<br>10 = White |
| D3. Grounding Connectors              |                          | 50 = 1/2" (12.7mm)<br>75 = 3/4" (19.1mm)<br>125 = 1 1/4" (31.8mm)<br>150 = 1 1/2" (38.1mm)<br>175 = 1 3/4" (44.5mm) |   |   |  |          |                                     |
| E1. Labeling Systems                  |                          |   |   |   |  |          |                                     |
| E2. Labels                            |                          |   |   |   |  |          |                                     |
| E3. Pre-Printed & Write-On Markers    |                          |   |   |   |  |          |                                     |
| E4. Permanent Identification          |                          |   |   |   |  |          |                                     |
| E5. Lockout/Tagout & Safety Solutions |                          |   |   |   |  |          |                                     |
| F. Index                              |                          |   |   |   |  |          |                                     |

## **UL® SP® Braided Expandable Sleeving – Polyethylene Terephthalate (PET)**

- Provides continuous abrasion protection for wires, cables, hoses and tubing
- Highly flexible open weave will not trap heat or humidity
- Allows for use with irregular shapes
- Lightweight, durable protection
- Rated for use up to 257°F (125°C)
- Compliant with U.S. and European passenger rail standards



| Part Number | Color | Nominal I.D. |      | Nominal Diameter Range |             | Length per reel |       | Std. Pkg. Qty. | Std. Ctn. Qty. |
|-------------|-------|--------------|------|------------------------|-------------|-----------------|-------|----------------|----------------|
|             |       | In.          | mm   | In.                    | mm          | Ft.             | m     |                |                |
| SE12P-TR0   | Black | 0.12         | 3.2  | 0.094 – 0.250          | 2.4 – 6.4   | 200             | 61.0  | 1              | 4              |
| SE12P-TR8   | Gray  | 0.12         | 3.2  | 0.094 – 0.250          | 2.4 – 6.4   | 200             | 61.0  | 1              | 4              |
| SE12P-MR0   | Black | 0.12         | 3.2  | 0.094 – 0.250          | 2.4 – 6.4   | 1000            | 304.8 | 1              | 2              |
| SE12P-MR8   | Gray  | 0.12         | 3.2  | 0.094 – 0.250          | 2.4 – 6.4   | 1000            | 304.8 | 1              | 2              |
| SE12P-MR10  | White | 0.12         | 3.2  | 0.094 – 0.250          | 2.4 – 6.4   | 1000            | 304.8 | 1              | 2              |
| SE25P-TR0   | Black | 0.25         | 6.4  | 0.125 – 0.375          | 3.2 – 9.5   | 200             | 61.0  | 1              | 4              |
| SE25P-TR8   | Gray  | 0.25         | 6.4  | 0.125 – 0.375          | 3.2 – 9.5   | 200             | 61.0  | 1              | 4              |
| SE25P-MR0   | Black | 0.25         | 6.4  | 0.125 – 0.375          | 3.2 – 9.5   | 1000            | 304.8 | 1              | 2              |
| SE25P-MR8   | Gray  | 0.25         | 6.4  | 0.125 – 0.375          | 3.2 – 9.5   | 1000            | 304.8 | 1              | 2              |
| SE25P-MR10  | White | 0.25         | 6.4  | 0.125 – 0.375          | 3.2 – 9.5   | 1000            | 304.8 | 1              | 2              |
| SE38P-TR0   | Black | 0.38         | 9.5  | 0.188 – 0.500          | 4.8 – 15.9  | 200             | 61.0  | 1              | 4              |
| SE38P-TR8   | Gray  | 0.38         | 9.5  | 0.188 – 0.500          | 4.8 – 15.9  | 200             | 61.0  | 1              | 4              |
| SE38P-MR0   | Black | 0.38         | 9.5  | 0.188 – 0.500          | 4.8 – 15.9  | 1000            | 304.8 | 1              | 2              |
| SE38P-MR8   | Gray  | 0.38         | 9.5  | 0.188 – 0.500          | 4.8 – 15.9  | 1000            | 304.8 | 1              | 2              |
| SE38P-MR10  | White | 0.38         | 9.5  | 0.188 – 0.500          | 4.8 – 15.9  | 1000            | 304.8 | 1              | 2              |
| SE50P-CR0   | Black | 0.50         | 12.7 | 0.250 – 0.750          | 6.4 – 19.1  | 100             | 30.5  | 1              | 4              |
| SE50P-CR8   | Gray  | 0.50         | 12.7 | 0.250 – 0.750          | 6.4 – 19.1  | 100             | 30.5  | 1              | 4              |
| SE50P-DR0   | Black | 0.50         | 12.7 | 0.250 – 0.750          | 6.4 – 19.1  | 500             | 152.4 | 1              | 2              |
| SE50P-DR8   | Gray  | 0.50         | 12.7 | 0.250 – 0.750          | 6.4 – 19.1  | 500             | 152.4 | 1              | 2              |
| SE50P-DR10  | White | 0.50         | 12.7 | 0.250 – 0.750          | 6.4 – 19.1  | 500             | 152.4 | 1              | 2              |
| SE75P-CR0   | Black | 0.75         | 19.1 | 0.500 – 1.25           | 12.7 – 31.8 | 100             | 30.5  | 1              | 4              |
| SE75P-CR8   | Gray  | 0.75         | 19.1 | 0.500 – 1.25           | 12.7 – 31.8 | 100             | 30.5  | 1              | 4              |
| SE75P-DR0   | Black | 0.75         | 19.1 | 0.500 – 1.25           | 12.7 – 31.8 | 500             | 152.4 | 1              | 2              |
| SE75P-DR8   | Gray  | 0.75         | 19.1 | 0.500 – 1.25           | 12.7 – 31.8 | 500             | 152.4 | 1              | 2              |
| SE75P-DR10  | White | 0.75         | 19.1 | 0.500 – 1.25           | 12.7 – 31.8 | 500             | 152.4 | 1              | 2              |
| SE125P-LR0  | Black | 1.25         | 31.8 | 0.750 – 1.50           | 19.1 – 38.1 | 50              | 15.2  | 1              | 4              |
| SE125P-LR8  | Gray  | 1.25         | 31.8 | 0.750 – 1.50           | 19.1 – 38.1 | 50              | 15.2  | 1              | 4              |
| SE125P-TR0  | Black | 1.25         | 31.8 | 0.750 – 1.50           | 19.1 – 38.1 | 200             | 61.0  | 1              | 2              |
| SE125P-TR8  | Gray  | 1.25         | 31.8 | 0.750 – 1.50           | 19.1 – 38.1 | 200             | 61.0  | 1              | 2              |
| SE125P-TR10 | White | 1.25         | 31.8 | 0.750 – 1.50           | 19.1 – 38.1 | 200             | 61.0  | 1              | 2              |
| SE150P-LR0  | Black | 1.50         | 38.1 | 1.00 – 2.13            | 25.4 – 54.0 | 50              | 15.2  | 1              | 4              |
| SE150P-LR8  | Gray  | 1.50         | 38.1 | 1.00 – 2.13            | 25.4 – 54.0 | 50              | 15.2  | 1              | 4              |
| SE150P-TR0  | Black | 1.50         | 38.1 | 1.00 – 2.13            | 25.4 – 54.0 | 200             | 61.0  | 1              | 2              |
| SE150P-TR8  | Gray  | 1.50         | 38.1 | 1.00 – 2.13            | 25.4 – 54.0 | 200             | 61.0  | 1              | 2              |
| SE150P-TR10 | White | 1.50         | 38.1 | 1.00 – 2.13            | 25.4 – 54.0 | 200             | 61.0  | 1              | 2              |
| SE175P-TR0  | Black | 1.75         | 44.5 | 1.25 – 2.75            | 31.8 – 69.9 | 200             | 61.0  | 1              | 2              |

Reel packaging may contain splices. Contact Panduit Customer Service for further information.

A.  
System  
Overview

B1.  
Cable Ties

B2.  
Cable  
Accessories

B3.  
Stainless  
Steel Ties

C1.  
Wiring  
Duct

C2.  
Surface  
Raceway

C3.  
Abrasion  
Protection

C4.  
Cable  
Management

D1.  
Terminals

D2.  
Power  
Connectors

D3.  
Grounding  
Connectors

E1.  
Labeling  
Systems

E2.  
Labels

E3.  
Pre-Printed  
& Write-On  
Markers

E4.  
Permanent  
Identification

E5.  
Lockout/  
Tagout/  
& Safety  
Solutions

F.  
Index

A. System Overview



## Braided Expandable Sleeving – Flame Retardant Polyethylene Terephthalate

B1. Cable Ties

- Provides continuous abrasion protection for wires, cables, hoses and tubing
- Highly flexible open weave will not trap heat or humidity
- Rated for use up to 257°F (125°C)
- Allows for use with irregular shapes
- Flammability: Meets UL 1441 VW-1
- Compliant with U.S. and European passenger rail standards

B2. Cable Accessories



B3. Stainless Steel Ties

C1. Wiring Duct

C2. Surface Raceway

C3. Abrasion Protection

C4. Cable Management

D1. Terminals

D2. Power Connectors

D3. Grounding Connectors

E1. Labeling Systems

E2. Labels

E3. Pre-Printed & Write-On Markers

E4. Permanent Identification

E5. Lockout/Tagout & Safety Solutions

F. Index

| Part Number   | Color | Nominal I.D. |      | Nominal Diameter Range |             | Length per reel |       | Std. Pkg. Qty. | Std. Ctn. Qty. |
|---------------|-------|--------------|------|------------------------|-------------|-----------------|-------|----------------|----------------|
|               |       | In.          | mm   | In.                    | mm          | Ft.             | m     |                |                |
| SE12PFR-TR0   | Black | 0.12         | 3.2  | 0.094 – 0.250          | 2.4 – 6.4   | 200             | 61.0  | 1              | 4              |
| SE12PFR-MR0   | Black | 0.12         | 3.2  | 0.094 – 0.250          | 2.4 – 6.4   | 1000            | 304.8 | 1              | 2              |
| SE12PFR-TR8   | Gray  | 0.12         | 3.2  | 0.094 – 0.250          | 2.4 – 6.4   | 200             | 61.0  | 1              | 4              |
| SE12PFR-MR8   | Gray  | 0.12         | 3.2  | 0.094 – 0.250          | 2.4 – 6.4   | 1000            | 304.8 | 1              | 2              |
| SE12PFR-MR10  | White | 0.12         | 3.2  | 0.094 – 0.250          | 2.4 – 6.4   | 1000            | 304.8 | 1              | 2              |
| SE25PFR-TR0   | Black | 0.25         | 6.4  | 0.125 – 0.375          | 3.2 – 9.5   | 200             | 61.0  | 1              | 4              |
| SE25PFR-MR0   | Black | 0.25         | 6.4  | 0.125 – 0.375          | 3.2 – 9.5   | 1000            | 304.8 | 1              | 2              |
| SE25PFR-TR8   | Gray  | 0.25         | 6.4  | 0.125 – 0.375          | 3.2 – 9.5   | 200             | 61.0  | 1              | 4              |
| SE25PFR-MR8   | Gray  | 0.25         | 6.4  | 0.125 – 0.375          | 3.2 – 9.5   | 1000            | 304.8 | 1              | 2              |
| SE25PFR-MR10  | White | 0.25         | 6.4  | 0.125 – 0.375          | 3.2 – 9.5   | 1000            | 304.8 | 1              | 2              |
| SE38PFR-MR0   | Black | 0.38         | 9.5  | 0.188 – 0.625          | 4.8 – 15.9  | 1000            | 304.8 | 1              | 2              |
| SE38PFR-TR0   | Black | 0.38         | 9.5  | 0.188 – 0.625          | 4.8 – 15.9  | 200             | 61.0  | 1              | 4              |
| SE38PFR-TR8   | Gray  | 0.38         | 9.5  | 0.188 – 0.625          | 4.8 – 15.9  | 200             | 61.0  | 1              | 4              |
| SE38PFR-MR8   | Gray  | 0.38         | 9.5  | 0.188 – 0.500          | 4.8 – 12.7  | 1000            | 304.8 | 1              | 2              |
| SE38PFR-MR10  | White | 0.38         | 9.5  | 0.188 – 0.500          | 4.8 – 12.7  | 1000            | 304.8 | 1              | 2              |
| SE50PFR-CR0   | Black | 0.50         | 12.7 | 0.250 – 0.750          | 6.4 – 19.1  | 100             | 30.5  | 1              | 4              |
| SE50PFR-CR8   | Gray  | 0.50         | 12.7 | 0.250 – 0.750          | 6.4 – 19.1  | 100             | 30.5  | 1              | 4              |
| SE50PFR-DR0   | Black | 0.50         | 12.7 | 0.250 – 0.750          | 6.4 – 19.1  | 500             | 152.4 | 1              | 2              |
| SE50PFR-DR8   | Gray  | 0.50         | 12.7 | 0.250 – 0.750          | 6.4 – 19.1  | 500             | 152.4 | 1              | 2              |
| SE50PFR-DR10  | White | 0.50         | 12.7 | 0.250 – 0.750          | 6.4 – 19.1  | 500             | 152.4 | 1              | 2              |
| SE75PFR-CR0   | Black | 0.75         | 19.1 | 0.500 – 1.25           | 12.7 – 31.8 | 100             | 30.5  | 1              | 4              |
| SE75PFR-CR8   | Gray  | 0.75         | 19.1 | 0.500 – 1.25           | 12.7 – 31.8 | 100             | 30.5  | 1              | 4              |
| SE75PFR-DR0   | Black | 0.75         | 19.1 | 0.500 – 1.25           | 12.7 – 31.8 | 500             | 152.4 | 1              | 2              |
| SE75PFR-DR8   | Gray  | 0.75         | 19.1 | 0.500 – 1.25           | 12.7 – 31.8 | 500             | 152.4 | 1              | 2              |
| SE75PFR-DR10  | White | 0.75         | 19.1 | 0.500 – 1.25           | 12.7 – 31.8 | 500             | 152.4 | 1              | 2              |
| SE125PFR-LR0  | Black | 1.25         | 31.8 | 0.750 – 1.50           | 19.1 – 38.1 | 50              | 15.2  | 1              | 4              |
| SE125PFR-LR8  | Gray  | 1.25         | 31.8 | 0.750 – 1.50           | 19.1 – 38.1 | 50              | 15.2  | 1              | 4              |
| SE125PFR-TR0  | Black | 1.25         | 31.8 | 0.750 – 1.50           | 19.1 – 38.1 | 200             | 61.0  | 1              | 2              |
| SE125PFR-TR8  | Gray  | 1.25         | 31.8 | 0.750 – 1.50           | 19.1 – 38.1 | 200             | 61.0  | 1              | 2              |
| SE125PFR-TR10 | White | 1.25         | 31.8 | 0.750 – 1.50           | 19.1 – 38.1 | 200             | 61.0  | 1              | 2              |
| SE150PFR-LR0  | Black | 1.50         | 38.1 | 1.00 – 2.13            | 25.4 – 54.0 | 50              | 15.2  | 1              | 4              |
| SE150PFR-LR8  | Gray  | 1.50         | 38.1 | 1.00 – 2.13            | 25.4 – 54.0 | 50              | 15.2  | 1              | 4              |
| SE150PFR-TR0  | Black | 1.50         | 38.1 | 1.00 – 2.13            | 25.4 – 54.0 | 200             | 61.0  | 1              | 2              |
| SE150PFR-TR8  | Gray  | 1.50         | 38.1 | 1.00 – 2.13            | 25.4 – 54.0 | 200             | 61.0  | 1              | 2              |
| SE150PFR-TR10 | White | 1.50         | 38.1 | 1.00 – 2.13            | 25.4 – 54.0 | 200             | 61.0  | 1              | 2              |
| SE175PFR-TR0  | Black | 1.75         | 44.5 | 1.25 – 2.75            | 31.8 – 69.9 | 200             | 61.0  | 1              | 2              |

### Tooling Head

- Sleeving cutter/end sealer blade – used with popular soldering guns to cut and seal sleeving



| Part Number | Description   | Std. Pkg. Qty. |
|-------------|---|----------------|
| HKBS        | For dual straight shank soldering guns with .500" spacing typical guns: WELLER Straight Shank Model 8200; WEN Model 199 or 100 (Replace tip holding screws with (2) screws included). | 1              |



## Fray Resistant Braided Expandable Sleeving

- Fray-resistant design resists fraying when cut with scissors
- Provides continuous abrasion protection resistance for wires, cables, and tubing
- For indoor use only
- Rated for use up to 257°F (125°C)
- Material: Polyethylene Terephthalate

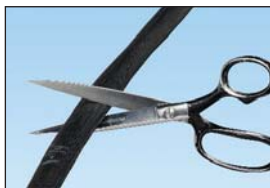

| Part Number  | Color | Nominal I.D. |      | Nominal Diameter Range |             | Length Per Reel‡ |      | Std. Pkg. Qty. | Std. Ctn. Qty. |
|--------------|-------|--------------|------|------------------------|-------------|------------------|------|----------------|----------------|
|              |       | In.          | mm   | In.                    | mm          | Ft.              | m    |                |                |
| SE12PSC-TR0  | Black | 0.12         | 3.2  | 0.13 – 0.25            | 3.2 – 6.4   | 200              | 61.0 | 1              | 4              |
| SE25PSC-TR0  | Black | 0.25         | 6.4  | 0.16 – 0.44            | 4.0 – 11.1  | 200              | 61.0 | 1              | 4              |
| SE38PSC-TR0  | Black | 0.38         | 9.5  | 0.19 – 0.63            | 4.8 – 15.9  | 200              | 61.0 | 1              | 4              |
| SE50PSC-CR0  | Black | 0.50         | 12.7 | 0.25 – 0.75            | 6.4 – 19.1  | 100              | 30.5 | 1              | 4              |
| SE75PSC-CR0  | Black | 0.75         | 19.1 | 0.63 – 1.0             | 15.9 – 25.4 | 100              | 30.5 | 1              | 4              |
| SE125PSC-LR0 | Black | 1.25         | 31.8 | 1.0 – 1.5              | 25.4 – 38.1 | 50               | 15.2 | 1              | 4              |
| SE150PSC-LR0 | Black | 1.50         | 38.1 | 1.3 – 2.0              | 31.8 – 50.8 | 50               | 15.2 | 1              | 4              |

‡Reel packaging may contain splices. Contact Panduit Customer Service for further information.

A.  
System  
Overview

B1.  
Cable Ties

B2.  
Cable  
Accessories

B3.  
Stainless  
Steel Ties

C1.  
Wiring  
Duct

C2.  
Surface  
Raceway

C3.  
Abrasion  
Protection

C4.  
Cable  
Management

D1.  
Terminals

D2.  
Power  
Connectors

D3.  
Grounding  
Connectors

E1.  
Labeling  
Systems

E2.  
Labels

E3.  
Pre-Printed  
& Write-On  
Markers

E4.  
Permanent  
Identification

E5.  
Lockout/  
Tagout/  
& Safety  
Solutions

F.  
Index

A. System Overview

## Part Number System for Non-Shrink PVC Tubing

B1. Cable Ties

**TV105**      -      **12**      **M**

B2. Cable Accessories

**Type**

TV105 = PVC Tubing

**Nominal Size**

12 = 12 AWG  
6 = 6 AWG  
3 = 3 AWG  
1 = 1 AWG  
0.38 = 3/8"  
0.50 = 1/2"  
0.75 = 3/4"  
1.0 = 1"

**Package Quantity**

C = 100' (30.5m)  
TL = 250' (76.2m)  
D = 500' (152.4m)  
M = 1000' (304.8m)

**Color Suffix**

Leave Blank = Clear  
20 = Black

B3. Stainless Steel Ties

C1. Wiring Duct

## Non-Shrink PVC Tubing

- Provides insulation and protection for lead wires, wire harness assemblies, soldered joints and components in electrical and electronic equipment

- All purpose flexible and non-shrinkable
- Resistant to heat and moisture

- Flammability: Meets UL 224 VW-1

- Voltage rating: 300 V and 600 V

- ASTM D-922 Grade CFR

- MIL-I-631 Type F, Form U, Grade C- Class 1 Category 1

- Material: Polyvinyl chloride (PVC)

- UL oil resistant class 1 rating

C2. Surface Raceway

C3. Abrasion Protection



C4. Cable Management

D1. Terminals

| Part Number    | Color | Nominal Size | Length Per Reel |       | Max. Inside Diameter |       | Wall Thickness |      | Max. Voltage Rating | Std. Pkg. Qty. | Std. Ctn. Qty. |
|----------------|-------|--------------|-----------------|-------|----------------------|-------|----------------|------|---------------------|----------------|----------------|
|                |       |              | Ft.             | m     | In                   | mm    | In             | mm   |                     |                |                |
| TV105-12MY     | Clear | 12 AWG       | 1000            | 304.8 | 0.089                | 2.26  | 0.016          | 0.41 | 300 V               | 1              | 2              |
| TV105-12M20Y   | Black | 12 AWG       | 1000            | 304.8 | 0.089                | 2.26  | 0.016          | 0.41 | 300 V               | 1              | 2              |
| TV105-6MY      | Clear | 6 AWG        | 1000            | 304.8 | 0.178                | 4.52  | 0.020          | 0.51 | 300 V               | 1              | 2              |
| TV105-6M20Y    | Black | 6 AWG        | 1000            | 304.8 | 0.178                | 4.52  | 0.020          | 0.51 | 300 V               | 1              | 2              |
| TV105-3MY      | Clear | 3 AWG        | 1000            | 304.8 | 0.249                | 6.32  | 0.020          | 0.51 | 300 V               | 1              | 2              |
| TV105-3M20Y    | Black | 3 AWG        | 1000            | 304.8 | 0.249                | 6.32  | 0.020          | 0.51 | 300 V               | 1              | 2              |
| TV105-1MY      | Clear | 1 AWG        | 1000            | 304.8 | 0.311                | 7.89  | 0.020          | 0.51 | 300 V               | 1              | —              |
| TV105-1M20Y    | Black | 1 AWG        | 1000            | 304.8 | 0.311                | 7.89  | 0.020          | 0.51 | 300 V               | 1              | —              |
| TV105-.38DY    | Clear | 3/8          | 500             | 152.4 | 0.399                | 10.13 | 0.025          | 0.64 | 600 V               | 1              | —              |
| TV105-.38D20Y  | Black | 3/8          | 500             | 152.4 | 0.399                | 10.13 | 0.025          | 0.64 | 600 V               | 1              | —              |
| TV105-.50DY    | Clear | 1/2          | 500             | 152.4 | 0.524                | 13.30 | 0.025          | 0.64 | 600 V               | 1              | —              |
| TV105-.50D20Y  | Black | 1/2          | 500             | 152.4 | 0.524                | 13.30 | 0.025          | 0.64 | 600 V               | 1              | —              |
| TV105-.75TLY   | Clear | 3/4          | 250             | 76.2  | 0.786                | 19.96 | 0.035          | 0.89 | 600 V               | 1              | —              |
| TV105-.75TL20Y | Black | 3/4          | 250             | 76.2  | 0.786                | 19.96 | 0.035          | 0.89 | 600 V               | 1              | —              |
| TV105-1.0CY    | Clear | 1            | 100             | 30.5  | 1.036                | 26.31 | 0.035          | 0.89 | 600 V               | 1              | 2              |
| TV105-1.0C20Y  | Black | 1            | 100             | 30.5  | 1.036                | 26.31 | 0.035          | 0.89 | 600 V               | 1              | 2              |

D2. Power Connectors

D3. Grounding Connectors

E1. Labeling Systems

E2. Labels

E3. Pre-Printed & Write-On Markers

## Duct Seal – Sealing Compounds

- Seals irregular openings from air, dust, or water
- Non-hardening sealant that adheres to metal, masonry, wood or plastic
- Provides vibration dampening

- Safe and easy to use, non-corrosive, non-toxic, no asbestos, will not stain or harm hands, and no unpleasant odor.

- Dielectric strength: 200 V/Mil, Min .030" thick

E5. Lockout/Tagout & Safety Solutions



| Part Number | Description                                | Std. Pkg. Qty. |
|-------------|--|----------------|
| DS1         | Duct seal (sealing compound) 1 lb. package | 1              |
| DS5         | Duct seal (sealing compound) 5 lb. package | 1              |

F. Index

## Flammability Tests and Classification

### Abrasion Protection Products Flammability Tests and Classifications

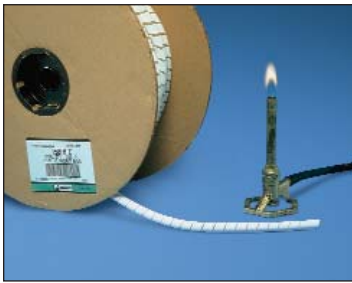

- A number of test procedures have been developed which can be used for the evaluation and comparison of various materials to support combustion
- Review the following classifications to find which category is designed to suit your abrasion and protection applications

### UL 94 Vertical Burning Test

Test samples of material, with dimension  $125 \pm 5\text{mm}$  by  $13.0 \pm 5\text{mm}$  and provided in the minimum and maximum thickness of the intended end use product, are tested in an unconditioned (as manufactured) state and in a conditioned state (7 days at  $168\text{F}^\circ$ ,  $75^\circ\text{C}$ ). The test requires the placement of a precisely controlled flame under a vertically supported specimen for a 10 second period. The flame is removed and the duration of flaming is recorded. If the flame extinguishes, the specimen is immediately subjected to a second 10 second ignition period. Duration of flaming is again recorded. A piece of 100% cotton is placed under the specimen. Also observed and documented is if the sample drips flaming particles that ignite the cotton indicator below.

#### Materials Classification

| Criteria Conditions  | V-0               | V-1                | V-2                |
|--|-------------------|--------------------|--------------------|
| Afterflame time for each individual specimen $t_1$ or $t_2$  | $\leq 10\text{s}$ | $\leq 30\text{s}$  | $\leq 30\text{s}$  |
| Total Afterflame time for any condition set ( $t_1$ plus $t_2$ for the 5 specimens)                            | $\leq 50\text{s}$ | $\leq 250\text{s}$ | $\leq 250\text{s}$ |
| Afterflame plus afterglow time for each individual specimen after the second flame application ( $t_2 + t_3$ ) | $\leq 30\text{s}$ | $\leq 60\text{s}$  | $\leq 60\text{s}$  |
| Afterflame or afterglow of any specimen up to the holding clamp  | No                | No                 | No                 |
| Cotton indicator ignited by flaming particles or drops   | No                | No                 | Yes                |

|       |  |
|-------|--|
| $t_1$ | Afterflame time after first flame application  |
| $t_2$ | Afterflame time after second flame application |
| $t_3$ | Afterglow time after second flame application  |

### MATERIALS CLASSIFIED UL 94 HB

- Specimens shall have a maximum burn rate of  $<1.5$  in./min over 3 inches of thickness of .120 inches to .5 inches
- Specimens shall have a maximum burn rate of  $<30$  in./min over 3 inches for a thickness less than .120 inches

### UL 224 VERTICAL WIRE FLAME TEST

Samples of fully recovered tubing are placed over a length of fine spring steel music wire. The test requires the precise placement of a controlled flame that contacts the heat shrink tubing. The flame is applied in five 15 second intervals with a time period between applications. If the flame extinguishes immediately after the first flame removal, subsequent flame applications are made to the tubing. Duration of specimen flaming is noted. A piece of surgical cotton is placed under the specimen. If a flaming or glowing piece of tubing drips and ignites the cotton, this is also noted.

### MATERIALS CLASSIFIED AS VW-1 SHALL:

- Not flame or glow longer than 60 seconds following any of the five applications of the flame
- Not ignite or damage more than 25% of kraft paper flag that is placed around the top of the tubing
- Not have any specimens which drip flaming particles and ignite the surgical cotton located 9 1/2 inches below the test specimen

A.  
System  
Overview

B1.  
Cable Ties

B2.  
Cable  
Accessories

B3.  
Stainless  
Steel Ties

C1.  
Wiring  
Duct

C2.  
Surface  
Raceway

C3.  
Abrasion  
Protection

C4.  
Cable  
Management

D1.  
Terminals

D2.  
Power  
Connectors

D3.  
Grounding  
Connectors

E1.  
Labeling  
Systems

E2.  
Labels

E3.  
Pre-Printed  
& Write-On  
Markers

E4.  
Permanent  
Identification

E5.  
Lockout/  
Tagout  
& Safety  
Solutions

F.  
Index

A. System Overview

B1. Cable Ties

B2. Cable Accessories

B3. Stainless Steel Ties

C1. Wiring Duct

C2. Surface Raceway

C3. Abrasion Protection

C4. Cable Management

D1. Terminals

D2. Power Connectors

D3. Grounding Connectors

E1. Labeling Systems

E2. Labels

E3. Pre-Printed & Write-On Markers

E4. Permanent Identification

E5. Lockout/Tagout & Safety Solutions

F. Index

## Abrasion Protection Materials Technical Data

|  | Ratings and Approvals          |                      |                     | Physical Properties                          |                         |                                    |                                 | Chemical Resistance   |           |                                     |                              |
|--|--------------------------------|----------------------|---------------------|--|-------------------------|------------------------------------|---------------------------------|---|-----------|-------------------------------------|------------------------------|
|  | UL Temperature Index           | Flammability (UL 94) | Melting Temperature | Abrasion Resistance (Lower number is better) | Specific Gravity (D792) | Minimum Tensile @23°C (psi) (D368) | Water Absorption (Max. 24 hrs.) | Organic Solvents  | Alkalies  | Acids                               | Petro-Chemicals              |
| <b>Natural Polyethylene</b><br>Lowest cost material for indoor use up to 122°F. Natural is available in all sizes.   | -40°F (-40°C) to 122°F (50°C)  | HB                   | 239°F (115°C)       | 22 mg  | 0.91 – 0.93             | 1400 (D368)                        | 0.01%                           | Resistant below 140°F (60°C) except to chlorinated solvents | Resistant | Resistant except to oxidizing acids | Some Discoloration           |
| <b>Weather Resistant Polyethylene</b><br>This material has the same properties as natural polyethylene, and also has additives which allow it to resist the effects of ultraviolet light and acid rain in an outdoor environment. This product is available in black only.                 | -40°F (-40°C) to 122°F (50°C)  | HB                   | 239°F (115°C)       | 20 mg  | 0.93 – 1.09             | 2000 (D368)                        | 0.03%                           | Resistant below 140°F (60°C) except to chlorinated solvents | Resistant | Resistant except to oxidizing acids | No Discoloration             |
| <b>Fire Resistant Polyethylene*</b><br>UL94-V-2 Rating<br>This material is self extinguishing and passes the UL 94 flame retardant test with V-2 rating.   | -40°F (-40°C) to 122°F (50°C)  | V-2                  | 239°F (115°C)       | 27 mg  | 1.00 – 1.30             | 1400 (D368)                        | 0.02%                           | Resistant below 140°F (60°C) except to chlorinated solvents | Resistant | Resistant except to oxidizing acids | Some Discoloration           |
| <b>Flame Retardant Polyethylene*</b><br>UL94-V-0 Rating. This material is self extinguishing and passes the UL94 flame retardant test with a V-0 rating.   | -4°F (-20°C) to 167°F (75°C)   | V-0                  | 270°F (132°C)       | 22 mg  | 1.23 – 1.37             | 1500 (D368)                        | 0.02%                           | Resistant except to halogenated hydrocarbons                | Resistant | Resistant                           | Resistant Some Discoloration |
| <b>Weather Resistant Polypropylene</b><br>This material is resistant to chemical attack and is suitable for harsh environment applications requiring UV/weather resistance and withstanding high temperatures.   | -40°F (-40°C) to 239°F (115°C) | HB                   | 334°F (168°C)       | —  | 0.902                   | 4000 (D638)                        | 0.1%                            | Resistant except to halogenated hydrocarbons                | Resistant | Resistant                           | Resistant No Discoloration   |
| <b>Nylon 6.6</b><br>Nylon is strong, durable material for indoor use up to 149°F. It offers a combination of lightweight, wide temperature range, and high abrasion resistance. This material is suitable for applications where heavy vibration or stress exists on the wiring or tubing. | -40°F (-40°C) to 149°F (65°C)  | HB                   | 505°F (263°C)       | 7 mg   | 1.13 – 1.15             | 12,400 (D368)                      | 1.2%                            | Resistant except to halogenated hydrocarbons                | Resistant | Not recommended                     | Resistant No Discoloration   |
| <b>Weather Resistant Nylon 6.6</b><br>This material has the same properties as natural Nylon and also has additives which allow it to resist the effects of ultraviolet light in an outdoor environment. This product is available in black only.  | -40°F (-40°C) to 149°F (65°C)  | HB                   | 505°F (263°C)       | 7 mg   | 1.13 – 1.15             | 12,400 (D368)                      | 1.2%                            | Resistant except to halogenated hydrocarbons                | Resistant | Not recommended                     | Resistant No Discoloration   |
| <b>TFE‡</b><br>This material is a non-flammable, fluorocarbon resin material. Suitable for use in any application (including nuclear containment). It is rated up to 356°F. Color: Opaque to Translucent.  | -40°F (-40°C) to 500°F (260°C) | V-0                  | 648°F (342°C)       | 7 mg   | 2.13 – 2.22             | 3000 (D876)                        | 0.01%                           | Resistant   | Resistant | Resistant                           | Resistant No Discoloration   |
| <b>Natural Polyethylene</b><br>Lowest cost material for indoor use up to 122°C. Natural is available in all sizes.   | -40°F (-40°C) to 122°F (50°C)  | HB                   | 239°F (115°C)       | 22 mg  | 0.91 – 0.93             | 1400 (D638)                        | 0.01%                           | Resistant below 140°F (60°C) except to chlorinated solvents | Resistant | Resistant except to oxidizing acids | Some Discoloration           |
| <b>Flame Retardant Polyethylene*</b><br>UL94-V-0 Rating. This material is self extinguishing and passes the UL94 flame retardant test with a V-0 rating.   | -4°F (-20°C) to 167°F (75°C)   | V-0                  | 270°F (132°C)       | 22 mg  | 1.15                    | 1500 (D876)                        | 0.02%                           | Resistant except to halogenated hydrocarbons                | Resistant | Resistant                           | Resistant Some Discoloration |

SPIRAL WRAP

PAN-WRAP™

Note: Typical operating temperature ranges are extended based on end use application and specific environment tests.

‡TFE is Polytetrafluoroethylene material.

\*Contains halogens. Other materials are halogen free.

## Abrasion Protection Materials Technical Data (continued)

|                       | Ratings and Approvals   |                      |                     | Physical Properties                          |                         |                              |                                 | Chemical Resistance   |                              |                                     |                              |
|-----------------------|---|----------------------|---------------------|--|-------------------------|------------------------------|---------------------------------|---|------------------------------|-------------------------------------|------------------------------|
|                       | UL Temperature Index  | Flammability (UL 94) | Melting Temperature | Abrasion Resistance (Lower number is better) | Specific Gravity (D792) | Minimum Tensile @ 23°C (psi) | Water Absorption (Max. 24 hrs.) | Organic Solvents  | Alkalies                     | Acids                               | Petro-Chemicals              |
| <b>SLEEVING</b>       | <b>Polyethylene Terephthalate (PET)</b><br>This material is a thermoplastic polyester material designed for indoor applications. It is rated for use up to 257°F and will tolerate short-term exposure up to 446°F. Colors: Black, White and Gray.  | HB                   | 500°F (260°C)       | —  | 1.39                    | 100,000 (D876)               | 0.08%                           | Resistant to some solvents                                    | Resistant to most weak bases | Resistant                           | Some Discoloration           |
|                       | <b>Flame Retardant Polyethylene* Terephthalate (PET)</b><br>This material is a self-extinguishing thermoplastic polyester that can be used indoors. It is also rated for use up to 257°F and will tolerate short term exposure up to 446°F. It is provided with tracers to identify the flame retardant material. | UL 1441 VW-1         | 469°F (243°C)       | —  | 1.39                    | 39,295 (D876)                | 0.08%                           | Resistant to some solvents                                    | Resistant to most weak bases | Resistant                           | Resistant Some Discoloration |
| <b>CLT</b>            | <b>Black Polypropylene</b><br>Lowest cost material is for use up to 122°F. Other colors may be available.   | HB                   | —                   | —  | 0.926 – 0.940           | 1500 (D638)                  | —                               | Resistant except to halogenated hydrocarbons                  | Resistant                    | Resistant                           | Resistant No Discoloration   |
|                       | <b>Nylon 6</b><br>Nylon is a strong, impact modified, heat stabilized, durable high abrasion resistant material.  | HB                   | 410°F (211°C)       | —  | 1.06 – 1.16             | 8000 (D638)                  | —                               | Resistant except to halogenated hydrocarbons                  | Resistant                    | Not recommended                     | Resistant No Discoloration   |
| <b>PVC</b>            | <b>PVC Non-Shrink Tubing*</b><br>This material provides insulation and protection for continuous use at temperature -4°F (-20°C) to 221°F (105°C).  | UL 224 VW-1          | —                   | —  | 1.35                    | 2500 (D876)                  | —                               | Resistant except to aromatic hydrocarbons, ketones and esters | Resistant                    | Resistant                           | Resistant No Discoloration   |
| <b>CLT FITTINGS</b>   | <b>Black Polyethylene</b><br>Lowest cost material is for use up to 122°F. Other colors may be available.  | UL94 HB              | —                   | —  | 1.04                    | 3,900 (D638)                 | 0.02 – 0.03%                    | Resistant except to halogenated hydrocarbons                  | Resistant                    | Resistant except to oxidizing acids | Resistant Some Discoloration |
|                       | <b>Natural Polyethylene</b><br>Lowest cost material for indoor use up to 122° F. Natural is available in all sizes.   | HB                   | 239°F (115°C)       | 22 mg  | 0.91 – 1.09             | 1400 (D638)                  | —                               | Resistant below 140°F (60°C) except to chlorinated solvents   | Resistant                    | Resistant except to oxidizing acids | Some Discoloration           |
| <b>GROMMET EDGING</b> | <b>Weather Resistant Polyethylene</b><br>This material has the same properties as natural polyethylene, and also has additives which allow it to resist the effects of ultraviolet light and acid rain in an outdoor environment. This product is available in black only.  | HB                   | 239°F (115°C)       | 20 mg  | 0.93 – 1.09             | 2000 (D638)                  | 0.03%                           | Resistant below 140°F (60°C) except to chlorinated solvents   | Resistant                    | Resistant except to oxidizing acids | No Discoloration             |
|                       | <b>Flame Retardant Polyethylene*</b><br>UL94-V-0 Rating<br>This material is self-extinguishing and passes the UL94 flame retardant test with a V-0 rating.  | V-0                  | 270°F (132°C)       | 22 mg  | 1.23 – 1.37             | 1200                         | 0.02%                           | Resistant below 194°F (90°C) except to chlorinated solvents   | Resistant                    | Resistant except to oxidizing acids | Some Discoloration           |
|                       | <b>Nylon</b><br>Nylon is strong, durable, self-extinguishing material for indoor use up to 149°F. It offers a combination of lightweight, wide temperature range, and high abrasion resistance. This material is suitable for applications where heavy vibration or stress exists on the wiring or tubing.        | V-2                  | 491°F (255°C)       | 7 mg   | 1.03 – 1.15             | 12,400 (D638)                | 1.5%                            | Resistant except to phenols and formic acid                   | Resistant                    | Resistant to most weak acids        | No Discoloration             |

Note: Typical operating temperature ranges are extended based on end use application and specific environment tests.

\*Contains halogens. Other materials are halogen free.

A. System Overview

B1. Cable Ties

B2. Cable Accessories

B3. Stainless Steel Ties

C1. Wiring Duct

C2. Surface Raceway

C3. Abrasion Protection

C4. Cable Management

D1. Terminals

D2. Power Connectors

D3. Grounding Connectors

E1. Labeling Systems

E2. Labels

E3. Pre-Printed & Write-On Markers

E4. Permanent Identification

E5. Lockout/Tagout & Safety Solutions

F. Index

A. System Overview

## Panduit Heat Shrink Tubing Heat Shrink Tubing Quick Selection Guide

B1. Cable Ties

Quick reference for Panduit Heat Shrink for specific location applications

B2. Cable Accessories

B3. Stainless Steel Ties

C1. Wiring Duct

C2. Surface Raceway

C3. Abrasion Protection

C4. Cable Management

D1. Terminals

D2. Power Connectors

D3. Grounding Connectors

E1. Labeling Systems

E2. Labels

E3. Pre-Printed & Write-On Markers

E4. Permanent Identification

E5. Lockout/Tagout & Safety Solutions

F. Index



**CHARACTERISTICS**

|                                 | HSTT        | HSTTV       | HSTTN | HSTTK | HSTTT | HSTTP | HSTTPN | HSTTVVA     | HSTTRA     | HSTTA | HSTTA4A | HST   | HSEC  | HSECFR |
|---------------------------------|-------------|-------------|-------|-------|-------|-------|--------|-------------|------------|-------|---------|-------|-------|--------|
| U.L. Listed                     |             |             |       |       |       |       |        |             |            |       |         | X     |       |        |
| UL Recognized                   | X‡          | X           |       | X     |       | X     | X      |             |            |       | X       | X     |       | X      |
| CSA Certified                   | X‡          | X           |       | X     |       | X     | X      |             |            |       |         | X     |       |        |
| VW-1-Rated                      |             | X           |       | X     |       | X     | X      | X^          | X^         | X^    | X^      | X     |       |        |
| Very Flexible                   |             | X           | X     |       |       |       |        |             |            |       |         |       |       |        |
| Flexible                        | X           |             |       |       |       | X     | X      | X           |            | X     |         |       |       |        |
| Semi-Rigid                      |             |             |       | X     | X     |       | X      |             | X          |       |         |       | X     |        |
| Thin Wall                       | X           | X           | X     | X     | X     | X     | X      | X           | X          | X     | X       |       |       |        |
| Thick Wall                      |             |             |       |       |       |       |        |             |            |       |         | X     | X     | X      |
| Cross-Linked Material           | X           | X           | X     | X     |       | X     |        | X           | X          | X     | X       | X     | X     | X      |
| Colors Available                | X           | X           |       |       |       |       |        |             |            |       |         | X*    |       |        |
| Shrink Ratio                    | 2:1         | 2:1         | 2:1   | 2:1   | 2:1   | 2:1   | 2:1    | 2:1         | 2.5:1 min. | 3:1   | 4:1     | 3:1   | 2.5:1 | 3:1    |
| Flame Retardant                 | X‡          | X           | X     | X     | X     | X     | X      | X           | X          | X     | X       | X     |       | X      |
| Adhesive Lined (Dual Wall)      |             |             |       |       |       |       |        | X           | X          | X     | X       | X     | X     | X      |
| Meets Military Specifications   | X■          | X■          | X     | X■    | X     |       | X      | X■          | X■         | X■    | X■      | X     |       |        |
| Below Ground Application        |             |             |       |       |       |       |        |             |            |       |         | X     |       |        |
| High Temp Applications (>250°F) |             |             |       | X     | X     |       |        |             |            |       |         |       |       |        |
| Highly Chemical Resistant       |             |             | X     | X     | X     |       |        |             |            |       |         |       |       |        |
| Low Coefficient of Friction     |             |             |       |       | X     |       |        |             |            |       |         |       |       |        |
| Custom Cut Lengths              | X           | X           | X     | X     | X     | X     |        | X           | X          | X     |         | X     |       |        |
| Standard 6" pieces              | X           | X           |       |       |       |       |        | X           |            | X     |         |       |       |        |
| Standard 4' lengths             | X           | X           |       | X     | X     |       |        | X           | X          | X     | X       | X     |       |        |
| Small 25' Reels                 | X           | X           | X     |       |       | X     |        |             |            |       |         |       |       |        |
| Large Reels                     | X           | X           | X     |       |       | X     | X      |             |            |       |         |       |       |        |
| UV Resistant                    | X#          | X#          | X#    | X     | X     | X#    |        | X#          | X#         | X#    | X#      | X#    | X#    | X#     |
| Shrink Temperature              | 194°F       | 194°F       | 275°F | 275°F | 644°F | 212°F | 212°F  | 248°F       | 257°F      | 248°F | 248°F   | 248°F | 248°F | 248°F  |
| Shelf Life (years)              | 5           | 5           | 5**   | 5     | 4     | 1     | 1      | 5           | 5          | 5     | 5       | 10    | 5     | 5      |
| Found on Page...                | C3.24–C3.27 | C3.28–C3.31 | C3.33 | C3.35 | C3.34 | C3.32 | C3.33  | C3.35–C3.36 | C3.37      | C3.36 | C3.37   | C3.38 | C3.39 | C3.39  |

\*Black/Red  
 \*\*Excluding HSTTN300 which is 2 years.  
 ‡Except Clear  
 ^Outer Wall  
 ■Material Performance only  
 #Black only



## Part Number System for Thin Wall Heat Shrink

### HSTT

| Type   | Expanded Diameter     | Tube Length        | Package Quantity                              | Color                 |
|--|-----------------------|--------------------|---|-----------------------|
| HSTT = Thin Wall   | 05 = 3/64" (1.2mm)    | 3 = 3" (76.2mm)    | (If Tube Length Specified)                    | NONE = Black          |
| HSTTV = Thin Wall VW-1   | 06 = 1/16" (1.6mm)    | 6 = 6" (152.4mm)   | 1 = 1 pc.                                     | C = Clear             |
| HSTTN = Thin Wall Neoprene   | 09 = 3/32" (2.4mm)    | 9 = 9" (228.6mm)   | 2 = 2 Pcs.                                    | 2 = Red               |
| HSTTK = Thin Wall PVDF KYNAR ▲                                     | 12 = 1/8" (3.2mm)     | 12 = 12" (304.8mm) | 3 = 3 Pcs.                                    | 4 = Yellow            |
| HSTTT = Thin Wall TFE ‡  | 19 = 3/16" (4.8mm)    | 48 = 48" (1.2m)    | 5 = 5 Pcs.                                    | 5 = Green             |
| HSTTP = Thin Wall PVC  | 25 = 1/4" (6.4mm)     | NONE = REEL        | X = 10 Pcs.                                   | 6 = Blue              |
| HSTTPN = Crystal Clear Thin Wall PVC                               | 38 = 3/8" (9.5mm)     |                    | Q = 25 Pcs.                                   | 10 = White            |
| HSTTVA = Flexible Adhesive Lined                                   | 50 = 1/2" (12.7mm)    |                    | LQ = 75 Pcs.                                  | 45 = Yellow/<br>Green |
| HSTTRA = Semi-Rigid Adhesive Lined                                 | 75 = 3/4" (19.1mm)    |                    | CQ = 125 Pcs.                                 |                       |
| HSTTA = Thin Wall Adhesive Lined                                   | 100 = 1" (25.4mm)     |                    | T = 200 Pcs.                                  |                       |
| HSTT4A = 4:1 Thin Wall Adhesive Lined                              | 150 = 1 1/2" (38.1mm) |                    | TL = 250 Pcs.                                 |                       |
| HST = Thick Wall Adhesive Lined                                    | 200 = 2" (50.8mm)     |                    | Y = 6" Pcs.                                   |                       |
| HSEC = Heat Shrink End Caps<br>Adhesive Lined                      | 300 = 3" (76.2mm)     |                    |   |                       |
| HSECFR = Heat Shrink End Caps<br>Flame Retardant<br>Adhesive Lined | 400 = 4" (101.6mm)    |                    |   |                       |
|  | 0.4 = .40" (10.2mm)   |                    | <b>Reels</b><br>(If No Tube Length Specified) |                       |
|  | 0.5 = .47" (11.9mm)   |                    | Q = 25' (7.6m)                                |                       |
|  | 0.8 = .80" (20.3mm)   |                    | L = 50' (15.2m)                               |                       |
|  | 1.0 = 1.0" (25.4mm)   |                    | C = 100' (30.5m)                              |                       |
|  | 1.1 = 1.1" (27.9mm)   |                    | T = 200' (61.0m)                              |                       |
|  | 1.5 = 1.5" (38.1mm)   |                    | D = 500' (152.4m)                             |                       |
|  | 2.0 = 2.0" (50.8mm)   |                    | M = 1000' (304.8m)                            |                       |
|  | 3.0 = 3.0" (76.2mm)   |                    |   |                       |
|  | 4.0 = 4.0" (101.6mm)  |                    |   |                       |

For Standard Packages containing 6" (152.4mm) lengths, refer to individual pages for complete part number offering.

Note: The above information is to be used as a guide. For specific part number offerings review individual pages for verification.

▲KYNAR is a registered trademark of Atofina Chemicals, Inc.

‡TFE is Polytetrafluoroethylene material.

A.  
System  
Overview

B1.  
Cable Ties

B2.  
Cable  
Accessories

B3.  
Stainless  
Steel Ties

C1.  
Wiring  
Duct

C2.  
Surface  
Raceway

C3.  
Abrasion  
Protection

C4.  
Cable  
Management

D1.  
Terminals

D2.  
Power  
Connectors

D3.  
Grounding  
Connectors

E1.  
Labeling  
Systems

E2.  
Labels

E3.  
Pre-Printed  
& Write-On  
Markers

E4.  
Permanent  
Identification

E5.  
Lockout/  
Tagout  
& Safety  
Solutions

F.  
Index

A. System Overview

## HSTT Heat Shrink 4 Foot Pieces and Reels

B1. Cable Ties

- Applications include insulating, protecting, and color coding wires and cables

- UL Recognized, CSA Certified
- Mil Spec: AMS-DTL-23053/5 Class 1 (Colors) Class 2 (Clear)

B2. Cable Accessories

- Voltage: 600 V

- Temperature range: -67°F to 275°F (-55°C to 135°C)

- Shrink ratio: 2:1

- For dry locations

- Flammability: Flame retardant EXCEPT clear

- Material: Black cross-linked Polyolefin

B3. Stainless Steel Ties



C1. Wiring Duct



C2. Surface Raceway

C3. Abrasion Protection

C4. Cable Management

D1. Terminals

D2. Power Connectors

D3. Grounding Connectors

E1. Labeling Systems

E2. Labels

E3. Pre-Printed & Write-On Markers

E4. Permanent Identification

E5. Lockout/Tagout & Safety Solutions

F. Index

| Part Number* | Nominal Diameter |     | Min. Expanded I.D. |     | Max. Recovered I.D. |     | Nominal Recovered Wall Thickness |     | Length |     | Length per Reel |       | Std. Pkg. Qty. | Std Ctn. Qty. |
|--------------|------------------|-----|--------------------|-----|---------------------|-----|----------------------------------|-----|--------|-----|-----------------|-------|----------------|---------------|
|              | In.              | mm  | In.                | mm  | In.                 | mm  | In.                              | mm  | Ft.    | m   | Ft.             | m     |                |               |
| HSTT05-48-Q  | 0.046            | 1.2 | 0.046              | 1.2 | 0.023               | 0.6 | 0.016                            | 0.4 | 4      | 1.2 | —               | —     | 25             | —             |
| HSTT05-48-TL | 0.046            | 1.2 | 0.046              | 1.2 | 0.023               | 0.6 | 0.016                            | 0.4 | 4      | 1.2 | —               | —     | 250            | —             |
| HSTT05-C‡    | 0.046            | 1.2 | 0.046              | 1.2 | 0.023               | 0.6 | 0.016                            | 0.4 | —      | —   | 100             | 30.5  | 1              | 10            |
| HSTT05-M‡    | 0.046            | 1.2 | 0.046              | 1.2 | 0.023               | 0.6 | 0.016                            | 0.4 | —      | —   | 1000            | 304.8 | 1              | 2             |
| HSTT06-48-Q  | 0.063            | 1.6 | 0.063              | 1.6 | 0.031               | 0.8 | 0.017                            | 0.4 | 4      | 1.2 | —               | —     | 25             | —             |
| HSTT06-48-TL | 0.063            | 1.6 | 0.063              | 1.6 | 0.031               | 0.8 | 0.017                            | 0.4 | 4      | 1.2 | —               | —     | 250            | —             |
| HSTT06-C‡    | 0.063            | 1.6 | 0.063              | 1.6 | 0.031               | 0.8 | 0.017                            | 0.4 | —      | —   | 100             | 30.5  | 1              | 10            |
| HSTT06-M‡    | 0.063            | 1.6 | 0.063              | 1.6 | 0.031               | 0.8 | 0.017                            | 0.4 | —      | —   | 1000            | 304.8 | 1              | 2             |
| HSTT09-48-Q  | 0.093            | 2.4 | 0.093              | 2.4 | 0.046               | 1.2 | 0.020                            | 0.5 | 4      | 1.2 | —               | —     | 25             | —             |
| HSTT09-48-TL | 0.093            | 2.4 | 0.093              | 2.4 | 0.046               | 1.2 | 0.020                            | 0.5 | 4      | 1.2 | —               | —     | 250            | —             |
| HSTT09-C‡    | 0.093            | 2.4 | 0.093              | 2.4 | 0.046               | 1.2 | 0.020                            | 0.5 | —      | —   | 100             | 30.5  | 1              | 10            |
| HSTT09-M‡    | 0.093            | 2.4 | 0.093              | 2.4 | 0.046               | 1.2 | 0.020                            | 0.5 | —      | —   | 1000            | 304.8 | 1              | 2             |
| HSTT12-48-Q  | 0.125            | 3.2 | 0.125              | 3.2 | 0.062               | 1.6 | 0.020                            | 0.5 | 4      | 1.2 | —               | —     | 25             | —             |
| HSTT12-48-TL | 0.125            | 3.2 | 0.125              | 3.2 | 0.062               | 1.6 | 0.020                            | 0.5 | 4      | 1.2 | —               | —     | 250            | —             |
| HSTT12-C‡    | 0.125            | 3.2 | 0.125              | 3.2 | 0.062               | 1.6 | 0.020                            | 0.5 | —      | —   | 100             | 30.5  | 1              | 10            |
| HSTT12-M‡    | 0.125            | 3.2 | 0.125              | 3.2 | 0.062               | 1.6 | 0.020                            | 0.5 | —      | —   | 1000            | 304.8 | 1              | 2             |
| HSTT19-48-Q  | 0.187            | 4.8 | 0.187              | 4.8 | 0.093               | 2.4 | 0.020                            | 0.5 | 4      | 1.2 | —               | —     | 25             | —             |
| HSTT19-48-TL | 0.187            | 4.8 | 0.187              | 4.8 | 0.093               | 2.4 | 0.020                            | 0.5 | 4      | 1.2 | —               | —     | 250            | —             |
| HSTT19-C‡    | 0.187            | 4.8 | 0.187              | 4.8 | 0.093               | 2.4 | 0.020                            | 0.5 | —      | —   | 100             | 30.5  | 1              | 10            |
| HSTT19-M‡    | 0.187            | 4.8 | 0.187              | 4.8 | 0.093               | 2.4 | 0.020                            | 0.5 | —      | —   | 1000            | 304.8 | 1              | 2             |
| HSTT25-48-Q  | 0.250            | 6.4 | 0.250              | 6.4 | 0.125               | 3.2 | 0.025                            | 0.6 | 4      | 1.2 | —               | —     | 25             | —             |
| HSTT25-48-TL | 0.250            | 6.4 | 0.250              | 6.4 | 0.125               | 3.2 | 0.025                            | 0.6 | 4      | 1.2 | —               | —     | 250            | —             |
| HSTT25-C‡    | 0.250            | 6.4 | 0.250              | 6.4 | 0.125               | 3.2 | 0.025                            | 0.6 | —      | —   | 100             | 30.5  | 1              | 10            |
| HSTT25-D‡    | 0.250            | 6.4 | 0.250              | 6.4 | 0.125               | 3.2 | 0.025                            | 0.6 | —      | —   | 500             | 152.4 | 1              | 2             |
| HSTT38-48-Q  | 0.375            | 9.5 | 0.375              | 9.5 | 0.187               | 4.8 | 0.025                            | 0.6 | 4      | 1.2 | —               | —     | 25             | —             |
| HSTT38-48-TL | 0.375            | 9.5 | 0.375              | 9.5 | 0.187               | 4.8 | 0.025                            | 0.6 | 4      | 1.2 | —               | —     | 250            | —             |
| HSTT38-C‡    | 0.375            | 9.5 | 0.375              | 9.5 | 0.187               | 4.8 | 0.025                            | 0.6 | —      | —   | 100             | 30.5  | 1              | 10            |
| HSTT38-T‡    | 0.375            | 9.5 | 0.375              | 9.5 | 0.187               | 4.8 | 0.025                            | 0.6 | —      | —   | 200             | 61.0  | 1              | 2             |

\*For colors, add C (Clear), 2 (Red), 4 (Yellow), 45 (Yellow/Green), 5 (Green), 6 (Blue) and 10 (White) to end of part number.

‡Part sold per reel

## RA® SP® HSTT Heat Shrink 4 Foot Pieces and Reels (continued)



| Part Number*  | Nominal Diameter |       | Min. Expanded I.D. |       | Max. Recovered I.D. |      | Nominal Recovered Wall Thickness |     | Length |     | Length per Reel |      | Std. Pkg. Qty. | Std. Ctn. Qty. |
|---------------|------------------|-------|--------------------|-------|---------------------|------|----------------------------------|-----|--------|-----|-----------------|------|----------------|----------------|
|               | In.              | mm    | In.                | mm    | In.                 | mm   | In.                              | mm  | Ft.    | m   | Ft.             | m    |                |                |
| HSTT50-48-5   | 0.500            | 12.7  | 0.500              | 12.7  | 0.250               | 6.4  | 0.025                            | 0.6 | 4      | 1.2 | —               | —    | 5              | —              |
| HSTT50-48-Q   | 0.500            | 12.7  | 0.500              | 12.7  | 0.250               | 6.4  | 0.025                            | 0.6 | 4      | 1.2 | —               | —    | 25             | —              |
| HSTT50-48-T   | 0.500            | 12.7  | 0.500              | 12.7  | 0.250               | 6.4  | 0.025                            | 0.6 | 4      | 1.2 | —               | —    | 200            | —              |
| HSTT50-C‡     | 0.500            | 12.7  | 0.500              | 12.7  | 0.250               | 6.4  | 0.025                            | 0.6 | —      | —   | 100             | 30.5 | 1              | 10             |
| HSTT50-T‡     | 0.500            | 12.7  | 0.500              | 12.7  | 0.250               | 6.4  | 0.025                            | 0.6 | —      | —   | 200             | 61.0 | 1              | 2              |
| HSTT75-48-5   | 0.750            | 19.1  | 0.750              | 19.1  | 0.375               | 9.5  | 0.030                            | 0.8 | 4      | 1.2 | —               | —    | 5              | —              |
| HSTT75-48-CQ  | 0.750            | 19.1  | 0.750              | 19.1  | 0.375               | 9.5  | 0.030                            | 0.8 | 4      | 1.2 | —               | —    | 125            | —              |
| HSTT75-C‡     | 0.750            | 19.1  | 0.750              | 19.1  | 0.375               | 9.5  | 0.030                            | 0.8 | —      | —   | 100             | 30.5 | 1              | 10             |
| HSTT75-T‡     | 0.750            | 19.1  | 0.750              | 19.1  | 0.375               | 9.5  | 0.030                            | 0.8 | —      | —   | 200             | 61.0 | 1              | 2              |
| HSTT100-48-5  | 1.00             | 25.4  | 1.00               | 25.4  | 0.500               | 12.7 | 0.035                            | 0.9 | 4      | 1.2 | —               | —    | 5              | —              |
| HSTT100-48-LQ | 1.00             | 25.4  | 1.00               | 25.4  | 0.500               | 12.7 | 0.035                            | 0.9 | 4      | 1.2 | —               | —    | 75             | —              |
| HSTT100-C‡    | 1.00             | 25.4  | 1.00               | 25.4  | 0.500               | 12.7 | 0.035                            | 0.9 | —      | —   | 100             | 30.5 | 1              | 2              |
| HSTT150-48-5  | 1.50             | 38.1  | 1.50               | 38.1  | 0.750               | 19.1 | 0.040                            | 1.0 | 4      | 1.2 | —               | —    | 5              | —              |
| HSTT150-C‡    | 1.50             | 38.1  | 1.50               | 38.1  | 0.750               | 19.1 | 0.040                            | 1.0 | —      | —   | 100             | 30.5 | 1              | 2              |
| HSTT200-48-5  | 2.00             | 50.8  | 2.00               | 50.8  | 1.00                | 25.4 | 0.045                            | 1.1 | 4      | 1.2 | —               | —    | 5              | —              |
| HSTT200-L‡    | 2.00             | 50.8  | 2.00               | 50.8  | 1.00                | 25.4 | 0.045                            | 1.1 | —      | —   | 50              | 15.2 | 1              | 2              |
| HSTT300-48-2  | 3.00             | 76.2  | 3.00               | 76.2  | 1.50                | 38.1 | 0.050                            | 1.3 | 4      | 1.2 | —               | —    | 2              | —              |
| HSTT300-L‡    | 3.00             | 76.2  | 3.00               | 76.2  | 1.50                | 38.1 | 0.050                            | 1.3 | —      | —   | 50              | 15.2 | 1              | 0              |
| HSTT400-48-2  | 4.00             | 101.6 | 4.00               | 101.6 | 2.00                | 50.8 | 0.055                            | 1.4 | 4      | 1.2 | —               | —    | 2              | —              |
| HSTT400-L‡    | 4.00             | 101.6 | 4.00               | 101.6 | 2.00                | 50.8 | 0.055                            | 1.4 | —      | —   | 50              | 15.2 | 1              | 0              |

\*For colors, add C (Clear), 2 (Red), 4 (Yellow), 45 (Yellow/Green), 5 (Green), 6 (Blue) and 10 (White) to end of part number.

‡Part sold per reel

## RA® SP® HSTT Heat Shrink on 25 Foot Reels

- Applications include insulating and protecting wires and cables
- Voltage: 600 V
- Shrink ratio: 2:1
- Flammability: Flame retardant EXCEPT clear
- UL Recognized, CSA Certified
- Mil Spec: AMS-DTL-23053/5 Class 1 (Black) Class 2 (Clear)
- Temperature range: -67°F to 275°F (-55°C to 135°C)
- For dry locations
- Material: Cross-linked Polyolefin



| Part Number* | Nominal Diameter |      | Min. Expanded I.D. |      | Max. Recovered I.D. |     | Nominal Recovered Wall Thickness |     | Std. Pkg. Qty. | Std. Ctn. Qty. |
|--------------|------------------|------|--------------------|------|---------------------|-----|----------------------------------|-----|----------------|----------------|
|              | In.              | mm   | In.                | mm   | In.                 | mm  | In.                              | mm  |                |                |
| HSTT05-Q     | 0.046            | 1.2  | 0.046              | 1.2  | 0.023               | 0.6 | 0.016                            | 0.4 | 1              | 10             |
| HSTT06-Q     | 0.063            | 1.6  | 0.063              | 1.6  | 0.031               | 0.8 | 0.017                            | 0.4 | 1              | 10             |
| HSTT09-Q     | 0.093            | 2.4  | 0.093              | 2.4  | 0.046               | 1.2 | 0.020                            | 0.5 | 1              | 10             |
| HSTT12-Q     | 0.125            | 3.2  | 0.125              | 3.2  | 0.062               | 1.6 | 0.020                            | 0.5 | 1              | 10             |
| HSTT19-Q     | 0.187            | 4.8  | 0.187              | 4.8  | 0.093               | 2.4 | 0.020                            | 0.5 | 1              | 10             |
| HSTT25-Q     | 0.250            | 6.4  | 0.250              | 6.4  | 0.125               | 3.2 | 0.025                            | 0.6 | 1              | 10             |
| HSTT38-Q     | 0.375            | 9.5  | 0.375              | 9.5  | 0.187               | 4.8 | 0.025                            | 0.6 | 1              | 10             |
| HSTT50-Q     | 0.500            | 12.7 | 0.500              | 12.7 | 0.250               | 6.4 | 0.025                            | 0.6 | 1              | 10             |
| HSTT75-Q     | 0.750            | 19.1 | 0.750              | 19.1 | 0.375               | 9.5 | 0.030                            | 0.8 | 1              | 10             |

\* For clear, add C to end of part number.

A. System Overview

B1. Cable Ties

B2. Cable Accessories

B3. Stainless Steel Ties

C1. Wiring Duct

C2. Surface Raceway

C3. Abrasion Protection

C4. Cable Management

D1. Terminals

D2. Power Connectors

D3. Grounding Connectors

E1. Labeling Systems

E2. Labels

E3. Pre-Printed & Write-On Markers

E4. Permanent Identification

E5. Lockout/Tagout & Safety Solutions

F. Index

A. System Overview

## Heat Shrink in 6 Inch Pieces; Black, Single Diameter

- Applications include insulating, protecting, and color coding wires and cables
- Voltage: 600 V
- Shrink ratio: 2:1
- Flammability: Flame retardant
- UL Recognized, CSA Certified
- Mil Spec: AMS-DTL-23053/5 Class 1
- Temperature range: -67°F to 275°F (-55°C to 135°C)
- For dry locations
- Material: Cross-linked Polyolefin



B1. Cable Ties

B2. Cable Accessories

B3. Stainless Steel Ties



| Part Number | Nominal Diameter |      | Min. Expanded I.D. |      | Max. Recovered I.D. |      | Nominal Recovered Wall Thickness |     | Total No. Pcs. | Std. Pkg. Qty. | Std. Ctn. Qty. |
|-------------|------------------|------|--------------------|------|---------------------|------|----------------------------------|-----|----------------|----------------|----------------|
|             | In.              | mm   | In.                | mm   | In.                 | mm   | In.                              | mm  |                |                |                |
| HSTT06-Y    | 0.063            | 1.6  | 0.063              | 1.6  | 0.031               | 0.8  | 0.017                            | 0.4 | 26             | 1              | 10             |
| HSTT09-Y    | 0.093            | 2.4  | 0.093              | 2.4  | 0.046               | 1.2  | 0.020                            | 0.5 | 24             | 1              | 10             |
| HSTT12-Y    | 0.125            | 3.2  | 0.125              | 3.2  | 0.062               | 1.6  | 0.020                            | 0.5 | 20             | 1              | 10             |
| HSTT19-Y    | 0.187            | 4.8  | 0.187              | 4.8  | 0.093               | 2.4  | 0.020                            | 0.5 | 18             | 1              | 10             |
| HSTT25-Y    | 0.250            | 6.4  | 0.250              | 6.4  | 0.125               | 3.2  | 0.025                            | 0.6 | 14             | 1              | 10             |
| HSTT38-Y    | 0.375            | 9.5  | 0.375              | 9.5  | 0.187               | 4.8  | 0.025                            | 0.6 | 12             | 1              | 10             |
| HSTT50-Y    | 0.500            | 12.7 | 0.500              | 12.7 | 0.250               | 6.4  | 0.025                            | 0.6 | 10             | 1              | 10             |
| HSTT75-Y    | 0.750            | 19.1 | 0.750              | 19.1 | 0.375               | 9.5  | 0.030                            | 0.8 | 8              | 1              | 10             |
| HSTT100-Y   | 1.00             | 25.4 | 1.00               | 25.4 | 0.500               | 12.7 | 0.035                            | 0.9 | 6              | 1              | 10             |

C1. Wiring Duct

C2. Surface Raceway

C3. Abrasion Protection

C4. Cable Management

D1. Terminals

## Heat Shrink in 6 Inch Pieces; Multi-Color, Single Diameter

- Applications include insulating, protecting, and color coding wires and cables
- Voltage: 600 V
- Shrink ratio: 2:1
- Flammability: Flame retardant EXCEPT clear
- UL Recognized, CSA Certified
- Mil Spec: AMS-DTL-23053/5 Class 1 (Colors) Class 2 (Clear)
- Temperature range: -67°F to 275°F (-55°C to 135°C)
- For dry locations
- Material: Cross-linked Polyolefin
- Colors include: clear, red, yellow, green, blue and white



E1. Labeling Systems



E2. Labels

E3. Pre-Printed & Write-On Markers

E4. Permanent Identification

E5. Lockout/Tagout & Safety Solutions

F. Index

| Part Number | Nominal Diameter |      | Min. Expanded I.D. |      | Max. Recovered I.D. |      | Total No. Pcs. | Black No. of Pieces | Each Color No. of Pieces | Std. Pkg. Qty. | Std. Ctn. Qty. |
|-------------|------------------|------|--------------------|------|---------------------|------|----------------|---------------------|--------------------------|----------------|----------------|
|             | In.              | mm   | In.                | mm   | In.                 | mm   |                |                     |                          |                |                |
| HSTT06-YK1  | 0.063            | 1.6  | 0.063              | 1.6  | 0.031               | 0.8  | 26             | 8                   | 3                        | 1              | 10             |
| HSTT09-YK1  | 0.093            | 2.4  | 0.093              | 2.4  | 0.046               | 1.2  | 24             | 6                   | 3                        | 1              | 10             |
| HSTT12-YK1  | 0.125            | 3.2  | 0.125              | 3.2  | 0.062               | 1.6  | 20             | 2                   | 3                        | 1              | 10             |
| HSTT19-YK1  | 0.187            | 4.8  | 0.187              | 4.8  | 0.093               | 2.4  | 18             | 6                   | 2                        | 1              | 10             |
| HSTT25-YK1  | 0.250            | 6.4  | 0.250              | 6.4  | 0.125               | 3.2  | 14             | 2                   | 2                        | 1              | 10             |
| HSTT38-YK1  | 0.375            | 9.5  | 0.375              | 9.5  | 0.187               | 4.8  | 12             | 6                   | 1                        | 1              | 10             |
| HSTT50-YK1  | 0.500            | 12.7 | 0.500              | 12.7 | 0.250               | 6.4  | 10             | 4                   | 1                        | 1              | 10             |
| HSTT75-YK1  | 0.750            | 19.1 | 0.750              | 19.1 | 0.375               | 9.5  | 8              | 2                   | 1                        | 1              | 10             |
| HSTT100-YK1 | 1.00             | 25.4 | 1.00               | 25.4 | 0.500               | 12.7 | 7              | 1                   | 1                        | 1              | 10             |

## Heat Shrink in 6 Inch Pieces; Black, Multiple Diameters

- Applications include insulating and protecting wires and cables
- Voltage: 600 V
- Shrink ratio: 2:1
- UL Recognized, CSA Certified
- Mil Spec: AMS-DTL-23053/5 Class 1
- Temperature range: -67°F to 275°F (-55°C to 135°C)
- For dry locations
- Material: Cross-linked Polyolefin



| Part Number | Nominal Diameter        | No. of Pieces by Diameter                                 | Total No. Pcs. | Std. Pkg. Qty. | Std. Ctn. Qty. |
|-------------|-------------------------|---|----------------|----------------|----------------|
| HSTT-YK1    | Various – Smaller Range | Two pcs. each 1/8", 1/16", 3/32", 1/4", 3/16", 3/8", 1/2" | 14             | 1              | 10             |
| HSTT-YK2    | Various – Larger Range  | Two pcs. each 3/8", 1/2", 3/4", 1"                        | 8              | 1              | 10             |

## Heat Shrink in 6 Inch Pieces; Yellow/Green Stripe, Multiple Diameters

- Applications include insulating, protecting, and color coding wires and cables
- Voltage: 600 V
- Shrink ratio: 2:1
- Flammability: Flame retardant
- UL Recognized, CSA Certified
- Mil Spec: AMS-DTL-23053/5 Class 1
- Temperature range: -67°F to 275°F (-55°C to 135°C)
- For dry locations
- Material: Cross-linked Polyolefin



| Part Number | Nominal Diameter        | No. of Pieces by Diameter             | Total No. Pcs. | Std. Pkg. Qty. | Std. Ctn. Qty. |
|-------------|-------------------------|---------------------------------------|----------------|----------------|----------------|
| HSTT-YK1-45 | Various – Smaller Range | Two pcs. each 1/8", 3/16", 1/4", 3/8" | 8              | 1              | 10             |
| HSTT-YK2-45 | Various – Larger Range  | Two pcs. each 3/8", 1/2", 3/4"        | 6              | 1              | 10             |

A.  
System  
Overview

B1.  
Cable Ties

B2.  
Cable  
Accessories

B3.  
Stainless  
Steel Ties

C1.  
Wiring  
Duct

C2.  
Surface  
Raceway

C3.  
Abrasion  
Protection

C4.  
Cable  
Management

D1.  
Terminals

D2.  
Power  
Connectors

D3.  
Grounding  
Connectors

E1.  
Labeling  
Systems

E2.  
Labels

E3.  
Pre-Printed  
& Write-On  
Markers

E4.  
Permanent  
Identification

E5.  
Lockout/  
Tagout  
& Safety  
Solutions

F.  
Index

A.  
System  
Overview

## HSTTV Heat Shrink 4 Foot Pieces

B1.  
Cable Ties

- Applications include insulating and protecting wires and cables
- Fast shrink time
- Voltage: 600 V
- Shrink ratio: 2:1
- Flammability: Meets UL 224 VW-1
- UL Recognized, CSA Certified
- Mil Spec: AMS-DTL-23053/5 Class 3
- Temperature range: -67°F to 275°F (-55°C to 135°C)
- For dry locations
- Material: Black cross-linked Polyolefin

B2.  
Cable  
Accessories

B3.  
Stainless  
Steel Ties



C1.  
Wiring  
Duct



C2.  
Surface  
Raceway

C3.  
Abrasion  
Protection

C4.  
Cable  
Management

D1.  
Terminals

D2.  
Power  
Connectors

D3.  
Grounding  
Connectors

E1.  
Labeling  
Systems

E2.  
Labels

E3.  
Pre-Printed  
& Write-On  
Markers

E4.  
Permanent  
Identification

E5.  
Lockout/  
Tagout  
& Safety  
Solutions

F.  
Index

| Part Number    | Nominal Diameter |      | Min. Expanded I.D. |      | Max. Recovered I.D. |      | Nominal Recovered Wall Thickness |     | Std. Pkg. Qty. | Std. Ctn. Qty. |
|----------------|------------------|------|--------------------|------|---------------------|------|----------------------------------|-----|----------------|----------------|
|                | In.              | mm   | In.                | mm   | In.                 | mm   | In.                              | mm  |                |                |
| HSTTV05-48-Q   | 0.046            | 1.2  | 0.046              | 1.2  | 0.023               | 0.6  | 0.016                            | 0.4 | 25             | —              |
| HSTTV05-48-TL  | 0.046            | 1.2  | 0.046              | 1.2  | 0.023               | 0.6  | 0.016                            | 0.4 | 250            | —              |
| HSTTV06-48-Q   | 0.063            | 1.6  | 0.063              | 1.6  | 0.031               | 0.8  | 0.017                            | 0.4 | 25             | —              |
| HSTTV06-48-TL  | 0.063            | 1.6  | 0.063              | 1.6  | 0.031               | 0.8  | 0.017                            | 0.4 | 250            | —              |
| HSTTV09-48-Q   | 0.093            | 2.4  | 0.093              | 2.4  | 0.046               | 1.2  | 0.020                            | 0.5 | 25             | —              |
| HSTTV09-48-TL  | 0.093            | 2.4  | 0.093              | 2.4  | 0.046               | 1.2  | 0.020                            | 0.5 | 250            | —              |
| HSTTV12-48-Q   | 0.125            | 3.2  | 0.125              | 3.2  | 0.062               | 1.6  | 0.020                            | 0.5 | 25             | —              |
| HSTTV12-48-TL  | 0.125            | 3.2  | 0.125              | 3.2  | 0.062               | 1.6  | 0.020                            | 0.5 | 250            | —              |
| HSTTV19-48-Q   | 0.187            | 4.8  | 0.187              | 4.8  | 0.093               | 2.4  | 0.020                            | 0.5 | 25             | —              |
| HSTTV19-48-TL  | 0.187            | 4.8  | 0.187              | 4.8  | 0.093               | 2.4  | 0.020                            | 0.5 | 250            | —              |
| HSTTV25-48-Q   | 0.250            | 6.4  | 0.250              | 6.4  | 0.125               | 3.2  | 0.025                            | 0.6 | 25             | —              |
| HSTTV25-48-TL  | 0.250            | 6.4  | 0.250              | 6.4  | 0.125               | 3.2  | 0.025                            | 0.6 | 250            | —              |
| HSTTV38-48-Q   | 0.375            | 9.5  | 0.375              | 9.5  | 0.187               | 4.8  | 0.025                            | 0.6 | 25             | —              |
| HSTTV38-48-TL  | 0.375            | 9.5  | 0.375              | 9.5  | 0.187               | 4.8  | 0.025                            | 0.6 | 250            | —              |
| HSTTV50-48-Q   | 0.500            | 12.7 | 0.500              | 12.7 | 0.250               | 6.4  | 0.025                            | 0.6 | 25             | —              |
| HSTTV50-48-T   | 0.500            | 12.7 | 0.500              | 12.7 | 0.250               | 6.4  | 0.025                            | 0.6 | 200            | —              |
| HSTTV75-48-5   | 0.750            | 19.1 | 0.750              | 19.1 | 0.375               | 9.5  | 0.030                            | 0.8 | 5              | —              |
| HSTTV75-48-CQ  | 0.750            | 19.1 | 0.750              | 19.1 | 0.375               | 9.5  | 0.030                            | 0.8 | 125            | —              |
| HSTTV100-48-5  | 1.00             | 25.4 | 1.00               | 25.4 | 0.500               | 12.7 | 0.035                            | 0.9 | 5              | —              |
| HSTTV100-48-LQ | 1.00             | 25.4 | 1.00               | 25.4 | 0.500               | 12.7 | 0.035                            | 0.9 | 75             | —              |
| HSTTV150-48-5  | 1.50             | 38.1 | 1.50               | 38.1 | 0.750               | 19.1 | 0.040                            | 1.0 | 5              | —              |



## HSTTV Heat Shrink on 100 Foot Reels

- Applications include insulating and protecting wires and cables
- Fast shrink time
- Voltage: 600 V
- Shrink ratio: 2:1
- Flammability: Meets UL 224 VW-1

- UL Recognized, CSA Certified
- Mil Spec: AMS-DTL-23053/5 Class 3
- Temperature range: -67°F to 275°F (-55°C to 135°C)
- For dry locations
- Material: Black Cross-linked Polyolefin



| Part Number  | Nominal Diameter |      | Min. Expanded I.D. |      | Max. Recovered I.D. |      | Nominal Recovered Wall Thickness |     | Std. Pkg. Qty. | Std. Ctn. Qty. |
|--------------|------------------|------|--------------------|------|---------------------|------|----------------------------------|-----|----------------|----------------|
|              | In.              | mm   | In.                | mm   | In.                 | mm   | In.                              | mm  |                |                |
| HSTTV05-C    | 0.046            | 1.2  | 0.046              | 1.2  | 0.023               | 0.6  | 0.016                            | 0.4 | 1              | 10             |
| HSTTV06-C    | 0.063            | 1.6  | 0.063              | 1.6  | 0.031               | 0.8  | 0.017                            | 0.4 | 1              | 10             |
| HSTTV09-C    | 0.093            | 2.4  | 0.093              | 2.4  | 0.046               | 1.2  | 0.020                            | 0.5 | 1              | 10             |
| HSTTV12-C    | 0.125            | 3.2  | 0.125              | 3.2  | 0.062               | 1.6  | 0.020                            | 0.5 | 1              | 10             |
| HSTTV19-C    | 0.187            | 4.8  | 0.187              | 4.8  | 0.093               | 2.4  | 0.020                            | 0.5 | 1              | 10             |
| HSTTV25-C    | 0.250            | 6.4  | 0.250              | 6.4  | 0.125               | 3.2  | 0.025                            | 0.6 | 1              | 10             |
| HSTTV38-C    | 0.375            | 9.5  | 0.375              | 9.5  | 0.187               | 4.8  | 0.025                            | 0.6 | 1              | 10             |
| HSTTV50-C    | 0.500            | 12.7 | 0.500              | 12.7 | 0.250               | 6.4  | 0.025                            | 0.6 | 1              | 10             |
| HSTTV75-C    | 0.750            | 19.1 | 0.750              | 19.1 | 0.375               | 9.5  | 0.030                            | 0.8 | 1              | 10             |
| HSTTV100-C   | 1.00             | 25.4 | 1.00               | 25.4 | 0.500               | 12.7 | 0.035                            | 0.9 | 1              | 2              |
| HSTTV100-C5* | 1.00             | 25.4 | 1.00               | 25.4 | 0.500               | 12.7 | 0.035                            | 0.9 | 1              | 2              |
| HSTTV150-C   | 1.50             | 38.1 | 1.50               | 38.1 | 0.750               | 19.1 | 0.040                            | 1.0 | 1              | 2              |

\*Green.

A. System Overview

## HSTTV Heat Shrink on Bulk Reels

- Applications include insulating, protecting, and color coding wires and cables
- Fast shrink time
- Voltage: 600 V
- Shrink ratio: 2:1
- Flammability: Meets UL 224 VW-1
- UL Recognized, CSA Certified
- Mil Spec: AMS-DTL-23053/5 Class 3
- Temperature range: -67°F to 275°F (-55°C to 135°C)
- For dry locations
- Material: Cross-linked Polyolefin

B1. Cable Ties

B2. Cable Accessories

B3. Stainless Steel Ties



C1. Wiring Duct

C2. Surface Raceway

C3. Abrasion Protection

C4. Cable Management

D1. Terminals

D2. Power Connectors

D3. Grounding Connectors

E1. Labeling Systems

E2. Labels

E3. Pre-Printed & Write-On Markers

E4. Permanent Identification

E5. Lockout/Tagout & Safety Solutions

F. Index



| Part Number | Nominal Diameter |      | Min. Expanded I.D. |      | Max. Recovered I.D. |      | Nominal Recovered Wall Thickness |     | Length Per Reel |       | Color  | Std. Pkg. Qty. | Std. Ctn. Qty. |
|-------------|------------------|------|--------------------|------|---------------------|------|----------------------------------|-----|-----------------|-------|--------|----------------|----------------|
|             | In.              | mm   | In.                | mm   | In.                 | mm   | In.                              | mm  | Ft.             | m     |        |                |                |
| HSTTV05-M   | 0.046            | 1.2  | 0.046              | 1.2  | 0.023               | 0.6  | 0.016                            | 0.4 | 1000            | 304.8 | Black  | 1              | 2              |
| HSTTV05-M2  | 0.046            | 1.2  | 0.046              | 1.2  | 0.023               | 0.6  | 0.016                            | 0.4 | 1000            | 304.8 | Red    | 1              | 2              |
| HSTTV05-M4  | 0.046            | 1.2  | 0.046              | 1.2  | 0.023               | 0.6  | 0.016                            | 0.4 | 1000            | 304.8 | Yellow | 1              | 2              |
| HSTTV05-M6  | 0.046            | 1.2  | 0.046              | 1.2  | 0.023               | 0.6  | 0.016                            | 0.4 | 1000            | 304.8 | Blue   | 1              | 2              |
| HSTTV06-M   | 0.063            | 1.6  | 0.063              | 1.6  | 0.031               | 0.8  | 0.017                            | 0.4 | 1000            | 304.8 | Black  | 1              | 2              |
| HSTTV06-M2  | 0.063            | 1.6  | 0.063              | 1.6  | 0.031               | 0.8  | 0.017                            | 0.4 | 1000            | 304.8 | Red    | 1              | 2              |
| HSTTV06-M4  | 0.063            | 1.6  | 0.063              | 1.6  | 0.031               | 0.8  | 0.017                            | 0.4 | 1000            | 304.8 | Yellow | 1              | 2              |
| HSTTV06-M6  | 0.063            | 1.6  | 0.063              | 1.6  | 0.031               | 0.8  | 0.017                            | 0.4 | 1000            | 304.8 | Blue   | 1              | 2              |
| HSTTV09-M   | 0.093            | 2.4  | 0.093              | 2.4  | 0.046               | 1.2  | 0.020                            | 0.5 | 1000            | 304.8 | Black  | 1              | 2              |
| HSTTV09-M2  | 0.093            | 2.4  | 0.093              | 2.4  | 0.046               | 1.2  | 0.020                            | 0.5 | 1000            | 304.8 | Red    | 1              | 2              |
| HSTTV09-M4  | 0.093            | 2.4  | 0.093              | 2.4  | 0.046               | 1.2  | 0.020                            | 0.5 | 1000            | 304.8 | Yellow | 1              | 2              |
| HSTTV09-M6  | 0.093            | 2.4  | 0.093              | 2.4  | 0.046               | 1.2  | 0.020                            | 0.5 | 1000            | 304.8 | Blue   | 1              | 2              |
| HSTTV12-M   | 0.125            | 3.2  | 0.125              | 3.2  | 0.062               | 1.6  | 0.020                            | 0.5 | 1000            | 304.8 | Black  | 1              | 2              |
| HSTTV12-M2  | 0.125            | 3.2  | 0.125              | 3.2  | 0.062               | 1.6  | 0.020                            | 0.5 | 1000            | 304.8 | Red    | 1              | 2              |
| HSTTV12-M4  | 0.125            | 3.2  | 0.125              | 3.2  | 0.062               | 1.6  | 0.020                            | 0.5 | 1000            | 304.8 | Yellow | 1              | 2              |
| HSTTV12-M6  | 0.125            | 3.2  | 0.125              | 3.2  | 0.062               | 1.6  | 0.020                            | 0.5 | 1000            | 304.8 | Blue   | 1              | 2              |
| HSTTV19-M   | 0.187            | 4.8  | 0.187              | 4.8  | 0.093               | 2.4  | 0.020                            | 0.5 | 1000            | 304.8 | Black  | 1              | 2              |
| HSTTV19-M2  | 0.187            | 4.8  | 0.187              | 4.8  | 0.093               | 2.4  | 0.020                            | 0.5 | 1000            | 304.8 | Red    | 1              | 2              |
| HSTTV19-M4  | 0.187            | 4.8  | 0.187              | 4.8  | 0.093               | 2.4  | 0.020                            | 0.5 | 1000            | 304.8 | Yellow | 1              | 2              |
| HSTTV19-M6  | 0.187            | 4.8  | 0.187              | 4.8  | 0.093               | 2.4  | 0.020                            | 0.5 | 1000            | 304.8 | Blue   | 1              | 2              |
| HSTTV25-D   | 0.250            | 6.4  | 0.250              | 6.4  | 0.125               | 3.2  | 0.025                            | 0.6 | 500             | 152.4 | Black  | 1              | 2              |
| HSTTV25-D2  | 0.250            | 6.4  | 0.250              | 6.4  | 0.125               | 3.2  | 0.025                            | 0.6 | 500             | 152.4 | Red    | 1              | 2              |
| HSTTV25-D4  | 0.250            | 6.4  | 0.250              | 6.4  | 0.125               | 3.2  | 0.025                            | 0.6 | 500             | 152.4 | Yellow | 1              | 2              |
| HSTTV25-D6  | 0.250            | 6.4  | 0.250              | 6.4  | 0.125               | 3.2  | 0.025                            | 0.6 | 500             | 152.4 | Blue   | 1              | 2              |
| HSTTV38-T   | 0.375            | 9.5  | 0.375              | 9.5  | 0.187               | 4.8  | 0.025                            | 0.6 | 200             | 61.1  | Black  | 1              | 2              |
| HSTTV38-T2  | 0.375            | 9.5  | 0.375              | 9.5  | 0.187               | 4.8  | 0.025                            | 0.6 | 200             | 61.1  | Red    | 1              | 2              |
| HSTTV38-T4  | 0.375            | 9.5  | 0.375              | 9.5  | 0.187               | 4.8  | 0.025                            | 0.6 | 200             | 61.1  | Yellow | 1              | 2              |
| HSTTV38-T6  | 0.375            | 9.5  | 0.375              | 9.5  | 0.187               | 4.8  | 0.025                            | 0.6 | 200             | 61.1  | Blue   | 1              | 2              |
| HSTTV50-T   | 0.500            | 12.7 | 0.500              | 12.7 | 0.250               | 6.4  | 0.025                            | 0.6 | 200             | 61.1  | Black  | 1              | 2              |
| HSTTV50-T2  | 0.500            | 12.7 | 0.500              | 12.7 | 0.250               | 6.4  | 0.025                            | 0.6 | 200             | 61.1  | Red    | 1              | 2              |
| HSTTV50-T4  | 0.500            | 12.7 | 0.500              | 12.7 | 0.250               | 6.4  | 0.025                            | 0.6 | 200             | 61.1  | Yellow | 1              | 2              |
| HSTTV50-T6  | 0.500            | 12.7 | 0.500              | 12.7 | 0.250               | 6.4  | 0.025                            | 0.6 | 200             | 61.1  | Blue   | 1              | 2              |
| HSTTV75-T   | 0.750            | 19.1 | 0.750              | 19.1 | 0.375               | 9.5  | 0.030                            | 0.8 | 200             | 61.1  | Black  | 1              | 2              |
| HSTTV75-T2  | 0.750            | 19.1 | 0.750              | 19.1 | 0.375               | 9.5  | 0.030                            | 0.8 | 200             | 61.1  | Red    | 1              | 2              |
| HSTTV75-T4  | 0.750            | 19.1 | 0.750              | 19.1 | 0.375               | 9.5  | 0.030                            | 0.8 | 200             | 61.1  | Yellow | 1              | 2              |
| HSTTV75-T6  | 0.750            | 19.1 | 0.750              | 19.1 | 0.375               | 9.5  | 0.030                            | 0.8 | 200             | 61.1  | Blue   | 1              | 2              |
| HSTTV100-T2 | 1.00             | 25.4 | 1.00               | 25.4 | 0.500               | 12.7 | 0.035                            | 0.9 | 200             | 61.1  | Red    | 1              | 2              |

## UL® SP® HSTTV Heat Shrink on 25 Foot Reels

- Applications include insulating and protecting wires and cables
- Fast shrink time
- Voltage: 600 V
- Shrink ratio: 2:1
- Flammability: Meets UL 224 VW-1
- UL Recognized, CSA Certified
- Mil Spec: AMS-DTL-23053/5 Class 3
- Temperature range: -67°F to 275°F (-55°C to 135°C)
- For dry locations
- Material: Black cross-linked Polyolefin



| Part Number | Nominal Diameter |      | Min. Expanded I.D. |      | Max. Recovered I.D. |      | Nominal Recovered Wall Thickness |     | Std. Pkg. Qty. | Std. Ctn. Qty. |
|-------------|------------------|------|--------------------|------|---------------------|------|----------------------------------|-----|----------------|----------------|
|             | In.              | mm   | In.                | mm   | In.                 | mm   | In.                              | mm  |                |                |
| HSTTV05-Q   | 0.046            | 1.2  | 0.046              | 1.2  | 0.023               | 0.6  | 0.016                            | 0.4 | 1              | 10             |
| HSTTV06-Q   | 0.063            | 1.6  | 0.063              | 1.6  | 0.031               | 0.8  | 0.017                            | 0.4 | 1              | 10             |
| HSTTV09-Q   | 0.093            | 2.4  | 0.093              | 2.4  | 0.046               | 1.2  | 0.020                            | 0.5 | 1              | 10             |
| HSTTV12-Q   | 0.125            | 3.2  | 0.125              | 3.2  | 0.062               | 1.6  | 0.020                            | 0.5 | 1              | 10             |
| HSTTV19-Q   | 0.187            | 4.8  | 0.187              | 4.8  | 0.093               | 2.4  | 0.020                            | 0.5 | 1              | 10             |
| HSTTV25-Q   | 0.250            | 6.4  | 0.250              | 6.4  | 0.125               | 3.2  | 0.025                            | 0.6 | 1              | 10             |
| HSTTV38-Q   | 0.375            | 9.5  | 0.375              | 9.5  | 0.187               | 4.8  | 0.025                            | 0.6 | 1              | 10             |
| HSTTV50-Q   | 0.500            | 12.7 | 0.500              | 12.7 | 0.250               | 6.4  | 0.025                            | 0.6 | 1              | 10             |
| HSTTV75-Q   | 0.750            | 19.1 | 0.750              | 19.1 | 0.375               | 9.5  | 0.030                            | 0.8 | 1              | 10             |
| HSTTV100-Q  | 1.00             | 25.4 | 1.00               | 25.4 | 0.500               | 12.7 | 0.035                            | 0.9 | 1              | 2              |

## UL® SP® HSTTV Heat Shrink 6 Inch Pieces

- Applications include insulating and protecting wires and cables
- Fast shrink time
- Voltage: 600 V
- Shrink ratio: 2:1
- Flammability: Meets UL 224 VW-1
- UL Recognized, CSA Certified
- Mil Spec: AMS-DTL-23053/5 Class 3
- Temperature range: -67°F to 275°F (-55°C to 135°C)
- For dry locations
- Material: Black cross-linked Polyolefin



| Part Number | Nominal Diameter / Size |      | Min. Expanded I.D. |      | Max. Recovered I.D. |      | Pieces Per Package | Std. Pkg. Qty. | Std. Ctn. Qty. |
|-------------|-------------------------|------|--------------------|------|---------------------|------|--------------------|----------------|----------------|
|             | In.                     | mm   | In.                | mm   | In.                 | mm   |                    |                |                |
| HSTTV05-Y   | 0.046                   | 1.2  | 0.046              | 1.2  | 0.023               | 0.6  | 26                 | 1              | 10             |
| HSTTV06-Y   | 0.063                   | 1.6  | 0.063              | 1.6  | 0.031               | 0.8  | 26                 | 1              | 10             |
| HSTTV09-Y   | 0.093                   | 2.4  | 0.093              | 2.4  | 0.046               | 1.2  | 24                 | 1              | 10             |
| HSTTV12-Y   | 0.125                   | 3.2  | 0.125              | 3.2  | 0.062               | 1.6  | 20                 | 1              | 10             |
| HSTTV19-Y   | 0.187                   | 4.8  | 0.187              | 4.8  | 0.093               | 2.4  | 18                 | 1              | 10             |
| HSTTV25-Y   | 0.250                   | 6.4  | 0.250              | 6.4  | 0.125               | 3.2  | 14                 | 1              | 10             |
| HSTTV38-Y   | 0.375                   | 9.5  | 0.375              | 9.5  | 0.187               | 4.8  | 12                 | 1              | 10             |
| HSTTV50-Y   | 0.500                   | 12.7 | 0.500              | 12.7 | 0.250               | 6.4  | 10                 | 1              | 10             |
| HSTTV75-Y   | 0.750                   | 19.1 | 0.750              | 19.1 | 0.375               | 9.5  | 8                  | 1              | 10             |
| HSTTV100-Y  | 1.00                    | 25.4 | 1.00               | 25.4 | 0.500               | 12.7 | 6                  | 1              | 10             |

A.  
System  
Overview

## HSTTP PVC Heat Shrink

B1.  
Cable Ties

- Applications include insulating and protecting wires and cables
- Good resistance to most fuels and oils
- Voltage: 600 V
- Shrink ratio: 2:1
- Flammability: Meets UL 224 VW-1

- UL Recognized, CSA Certified
- Temperature range: -4°F to 221°F (-20°C to 105°C)
- For dry locations
- Material: Black cross-linked Polyvinyl Chloride
- Mil Spec: AMS-DTL-23053/2 Class 1

B2.  
Cable  
Accessories



B3.  
Stainless  
Steel Ties

C1.  
Wiring  
Duct



C2.  
Surface  
Raceway

C3.  
Abrasion  
Protection

C4.  
Cable  
Management

D1.  
Terminals

D2.  
Power  
Connectors

D3.  
Grounding  
Connectors

E1.  
Labeling  
Systems

E2.  
Labels

E3.  
Pre-Printed  
& Write-On  
Markers

E4.  
Permanent  
Identification

E5.  
Lockout/  
Tagout  
& Safety  
Solutions

F.  
Index

| Part Number | Nominal Diameter |      | Min. Expanded I.D. |      | Max. Recovered I.D. |      | Nominal Recovered Wall Thickness |     | Length Per Reel |       | Std. Pkg. Qty. | Std. Ctn. Qty. |
|-------------|------------------|------|--------------------|------|---------------------|------|----------------------------------|-----|-----------------|-------|----------------|----------------|
|             | In.              | mm   | In.                | mm   | In.                 | mm   | In.                              | mm  | Ft.             | m     |                |                |
| HSTTP05-QY  | 0.046            | 1.2  | 0.046              | 1.2  | 0.023               | 0.6  | 0.02                             | 0.5 | 25              | 7.6   | 1              | 10             |
| HSTTP05-CY  | 0.046            | 1.2  | 0.046              | 1.2  | 0.023               | 0.6  | 0.02                             | 0.5 | 100             | 30.5  | 1              | 2              |
| HSTTP05-MY  | 0.046            | 1.2  | 0.046              | 1.2  | 0.023               | 0.6  | 0.02                             | 0.5 | 1000            | 304.8 | 1              | 2              |
| HSTTP06-QY  | 0.063            | 1.6  | 0.063              | 1.6  | 0.031               | 0.8  | 0.02                             | 0.5 | 25              | 7.6   | 1              | 10             |
| HSTTP06-CY  | 0.063            | 1.6  | 0.063              | 1.6  | 0.031               | 0.8  | 0.02                             | 0.5 | 100             | 30.5  | 1              | 2              |
| HSTTP06-MY  | 0.063            | 1.6  | 0.063              | 1.6  | 0.031               | 0.8  | 0.02                             | 0.5 | 1000            | 304.8 | 1              | 2              |
| HSTTP09-QY  | 0.093            | 2.4  | 0.093              | 2.4  | 0.046               | 1.2  | 0.025                            | 0.6 | 25              | 7.6   | 1              | 10             |
| HSTTP09-CY  | 0.093            | 2.4  | 0.093              | 2.4  | 0.046               | 1.2  | 0.025                            | 0.6 | 100             | 30.5  | 1              | 2              |
| HSTTP09-MY  | 0.093            | 2.4  | 0.093              | 2.4  | 0.046               | 1.2  | 0.025                            | 0.6 | 1000            | 304.8 | 1              | 2              |
| HSTTP12-QY  | 0.125            | 3.2  | 0.125              | 3.2  | 0.062               | 1.6  | 0.025                            | 0.6 | 25              | 7.6   | 1              | 10             |
| HSTTP12-CY  | 0.125            | 3.2  | 0.125              | 3.2  | 0.062               | 1.6  | 0.025                            | 0.6 | 100             | 30.5  | 1              | 2              |
| HSTTP12-MY  | 0.125            | 3.2  | 0.125              | 3.2  | 0.062               | 1.6  | 0.025                            | 0.6 | 1000            | 304.8 | 1              | 2              |
| HSTTP19-QY  | 0.187            | 4.8  | 0.187              | 4.8  | 0.093               | 2.4  | 0.025                            | 0.6 | 25              | 7.6   | 1              | 10             |
| HSTTP19-CY  | 0.187            | 4.8  | 0.187              | 4.8  | 0.093               | 2.4  | 0.025                            | 0.6 | 100             | 30.5  | 1              | 2              |
| HSTTP19-MY  | 0.187            | 4.8  | 0.187              | 4.8  | 0.093               | 2.4  | 0.025                            | 0.6 | 1000            | 304.8 | 1              | 2              |
| HSTTP25-QY  | 0.250            | 6.4  | 0.250              | 6.4  | 0.125               | 3.2  | 0.025                            | 0.6 | 25              | 7.6   | 1              | 10             |
| HSTTP25-CY  | 0.250            | 6.4  | 0.250              | 6.4  | 0.125               | 3.2  | 0.025                            | 0.6 | 100             | 30.5  | 1              | 2              |
| HSTTP25-DY  | 0.250            | 6.4  | 0.250              | 6.4  | 0.125               | 3.2  | 0.025                            | 0.6 | 500             | 152.4 | 1              | 2              |
| HSTTP38-QY  | 0.375            | 9.5  | 0.375              | 9.5  | 0.187               | 4.8  | 0.03                             | 0.8 | 25              | 7.6   | 1              | 10             |
| HSTTP38-CY  | 0.375            | 9.5  | 0.375              | 9.5  | 0.187               | 4.8  | 0.03                             | 0.8 | 100             | 30.5  | 1              | 2              |
| HSTTP38-TY  | 0.375            | 9.5  | 0.375              | 9.5  | 0.187               | 4.8  | 0.03                             | 0.8 | 200             | 61.0  | 1              | 2              |
| HSTTP50-QY  | 0.500            | 12.7 | 0.500              | 12.7 | 0.250               | 6.4  | 0.03                             | 0.8 | 25              | 7.6   | 1              | 10             |
| HSTTP50-CY  | 0.500            | 12.7 | 0.500              | 12.7 | 0.250               | 6.4  | 0.03                             | 0.8 | 100             | 30.5  | 1              | 2              |
| HSTTP75-QY  | 0.750            | 19.1 | 0.750              | 19.1 | 0.375               | 9.5  | 0.035                            | 0.9 | 25              | 7.6   | 1              | 10             |
| HSTTP75-CY  | 0.750            | 19.1 | 0.750              | 19.1 | 0.375               | 9.5  | 0.035                            | 0.9 | 100             | 30.5  | 1              | 2              |
| HSTTP100-QY | 1.00             | 25.4 | 1.00               | 25.4 | 0.500               | 12.7 | 0.04                             | 1.0 | 25              | 7.6   | 1              | 2              |
| HSTTP100-CY | 1.00             | 25.4 | 1.00               | 25.4 | 0.500               | 12.7 | 0.04                             | 1.0 | 100             | 30.5  | 1              | 2              |
| HSTTP150-QY | 1.50             | 38.1 | 1.50               | 38.1 | 0.750               | 19.1 | 0.045                            | 1.1 | 25              | 7.6   | 1              | 2              |
| HSTTP150-CY | 1.50             | 38.1 | 1.50               | 38.1 | 0.750               | 19.1 | 0.045                            | 1.1 | 100             | 30.5  | 1              | 2              |
| HSTTP200-QY | 2.00             | 50.8 | 2.00               | 50.8 | 1.00                | 25.4 | 0.05                             | 1.3 | 25              | 7.6   | 1              | 2              |

## UL® SP® HSTTPN Crystal Clear PVC Heat Shrink



- Low shrink temperature (store below 90°F) to speed installation
- Crystal clear material ensures easy to read labels and splice inspections
- Mil Spec: AMS-DTL-23053/2 Class 2
- Voltage: 600 V
- Highly flame retardant product manufactured from a material that is rated UL 224 VW-1
- Shrink ratio of 2:1 insulates a wide range of diameters and irregular shapes



| Part Number     | Nominal Diameter |      | Min. Expanded I.D. |      | Max. Recovered I.D. |      | Nominal Recovered Wall Thickness |     | Length |       | Length Per Reel |      | Std. Pkg. Qty. | Std. Ctn. Qty. |
|-----------------|------------------|------|--------------------|------|---------------------|------|----------------------------------|-----|--------|-------|-----------------|------|----------------|----------------|
|                 | In.              | mm   | In.                | mm   | In.                 | mm   | In.                              | mm  | In.    | mm    | Ft.             | m    |                |                |
| HSTTPN50-438-L  | 0.46             | 11.7 | 0.46               | 11.7 | 0.25                | 6.4  | 0.022                            | 0.6 | 4.38   | 111.3 | —               | —    | 50             | 500            |
| HSTTPN50-713-Q  | 0.46             | 11.7 | 0.46               | 11.7 | 0.25                | 6.4  | 0.022                            | 0.6 | 7.13   | 181.1 | —               | —    | 25             | 250            |
| HSTTPN62-750-Q  | 0.56             | 14.3 | 0.56               | 14.3 | 0.31                | 8.0  | 0.027                            | 0.7 | 7.50   | 190.5 | —               | —    | 25             | 250            |
| HSTTPN75-775-Q  | 0.70             | 17.7 | 0.70               | 17.7 | 0.38                | 9.5  | 0.027                            | 0.7 | 7.75   | 196.9 | —               | —    | 25             | 250            |
| HSTTPN100-775-Q | 0.90             | 22.9 | 0.90               | 22.9 | 0.50                | 12.7 | 0.030                            | 0.8 | 7.75   | 196.9 | —               | —    | 25             | 250            |
| HSTTPN150-925-X | 1.40             | 35.4 | 1.40               | 35.4 | 0.75                | 19.1 | 0.030                            | 0.8 | 9.25   | 235.0 | —               | —    | 10             | 100            |
| HSTTPN200-950-X | 1.80             | 45.7 | 1.80               | 45.7 | 1.00                | 25.4 | 0.039                            | 1.0 | 9.50   | 241.3 | —               | —    | 10             | 100            |
| HSTTPN50-CC     | 0.46             | 11.7 | 0.46               | 11.7 | 0.25                | 6.4  | 0.022                            | 0.6 | —      | —     | 100             | 30.5 | 1              | 2              |
| HSTTPN62-CC     | 0.56             | 14.3 | 0.56               | 14.3 | 0.31                | 8.0  | 0.027                            | 0.7 | —      | —     | 100             | 30.5 | 1              | 2              |
| HSTTPN75-CC     | 0.70             | 17.7 | 0.70               | 17.7 | 0.38                | 9.5  | 0.027                            | 0.7 | —      | —     | 100             | 30.5 | 1              | 2              |
| HSTTPN100-CC    | 0.90             | 22.9 | 0.90               | 22.9 | 0.50                | 12.7 | 0.030                            | 0.8 | —      | —     | 100             | 30.5 | 1              | 2              |
| HSTTPN150-CC    | 1.40             | 35.4 | 1.40               | 35.4 | 0.75                | 19.1 | 0.030                            | 0.8 | —      | —     | 100             | 30.5 | 1              | 2              |
| HSTTPN200-CC    | 1.80             | 45.7 | 1.80               | 45.7 | 1.00                | 25.4 | 0.039                            | 1.0 | —      | —     | 100             | 30.5 | 1              | 2              |

## HSTTN Neoprene Heat Shrink

- Applications include insulating, protecting, and color coding wires and cables
- Excellent chemical resistance especially to fuels and oils
- Voltage: 600 V
- Shrink ratio: 2:1
- Mil Spec: AMS-DTL-23053/1 Class 2
- Temperature range: -94°F to 250°F (-70°C to 121°C)
- For dry locations
- Material: Black cross-linked Neoprene



| Part Number | Nominal Diameter |      | Min. Expanded I.D. |      | Max. Recovered I.D. |      | Nominal Recovered Wall Thickness |     | Length per Reel |      | Std. Pkg. Qty. | Std. Ctn. Qty. |
|-------------|------------------|------|--------------------|------|---------------------|------|----------------------------------|-----|-----------------|------|----------------|----------------|
|             | In.              | mm   | In.                | mm   | In.                 | mm   | In.                              | mm  | Ft.             | m    |                |                |
| HSTTN25-CY  | 0.250            | 6.4  | 0.250              | 6.4  | 0.143               | 3.6  | 0.035                            | 0.9 | 100             | 30.5 | 1              | 2              |
| HSTTN38-CY  | 0.375            | 9.5  | 0.375              | 9.5  | 0.211               | 5.4  | 0.040                            | 1.0 | 100             | 30.5 | 1              | 2              |
| HSTTN50-CY  | 0.500            | 12.7 | 0.500              | 12.7 | 0.286               | 7.3  | 0.048                            | 1.2 | 100             | 30.5 | 1              | 2              |
| HSTTN63-CY  | 0.625            | 15.9 | 0.625              | 15.9 | 0.357               | 9.1  | 0.052                            | 1.3 | 100             | 30.5 | 1              | 2              |
| HSTTN75-CY  | 0.750            | 19.1 | 0.750              | 19.1 | 0.428               | 10.9 | 0.057                            | 1.5 | 100             | 30.5 | 1              | 2              |
| HSTTN88-CY  | 0.875            | 22.2 | 0.875              | 22.2 | 0.500               | 12.7 | 0.065                            | 1.7 | 100             | 30.5 | 1              | 2              |
| HSTTN100-CY | 1.00             | 25.4 | 1.00               | 25.4 | 0.570               | 14.5 | 0.070                            | 1.8 | 100             | 30.5 | 1              | 2              |
| HSTTN125-CY | 1.25             | 31.8 | 1.25               | 31.8 | 0.714               | 18.1 | 0.087                            | 2.2 | 100             | 30.5 | 1              | 2              |
| HSTTN150-CY | 1.50             | 38.1 | 1.50               | 38.1 | 0.857               | 21.8 | 0.095                            | 2.4 | 100             | 30.5 | 1              | 2              |
| HSTTN175-CY | 1.75             | 44.5 | 1.75               | 44.5 | 1.00                | 25.4 | 0.107                            | 2.7 | 100             | 30.5 | 1              | 1              |
| HSTTN200-QY | 2.00             | 50.8 | 2.00               | 50.8 | 1.14                | 29.0 | 0.110                            | 2.8 | 25              | 7.6  | 1              | 2              |
| HSTTN300-QY | 3.00             | 76.2 | 3.00               | 76.2 | 1.71                | 43.4 | 0.125                            | 3.8 | 25              | 7.6  | 1              | 2              |



A.  
System  
Overview

B1.  
Cable Ties

B2.  
Cable  
Accessories

B3.  
Stainless  
Steel Ties

C1.  
Wiring  
Duct

C2.  
Surface  
Raceway

C3.  
Abrasion  
Protection

C4.  
Cable  
Management

D1.  
Terminals

D2.  
Power  
Connectors

D3.  
Grounding  
Connectors

E1.  
Labeling  
Systems

E2.  
Labels

E3.  
Pre-Printed  
& Write-On  
Markers

E4.  
Permanent  
Identification

E5.  
Lockout/  
Tagout  
& Safety  
Solutions

F.  
Index

A.  
System  
Overview

## TFE Heat Shrink 4 Foot Pieces

B1.  
Cable Ties

- Applications include insulating and protecting wires and cables
- Voltage: 600 V
- Shrink ratio: 2:1

- Color: Opaque
- For dry locations
- Material: Polytetrafluoroethylene (TFE)
- High temperature; resists corrosive atmosphere
- See page C3.42 for shrink instructions

B2.  
Cable  
Accessories

- Mil Spec: AMS-DTL-23053/12 Class 3
- Temperature range: -88°F to 482°F (-67°C to 250°C)

B3.  
Stainless  
Steel Ties



C1.  
Wiring  
Duct

C2.  
Surface  
Raceway

C3.  
Abrasion  
Protection

C4.  
Cable  
Management

D1.  
Terminals

D2.  
Power  
Connectors

D3.  
Grounding  
Connectors

E1.  
Labeling  
Systems

E2.  
Labels

E3.  
Pre-Printed  
& Write-On  
Markers

E4.  
Permanent  
Identification

E5.  
Lockout/  
Tagout/  
& Safety  
Solutions

F.  
Index



| Part Number   | Nominal Diameter |      | Min. Expanded I.D. |      | Max. Recovered I.D. |      | Nominal Recovered Wall Thickness |     | Length |     | Std. Pkg. Qty. |
|---------------|------------------|------|--------------------|------|---------------------|------|----------------------------------|-----|--------|-----|----------------|
|               | In.              | mm   | In.                | mm   | In.                 | mm   | In.                              | mm  | Ft.    | m   |                |
| HSTTT03-48-Q  | 30 AWG           | 0.9  | 0.034              | 0.9  | 0.015               | 0.4  | 0.009                            | 0.2 | 4      | 1.2 | 25             |
| HSTTT04-48-Q  | 28 AWG           | 1.0  | 0.038              | 1.0  | 0.018               | 0.5  | 0.009                            | 0.2 | 4      | 1.2 | 25             |
| HSTTT046-48-Q | 26 AWG           | 1.2  | 0.046              | 1.2  | 0.022               | 0.5  | 0.010                            | 0.3 | 4      | 1.2 | 25             |
| HSTTT05-48-Q  | 24 AWG           | 1.3  | 0.050              | 1.3  | 0.027               | 0.7  | 0.010                            | 0.3 | 4      | 1.2 | 25             |
| HSTTT055-48-Q | 22 AWG           | 1.4  | 0.055              | 1.4  | 0.032               | 0.8  | 0.012                            | 0.3 | 4      | 1.2 | 25             |
| HSTTT06-48-Q  | 20 AWG           | 1.5  | 0.060              | 1.5  | 0.039               | 1.0  | 0.012                            | 0.3 | 4      | 1.2 | 25             |
| HSTTT08-48-Q  | 18 AWG           | 1.9  | 0.076              | 1.9  | 0.049               | 1.2  | 0.012                            | 0.3 | 4      | 1.2 | 25             |
| HSTTT09-48-Q  | 16 AWG           | 2.3  | 0.093              | 2.3  | 0.061               | 1.6  | 0.012                            | 0.3 | 4      | 1.2 | 25             |
| HSTTT12-48-Q  | 14 AWG           | 3.0  | 0.120              | 3.0  | 0.072               | 1.8  | 0.012                            | 0.3 | 4      | 1.2 | 25             |
| HSTTT15-48-Q  | 12 AWG           | 3.8  | 0.150              | 3.8  | 0.089               | 2.3  | 0.012                            | 0.3 | 4      | 1.2 | 25             |
| HSTTT19-48-Q  | 10 AWG           | 4.9  | 0.191              | 4.9  | 0.112               | 2.8  | 0.012                            | 0.3 | 4      | 1.2 | 25             |
| HSTTT24-48-Q  | 8 AWG            | 6.0  | 0.240              | 6.0  | 0.141               | 3.6  | 0.015                            | 0.4 | 4      | 1.2 | 25             |
| HSTTT30-48-Q  | 6 AWG            | 7.7  | 0.302              | 7.7  | 0.178               | 4.5  | 0.015                            | 0.4 | 4      | 1.2 | 25             |
| HSTTT37-48-Q  | 4 AWG            | 9.4  | 0.370              | 9.4  | 0.224               | 5.7  | 0.015                            | 0.4 | 4      | 1.2 | 25             |
| HSTTT43-48-Q  | 2 AWG            | 10.9 | 0.430              | 10.9 | 0.278               | 7.0  | 0.015                            | 0.4 | 4      | 1.2 | 25             |
| HSTTT47-48-Q  | 0 AWG            | 11.9 | 0.470              | 11.9 | 0.347               | 8.8  | 0.015                            | 0.4 | 4      | 1.2 | 25             |
| HSTTT56-48-5  | 9/16             | 14.2 | 0.560              | 14.2 | 0.399               | 10.1 | 0.015                            | 0.4 | 4      | 1.2 | 5              |
| HSTTT66-48-5  | 5/8              | 16.6 | 0.655              | 16.6 | 0.462               | 11.7 | 0.018                            | 0.5 | 4      | 1.2 | 5              |
| HSTTT75-48-5  | 3/4              | 19.1 | 0.750              | 19.0 | 0.524               | 13.3 | 0.018                            | 0.5 | 4      | 1.2 | 5              |
| HSTTT93-48-5  | 15/16            | 23.6 | 0.930              | 23.6 | 0.655               | 16.6 | 0.020                            | 0.5 | 4      | 1.2 | 5              |
| HSTTT112-48-5 | 1 1/8            | 28.6 | 1.12               | 28.6 | 0.786               | 20.0 | 0.025                            | 0.6 | 4      | 1.2 | 5              |
| HSTTT131-48-2 | 1 5/16           | 33.3 | 1.31               | 33.3 | 0.911               | 23.1 | 0.030                            | 0.8 | 4      | 1.2 | 2              |
| HSTTT150-48-2 | 1 1/2            | 38.1 | 1.50               | 38.1 | 1.036               | 26.3 | 0.030                            | 0.8 | 4      | 1.2 | 2              |



## **RU** **SP** HSTTK Kynar\* Heat Shrink 4 Foot Pieces

- Applications include insulating and protecting wires and cables
- Excellent chemical and abrasion resistance
- Use in high temperature or solvent rich environment
- Voltage: 600 V
- Shrink ratio: 2:1
- Flammability: Meets UL 224 VW-1
- Mil Spec: AMS-DTL-23053/8
- Temperature range: -67°F to 347°F (-55°C to 175°C)
- For dry locations
- Material: Clear Cross-linked Polyvinylidene Fluoride (PVDF)



| Part Number   | Nominal Diameter |      | Min. Expanded I.D. |      | Max. Recovered I.D. |      | Nominal Recovered Wall Thickness |     | Std. Pkg. Qty. |
|---------------|------------------|------|--------------------|------|---------------------|------|----------------------------------|-----|----------------|
|               | In.              | mm   | In.                | mm   | In.                 | mm   | In.                              | mm  |                |
| HSTTK05-48-Q  | 0.046            | 1.2  | 0.046              | 1.2  | 0.023               | 0.6  | 0.010                            | 0.3 | 25             |
| HSTTK06-48-Q  | 0.063            | 1.6  | 0.063              | 1.6  | 0.031               | 0.8  | 0.010                            | 0.3 | 25             |
| HSTTK09-48-Q  | 0.093            | 2.4  | 0.093              | 2.4  | 0.046               | 1.2  | 0.010                            | 0.3 | 25             |
| HSTTK12-48-Q  | 0.125            | 3.2  | 0.125              | 3.2  | 0.062               | 1.6  | 0.010                            | 0.3 | 25             |
| HSTTK19-48-Q  | 0.187            | 4.8  | 0.187              | 4.8  | 0.093               | 2.4  | 0.010                            | 0.3 | 25             |
| HSTTK25-48-Q  | 0.250            | 6.4  | 0.250              | 6.4  | 0.125               | 3.2  | 0.012                            | 0.3 | 25             |
| HSTTK38-48-Q  | 0.375            | 9.5  | 0.375              | 9.5  | 0.187               | 4.8  | 0.012                            | 0.3 | 25             |
| HSTTK50-48-5  | 0.500            | 12.7 | 0.500              | 12.7 | 0.250               | 6.4  | 0.012                            | 0.3 | 5              |
| HSTTK75-48-5  | 0.750            | 19.1 | 0.750              | 19.1 | 0.375               | 9.5  | 0.017                            | 0.4 | 5              |
| HSTTK100-48-5 | 1.00             | 25.4 | 1.00               | 25.4 | 0.500               | 12.7 | 0.019                            | 0.5 | 5              |

\*KYNAR is a registered trademark of Atofina Chemicals, Inc.

## **RU** HSTTVA Heat Shrink 4 Foot and 6 Inch Pieces

- Applications include insulating and protecting wires and cables
- Flexible tubing with an adhesive inner wall which seals and protects components from moisture and corrosion
- Voltage rating: 600 V
- Shrink ratio: 2:1
- Flammability: Outer wall flame retardant
- Mil Spec: AMS-DTL-23053/4 Class 2
- Temperature range: -67°F to 230°F (-55°C to 110°C)
- For damp locations
- Material: Adhesive lined black cross-linked Polyolefin



| Part Number              | Nominal Diameter |      | Min. Expanded I.D. |      | Max. Recovered I.D. |      | Nominal Recovered Wall Thickness |     | Std. Pkg. Qty. |
|--------------------------|------------------|------|--------------------|------|---------------------|------|----------------------------------|-----|----------------|
|                          | In.              | mm   | In.                | mm   | In.                 | mm   | In.                              | mm  |                |
| <b>4' (1.22m) Pieces</b> |                  |      |                    |      |                     |      |                                  |     |                |
| HSTTVA12-48-Q            | 0.125            | 3.2  | 0.125              | 3.2  | 0.062               | 1.6  | 0.021                            | 0.5 | 25             |
| HSTTVA19-48-Q            | 0.187            | 4.8  | 0.187              | 4.8  | 0.093               | 2.4  | 0.023                            | 0.6 | 25             |
| HSTTVA25-48-Q            | 0.250            | 6.4  | 0.250              | 6.4  | 0.125               | 3.2  | 0.029                            | 0.7 | 25             |
| HSTTVA38-48-Q            | 0.375            | 9.5  | 0.375              | 9.5  | 0.187               | 4.8  | 0.029                            | 0.7 | 25             |
| HSTTVA50-48-5            | 0.500            | 12.7 | 0.500              | 12.7 | 0.250               | 6.4  | 0.030                            | 0.8 | 5              |
| HSTTVA75-48-5            | 0.750            | 19.1 | 0.750              | 19.1 | 0.375               | 9.5  | 0.035                            | 0.9 | 5              |
| HSTTVA100-48-5           | 1.00             | 25.4 | 1.00               | 25.4 | 0.500               | 12.7 | 0.042                            | 1.1 | 5              |
| HSTTVA150-48-5           | 1.50             | 38.1 | 1.50               | 38.1 | 0.750               | 19.1 | 0.047                            | 1.2 | 5              |

Table continues on page C3.36

A. System Overview

B1. Cable Ties

B2. Cable Accessories

B3. Stainless Steel Ties

C1. Wiring Duct

C2. Surface Raceway

C3. Abrasion Protection

C4. Cable Management

D1. Terminals

D2. Power Connectors

D3. Grounding Connectors

E1. Labeling Systems

E2. Labels

E3. Pre-Printed & Write-On Markers

E4. Permanent Identification

E5. Lockout/Tagout & Safety Solutions

F. Index

A. System Overview

## HSTTVA Heat Shrink 4 Foot and 6 Inch Pieces (continued)

B1. Cable Ties

| Part Number                | Nominal Diameter |      | Min. Expanded I.D. |      | Max. Recovered I.D. |      | Nominal Recovered Wall Thickness |     | Std. Pkg. Qty. | Pieces per Package |
|----------------------------|------------------|------|--------------------|------|---------------------|------|----------------------------------|-----|----------------|--------------------|
|                            | In.              | mm   | In.                | mm   | In.                 | mm   | In.                              | mm  |                |                    |
| <b>6" (152.4mm) Pieces</b> |                  |      |                    |      |                     |      |                                  |     |                |                    |
| HSTTVA12-Y                 | 0.125            | 3.2  | 0.125              | 3.2  | 0.062               | 1.6  | 0.020                            | 0.5 | 1              | 7                  |
| HSTTVA19-Y                 | 0.187            | 4.8  | 0.187              | 4.8  | 0.093               | 2.4  | 0.022                            | 0.6 | 1              | 7                  |
| HSTTVA25-Y                 | 0.250            | 6.4  | 0.250              | 6.4  | 0.125               | 3.2  | 0.030                            | 0.8 | 1              | 5                  |
| HSTTVA38-Y                 | 0.375            | 9.5  | 0.375              | 9.5  | 0.187               | 4.8  | 0.031                            | 0.8 | 1              | 4                  |
| HSTTVA50-Y                 | 0.500            | 12.7 | 0.500              | 12.7 | 0.250               | 6.4  | 0.032                            | 0.8 | 1              | 4                  |
| HSTTVA75-Y                 | 0.750            | 19.1 | 0.750              | 19.1 | 0.375               | 9.5  | 0.037                            | 0.9 | 1              | 3                  |
| HSTTVA100-Y                | 1.00             | 25.4 | 1.00               | 25.4 | 0.500               | 12.7 | 0.046                            | 1.2 | 1              | 2                  |

B2. Cable Accessories

B3. Stainless Steel Ties

C1. Wiring Duct

## HSTTA Heat Shrink 4 Foot and 6 Inch Pieces

- Applications include insulating and protecting wires and cables
- Flexible tubing with an adhesive inner wall which seals and protects components from moisture and corrosion
- Voltage rating: 600 V
- Shrink ratio: 3:1
- Flammability: Outer wall flame retardant
- Mil Spec: AMS-DTL-23053/4 Class 3
- Temperature range: -67°F to 230°F (-55°C to 110°C)
- For damp locations
- Material: Adhesive lined black cross-linked Polyolefin



C2. Surface Raceway

C3. Abrasion Protection

C4. Cable Management



D1. Terminals

D2. Power Connectors

D3. Grounding Connectors

E1. Labeling Systems

E2. Labels

E3. Pre-Printed & Write-On Markers

E4. Permanent Identification

E5. Lockout/Tagout & Safety Solutions

F. Index

| Part Number              | Nominal Diameter |      | Min. Expanded I.D. |      | Max. Recovered I.D. |      | Nominal Recovered Wall Thickness |     | Std. Pkg. Qty. | Std. Ctn. Qty. |
|--------------------------|------------------|------|--------------------|------|---------------------|------|----------------------------------|-----|----------------|----------------|
|                          | In.              | mm   | In.                | mm   | In.                 | mm   | In.                              | mm  |                |                |
| <b>4' (1.22m) Pieces</b> |                  |      |                    |      |                     |      |                                  |     |                |                |
| HSTTA19-48-Q             | 0.187            | 4.8  | 0.187              | 4.8  | 0.062               | 1.6  | 0.040                            | 1.0 | 25             | —              |
| HSTTA25-48-Q             | 0.250            | 6.4  | 0.250              | 6.4  | 0.080               | 2.0  | 0.040                            | 1.0 | 25             | —              |
| HSTTA25-48-TL            | 0.250            | 6.4  | 0.250              | 6.4  | 0.080               | 2.0  | 0.040                            | 1.0 | 250            | —              |
| HSTTA38-48-Q             | 0.375            | 9.5  | 0.375              | 9.5  | 0.120               | 3.0  | 0.055                            | 1.4 | 25             | —              |
| HSTTA38-48-TL            | 0.375            | 9.5  | 0.375              | 9.5  | 0.120               | 3.0  | 0.055                            | 1.4 | 250            | —              |
| HSTTA50-48-5             | 0.500            | 12.7 | 0.500              | 12.7 | 0.160               | 4.1  | 0.070                            | 1.8 | 5              | —              |
| HSTTA50-48-T             | 0.500            | 12.7 | 0.500              | 12.7 | 0.160               | 4.1  | 0.070                            | 1.8 | 200            | —              |
| HSTTA75-48-5             | 0.750            | 19.1 | 0.750              | 19.1 | 0.250               | 6.4  | 0.085                            | 2.2 | 5              | —              |
| HSTTA75-48-C             | 0.750            | 19.1 | 0.750              | 19.1 | 0.250               | 6.4  | 0.085                            | 2.2 | 100            | —              |
| HSTTA100-48-5            | 1.00             | 25.4 | 1.00               | 25.4 | 0.320               | 8.1  | 0.100                            | 2.5 | 5              | —              |
| HSTTA100-48-L            | 1.00             | 25.4 | 1.00               | 25.4 | 0.320               | 8.1  | 0.100                            | 2.5 | 50             | —              |
| HSTTA150-48-5            | 1.50             | 38.1 | 1.50               | 38.1 | 0.510               | 12.9 | 0.100                            | 2.5 | 5              | —              |
| HSTTA150-48-Q            | 1.50             | 38.1 | 1.50               | 38.1 | 0.510               | 12.9 | 0.100                            | 2.5 | 25             | —              |

| Part Number                | Nominal Diameter |      | Min. Expanded I.D. |      | Max. Recovered I.D. |      | Nominal Recovered Wall Thickness |     | Std. Pkg. Qty. | Std. Ctn. Qty. | Pieces per Package |
|----------------------------|------------------|------|--------------------|------|---------------------|------|----------------------------------|-----|----------------|----------------|--------------------|
|                            | In.              | mm   | In.                | mm   | In.                 | mm   | In.                              | mm  |                |                |                    |
| <b>6" (152.4mm) Pieces</b> |                  |      |                    |      |                     |      |                                  |     |                |                |                    |
| HSTTA19-Y                  | 0.187            | 4.8  | 0.187              | 4.8  | 0.062               | 1.6  | 0.040                            | 1.0 | 1              | 10             | 6                  |
| HSTTA25-Y                  | 0.250            | 6.4  | 0.250              | 6.4  | 0.080               | 2.0  | 0.040                            | 1.0 | 1              | 10             | 4                  |
| HSTTA38-Y                  | 0.375            | 9.5  | 0.375              | 9.5  | 0.120               | 3.0  | 0.055                            | 1.4 | 1              | 10             | 3                  |
| HSTTA50-Y                  | 0.500            | 12.7 | 0.500              | 12.7 | 0.160               | 4.1  | 0.070                            | 1.8 | 1              | 10             | 3                  |
| HSTTA75-Y                  | 0.750            | 19.1 | 0.750              | 19.1 | 0.250               | 6.4  | 0.085                            | 2.2 | 1              | 10             | 2                  |
| HSTTA100-Y                 | 1.00             | 25.4 | 1.00               | 25.4 | 0.320               | 8.1  | 0.100                            | 2.5 | 1              | 10             | 2                  |
| HSTTA150-Y                 | 1.50             | 38.1 | 1.50               | 38.1 | 0.510               | 12.9 | 0.100                            | 2.5 | 1              | 10             | 1                  |

## HSTT4A Heat Shrink 4 Foot Pieces

- Applications include insulating and protecting oversized electrical and electronic components, cables, terminals and connectors
- Flexible tubing with an adhesive inner wall which seals and protects components from moisture and corrosion
- Voltage: 600 V
- Shrink ratio: 4:1

- Flammability: Flame retardant outer wall meets UL 224 VW-1
- Mil Spec: AMS-DTL-23053/4 Class 3
- Temperature range: -67°F to 257°F (-55°C to 125°C)
- For damp locations
- Material: Adhesive lined black cross-linked Polyolefin



| Part Number    | Nominal Diameter |      | Min. Expanded I.D. |      | Max. Recovered I.D. |      | Nominal Recovered Wall Thickness |      | Length |     | Std. Pkg. Qty. |
|----------------|------------------|------|--------------------|------|---------------------|------|----------------------------------|------|--------|-----|----------------|
|                | In.              | mm   | In.                | mm   | In.                 | mm   | In.                              | mm   | Ft.    | m   |                |
| HSTT4A15-48-Q  | 0.158            | 4.0  | 0.158              | 4.0  | 0.039               | 1.0  | 0.043                            | 1.10 | 4      | 1.2 | 25             |
| HSTT4A31-48-Q  | 0.315            | 8.0  | 0.315              | 8.0  | 0.079               | 2.0  | 0.043                            | 1.10 | 4      | 1.2 | 25             |
| HSTT4A47-48-Q  | 0.472            | 12.0 | 0.472              | 12.0 | 0.118               | 3.0  | 0.055                            | 1.40 | 4      | 1.2 | 25             |
| HSTT4A62-48-5  | 0.630            | 16.0 | 0.630              | 16.0 | 0.158               | 4.0  | 0.070                            | 1.80 | 4      | 1.2 | 5              |
| HSTT4A94-48-5  | 0.945            | 24.0 | 0.945              | 24.0 | 0.236               | 6.0  | 0.088                            | 2.25 | 4      | 1.2 | 5              |
| HSTT4A125-48-5 | 1.26             | 32.0 | 1.26               | 32.0 | 0.315               | 8.0  | 0.100                            | 2.54 | 4      | 1.2 | 5              |
| HSTT4A200-48-5 | 2.05             | 52.0 | 2.05               | 52.0 | 0.512               | 13.0 | 0.100                            | 2.54 | 4      | 1.2 | 5              |

## HSTTRA Heat Shrink 4 Foot Pieces

- Applications include insulating and protecting wires and cables
- Semi-rigid tubing with an adhesive inner wall seals and protects components from moisture and corrosion
- Voltage rating: 600 V
- Shrink ratio: 2.5:1 Minimum

- Mil Spec: AMS-DTL-23053/4 Class 1
- Temperature range: -67°F to 230°F (-55°C to 110°C)
- For damp locations
- Material: Adhesive lined black cross-linked Polyolefin



| Part Number    | Nominal Diameter |      | Min. Expanded I.D. |      | Max. Recovered I.D. |      | Nominal Recovered Wall Thickness |     | Std. Pkg. Qty. |
|----------------|------------------|------|--------------------|------|---------------------|------|----------------------------------|-----|----------------|
|                | In.              | mm   | In.                | mm   | In.                 | mm   | In.                              | mm  |                |
| HSTTRA12-48-Q  | 0.125            | 3.2  | 0.125              | 3.2  | 0.023               | 0.6  | 0.038                            | 1.0 | 25             |
| HSTTRA19-48-Q  | 0.187            | 4.8  | 0.187              | 4.8  | 0.060               | 1.5  | 0.043                            | 1.1 | 25             |
| HSTTRA25-48-Q  | 0.250            | 6.4  | 0.250              | 6.4  | 0.080               | 2.0  | 0.047                            | 1.2 | 25             |
| HSTTRA38-48-Q  | 0.375            | 9.5  | 0.375              | 9.5  | 0.135               | 3.4  | 0.050                            | 1.3 | 25             |
| HSTTRA50-48-5  | 0.500            | 12.7 | 0.500              | 12.7 | 0.195               | 5.0  | 0.055                            | 1.4 | 5              |
| HSTTRA75-48-5  | 0.750            | 19.1 | 0.750              | 19.1 | 0.313               | 8.0  | 0.065                            | 1.7 | 5              |
| HSTTRA100-48-5 | 1.00             | 25.4 | 1.00               | 25.4 | 0.400               | 10.2 | 0.075                            | 1.9 | 5              |

A. System Overview

B1. Cable Ties

B2. Cable Accessories

B3. Stainless Steel Ties

C1. Wiring Duct

C2. Surface Raceway

C3. Abrasion Protection

C4. Cable Management

D1. Terminals

D2. Power Connectors

D3. Grounding Connectors

E1. Labeling Systems

E2. Labels

E3. Pre-Printed & Write-On Markers

E4. Permanent Identification

E5. Lockout/Tagout & Safety Solutions

F. Index

A. System Overview

**UL** **RU** **CSA** **Thick Wall Polyolefin Heat Shrink**

B1. Cable Ties

- Applications include insulating and protecting wires and cables
- Adhesive-lined inner wall seals and protects against moisture
- Thick wall suitable for direct burial according to UL 486D and provides excellent protection
- Voltage rating: UL 486D Listed for 600 V 90°C continuous use
- Shrink ratio: 3:1
- Flammability: Flame retardant outer wall meets UL 224 VW-1

- UL Listed, UL Recognized and CSA Certified (Except HST3.0 and HST3.5)
- Mil Spec: AMS-DTL-23053/15
- Temperature range: -67°F to 230°F (-55°C to 110°C)
- For wet locations
- Suitable for outdoor, direct sunlight applications
- Material: Adhesive lined black and red cross-linked Polyolefin

B2. Cable Accessories

B3. Stainless Steel Ties



C1. Wiring Duct

C2. Surface Raceway

C3. Abrasion Protection

C4. Cable Management

D1. Terminals

D2. Power Connectors

D3. Grounding Connectors

E1. Labeling Systems

E2. Labels

E3. Pre-Printed & Write-On Markers

E4. Permanent Identification

E5. Lockout/Tagout & Safety Solutions

F. Index



| Part Number     | Min. Expanded I.D. |      | Max. Recovered I.D. |      | Nominal Recovered Wall Thickness |     | Length |        | Std. Pkg. Qty. | Std. Ctn. Qty. |
|-----------------|--------------------|------|---------------------|------|----------------------------------|-----|--------|--------|----------------|----------------|
|                 | In.                | mm   | In.                 | mm   | In.                              | mm  | In.    | mm     |                |                |
| HST0.4-3-Q2Y*   | 0.40               | 10.2 | 0.16                | 4.1  | 0.08                             | 2.0 | 3.0    | 76.2   | 25             | 100            |
| HST0.4-3-QY*    | 0.40               | 10.2 | 0.16                | 4.1  | 0.08                             | 2.0 | 3.0    | 76.2   | 25             | 100            |
| HST0.4-48-5-2Y* | 0.40               | 10.2 | 0.16                | 4.1  | 0.08                             | 2.0 | 48.0   | 1219.2 | 5              | 20             |
| HST0.4-48-5Y*   | 0.40               | 10.2 | 0.16                | 4.1  | 0.08                             | 2.0 | 48.0   | 1219.2 | 5              | 20             |
| HST0.4-6-3Y*    | 0.40               | 10.2 | 0.16                | 4.1  | 0.08                             | 2.0 | 6.0    | 152.4  | 3              | 30             |
| HST0.4-6-X2Y*   | 0.40               | 10.2 | 0.16                | 4.1  | 0.08                             | 2.0 | 6.0    | 152.4  | 10             | 100            |
| HST0.4-6-XY*    | 0.40               | 10.2 | 0.16                | 4.1  | 0.08                             | 2.0 | 6.0    | 152.4  | 10             | 100            |
| HST0.8-12-5-2Y* | 0.75               | 19.1 | 0.22                | 5.6  | 0.09                             | 2.3 | 12.0   | 304.8  | 5              | 50             |
| HST0.8-12-5Y*   | 0.75               | 19.1 | 0.22                | 5.6  | 0.09                             | 2.3 | 12.0   | 304.8  | 5              | 50             |
| HST0.8-48-5-2Y* | 0.75               | 19.1 | 0.22                | 5.6  | 0.09                             | 2.3 | 48.0   | 1219.2 | 5              | 20             |
| HST0.8-48-5Y*   | 0.75               | 19.1 | 0.22                | 5.6  | 0.09                             | 2.3 | 48.0   | 1219.2 | 5              | 20             |
| HST0.8-6-3Y*    | 0.75               | 19.1 | 0.22                | 5.6  | 0.09                             | 2.3 | 6.0    | 152.4  | 3              | 30             |
| HST0.8-6-X2Y*   | 0.75               | 19.1 | 0.22                | 5.6  | 0.09                             | 2.3 | 6.0    | 152.4  | 10             | 100            |
| HST0.8-6-XY*    | 0.75               | 19.1 | 0.22                | 5.6  | 0.09                             | 2.3 | 6.0    | 152.4  | 10             | 100            |
| HST0.8-9-X2Y*   | 0.75               | 19.1 | 0.22                | 5.6  | 0.09                             | 2.3 | 9.0    | 228.6  | 10             | 100            |
| HST0.8-9-XY*    | 0.75               | 19.1 | 0.22                | 5.6  | 0.09                             | 2.3 | 9.0    | 228.6  | 10             | 100            |
| HST1.1-12-5-2Y  | 1.10               | 27.9 | 0.38                | 9.5  | 0.12                             | 3.0 | 12.0   | 304.8  | 5              | 50             |
| HST1.1-12-5Y    | 1.10               | 27.9 | 0.38                | 9.5  | 0.12                             | 3.0 | 12.0   | 304.8  | 5              | 50             |
| HST1.1-48-5-2Y  | 1.10               | 27.9 | 0.38                | 9.5  | 0.12                             | 3.0 | 48.0   | 1219.2 | 5              | 20             |
| HST1.1-48-5Y    | 1.10               | 27.9 | 0.38                | 9.5  | 0.12                             | 3.0 | 48.0   | 1219.2 | 5              | 20             |
| HST1.1-6-3Y     | 1.10               | 27.9 | 0.38                | 9.5  | 0.12                             | 3.0 | 6.0    | 152.4  | 3              | 30             |
| HST1.1-6-X2Y    | 1.10               | 27.9 | 0.38                | 9.5  | 0.12                             | 3.0 | 6.0    | 152.4  | 10             | 100            |
| HST1.1-6-XY     | 1.10               | 27.9 | 0.38                | 9.5  | 0.12                             | 3.0 | 6.0    | 152.4  | 10             | 100            |
| HST1.1-9-2Y     | 1.10               | 27.9 | 0.38                | 9.5  | 0.12                             | 3.0 | 9.0    | 228.6  | 2              | 20             |
| HST1.1-9-X2Y    | 1.10               | 27.9 | 0.38                | 9.5  | 0.12                             | 3.0 | 9.0    | 228.6  | 10             | 100            |
| HST1.1-9-XY     | 1.10               | 27.9 | 0.38                | 9.5  | 0.12                             | 3.0 | 9.0    | 228.6  | 10             | 100            |
| HST1.5-12-1Y    | 1.50               | 38.1 | 0.50                | 12.7 | 0.16                             | 4.1 | 12.0   | 304.8  | 1              | 10             |
| HST1.5-12-5Y    | 1.50               | 38.1 | 0.50                | 12.7 | 0.16                             | 4.1 | 12.0   | 304.8  | 5              | 50             |
| HST1.5-48-5-2Y  | 1.50               | 38.1 | 0.50                | 12.7 | 0.16                             | 4.1 | 48.0   | 1219.2 | 5              | 15             |
| HST1.5-48-5Y    | 1.50               | 38.1 | 0.50                | 12.7 | 0.16                             | 4.1 | 48.0   | 1219.2 | 5              | 15             |
| HST1.5-9-XY     | 1.50               | 38.1 | 0.50                | 12.7 | 0.16                             | 4.1 | 9.0    | 228.6  | 10             | 100            |
| HST2.0-12-2Y    | 2.00               | 50.8 | 0.67                | 16.9 | 0.16                             | 4.1 | 12.0   | 304.8  | 2              | 20             |
| HST2.0-48-2Y    | 2.00               | 50.8 | 0.67                | 16.9 | 0.16                             | 4.1 | 48.0   | 1219.2 | 2              | 8              |
| HST2.0-9-5Y     | 2.00               | 50.8 | 0.67                | 16.9 | 0.16                             | 4.1 | 9.0    | 228.6  | 5              | 50             |
| HST2.7-12-2Y    | 2.70               | 68.6 | 0.87                | 22.1 | 0.16                             | 4.1 | 12.0   | 304.8  | 2              | 20             |
| HST2.7-48-2Y    | 2.70               | 68.6 | 0.87                | 22.1 | 0.16                             | 4.1 | 48.0   | 1219.2 | 2              | 8              |
| HST3.0-12-2     | 3.00               | 76.2 | 1.00                | 25.4 | 0.16                             | 4.1 | 12.0   | 304.8  | 2              | 20             |
| HST3.0-48-2     | 3.00               | 76.2 | 1.00                | 25.4 | 0.16                             | 4.1 | 48.0   | 1219.2 | 2              | 8              |
| HST3.5-12-2Y    | 3.50               | 88.9 | 1.20                | 30.5 | 0.16                             | 4.1 | 12.0   | 304.8  | 2              | 20             |
| HST3.5-48-2Y    | 3.50               | 88.9 | 1.20                | 30.5 | 0.16                             | 4.1 | 48.0   | 1219.2 | 2              | 6              |

\*Product meets performance requirements of AMS-DTL-23053/15; some dimensions differ from specification.

## Heat Shrink End Caps

- Applications include insulating and protecting wires and cables
- Adhesive lined inner wall seals and provides excellent protection against moisture
- Voltage rating of 600 V
- Shrink ratio: 2.5:1 (HSEC); 3:1 (HSECFR)
- Temperature range: -67°F to 230°F (-55°C to 110°C)
- For wet locations
- Material: Adhesive lined black cross-linked Polyolefin; HSECFR = Flame retardant

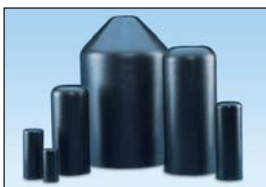

HSEC



HSECFR



| Part Number | Min. Expanded I.D. |       | Max. Recovered I.D. |      | Nominal Recovered Wall Thickness |     | Cap Length |       | Std. Pkg. Qty. | Std. Ctn. Qty. |
|-------------|--------------------|-------|---------------------|------|----------------------------------|-----|------------|-------|----------------|----------------|
|             | In.                | mm    | In.                 | mm.  | In.                              | mm  | In.        | mm    |                |                |
| HSEC0.5-X   | 0.47               | 11.9  | 0.18                | 4.6  | 0.10                             | 2.5 | 1.4        | 35.1  | 10             | 100            |
| HSEC0.8-X   | 0.79               | 20.1  | 0.30                | 7.6  | 0.10                             | 2.5 | 2.1        | 54.1  | 10             | 100            |
| HSEC1.0-X   | 1.02               | 25.9  | 0.45                | 11.4 | 0.10                             | 2.5 | 3.2        | 82.0  | 10             | 100            |
| HSEC1.5-5   | 1.58               | 40.1  | 0.68                | 17.3 | 0.11                             | 2.8 | 3.9        | 98.0  | 5              | 50             |
| HSEC2.0-5   | 2.25               | 57.2  | 0.87                | 22.1 | 0.15                             | 3.8 | 5.5        | 140.2 | 5              | 50             |
| HSEC4.0-2   | 4.14               | 105.2 | 1.78                | 45.2 | 0.15                             | 3.8 | 6.9        | 175.3 | 2              | 10             |

### Heat Shrink End Caps – Flame Retardant

|              |      |      |      |      |      |     |     |      |    |     |
|--------------|------|------|------|------|------|-----|-----|------|----|-----|
| HSECFR0.5-XY | 0.51 | 13.0 | 0.16 | 4.1  | 0.09 | 2.3 | 2.5 | 63.5 | 10 | 100 |
| HSECFR0.8-XY | 0.75 | 19.1 | 0.24 | 6.1  | 0.09 | 2.3 | 2.5 | 63.5 | 10 | 100 |
| HSECFR1.0-XY | 1.10 | 27.9 | 0.35 | 8.9  | 0.12 | 3.0 | 3.0 | 76.2 | 10 | 100 |
| HSECFR1.5-5Y | 1.50 | 38.1 | 0.47 | 11.9 | 0.16 | 4.1 | 3.5 | 88.9 | 5  | 50  |
| HSECFR2.0-5Y | 2.00 | 50.8 | 0.63 | 16.0 | 0.16 | 4.1 | 3.5 | 88.9 | 5  | 50  |

A. System Overview

B1. Cable Ties

B2. Cable Accessories

B3. Stainless Steel Ties

C1. Wiring Duct

C2. Surface Raceway

C3. Abrasion Protection

C4. Cable Management

D1. Terminals

D2. Power Connectors

D3. Grounding Connectors

E1. Labeling Systems

E2. Labels

E3. Pre-Printed & Write-On Markers

E4. Permanent Identification

E5. Lockout/Tagout & Safety Solutions

F. Index

A.  
System  
Overview

## Plastic Heat Shrink Tubing Kit Boxes – For Dry Locations

B1.  
Cable Ties



B2.  
Cable  
Accessories

B3.  
Stainless  
Steel Ties

C1.  
Wiring  
Duct

C2.  
Surface  
Raceway

C3.  
Abrasion  
Protection

C4.  
Cable  
Management

D1.  
Terminals

D2.  
Power  
Connectors

D3.  
Grounding  
Connectors

E1.  
Labeling  
Systems

E2.  
Labels

E3.  
Pre-Printed  
& Write-On  
Markers

E4.  
Permanent  
Identification

E5.  
Lockout/  
Tagout/  
& Safety  
Solutions

F.  
Index

| Part Number | Part Description  | Contents   | Std. Pkg. Qty. |
|-------------|---|--|----------------|
| KP-HSTT1    | Heat shrink kit box – plastic case, various sizes. Black only.                | 35 ea. of 3/32", 1/8"<br>21 ea. of 3/16", 1/4"<br>7 ea. of 3/8", 1/2"                                  | 1              |
| KP-HSTT2    | Heat shrink kit box – plastic case, various sizes, various colors.            | 35 ea. (5 ea. color) 3/32", 1/8"<br>21 ea. (3 ea. color) 3/16", 1/4"<br>7 ea. (1 ea. color) 3/8", 1/2" | 1              |
| KP-HSTTA    | Dual Wall Adhesive Lined Thin Wall Heat Shrink: Plastic Kit Box – Black only. | 14 ea. 3/16"<br>12 ea. 1/4"<br>10 ea. 3/8"<br>6 ea. 1/2"<br>3 ea. 3/4"<br>2 ea. 1"                     | 1              |



## Heat Shrink Tools and Accessories



| Part Number  | Part Description  | Std. Pkg. Qty. | Std. Ctn. Qty. |
|--------------|---|----------------|----------------|
| HSG-115V-650 | Heat gun with stand. Temperature range of 650°F (343°C) to 900°F (482°C) plus stand. (Case and accessories not included). | 1              | –              |
| HSG-A1       | Shrink tube reflector for tubing up to 3/4" inside diameter. Directs heat around tubing to reduce shrink time.            | 1              | 10             |
| HSG-A2       | Shrink tube reflector for tubing up to 1 1/2" inside diameter. Directs heat around tubing to reduce shrink time.          | 1              | 10             |
| HSG-A4       | Black polyethylene case stores heat gun, stand, and both accessories.   | 1              | –              |
| HSG-P1       | Replacement brush / spring kit.   | 1              | 5              |
| HSG-P2       | Replacement switch 20 Amp.  | 1              | 5              |
| HSG-P3       | Replacement bearing kit.  | 1              | 5              |
| HSG-P7       | Replacement heat element 650°F.   | 1              | –              |



## Heat Shrink Process Defined

### Extrusion/Material

Various thermoplastic materials that will repeatedly melt and flow, such as polyolefin, PVC, etc., are extruded into tube form. If examined at a molecular level, the material would resemble long thin strands weakly connected at various points by crystalline structure. If left in this state, the performance of the tube would be limited to that of the base material.

### Cross Linking

Cross-linking creates high strength bonds between the molecular strands, in addition to the crystalline bonds. This is done with a high voltage or chemical treatment of the material. The cross-link bonds will not break down with heat; this transforms the material from a thermoplastic to a thermoset material that will not melt and flow. The result is a material with superior electrical and mechanical properties.

### Expansion

The cross-linked tube is heated and the crystalline bonds dissolve, however, the cross-link bonds remain. The tube now is softer and can be expanded. This causes the cross-link bonds to stretch when cooled quickly, the crystalline bonds reform, freezing the tube in the expanded size. The tubing has now completed the manufacturing process.

### Recovery

With the proper type and size of tube selected, the tube is placed over the object to be covered. Heat is now applied. This causes the crystalline bonds to dissolve again and the tube softens. The stretched cross-link bonds now return to their original length and the tube shrinks to the diameter it had when cross-linked, unless it encounters an object larger than this diameter. In this case, it conforms tightly to this object.

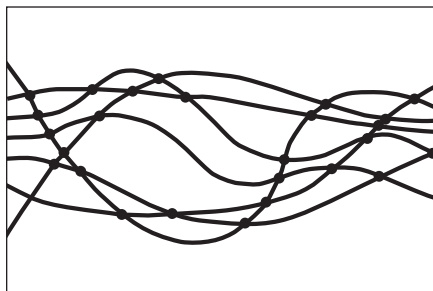

Extrusion

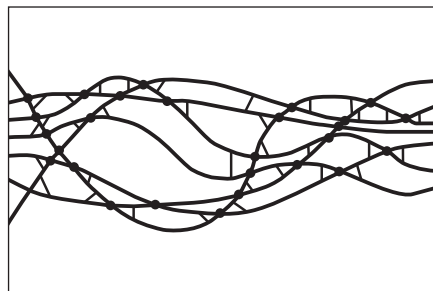

Cross-Link

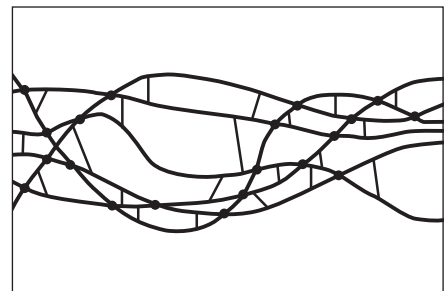

Expansion

A.  
System  
Overview

B1.  
Cable Ties

B2.  
Cable  
Accessories

B3.  
Stainless  
Steel Ties

C1.  
Wiring  
Duct

C2.  
Surface  
Raceway

C3.  
Abrasion  
Protection

C4.  
Cable  
Management

D1.  
Terminals

D2.  
Power  
Connectors

D3.  
Grounding  
Connectors

E1.  
Labeling  
Systems

E2.  
Labels

E3.  
Pre-Printed  
& Write-On  
Markers

E4.  
Permanent  
Identification

E5.  
Lockout/  
Tagout  
& Safety  
Solutions

F.  
Index

A.  
System  
Overview

## Heat Shrink Installation Instructions

B1.  
Cable Ties

### General Instructions

Position heat shrink over the object to be covered. Using a heat gun, soft yellow flame torch, infrared heat source or oven, evenly heat the tubing until it has fully recovered and conforms to the object. Use caution not to char or burn the tubing.

B2.  
Cable  
Accessories

### Special Instructions for HSTTT

TFE Heat Shrink is the most difficult to recover due to its high shrink temperature. TFE shrink tubing must be heated to the gel state 621°F (327°C) to completely recover. This can be recognized when the tubing changes from milky white to clear. Because of the unique characteristics of this material, a controlled temperature oven will achieve the most reliable results – it is difficult to consistently recover this product using a high-temp heat gun or similar heat source. These methods have a tendency to overheat the tube in one area while other areas remain cool.

B3.  
Stainless  
Steel Ties

C1.  
Wiring  
Duct

When recovering onto objects, use a temperature controlled oven set at 660°F – 680°F (349°C – 360°C) for approximately 10 minutes is recommended. It is best to place the product on a fiberglass mat or suspend as opposed to contacting the oven rack. Do NOT heat the product above 700°F (371°C), or degradation damage to the TFE polymer will occur.

C2.  
Surface  
Raceway

### Size Selection for Heat Shrink Tubing

Generally, the largest tube that shrinks down tightly onto an object should be chosen. This allows the heat shrink tubing maximum stress relief and this will yield the longest service life.

C3.  
Abrasion  
Protection

#### Example:

A multi-conductor cable needs to be covered with HSTT Type Dry-Shrink™ Heat Shrink. The area to be covered has a measured outside diameter of .700" (17.8mm). The two possibilities are HSTT75-48-5 and HSTT100-48-5.

C4.  
Cable  
Management

| Part Number  | Expanded I.D<br>In. (mm) | Recovered I.D.<br>In. (mm) |
|--------------|--------------------------|----------------------------|
| HSTT75-48-5  | .750 (19.1)              | .375 (9.5)                 |
| HSTT100-48-5 | 1.00 (25.4)              | .500 (12.7)                |

D1.  
Terminals

D2.  
Power  
Connectors

The proper choice is HSTT100-48-5 since the tube will recover more than HSTT75-48-5. The HSTT75-48-5 will fit over the .700 inch (17.8mm) outside diameter; however, this is not the proper choice since it is smaller than the HSTT100-48-5. In general, heat shrink should recover at least 10% – 20% to reduce stress and yield the longest service life.

D3.  
Grounding  
Connectors

E1.  
Labeling  
Systems

E2.  
Labels

E3.  
Pre-Printed  
& Write-On  
Markers

E4.  
Permanent  
Identification

E5.  
Lockout/  
Tagout  
& Safety  
Solutions

F.  
Index

## Recommended Tubing Size for Common Wire Types Based on Location For Insulated Wire, Non-Insulated Wire, and Insulated Wire with Copper Connectors

### Instructions for Tube Selection:

1) Determine location type.

#### LOCATION:

**DRY:** A location not normally subject to dampness or wetness. A location classified as dry may be temporarily subject to dampness or wetness, as in the case of a building under construction.

**DAMP:** Partially protected locations under canopies, marquees, roofed open porches and like locations, and interior locations subject to moderate degrees of moisture, such as some basements, barns, and cold-storage warehouses.

**WET:** Installations underground or in concrete slabs or masonry in direct contact with the earth, and locations subject to saturation with water or other liquids, such as vehicle washing areas, and locations exposed to weather and unprotected.

- 2) Match wire size to location type under required application – insulated wire, non-insulated wire, or insulated wire with copper connectors.
- 3) Read corresponding part number.
- 4) Part numbers with “-Y” are packages containing 6 inch pieces. Part numbers with “-48” are 48 inch pieces.
- 5) Part numbers shown below are for black heat shrink.

| Wire Size | Insulated Wire with Copper Connector |              |              | Uninsulated Wire |              |              |
|-----------|--------------------------------------|--------------|--------------|------------------|--------------|--------------|
|           | Dry-Shrink™                          | Damp-Shrink™ | Wet-Shrink™  | Dry-Shrink™      | Damp-Shrink™ | Wet-Shrink™  |
| 24        | HSTT09-Y                             | HSTTA19-Y    | —            | —                | —            | —            |
| 22        | HSTT09-Y                             | HSTTA19-Y    | —            | HSTT05-Y         | —            | —            |
| 20        | HSTT12-Y                             | HSTTA19-Y    | —            | HSTT05-Y         | —            | —            |
| 18        | HSTT12-Y                             | HSTTA19-Y    | —            | HSTT06-Y         | —            | —            |
| 16        | HSTT19-Y                             | HSTTA25-Y    | —            | HSTT09-Y         | —            | —            |
| 14        | HSTT19-Y                             | HSTTA25-Y    | —            | HSTT09-Y         | HSTTA19-Y    | —            |
| 12        | HSTT25-Y                             | HSTTA38-Y    | —            | HSTT012-Y        | HSTTA19-Y    | —            |
| 10        | HSTT25-Y                             | HSTTA38-Y    | HST0.4-48-5Y | HSTT19-Y         | HSTTA25-Y    | —            |
| 8         | HSTT38-Y                             | HSTTA50-Y    | HST0.4-48-5Y | HSTT19-Y         | HSTTA25-Y    | —            |
| 6         | HSTT50-Y                             | HSTTA50-Y    | HST0.8-48-5Y | HSTT25-Y         | HSTTA38-Y    | HST0.4-48-5Y |
| 4         | HSTT50-Y                             | HSTTA75-Y    | HST0.8-48-5Y | HSTT38-Y         | HSTTA50-Y    | HST0.4-48-5Y |
| 3         | HSTT50-Y                             | HSTTA75-Y    | HST0.8-48-5Y | HSTT38-Y         | HSTTA50-Y    | HST0.4-48-5Y |
| 2         | HSTT75-Y                             | HSTTA100-Y   | HST1.1-48-5Y | HSTT38-Y         | HSTTA50-Y    | HST0.8-48-5Y |
| 1         | HSTT75-Y                             | HSTTA100-Y   | HST1.1-48-5Y | HSTT50-Y         | HSTTA75-Y    | HST0.8-48-5Y |
| 1/0       | HSTT75-Y                             | HSTTA100-Y   | HST1.1-48-5Y | HSTT50-Y         | HSTTA75-Y    | HST0.8-48-5Y |
| 2/0       | HSTT100-Y                            | HSTTA150-Y   | HST1.5-48-5Y | HSTT50-Y         | HSTTA100-Y   | HST0.8-48-5Y |
| 3/0       | HSTT100-Y                            | HSTTA150-Y   | HST1.5-48-5Y | HSTT75-Y         | HSTTA100-Y   | HST1.1-48-5Y |
| 4/0       | HSTT100-Y                            | HSTTA150-Y   | HST1.5-48-5Y | HSTT75-Y         | HSTTA100-Y   | HST1.1-48-5Y |
| 250       | HSTT100-Y                            | HSTTA150-Y   | HST2.0-48-2Y | HSTT100-Y        | HSTTA100-Y   | HST1.1-48-5Y |
| 300       | HSTT150-48-5                         | HSTTA150-Y   | HST2.0-48-2Y | HSTT100-Y        | HSTTA150-Y   | HST1.5-48-5Y |
| 350       | HSTT150-48-5                         | HSTTA150-Y   | HST2.0-48-2Y | HSTT100-Y        | HSTTA150-Y   | HST1.5-48-5Y |
| 400       | HSTT150-48-5                         | HSTTA150-Y   | HST2.0-48-2Y | HSTT100-Y        | HSTTA150-Y   | HST1.5-48-5Y |
| 500       | HSTT150-48-5                         | HSTTA150-Y   | HST2.0-48-2Y | HSTT100-Y        | HSTTA150-Y   | HST1.5-48-5Y |
| 600       | HSTT200-48-5                         | HSTTA150-Y   | HST2.0-48-2Y | HSTT150-48-5     | HSTTA150-Y   | HST2.0-48-2Y |
| 700       | HSTT200-48-5                         | HSTTA150-Y   | HST2.0-48-2Y | HSTT150-48-5     | HSTTA150-Y   | HST2.0-48-2Y |
| 750       | HSTT200-48-5                         | HSTTA150-Y   | HST3.0-48-2Y | HSTT150-48-5     | HSTTA150-Y   | HST2.0-48-2Y |
| 800       | HSTT200-48-5                         | HSTTA150-Y   | HST3.0-48-2Y | HSTT150-48-5     | HSTTA150-Y   | HST2.0-48-2Y |
| 900       | HSTT200-48-5                         | —            | HST3.0-48-2Y | HSTT150-48-5     | HSTTA150-Y   | HST2.0-48-2Y |
| 1000      | HSTT200-48-5                         | —            | HST3.0-48-2Y | HSTT150-48-5     | HSTTA150-Y   | HST2.0-48-2Y |
| 1250      | HSTT200-48-2                         | —            | HST3.0-48-2Y | HSTT200-48-5     | HSTTA150-Y   | HST2.0-48-2Y |
| 1500      | HSTT300-48-2                         | —            | HST3.0-48-2Y | HSTT200-48-5     | —            | HST2.0-48-2Y |
| 1750      | HSTT300-48-2                         | —            | HST3.0-48-2Y | HSTT200-48-5     | —            | HST2.0-48-2Y |
| 2000      | HSTT300-48-2                         | —            | HST3.0-48-2Y | HSTT200-48-5     | —            | HST2.0-48-2Y |

Sizing information is based on the following wire types: MTW, THHN, THWN, TFN, THW, TW, TF, RHW, RH, RHH and UL 1015.

THHN is the most common wire type.

Portions reprinted with permission from NFPA, the National Electrical Code\* Handbook, Copyright 1996, National Fire Protection Association, Quincy, MA 02269.

\*All rights reserved. National Electrical Code and NEC are registered trademarks of the National Fire Protection Association, Inc., Quincy, MA 02269.

A.  
System  
Overview

B1.  
Cable Ties

B2.  
Cable  
Accessories

B3.  
Stainless  
Steel Ties

C1.  
Wiring  
Duct

C2.  
Surface  
Raceway

C3.  
Abrasion  
Protection

C4.  
Cable  
Management

D1.  
Terminals

D2.  
Power  
Connectors

D3.  
Grounding  
Connectors

E1.  
Labeling  
Systems

E2.  
Labels

E3.  
Pre-Printed  
& Write-On  
Markers

E4.  
Permanent  
Identification

E5.  
Lockout/  
Tagout  
& Safety  
Solutions

F.  
Index

## Dry-Shrink™, Damp-Shrink™, and Wet-Shrink™ Heat Shrink Tubing

### Technical Data

#### General Information

| Product Type  | Typical Applications   | Specific Gravity                           | Flammability  | Water Absorption          | Dielectric Strength   |
|---------------|--|--|---|---------------------------|---|
| <b>HSTT</b>   | Economical and easy way to insulate, protect, harness and identify electrical and electronic components in a wide variety of applications. Black is U.V. Resistant. Suitable for use in dry locations.   | Class 1, 1.35<br>Class 2, 1.0<br>ASTM D792 | Class 1 Self Extinguishing<br>ASTM D2671<br>Procedure B | .5% MAX.<br>ASTM<br>D570  | 500 V/MIL.<br>(19.7 Kv/mm) min.<br>ASTM D2671   |
| <b>HSTTV</b>  | Use where UL recognition with VW-1 rating is required. Use where the wire component cannot tolerate higher shrink temperatures, reduces application time to insulate, protect, identify, etc. Black is U.V. Resistant. Suitable for use in dry locations.                      | 1.50<br>ASTM D792                          | VW-1 per UL 224   | .5% MAX.<br>ASTM<br>D570  | 500 V/MIL.<br>(19.7 Kv/mm) min.<br>ASTM D2671   |
| <b>HSTTP</b>  | Ripple free conformance around sharp bends as in appliance handles and bus bars. Good cut through and solder-iron resistance. Black is U.V. Resistant. Suitable for use in dry locations.  | 1.35 MAX.                                  | VW-1 per UL 224   | 1.0% MAX.<br>ASTM<br>D570 | 400 V/MIL.<br>(15.8 Kv/mm) min.<br>ASTM D2671   |
| <b>HSTTPN</b> | Crystal clear product that is excellent for protecting wire and cable markers and continuous inspection of splices. Suitable for use in dry locations.   | N/A  | VW-1 per UL 224   | 1.0% MAX.<br>ASTM<br>D570 | 400 V/MIL.<br>(15.8 Kv/mm) min.<br>ASTM D2671   |
| <b>HSTTN</b>  | Insulation and abrasion resistance, extensive military uses on vehicles and ship-board. Excellent chemical resistance especially to fuels and oils. Black is U.V. Resistant. Suitable for use in dry locations.  | 1.30<br>ASTM<br>D792                       | Self Extinguishing<br>ASTM D876                         | 1.0% MAX.<br>ASTM<br>D570 | 300 V/MIL.<br>(11.8 Kv/mm) min.<br>ASTM D2671   |
| <b>HSTTT</b>  | High insulation and abrasion resistance. High temperature, strain relief, resists corrosive atmosphere, self lubrication and non-wetting. Can be used with fiber optics and as a strain relief for high density connectors. U.V. Resistant. Suitable for use in dry locations. | 2.2 MAX.<br>ASTM<br>D792                   | VW-1 per UL 224   | .01% MAX.<br>ASTM<br>D570 | 800 V/MIL.<br>(31.5 Kv/mm) min.<br>ASTM D2671   |
| <b>HSTTK</b>  | Protection and strain relief for wires or connectors in a high temperature or solvent rich environment. Insulation of heater leads. Suitable for use in dry locations.   | 1.8 MAX.<br>ASTM<br>D792                   | VW-1 per UL 224   | .5% MAX.<br>ASTM<br>D570  | Size to (12.7mm)<br>800 V/MIL.<br>(31.5 Kv/mm) min<br>Over (12.7mm)<br>600 V/MIL.<br>(23.6 Kv/mm) min<br>ASTM D2671 |
| <b>HSTTVA</b> | Seals and protects components from moisture and corrosion. Use where a flexible tubing is needed. Suitable for damp locations.   | N/A  | Self Extinguishing<br>ASTM D2671<br>Procedure B         | .5% MAX.<br>ASTM<br>D570  | 500 V/MIL.<br>(19.7 Kv/mm) min.<br>ASTM D2671   |
| <b>HSTTA</b>  | Environmentally seals and protects components. The 3:1 shrink ratio is a benefit when working with connector to cable transitions. Suitable for damp locations.  | N/A  | Self Extinguishing<br>ASTM D2671<br>Procedure B         | 1.0% MAX.<br>ASTM<br>D570 | 300 V/MIL.<br>(11.8 Kv/mm) min.<br>ASTM D2671   |
| <b>HSTT4A</b> | Seals and protects components from moisture and corrosion. The 4:1 shrink ratio is a benefit when working with large transitions. Use where a flexible tubing is needed. Suitable for damp locations.  | N/A  | VW-1 per UL 224   | 1.0% MAX.<br>ASTM<br>D570 | 500 V/MIL.<br>(19.7 Kv/mm) min.<br>ASTM D2671   |
| <b>HSTTRA</b> | Environmentally seals and protects components forming a rugged and heavy duty covering. The 2.5:1 shrink ratio is a benefit when working with connector to cable transitions. Suitable for damp locations.   | N/A  | N/A   | .5% MAX.<br>ASTM<br>D570  | 500 V/MIL.<br>(19.7 Kv/mm) min.<br>ASTM D2671   |
| <b>HST</b>    | Seals and protects electrical connections and splices above or below ground, 3:1 shrink ratio. Suitable for outdoor and wet locations.   | 1.2 MAX.                                   | VW-1 per UL 224   | .5% MAX.<br>ASTM<br>D570  | 200 V/MIL.<br>(7.9 Kv/mm) min.<br>ASTM D2671  |

## CABLE MANAGEMENT

Panduit offers a complete line of cable management products and accessories to route and secure cable. These products are an essential part of a clean, professional installation, which help improve quality and increase system performance.



- Maintains bend radius control and cable performance while bundling and securing cable to prevent snags and stress from over bending
- Provides attractive installations and allows for easier moves, adds, and changes while reducing stress on cable
- Organizes cable in a variety of applications where depth is critical or space is limited

Panduit solutions provide the options necessary to handle the most demanding installations while providing the flexibility to facilitate system upgrades now and in the future.

A.  
System  
Overview

B1.  
Cable Ties

B2.  
Cable  
Accessories

B3.  
Stainless  
Steel Ties

C1.  
Wiring  
Duct

C2.  
Surface  
Raceway

C3.  
Abrasion  
Protection

C4.  
Cable  
Management

D1.  
Terminals

D2.  
Power  
Connectors

D3.  
Grounding  
Connectors

E1.  
Labeling  
Systems

E2.  
Labels

E3.  
Pre-Printed  
& Write-On  
Markers

E4.  
Permanent  
Identification

E5.  
Lockout/  
Tagout  
& Safety  
Solutions

F.  
Index

A. System Overview

## Cool Boot™ Raised Floor Assembly PATENTED

B1. Cable Ties

B2. Cable Accessories

B3. Stainless Steel Ties

C1. Wiring Duct

C2. Surface Raceway

C3. Abrasion Protection

C4. Cable Management

- Patented design with air tight fabric minimizes bypass of air through cutouts in the raised floor to decrease energy costs in hot aisle/cold aisle data center designs
- Ultra-Cinch™ Tie closes top of fabric to prevent air from escaping around cable bundles
- Electrostatic dissipative material provides a pathway to ground reducing the chance of damaging network equipment with electric shock
- Vertical Hook and Loop Cable Tie closure system allows for installation on existing cable bundles
- Horizontal Hook and Loop Cable Tie closure system allows two or more bundles to be separated in existing or new installations

- Flexible polycarbonate outer ring houses fabric to allow user to secure product to raised floor tile; slit allows outer ring to flex so entire cable bundle can be inserted to allow for retrofit installations even when vertical cable managers are already in place
- Low profile polycarbonate outer ring allows compatibility with vertical cable managers
- Self-tapping #6 screws (included) allow a secure fastening method to top of raised floor tile that also provides a pathway to ground
- Color: Black polycarbonate outer ring with navy blue fabric
- Manufactured from flame retardant material



RFG\*X\*SMY

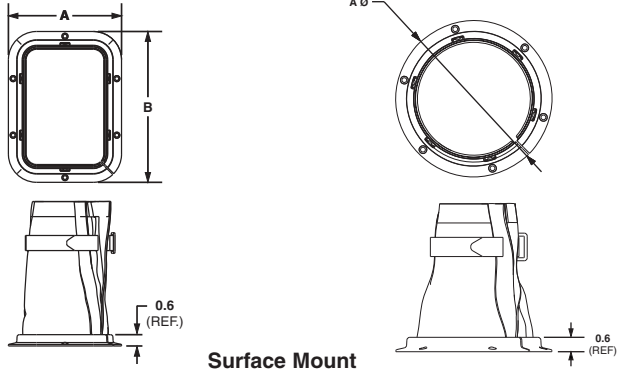

| Part Number          | Material   | Length |       | Width |       | Diameter |       | Max. Bundle Diameter |               | Std. Pkg. Qty. | Std. Ctn. Qty. |
|----------------------|--|--------|-------|-------|-------|----------|-------|----------------------|---------------|----------------|----------------|
|                      |  | In.    | mm    | In.   | mm    | In.      | mm    | In.                  | mm            |                |                |
| <b>Surface Mount</b> |  |        |       |       |       |          |       |                      |               |                |                |
| <b>RFG6X8SMY</b>     | Flame Retardant Electrostatic Dissipative Polycarbonate with an Electrostatic Dissipative Fabric | 8.0    | 203.2 | 6.0   | 152.4 | —        | —     | 4.2 x 6.2            | 106.7 x 157.4 | 1              | 10             |
| <b>RFG8X8SMY</b>     | Flame Retardant Electrostatic Dissipative Polycarbonate with an Electrostatic Dissipative Fabric | 8.0    | 203.2 | 8.0   | 203.2 | —        | —     | 6.2 x 6.2            | 157.4 x 157.4 | 1              | 10             |
| <b>RFG10X8SMY</b>    | Flame Retardant Electrostatic Dissipative Polycarbonate with an Electrostatic Dissipative Fabric | 8.0    | 203.2 | 10.0  | 254.0 | —        | —     | 8.2 x 6.2            | 208.3 x 157.4 | 1              | 10             |
| <b>RFG12X4SMY</b>    | Flame Retardant Electrostatic Dissipative Polycarbonate with an Electrostatic Dissipative Fabric | 4.0    | 101.6 | 12.0  | 304.8 | —        | —     | 10.2 x 2.2           | 259.1 x 55.9  | 1              | 10             |
| <b>RFG12X8SMY</b>    | Flame Retardant Electrostatic Dissipative Polycarbonate with an Electrostatic Dissipative Fabric | 8.0    | 203.2 | 12.0  | 304.8 | —        | —     | 10.2 x 6.2           | 259.1 x 157.4 | 1              | 10             |
| <b>RFG3DSMY</b>      | Flame Retardant Electrostatic Dissipative Polycarbonate with an Electrostatic Dissipative Fabric | —      | —     | —     | —     | 4.5      | 114.3 | 2.7                  | 68.6          | 1              | 10             |
| <b>RFG5DSMY</b>      | Flame Retardant Electrostatic Dissipative Polycarbonate with an Electrostatic Dissipative Fabric | —      | —     | —     | —     | 6.5      | 165.1 | 4.7                  | 119.4         | 1              | 10             |

Product complies with Article 645 Section 5(D)(4) of the 2005 National Electrical Code.  
 Compatible with NetRunner™ and PatchRunner™ Cable Managers, and Panduit Net-Access™ and NetServ™ Cabinets to create a complete cable management system.

\*Integral products include a flexible sub-grommet to prevent damage to cable from sharp edges of cut floor tile.



## Cool Boot™ Raised Floor Assembly (continued)



RFG\*X\*Y

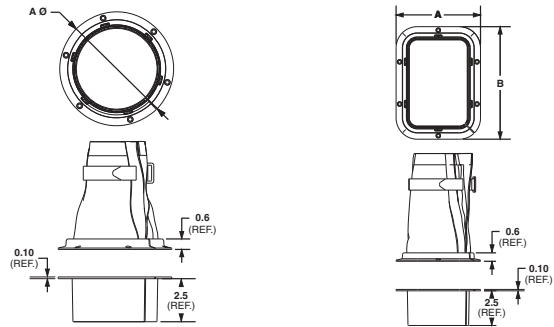

Integral Mount

| Part Number            | Material   | Length |       | Width |       | Diameter |       | Max. Bundle Diameter |               | Std. Pkg. Qty. | Std. Ctn. Qty. |
|------------------------|--|--------|-------|-------|-------|----------|-------|----------------------|---------------|----------------|----------------|
|                        |  | In.    | mm    | In.   | mm    | In.      | mm    | In.                  | mm            |                |                |
| <b>Integral Mount*</b> |  |        |       |       |       |          |       |                      |               |                |                |
| <b>RFG6X8Y</b>         | Flame Retardant Electrostatic Dissipative Polycarbonate with an Electrostatic Dissipative Fabric and Thermoplastic Elastomer | 8.0    | 203.2 | 6.0   | 152.4 | —        | —     | 4.2 x 6.2            | 106.7 x 157.4 | 1              | 10             |
| <b>RFG8X8Y</b>         | Flame Retardant Electrostatic Dissipative Polycarbonate with an Electrostatic Dissipative Fabric and Thermoplastic Elastomer | 8.0    | 203.2 | 8.0   | 203.2 | —        | —     | 6.2 x 6.2            | 157.4 x 157.4 | 1              | 10             |
| <b>RFG10X8Y</b>        | Flame Retardant Electrostatic Dissipative Polycarbonate with an Electrostatic Dissipative Fabric and Thermoplastic Elastomer | 8.0    | 203.2 | 10.0  | 254.0 | —        | —     | 8.2 x 6.2            | 208.3 x 157.4 | 1              | 10             |
| <b>RFG12X4Y</b>        | Flame Retardant Electrostatic Dissipative Polycarbonate with an Electrostatic Dissipative Fabric and Thermoplastic Elastomer | 4.0    | 101.6 | 12.0  | 304.8 | —        | —     | 10.2 x 2.2           | 259.1 x 55.9  | 1              | 10             |
| <b>RFG12X8Y</b>        | Flame Retardant Electrostatic Dissipative Polycarbonate with an Electrostatic Dissipative Fabric and Thermoplastic Elastomer | 8.0    | 203.2 | 12.0  | 304.8 | —        | —     | 10.2 x 6.2           | 259.1 x 157.4 | 1              | 10             |
| <b>RFG3DY</b>          | Flame Retardant Electrostatic Dissipative Polycarbonate with an Electrostatic Dissipative Fabric and Thermoplastic Elastomer | —      | —     | —     | —     | 4.5      | 114.3 | 3.0                  | 68.6          | 1              | 10             |
| <b>RFG5DY</b>          | Flame Retardant Electrostatic Dissipative Polycarbonate with an Electrostatic Dissipative Fabric and Thermoplastic Elastomer | —      | —     | —     | —     | 6.5      | 165.1 | 4.7                  | 119.4         | 1              | 10             |

Product complies with Article 645 Section 5(D)(4) of the 2005 National Electrical Code.

Compatible with NetRunner™ and PatchRunner™ Cable Managers, and Panduit Net-Access™ and NetServ™ Cabinets to create a complete cable management system.

\*Integral products include a flexible sub-grommet to prevent damage to cable from sharp edges of cut floor tile.

A.  
System  
Overview

B1.  
Cable Ties

B2.  
Cable  
Accessories

B3.  
Stainless  
Steel Ties

C1.  
Wiring  
Duct

C2.  
Surface  
Raceway

C3.  
Abrasion  
Protection

C4.  
Cable  
Management

D1.  
Terminals

D2.  
Power  
Connectors

D3.  
Grounding  
Connectors

E1.  
Labeling  
Systems

E2.  
Labels

E3.  
Pre-Printed  
& Write-On  
Markers

E4.  
Permanent  
Identification

E5.  
Lockout/  
Tagout  
& Safety  
Solutions

F.  
Index

A. System Overview

**UL** LISTED **J-Pro™ Cable Support System** **PATENTED**

B1. Cable Ties

B2. Cable Accessories

B3. Stainless Steel Ties

C1. Wiring Duct

C2. Surface Raceway

C3. Abrasion Protection

C4. Cable Management

D1. Terminals

D2. Power Connectors

D3. Grounding Connectors

E1. Labeling Systems

E2. Labels

E3. Pre-Printed & Write-On Markers

E4. Permanent Identification

E5. Lockout/Tagout & Safety Solutions

F. Index

- Patented design provides complete horizontal and vertical 1" (25.4mm) bend radius control that helps prevent degradation of cable performance
- UL 2043 and CAN/ULC S102.2 listed and suitable for use in air handling spaces
- Pre-ripped assemblies allow for attachment to walls, ceilings, beams, threaded rods, drop wires and underfloor supports to meet requirements of a variety of applications

- Wide cable support base prevents pinch points that could cause damage to cables
- Cable tie channel allows user to easily install 3/4" Tak-Ty® Cable Ties to retain cable bundle
- Durable non-metallic J Hook materials provide the ability to manage and support a large number of cables
- Standard product is black. For color options see page C4.7



JP2W-L20



JP2WP-L20



JP2CM-L20



JP2DW-L20

| Part Number*                           | Part Description   | Max. Bundle Capacity |       | Max. Cable Capacity |                |                 | Std. Pkg. Qty. |
|--|--|----------------------|-------|---------------------|----------------|-----------------|----------------|
|  |  | In.                  | mm    | Cat. 6A (.310")     | Cat. 6 (.236") | Cat. 5e (.193") |                |
| <b>Wall Mount</b>                      |  |                      |       |                     |                |                 |                |
| <b>JP75W-L20</b>                       | J Hook for wall mount applications. One 1/4" (M6) mounting hole for user supplied screw.   | 0.75                 | 19.0  | 4                   | 8              | 12              | 50             |
| <b>JP131W-L20</b>                      |  | 1.31                 | 33.3  | 14                  | 28             | 40              | 50             |
| <b>JP2W-L20</b>                        |  | 2.00                 | 50.8  | 30                  | 50             | 70              | 50             |
| <b>JP4W-X20</b>                        |  | 4.00                 | 101.6 | 115                 | 210            | 280             | 10             |
| <b>Wall Mount with Bracket</b>         |  |                      |       |                     |                |                 |                |
| <b>JP75WP-L20</b>                      | J Hook for powder actuated installation on walls. One 5/32" (M4) mounting hole for user supplied fasteners.                        | 0.75                 | 19.0  | 4                   | 8              | 12              | 50             |
| <b>JP131WP-L20</b>                     |  | 1.31                 | 33.3  | 14                  | 28             | 40              | 50             |
| <b>JP2WP-L20</b>                       |  | 2.00                 | 50.8  | 30                  | 50             | 70              | 50             |
| <b>JP4WP-X20</b>                       |  | 4.00                 | 101.6 | 115                 | 210            | 280             | 10             |
| <b>Ceiling Mount</b>                   |  |                      |       |                     |                |                 |                |
| <b>JP75CM-L20</b>                      | J Hook with ceiling mount bracket that has one 3/16" (M5), 1/4" (M6), and 3/8" (M10) mounting hole.                                | 0.75                 | 19.0  | 4                   | 8              | 12              | 50             |
| <b>JP131CM-L20</b>                     |  | 1.31                 | 33.3  | 14                  | 28             | 40              | 50             |
| <b>JP2CM-L20</b>                       |  | 2.00                 | 50.8  | 30                  | 50             | 70              | 50             |
| <b>JP4CM-X20</b>                       |  | 4.00                 | 101.6 | 115                 | 210            | 280             | 10             |
| <b>Drop Wire and Threaded Rod Clip</b> |  |                      |       |                     |                |                 |                |
| <b>JP75DW-L20</b>                      | J Hook with clip for use with #12 wire, threaded rod up to 1/4" (6.4mm) in diameter, or 1/8" – 1/4" (3.2mm – 6.4mm) thick flanges. | 0.75                 | 19.0  | 4                   | 8              | 12              | 50             |
| <b>JP131DW-L20</b>                     |  | 1.31                 | 33.3  | 14                  | 28             | 40              | 50             |
| <b>JP2DW-L20</b>                       |  | 2.00                 | 50.8  | 30                  | 50             | 70              | 50             |

\*Suitable for use in air handling spaces in accordance with Sec. 300-22(c) and (d) of the National Electrical Code. JP4 family of parts suitable for use in single unit configurations. Listed in accordance with CAN/ULC S102.2 when mounted as single units or in pairs. Minimum spacing of 4' (1220mm) required between mount points. (Flame spread rating = 0, Smoke developed classification = 30)



## J-Pro™ Cable Support System (continued)



JP2SBC50R-L20



JP2SBC50-L20



JP2SBC87-L20



JP2SBC87R-L20



JP2HBC25R-L20

JP2HBC50R-L20

JP2HBC75R-L20

| Part Number*                 | Part Description   | Max. Bundle Capacity |       | Max. Cable Capacity |               |                | Std. Pkg. Qty. |
|------------------------------|--|----------------------|-------|---------------------|---------------|----------------|----------------|
|                              |  | In.                  | mm    | Cat 6A (.310")      | Cat 6 (.236") | Cat 5e (.193") |                |
| <b>Screw-On Beam Clamps</b>  |  |                      |       |                     |               |                |                |
| JP75SBC50-L20                | J Hook with screw-on beam clamp for use with flanges up to 1/2" (12.7mm) thick.                                  | 0.75                 | 19.0  | 4                   | 8             | 12             | 50             |
| JP131SBC50-L20               |  | 1.31                 | 33.3  | 14                  | 28            | 40             | 50             |
| JP2SBC50-L20                 |  | 2.00                 | 50.8  | 30                  | 50            | 70             | 50             |
| JP4SBC50-X20                 |  | 4.00                 | 101.6 | 115                 | 210           | 280            | 10             |
| JP75SBC50R-L20               | J Hook with screw-on beam clamp for use with flanges up to 1/2" (12.7mm) thick. Rotates 360 degrees.             | 0.75                 | 19.0  | 4                   | 8             | 12             | 50             |
| JP131SBC50R-L20              |  | 1.31                 | 33.3  | 14                  | 28            | 40             | 50             |
| JP2SBC50R-L20                |  | 2.00                 | 50.8  | 30                  | 50            | 70             | 50             |
| JP4SBC50R-X20                |  | 4.00                 | 101.6 | 115                 | 210           | 280            | 10             |
| JP75SBC87-L20                | J Hook with screw-on beam clamp for use with flanges up to 3/4" (19.1mm) thick.                                  | 0.75                 | 19.0  | 4                   | 8             | 12             | 50             |
| JP131SBC87-L20               |  | 1.31                 | 33.3  | 14                  | 28            | 40             | 50             |
| JP2SBC87-L20                 |  | 2.00                 | 50.8  | 30                  | 50            | 70             | 50             |
| JP4SBC87-X20                 |  | 4.00                 | 101.6 | 115                 | 210           | 280            | 10             |
| JP75SBC87R-L20               | J Hook with screw-on beam clamp for use with flanges up to 3/4" (19.1mm) thick. Rotates 360 degrees.             | 0.75                 | 19.0  | 4                   | 8             | 12             | 50             |
| JP131SBC87R-L20              |  | 1.31                 | 33.3  | 14                  | 28            | 40             | 50             |
| JP2SBC87R-L20                |  | 2.00                 | 50.8  | 30                  | 50            | 70             | 50             |
| JP4SBC87R-X20                |  | 4.00                 | 101.6 | 115                 | 210           | 280            | 10             |
| <b>Hammer-On Beam Clamps</b> |  |                      |       |                     |               |                |                |
| JP75HBC25R-L20               | J Hook with hammer-on beam clamp for use with flanges 1/8" – 1/4" (3.2mm – 6.4mm) thick. Rotates 360 degrees.    | 0.75                 | 19.0  | 4                   | 8             | 12             | 50             |
| JP131HBC25R-L20              |  | 1.31                 | 33.3  | 14                  | 28            | 40             | 50             |
| JP2HBC25R-L20                |  | 2.00                 | 50.8  | 30                  | 50            | 70             | 50             |
| JP4HBC25R-X20                |  | 4.00                 | 101.6 | 115                 | 210           | 280            | 10             |
| JP75HBC50R-L20               | J Hook with hammer-on beam clamp for use with flanges 5/16" – 1/2" (7.9mm – 12.7mm) thick. Rotates 360 degrees.  | 0.75                 | 19.0  | 4                   | 8             | 12             | 50             |
| JP131HBC50R-L20              |  | 1.31                 | 33.3  | 14                  | 28            | 40             | 50             |
| JP2HBC50R-L20                |  | 2.00                 | 50.8  | 30                  | 50            | 70             | 50             |
| JP4HBC50R-X20                |  | 4.00                 | 101.6 | 115                 | 210           | 280            | 10             |
| JP75HBC75R-L20               | J Hook with hammer-on beam clamp for use with flanges 9/16" – 3/4" (14.3mm – 19.1mm) thick. Rotates 360 degrees. | 0.75                 | 19.0  | 4                   | 8             | 12             | 50             |
| JP131HBC75R-L20              |  | 1.31                 | 33.3  | 14                  | 28            | 40             | 50             |
| JP2HBC75R-L20                |  | 2.00                 | 50.8  | 30                  | 50            | 70             | 50             |
| JP4HBC75R-X20                |  | 4.0                  | 101.6 | 115                 | 210           | 280            | 10             |

\*Suitable for use in air handling spaces in accordance with Sec. 300-22(c) and (d) of the National Electrical Code. JP4 family of parts suitable for use in single unit configurations. Listed in accordance with CAN/ULC S102.2 when mounted as single units or in pairs. Minimum spacing of 4' (1220mm) required between mount points. (Flame spread rating = 0, Smoke developed classification = 30)

Table continues on page C4.6

A. System Overview

B1. Cable Ties

B2. Cable Accessories

B3. Stainless Steel Ties

C1. Wiring Duct

C2. Surface Raceway

C3. Abrasion Protection

C4. Cable Management

D1. Terminals

D2. Power Connectors

D3. Grounding Connectors

E1. Labeling Systems

E2. Labels

E3. Pre-Printed & Write-On Markers

E4. Permanent Identification

E5. Lockout/Tagout & Safety Solutions

F. Index

A. System Overview



## J-Pro™ Cable Support System (continued)

B1. Cable Ties

B2. Cable Accessories

B3. Stainless Steel Ties

C1. Wiring Duct

C2. Surface Raceway

C3. Abrasion Protection

C4. Cable Management

D1. Terminals

D2. Power Connectors

D3. Grounding Connectors

E1. Labeling Systems

E2. Labels

E3. Pre-Printed & Write-On Markers

E4. Permanent Identification

E5. Lockout/Tagout & Safety Solutions

F. Index



**JP2ZP-L20**



**JP2CP-L20**



**JP2UF100-L20**

| Part Number*                             | Part Description   | Max. Bundle Capacity |       | Max. Cable Capacity |                |                 | Std. Pkg. Qty. |
|--|--|----------------------|-------|---------------------|----------------|-----------------|----------------|
|  |  | In.                  | mm    | Cat. 6A (.310")     | Cat. 6 (.236") | Cat. 5e (.193") |                |
| <b>Z-Purlin Clips</b>                    |  |                      |       |                     |                |                 |                |
| <b>JP75ZP-L20</b>                        | J Hook with z-purlin clip for use with angled flanges up to 1/4" (6.4mm) thick.                        | 0.75                 | 19.0  | 4                   | 8              | 12              | 50             |
| <b>JP131ZP-L20</b>                       |  | 1.31                 | 33.3  | 14                  | 28             | 40              | 50             |
| <b>JP2ZP-L20</b>                         |  | 2.00                 | 50.8  | 30                  | 50             | 70              | 50             |
| <b>JP4ZP-X20</b>                         |  | 4.00                 | 101.6 | 115                 | 210            | 280             | 10             |
| <b>C-Purlin Clips</b>                    |  |                      |       |                     |                |                 |                |
| <b>JP75CP-L20</b>                        | J Hook with c-purlin clip for use with vertical flanges up to 1/4" (6.4mm) thick.                      | 0.75                 | 19.0  | 4                   | 8              | 12              | 50             |
| <b>JP131CP-L20</b>                       |  | 1.31                 | 33.3  | 14                  | 28             | 40              | 50             |
| <b>JP2CP-L20</b>                         |  | 2.00                 | 50.8  | 30                  | 50             | 70              | 50             |
| <b>JP4CP-X20</b>                         |  | 4.00                 | 101.6 | 115                 | 210            | 280             | 10             |
| <b>Underfloor Pedestal Support Clamp</b> |  |                      |       |                     |                |                 |                |
| <b>JP75UF100-L20</b>                     | J Hook with underfloor clamp for use with pedestal support 7/8" square or 1 1/8" – 1 3/8" in diameter. | 0.75                 | 19.0  | 4                   | 8              | 12              | 50             |
| <b>JP131UF100-L20</b>                    |  | 1.31                 | 33.3  | 14                  | 28             | 40              | 50             |
| <b>JP2UF100-L20</b>                      |  | 2.00                 | 50.8  | 30                  | 50             | 70              | 50             |
| <b>JP4UF100-X20</b>                      |  | 4.00                 | 101.6 | 115                 | 210            | 280             | 10             |

\*Suitable for use in air handling spaces in accordance with Sec. 300-22(c) and (d) of the National Electrical Code. JP4 family of parts suitable for use in single unit configurations. Listed in accordance with CAN/ULC S102.2 when mounted as single units or in pairs. Minimum spacing of 4' (1220mm) required between mount points. (Flame spread rating = 0, Smoke developed classification = 30)

## Color Selection Guide

| Base Part Number | Black | Red | Blue | White | Green | Orange |
|------------------|-------|-----|------|-------|-------|--------|
| JP75W            | -L20  | -L2 |      |       | -L5   | -L3    |
| JP75WP           | -L20  | -L2 |      |       |       |        |
| JP75CM           | -L20  | -L2 |      |       |       |        |
| JP75DW           | -L20  | -L2 | -L6  |       |       |        |
| JP75ZP           | -L20  |     |      |       |       |        |
| JP75CP           | -L20  |     |      |       |       |        |
| JP75SBC50        | -L20  |     |      |       |       |        |
| JP75SBC87        | -L20  |     |      |       |       |        |
| JP75SBC50R       | -L20  | -L2 |      | -L    |       |        |
| JP75SBC87R       | -L20  |     |      |       |       |        |
| JP75HBC25R       | -L20  |     |      |       |       |        |
| JP75HBC50R       | -L20  | -L2 |      | -L    |       |        |
| JP75HBC75R       | -L20  |     |      |       |       |        |
| JP75UF100        | -L20  |     |      |       |       |        |
| JP131W           | -L20  |     | -L6  |       | -L5   | -L3    |
| JP131WP          | -L20  |     |      |       |       |        |
| JP131CM          | -L20  |     |      |       |       |        |
| JP131DW          | -L20  |     | -L6  |       |       |        |
| JP131ZP          | -L20  |     |      |       |       |        |
| JP131CP          | -L20  |     |      |       |       |        |
| JP131SBC50       | -L20  |     |      |       |       |        |
| JP131SBC87       | -L20  |     |      |       |       |        |
| JP131SBC50R      | -L20  | -L2 |      | -L    |       |        |
| JP131SBC87R      | -L20  |     |      |       |       |        |
| JP131HBC25R      | -L20  |     |      |       |       |        |
| JP131HBC50R      | -L20  | -L2 |      | -L    |       |        |
| JP131HBC75R      | -L20  |     |      |       |       |        |
| JP131UF100       | -L20  |     |      |       |       |        |
| JP2W             | -L20  | -L2 | -L6  | -L    | -L5   | -L3    |
| JP2WP            | -L20  |     | -L6  |       |       |        |
| JP2CM            | -L20  | -L2 |      |       |       |        |
| JP2DW            | -L20  | -L2 | -L6  | -L    |       |        |
| JP2ZP            | -L20  |     |      |       |       |        |
| JP2CP            | -L20  |     |      |       |       |        |
| JP2SBC50         | -L20  |     |      | -L    |       |        |
| JP2SBC87         | -L20  |     |      |       |       |        |
| JP2SBC50R        | -L20  | -L2 |      | -L    |       |        |
| JP2SBC87R        | -L20  | -L2 |      |       |       |        |
| JP2HBC25R        | -L20  |     |      |       |       |        |
| JP2HBC50R        | -L20  | -L2 |      | -L    |       |        |
| JP2HBC75R        | -L20  |     |      |       |       |        |
| JP2UF100         | -L20  |     |      |       |       |        |
| JP4W             | -X20  | -X2 | -X6  | -X    |       |        |
| JP4WP            | -X20  | -X2 | -X6  | -X    |       |        |
| JP4CM            | -X20  |     |      |       |       |        |
| JP4ZP            | -X20  |     |      |       |       |        |
| JP4CP            | -X20  |     |      |       |       |        |
| JP4SBC50         | -X20  |     |      | -X    |       |        |
| JP4SBC87         | -X20  |     |      |       |       |        |
| JP4SBC50R        | -X20  | -X2 |      | -X    |       |        |
| JP4SBC87R        | -X20  |     |      |       |       |        |
| JP4HBC25R        | -X20  |     |      |       |       |        |
| JP4HBC50R        | -X20  | -X2 |      | -X    |       |        |
| JP4HBC75R        | -X20  |     |      |       |       |        |
| JP4UF100         | -X20  |     |      |       |       |        |

A.  
System  
Overview

B1.  
Cable Ties

B2.  
Cable  
Accessories

B3.  
Stainless  
Steel Ties

C1.  
Wiring  
Duct

C2.  
Surface  
Raceway

C3.  
Abrasion  
Protection

C4.  
Cable  
Management

D1.  
Terminals

D2.  
Power  
Connectors

D3.  
Grounding  
Connectors

E1.  
Labeling  
Systems

E2.  
Labels

E3.  
Pre-Printed  
& Write-On  
Markers

E4.  
Permanent  
Identification

E5.  
Lockout/  
Tagout  
& Safety  
Solutions

F.  
Index

A. System Overview



## J-Mod® Cable Support System PATENTED

B1. Cable Ties

- Modular design allows flexibility to assemble system in multiple configurations
- Unique chaining bracket design creates a strong metal backbone and allows expansion of the system without disturbance of an existing installation

- Brackets allow for attachment to ceilings, beams, threaded rods and drop wires to meet requirements of a variety of applications
- Manufactured from materials that meet UL 2043 and are suitable for use in air handling spaces
- Complete horizontal and vertical 1" bend radius control
- Cables do not come in contact with metal

B2. Cable Accessories



JM JH2W-X20

JM JH2-X20

B3. Stainless Steel Ties

C1. Wiring Duct

C2. Surface Raceway

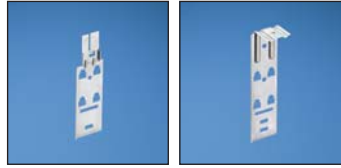

JM CB-X

JM CMB25-1-X

C3. Abrasion Protection

C4. Cable Management

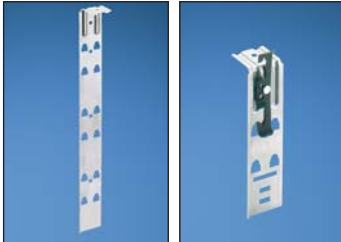

JM CMB25-3-X

JM CMB25-3-X\*\*

D1. Terminals

D2. Power Connectors



JM DWB-3-X

JM DWB-1-X

D3. Grounding Connectors

E1. Labeling Systems

E2. Labels



JM TRB38-3-X

JM TRB38-1-X

E3. Pre-Printed & Write-On Markers

E4. Permanent Identification



JM SBCB87-3-X

E5. Lockout/Tagout & Safety Solutions

F. Index

| Part Number                                   | Part Description  | Material* | Std. Pkg. Qty. | Std. Ctn. Qty. |
|---|---|-----------|----------------|----------------|
| <b>J Hook with Maximum 2" Bundle Capacity</b> |   |           |                |                |
| JM JH2W-X20*                                  | J Hook for wall mount applications only. Two 1/4" (M6) mounting holes for user supplied screws. | Nylon 6.6 | 10             | 50             |
| JM JH2-X20*                                   | J Hook with snap lock attachments for use with all brackets listed below.                       | Nylon 6.6 | 10             | 50             |

### Chaining Bracket

|         |   |                   |    |    |
|---------|---|-------------------|----|----|
| JM CB-X | Chaining bracket to extend J-Mod® capacity one level. Capacity: three levels maximum. For use with all single-level mounting brackets listed below. | Zinc Plated Steel | 10 | 50 |
|---------|---|-------------------|----|----|

### Ceiling Mount Brackets

|                |  |                  |    |    |
|----------------|--|------------------|----|----|
| JM CMB25-1-X   | Single-level ceiling mount bracket with one 1/4" (M6) mounting hole.                                 | Galvanized Steel | 10 | 50 |
| JM CMB25-3-X** | Three-level ceiling mount bracket with one 1/4" (M6) mounting hole. Maximum capacity of six J Hooks. | Galvanized Steel | 10 | 50 |

### Drop Wire Brackets

|              |   |   |    |    |
|--------------|---|---|----|----|
| JM DWB-1-X   | Single-level drop wire bracket. Attaches to #12 wire or 1/4" (6.4mm) plain rod. Maximum capacity of one J Hook per level.   | Galvanized Steel with Metal Attachments | 10 | 50 |
| JM DWB-3-X** | Three-level drop wire bracket. Attaches to #12 wire or 1/4" (6.4mm) plain rod. Maximum capacity of one J Hook for each of three levels. Maximum static load of 40 pounds. | Galvanized Steel with Metal Attachments | 10 | 50 |

### Threaded Rod Brackets

|                |  |   |    |    |
|----------------|--|---|----|----|
| JM TRB38-1-X   | Single-level threaded rod bracket. Accepts 1/4" – 3/8" (6.4mm – 9.5mm) threaded rod.                                 | Galvanized Steel with Metal Attachments | 10 | 50 |
| JM TRB38-3-X** | Three-level threaded rod bracket. Accepts 1/4" – 3/8" (6.4mm – 9.5mm) threaded rod. Maximum capacity of six J Hooks. | Galvanized Steel with Metal Attachments | 10 | 50 |

### Screw-On Beam Clamp Brackets

|                 |  |   |    |    |
|-----------------|--|---|----|----|
| JM SBCB87-1-X   | Single-level screw-on beam clamp bracket for use with flanges up to 3/4" (19.1mm) thick.                                 | Galvanized Steel with Metal Attachments | 10 | 50 |
| JM SBCB87-3-X** | Three-level screw-on beam clamp bracket for use with flanges up to 3/4" (19.1mm) thick. Maximum capacity of six J Hooks. | Galvanized Steel with Metal Attachments | 10 | 50 |

\*Suitable for use in air handling spaces and listed in accordance with UL 2043 and CAN/ULC S102.2 when mounted as single units or in pairs. Maximum spacing of 4' (1220mm) required between mount points. (Flame Spread Rating = 0, Smoke Developed Classification = 30)

\*\*Not for use with chaining brackets.

|                   | Maximum Cable Capacity |                |                 |
|-------------------|------------------------|----------------|-----------------|
|                   | Cat. 6A (.310")        | Cat. 6 (.236") | Cat. 5e (.193") |
| JM JH2W or JM JH2 | 30                     | 50             | 70              |



## Bridle Rings and Fastening Clip

- Multiple diameters, thread sizes, and configurations
- Threaded and non-threaded sizes are compatible with spring steel clip (BR-MPCL) clamp providing a solid securing point for the bridle ring
- Other unique labor saving assemblies differentiate from competition – including pre-assemblies with powder actuated fasteners, toggle wings, and clearance holes for user supplied fasteners



Non-Threaded #8 Wire



Threaded



Wood Screw Thread



Power Actuated Fastener



User Supplied Nail or Fastener



Integrated Toggle Screw

| Part Number                 | Part Description   | Std. Pkg. Qty. |
|-----------------------------|--|----------------|
| <b>Bridle Rings</b>         |  |                |
| BR-.50                      | Bridle ring, .50" dia., non-threaded #8 wire (.162).   | 100            |
| BR-.75                      | Bridle ring, .75" dia., non-threaded #8 wire (.162).   | 100            |
| BR-1.25                     | Bridle ring, 1.25" dia., non-threaded #8 wire (.162).  | 100            |
| BR-2.0                      | Bridle ring, 2.00" dia., non-threaded #8 wire (.162).  | 100            |
| BR-.50-10-24                | Bridle ring, .50" dia., 10 – 24 threaded.  | 100            |
| BR-.75-10-24                | Bridle ring, .75" dia., 10 – 24 threaded.  | 100            |
| BR-1.25-10-24               | Bridle ring, 1.25" dia., 10 – 24 threaded.   | 100            |
| BR-2.0-10-24                | Bridle ring, 2.00" dia., 10 – 24 threaded.   | 100            |
| BR-1.25-1/4-20              | Bridle ring, 1.25" dia., 1/4 – 20 threaded.  | 100            |
| BR-2.0-1/4-20               | Bridle ring, 2.00" dia., 1/4 – 20 threaded.  | 100            |
| BR-4.0-1/4-20               | Bridle ring, 4.00" dia., 1/4 – 20 threaded.  | 50             |
| BR-1.25-14WS                | Bridle ring, 1.25" dia., 16 wood screw thread.   | 100            |
| BR-2.0-14WS                 | Bridle ring, 2.00" dia., 16 wood screw thread.   | 100            |
| BR-1.5-PAF                  | Bridle ring, 1.50" dia., with powder actuated fastener.  | 50             |
| BR-2.0-PAF                  | Bridle ring, 2.00" (50.8mm) dia., with powder actuated fastener.   | 50             |
| BR-1.5-SN                   | Bridle ring, 1.50" dia., user supplied nail or fastener.   | 100            |
| BR-2.0-SN                   | Bridle ring, 2.00" dia., user supplied nail or fastener.   | 100            |
| BR-1.5-TW                   | Bridle ring, 1.50" dia., with integrated toggle screw.   | 25             |
| BR-2.0-TW                   | Bridle ring, 2.00" dia., with integrated toggle screw.   | 25             |
| <b>General Purpose Clip</b> |  |                |
| BR-MPCL                     | Multi-purpose clip; accommodates beam flange from 1/8" to 1/2", standard 1/4 – 20 or #10 – 24 threaded bridle rings, standard drive rings, as well as non-threaded #8 wire bridle rings. | 100            |

## Low Voltage Mounting Brackets

- Choose design styles for new install or retrofit install
- Available in both single and double gang configurations

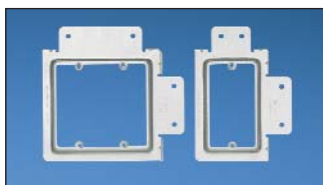

New Install

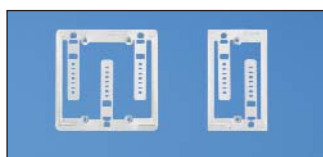

Retrofit Install

| Part Number | Part Description  | Std. Pkg. Qty. |
|-------------|---|----------------|
| LV-S-1G     | Low voltage integral mounting bracket for new installations, single gang stud bracket.  | 25             |
| LV-S-2G     | Low voltage integral mounting bracket for new installations, double gang stud bracket.  | 25             |
| LV-W-1G     | Low voltage mounting bracket for retrofit installations; single gang box with screws; suitable for wall material thicknesses of 1/2" to 1 1/2". | 100            |
| LV-W-2G     | Low voltage mounting bracket for retrofit installations; double gang box with screws; suitable for wall material thicknesses of 1/2" to 1 1/2". | 50             |

A. System Overview

## Metal Stud Accessories

B1. Cable Ties

- Metal stud grommets and cable support manager support and protect cable within the building structure

- Metal Stud Punching Tool punches a 1-11/32" (34.1mm) round hole in 25 GA. min. to 20 GA max. mild steel studs; contoured handle; lightweight aluminum head; automatic hole centering on standard width (3.625") studs; replaceable punch and dies; self-stripping design that eliminates punch hang-ups

B2. Cable Accessories

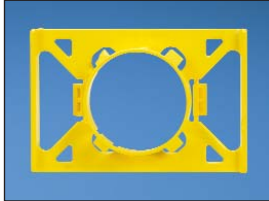

MSG-1.3-C

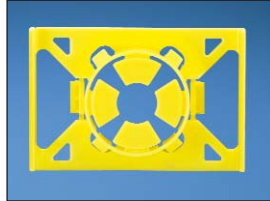

MSGV-1.3-C

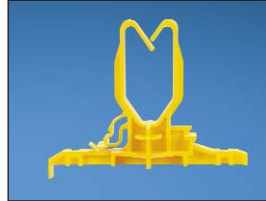

CSM-1.25-C



MSPT-1.3

B3. Stainless Steel Ties

C1. Wiring Duct

C2. Surface Raceway

C3. Abrasion Protection

C4. Cable Management

| Part Number | Part Description   | Std. Pkg. Qty. | Std. Ctn. Qty. |
|-------------|--|----------------|----------------|
| MSG-1.3-C   | Metal stud grommet, 1-11/32" hole.                                     | 100            | 1000           |
| MSGV-1.3-C  | Metal stud grommet, 1-11/32" hole, anti-vibration for 1/2" to 1" pipe. | 100            | 1000           |
| CSM-1.25-C  | Cable stud manager for 1.25" cable spacing.                            | 100            | 1000           |
| MSPT-1.3    | Metal stud punch tool with contoured handle for increased leverage.    | 1              | —              |

D1. Terminals



## Conduit Waterfall



D2. Power Connectors

- Helps prevent pinch points and over bending that could cause damage to cable
- Suitable for use in air handling spaces per UL 2043
- UL listed per UL 1565

- Unique patented design allows for use in both new and retrofit applications
- Allows user to install 3/4" Tak-Ty® Cable Ties to provide a method to retain and manage the cable bundle
- Material: Black nylon meets UL 94V-0 specifications

D3. Grounding Connectors



E1. Labeling Systems

E2. Labels

E3. Pre-Printed & Write-On Markers

E4. Permanent Identification

E5. Lockout/Tagout & Safety Solutions

F. Index

| Part Number   | Part Description   | Std. Pkg. Qty. | Std. Ctn. Qty. |
|---------------|--|----------------|----------------|
| <b>CWF400</b> | Provides bend radius control for cables entering/exiting 4" EMT conduit. Secure to conduit without tools utilizing integral thumb screw and captive nut. | 1              | 10             |

## Waterfall Accessories PATENTED

- Patented bend radius control product
- Product available as a kit (includes base, two wings, and cable ties) or purchased separately
- Easy to install waterfall kit maintains bend radius control in both vertical and horizontal directions to provide a TIA/EIA-568-B compliant installation

- Base attaches to either the rung or stringer on most standard ladder racks for a variety of installations/configurations
- Modular components allow user to custom configure each location where cable management is required
- Material: Black Glass-Filled Nylon 6.6 meets UL 94V-0 specifications



CMW-KIT



CMWB



CMWW

| Part Number    | Part Description   | Color* | Std. Pkg. Qty. | Std. Ctn. Qty. |
|----------------|--|--------|----------------|----------------|
| <b>CMW-KIT</b> | Cable management waterfall kit. Provides bend radius control when transferring cables from standard ladder rack. Kit includes CMWB, two CMWW, and cable ties.  | Black  | 1              | 10             |
| <b>CMWB</b>    | Cable management waterfall base. Used to maintain 1.75" bend radius control vertically when transferring cable off of ladder rack. Mounts to ladder rack rung or stringer with standard cross section cable ties (included). |        | 1              | 10             |
| <b>CMWW</b>    | Cable management waterfall wing. Used in conjunction with CMWB to maintain 1.00" bend radius control horizontally when transferring cable off ladder rack.   |        | 1              | 10             |

\*For white, include suffix of 10. For example: CMW-KIT10.

## Double Waterfall Accessory

- Double waterfall base attaches to the rung on most standard ladder racks to allow bend radius control for cables coming from either direction
- UL 94V-0 Rated Material

- Easy to install double waterfall base maintains bend radius control in a vertical direction to provide a TIA/EIA-568-B compliant installation



| Part Number  | Part Description   | Color | Std. Pkg. Qty. | Std. Ctn. Qty. |
|--------------|--|-------|----------------|----------------|
| <b>CMW2B</b> | Cable management double waterfall base. Used to maintain 1.75" bend radius control vertically when transferring cable off either side of ladder rack rung. Mounts to ladder rack rung with standard cross section cable ties (included). | Black | 1              | 10             |

A. System Overview

B1. Cable Ties

B2. Cable Accessories

B3. Stainless Steel Ties

C1. Wiring Duct

C2. Surface Raceway

C3. Abrasion Protection

C4. Cable Management

D1. Terminals

D2. Power Connectors

D3. Grounding Connectors

E1. Labeling Systems

E2. Labels

E3. Pre-Printed & Write-On Markers

E4. Permanent Identification

E5. Lockout/Tagout & Safety Solutions

F. Index

A.  
System  
Overview

## Stackable Cable Rack Spacers **PATENTED**

B1.  
Cable Ties

- Patented ladder rack accessories
- Separate and support cable and prevent pinch points between the bottom row of cable and the rung as a result of the weight of multiple cable layers applied on top of each other
- Mount to ladder rack with standard cross section cable ties
- Maximize rack space by stacking products for maximum cable capacity
- Provide an alternative to lacing cord by allowing user to secure cable to spacer to prevent movement of cable
- Color: Black

B2.  
Cable  
Accessories

B3.  
Stainless  
Steel Ties



CRS6-X



CRS1-X



CRS4-125-X



CRS1-125-X

| Part Number       | Part Description   | Width |       | Std. Pkg. Qty. | Std. Ctn. Qty. |
|-------------------|--|-------|-------|----------------|----------------|
|                   |  | In.   | mm    |                |                |
| <b>CRS6-X</b>     | Six space stackable cable rack spacer. Accepts cable up to .80" diameter.  | 5.25  | 133.4 | 10             | 100            |
| <b>CRS1-X</b>     | One space stackable cable rack spacer. Use with CRS6 to fill width of ladder rack. Accepts cable up to .80" diameter.  | 1.13  | 28.58 | 10             | 100            |
| <b>CRS4-125-X</b> | Four space stackable cable rack spacer. Accepts cable up to 1.25" diameter.  | 5.24  | 133.1 | 10             | 100            |
| <b>CRS1-125-X</b> | One space stackable cable rack spacer. Use with CRS4 to fill width of ladder rack. Accepts cable up to 1.25" diameter. | 1.55  | 39.4  | 10             | 100            |

C1.  
Wiring  
Duct

C2.  
Surface  
Raceway

C3.  
Abrasion  
Protection

C4.  
Cable  
Management

D1.  
Terminals

## Threaded Rod Cover

D2.  
Power  
Connectors

- Protects cable from abrasion caused by contact with threaded rod
- Material meets UL 94V-0 specifications
- Available in 18" lengths
- Accept 1/2" to 5/8" threaded rod
- For indoor use only
- Material: Gray or Black Polyethylene

D3.  
Grounding  
Connectors

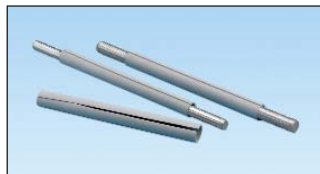

| Part Number         | Part Description   | Std. Pkg. Qty. | Std. Ctn. Qty. |
|---------------------|--|----------------|----------------|
| <b>TRC18FR-X8Y</b>  | Used to protect cabling from threaded rod. Flexible material with vertical slit allows easy installation. Gray.  | 10             | 100            |
| <b>TRC18FR-X20Y</b> | Used to protect cabling from threaded rod. Flexible material with vertical slit allows easy installation. Black. | 10             | 100            |

E1.  
Labeling  
Systems

E2.  
Labels

E3.  
Pre-Printed  
& Write-On  
Markers

E4.  
Permanent  
Identification

E5.  
Lockout/  
Tagout  
& Safety  
Solutions

F.  
Index

## Vertical D-Rings PATENTED

- Patented cable manager ring
- Standard EIA hole spacing allows product to be mounted to any standard rack
- Flexible material allows arm to rotate so entire cable bundle can be inserted and removed

- 1/4" mounting holes allow for a variety of screws to secure the D-ring to a surface
- Material: Black Polycarbonate



| Part Number    | Part Description  | Fiber | ScTP | UTP | Std. Pkg. Qty. | Std. Ctn. Qty. |
|----------------|---|-------|------|-----|----------------|----------------|
| <b>CMVDR1</b>  | Vertical D-ring.<br>Outside dimensions 5.70"L x 2.00"W.   | 252   | 48   | 96  | 1              | 10             |
| <b>CMVDR1S</b> | Vertical D-ring.<br>Outside dimensions 3.30"L x 2.00"W.   | 132   | 32   | 52  | 1              | 10             |
| <b>CMVDR2</b>  | Vertical D-ring.<br>Outside dimensions 5.70"L x 3.00"W.   | 504   | 96   | 192 | 1              | 10             |
| <b>CMVDR2S</b> | Vertical D-ring.<br>Outside dimensions 3.30"L x 3.00"W.   | 252   | 48   | 96  | 1              | 10             |
| <b>CMVDRC</b>  | Center mounted vertical D-ring for routing cables between two adjacent racks. Requires 8.25" spacing between the center lines of the adjacent rack's mounting holes.<br>Outside dimensions 5.60"L x 8.00"W. | 1000  | 200  | 400 | 1              | 10             |

All product color is black.

## Tak-Ty® Hook & Loop Cable Tie Mounts

- For use with hook and loop cable ties, see page B1.87, B1.88
- Unique cradle design provides maximum stability for cable bundle
- For indoor use only

- Dimensions: 1.10"L x 1.12"W x 0.34"H (27.9mm x 28.4mm x 8.6mm)

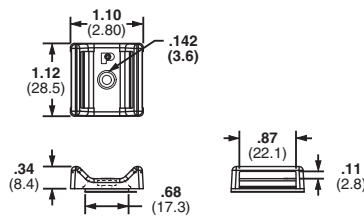

| Part Number        | Used with Cable Ties‡       | Material  | Color                        | Max. Static Load |      | Mounting Method*                 | Std. Pkg. Qty. | Std. Ctn. Qty. |      |
|--------------------|-----------------------------|-----------|------------------------------|------------------|------|----------------------------------|----------------|----------------|------|
|                    |                             |           |                              | Lbs.             | g    |                                  |                |                |      |
| <b>ABMT-A-C</b>    | HLS,<br>HLT,<br>TTS,<br>UCT | Nylon 6.6 | Natural                      | 0.38             | 174  | Pre-installed<br>Rubber Adhesive | 100            | 1000           |      |
| <b>ABMT-A-C20</b>  |                             |           | Black                        |                  |      |                                  |                |                |      |
| <b>ABMT-S6-C</b>   |                             |           | Natural                      | —                | —    |                                  | #6 (M3) Screw  | 100            | 1000 |
| <b>ABMT-S6-C20</b> |                             |           | Black                        |                  |      |                                  |                |                |      |
| <b>ABMT-S6-C60</b> |                             | Black     | Flame Retardant<br>Nylon 6.6 | Natural          | 100  | 1000                             |                |                |      |
| <b>ABMT-S6-C69</b> |                             | Natural   |                              | 100              | 1000 |                                  |                |                |      |

‡Cable tie cross section sizes: HLT = Tak-Ty™ Hook & Loop Ties, HLS = Tak-Ty™ Hook & Loop Strip Tie, TTS = Tak-Tape™ Roll, UCT = Ultra-Cinch™ Tie.  
\*For proper selection of adhesives see page B2.53.

A. System Overview

## Flat Pan-Post™ Standoffs

B1. Cable Ties

- Standard EIA hole spacing allows product to be mounted with user supplied screws up to 1/4" diameter
- Organize cables in standard cabinets and racks
- Mounting method: 1/4" (M6) screw
- Use where space is limited
- For indoor use only

B2. Cable Accessories



B3. Stainless Steel Ties

C1. Wiring Duct

C2. Surface Raceway

C3. Abrasion Protection

C4. Cable Management

| Part Number           | Part Description  | Std. Pkg. Qty. | Std. Ctn. Qty. |
|-----------------------|---|----------------|----------------|
| <b>PPF2S-S25-V</b>    | Nylon 6.6 flat Pan-Post™ Standoff. Use with miniature, intermediate, and standard cross section cable ties. Dimensions 5.42"L x 1.50"H x 0.19"W (137.7mm x 38.1mm x 4.8mm).   | 5              | 100            |
| <b>PPF2S-S25-V69</b>  | Flame retardant nylon 6.6 flat Pan-Post™ Standoff. Use with miniature, intermediate, and standard cross section cable ties. Material meets UL 94V-0 specifications. Dimensions 5.42"L x 1.50"H x 0.19"W (137.7mm x 38.1mm x 4.8mm). | 5              | 100            |
| <b>PPF2SV-S25-V</b>   | Nylon 6.6 flat Pan-Post™ Standoff. Use with Tak-Ty® Hook & Loop Cable Ties. Dimensions 5.60"L x 1.62"H x 0.19"W (142.2mm x 41.3mm x 4.8mm).   | 5              | 100            |
| <b>PPF2SV-S25-V69</b> | Flame retardant nylon 6.6 flat Pan-Post™ Standoff. Use with Tak-Ty® Hook & Loop Cable Ties. Material meets UL 94V-0 specifications. Dimensions 5.60"L x 1.62"H x 0.19"W (142.2mm x 41.3mm x 4.8mm).                                 | 5              | 100            |

## Communication Cable Management Kit for Cabinets

D1. Terminals

- Kit of cable management accessories specifically designed for use in a network cabinet or enclosure

D2. Power Connectors

D3. Grounding Connectors

E1. Labeling Systems

E2. Labels

E3. Pre-Printed & Write-On Markers

E4. Permanent Identification

E5. Lockout/Tagout & Safety Solutions

F. Index



| Part Number    | Part Description   | Std. Pkg. Qty. | Std. Ctn. Qty. |
|----------------|--|----------------|----------------|
| <b>CCMKIT1</b> | Kit includes the following:<br>1 roll 15' (4.6m) length .33" (8.4mm) Tak-Ty® Cable Ties<br>24 nylon cable ties<br>12 adhesive backed cable tie mounts<br>6 push style cable tie mounts<br>4 vertical wire saddles<br>8 flat Pan-Post™ Standoffs for use with std. nylon cable ties   | 1              | 100            |
| <b>CCMKIT2</b> | Kit includes the following:<br>1 roll 15' (4.6m) length .75" (19.1mm) Tak-Ty® Cable Ties<br>12 nylon cable ties<br>6 adhesive backed cable tie mounts<br>6 adhesive backed mounts for .75" (19.1mm) Tak-Ty® Cable Ties<br>6 screw mounts for .75" (19.1mm) Tak-Ty® Cable Ties<br>4 vertical wire saddles<br>6 flat Pan-Post™ Standoffs for use with .75" (19.1mm) Tak-Ty® Cable Ties | 1              | 100            |

Order the number of kits required.



## PAN-TERM® TERMINALS

Panduit® Pan-Term® Terminals are designed and manufactured for fast assembly, and reliable performance. Panduit provides an extensive line of tooling designed specifically to provide optimum performance. As the demand for loose piece terminals increases, it becomes essential to provide a complete system for termination products.



- Funnel entry available on vinyl and nylon insulated terminals and disconnects, speeds insertion, and minimizes turned back wire strands
- Made of electrolytic copper to provide an optimum combination of crimp forming and high conductivity properties to provide superior terminations
- Available in sizes from #26 – 2 AWG and stud hole diameters from #2 – 1/2 inch; non-insulated tubular terminals sizes from #8 – 250 kcmil
- Applicable sizes are UL Listed and CSA Certified, RoHS compliant, ABS (American Bureau of Shipping) Approved, Class IE Nuclear Rated, DFARS 252.225-7014 Compliant and meet Military Specifications MS25036 and MS20659 as noted
- Wide assortment of manual, controlled cycle, battery operated hydraulic and pneumatic crimping tools for reliable connections at the lowest installed cost
- Standard pack terminals are now offered in a new ergonomic, reusable, clear plastic bottle with color-coded flip top lids for easy product selection, dispensing and size identification
- New Convenience Packs offer premium terminal products in a clear, resealable, 20 piece package, designed for quick product selection and identification

Panduit continually provides new designs to meet the application challenges encountered by our customers. Panduit offers a wide assortment of Pan-Term® termination products to meet customer needs at the lowest installed cost.

A.  
System  
Overview

B1.  
Cable Ties

B2.  
Cable  
Accessories

B3.  
Stainless  
Steel Ties

C1.  
Wiring  
Duct

C2.  
Surface  
Raceway

C3.  
Abrasion  
Protection

C4.  
Cable  
Management

D1.  
Terminals

D2.  
Power  
Connectors

D3.  
Grounding  
Connectors

E1.  
Labeling  
Systems

E2.  
Labels

E3.  
Pre-Printed  
& Write-On  
Markers

E4.  
Permanent  
Identification

E5.  
Lockout/  
Tagout  
& Safety  
Solutions

F.  
Index

A. System Overview

## Features and Benefits – Pan-Term® Terminals

B1. Cable Ties

All Panduit terminals feature high quality materials made with electrolytic copper for high conductivity and are tin-plated for corrosion resistance.

B2. Cable Accessories

B3. Stainless Steel Ties

C1. Wiring Duct

C2. Surface Raceway

C3. Abrasion Protection

C4. Cable Management

### Non-Insulated Terminals Type P

Maximum recommended operating temperature 302°F (150°C)

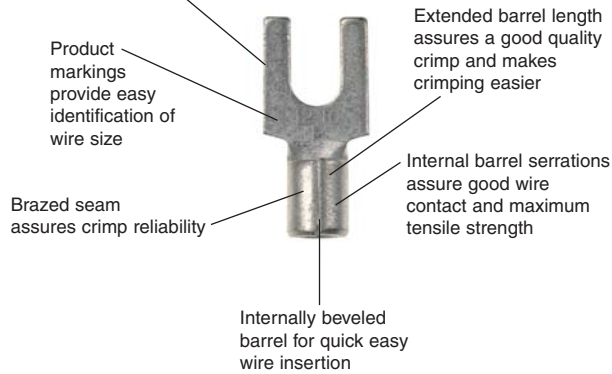

UL and CSA rated up to 2000 V per UL 486A/B. Nickel plated terminals rated up to 650°F (343°C) maximum operating temperature.

### Nylon Insulated Terminals with Insulation Grip Sleeve Type PN or PNF

Internal barrel serrations assure good wire contact and maximum tensile strength

Insulation grip sleeve provides a superior insulation crimp for high vibration and high strain relief applications

Funnel entry for faster insertion and lower installed cost



Maximum insulation temperature 221°F (105°C)

Sleeved barrel assures crimp reliability

Color coded insulation identifies wire range



UL and CSA rated up to 600 V per UL 486A/B. Flammability – UL 94V-2/HB. Proprietary blend of UL 94V-2 and UL 94HB flammability rated materials.

D1. Terminals

### Vinyl Insulated Terminals With Insulation Support Type PV

Internal barrel serrations assure good wire contact and maximum tensile strength

Insulation crimp provides insulation support to protect electrical crimp

Funnel entry for faster insertion and lower installed cost



Maximum insulation temperature 221°F (105°C)

Brazed seam assures crimp reliability

Color coded insulation identifies wire range



UL and CSA rated up to 600 V per UL 486A/B. Flammability – UL 94V-0.

### Non-Insulated Seamless Tubular Terminals Type S

Internally beveled barrel for quick easy wire insertion

Seamless tubular barrel provides consistent, high performance, quality crimps

Maximum recommended operating temperature 302°F (150°C)

Inspection hole allows visual inspection for proper wire insertion

Product markings provide easy identification of wire sizes

Double thickness provides a strong ring tongue



UL and CSA rated up to 2000 V per UL 486A/B.

D2. Power Connectors

D3. Grounding Connectors

E1. Labeling Systems

E2. Labels

E3. Pre-Printed & Write-On Markers

E4. Permanent Identification

E5. Lockout/Tagout & Safety Solutions

F. Index



Panduit extensive line of tooling is specifically designed for optimum crimping performance.

See pages D1.83 – D1.89.



Panduit designs and manufactures a full line of labeling products, software and printers to assist you with your labeling requirements.

See pages E1.1 – E2.28.

## Selection Guide – Pan-Term® Ring Terminals

| Insulation Material |               | Style                                   | Feature             | Type                           | Page Number |       |
|---------------------|---------------|---|---------------------|--------------------------------|-------------|-------|
| Ring Terminals      | Nylon         | Standard Ring                           | Insulation Grip     | PN-R                           | D1.6        |       |
|                     |               |   | Funnel Entry        | PNF-R                          | D1.7        |       |
|                     |               |   | Expanded Insulation | PN-RX                          | D1.8        |       |
|                     |               |   | Heavy Duty          | PN-HDR                         | D1.13       |       |
|                     |               | Multiple Stud                           | Insulation Grip     | PN-610R                        | D1.8        |       |
|                     | Vinyl         | Standard Ring                           | Insulation Support  | PV-R                           | D1.9        |       |
|                     |               |   | Expanded Insulation | PV-RX                          | D1.10       |       |
|                     |               |   | Heavy Duty          | PV-HDR                         | D1.14       |       |
|                     |               |   | Multiple Stud       | Large Wire, Insulation Support | PV-R/X      | D1.15 |
|                     |               | Expanded Insulation, Insulation Support |                     | PV-RX                          | D1.16       |       |
| Insulation Support  |               | PV-610R                                 |                     | D1.11                          |             |       |
| Heat Shrink         | Standard Ring | Heat Shrink Insulation                  | PH-R                | D1.13                          |             |       |
| KYNAR® Insulated    | Standard Ring | Insulation Grip                         | PK-R                | D1.12                          |             |       |
| Non-Insulated       | Standard Ring | Brazed Seam                             | P-R                 | D1.17                          |             |       |
|                     |               | High Temp, Brazed Seam                  | P-RHT               | D1.19                          |             |       |
|                     |               | Heavy Duty                              | P-HDR               | D1.20                          |             |       |
|                     |               | Large Wire                              | P-R                 | D1.20                          |             |       |
|                     | Multiple Stud | Brazed Seam                             | P-610R              | D1.18                          |             |       |
|                     | Tubular Ring  | Large Wire, Seamless Barrel             | S-R                 | D1.20                          |             |       |



®KYNAR is a registered trademark of Atofina Chemicals, Inc.

A. System Overview

B1. Cable Ties

B2. Cable Accessories

B3. Stainless Steel Ties

C1. Wiring Duct

C2. Surface Raceway

C3. Abrasion Protection

C4. Cable Management

D1. Terminals

D2. Power Connectors

D3. Grounding Connectors

E1. Labeling Systems

E2. Labels

E3. Pre-Printed & Write-On Markers

E4. Permanent Identification

E5. Lockout/Tagout & Safety Solutions

F. Index

A. System Overview

B1. Cable Ties

B2. Cable Accessories

B3. Stainless Steel Ties

C1. Wiring Duct

C2. Surface Raceway

C3. Abrasion Protection

C4. Cable Management

D1. Terminals

D2. Power Connectors

D3. Grounding Connectors

E1. Labeling Systems

E2. Labels

E3. Pre-Printed & Write-On Markers

E4. Permanent Identification

E5. Lockout/Tagout & Safety Solutions

F. Index

## Selection Guide – Pan-Term® Fork Terminals

| Material           | Style              | Feature                                   | Type   | Page Number |
|--------------------|--------------------|---|--------|-------------|
| Nylon              | Standard Fork      | Insulation Grip                           | PN-F   | D1.22       |
|                    |                    | Funnel Entry                              | PNF-F  | D1.22       |
|                    | Locking Fork       | Insulation Grip                           | PN-LF  | D1.24       |
|                    |                    | Funnel Entry                              | PNF-LF | D1.25       |
|                    | Locking Fork Short | Insulation Grip                           | PN-SLF | D1.26       |
| Funnel Entry       | PNF-SLF            | D1.27                                     |        |             |
| Flanged Fork       | Insulation Grip    | PN-FF                                     | D1.28  |             |
|                    |                    |   |        |             |
| Vinyl              | Standard Fork      | Insulation Support                        | PV-F   | D1.23       |
|                    |                    | Expanded Insulation                       | PV-FX  | D1.24       |
|                    | Locking Fork       | Funnel Entry                              | PV-LF  | D1.25       |
|                    |                    | Expanded Insulation<br>Insulation Support | PV-LFX | D1.26       |
|                    | Locking Fork Short | Funnel Entry                              | PV-SLF | D1.27       |
| Flanged Fork       | Funnel Entry       | PV-FF                                     | D1.28  |             |
| Heat Shrink        | Standard Fork      | Heat Shrink Insulation                    | PH-F   | D1.31       |
|                    |                    |   |        |             |
| Non-Insulated      | Standard Fork      | Brazed Seam                               | P-F    | D1.29       |
|                    |                    | Brazed Seam                               | P-FF   | D1.30       |
|                    | Locking Fork       | Brazed Seam                               | P-LF   | D1.30       |
|                    |                    | Brazed Seam                               | P-SLF  | D1.31       |
| Locking Fork Short | Brazed Seam        | P-SLF                                     | D1.31  |             |

### Fork Terminals



## Part Number System for Pan-Term® Terminals

| <b>P</b>                    | <b>N</b>                                     | <b>14</b>      | <b>4</b>   | <b>R</b>                 | <b>X</b>                                | <b>C</b>       |
|-----------------------------|--|----------------|------------|--------------------------|---|----------------|
| Type                        | Insulation                                   | Wire Range     | Stud Size  | Tongue Configuration     | Special Configuration                   | Std. Pkg. Size |
| P = Seamed Barrel           | H = Heat Shrink                              | 22 = #26 – 22  | 2 = #2     | HDR = Heavy Duty Ring    | HT6 = High Temperature                  | 5 = 5          |
| S = Seamless Tubular Barrel | K = KYNAR <sup>®</sup> Insulated             | 18 = #22 – 18  | 4 = #4     | F = Fork                 | N = Narrow Tongue                       | X = 10         |
|                             | N = Nylon Insulated                          | 14 = #16 – 14  | 5 = #5     | FF = Flanged Fork        | W = Wide Tongue                         | E = 20         |
|                             | NF = Nylon Insulated Funnel Entry            | 12 = #16 – 12  | 6 = #6     | LF = Locking Fork        | X = Expanded Insulation                 | Q = 25         |
|                             | V = Vinyl Insulated = Non-Ins. (leave blank) | 10 = #12 – 10  | 8 = #8     | R = Ring                 | = Non-Expanded Insulation (leave blank) | L = 50         |
|                             |  | 8 = #8         | 10 = #10   | SLF = Short Locking Fork |   | C = 100        |
|                             |  | 6 = #6         | 14 = 1/4"  |                          |   | T = 200        |
|                             |  | 4 = #4         | 56 = 5/16" |                          |   | D = 500        |
|                             |  | 2 = #2         | 38 = 3/8"  |                          |   | M = 1000       |
|                             |  | 1 = #1         | 76 = 7/16" |                          |   |                |
|                             |  | 1/0 = 1/0      | 12 = 1/2"  |                          |   |                |
|                             |  | 2/0 = 2/0      |            |                          |   |                |
|                             |  | 3/0 = 3/0      |            |                          |   |                |
|                             |  | 4/0 = 4/0      |            |                          |   |                |
|                             |  | 250 = 250kcmil |            |                          |   |                |

▪KYNAR is a registered trademark of Atofina Chemicals, Inc.

A.  
System  
Overview

B1.  
Cable Ties

B2.  
Cable  
Accessories

B3.  
Stainless  
Steel Ties

C1.  
Wiring  
Duct

C2.  
Surface  
Raceway

C3.  
Abrasion  
Protection

C4.  
Cable  
Management

D1.  
Terminals

D2.  
Power  
Connectors

D3.  
Grounding  
Connectors

E1.  
Labeling  
Systems

E2.  
Labels

E3.  
Pre-Printed  
& Write-On  
Markers

E4.  
Permanent  
Identification

E5.  
Lockout/  
Tagout  
& Safety  
Solutions

F.  
Index

A. System Overview

B1. Cable Ties

B2. Cable Accessories

B3. Stainless Steel Ties

C1. Wiring Duct

C2. Surface Raceway

C3. Abrasion Protection

C4. Cable Management

D1. Terminals

D2. Power Connectors

D3. Grounding Connectors

E1. Labeling Systems

E2. Labels

E3. Pre-Printed & Write-On Markers

E4. Permanent Identification

E5. Lockout/Tagout & Safety Solutions

F. Index

**UL LISTED** **CSA CERTIFIED** **Ring Terminal, Nylon Insulated**

**Type PN-R**

- Ring tongue design assures a secure connection in high vibration applications
- Metal insulation grip sleeve crimps to wire insulation, providing protection to the crimp joint during high vibration applications
- Internal barrel serrations assure good wire contact and maximum tensile strength
- UL Flammability UL 94V-2/HB, maximum insulation temperature 221°F (105°C)
- UL and CSA rated up to 600 V per UL 486A/B

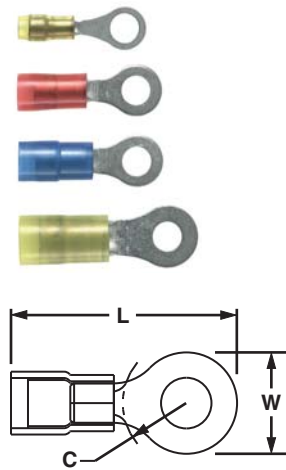

| Part Number        | Wire Range  | Color Code | Stock Thickness (In.) | Max. Ins. (In.) | Stud Size | Figure Dimensions (In.) |      |      | Recommended Installation Tool                     | Std. Pkg. Qty.** | Std. Ctn. Qty. |
|--------------------|-------------|------------|-----------------------|-----------------|-----------|-------------------------|------|------|---|------------------|----------------|
|                    |             |            |                       |                 |           | L                       | W    | C    |   |                  |                |
| <b>PN22-2R-C*</b>  | 26 – 22 AWG | Yellow     | 0.02                  | 0.090           | #2        | 0.69                    | 0.20 | 0.18 | CT-600-A, CT-1525, CT-2500                        | 100              | 1000           |
| <b>PN22-4R-C*</b>  |             |            | 0.02                  | 0.090           | #4        | 0.69                    | 0.20 | 0.18 |   | 100              | 1000           |
| <b>PN22-6R-C*</b>  |             |            | 0.02                  | 0.090           | #6        | 0.69                    | 0.20 | 0.18 |   | 100              | 1000           |
| <b>PN22-8R-C*</b>  |             |            | 0.02                  | 0.090           | #8        | 0.78                    | 0.26 | 0.26 |   | 100              | 1000           |
| <b>PN22-10R-C*</b> |             |            | 0.02                  | 0.090           | #10       | 0.78                    | 0.31 | 0.24 |   | 100              | 1000           |
| <b>PN18-4RN-C^</b> | 22 – 18 AWG | Red        | 0.03                  | 0.145           | #4        | 0.74                    | 0.22 | 0.18 | CT-100A‡, CT-600-A‡, CT-1550‡, CT-1551‡, CT-2500‡ | 100              | 500            |
| <b>PN18-4R-C</b>   |             |            | 0.03                  | 0.145           | #4        | 0.80                    | 0.25 | 0.22 |   | 100              | 500            |
| <b>PN18-6RN-C^</b> |             |            | 0.03                  | 0.145           | #6        | 0.77                    | 0.22 | 0.18 |   | 100              | 500            |
| <b>PN18-6R-C^</b>  |             |            | 0.03                  | 0.145           | #6        | 0.80                    | 0.25 | 0.22 |   | 100              | 500            |
| <b>PN18-8R-C^</b>  |             |            | 0.03                  | 0.145           | #8        | 0.86                    | 0.31 | 0.25 |   | 100              | 500            |
| <b>PN18-10R-C^</b> |             |            | 0.03                  | 0.145           | #10       | 0.88                    | 0.31 | 0.25 |   | 100              | 500            |
| <b>PN18-14R-C^</b> |             |            | 0.03                  | 0.145           | 1/4"      | 1.09                    | 0.45 | 0.38 |   | 100              | 500            |
| <b>PN18-56R-C^</b> |             |            | 0.03                  | 0.145           | 5/16"     | 1.09                    | 0.46 | 0.38 |   | 100              | 500            |
| <b>PN18-38R-C^</b> |             |            | 0.03                  | 0.145           | 3/8"      | 1.17                    | 0.53 | 0.43 |   | 100              | 500            |
| <b>PN18-12R-L</b>  |             |            | 0.03                  | 0.145           | 1/2"      | 1.35                    | 0.72 | 0.53 |   | 50               | 500            |
| <b>PN14-4R-C^</b>  | 18 – 14 AWG | Blue       | 0.03                  | 0.162           | #4        | 0.78                    | 0.25 | 0.20 | CT-100A‡, CT-600-A‡, CT-1550‡, CT-1551‡, CT-2500‡ | 100              | 500            |
| <b>PN14-6RN-C^</b> |             |            | 0.03                  | 0.162           | #6        | 0.76                    | 0.25 | 0.20 |   | 100              | 500            |
| <b>PN14-6R-C^</b>  |             |            | 0.03                  | 0.162           | #6        | 0.85                    | 0.31 | 0.25 |   | 100              | 500            |
| <b>PN14-8R-C^</b>  |             |            | 0.03                  | 0.162           | #8        | 0.85                    | 0.31 | 0.25 |   | 100              | 500            |
| <b>PN14-10R-C^</b> |             |            | 0.03                  | 0.162           | #10       | 0.85                    | 0.31 | 0.25 |   | 100              | 500            |
| <b>PN14-14R-C^</b> |             |            | 0.03                  | 0.162           | 1/4"      | 1.05                    | 0.46 | 0.38 |   | 100              | 500            |
| <b>PN14-56R-C^</b> |             |            | 0.03                  | 0.162           | 5/16"     | 1.05                    | 0.46 | 0.38 |   | 100              | 500            |
| <b>PN14-38R-L^</b> |             |            | 0.03                  | 0.162           | 3/8"      | 1.14                    | 0.53 | 0.43 |   | 50               | 500            |
| <b>PN14-12R-Q</b>  |             |            | 0.03                  | 0.162           | 1/2"      | 1.35                    | 0.72 | 0.53 |   | 25               | 125            |
| <b>PN10-6R-L^</b>  |             |            | 12 – 10 AWG           | Yellow          | 0.04      | 0.225                   | #6   | 1.06 |   | 0.37             | 0.31           |
| <b>PN10-8R-L^</b>  | 0.04        | 0.225      |                       |                 | #8        | 1.06                    | 0.37 | 0.31 | 50  | 500              |                |
| <b>PN10-10R-L^</b> | 0.04        | 0.225      |                       |                 | #10       | 1.06                    | 0.38 | 0.31 | 50  | 500              |                |
| <b>PN10-14R-L^</b> | 0.04        | 0.225      |                       |                 | 1/4"      | 1.21                    | 0.52 | 0.38 | 50  | 500              |                |
| <b>PN10-56R-L^</b> | 0.04        | 0.225      |                       |                 | 5/16"     | 1.21                    | 0.52 | 0.38 | 50  | 500              |                |
| <b>PN10-38R-L^</b> | 0.04        | 0.225      |                       |                 | 3/8"      | 1.29                    | 0.58 | 0.43 | 50  | 500              |                |
| <b>PN10-12R-Q</b>  | 0.04        | 0.225      |                       |                 | 1/2"      | 1.47                    | 0.72 | 0.53 | 25  | 125              |                |

\*Wire sizes #26-22 AWG, are not UL Listed or CSA Certified.

\*\*Bulk packaging may be available, contact Panduit Customer Service for additional information.

^For military specification cross reference see page D1.96.

‡UL and CSA approved tooling/product combinations. For crimping tool information, see pages D1.83, D1.84, D1.86 and D1.88.





## Ring Terminal, Nylon Insulated – Funnel Entry

### Type PNF-R

- Ring tongue design assures a secure connection in high vibration applications
- Metal insulation grip sleeve crimps to wire insulation, providing protection to the crimp joint during high vibration applications
- Internal barrel serrations assure good wire contact and maximum tensile strength
- UL Flammability UL 94V-2/HB, maximum insulation temperature 221°F (105°C)
- UL and CSA rated up to 600 V per UL 486A/B

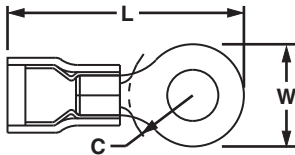

| Part Number         | Wire Range  | Color Code | Stock Thickness (In.) | Max. Ins. (In.) | Stud Size | Figure Dimensions (In.) |      |      | Recommended Installation Tool                     | Std. Pkg. Qty.** | Std. Ctn. Qty.                                    |   |     |     |
|---------------------|-------------|------------|-----------------------|-----------------|-----------|-------------------------|------|------|---|------------------|---|---|-----|-----|
|                     |             |            |                       |                 |           | L                       | W    | C    |   |                  |   |   |     |     |
| <b>PNF18-4R-C</b>   | 22 – 18 AWG | Red        | 0.03                  | 0.136           | #4        | 0.77                    | 0.25 | 0.20 | CT-100A‡, CT-600-A‡, CT-1550‡, CT-1551‡, CT-2500‡ | 100              | 500   |   |     |     |
| <b>PNF18-6RN-C^</b> |             |            | 0.03                  | 0.136           | #6        | 0.76                    | 0.22 | 0.18 |   | 100              | 500   |   |     |     |
| <b>PNF18-6R-C^</b>  |             |            | 0.03                  | 0.136           | #6        | 0.77                    | 0.25 | 0.20 |   | 100              | 500   |   |     |     |
| <b>PNF18-8R-C^</b>  |             |            | 0.03                  | 0.136           | #8        | 0.87                    | 0.31 | 0.24 |   | 100              | 500   |   |     |     |
| <b>PNF18-10R-C^</b> |             |            | 0.03                  | 0.136           | #10       | 0.87                    | 0.32 | 0.25 |   | 100              | 500   |   |     |     |
| <b>PNF18-14R-C^</b> |             |            | 0.03                  | 0.136           | 1/4"      | 1.08                    | 0.46 | 0.38 |   | 100              | 500   |   |     |     |
| <b>PNF18-56R-C^</b> |             |            | 0.03                  | 0.136           | 5/16"     | 1.08                    | 0.46 | 0.39 |   | 100              | 500   |   |     |     |
| <b>PNF18-38R-C^</b> |             |            | 0.03                  | 0.136           | 3/8"      | 1.16                    | 0.53 | 0.41 |   | 100              | 500   |   |     |     |
| <b>PNF14-4R-C^</b>  |             |            | 16 – 14 AWG           | Blue            | 0.03      | 0.162                   | #4   | 0.78 |   | 0.25             | 0.18  | CT-100A‡, CT-600-A‡, CT-1550‡, CT-1551‡, CT-2500‡ | 100 | 500 |
| <b>PNF14-6RN-C^</b> |             |            |                       |                 | 0.03      | 0.162                   | #6   | 0.78 |   | 0.25             | 0.18  |   | 100 | 500 |
| <b>PNF14-6R-C^</b>  | 0.03        | 0.162      |                       |                 | #6        | 0.87                    | 0.31 | 0.24 | 100   | 500              |   |   |     |     |
| <b>PNF14-8R-C^</b>  | 0.03        | 0.162      |                       |                 | #8        | 0.87                    | 0.31 | 0.25 | 100   | 500              |   |   |     |     |
| <b>PNF14-10R-C^</b> | 0.03        | 0.162      |                       |                 | #10       | 0.85                    | 0.31 | 0.29 | 100   | 500              |   |   |     |     |
| <b>PNF14-14R-C^</b> | 0.03        | 0.162      |                       |                 | 1/4"      | 1.06                    | 0.46 | 0.40 | 100   | 500              |   |   |     |     |
| <b>PNF14-56R-C^</b> | 0.03        | 0.162      |                       |                 | 5/16"     | 1.06                    | 0.46 | 0.40 | 100   | 500              |   |   |     |     |
| <b>PNF14-38R-L^</b> | 0.03        | 0.162      |                       |                 | 3/8"      | 1.14                    | 0.53 | 0.45 | 50  | 500              |   |   |     |     |
| <b>PNF10-6R-L^</b>  | 12 – 10 AWG | Yellow     |                       |                 | 0.04      | 0.225                   | #6   | 1.06 | 0.37  | 0.31             | CT-100A‡, CT-600-A‡, CT-1550‡, CT-1551‡, CT-2500‡ |   | 50  | 500 |
| <b>PNF10-8R-L^</b>  |             |            |                       |                 | 0.04      | 0.225                   | #8   | 1.06 | 0.37  | 0.31             |   |   | 50  | 500 |
| <b>PNF10-10R-L^</b> |             |            | 0.04                  | 0.225           | #10       | 1.06                    | 0.37 | 0.31 | 50  | 500              |   |   |     |     |
| <b>PNF10-14R-L^</b> |             |            | 0.04                  | 0.225           | 1/4"      | 1.21                    | 0.52 | 0.38 | 50  | 500              |   |   |     |     |
| <b>PNF10-56R-L^</b> |             |            | 0.04                  | 0.225           | 5/16"     | 1.21                    | 0.52 | 0.38 | 50  | 500              |   |   |     |     |
| <b>PNF10-38R-L^</b> |             |            | 0.04                  | 0.225           | 3/8"      | 1.29                    | 0.58 | 0.43 | 50  | 500              |   |   |     |     |

\*\*Bulk packaging may be available, contact Panduit Customer Service for additional information.

^For military specification cross reference see page D1.96.

‡UL and CSA approved tooling/product combinations. For crimping tool information, see pages D1.83, D1.84, D1.86 and D1.88.

A. System Overview

B1. Cable Ties

B2. Cable Accessories

B3. Stainless Steel Ties

C1. Wiring Duct

C2. Surface Raceway

C3. Abrasion Protection

C4. Cable Management

D1. Terminals

D2. Power Connectors

D3. Grounding Connectors

E1. Labeling Systems

E2. Labels

E3. Pre-Printed & Write-On Markers

E4. Permanent Identification

E5. Lockout/Tagout & Safety Solutions

F. Index

A. System Overview

B1. Cable Ties

B2. Cable Accessories

B3. Stainless Steel Ties

C1. Wiring Duct

C2. Surface Raceway

C3. Abrasion Protection

C4. Cable Management

D1. Terminals

D2. Power Connectors

D3. Grounding Connectors

E1. Labeling Systems

E2. Labels

E3. Pre-Printed & Write-On Markers

E4. Permanent Identification

E5. Lockout/Tagout & Safety Solutions

F. Index



## Ring Terminal, Nylon Insulated – Expanded Insulation

### Type PN-RX

- Expanded wire entry designed to accommodate wire with a larger insulation thickness
- Ring tongue design assures a secure connection in high vibration applications
- Metal insulation grip sleeve crimps to wire insulation, providing protection to the crimp joint during high vibration applications
- Internal barrel serrations assure good wire contact and maximum tensile strength
- UL Flammability UL 94V-2/HB, maximum insulation temperature 221°F (105°C)
- UL and CSA rated up to 600 V per UL 486A/B

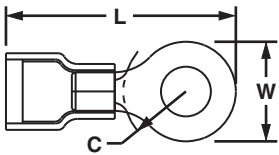

| Part Number        | Wire Range  | Color Code | Stock Thickness (In.) | Max. Ins. (In.) | Stud Size | Figure Dimensions (In.) |      |      | Recommended Installation Tool                     | Std. Pkg. Qty.** | Std. Ctn. Qty. |
|--------------------|-------------|------------|-----------------------|-----------------|-----------|-------------------------|------|------|---|------------------|----------------|
|                    |             |            |                       |                 |           | L                       | W    | C    |   |                  |                |
| <b>PN14-6RX-C</b>  | 16 – 14 AWG | Blue       | 0.03                  | 0.200           | #6        | 0.93                    | 0.31 | 0.25 | CT-100A‡, CT-600-A‡, CT-1550‡, CT-1551‡, CT-2500‡ | 100              | 500            |
| <b>PN14-8RX-C</b>  |             |            | 0.03                  | 0.200           | #8        | 0.93                    | 0.31 | 0.25 |   |                  |                |
| <b>PN14-10RX-C</b> |             |            | 0.03                  | 0.200           | #10       | 0.93                    | 0.31 | 0.25 |   |                  |                |
| <b>PN14-14RX-L</b> |             |            | 0.03                  | 0.200           | 1/4"      | 1.13                    | 0.46 | 0.38 |   |                  |                |
| <b>PN10-6RX-L</b>  | 12 – 10 AWG | Yellow     | 0.04                  | 0.265           | #6        | 1.13                    | 0.37 | 0.33 | CT-100A‡, CT-600-A‡, CT-1550‡, CT-1551‡, CT-2500‡ | 50               | 500            |
| <b>PN10-8RX-L</b>  |             |            | 0.04                  | 0.265           | #8        | 1.13                    | 0.37 | 0.33 |   |                  |                |
| <b>PN10-10RX-L</b> |             |            | 0.04                  | 0.265           | #10       | 1.13                    | 0.37 | 0.33 |   |                  |                |
| <b>PN10-14RX-L</b> |             |            | 0.04                  | 0.265           | 1/4"      | 1.27                    | 0.52 | 0.42 |   |                  |                |
| <b>PN10-56RX-L</b> |             |            | 0.04                  | 0.265           | 5/16"     | 1.27                    | 0.52 | 0.42 |   |                  |                |
| <b>PN10-38RX-L</b> |             |            | 0.04                  | 0.265           | 3/8"      | 1.35                    | 0.58 | 0.46 |   |                  |                |

\*\*Bulk packaging may be available, contact Panduit Customer Service for additional information.  
 ‡UL and CSA approved tooling/product combinations. For crimping tool information, see pages D1.83, D1.84, D1.86 and D1.88.



## Multiple Stud Terminal, Nylon Insulated

### Type PN-610R

- Teardrop shaped mounting hole of multiple stud terminals permits use with #6, #8, or #10 size studs
- Ring tongue design assures a secure connection in high vibration applications
- Metal insulation grip sleeve crimps to wire insulation, providing protection to the crimp joint during high vibration applications
- Internal barrel serrations assure good wire contact and maximum tensile strength
- UL Flammability UL 94V-2/HB, maximum insulation temperature 221°F (105°C)
- UL and CSA rated up to 600 V per UL 486A/B

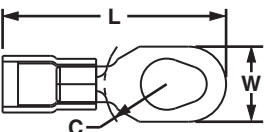

| Part Number        | Wire Range  | Color Code | Stock Thickness (In.) | Max. Ins. (In.) | Stud Size   | Figure Dimensions (In.) |      |      | Recommended Installation Tool                             | Std. Pkg. Qty.** | Std. Ctn. Qty. |
|--------------------|-------------|------------|-----------------------|-----------------|-------------|-------------------------|------|------|---|------------------|----------------|
|                    |             |            |                       |                 |             | L                       | W    | C    |   |                  |                |
| <b>PN18-610R-C</b> | 22 – 18 AWG | Red        | 0.03                  | 0.145           | #6, #8, #10 | 0.95                    | 0.31 | 0.25 | CT-100A‡, CT-600-A‡, CT-1550‡, CT-1551‡, CT-2500‡, CT-400 | 100              | 500            |
| <b>PN14-610R-C</b> | 16 – 14 AWG | Blue       | 0.03                  | 0.165           |             | 0.95                    | 0.31 | 0.25 |   |                  |                |
| <b>PN10-610R-L</b> | 12 – 10 AWG | Yellow     | 0.04                  | 0.225           |             | 1.17                    | 0.37 | 0.33 |   |                  |                |

\*\*Bulk packaging may be available, contact Panduit Customer Service for additional information.  
 ‡UL and CSA approved tooling/product combinations. For crimping tool information, see pages D1.83, D1.84, D1.86 and D1.88.



## Ring Terminal, Vinyl Insulated – Funnel Entry

### Type PV-R

- Insulation support helps to prevent wire damage in bending applications
- Ring tongue design assures a secure connection in high vibration applications
- Brazed seam protects terminal barrel from splitting during the crimp process

- Internal barrel serrations assure good wire contact and maximum tensile strength
- UL Flammability UL 94V-0, maximum insulation temperature 221°F (105°C)
- UL and CSA rated up to 600 V per UL 486A/B

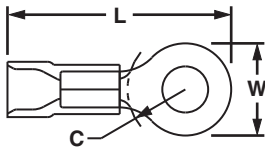

| Part Number  | Wire Range  | Color Code | Stock Thickness (In.) | Max. Ins. (In.) | Stud Size | Figure Dimensions (In.) |      |      | Recommended Installation Tool                     | Std. Pkg. Qty.** | Std. Ctn. Qty. |
|--------------|-------------|------------|-----------------------|-----------------|-----------|-------------------------|------|------|---|------------------|----------------|
|              |             |            |                       |                 |           | L                       | W    | C    |   |                  |                |
| PV22-2R-CY*  | 26 – 22 AWG | Yellow     | 0.02                  | 0.110           | #2        | 0.68                    | 0.21 | 0.18 | CT-600-A, CT-1525, CT-2500                        | 100              | 1000           |
| PV22-4R-CY*  |             |            | 0.02                  | 0.110           | #4        | 0.68                    | 0.21 | 0.18 |   | 100              | 1000           |
| PV22-6R-CY*  |             |            | 0.02                  | 0.110           | #6        | 0.68                    | 0.21 | 0.18 |   | 100              | 1000           |
| PV22-8R-CY*  |             |            | 0.02                  | 0.110           | #8        | 0.78                    | 0.26 | 0.26 |   | 100              | 1000           |
| PV22-10R-CY* |             |            | 0.02                  | 0.110           | #10       | 0.78                    | 0.32 | 0.24 |   | 100              | 1000           |
| PV18-4R-CY   | 22 – 18 AWG | Red        | 0.03                  | 0.150           | #4        | 0.84                    | 0.25 | 0.22 | CT-100A‡, CT-600-A‡, CT-1550‡, CT-1551‡, CT-2500‡ | 100              | 500            |
| PV18-6R-CY   |             |            | 0.03                  | 0.150           | #6        | 0.86                    | 0.25 | 0.22 |   | 100              | 500            |
| PV18-8R-CY   |             |            | 0.03                  | 0.150           | #8        | 0.91                    | 0.31 | 0.26 |   | 100              | 500            |
| PV18-10R-CY  |             |            | 0.03                  | 0.150           | #10       | 0.94                    | 0.31 | 0.27 |   | 100              | 500            |
| PV18-14R-CY  |             |            | 0.03                  | 0.150           | 1/4"      | 1.11                    | 0.46 | 0.37 |   | 100              | 500            |
| PV18-56R-CY  |             |            | 0.03                  | 0.150           | 5/16"     | 1.11                    | 0.46 | 0.39 |   | 100              | 500            |
| PV18-38R-LY  |             |            | 0.03                  | 0.150           | 3/8"      | 1.19                    | 0.53 | 0.42 |   | 50               | 500            |
| PV18-12R-LY  | 0.03        | 0.150      | 1/2"                  | 1.42            | 0.72      | 0.53                    | 50   | 500  |   |                  |                |
| PV14-4R-C    | 16 – 14 AWG | Blue       | 0.03                  | 0.170           | #4        | 0.84                    | 0.25 | 0.19 | CT-100A‡, CT-600-A‡, CT-1550‡, CT-1551‡, CT-2500‡ | 100              | 500            |
| PV14-6RN-C   |             |            | 0.03                  | 0.170           | #6        | 0.84                    | 0.25 | 0.19 |   | 100              | 500            |
| PV14-6R-C    |             |            | 0.03                  | 0.170           | #6        | 0.92                    | 0.31 | 0.25 |   | 100              | 500            |
| PV14-8R-C    |             |            | 0.03                  | 0.170           | #8        | 0.92                    | 0.31 | 0.25 |   | 100              | 500            |
| PV14-10R-C   |             |            | 0.03                  | 0.170           | #10       | 0.92                    | 0.31 | 0.25 |   | 100              | 500            |
| PV14-14R-C   |             |            | 0.03                  | 0.170           | 1/4"      | 1.12                    | 0.46 | 0.38 |   | 100              | 500            |
| PV14-56R-C   |             |            | 0.03                  | 0.170           | 5/16"     | 1.12                    | 0.46 | 0.38 |   | 100              | 500            |
| PV14-38R-L   |             |            | 0.03                  | 0.170           | 3/8"      | 1.21                    | 0.53 | 0.43 |   | 50               | 500            |
| PV14-12R-L   |             |            | 0.03                  | 0.170           | 1/2"      | 1.42                    | 0.72 | 0.53 |   | 50               | 500            |
| PV10-6R-L    |             |            | 12 – 10 AWG           | Yellow          | 0.04      | 0.225                   | #6   | 1.05 |   | 0.31             | 0.31           |
| PV10-8R-L    | 0.04        | 0.225      |                       |                 | #8        | 1.05                    | 0.31 | 0.31 | 50  | 500              |                |
| PV10-10R-L   | 0.04        | 0.225      |                       |                 | #10       | 1.05                    | 0.31 | 0.31 | 50  | 500              |                |
| PV10-14R-L   | 0.04        | 0.225      |                       |                 | 1/4"      | 1.23                    | 0.52 | 0.38 | 50  | 500              |                |
| PV10-56R-L   | 0.04        | 0.225      |                       |                 | 5/16"     | 1.23                    | 0.52 | 0.38 | 50  | 500              |                |
| PV10-38R-L   | 0.04        | 0.225      |                       |                 | 3/8"      | 1.31                    | 0.58 | 0.41 | 50  | 500              |                |
| PV10-12R-Q   | 0.04        | 0.225      |                       |                 | 1/2"      | 1.46                    | 0.72 | 0.53 | 25  | 250              |                |

\*Wire sizes #26 – 22 AWG, are not UL Listed or CSA Certified.

\*\*Bulk packaging may be available, contact Panduit Customer Service for additional information.

‡UL and CSA approved tooling/product combinations. For crimping tool information, see pages D1.83, D1.84, D1.86 and D1.88.

A. System Overview

B1. Cable Ties

B2. Cable Accessories

B3. Stainless Steel Ties

C1. Wiring Duct

C2. Surface Raceway

C3. Abrasion Protection

C4. Cable Management

D1. Terminals

D2. Power Connectors

D3. Grounding Connectors

E1. Labeling Systems

E2. Labels

E3. Pre-Printed & Write-On Markers

E4. Permanent Identification

E5. Lockout/Tagout & Safety Solutions

F. Index

A. System Overview

B1. Cable Ties

B2. Cable Accessories

B3. Stainless Steel Ties

C1. Wiring Duct

C2. Surface Raceway

C3. Abrasion Protection

C4. Cable Management

D1. Terminals

D2. Power Connectors

D3. Grounding Connectors

E1. Labeling Systems

E2. Labels

E3. Pre-Printed & Write-On Markers

E4. Permanent Identification

E5. Lockout/Tagout & Safety Solutions

F. Index



## Ring Terminal, Vinyl Expanded Insulation

### Type PV-RX

- Expanded wire entry designed to accommodate wire with a larger insulation thickness
- Ring tongue design assures a secure connection in high vibration applications
- Insulation support helps to prevent wire damage in bending applications
- Brazed seam protects terminal barrel from splitting during the crimp process
- Internal barrel serrations assure good wire contact and maximum tensile strength
- UL Flammability UL 94V-0, maximum insulation temperature 221°F (105°C)
- UL and CSA rated up to 600 V per UL 486A/B

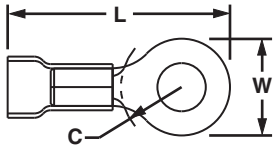

| Part Number  | Wire Range  | Color Code | Stock Thickness (In.) | Max. Ins. (In.) | Stud Size | Figure Dimensions (In.) |      |      | Recommended Installation Tool                     | Std. Pkg. Qty.** | Std. Ctn. Qty.                                    |
|--------------|-------------|------------|-----------------------|-----------------|-----------|-------------------------|------|------|---|------------------|---|
|              |             |            |                       |                 |           | L                       | W    | C    |   |                  |   |
| PV18-4RX-CY  | 22 – 18 AWG | Red        | 0.03                  | 0.170           | #4        | 0.88                    | 0.25 | 0.22 | CT-100A‡, CT-600-A‡, CT-1550‡, CT-1551‡, CT-2500‡ | 100              | 500   |
| PV18-6RX-CY  |             |            | 0.03                  | 0.170           | #6        | 0.89                    | 0.25 | 0.22 |   |                  |   |
| PV18-8RX-CY  |             |            | 0.03                  | 0.170           | #8        | 0.97                    | 0.31 | 0.27 |   |                  |   |
| PV18-10RX-CY |             |            | 0.03                  | 0.170           | #10       | 0.96                    | 0.31 | 0.27 |   |                  |   |
| PV18-14RX-CY |             |            | 0.03                  | 0.170           | 1/4"      | 1.17                    | 0.46 | 0.40 |   |                  |   |
| PV18-56RX-LY |             |            | 0.03                  | 0.170           | 5/16"     | 1.17                    | 0.46 | 0.40 |   |                  |   |
| PV18-38RX-LY |             |            | 0.03                  | 0.170           | 3/8"      | 1.25                    | 0.53 | 0.45 |   |                  |   |
| PV14-4RX-C   |             |            | 16 – 14 AWG           | Blue            | 0.03      | 0.200                   | #4   | 0.87 |   |                  |   |
| PV14-6RX-C   | 0.03        | 0.200      |                       |                 | #6        | 0.96                    | 0.31 | 0.25 |   |                  |   |
| PV14-8RX-C   | 0.03        | 0.200      |                       |                 | #8        | 0.96                    | 0.31 | 0.25 |   |                  |   |
| PV14-10RX-C  | 0.03        | 0.200      |                       |                 | #10       | 0.96                    | 0.31 | 0.25 |   |                  |   |
| PV14-14RX-L  | 0.03        | 0.200      |                       |                 | 1/4"      | 1.16                    | 0.46 | 0.37 |   |                  |   |
| PV14-56RX-L  | 0.03        | 0.200      |                       |                 | 5/16"     | 1.16                    | 0.46 | 0.37 |   |                  |   |
| PV14-38RX-L  | 0.03        | 0.200      |                       |                 | 3/8"      | 1.25                    | 0.53 | 0.42 |   |                  |   |
| PV10-6RX-L   | 12 – 10 AWG | Yellow     |                       |                 | 0.04      | 0.250                   | #6   | 1.10 | 0.31  | 0.30             | CT-100A‡, CT-600-A‡, CT-1550‡, CT-1551‡, CT-2500‡ |
| PV10-8RX-L   |             |            | 0.04                  | 0.250           | #8        | 1.10                    | 0.31 | 0.30 |   |                  |   |
| PV10-10RX-L  |             |            | 0.04                  | 0.250           | #10       | 1.10                    | 0.31 | 0.30 |   |                  |   |
| PV10-14RX-L  |             |            | 0.04                  | 0.250           | 1/4"      | 1.29                    | 0.52 | 0.39 |   |                  |   |
| PV10-56RX-L  |             |            | 0.04                  | 0.250           | 5/16"     | 1.29                    | 0.52 | 0.42 |   |                  |   |
| PV10-38RX-L  |             |            | 0.04                  | 0.250           | 3/8"      | 1.39                    | 0.58 | 0.46 |   |                  |   |

\*\*Bulk packaging may be available, contact Panduit Customer Service for additional information.

‡UL and CSA approved tooling/product combinations. For crimping tool information, see pages D1.83, D1.84, D1.86 and D1.88.



## Multiple Stud Terminal, Vinyl Insulated – Funnel Entry

### Type PV-610R

- Teardrop shaped mounting hole of multiple stud terminals permits use with #6, #8, or #10 size studs
- Ring tongue design assures a secure connection in high vibration applications
- Insulation support helps to prevent wire damage in bending applications
- Brazed seam protects terminal barrel from splitting during the crimp process
- Internal barrel serrations assure good wire contact and maximum tensile strength
- UL Flammability UL 94V-0, maximum insulation temperature 221°F (105°C)
- UL and CSA rated up to 600 V per UL 486A/B

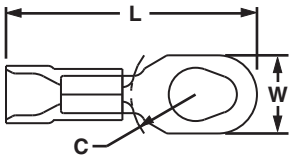

| Part Number         | Wire Range  | Color Code | Stock Thickness (In.) | Max. Ins. (In.) | Stud Size   | Figure Dimensions (In.) |      |      | Recommended Installation Tool                    | Std. Pkg. Qty.** | Std. Ctn. Qty. |
|---------------------|-------------|------------|-----------------------|-----------------|-------------|-------------------------|------|------|--|------------------|----------------|
|                     |             |            |                       |                 |             | L                       | W    | C    |  |                  |                |
| <b>PV18-610R-CY</b> | 22 – 18 AWG | Red        | 0.03                  | 0.150           | #6, #8, #10 | 1.00                    | 0.31 | 0.25 | CT-100A, CT-600-A‡, CT-1550‡, CT-1551‡, CT-2500‡ | 100              | 500            |
| <b>PV14-610R-C</b>  | 16 – 14 AWG | Blue       | 0.03                  | 0.170           |             | 1.00                    | 0.31 | 0.25 |  | 100              | 500            |
| <b>PV10-610R-L</b>  | 12 – 10 AWG | Yellow     | 0.04                  | 0.225           |             | 1.17                    | 0.37 | 0.31 |  | 50               | 500            |

\*\*Bulk packaging may be available, contact Panduit Customer Service for additional information.  
 ‡UL and CSA approved tooling/product combinations. For crimping tool information, see pages D1.83, D1.84, D1.86 and D1.88.

A. System Overview

B1. Cable Ties

B2. Cable Accessories

B3. Stainless Steel Ties

C1. Wiring Duct

C2. Surface Raceway

C3. Abrasion Protection

C4. Cable Management

D1. Terminals

D2. Power Connectors

D3. Grounding Connectors

E1. Labeling Systems

E2. Labels

E3. Pre-Printed & Write-On Markers

E4. Permanent Identification

E5. Lockout/Tagout & Safety Solutions

F. Index

A. System Overview

B1. Cable Ties

B2. Cable Accessories

B3. Stainless Steel Ties

C1. Wiring Duct

C2. Surface Raceway

C3. Abrasion Protection

C4. Cable Management

D1. Terminals

D2. Power Connectors

D3. Grounding Connectors

E1. Labeling Systems

E2. Labels

E3. Pre-Printed & Write-On Markers

E4. Permanent Identification

E5. Lockout/Tagout & Safety Solutions

F. Index



## Ring Terminal, KYNAR® Insulated

### Type PK-R

- For nuclear containment areas and high temperature to 300°F (150°C) applications
- Color code: natural with appropriate color stripe to identify wire range
- Ring tongue design assures a secure connection in high vibration applications

- UL and CSA rated up to 600 V per UL 486A/B

**Note: For PK18 – PK10 Terminals the following applies:**

- Classified as Class 1E in accordance with IEEE 323-2003
- Metal insulation grip sleeve crimps to wire insulation, providing protection to the crimp joint during high vibration applications



| Part Number | Wire Range  | Color Code    | Stock Thickness (In.) | Max. Ins. (In.) | Stud Size | Figure Dimensions (In.) |      |      | Recommended Installation Tool                    | Std. Pkg. Qty.** | Std. Ctn. Qty. |
|-------------|-------------|---------------|-----------------------|-----------------|-----------|-------------------------|------|------|--|------------------|----------------|
|             |             |               |                       |                 |           | L                       | W    | C    |  |                  |                |
| PK18-4R-C   | 22 – 16 AWG | Red Stripe    | 0.03                  | 0.145           | #4        | 0.80                    | 0.25 | 0.22 | CT-100A, CT-600-A‡, CT-1550‡, CT-1551‡, CT-2500‡ | 100              | 500            |
| PK18-6R-C   |             |               | 0.03                  | 0.145           | #6        | 0.80                    | 0.25 | 0.22 |  | 100              | 500            |
| PK18-8R-C   |             |               | 0.03                  | 0.145           | #8        | 0.89                    | 0.31 | 0.29 |  | 100              | 500            |
| PK18-10R-C  |             |               | 0.03                  | 0.145           | #10       | 0.89                    | 0.31 | 0.29 |  | 100              | 500            |
| PK18-14R-C  |             |               | 0.03                  | 0.145           | 1/4"      | 1.10                    | 0.46 | 0.40 |  | 100              | 500            |
| PK18-38R-C  |             |               | 0.03                  | 0.145           | 3/8"      | 1.18                    | 0.53 | 0.45 |  | 100              | 500            |
| PK18-56R-C  | 18 – 14 AWG | Blue Stripe   | 0.03                  | 0.145           | 5/16"     | 1.10                    | 0.46 | 0.40 | CT-100A, CT-600-A‡, CT-1550‡, CT-1551‡, CT-2500‡ | 100              | 500            |
| PK14-4R-C   |             |               | 0.03                  | 0.162           | #4        | 0.78                    | 0.25 | 0.22 |  | 100              | 500            |
| PK14-6R-C   |             |               | 0.03                  | 0.162           | #6        | 0.87                    | 0.31 | 0.29 |  | 100              | 500            |
| PK14-8R-C   |             |               | 0.03                  | 0.162           | #8        | 0.87                    | 0.31 | 0.29 |  | 100              | 500            |
| PK14-10R-C  |             |               | 0.03                  | 0.162           | #10       | 0.87                    | 0.31 | 0.29 |  | 100              | 500            |
| PK14-14R-C  |             |               | 0.03                  | 0.162           | 1/4"      | 1.08                    | 0.46 | 0.40 |  | 100              | 500            |
| PK14-38R-C  | 12 – 10 AWG | Yellow Stripe | 0.03                  | 0.162           | 3/8"      | 1.15                    | 0.53 | 0.43 | CT-100A, CT-600-A‡, CT-1550‡, CT-1551‡, CT-2500‡ | 100              | 500            |
| PK14-56R-C  |             |               | 0.03                  | 0.162           | 5/16"     | 1.08                    | 0.46 | 0.40 |  | 100              | 500            |
| PK10-6R-L   |             |               | 0.04                  | 0.225           | #6        | 1.06                    | 0.37 | 0.33 |  | 50               | 500            |
| PK10-8R-L   |             |               | 0.04                  | 0.225           | #8        | 1.06                    | 0.37 | 0.33 |  | 50               | 500            |
| PK10-10R-L  |             |               | 0.04                  | 0.225           | #10       | 1.06                    | 0.37 | 0.33 |  | 50               | 500            |
| PK10-14R-L  |             |               | 0.04                  | 0.225           | 1/4"      | 1.25                    | 0.38 | 0.42 |  | 50               | 500            |
| PK10-38R-Q  |             |               | 0.04                  | 0.225           | 3/8"      | 1.34                    | 0.58 | 0.42 | 25   | 125              |                |



### Large Wire, KYNAR® Insulated

|           |       |               |      |       |       |      |      |      |                     |     |      |
|-----------|-------|---------------|------|-------|-------|------|------|------|---------------------|-----|------|
| PK8-8R-T  | 8 AWG | Red Stripe    | 0.04 | 0.326 | #8    | 1.50 | 0.42 | 0.43 | CT-2600, CD-2600-8‡ | 200 | 1200 |
| PK8-10R-T |       |               | 0.04 | 0.326 | #10   | 1.52 | 0.47 | 0.43 |                     | 200 | 1200 |
| PK8-14R-T |       |               | 0.04 | 0.326 | 1/4"  | 1.52 | 0.47 | 0.43 |                     | 200 | 1200 |
| PK8-56R-T |       |               | 0.04 | 0.326 | 5/16" | 1.63 | 0.59 | 0.51 |                     | 200 | 1200 |
| PK8-38R-T |       |               | 0.04 | 0.326 | 3/8"  | 1.63 | 0.59 | 0.51 |                     | 200 | 1200 |
| PK8-12R-T | 6 AWG | Blue Stripe   | 0.04 | 0.326 | 1/2"  | 1.73 | 0.82 | 0.51 | CT-2600, CD-2600-6‡ | 200 | 1200 |
| PK6-8R-T  |       |               | 0.05 | 0.360 | #8    | 1.59 | 0.47 | 0.43 |                     | 200 | 1200 |
| PK6-10R-T |       |               | 0.05 | 0.360 | #10   | 1.60 | 0.47 | 0.43 |                     | 200 | 1200 |
| PK6-14R-T |       |               | 0.05 | 0.360 | 1/4"  | 1.63 | 0.47 | 0.48 |                     | 200 | 1200 |
| PK6-56R-T |       |               | 0.05 | 0.360 | 5/16" | 1.72 | 0.62 | 0.53 |                     | 200 | 1200 |
| PK6-38R-T | 4 AWG | Yellow Stripe | 0.05 | 0.360 | 3/8"  | 1.72 | 0.62 | 0.51 | CT-2600, CD-2600-4‡ | 200 | 1200 |
| PK6-12R-T |       |               | 0.05 | 0.360 | 1/2"  | 1.82 | 0.82 | 0.51 |                     | 200 | 1200 |
| PK4-10R-T |       |               | 0.05 | 0.450 | #10   | 1.86 | 0.55 | 0.50 |                     | 200 | 1200 |
| PK4-14R-T |       |               | 0.05 | 0.450 | 1/4"  | 1.86 | 0.55 | 0.50 |                     | 200 | 1200 |
| PK4-56R-T |       |               | 0.05 | 0.450 | 5/16" | 1.93 | 0.68 | 0.50 |                     | 200 | 1200 |
| PK4-38R-T | 2 AWG | Red Stripe    | 0.05 | 0.450 | 3/8"  | 1.93 | 0.68 | 0.50 | CT-2600, CD-2600-2‡ | 200 | 1200 |
| PK4-12R-T |       |               | 0.05 | 0.450 | 1/2"  | 2.02 | 0.86 | 0.50 |                     | 200 | 1200 |
| PK2-10R-T |       |               | 0.06 | 0.550 | #10   | 1.95 | 0.68 | 0.58 |                     | 200 | 1200 |
| PK2-14R-T |       |               | 0.06 | 0.550 | 1/4"  | 1.95 | 0.68 | 0.58 |                     | 200 | 1200 |
| PK2-56R-T |       |               | 0.06 | 0.550 | 5/16" | 1.95 | 0.68 | 0.58 |                     | 200 | 1200 |
| PK2-38R-T |       |               | 0.06 | 0.550 | 3/8"  | 1.95 | 0.68 | 0.58 |                     | 200 | 1200 |
| PK2-12R-T |       |               | 0.06 | 0.550 | 1/2"  | 2.04 | 0.86 | 0.58 |                     | 200 | 1200 |

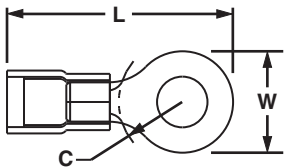

\*KYNAR is a registered trademark of Atofina Chemicals, Inc.

‡UL approved tooling/product combinations. For crimping tool information, see pages D1.83, D1.84, D1.86, D1.88, and D1.89.



**UL LISTED** **CSA CERTIFIED** **Heat Shrink, Ring Terminal**

**Type PH-R**

- Heat shrink sleeving forms a protective barrier to provide environmentally sealed terminations ideal for high moisture applications
- Ring tongue design assures a secure connection in high vibration applications
- Brazed seam protects terminal barrel from splitting during the crimp process

- Heat shrink installation is completed with a standard heat gun
- Minimum continuous operating temperature -65°F (-55°C)
- Maximum continuous operation temperature 230°F (110°C)
- Shrink temperature 300°F (150°C)
- UL and CSA rated up to 600 V per UL 486A/B

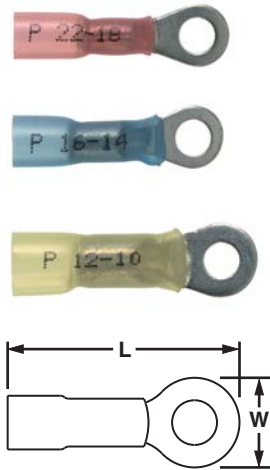

| Part Number | Wire Range  | Color Code | Max. Ins. (In.) | Stud Size (In.) | Figure Dimensions (In.) |      |   | Wire Strip Length (In.) | Recommended Installation Tool | Std. Pkg. Qty. | Std. Ctn. Qty. |
|-------------|-------------|------------|-----------------|-----------------|-------------------------|------|---|-------------------------|-------------------------------|----------------|----------------|
|             |             |            |                 |                 | L                       | W    | C |                         |                               |                |                |
| PH18-6R-Q   | 22 – 18 AWG | Red        | 0.170           | #6              | 1.05                    | 0.25 |   | 5/16                    | CT-310                        | 25             | 125            |
| PH18-8R-Q   |             |            | 0.170           | #8              | 1.08                    | 0.31 |   | 5/16                    |                               | 25             | 125            |
| PH18-10R-Q  |             |            | 0.170           | #10             | 1.08                    | 0.31 |   | 5/16                    |                               | 25             | 125            |
| PH18-14R-Q  |             |            | 0.170           | 1/4"            | 1.24                    | 0.47 |   | 5/16                    |                               | 25             | 125            |
| PH14-6R-Q   | 16 – 14 AWG | Blue       | 0.190           | #6              | 1.06                    | 0.31 |   | 5/16                    | CT-310                        | 25             | 125            |
| PH14-8R-Q   |             |            | 0.190           | #8              | 1.03                    | 0.31 |   | 5/16                    |                               | 25             | 125            |
| PH14-10R-Q  |             |            | 0.190           | #10             | 1.05                    | 0.32 |   | 5/16                    |                               | 25             | 125            |
| PH14-14R-Q  |             |            | 0.190           | 1/4"            | 1.24                    | 0.46 |   | 5/16                    |                               | 25             | 125            |
| PH14-56R-Q  |             |            | 0.190           | 5/16"           | 1.24                    | 0.46 |   | 5/16                    |                               | 25             | 125            |
| PH14-38R-Q  |             |            | 0.190           | 3/8"            | 1.24                    | 0.53 |   | 5/16                    |                               | 25             | 125            |
| PH10-8R-E   | 12 – 10 AWG | Yellow     | 0.240           | #8              | 1.22                    | 0.37 |   | 5/16                    | CT-310                        | 20             | 100            |
| PH10-10R-E  |             |            | 0.240           | #10             | 1.20                    | 0.37 |   | 5/16                    |                               | 20             | 100            |
| PH10-14R-E  |             |            | 0.240           | 1/4"            | 1.20                    | 0.52 |   | 5/16                    |                               | 20             | 100            |
| PH10-38R-E  |             |            | 0.240           | 3/8"            | 1.20                    | 0.59 |   | 5/16                    |                               | 20             | 100            |
| PH10-12R-E  |             |            | 0.240           | 1/2"            | 1.54                    | 0.72 |   | 5/16                    |                               | 20             | 100            |

For crimping tool information, see page D1.85.

**UL LISTED** **CSA CERTIFIED** **Ring Terminal, Heavy Duty, Nylon Insulated**

**Type PN-HDR**

- Manufactured from stock 56% thicker than a standard #16 – #14 AWG terminal for use in heavy-duty applications
- Insulation housing is marked with "HDR" to signify heavy-duty ring
- Ring tongue design assures a secure connection in high vibration applications
- Metal insulation grip sleeve crimps to wire insulation, providing protection to the crimp joint during high vibration applications

- Internal barrel serrations assure good wire contact and maximum tensile strength
- UL Flammability UL 94V-2/HB, maximum insulation temperature 221°F (105°C)
- UL and CSA rated up to 600 V per UL 486A/B

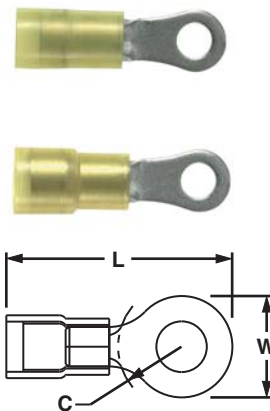

| Part Number  | Wire Range  | Color Code | Stock Thickness (In.) | Max. Ins. (In.) | Stud Size | Figure Dimensions (In.) |      |      | Recommended Installation Tool | Std. Pkg. Qty.** | Std. Ctn. Qty. |
|--------------|-------------|------------|-----------------------|-----------------|-----------|-------------------------|------|------|-------------------------------|------------------|----------------|
|              |             |            |                       |                 |           | L                       | W    | C    |                               |                  |                |
| PN12-8HDR-L  | 16 – 12 AWG | Yellow     | 0.05                  | 0.225           | #8        | 1.06                    | 0.31 | 0.35 | CT-1550‡, CT-1551‡, CT-2500‡  | 50               | 500            |
| PN12-10HDR-L |             |            | 0.05                  | 0.225           | #10       | 1.09                    | 0.37 | 0.33 |                               | 50               | 500            |
| PN12-14HDR-L |             |            | 0.05                  | 0.225           | 1/4"      | 1.24                    | 0.52 | 0.42 |                               | 50               | 500            |
| PN12-56HDR-L |             |            | 0.05                  | 0.225           | 5/16"     | 1.24                    | 0.52 | 0.42 |                               | 50               | 500            |
| PN12-38HDR-L |             |            | 0.05                  | 0.225           | 3/8"      | 1.30                    | 0.58 | 0.46 |                               | 50               | 500            |

\*\*Bulk packaging may be available, contact Panduit Customer Service for additional information.

‡UL and CSA approved tooling/product combinations. For crimping tool information, see pages D1.84 and D1.88.

A. System Overview

B1. Cable Ties

B2. Cable Accessories

B3. Stainless Steel Ties

C1. Wiring Duct

C2. Surface Raceway

C3. Abrasion Protection

C4. Cable Management

D1. Terminals

D2. Power Connectors

D3. Grounding Connectors

E1. Labeling Systems

E2. Labels

E3. Pre-Printed & Write-On Markers

E4. Permanent Identification

E5. Lockout/Tagout & Safety Solutions

F. Index

A. System Overview

B1. Cable Ties



## Ring Terminal, Heavy Duty, Vinyl Insulated – Funnel Entry

### Type PV-HDR

- Manufactured from stock 56% thicker than a standard #16 – 14 AWG terminal for use in heavy-duty applications
- Insulation housing is marked with “HDR” to signify heavy-duty ring
- Ring tongue design assures a secure connection in high vibration applications
- Insulation support helps to prevent wire damage in bending applications
- Brazed seam protects terminal barrel from splitting during the crimp process
- Internal barrel serrations assure good wire contact and maximum tensile strength
- UL Flammability UL 94V-0, maximum insulation temperature 221°F (105°C)
- UL and CSA rated up to 600 V per UL 486A/B

C1. Wiring Duct



C2. Surface Raceway



C3. Abrasion Protection

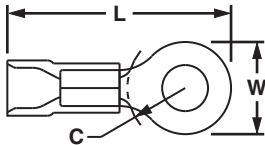

C4. Cable Management

| Part Number | Wire Range | Color Code | Stock Thickness (In.) | Max. Ins. (In.) | Stud Size | Figure Dimensions (In.) |   |   | Recommended Installation Tool | Std. Pkg. Qty.** | Std. Ctn. Qty. |
|-------------|------------|------------|-----------------------|-----------------|-----------|-------------------------|---|---|-------------------------------|------------------|----------------|
|             |            |            |                       |                 |           | L                       | W | C |                               |                  |                |

#### Standard Heavy Duty Insulation

|                     |             |        |      |       |       |      |      |      |   |    |     |
|---------------------|-------------|--------|------|-------|-------|------|------|------|---|----|-----|
| PV12-6HDR-L         | 16 – 12 AWG | Yellow | 0.05 | 0.225 | #6    | 1.05 | 0.31 | 0.35 | CT-600-A‡, CT-1550‡, CT-1551‡, CT-2500‡ | 50 | 500 |
| PV12-8HDR-L         |             |        | 0.05 | 0.225 | #8    | 1.05 | 0.31 | 0.35 |   | 50 | 500 |
| <b>PV12-10HDR-L</b> |             |        | 0.05 | 0.225 | #10   | 1.08 | 0.37 | 0.33 |   | 50 | 500 |
| <b>PV12-14HDR-L</b> |             |        | 0.05 | 0.225 | 1/4"  | 1.23 | 0.52 | 0.42 |   | 50 | 500 |
| PV12-56HDR-L        |             |        | 0.05 | 0.225 | 5/16" | 1.23 | 0.52 | 0.42 |   | 50 | 500 |
| PV12-38HDR-L        |             |        | 0.05 | 0.225 | 3/8"  | 1.31 | 0.58 | 0.46 |   | 50 | 500 |

#### Expanded Heavy Duty Insulation\*

|                      |             |        |      |       |       |      |      |      |   |    |     |
|----------------------|-------------|--------|------|-------|-------|------|------|------|---|----|-----|
| PV12-6HDRX-L         | 16 – 12 AWG | Yellow | 0.05 | 0.250 | #6    | 1.05 | 0.31 | 0.35 | CT-600-A‡, CT-1550‡, CT-1551‡, CT-2500‡ | 50 | 500 |
| PV12-8HDRX-L         |             |        | 0.05 | 0.250 | #8    | 1.05 | 0.31 | 0.35 |   | 50 | 500 |
| <b>PV12-10HDRX-L</b> |             |        | 0.05 | 0.250 | #10   | 1.08 | 0.37 | 0.33 |   | 50 | 500 |
| <b>PV12-14HDRX-L</b> |             |        | 0.05 | 0.250 | 1/4"  | 1.23 | 0.52 | 0.42 |   | 50 | 500 |
| PV12-56HDRX-L        |             |        | 0.05 | 0.250 | 5/16" | 1.23 | 0.52 | 0.42 |   | 50 | 500 |
| PV12-38HDRX-L        |             |        | 0.05 | 0.250 | 3/8"  | 1.31 | 0.58 | 0.46 |   | 50 | 500 |

\*Expanded insulation parts do not have funnel entry.

\*\*Bulk packaging may be available, contact Panduit Customer Service for additional information.

‡UL and CSA approved tooling/product combinations. For tooling information, see pages D1.84, D1.86, and D1.88.

D1. Terminals

D2. Power Connectors

D3. Grounding Connectors

E1. Labeling Systems

E2. Labels

E3. Pre-Printed & Write-On Markers

E4. Permanent Identification

E5. Lockout/Tagout & Safety Solutions

F. Index

## Ring Terminal, Large Wire, Vinyl Insulated

### Type PV-R

- Ring tongue design assures a secure connection in high vibration applications
- Insulation support helps to prevent wire damage in bending applications
- Brazed seam protects terminal barrel from splitting during the crimp process
- Internal barrel serrations assure good wire contact and maximum tensile strength
- UL Flammability UL 94V-0, maximum insulation temperature 221°F (105°C)
- UL rated up to 600 V per UL 486A/B

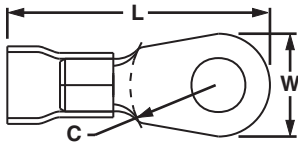

| Part Number | Wire Range | Color Code | Stock Thickness (In.) | Max. Ins. (In.) | Stud Size | Figure Dimensions (In.) |      |      | Recommended Installation Tool                        | Std. Pkg. Qty.** | Std. Ctn. Qty. |
|-------------|------------|------------|-----------------------|-----------------|-----------|-------------------------|------|------|--|------------------|----------------|
|             |            |            |                       |                 |           | L                       | W    | C    |  |                  |                |
| PV8-8R-QY   | 8 AWG      | Red        | 0.04                  | 0.280           | #8        | 1.51                    | 0.42 | 0.43 | CT-720,<br>CD-720PV8-2‡,<br>CT-2600,<br>CD-2600-PV8‡ | 25               | 250            |
| PV8-10R-QY  |            |            | 0.04                  | 0.280           | #10       | 1.53                    | 0.47 | 0.43 |  | 25               | 250            |
| PV8-14R-QY  |            |            | 0.04                  | 0.280           | 1/4"      | 1.53                    | 0.47 | 0.43 |  | 25               | 250            |
| PV8-56R-QY  |            |            | 0.04                  | 0.280           | 5/16"     | 1.64                    | 0.59 | 0.49 |  | 25               | 250            |
| PV8-38R-QY  |            |            | 0.04                  | 0.280           | 3/8"      | 1.64                    | 0.59 | 0.51 |  | 25               | 250            |
| PV8-12R-XY  |            |            | 0.04                  | 0.280           | 1/2"      | 1.74                    | 0.82 | 0.51 |  | 10               | 100            |
| PV6-8R-E    | 6 AWG      | Blue       | 0.05                  | 0.340           | #8        | 1.61                    | 0.47 | 0.43 | CT-720,<br>CD-720PV8-2‡,<br>CT-2600,<br>CD-2600-PV6‡ | 20               | 200            |
| PV6-10R-X   |            |            | 0.05                  | 0.340           | #10       | 1.62                    | 0.47 | 0.43 |  | 10               | 100            |
| PV6-14R-X   |            |            | 0.05                  | 0.340           | 1/4"      | 1.65                    | 0.47 | 0.48 |  | 10               | 100            |
| PV6-56R-X   |            |            | 0.05                  | 0.340           | 5/16"     | 1.74                    | 0.62 | 0.53 |  | 10               | 100            |
| PV6-38R-X   |            |            | 0.05                  | 0.340           | 3/8"      | 1.74                    | 0.62 | 0.51 |  | 10               | 100            |
| PV6-12R-X   |            |            | 0.05                  | 0.340           | 1/2"      | 1.84                    | 0.82 | 0.51 |  | 10               | 100            |
| PV4-10R-E   | 4 AWG      | Yellow     | 0.05                  | 0.450           | #10       | 1.88                    | 0.55 | 0.50 | CT-720,<br>CD-720PV8-2‡,<br>CT-2600,<br>CD-2600-PV4‡ | 20               | 200            |
| PV4-14R-E   |            |            | 0.05                  | 0.450           | 1/4"      | 1.88                    | 0.55 | 0.50 |  | 20               | 200            |
| PV4-56R-E   |            |            | 0.05                  | 0.450           | 5/16"     | 1.95                    | 0.68 | 0.50 |  | 20               | 200            |
| PV4-38R-E   |            |            | 0.05                  | 0.450           | 3/8"      | 1.95                    | 0.68 | 0.50 |  | 20               | 200            |
| PV4-12R-E   |            |            | 0.05                  | 0.450           | 1/2"      | 2.04                    | 0.86 | 0.50 |  | 20               | 200            |
| PV2-10R-XY  | 2 AWG      | Red        | 0.06                  | 0.560           | #10       | 1.96                    | 0.68 | 0.58 | CT-720,<br>CD-720PV8-2‡,<br>CT-2600,<br>CD-2600-PV2‡ | 10               | 100            |
| PV2-14R-XY  |            |            | 0.06                  | 0.560           | 1/4"      | 1.96                    | 0.68 | 0.58 |  | 10               | 100            |
| PV2-56R-XY  |            |            | 0.06                  | 0.560           | 5/16"     | 1.96                    | 0.68 | 0.58 |  | 10               | 100            |
| PV2-38R-XY  |            |            | 0.06                  | 0.560           | 3/8"      | 1.96                    | 0.68 | 0.58 |  | 10               | 100            |
| PV2-12R-XY  |            |            | 0.06                  | 0.560           | 1/2"      | 2.05                    | 0.86 | 0.58 |  | 10               | 100            |

\*\*Bulk packaging may be available, contact Panduit Customer Service for additional information.

‡UL approved tooling/product combinations. For crimping tool information, see page D1.87 and D1.89.

A.  
System  
Overview

B1.  
Cable Ties

B2.  
Cable  
Accessories

B3.  
Stainless  
Steel Ties

C1.  
Wiring  
Duct

C2.  
Surface  
Raceway

C3.  
Abrasion  
Protection

C4.  
Cable  
Management

D1.  
Terminals

D2.  
Power  
Connectors

D3.  
Grounding  
Connectors

E1.  
Labeling  
Systems

E2.  
Labels

E3.  
Pre-Printed  
& Write-On  
Markers

E4.  
Permanent  
Identification

E5.  
Lockout/  
Tagout  
& Safety  
Solutions

F.  
Index

A. System Overview

B1. Cable Ties

B2. Cable Accessories

B3. Stainless Steel Ties

C1. Wiring Duct

C2. Surface Raceway

C3. Abrasion Protection

C4. Cable Management

D1. Terminals

D2. Power Connectors

D3. Grounding Connectors

E1. Labeling Systems

E2. Labels

E3. Pre-Printed & Write-On Markers

E4. Permanent Identification

E5. Lockout/Tagout & Safety Solutions

F. Index



## Ring Terminal, Large Wire, Vinyl Expanded Insulation

### Type PV-RX

- Ring tongue design assures a secure connection in high vibration applications
- Expanded wire entry designed to accommodate wire with a larger insulation thickness
- Insulation support helps to prevent wire damage in bending applications
- Brazed seam protects terminal barrel from splitting during the crimp process
- Internal barrel serrations assure good wire contact and maximum tensile strength
- UL Flammability UL 94V-0, maximum insulation temperature 221°F (105°C)
- UL rated up to 600 V per UL 486A/B

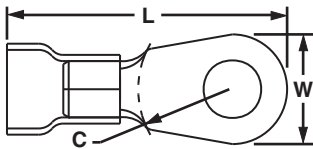

| Part Number | Wire Range | Color Code | Stock Thickness (In.) | Max. Ins. (In.) | Stud Size | Figure Dimensions (In.) |      |      | Recommended Installation Tool                        | Std. Pkg. Qty.** | Std. Ctn. Qty. |
|-------------|------------|------------|-----------------------|-----------------|-----------|-------------------------|------|------|--|------------------|----------------|
|             |            |            |                       |                 |           | L                       | W    | C    |  |                  |                |
| PV8-8RX-QY  | 8 AWG      | Red        | 0.04                  | 0.360           | #8        | 1.50                    | 0.42 | 0.43 | CT-720,<br>CD-720PV8-2‡,<br>CT-2600,<br>CD-2600-PV8‡ | 25               | 250            |
| PV8-10RX-QY |            |            | 0.04                  | 0.360           | #10       | 1.52                    | 0.47 | 0.43 |  | 25               | 250            |
| PV8-14RX-QY |            |            | 0.04                  | 0.360           | 1/4"      | 1.52                    | 0.47 | 0.43 |  | 25               | 250            |
| PV8-56RX-QY |            |            | 0.04                  | 0.360           | 5/16"     | 1.62                    | 0.59 | 0.51 |  | 25               | 250            |
| PV8-38RX-QY |            |            | 0.04                  | 0.360           | 3/8"      | 1.62                    | 0.59 | 0.51 |  | 25               | 250            |
| PV8-12RX-XY |            |            | 0.04                  | 0.360           | 1/2"      | 1.74                    | 0.82 | 0.51 |  | 10               | 100            |
| PV6-8RX-E   | 6 AWG      | Blue       | 0.05                  | 0.436           | #8        | 1.61                    | 0.47 | 0.43 | CT-720,<br>CD-720PV8-2‡,<br>CT-2600,<br>CD-2600-PV6‡ | 20               | 200            |
| PV6-10RX-X  |            |            | 0.05                  | 0.436           | #10       | 1.61                    | 0.47 | 0.43 |  | 10               | 100            |
| PV6-14RX-X  |            |            | 0.05                  | 0.436           | 1/4"      | 1.61                    | 0.47 | 0.43 |  | 10               | 100            |
| PV6-56RX-X  |            |            | 0.05                  | 0.436           | 5/16"     | 1.73                    | 0.62 | 0.51 |  | 10               | 100            |
| PV6-38RX-X  |            |            | 0.05                  | 0.436           | 3/8"      | 1.73                    | 0.62 | 0.53 |  | 10               | 100            |
| PV4-10RX-E  | 4 AWG      | Yellow     | 0.05                  | 0.515           | #10       | 1.87                    | 0.55 | 0.53 | CT-720,<br>CD-720PV8-2‡,<br>CT-2600,<br>CD-2600-PV4‡ | 20               | 200            |
| PV4-14RX-E  |            |            | 0.05                  | 0.515           | 1/4"      | 1.87                    | 0.55 | 0.53 |  | 20               | 200            |
| PV4-56RX-E  |            |            | 0.05                  | 0.515           | 5/16"     | 1.94                    | 0.68 | 0.53 |  | 20               | 200            |
| PV4-38RX-E  |            |            | 0.05                  | 0.515           | 3/8"      | 1.94                    | 0.68 | 0.53 |  | 20               | 200            |
| PV4-12RX-E  |            |            | 0.05                  | 0.515           | 1/2"      | 2.03                    | 0.86 | 0.53 |  | 20               | 200            |
| PV2-10RX-XY | 2 AWG      | Red        | 0.06                  | 0.632           | #10       | 1.94                    | 0.68 | 0.58 | CT-720,<br>CD-720PV8-2‡,<br>CT-2600,<br>CD-2600-PV2‡ | 10               | 100            |
| PV2-14RX-XY |            |            | 0.06                  | 0.632           | 1/4"      | 1.94                    | 0.68 | 0.58 |  | 10               | 100            |
| PV2-56RX-XY |            |            | 0.06                  | 0.632           | 5/16"     | 1.94                    | 0.68 | 0.58 |  | 10               | 100            |
| PV2-38RX-XY |            |            | 0.06                  | 0.632           | 3/8"      | 1.94                    | 0.68 | 0.58 |  | 10               | 100            |
| PV2-12RX-XY |            |            | 0.06                  | 0.632           | 1/2"      | 2.03                    | 0.86 | 0.58 |  | 10               | 100            |

\*\*Bulk packaging may be available, contact Panduit Customer Service for additional information.

‡UL approved tooling/product combinations. For crimping tool information, see page D1.87 and D1.89.

**UL LISTED** **CSA CERTIFIED** **Ring Terminal, Non-Insulated**

**Type P-R**

- Ring tongue design assures a secure connection in high vibration applications
- Internal barrel serrations assure good wire contact and maximum tensile strength
- Brazed seam protects terminal barrel from splitting during the crimp process

- Barrel of terminal internally beveled to provide quick and easy wire insertion
- Maximum recommended operating temperature 302°F (150°C)
- UL and CSA rated up to 2000 V per UL 486A/B

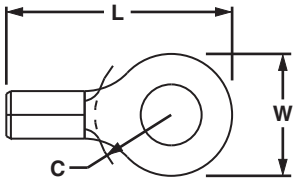

| Part Number       | Wire Range  | Stock Thickness (In.) | Stud Size | Figure Dimensions (In.) |      |      | Recommended Installation Tool                    | Std. Pkg. Qty.**   | Std. Ctn. Qty.                                   |     |      |
|-------------------|-------------|-----------------------|-----------|-------------------------|------|------|--|--|--|-----|------|
|                   |             |                       |           | L                       | W    | C    |  |  |  |     |      |
| <b>P22-2R-C*</b>  | 26 – 22 AWG | 0.02                  | #2        | 0.52                    | 0.20 | 0.16 | CT-200   | 100  | 1000   |     |      |
| <b>P22-4R-C*</b>  |             | 0.02                  | #4        | 0.52                    | 0.20 | 0.16 |  | 100  | 1000   |     |      |
| <b>P22-6R-C*</b>  |             | 0.02                  | #6        | 0.52                    | 0.20 | 0.16 |  | 100  | 1000   |     |      |
| <b>P22-8R-C*</b>  |             | 0.02                  | #8        | 0.63                    | 0.26 | 0.25 |  | 100  | 1000   |     |      |
| <b>P22-10R-C*</b> |             | 0.02                  | #10       | 0.63                    | 0.31 | 0.22 |  | 100  | 1000   |     |      |
| <b>P18-4R-C</b>   | 22 – 16 AWG | 0.03                  | #4        | 0.62                    | 0.25 | 0.21 | CT-100A‡, CT-200‡, CT-600-A‡, CT-1570‡, CT-2500‡ | 100  | 1000   |     |      |
| <b>P18-6RN-C</b>  |             | 0.03                  | #6        | 0.60                    | 0.22 | 0.19 |  | 100  | 1000   |     |      |
| <b>P18-6R-C</b>   |             | 0.03                  | #6        | 0.62                    | 0.25 | 0.21 |  | 100  | 1000   |     |      |
| <b>P18-8R-C</b>   |             | 0.03                  | #8        | 0.71                    | 0.31 | 0.25 |  | 100  | 1000   |     |      |
| <b>P18-10R-C</b>  |             | 0.03                  | #10       | 0.71                    | 0.31 | 0.25 |  | 100  | 1000   |     |      |
| <b>P18-14R-C</b>  |             | 0.03                  | 1/4"      | 0.91                    | 0.46 | 0.38 |  | 100  | 1000   |     |      |
| <b>P18-56R-C</b>  |             | 0.03                  | 5/16"     | 0.91                    | 0.46 | 0.38 |  | 100  | 1000   |     |      |
| <b>P18-38R-C</b>  |             | 0.03                  | 3/8"      | 1.0                     | 0.53 | 0.43 |  | 100  | 1000   |     |      |
| <b>P18-12R-C</b>  |             | 0.03                  | 1/2"      | 1.20                    | 0.72 | 0.53 |  | 100  | 1000   |     |      |
| <b>P14-4R-C</b>   |             | 18 – 14 AWG           | 0.03      | #4                      | 0.62 | 0.25 |  | 0.20   | CT-100A‡, CT-200‡, CT-600-A‡, CT-1570‡, CT-2500‡ | 100 | 1000 |
| <b>P14-6R-C</b>   | 0.03        |                       | #6        | 0.62                    | 0.25 | 0.20 | 100  | 1000   |  |     |      |
| <b>P14-8R-C</b>   | 0.03        |                       | #8        | 0.71                    | 0.31 | 0.25 | 100  | 1000   |  |     |      |
| <b>P14-10R-C</b>  | 0.03        |                       | #10       | 0.71                    | 0.31 | 0.25 | 100  | 1000   |  |     |      |
| <b>P14-14R-C</b>  | 0.03        |                       | 1/4"      | 0.91                    | 0.46 | 0.38 | 100  | 1000   |  |     |      |
| <b>P14-56R-C</b>  | 0.03        |                       | 5/16"     | 0.91                    | 0.46 | 0.38 | 100  | 1000   |  |     |      |
| <b>P14-38R-C</b>  | 0.03        |                       | 3/8"      | 1.0                     | 0.53 | 0.43 | 100  | 1000   |  |     |      |
| <b>P14-12R-L</b>  | 0.03        |                       | 1/2"      | 1.20                    | 0.72 | 0.53 | 50   | 500  |  |     |      |
| <b>P10-6R-L^</b>  | 14 – 10 AWG |                       | 0.04      | #6                      | 0.78 | 0.31 | 0.31   | CT-100A‡, CT-200‡, CT-600-A‡, CT-1570‡, CT-1701‡, CT-2500‡ |  | 50  | 500  |
| <b>P10-8R-L</b>   |             |                       | 0.04      | #8                      | 0.78 | 0.31 | 0.31   |  |  | 50  | 500  |
| <b>P10-10R-L^</b> |             | 0.04                  | #10       | 0.81                    | 0.38 | 0.31 | 50   |  | 500  |     |      |
| <b>P10-14R-L</b>  |             | 0.04                  | 1/4"      | 0.96                    | 0.52 | 0.38 | 50   |  | 500  |     |      |
| <b>P10-56R-L^</b> |             | 0.04                  | 5/16"     | 0.95                    | 0.52 | 0.38 | 50   |  | 500  |     |      |
| <b>P10-38R-L^</b> |             | 0.04                  | 3/8"      | 1.05                    | 0.58 | 0.44 | 50   |  | 500  |     |      |
| <b>P10-12R-L</b>  |             | 0.04                  | 1/2"      | 1.20                    | 0.72 | 0.53 | 50   |  | 500  |     |      |

\*Wire sizes #26 – 22 AWG are not UL Listed or CSA Certified.

\*\*Bulk packaging may be available, contact Panduit Customer Service for additional information.

^For military specification cross reference see page D1.96.

‡UL and CSA approved tooling/product combinations. For crimping tool information, see pages D1.83, D1.84, D1.86 and D1.88.

A. System Overview

B1. Cable Ties

B2. Cable Accessories

B3. Stainless Steel Ties

C1. Wiring Duct

C2. Surface Raceway

C3. Abrasion Protection

C4. Cable Management

D1. Terminals

D2. Power Connectors

D3. Grounding Connectors

E1. Labeling Systems

E2. Labels

E3. Pre-Printed & Write-On Markers

E4. Permanent Identification

E5. Lockout/Tagout & Safety Solutions

F. Index

A. System Overview

B1. Cable Ties

B2. Cable Accessories

B3. Stainless Steel Ties

C1. Wiring Duct

C2. Surface Raceway

C3. Abrasion Protection

C4. Cable Management

D1. Terminals

D2. Power Connectors

D3. Grounding Connectors

E1. Labeling Systems

E2. Labels

E3. Pre-Printed & Write-On Markers

E4. Permanent Identification

E5. Lockout/Tagout & Safety Solutions

F. Index



## Multiple Stud Terminal, Non-Insulated

### Type P-610R

- Ring tongue design assures a secure connection in high vibration applications
- Teardrop shaped mounting hole of multiple stud terminals permits use with #6, #8, or #10 size studs
- Internal barrel serrations assure good wire contact and maximum tensile strength
- Brazed seam protects terminal barrel from splitting during the crimp process
- Barrel of terminal internally beveled to provide quick and easy wire insertion
- Maximum recommended operating temperature 302°F (150°C)
- UL and CSA rated up to 2000 V per UL 486A/B



| Part Number       | Wire Range  | Stock Thickness (In.) | Stud Size   | Figure Dimensions (In.) |      |      | Recommended Installation Tool                              | Std. Pkg. Qty.** | Std. Ctn. Qty. |
|-------------------|-------------|-----------------------|-------------|-------------------------|------|------|--|------------------|----------------|
|                   |             |                       |             | L                       | W    | C    |  |                  |                |
| <b>P18-610R-C</b> | 22 – 16 AWG | 0.03                  | #6, #8, #10 | 0.80                    | 0.31 | 0.25 | CT-100A‡, CT-200‡, CT-600-A‡, CT-1570‡, CT-1701‡, CT-2500‡ | 100              | 500            |
| <b>P14-610R-C</b> | 18 – 14 AWG | 0.03                  |             | 0.80                    | 0.31 | 0.25 |  | 100              | 500            |
| <b>P10-610R-L</b> | 14 – 10 AWG | 0.04                  |             | 0.90                    | 0.37 | 0.31 | 50   | 500              |                |

\*\*Bulk packaging may be available, contact Panduit Customer Service for additional information.  
‡UL and CSA approved tooling/product combinations. For tooling information, see pages D1.83, D1.84, D1.86 and D1.88.

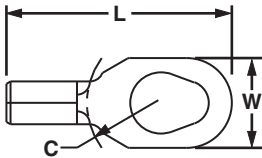



## Ring Terminal, Non-Insulated – High Temperature

### Type P-RHT

- Ring tongue design assures a secure connection in high vibration applications
- Nickel plated copper for temperatures up to 650°F (343°C)
- Internal barrel serrations assure good wire contact and maximum tensile strength
- Brazed seam protects terminal barrel from splitting during the crimp process
- Barrel of terminal internally beveled to provide quick and easy wire insertion
- Rated up to 2000 V



| Part Number         | Wire Range  | Stock Thickness (In.) | Stud Size | Figure Dimensions (In.) |      |      | Recommended Installation Tool                        | Std. Pkg. Qty. | Std. Ctn. Qty. |
|---------------------|-------------|-----------------------|-----------|-------------------------|------|------|--|----------------|----------------|
|                     |             |                       |           | L                       | W    | C    |  |                |                |
| <b>P18-6RHT6-C</b>  | 22 – 16 AWG | 0.03                  | #6        | 0.62                    | 0.25 | 0.21 | CT-100A, CT-200, CT-600-A, CT-1570, CT-2500          | 100            | 1000           |
| <b>P18-8RHT6-C</b>  |             | 0.03                  | #8        | 0.71                    | 0.31 | 0.25 |  | 100            | 1000           |
| <b>P18-10RHT6-C</b> |             | 0.03                  | #10       | 0.71                    | 0.31 | 0.25 |  | 100            | 1000           |
| <b>P14-6RHT6-C</b>  | 18 – 14 AWG | 0.03                  | #6        | 0.62                    | 0.25 | 0.20 | CT-100A, CT-200, CT-600-A, CT-1570, CT-2500          | 100            | 1000           |
| <b>P14-8RHT6-C</b>  |             | 0.03                  | #8        | 0.71                    | 0.31 | 0.25 |  | 100            | 1000           |
| <b>P14-10RHT6-C</b> |             | 0.03                  | #10       | 0.71                    | 0.31 | 0.25 |  | 100            | 1000           |
| <b>P10-6RHT6-L</b>  | 12 – 10 AWG | 0.04                  | #6        | 0.78                    | 0.31 | 0.35 | CT-100A, CT-200, CT-600-A, CT-1570, CT-1701, CT-2500 | 50             | 500            |
| <b>P10-8RHT6-L</b>  |             | 0.04                  | #8        | 0.78                    | 0.31 | 0.35 |  | 50             | 500            |
| <b>P10-10RHT6-L</b> |             | 0.04                  | #10       | 0.81                    | 0.38 | 0.33 |  | 50             | 500            |
| <b>P10-14RHT6-L</b> |             | 0.04                  | 1/4"      | 0.96                    | 0.53 | 0.42 |  | 50             | 500            |



### Large Wire, Non-Insulated - High Temperature

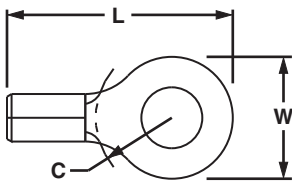

|                    |       |      |       |      |      |      |                     |    |     |
|--------------------|-------|------|-------|------|------|------|---------------------|----|-----|
| <b>P8-8RHT6-Q</b>  | 8 AWG | 0.04 | #8    | 1.12 | 0.42 | 0.43 | CT-2600, CD-2600-8‡ | 25 | 250 |
| <b>P8-10RHT6-Q</b> |       | 0.04 | #10   | 1.14 | 0.42 | 0.43 |                     | 25 | 250 |
| <b>P8-14RHT6-Q</b> |       | 0.04 | 1/4"  | 1.14 | 0.47 | 0.43 |                     | 25 | 250 |
| <b>P8-56RHT6-Q</b> |       | 0.04 | 5/16" | 1.25 | 0.59 | 0.51 |                     | 25 | 250 |
| <b>P8-38RHT6-Q</b> |       | 0.04 | 3/8"  | 1.25 | 0.59 | 0.51 |                     | 25 | 250 |
| <b>P8-12RHT6-Q</b> | 6 AWG | 0.04 | 1/2"  | 1.36 | 0.82 | 0.54 | CT-2600, CD-2600-6‡ | 25 | 250 |
| <b>P6-8RHT6-E</b>  |       | 0.05 | #8    | 1.21 | 0.47 | 0.43 |                     | 20 | 200 |
| <b>P6-10RHT6-E</b> |       | 0.05 | #10   | 1.21 | 0.47 | 0.43 |                     | 20 | 200 |
| <b>P6-14RHT6-E</b> |       | 0.05 | 1/4"  | 1.21 | 0.47 | 0.43 |                     | 20 | 200 |
| <b>P6-56RHT6-E</b> |       | 0.05 | 5/16" | 1.33 | 0.62 | 0.51 |                     | 20 | 200 |
| <b>P6-38RHT6-E</b> | 4 AWG | 0.05 | 3/8"  | 1.33 | 0.62 | 0.51 | CT-2600, CD-2600-4‡ | 20 | 200 |
| <b>P6-12RHT6-E</b> |       | 0.05 | 1/2"  | 1.43 | 0.82 | 0.51 |                     | 20 | 200 |
| <b>P4-10RHT6-E</b> |       | 0.05 | #10   | 1.40 | 0.55 | 0.50 |                     | 20 | 200 |
| <b>P4-14RHT6-E</b> |       | 0.05 | 1/4"  | 1.40 | 0.55 | 0.50 |                     | 20 | 200 |
| <b>P4-56RHT6-E</b> |       | 0.05 | 5/16" | 1.46 | 0.68 | 0.50 |                     | 20 | 200 |
| <b>P4-38RHT6-E</b> | 2 AWG | 0.05 | 3/8"  | 1.46 | 0.68 | 0.50 | CT-2600, CD-2600-2‡ | 20 | 200 |
| <b>P4-12RHT6-E</b> |       | 0.05 | 1/2"  | 1.55 | 0.86 | 0.53 |                     | 20 | 200 |
| <b>P2-10RHT6-X</b> |       | 0.06 | #10   | 1.46 | 0.68 | 0.58 |                     | 10 | 100 |
| <b>P2-14RHT6-X</b> |       | 0.06 | 1/4"  | 1.46 | 0.68 | 0.58 |                     | 10 | 100 |
| <b>P2-56RHT6-X</b> |       | 0.06 | 5/16" | 1.46 | 0.68 | 0.58 |                     | 10 | 100 |
| <b>P2-38RHT6-X</b> | 2 AWG | 0.06 | 3/8"  | 1.46 | 0.68 | 0.58 | CT-2600, CD-2600-2‡ | 10 | 100 |
| <b>P2-12RHT6-X</b> |       | 0.06 | 1/2"  | 1.55 | 0.86 | 0.58 |                     | 10 | 100 |

\*\*Bulk packaging may be available, contact Panduit Customer Service for additional information. For crimping tool information, see pages D1.83, D1.84, D1.86, D1.88, and D1.89.

A. System Overview

B1. Cable Ties

B2. Cable Accessories

B3. Stainless Steel Ties

C1. Wiring Duct

C2. Surface Raceway

C3. Abrasion Protection

C4. Cable Management

D1. Terminals

D2. Power Connectors

D3. Grounding Connectors

E1. Labeling Systems

E2. Labels

E3. Pre-Printed & Write-On Markers

E4. Permanent Identification

E5. Lockout/Tagout & Safety Solutions

F. Index

A. System Overview

B1. Cable Ties

B2. Cable Accessories

B3. Stainless Steel Ties

C1. Wiring Duct

C2. Surface Raceway

C3. Abrasion Protection

C4. Cable Management

D1. Terminals

D2. Power Connectors

D3. Grounding Connectors

E1. Labeling Systems

E2. Labels

E3. Pre-Printed & Write-On Markers

E4. Permanent Identification

E5. Lockout/Tagout & Safety Solutions

F. Index



## Ring Terminal, Heavy Duty Non-Insulated

### Type P-HDR

- Ring tongue design assures a secure connection in high vibration applications
- Manufactured from stock 56% thicker than a standard #16 – 14 AWG terminal for use in heavy-duty applications
- Internal barrel serrations assure good wire contact and maximum tensile strength

- Brazed seam protects terminal barrel from splitting during the crimp process
- Barrel of terminal internally beveled to provide quick and easy wire insertion
- Maximum recommended operating temperature 302°F (150°C)
- UL and CSA rated up to 2000 V per UL 486A/B

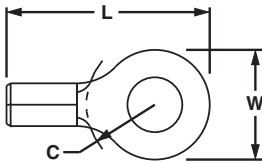

| Part Number        | Wire Range  | Stock Thickness (In.) | Stud Size | Figure Dimensions (In.) |      |      | Recommended Installation Tool       | Std. Pkg. Qty.** | Std. Ctn. Qty. |
|--------------------|-------------|-----------------------|-----------|-------------------------|------|------|-------------------------------------|------------------|----------------|
|                    |             |                       |           | L                       | W    | C    |                                     |                  |                |
| <b>P12-6HDR-L</b>  | 16 – 12 AWG | 0.05                  | #6        | 0.78                    | 0.31 | 0.36 | CT-100A, CT-200, CT-1570‡, CT-2500‡ | 50               | 500            |
| <b>P12-8HDR-L</b>  |             | 0.05                  | #8        | 0.78                    | 0.31 | 0.36 |                                     | 50               | 500            |
| <b>P12-10HDR-L</b> |             | 0.05                  | #10       | 0.81                    | 0.37 | 0.36 |                                     | 50               | 500            |
| <b>P12-14HDR-L</b> |             | 0.05                  | 1/4"      | 0.96                    | 0.52 | 0.43 |                                     | 50               | 500            |
| <b>P12-56HDR-L</b> |             | 0.05                  | 5/16"     | 0.96                    | 0.52 | 0.43 |                                     | 50               | 500            |
| <b>P12-38HDR-L</b> |             | 0.05                  | 3/8"      | 1.04                    | 0.58 | 0.48 |                                     | 50               | 500            |

\*\*Bulk packaging may be available, contact Panduit Customer Service for additional information.

‡UL and CSA approved tooling/product combinations. For crimping tool information, see pages D1.83, D1.84, and D1.88.



## Ring Terminal, Large Wire Non-Insulated

### Type P-R

- Designed for use with #8 - #2 AWG copper wire
- Ring tongue design assures a secure connection in high vibration applications
- Internal barrel serrations assure good wire contact and maximum tensile strength

- Brazed seam protects terminal barrel from splitting during the crimp process
- Barrel of terminal internally beveled to provide quick and easy wire insertion
- Maximum recommended operating temperature 302°F (150°C)
- UL and CSA rated up to 2000 V per UL 486A/B

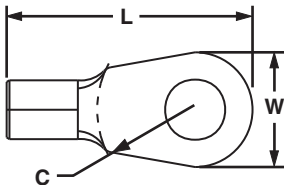

| Part Number      | Wire Range | Stock Thickness (In.) | Stud Size | Figure Dimensions (In.) |      |      | Recommended Installation Tool | Std. Pkg. Qty.** | Std. Ctn. Qty. |
|------------------|------------|-----------------------|-----------|-------------------------|------|------|-------------------------------|------------------|----------------|
|                  |            |                       |           | L                       | W    | C    |                               |                  |                |
| <b>P8-8R-Q</b>   | 8 AWG      | 0.04                  | #8        | 1.12                    | 0.42 | 0.43 | CT-1701‡, CT-2600, CD-2600-8‡ | 25               | 250            |
| <b>P8-10R-Q</b>  |            | 0.04                  | #10       | 1.14                    | 0.47 | 0.43 |                               | 25               | 250            |
| <b>P8-14R-Q</b>  |            | 0.04                  | 1/4"      | 1.14                    | 0.47 | 0.43 |                               | 25               | 250            |
| <b>P8-56R-Q</b>  |            | 0.04                  | 5/16"     | 1.25                    | 0.59 | 0.51 |                               | 25               | 250            |
| <b>P8-38R-Q</b>  |            | 0.04                  | 3/8"      | 1.25                    | 0.59 | 0.51 |                               | 25               | 250            |
| <b>P8-12R-Q</b>  |            | 0.04                  | 1/2"      | 1.36                    | 0.82 | 0.54 |                               | 25               | 250            |
| <b>P6-8R-E</b>   | 6 AWG      | 0.05                  | #8        | 1.21                    | 0.47 | 0.43 | CT-1701‡, CT-2600, CD-2600-6‡ | 20               | 200            |
| <b>P6-10R-E</b>  |            | 0.05                  | #10       | 1.21                    | 0.47 | 0.43 |                               | 20               | 200            |
| <b>P6-14R-E</b>  |            | 0.05                  | 1/4"      | 1.21                    | 0.47 | 0.43 |                               | 20               | 200            |
| <b>P6-56R-E</b>  |            | 0.05                  | 5/16"     | 1.33                    | 0.62 | 0.51 |                               | 20               | 200            |
| <b>P6-38R-E</b>  |            | 0.05                  | 3/8"      | 1.33                    | 0.62 | 0.51 |                               | 20               | 200            |
| <b>P6-12R-E</b>  |            | 0.05                  | 1/2"      | 1.43                    | 0.82 | 0.51 |                               | 20               | 200            |
| <b>P4-10R-E</b>  | 4 AWG      | 0.05                  | #10       | 1.40                    | 0.55 | 0.50 | CT-1701‡, CT-2600, CD-2600-4‡ | 20               | 200            |
| <b>P4-14R-E</b>  |            | 0.05                  | 1/4"      | 1.40                    | 0.55 | 0.50 |                               | 20               | 200            |
| <b>P4-56R-E</b>  |            | 0.05                  | 5/16"     | 1.46                    | 0.68 | 0.50 |                               | 20               | 200            |
| <b>P4-38R-E</b>  |            | 0.05                  | 3/8"      | 1.46                    | 0.68 | 0.50 |                               | 20               | 200            |
| <b>P4-12R-E</b>  | 0.05       | 1/2"                  | 1.55      | 0.86                    | 0.53 | 20   | 200                           |                  |                |
| <b>P2-10R-X</b>  | 2 AWG      | 0.06                  | #10       | 1.46                    | 0.68 | 0.58 | CT-1701‡, CT-2600, CD-2600-2‡ | 10               | 100            |
| <b>P2-14R-X</b>  |            | 0.06                  | 1/4"      | 1.46                    | 0.68 | 0.58 |                               | 10               | 100            |
| <b>P2-56R-X</b>  |            | 0.06                  | 5/16"     | 1.46                    | 0.68 | 0.58 |                               | 10               | 100            |
| <b>P2-38R-X</b>  |            | 0.06                  | 3/8"      | 1.46                    | 0.68 | 0.58 |                               | 10               | 100            |
| <b>P2-12R-X*</b> |            | 0.06                  | 1/2"      | 1.55                    | 0.86 | 0.58 |                               | 10               | 100            |

\*Not CSA Certified.

\*\*Bulk packaging may be available, contact Panduit Customer Service for additional information.

‡UL and CSA approved tooling/product combinations. For crimping tool information, see page D1.84 and D1.89.



## Tubular Ring Terminal, Non-Insulated

### Type S-R

- Seamless tubular barrel provides a consistent high performance quality crimp
- Round double thick tongue for reliable power applications
- Barrel of terminal internally beveled to provide quick and easy wire insertion
- Inspection window allows visual inspection of proper wire insertion
- Maximum recommended operating temperature 302°F (150°C)
- UL and CSA rated up to 2000 V per UL 486A – 486B

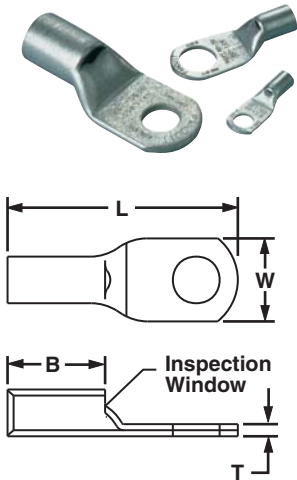

| Min. Tensile Strength of Tubular Ring Terminals |     |     |     |
|---|-----|-----|-----|
| #8  | #6  | #4  | #2  |
| 90  | 100 | 140 | 180 |

| Part Number | Wire Range | Stud Hole Size | Tongue Width (In.) | Figure Dimensions (In.) |      |      |   | Recommended Installation Tool | Std. Pkg. Qty.** | Std. Ctn. Qty. |
|-------------|------------|----------------|--------------------|-------------------------|------|------|---|-------------------------------|------------------|----------------|
|             |            |                |                    | W                       | L    | B    | T   |                               |                  |                |
| S8-10R-Q    | 8 AWG      | #10            | 0.41               | 1.10                    | 0.40 | 0.08 | CT-1700,<br>CT-720,<br>CT-930,<br>CT-930CH,<br>CT-940CH,<br>CT-2001,<br>CT-2002,<br>CT-2931,<br>CT-2940 | 25                            | 250              |                |
| S8-14R-Q    |            | 1/4"           | 0.48               | 1.20                    | 0.40 | 0.07 |   | 25                            | –                |                |
| S8-56R-Q    |            | 5/16"          | 0.60               | 1.30                    | 0.40 | 0.05 |   | 25                            | 250              |                |
| S8-38R-Q    |            | 3/8"           | 0.60               | 1.40                    | 0.40 | 0.05 |   | 25                            | 250              |                |
| S6-10R-E    | 6 AWG      | #10            | 0.45               | 1.20                    | 0.48 | 0.09 |   | 20                            | 200              |                |
| S6-14R-E    |            | 1/4"           | 0.48               | 1.30                    | 0.48 | 0.08 |   | 20                            | –                |                |
| S6-56R-E    |            | 5/16"          | 0.56               | 1.40                    | 0.48 | 0.07 |   | 20                            | 200              |                |
| S6-38R-E    |            | 3/8"           | 0.62               | 1.50                    | 0.48 | 0.06 |   | 20                            | 200              |                |
| S4-10R-E    | 4 AWG      | #10            | 0.55               | 1.20                    | 0.48 | 0.09 |   | 20                            | 200              |                |
| S4-14R-E    |            | 1/4"           | 0.55               | 1.30                    | 0.48 | 0.09 |   | 20                            | 200              |                |
| S4-56R-E    |            | 5/16"          | 0.55               | 1.40                    | 0.48 | 0.09 |   | 20                            | 200              |                |
| S4-38R-E    |            | 3/8"           | 0.62               | 1.50                    | 0.48 | 0.07 |   | 20                            | 200              |                |
| S2-10R-X    | 1 – 2 AWG  | #10            | 0.70               | 1.60                    | 0.59 | 0.11 | 10  | 100                           |                  |                |
| S2-14R-X    |            | 1/4"           | 0.70               | 1.60                    | 0.59 | 0.11 | 10  | 100                           |                  |                |
| S2-56R-X    |            | 5/16"          | 0.70               | 1.70                    | 0.59 | 0.11 | 10  | 100                           |                  |                |
| S2-38R-X    |            | 3/8"           | 0.70               | 1.70                    | 0.59 | 0.11 | 10  | 100                           |                  |                |
| S2-12R-X    |            | 1/2"           | 0.79               | 1.90                    | 0.59 | 0.09 | 10  | 100                           |                  |                |
| S1/0-14R-X  | 1/0 AWG    | 1/4"           | 0.76               | 1.60                    | 0.58 | 0.12 | 10  | 100                           |                  |                |
| S1/0-56R-X  |            | 5/16"          | 0.76               | 1.70                    | 0.58 | 0.12 | 10  | 100                           |                  |                |
| S1/0-38R-X  |            | 3/8"           | 0.76               | 1.70                    | 0.58 | 0.12 | 10  | 100                           |                  |                |
| S1/0-12R-X  |            | 1/2"           | 0.82               | 1.90                    | 0.58 | 0.12 | 10  | 100                           |                  |                |
| S2/0-14R-X  | 2/0 AWG    | 1/4"           | 0.85               | 1.90                    | 0.66 | 0.13 | 10  | 100                           |                  |                |
| S2/0-56R-X  |            | 5/16"          | 0.85               | 1.90                    | 0.66 | 0.13 | 10  | 100                           |                  |                |
| S2/0-38R-X  |            | 3/8"           | 0.85               | 1.90                    | 0.66 | 0.13 | 10  | 100                           |                  |                |
| S2/0-76R-X  |            | 7/16"          | 0.85               | 2.10                    | 0.66 | 0.13 | 10  | 100                           |                  |                |
| S2/0-12R-X  |            | 1/2"           | 0.85               | 2.10                    | 0.66 | 0.13 | 10  | 100                           |                  |                |
| S3/0-14R-5  | 3/0 AWG    | 1/4"           | 0.96               | 2.10                    | 0.83 | 0.13 | 5   | 50                            |                  |                |
| S3/0-56R-5  |            | 5/16"          | 0.96               | 2.10                    | 0.83 | 0.13 | 5   | 50                            |                  |                |
| S3/0-38R-5  |            | 3/8"           | 0.96               | 2.10                    | 0.83 | 0.13 | 5   | 50                            |                  |                |
| S3/0-76R-5  |            | 7/16"          | 0.96               | 2.30                    | 0.83 | 0.13 | 5   | 50                            |                  |                |
| S3/0-12R-5  |            | 1/2"           | 0.96               | 2.30                    | 0.83 | 0.13 | 5   | 50                            |                  |                |
| S4/0-56R-5  | 4/0 AWG    | 5/16"          | 1.06               | 2.30                    | 0.91 | 0.14 | 5   | 50                            |                  |                |
| S4/0-38R-5  |            | 3/8"           | 1.06               | 2.30                    | 0.91 | 0.14 | 5   | 50                            |                  |                |
| S4/0-76R-5  |            | 7/16"          | 1.06               | 2.50                    | 0.91 | 0.14 | 5   | 50                            |                  |                |
| S4/0-12R-5  |            | 1/2"           | 1.06               | 2.50                    | 0.91 | 0.14 | 5   | 50                            |                  |                |
| S250-56R-5  | 250 kcmil  | 5/16"          | 1.17               | 2.50                    | 1.01 | 0.14 | 5   | 50                            |                  |                |
| S250-38R-5  |            | 3/8"           | 1.17               | 2.50                    | 1.01 | 0.14 | 5   | 50                            |                  |                |
| S250-76R-5  |            | 7/16"          | 1.17               | 2.60                    | 1.01 | 0.14 | 5   | 50                            |                  |                |
| S250-12R-5  |            | 1/2"           | 1.17               | 2.60                    | 1.01 | 0.14 | 5   | 50                            |                  |                |

For crimping tool information, see pages D1.84, D1.87, D3.37 – D3.46.

\*\*Bulk packaging may be available, contact Panduit Customer Service for additional information.

A. System Overview

B1. Cable Ties

B2. Cable Accessories

B3. Stainless Steel Ties

C1. Wiring Duct

C2. Surface Raceway

C3. Abrasion Protection

C4. Cable Management

D1. Terminals

D2. Power Connectors

D3. Grounding Connectors

E1. Labeling Systems

E2. Labels

E3. Pre-Printed & Write-On Markers

E4. Permanent Identification

E5. Lockout/Tagout & Safety Solutions

F. Index

A. System Overview

B1. Cable Ties

B2. Cable Accessories

B3. Stainless Steel Ties

C1. Wiring Duct

C2. Surface Raceway

C3. Abrasion Protection

C4. Cable Management

D1. Terminals

D2. Power Connectors

D3. Grounding Connectors

E1. Labeling Systems

E2. Labels

E3. Pre-Printed & Write-On Markers

E4. Permanent Identification

E5. Lockout/Tagout & Safety Solutions

F. Index



## Fork Terminal, Nylon Insulated

### Type PN-F

- Fork design provides for fast and easy installation, without the need to remove fastener
- Metal insulation grip sleeve crimps to wire insulation, providing protection to the crimp joint during high vibration applications

- Internal barrel serrations assure good wire contact and maximum tensile strength
- UL Flammability UL 94V-2/HB, maximum insulation temperature 221°F (105°C)
- UL and CSA rated up to 600 V per UL 486A/B

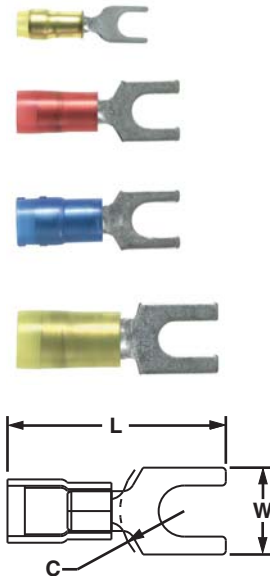

| Part Number         | Wire Range  | Color Code | Stock Thickness (In.) | Max. Ins. (In.) | Stud Size | Figure Dimensions (In.) |      |      | Recommended Installation Tool                     | Std. Pkg. Qty.** | Std. Ctn. Qty. |
|---------------------|-------------|------------|-----------------------|-----------------|-----------|-------------------------|------|------|---|------------------|----------------|
|                     |             |            |                       |                 |           | L                       | W    | C    |   |                  |                |
| <b>PN22-2F-C*</b>   | 26 – 22 AWG | Yellow     | 0.02                  | 0.090           | #2        | 0.66                    | 0.20 | 0.19 | CT-600-A, CT-1525, CT-2500                        | 100              | 1000           |
| <b>PN22-4F-C*</b>   |             |            | 0.02                  | 0.090           | #4        | 0.67                    | 0.20 | 0.21 |   |                  |                |
| <b>PN22-6F-C*</b>   |             |            | 0.02                  | 0.090           | #6        | 0.77                    | 0.25 | 0.26 |   |                  |                |
| <b>PN18-6FN-C*</b>  | 22 – 18 AWG | Red        | 0.03                  | 0.145           | #6        | 0.78                    | 0.24 | 0.20 | CT-100A‡, CT-600-A‡, CT-1550‡, CT-1551‡, CT-2500‡ | 100              | 500            |
| <b>PN18-6F-C</b>    |             |            | 0.03                  | 0.145           | #6        | 0.78                    | 0.30 | 0.20 |   |                  |                |
| <b>PN18-8F-C</b>    |             |            | 0.03                  | 0.145           | #8        | 0.85                    | 0.32 | 0.23 |   |                  |                |
| <b>PN18-10FN-C*</b> |             |            | 0.03                  | 0.145           | #10       | 0.86                    | 0.31 | 0.25 |   |                  |                |
| <b>PN18-10F-C</b>   |             |            | 0.03                  | 0.145           | #10       | 0.86                    | 0.35 | 0.25 |   |                  |                |
| <b>PN18-14F-C</b>   |             |            | 0.03                  | 0.145           | 1/4"      | 1.03                    | 0.44 | 0.33 |   |                  |                |
| <b>PN14-6FN-C*</b>  | 18 – 14 AWG | Blue       | 0.03                  | 0.162           | #6        | 0.79                    | 0.24 | 0.19 | CT-100A‡, CT-600-A‡, CT-1550‡, CT-1551‡, CT-2500‡ | 100              | 500            |
| <b>PN14-6F-C</b>    |             |            | 0.03                  | 0.162           | #6        | 0.79                    | 0.28 | 0.19 |   |                  |                |
| <b>PN14-8F-C</b>    |             |            | 0.03                  | 0.162           | #8        | 0.85                    | 0.31 | 0.23 |   |                  |                |
| <b>PN14-10FN-C*</b> |             |            | 0.03                  | 0.162           | #10       | 0.87                    | 0.31 | 0.24 |   |                  |                |
| <b>PN14-10F-C</b>   |             |            | 0.03                  | 0.162           | #10       | 0.87                    | 0.34 | 0.24 |   |                  |                |
| <b>PN14-14F-C</b>   |             |            | 0.03                  | 0.162           | 1/4"      | 1.02                    | 0.44 | 0.32 |   |                  |                |
| <b>PN10-6F-L</b>    | 12 – 10 AWG | Yellow     | 0.04                  | 0.225           | #6        | 1.00                    | 0.31 | 0.22 | CT-100A‡, CT-600-A‡, CT-1550‡, CT-1551‡, CT-2500‡ | 50               | 500            |
| <b>PN10-8F-L</b>    |             |            | 0.04                  | 0.225           | #8        | 1.03                    | 0.37 | 0.22 |   |                  |                |
| <b>PN10-10F-L</b>   |             |            | 0.04                  | 0.225           | #10       | 1.04                    | 0.37 | 0.22 |   |                  |                |
| <b>PN10-14F-L</b>   |             |            | 0.04                  | 0.225           | 1/4"      | 1.14                    | 0.49 | 0.30 |   |                  |                |

\*Not UL Listed or CSA Certified.

\*\*Bulk packaging may be available, contact Panduit Customer Service for additional information.

‡UL and CSA approved tooling/product combinations. For crimping tool information, see pages D1.83, D1.84, D1.86 and D1.88.



## Fork Terminal, Nylon Insulated – Funnel Entry

### Type PNF-F

- Fork design provides for fast and easy installation, without the need to remove fastener
- Metal insulation grip sleeve crimps to wire insulation, providing protection to the crimp joint during high vibration applications

- Internal barrel serrations assure good wire contact and maximum tensile strength
- UL Flammability UL 94V-2/HB, maximum insulation temperature 221°F (105°C)
- UL and CSA rated up to 600 V per UL 486A/B

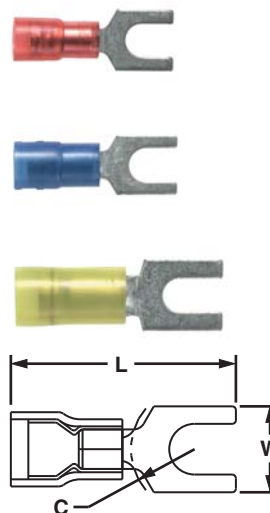

| Part Number        | Wire Range  | Color Code | Stock Thickness (In.) | Max. Ins. (In.) | Stud Size | Figure Dimensions (In.) |      |      | Recommended Installation Tool                     | Std. Pkg. Qty.** | Std. Ctn. Qty. |
|--------------------|-------------|------------|-----------------------|-----------------|-----------|-------------------------|------|------|---|------------------|----------------|
|                    |             |            |                       |                 |           | L                       | W    | C    |   |                  |                |
| <b>PNF18-6F-C</b>  | 22 – 18 AWG | Red        | 0.03                  | 0.136           | #6        | 0.80                    | 0.30 | 0.22 | CT-100A‡, CT-600-A‡, CT-1550‡, CT-1551‡, CT-2500‡ | 100              | 500            |
| <b>PNF18-8F-C</b>  |             |            | 0.03                  | 0.136           | #8        | 0.86                    | 0.31 | 0.25 |   |                  |                |
| <b>PNF18-10F-C</b> |             |            | 0.03                  | 0.136           | #10       | 0.87                    | 0.34 | 0.26 |   |                  |                |
| <b>PNF18-14F-C</b> |             |            | 0.03                  | 0.136           | 1/4"      | 1.05                    | 0.44 | 0.35 |   |                  |                |
| <b>PNF14-6F-C</b>  | 16 – 14 AWG | Blue       | 0.03                  | 0.162           | #6        | 0.80                    | 0.28 | 0.22 | CT-100A‡, CT-600-A‡, CT-1550‡, CT-1551‡, CT-2500‡ | 100              | 500            |
| <b>PNF14-8F-C</b>  |             |            | 0.03                  | 0.162           | #8        | 0.85                    | 0.31 | 0.25 |   |                  |                |
| <b>PNF14-10F-C</b> |             |            | 0.03                  | 0.162           | #10       | 0.87                    | 0.34 | 0.26 |   |                  |                |
| <b>PNF14-14F-C</b> |             |            | 0.03                  | 0.162           | 1/4"      | 1.05                    | 0.44 | 0.35 |   |                  |                |
| <b>PNF10-6F-L</b>  | 12 – 10 AWG | Yellow     | 0.04                  | 0.225           | #6        | 1.01                    | 0.31 | 0.24 | CT-100A‡, CT-600-A‡, CT-1550‡, CT-1551‡, CT-2500‡ | 50               | 500            |
| <b>PNF10-8F-L</b>  |             |            | 0.04                  | 0.225           | #8        | 1.02                    | 0.37 | 0.24 |   |                  |                |
| <b>PNF10-10F-L</b> |             |            | 0.04                  | 0.225           | #10       | 1.04                    | 0.37 | 0.24 |   |                  |                |
| <b>PNF10-14F-L</b> |             |            | 0.04                  | 0.225           | 1/4"      | 1.15                    | 0.50 | 0.31 |   |                  |                |

\*\*Bulk packaging may be available, contact Panduit Customer Service for additional information.

‡UL and CSA approved tooling/product combinations. For crimping tool information, see pages D1.83, D1.84, D1.86 and D1.88.



## Fork Terminal, Vinyl Insulated – Funnel Entry

### Type PV-F

- Fork design provides for fast and easy installation, without the need to remove fastener
- Insulation support helps to prevent wire damage in bending applications
- Brazed seam protects terminal barrel from splitting during the crimp process
- Internal barrel serrations assure good wire contact and maximum tensile strength
- UL Flammability UL 94V-0, maximum insulation temperature 221°F (105°C)
- UL and CSA rated up to 600 V per UL 486A/B

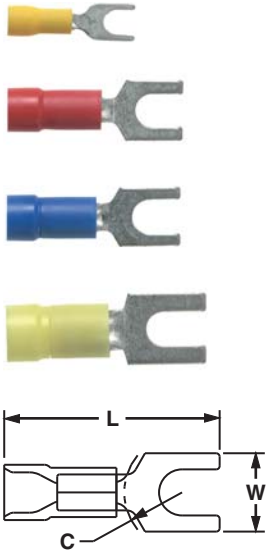

| Part Number   | Wire Range  | Color Code | Stock Thickness (In.) | Max. Ins. (In.) | Stud Size | Figure Dimensions (In.) |      |      | Recommended Installation Tool                     | Std. Pkg. Qty.** | Std. Ctn. Qty. |
|---------------|-------------|------------|-----------------------|-----------------|-----------|-------------------------|------|------|---|------------------|----------------|
|               |             |            |                       |                 |           | L                       | W    | C    |   |                  |                |
| PV22-2F-CY*   | 26 – 22 AWG | Yellow     | 0.02                  | 0.110           | #2        | 0.61                    | 0.20 | 0.19 | CT-600-A, CT-1525, CT-2500                        | 100              | 1000           |
| PV22-4F-CY*   |             |            | 0.02                  | 0.110           | #4        | 0.67                    | 0.20 | 0.21 |   | 100              | 1000           |
| PV22-6F-CY*   |             |            | 0.02                  | 0.110           | #6        | 0.76                    | 0.25 | 0.26 |   | 100              | 1000           |
| PV18-6FN-CY*  | 22 – 16 AWG | Red        | 0.03                  | 0.150           | #6        | 0.85                    | 0.24 | 0.21 | CT-100A‡, CT-600-A‡, CT-1550‡, CT-1551‡, CT-2500‡ | 100              | 500            |
| PV18-6F-CY    |             |            | 0.03                  | 0.150           | #6        | 0.86                    | 0.30 | 0.21 |   | 100              | 500            |
| PV18-8F-CY    |             |            | 0.03                  | 0.150           | #8        | 0.93                    | 0.32 | 0.25 |   | 100              | 500            |
| PV18-10FN-CY* |             |            | 0.03                  | 0.150           | #10       | 0.93                    | 0.31 | 0.25 |   | 100              | 500            |
| PV18-10F-CY   |             |            | 0.03                  | 0.150           | #10       | 0.93                    | 0.35 | 0.25 |   | 100              | 500            |
| PV14-6FN-C*   | 16 – 14 AWG | Blue       | 0.03                  | 0.170           | #6        | 0.84                    | 0.24 | 0.19 | CT-100A‡, CT-600-A‡, CT-1550‡, CT-1551‡, CT-2500‡ | 100              | 500            |
| PV14-6F-C     |             |            | 0.03                  | 0.170           | #6        | 0.84                    | 0.28 | 0.19 |   | 100              | 500            |
| PV14-8F-C     |             |            | 0.03                  | 0.170           | #8        | 0.90                    | 0.31 | 0.23 |   | 100              | 500            |
| PV14-10FN-C*  |             |            | 0.03                  | 0.170           | #10       | 0.92                    | 0.31 | 0.24 |   | 100              | 500            |
| PV14-10F-C    |             |            | 0.03                  | 0.170           | #10       | 0.92                    | 0.34 | 0.24 |   | 100              | 500            |
| PV14-14F-C    |             |            | 0.03                  | 0.170           | 1/4"      | 1.09                    | 0.44 | 0.32 |   | 100              | 1000           |
| PV10-6F-L     |             |            | 14 – 10 AWG           | Yellow          | 0.04      | 0.225                   | #6   | 1.01 |   | 0.31             | 0.25           |
| PV10-8F-L     | 0.04        | 0.225      |                       |                 | #8        | 1.04                    | 0.37 | 0.25 | 50  | 500              |                |
| PV10-10F-L    | 0.04        | 0.225      |                       |                 | #10       | 1.04                    | 0.37 | 0.25 | 50  | 500              |                |
| PV10-14F-L    | 0.04        | 0.225      |                       |                 | 1/4"      | 1.14                    | 0.49 | 0.32 | 50  | 500              |                |

\*Not UL Listed or CSA Certified.

\*\*Bulk packaging may be available, contact Panduit Customer Service for additional information.

‡UL and CSA approved tooling/product combinations. For crimping tool information, see pages D1.83, D1.84, D1.86 and D1.88.

A. System Overview

B1. Cable Ties

B2. Cable Accessories

B3. Stainless Steel Ties

C1. Wiring Duct

C2. Surface Raceway

C3. Abrasion Protection

C4. Cable Management

D1. Terminals

D2. Power Connectors

D3. Grounding Connectors

E1. Labeling Systems

E2. Labels

E3. Pre-Printed & Write-On Markers

E4. Permanent Identification

E5. Lockout/Tagout & Safety Solutions

F. Index



A. System Overview

B1. Cable Ties

B2. Cable Accessories

B3. Stainless Steel Ties

C1. Wiring Duct

C2. Surface Raceway

C3. Abrasion Protection

C4. Cable Management

D1. Terminals

D2. Power Connectors

D3. Grounding Connectors

E1. Labeling Systems

E2. Labels

E3. Pre-Printed & Write-On Markers

E4. Permanent Identification

E5. Lockout/Tagout & Safety Solutions

F. Index



## Fork Terminal, Vinyl Insulated – Expanded Insulation

### Type PV-FX

- Expanded wire entry designed to accommodate wire with a larger insulation thickness
- Fork design provides for fast and easy installation, without the need to remove fastener
- Insulation support helps to prevent wire damage in bending applications
- Brazed seam protects terminal barrel from splitting during the crimp process
- Internal barrel serrations assure good wire contact and maximum tensile strength
- UL Flammability UL 94V-0, maximum insulation temperature 221°F (105°C)
- UL and CSA rated up to 600 V per UL 486A/B

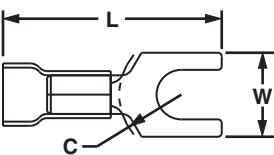

| Part Number  | Wire Range  | Color Code | Stock Thickness (In.) | Max. Ins. (In.) | Stud Size | Figure Dimensions (In.) |      |      | Recommended Installation Tool                     | Std. Pkg. Qty.** | Std. Ctn. Qty. |
|--------------|-------------|------------|-----------------------|-----------------|-----------|-------------------------|------|------|---|------------------|----------------|
|              |             |            |                       |                 |           | L                       | W    | C    |   |                  |                |
| PV18-6FX-CY  | 22 – 18 AWG | Red        | 0.03                  | 0.170           | #6        | 0.83                    | 0.30 | 0.21 | CT-100A‡, CT-600-A‡, CT-1550‡, CT-1551‡, CT-2500‡ | 100              | 500            |
| PV18-8FX-CY  |             |            | 0.03                  | 0.170           | #8        | 0.89                    | 0.32 | 0.25 |   |                  |                |
| PV18-10FX-CY |             |            | 0.03                  | 0.170           | #10       | 0.91                    | 0.35 | 0.25 |   |                  |                |
| PV14-6FX-C   | 18 – 14 AWG | Blue       | 0.03                  | 0.200           | #6        | 0.89                    | 0.28 | 0.16 | CT-100A‡, CT-600-A‡, CT-1550‡, CT-1551‡, CT-2500‡ | 100              | 500            |
| PV14-8FX-C   |             |            | 0.03                  | 0.200           | #8        | 0.96                    | 0.31 | 0.20 |   |                  |                |
| PV14-10FX-C  |             |            | 0.03                  | 0.200           | #10       | 0.97                    | 0.34 | 0.22 |   |                  |                |
| PV10-8FX-L   | 12 – 10 AWG | Yellow     | 0.04                  | 0.250           | #8        | 1.11                    | 0.37 | 0.24 | CT-100A‡, CT-600-A‡, CT-1550‡, CT-1551‡, CT-2500‡ | 50               | 500            |
| PV10-10FX-L  |             |            | 0.04                  | 0.250           | #10       | 1.11                    | 0.37 | 0.24 |   |                  |                |
| PV10-14FX-L  |             |            | 0.04                  | 0.250           | 1/4"      | 1.22                    | 0.50 | 0.32 |   |                  |                |

\*\*Bulk packaging may be available, contact Panduit Customer Service for additional information.  
 ‡UL and CSA approved tooling/product combinations. For crimping tool information, see pages D1.83, D1.84, D1.86 and D1.88.



## Locking Fork Terminal, Nylon Insulated

### Type PN-LF

- Locks in place for secure connection
- Fork design provides for fast and easy installation, without the need to remove fastener
- Metal insulation grip sleeve crimps to wire insulation, providing protection to the crimp joint during high vibration applications
- Internal barrel serrations assure good wire contact and maximum tensile strength
- UL Flammability UL 94V-2/HB, maximum insulation temperature 221°F (105°C)
- UL and CSA rated up to 600 V per UL 486A/B

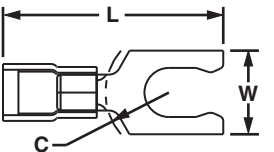

| Part Number   | Wire Range  | Color Code | Stock Thickness (In.) | Max. Ins. (In.) | Stud Size | Figure Dimensions (In.) |      |      | Recommended Installation Tool                     | Std. Pkg. Qty.** | Std. Ctn. Qty. |
|---------------|-------------|------------|-----------------------|-----------------|-----------|-------------------------|------|------|---|------------------|----------------|
|               |             |            |                       |                 |           | L                       | W    | C    |   |                  |                |
| PN18-6LF-C    | 22 – 18 AWG | Red        | 0.03                  | 0.145           | #6        | 0.82                    | 0.27 | 0.22 | CT-100A‡, CT-600-A‡, CT-1550‡, CT-1551‡, CT-2500‡ | 100              | 500            |
| PN18-6LFW-C   |             |            | 0.03                  | 0.145           | #6        | 0.85                    | 0.29 | 0.22 |   |                  |                |
| PN18-8LF-C    |             |            | 0.03                  | 0.145           | #8        | 0.89                    | 0.29 | 0.25 |   |                  |                |
| PN18-10LF-C   |             |            | 0.03                  | 0.145           | #10       | 0.89                    | 0.33 | 0.25 |   |                  |                |
| PN18-10LFN-C* |             |            | 0.03                  | 0.145           | #10       | 0.91                    | 0.29 | 0.25 |   |                  |                |
| PN14-6LF-C    | 18 – 14 AWG | Blue       | 0.03                  | 0.162           | #6        | 0.86                    | 0.25 | 0.22 | CT-100A‡, CT-600-A‡, CT-1550‡, CT-1551‡, CT-2500‡ | 100              | 500            |
| PN14-6LFW-C   |             |            | 0.03                  | 0.162           | #6        | 0.84                    | 0.29 | 0.22 |   |                  |                |
| PN14-8LF-C    |             |            | 0.03                  | 0.162           | #8        | 0.92                    | 0.29 | 0.25 |   |                  |                |
| PN14-10LF-C   |             |            | 0.03                  | 0.162           | #10       | 0.91                    | 0.33 | 0.25 |   |                  |                |
| PN14-10LFN-C* |             |            | 0.03                  | 0.162           | #10       | 0.91                    | 0.28 | 0.25 |   |                  |                |
| PN10-6LF-L    | 12 – 10 AWG | Yellow     | 0.04                  | 0.225           | #6        | 1.02                    | 0.30 | 0.23 | CT-100A‡, CT-600-A‡, CT-1550‡, CT-1551‡, CT-2500‡ | 50               | 500            |
| PN10-8LF-L    |             |            | 0.04                  | 0.225           | #8        | 1.05                    | 0.30 | 0.23 |   |                  |                |
| PN10-10LF-L   |             |            | 0.04                  | 0.225           | #10       | 1.05                    | 0.34 | 0.23 |   |                  |                |
| PN10-14LF-L   |             |            | 0.04                  | 0.225           | 1/4"      | 1.17                    | 0.46 | 0.32 |   |                  |                |

\*Not UL Listed or CSA Certified.  
 \*\*Bulk packaging may be available, contact Panduit Customer Service for additional information.  
 ‡UL and CSA approved tooling/product combinations. For crimping tool information, see pages D1.83, D1.84, D1.86 and D1.88.





## Locking Fork Terminal, Nylon Insulated – Funnel Entry

### Type PNF-LF

- Locks in place for secure connection
- Fork design provides for fast and easy installation, without the need to remove fastener
- Metal insulation grip sleeve crimps to wire insulation, providing protection to the crimp joint during high vibration applications

- Internal barrel serrations assure good wire contact and maximum tensile strength
- UL Flammability UL 94V-2/HB, maximum insulation temperature 221°F (105°C)
- UL and CSA rated up to 600 V per UL 486A/B

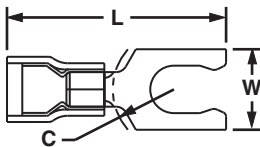

| Part Number         | Wire Range  | Color Code | Stock Thickness (In.) | Max. Ins. (In.) | Stud Size | Figure Dimensions (In.) |      |      | Recommended Installation Tool                     | Std. Pkg. Qty.** | Std. Ctn. Qty. |
|---------------------|-------------|------------|-----------------------|-----------------|-----------|-------------------------|------|------|---|------------------|----------------|
|                     |             |            |                       |                 |           | L                       | W    | C    |   |                  |                |
| <b>PNF18-6LF-C</b>  | 22 – 18 AWG | Red        | 0.03                  | 0.145           | #6        | 0.82                    | 0.27 | 0.20 | CT-100A‡, CT-600-A‡, CT-1550‡, CT-1551‡, CT-2500‡ | 100              | 500            |
| <b>PNF18-6LFW-C</b> |             |            | 0.03                  | 0.145           | #6        | 0.85                    | 0.29 | 0.20 |   |                  |                |
| <b>PNF18-8LF-C</b>  |             |            | 0.03                  | 0.145           | #8        | 0.89                    | 0.29 | 0.26 |   |                  |                |
| <b>PNF18-10LF-C</b> | 18 – 14 AWG | Blue       | 0.03                  | 0.145           | #10       | 0.89                    | 0.33 | 0.25 | CT-100A‡, CT-600-A‡, CT-1550‡, CT-1551‡, CT-2500‡ | 100              | 500            |
| <b>PNF14-6LF-C</b>  |             |            | 0.03                  | 0.162           | #6        | 0.87                    | 0.25 | 0.20 |   |                  |                |
| <b>PNF14-6LFW-C</b> |             |            | 0.03                  | 0.162           | #6        | 0.84                    | 0.29 | 0.20 |   |                  |                |
| <b>PNF14-8LF-C</b>  | 12 – 10 AWG | Yellow     | 0.03                  | 0.162           | #8        | 0.93                    | 0.29 | 0.25 | CT-100A‡, CT-600-A‡, CT-1550‡, CT-1551‡, CT-2500‡ | 100              | 500            |
| <b>PNF14-10LF-C</b> |             |            | 0.03                  | 0.162           | #10       | 0.93                    | 0.33 | 0.25 |   |                  |                |
| <b>PNF10-6LF-L</b>  |             |            | 0.04                  | 0.225           | #6        | 1.02                    | 0.30 | 0.20 |   |                  |                |
| <b>PNF10-8LF-L</b>  | 12 – 10 AWG | Yellow     | 0.04                  | 0.225           | #8        | 1.05                    | 0.30 | 0.20 | CT-100A‡, CT-600-A‡, CT-1550‡, CT-1551‡, CT-2500‡ | 50               | 500            |
| <b>PNF10-10LF-L</b> |             |            | 0.04                  | 0.225           | #10       | 1.05                    | 0.34 | 0.22 |   |                  |                |
| <b>PNF10-14LF-L</b> |             |            | 0.04                  | 0.225           | 1/4"      | 1.19                    | 0.46 | 0.33 |   |                  |                |

\*\*Bulk packaging may be available, contact Panduit Customer Service for additional information.

‡UL and CSA approved tooling/product combinations. For crimping tool information, see pages D1.83, D1.84, D1.86 and D1.88.



## Locking Fork Terminal, Vinyl Insulated – Funnel Entry

### Type PV-LF

- Locks in place for secure connection
- Fork design provides for fast and easy installation, without the need to remove fastener
- Insulation support helps to prevent wire damage in bending applications

- Internal barrel serrations assure good wire contact and maximum tensile strength
- UL Flammability UL 94V-0, maximum insulation temperature 221°F (105°C)
- UL and CSA rated up to 600 V per UL 486A/B

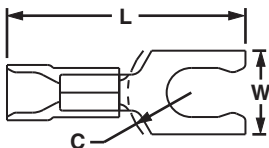

| Part Number           | Wire Range  | Color Code | Stock Thickness (In.) | Max. Ins. (In.) | Stud Size | Figure Dimensions (In.) |      |      | Recommended Installation Tool                     | Std. Pkg. Qty.** | Std. Ctn. Qty. |
|-----------------------|-------------|------------|-----------------------|-----------------|-----------|-------------------------|------|------|---|------------------|----------------|
|                       |             |            |                       |                 |           | L                       | W    | C    |   |                  |                |
| <b>PV18-6LF-CY</b>    | 22 – 18 AWG | Red        | 0.03                  | 0.150           | #6        | 0.90                    | 0.27 | 0.22 | CT-100A‡, CT-600-A‡, CT-1550‡, CT-1551‡, CT-2500‡ | 100              | 500            |
| <b>PV18-6LFW-CY</b>   |             |            | 0.03                  | 0.150           | #6        | 0.90                    | 0.29 | 0.22 |   |                  |                |
| <b>PV18-8LF-CY</b>    |             |            | 0.03                  | 0.150           | #8        | 0.97                    | 0.29 | 0.25 |   |                  |                |
| <b>PV18-10LF-CY</b>   | 18 – 14 AWG | Blue       | 0.03                  | 0.150           | #10       | 0.97                    | 0.33 | 0.25 | CT-100A‡, CT-600-A‡, CT-1550‡, CT-1551‡, CT-2500‡ | 100              | 500            |
| <b>PV18-10LFN-CY*</b> |             |            | 0.03                  | 0.150           | #10       | 0.97                    | 0.29 | 0.25 |   |                  |                |
| <b>PV14-6LF-C</b>     |             |            | 0.03                  | 0.170           | #6        | 0.90                    | 0.25 | 0.22 |   |                  |                |
| <b>PV14-6LFW-C</b>    | 12 – 10 AWG | Yellow     | 0.03                  | 0.170           | #6        | 0.90                    | 0.29 | 0.22 | CT-100A‡, CT-600-A‡, CT-1550‡, CT-1551‡, CT-2500‡ | 100              | 500            |
| <b>PV14-8LF-C</b>     |             |            | 0.03                  | 0.170           | #8        | 0.97                    | 0.29 | 0.25 |   |                  |                |
| <b>PV14-10LF-C</b>    |             |            | 0.03                  | 0.170           | #10       | 0.97                    | 0.33 | 0.25 |   |                  |                |
| <b>PV14-10LFN-C*</b>  | 12 – 10 AWG | Yellow     | 0.03                  | 0.170           | #10       | 0.97                    | 0.29 | 0.25 | CT-100A‡, CT-600-A‡, CT-1550‡, CT-1551‡, CT-2500‡ | 100              | 500            |
| <b>PV10-6LF-L</b>     |             |            | 0.04                  | 0.225           | #6        | 1.03                    | 0.30 | 0.23 |   |                  |                |
| <b>PV10-8LF-L</b>     |             |            | 0.04                  | 0.225           | #8        | 1.05                    | 0.30 | 0.23 |   |                  |                |
| <b>PV10-10LF-L</b>    | 12 – 10 AWG | Yellow     | 0.04                  | 0.225           | #10       | 1.04                    | 0.34 | 0.23 | CT-100A‡, CT-600-A‡, CT-1550‡, CT-1551‡, CT-2500‡ | 50               | 500            |
| <b>PV10-14LF-L</b>    |             |            | 0.04                  | 0.225           | 1/4"      | 1.19                    | 0.46 | 0.36 |   |                  |                |

\*Not UL Listed or CSA Certified.

\*\*Bulk packaging may be available, contact Panduit Customer Service for additional information.

‡UL and CSA approved tooling/product combinations. For crimping tool information, see pages D1.83, D1.84, D1.86 and D1.88.

A. System Overview

B1. Cable Ties

B2. Cable Accessories

B3. Stainless Steel Ties

C1. Wiring Duct

C2. Surface Raceway

C3. Abrasion Protection

C4. Cable Management

D1. Terminals

D2. Power Connectors

D3. Grounding Connectors

E1. Labeling Systems

E2. Labels

E3. Pre-Printed & Write-On Markers

E4. Permanent Identification

E5. Lockout/Tagout & Safety Solutions

F. Index

A. System Overview

B1. Cable Ties

B2. Cable Accessories

B3. Stainless Steel Ties

C1. Wiring Duct

C2. Surface Raceway

C3. Abrasion Protection

C4. Cable Management

D1. Terminals

D2. Power Connectors

D3. Grounding Connectors

E1. Labeling Systems

E2. Labels

E3. Pre-Printed & Write-On Markers

E4. Permanent Identification

E5. Lockout/Tagout & Safety Solutions

F. Index



## Locking Fork Terminal, Vinyl Insulated – Expanded Insulation

### Type PV-LFX

- Fork design provides for fast and easy installation, without the need to remove fastener
- Expanded wire entry designed to accommodate wire with a larger insulation thickness
- Locks in place for secure connection
- Insulation support helps to prevent wire damage in bending applications
- Brazed seam protects terminal barrel from splitting during the crimp process
- Internal barrel serrations assure good wire contact and maximum tensile strength
- UL Flammability UL 94V-0, maximum insulation temperature 221°F (105°C)
- UL and CSA rated up to 600 V per UL 486A/B



| Part Number          | Wire Range  | Color Code | Stock Thickness (In.) | Max. Ins. (In.) | Stud Size | Figure Dimensions (In.) |      |      | Recommended Installation Tool                     | Std. Pkg. Qty.** | Std. Ctn. Qty. |
|----------------------|-------------|------------|-----------------------|-----------------|-----------|-------------------------|------|------|---|------------------|----------------|
|                      |             |            |                       |                 |           | L                       | W    | C    |   |                  |                |
| <b>PV18-6LFX-CY</b>  | 22 – 16 AWG | Red        | 0.03                  | 0.170           | #6        | 0.95                    | 0.27 | 0.20 | CT-100A‡, CT-600-A‡, CT-1550‡, CT-1551‡, CT-2500‡ | 100              | 500            |
| <b>PV18-8LFX-CY</b>  |             |            | 0.03                  | 0.170           | #8        | 1.01                    | 0.29 | 0.20 |   |                  |                |
| <b>PV18-10LFX-CY</b> |             |            | 0.03                  | 0.170           | #10       | 1.04                    | 0.33 | 0.23 |   |                  |                |
| <b>PV14-6LFX-C</b>   | 18 – 14 AWG | Blue       | 0.03                  | 0.200           | #6        | 0.95                    | 0.25 | 0.20 | CT-100A‡, CT-600-A‡, CT-1550‡, CT-1551‡, CT-2500‡ | 100              | 500            |
| <b>PV14-8LFX-C</b>   |             |            | 0.03                  | 0.200           | #8        | 1.01                    | 0.29 | 0.23 |   |                  |                |
| <b>PV14-10LFX-C</b>  |             |            | 0.03                  | 0.200           | #10       | 1.01                    | 0.33 | 0.23 |   |                  |                |
| <b>PV10-6LFX-L</b>   | 12 – 10 AWG | Yellow     | 0.04                  | 0.250           | #6        | 1.09                    | 0.30 | 0.23 | CT-100A‡, CT-600-A‡, CT-1550‡, CT-1551‡, CT-2500‡ | 50               | 500            |
| <b>PV10-8LFX-L</b>   |             |            | 0.04                  | 0.250           | #8        | 1.12                    | 0.30 | 0.23 |   |                  |                |
| <b>PV10-10LFX-L</b>  |             |            | 0.04                  | 0.250           | #10       | 1.12                    | 0.34 | 0.23 |   |                  |                |
| <b>PV10-14LFX-L</b>  |             |            | 0.04                  | 0.250           | 1/4"      | 1.25                    | 0.46 | 0.32 |   |                  |                |

\*\*Bulk packaging may be available, contact Panduit Customer Service for additional information.  
 ‡UL and CSA approved tooling/product combinations. For crimping tool information, see pages D1.83, D1.84, D1.86 and D1.88.



## Short Locking Fork Terminal, Nylon Insulated

### Type PN-SLF

- Locks in place for a secure connection in limited spaces
- Fork design provides for fast and easy installation, without the need to remove fastener
- Metal insulation grip sleeve crimps to wire insulation, providing protection to the crimp joint during high vibration applications
- Internal barrel serrations assure good wire contact and maximum tensile strength
- UL Flammability UL 94V-2/HB, maximum insulation temperature 221°F (105°C)
- UL and CSA rated up to 600 V per UL 486A/B

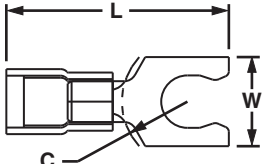

| Part Number         | Wire Range  | Color Code | Stock Thickness (In.) | Max. Ins. (In.) | Stud Size | Figure Dimensions (In.) |      |      | Recommended Installation Tool | Std. Pkg. Qty.** | Std. Ctn. Qty. |
|---------------------|-------------|------------|-----------------------|-----------------|-----------|-------------------------|------|------|-------------------------------|------------------|----------------|
|                     |             |            |                       |                 |           | L                       | W    | C    |                               |                  |                |
| <b>PN18-5SLF-C</b>  | 22 – 18 AWG | Red        | 0.03                  | 0.145           | #5        | 0.75                    | 0.26 | 0.19 | CT-1550, CT-1551, CT-2500     | 100              | 500            |
| <b>PN18-6SLF-C</b>  |             |            | 0.03                  | 0.145           | #6        | 0.75                    | 0.27 | 0.19 |                               |                  |                |
| <b>PN18-8SLF-C</b>  |             |            | 0.03                  | 0.145           | #8        | 0.80                    | 0.29 | 0.23 |                               |                  |                |
| <b>PN18-10SLF-C</b> |             |            | 0.03                  | 0.145           | #10       | 0.81                    | 0.33 | 0.23 |                               |                  |                |
| <b>PN14-5SLF-C</b>  | 16 – 14 AWG | Blue       | 0.03                  | 0.162           | #5        | 0.75                    | 0.25 | 0.19 | CT-1550, CT-1551, CT-2500     | 100              | 500            |
| <b>PN14-6SLF-C</b>  |             |            | 0.03                  | 0.162           | #6        | 0.75                    | 0.25 | 0.19 |                               |                  |                |
| <b>PN14-8SLF-C</b>  |             |            | 0.03                  | 0.162           | #8        | 0.80                    | 0.29 | 0.23 |                               |                  |                |
| <b>PN14-10SLF-C</b> |             |            | 0.03                  | 0.162           | #10       | 0.81                    | 0.33 | 0.23 |                               |                  |                |
| <b>PN14-14SLF-C</b> | 12 – 10 AWG | Yellow     | 0.03                  | 0.162           | 1/4"      | 0.90                    | 0.44 | 0.28 | CT-1550, CT-1551, CT-2500     | 100              | 500            |
| <b>PN10-5SLF-L</b>  |             |            | 0.04                  | 0.225           | #5        | 0.86                    | 0.25 | 0.22 |                               |                  |                |
| <b>PN10-6SLF-L</b>  |             |            | 0.04                  | 0.225           | #6        | 0.86                    | 0.25 | 0.22 |                               |                  |                |
| <b>PN10-8SLF-L</b>  |             |            | 0.04                  | 0.225           | #8        | 0.92                    | 0.29 | 0.26 |                               |                  |                |
| <b>PN10-10SLF-L</b> | 12 – 10 AWG | Yellow     | 0.04                  | 0.225           | #10       | 0.92                    | 0.33 | 0.26 | CT-1550, CT-1551, CT-2500     | 50               | 500            |
| <b>PN10-14SLF-L</b> |             |            | 0.04                  | 0.225           | 1/4"      | 1.01                    | 0.45 | 0.33 |                               |                  |                |

\*\*Bulk packaging may be available, contact Panduit Customer Service for additional information.  
 For crimping tool information, see pages D1.84 and D1.88.



## Short Locking Fork Terminal, Nylon Insulated – Funnel Entry

### Type PNF-SLF

- Locks in place for a secure connection in limited spaces
- Fork design provides for fast and easy installation, without the need to remove fastener
- Metal insulation grip sleeve crimps to wire insulation, providing protection to the crimp joint during high vibration applications

- Internal barrel serrations assure good wire contact and maximum tensile strength
- UL Flammability UL 94V-2/HB, maximum insulation temperature 221°F (105°C)
- UL and CSA rated up to 600 V per UL 486A/B



| Part Number   | Wire Range  | Color Code | Stock Thickness (In.) | Max. Ins. (In.) | Stud Size | Figure Dimensions (In.) |      |      | Recommended Installation Tool | Std. Pkg. Qty.** | Std. Ctn. Qty. |
|---------------|-------------|------------|-----------------------|-----------------|-----------|-------------------------|------|------|-------------------------------|------------------|----------------|
|               |             |            |                       |                 |           | L                       | W    | C    |                               |                  |                |
| PNF18-5SLF-C  | 22 – 18 AWG | Red        | 0.03                  | 0.145           | #5        | 0.75                    | 0.26 | 0.19 | CT-1550, CT-1551, CT-2500     | 100              | 500            |
| PNF18-6SLF-C  |             |            | 0.03                  | 0.145           | #6        | 0.75                    | 0.27 | 0.19 |                               |                  |                |
| PNF18-8SLF-C  |             |            | 0.03                  | 0.145           | #8        | 0.80                    | 0.29 | 0.23 |                               |                  |                |
| PNF18-10SLF-C |             |            | 0.03                  | 0.145           | #10       | 0.81                    | 0.33 | 0.23 |                               |                  |                |
| PNF14-5SLF-C  | 16 – 14 AWG | Blue       | 0.03                  | 0.162           | #5        | 0.75                    | 0.25 | 0.19 | CT-1550, CT-1551, CT-2500     | 100              | 500            |
| PNF14-6SLF-C  |             |            | 0.03                  | 0.162           | #6        | 0.75                    | 0.25 | 0.19 |                               |                  |                |
| PNF14-8SLF-C  |             |            | 0.03                  | 0.162           | #8        | 0.82                    | 0.29 | 0.23 |                               |                  |                |
| PNF14-10SLF-C |             |            | 0.03                  | 0.162           | #10       | 0.81                    | 0.33 | 0.23 |                               |                  |                |
| PNF14-14SLF-C |             |            | 0.03                  | 0.162           | 1/4"      | 0.91                    | 0.44 | 0.28 |                               | 100              | 500            |
| PNF10-6SLF-L  | 12 – 10 AWG | Yellow     | 0.04                  | 0.225           | #6        | 0.91                    | 0.25 | 0.17 | CT-1550, CT-1551, CT-2500     | 50               | 500            |
| PNF10-8SLF-L  |             |            | 0.04                  | 0.225           | #8        | 0.92                    | 0.29 | 0.22 |                               |                  |                |
| PNF10-10SLF-L |             |            | 0.04                  | 0.225           | #10       | 0.93                    | 0.33 | 0.22 |                               |                  |                |
| PNF10-14SLF-L |             |            | 0.04                  | 0.225           | 1/4"      | 1.02                    | 0.45 | 0.28 |                               |                  |                |

\*\*Bulk packaging may be available, contact Panduit Customer Service for additional information. For crimping tool information, see pages D1.84 and D1.88.



## Short Locking Fork Terminal, Vinyl Insulated – Funnel Entry

### Type PV-SLF

- Locks in place for a secure connection in limited spaces
- Fork design provides for fast and easy installation, without the need to remove fastener
- Insulation support helps to prevent wire damage in bending applications

- Internal barrel serrations assure good wire contact and maximum tensile strength
- UL Flammability UL 94V-0, maximum insulation temperature 221°F (105°C)
- UL and CSA rated up to 600 V per UL 486A/B



| Part Number    | Wire Range  | Color Code | Stock Thickness (In.) | Max. Ins. (In.) | Stud Size | Figure Dimensions (In.) |      |      | Recommended Installation Tool | Std. Pkg. Qty.** | Std. Ctn. Qty. |
|----------------|-------------|------------|-----------------------|-----------------|-----------|-------------------------|------|------|-------------------------------|------------------|----------------|
|                |             |            |                       |                 |           | L                       | W    | C    |                               |                  |                |
| PV18-5SLF-CY^  | 22 – 18 AWG | Red        | 0.03                  | 0.150           | #5        | 0.82                    | 0.26 | 0.19 | CT-1550, CT-1551, CT-2500     | 100              | 500            |
| PV18-6SLF-CY^  |             |            | 0.03                  | 0.150           | #6        | 0.82                    | 0.27 | 0.19 |                               |                  |                |
| PV18-8SLF-CY^  |             |            | 0.03                  | 0.150           | #8        | 0.87                    | 0.29 | 0.23 |                               |                  |                |
| PV18-10SLF-CY^ |             |            | 0.03                  | 0.150           | #10       | 0.88                    | 0.33 | 0.23 |                               |                  |                |
| PV14-5SLF-C*   | 16 – 14 AWG | Blue       | 0.03                  | 0.175           | #5        | 0.80                    | 0.25 | 0.22 | CT-1550, CT-1551, CT-2500     | 100              | 1000           |
| PV14-6SLF-C*   |             |            | 0.03                  | 0.175           | #6        | 0.80                    | 0.25 | 0.22 |                               |                  |                |
| PV14-8SLF-C*   |             |            | 0.03                  | 0.175           | #8        | 0.85                    | 0.29 | 0.26 |                               |                  |                |
| PV14-10SLF-C*  |             |            | 0.03                  | 0.175           | #10       | 0.86                    | 0.33 | 0.26 |                               |                  |                |
| PV14-14SLF-C*  |             |            | 0.03                  | 0.175           | 1/4"      | 0.95                    | 0.44 | 0.33 |                               | 100              | 1000           |
| PV10-5SLF-L    | 12 – 10 AWG | Yellow     | 0.04                  | 0.225           | #5        | 0.86                    | 0.25 | 0.22 | CT-1550, CT-1551, CT-2500     | 50               | 500            |
| PV10-6SLF-L    |             |            | 0.04                  | 0.225           | #6        | 0.87                    | 0.25 | 0.22 |                               |                  |                |
| PV10-8SLF-L    |             |            | 0.04                  | 0.225           | #8        | 0.92                    | 0.29 | 0.26 |                               |                  |                |
| PV10-10SLF-L   |             |            | 0.04                  | 0.225           | #10       | 0.92                    | 0.33 | 0.26 |                               |                  |                |
| PV10-14SLF-L   |             |            | 0.04                  | 0.225           | 1/4"      | 1.02                    | 0.45 | 0.33 |                               | 50               | 500            |

\*Not UL Listed or CSA Certified.

\*\*Bulk packaging may be available, contact Panduit Customer Service for additional information. For crimping tool information, see pages D1.84 and D1.88.

^CSA Certified only.

A. System Overview

B1. Cable Ties

B2. Cable Accessories

B3. Stainless Steel Ties

C1. Wiring Duct

C2. Surface Raceway

C3. Abrasion Protection

C4. Cable Management

D1. Terminals

D2. Power Connectors

D3. Grounding Connectors

E1. Labeling Systems

E2. Labels

E3. Pre-Printed & Write-On Markers

E4. Permanent Identification

E5. Lockout/Tagout & Safety Solutions

F. Index

A. System Overview

B1. Cable Ties

B2. Cable Accessories

B3. Stainless Steel Ties

C1. Wiring Duct

C2. Surface Raceway

C3. Abrasion Protection

C4. Cable Management

D1. Terminals

D2. Power Connectors

D3. Grounding Connectors

E1. Labeling Systems

E2. Labels

E3. Pre-Printed & Write-On Markers

E4. Permanent Identification

E5. Lockout/Tagout & Safety Solutions

F. Index



## Flanged Fork Terminal, Nylon Insulated

### Type PN-FF

- Fork design provides for fast and easy installation, without the need to remove fastener
- Flange design provides extra secure connection on a variety of applications
- Metal insulation grip sleeve crimps to wire insulation, providing protection to the crimp joint during high vibration applications

- Internal barrel serrations assure good wire contact and maximum tensile strength
- UL Flammability UL 94V-2/HB, maximum insulation temperature 221°F (105°C)
- UL and CSA rated up to 600 V per UL 486A/B

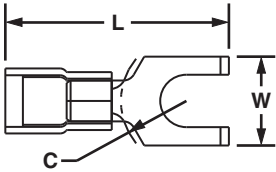

| Part Number        | Wire Range  | Color Code | Stock Thickness (In.) | Max. Ins. (In.) | Stud Size | Figure Dimensions (In.) |      |      | Recommended Installation Tool                     | Std. Pkg. Qty.** | Std. Ctn. Qty. |
|--------------------|-------------|------------|-----------------------|-----------------|-----------|-------------------------|------|------|---|------------------|----------------|
|                    |             |            |                       |                 |           | L                       | W    | C    |   |                  |                |
| <b>PN18-6FF-C</b>  | 22 – 16 AWG | Red        | 0.03                  | 0.136           | #6        | 0.81                    | 0.28 | 0.20 | CT-100A‡, CT-600-A‡, CT-1550‡, CT-1551‡, CT-2500‡ | 100              | 500            |
| <b>PN18-8FF-C</b>  |             |            | 0.03                  | 0.136           | #8        | 0.88                    | 0.31 | 0.23 |   |                  |                |
| <b>PN18-10FF-C</b> |             |            | 0.03                  | 0.136           | #10       | 0.86                    | 0.35 | 0.23 |   |                  |                |
| <b>PN14-6FF-C</b>  | 18 – 14 AWG | Blue       | 0.03                  | 0.162           | #6        | 0.79                    | 0.28 | 0.20 | CT-100A‡, CT-600-A‡, CT-1550‡, CT-1551‡, CT-2500‡ | 100              | 500            |
| <b>PN14-8FF-C</b>  |             |            | 0.03                  | 0.162           | #8        | 0.86                    | 0.31 | 0.23 |   |                  |                |
| <b>PN14-10FF-C</b> |             |            | 0.03                  | 0.162           | #10       | 0.86                    | 0.36 | 0.23 |   |                  |                |
| <b>PN10-8FF-L</b>  | 12 – 10 AWG | Yellow     | 0.04                  | 0.225           | #8        | 1.05                    | 0.37 | 0.28 | CT-100A‡, CT-600-A‡, CT-1550‡, CT-1551‡, CT-2500‡ | 50               | 500            |
| <b>PN10-10FF-L</b> |             |            | 0.04                  | 0.225           | #10       | 1.05                    | 0.37 | 0.28 |   |                  |                |

\*\*Bulk packaging may be available, contact Panduit Customer Service for additional information.

‡UL and CSA approved tooling/product combinations. For crimping tool information, see pages D1.83, D1.84, D1.86 and D1.88.



## Flanged Fork Terminal, Vinyl Insulated – Funnel Entry

### Type PV-FF

- Fork design provides for fast and easy installation, without the need to remove fastener
- Flange design provides extra secure connection on a variety of applications
- Insulation support helps to prevent wire damage in bending applications
- Brazed seam protects terminal barrel from splitting during the crimp process

- Internal barrel serrations assure good wire contact and maximum tensile strength
- UL Flammability UL 94V-0, maximum insulation temperature 221°F (105°C)
- UL and CSA rated up to 600 V per UL 486A/B

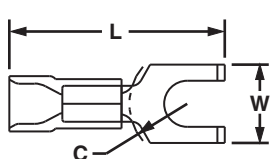

| Part Number         | Wire Range  | Color Code | Stock Thickness (In.) | Max. Ins. (In.) | Stud Size | Figure Dimensions (In.) |      |      | Recommended Installation Tool                     | Std. Pkg. Qty.** | Std. Ctn. Qty. |
|---------------------|-------------|------------|-----------------------|-----------------|-----------|-------------------------|------|------|---|------------------|----------------|
|                     |             |            |                       |                 |           | L                       | W    | C    |   |                  |                |
| <b>PV18-6FF-CY</b>  | 22 – 16 AWG | Red        | 0.03                  | 0.150           | #6        | 0.87                    | 0.28 | 0.19 | CT-100A‡, CT-600-A‡, CT-1550‡, CT-1551‡, CT-2500‡ | 100              | 500            |
| <b>PV18-8FF-CY</b>  |             |            | 0.03                  | 0.150           | #8        | 0.94                    | 0.31 | 0.23 |   |                  |                |
| <b>PV18-10FF-CY</b> |             |            | 0.03                  | 0.150           | #10       | 0.93                    | 0.35 | 0.23 |   |                  |                |
| <b>PV14-6FF-C</b>   | 16 – 14 AWG | Blue       | 0.03                  | 0.165           | #6        | 0.88                    | 0.28 | 0.19 | CT-100A‡, CT-600-A‡, CT-1550‡, CT-1551‡, CT-2500‡ | 100              | 500            |
| <b>PV14-8FF-C</b>   |             |            | 0.03                  | 0.165           | #8        | 0.94                    | 0.31 | 0.23 |   |                  |                |
| <b>PV14-10FF-C</b>  |             |            | 0.03                  | 0.165           | #10       | 0.94                    | 0.35 | 0.23 |   |                  |                |
| <b>PV10-8FF-L</b>   | 14 – 10 AWG | Yellow     | 0.04                  | 0.225           | #8        | 1.03                    | 0.37 | 0.22 | CT-100A‡, CT-600-A‡, CT-1550‡, CT-1551‡, CT-2500‡ | 50               | 500            |
| <b>PV10-10FF-L</b>  |             |            | 0.04                  | 0.225           | #10       | 1.03                    | 0.37 | 0.22 |   |                  |                |

\*\*Bulk packaging may be available, contact Panduit Customer Service for additional information.

‡UL and CSA approved tooling/product combinations. For crimping tool information, see pages D1.83, D1.84, D1.86 and D1.88.



## Fork Terminal, Non-Insulated

### Type P-F

- Fork design provides for fast and easy installation, without the need to remove fastener
- Internal barrel serrations assure good wire contact and maximum tensile strength
- Brazed seam protects terminal barrel from splitting during the crimp process

- Barrel of terminal internally beveled to provide quick and easy wire insertion
- Maximum recommended operating temperature 302°F (150°C)
- UL and CSA rated up to 2000 V per UL 486A/B

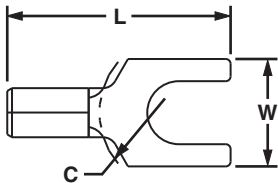

| Part Number | Wire Range  | Stock Thickness (In.) | Stud Size | Figure Dimensions (In.) |      |      | Recommended Installation Tool                              | Std. Pkg. Qty.** | Std. Ctn. Qty. |
|-------------|-------------|-----------------------|-----------|-------------------------|------|------|--|------------------|----------------|
|             |             |                       |           | L                       | W    | C    |  |                  |                |
| P22-2F-C*   | 26 – 22 AWG | 0.02                  | #2        | 0.49                    | 0.19 | 0.19 | CT-200   | 100              | 1000           |
| P22-4F-C*   |             | 0.02                  | #4        | 0.49                    | 0.20 | 0.19 |  | 100              | 1000           |
| P22-6F-C*   |             | 0.02                  | #6        | 0.59                    | 0.25 | 0.26 |  | 100              | 1000           |
| P18-6FN-C*  | 22 – 16 AWG | 0.03                  | #6        | 0.63                    | 0.24 | 0.19 | CT-100A‡, CT-200‡, CT-600-A‡, CT-1570‡, CT-2500‡           | 100              | 1000           |
| P18-6F-C    |             | 0.03                  | #6        | 0.63                    | 0.30 | 0.21 |  | 100              | 1000           |
| P18-8F-C    |             | 0.03                  | #8        | 0.69                    | 0.32 | 0.25 |  | 100              | 1000           |
| P18-10FN-C* |             | 0.03                  | #10       | 0.71                    | 0.31 | 0.25 |  | 100              | 1000           |
| P18-10F-C   |             | 0.03                  | #10       | 0.71                    | 0.35 | 0.25 |  | 100              | 1000           |
| P18-14F-C   |             | 0.03                  | 1/4"      | 0.88                    | 0.44 | 0.33 |  | 100              | 1000           |
| P14-6FN-C   | 18 – 14 AWG | 0.03                  | #6        | 0.63                    | 0.24 | 0.20 | CT-100A‡, CT-200‡, CT-600-A‡, CT-1570‡, CT-2500‡           | 100              | 1000           |
| P14-6F-C    |             | 0.03                  | #6        | 0.63                    | 0.28 | 0.20 |  | 100              | 1000           |
| P14-8F-C    |             | 0.03                  | #8        | 0.69                    | 0.31 | 0.23 |  | 100              | 1000           |
| P14-10FN-C  |             | 0.03                  | #10       | 0.71                    | 0.31 | 0.25 |  | 100              | 1000           |
| P14-10F-C   |             | 0.03                  | #10       | 0.71                    | 0.34 | 0.25 |  | 100              | 1000           |
| P14-14F-C   |             | 0.03                  | 1/4"      | 0.88                    | 0.44 | 0.33 |  | 100              | 1000           |
| P10-6F-L    | 12 – 10 AWG | 0.04                  | #6        | 0.75                    | 0.31 | 0.22 | CT-100A‡, CT-200‡, CT-600-A‡, CT-1570‡, CT-1701‡, CT-2500‡ | 50               | 500            |
| P10-8F-L    |             | 0.04                  | #8        | 0.78                    | 0.37 | 0.22 |  | 50               | 500            |
| P10-10F-L   |             | 0.04                  | #10       | 0.78                    | 0.37 | 0.23 |  | 50               | 500            |
| P10-14F-L   |             | 0.04                  | 1/4"      | 0.89                    | 0.50 | 0.30 |  | 50               | 500            |

\*Not UL Listed or CSA Certified.

\*\*Bulk packaging may be available, contact Panduit Customer Service for additional information.

‡UL and CSA approved tooling/product combinations. For crimping tool information, see pages D1.83, D1.84, D1.86 and D1.88.

A. System Overview

B1. Cable Ties

B2. Cable Accessories

B3. Stainless Steel Ties

C1. Wiring Duct

C2. Surface Raceway

C3. Abrasion Protection

C4. Cable Management

D1. Terminals

D2. Power Connectors

D3. Grounding Connectors

E1. Labeling Systems

E2. Labels

E3. Pre-Printed & Write-On Markers

E4. Permanent Identification

E5. Lockout/Tagout & Safety Solutions

F. Index



A. System Overview

B1. Cable Ties

B2. Cable Accessories

B3. Stainless Steel Ties

C1. Wiring Duct

C2. Surface Raceway

C3. Abrasion Protection

C4. Cable Management



## Flanged Fork Terminal, Non-Insulated

### Type P-FF

- Fork design provides for fast and easy installation, without the need to remove fastener
- Flange design provides extra secure connection on a variety of applications
- Internal barrel serrations assure good wire contact and maximum tensile strength
- Brazed seam protects terminal barrel from splitting during the crimp process
- Barrel of terminal internally beveled to provide quick and easy wire insertion
- Maximum recommended operating temperature 302°F (150°C)
- UL and CSA rated up to 2000 V per UL 486A/B

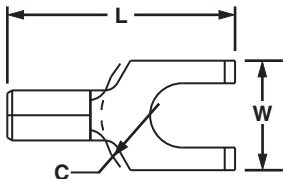

| Part Number       | Wire Range  | Stock Thickness (In.) | Stud Size | Figure Dimensions (In.) |      |      | Recommended Installation Tool                              | Std. Pkg. Qty.** | Std. Ctn. Qty. |
|-------------------|-------------|-----------------------|-----------|-------------------------|------|------|--|------------------|----------------|
|                   |             |                       |           | L                       | W    | C    |  |                  |                |
| <b>P18-8FF-C</b>  | 22 – 16 AWG | 0.03                  | #8        | 0.72                    | 0.31 | 0.25 | CT-100A‡, CT-200‡, CT-600-A‡, CT-1570‡, CT-2500‡           | 100              | 500            |
| <b>P14-6FF-C</b>  | 16 – 14 AWG | 0.03                  | #6        | 0.65                    | 0.28 | 0.22 |  | 100              | 500            |
| <b>P14-8FF-C</b>  |             | 0.03                  | #8        | 0.72                    | 0.31 | 0.25 |  | 100              | 500            |
| <b>P10-10FF-L</b> | 12 – 10 AWG | 0.04                  | #10       | 0.80                    | 0.38 | 0.28 | CT-100A‡, CT-200‡, CT-600-A‡, CT-1570‡, CT-1701‡, CT-2500‡ | 50               | 500            |

\*\*Bulk packaging may be available, contact Panduit Customer Service for additional information.  
 ‡UL and CSA approved tooling/product combinations. For crimping tool information, see pages D1.83, D1.84, D1.86 and D1.88.



## Locking Fork Terminal, Non-Insulated

### Type P-LF

- Locks in place for secure connection
- Fork design provides for fast and easy installation, without the need to remove fastener
- Internal barrel serrations assure good wire contact and maximum tensile strength
- Brazed seam protects terminal barrel from splitting during the crimp process
- Barrel of terminal internally beveled to provide quick and easy wire insertion
- Maximum recommended operating temperature 302°F (150°C)
- UL and CSA rated up to 2000 V per UL 486A/B

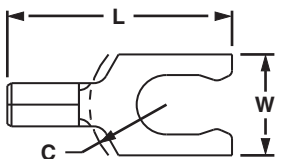

| Part Number         | Wire Range  | Stock Thickness (In.) | Stud Size | Figure Dimensions (In.) |      |      | Recommended Installation Tool                              | Std. Pkg. Qty.** | Std. Ctn. Qty. |
|---------------------|-------------|-----------------------|-----------|-------------------------|------|------|--|------------------|----------------|
|                     |             |                       |           | L                       | W    | C    |  |                  |                |
| <b>P18-6LF-C</b>    | 22 – 16 AWG | 0.03                  | #6        | 0.68                    | 0.27 | 0.22 | CT-100A‡, CT-200‡, CT-600-A‡, CT-1570‡, CT-2500‡           | 100              | 500            |
| <b>P18-6LFW-C</b>   |             | 0.03                  | #6        | 0.70                    | 0.29 | 0.22 |  | 100              | 500            |
| <b>P18-8LF-C</b>    |             | 0.03                  | #8        | 0.74                    | 0.29 | 0.23 |  | 100              | 500            |
| <b>P18-10LFN-C*</b> |             | 0.03                  | #10       | 0.74                    | 0.28 | 0.23 |  | 100              | 500            |
| <b>P18-10LF-C</b>   |             | 0.03                  | #10       | 0.74                    | 0.33 | 0.23 |  | 100              | 500            |
| <b>P14-6LF-C</b>    | 18 – 14 AWG | 0.03                  | #6        | 0.70                    | 0.25 | 0.22 | CT-100A‡, CT-200‡, CT-600-A‡, CT-1570‡, CT-2500‡           | 100              | 500            |
| <b>P14-6LFW-C</b>   |             | 0.03                  | #6        | 0.70                    | 0.29 | 0.22 |  | 100              | 500            |
| <b>P14-8LF-C</b>    |             | 0.03                  | #8        | 0.77                    | 0.29 | 0.27 |  | 100              | 500            |
| <b>P14-10LFN-C*</b> |             | 0.03                  | #10       | 0.77                    | 0.29 | 0.27 |  | 100              | 500            |
| <b>P14-10LF-C</b>   |             | 0.03                  | #10       | 0.77                    | 0.33 | 0.27 |  | 100              | 500            |
| <b>P10-6LF-L</b>    | 14 – 10 AWG | 0.04                  | #6        | 0.77                    | 0.30 | 0.23 | CT-100A‡, CT-200‡, CT-600-A‡, CT-1570‡, CT-1701‡, CT-2500‡ | 50               | 500            |
| <b>P10-8LF-L</b>    |             | 0.04                  | #8        | 0.79                    | 0.30 | 0.23 |  | 50               | 500            |
| <b>P10-10LF-L</b>   |             | 0.04                  | #10       | 0.79                    | 0.34 | 0.23 |  | 50               | 500            |
| <b>P10-14LF-L</b>   |             | 0.04                  | 1/4"      | 0.92                    | 0.46 | 0.33 |  | 50               | 500            |

\*Not UL Listed or CSA Certified.  
 \*\*Bulk packaging may be available, contact Panduit Customer Service for additional information.  
 ‡UL and CSA approved tooling/product combinations. For crimping tool information, see pages D1.83, D1.84, D1.86 and D1.88.





## Short Locking Fork Terminal, Non-Insulated

### Type P-SLF

- Locks in place for a secure connection in limited spaces
- Fork design provides for fast and easy installation, without the need to remove fastener
- Internal barrel serrations assure good wire contact and maximum tensile strength
- Brazed seam protects terminal barrel from splitting during the crimp process
- Barrel of terminal internally beveled to provide quick and easy wire insertion
- Maximum recommended operating temperature 302°F (150°C)
- UL and CSA rated up to 2000 V per UL 486A/B

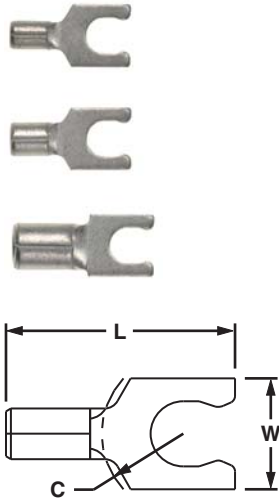

| Part Number | Wire Range  | Stock Thickness (In.) | Stud Size | Figure Dimensions (In.) |      |      | Recommended Installation Tool                              | Std. Pkg. Qty.** | Std. Ctn. Qty. |
|-------------|-------------|-----------------------|-----------|-------------------------|------|------|--|------------------|----------------|
|             |             |                       |           | L                       | W    | C    |  |                  |                |
| P18-6SLF-C  | 22 – 16 AWG | 0.03                  | #6        | 0.51                    | 0.27 | 0.22 | CT-100A‡, CT-200‡, CT-600-A‡, CT-1570‡, CT-2500‡           | 100              | 1000           |
| P18-8SLF-C  |             | 0.03                  | #8        | 0.56                    | 0.29 | 0.25 |  | 100              | 1000           |
| P18-10SLF-C |             | 0.03                  | #10       | 0.57                    | 0.33 | 0.25 |  | 100              | 1000           |
| P14-6SLF-C  | 16 – 14 AWG | 0.03                  | #6        | 0.51                    | 0.25 | 0.22 | CT-100A‡, CT-200‡, CT-600-A‡, CT-1570‡, CT-2500‡           | 100              | 1000           |
| P14-8SLF-C  |             | 0.03                  | #8        | 0.56                    | 0.29 | 0.25 |  | 100              | 1000           |
| P14-10SLF-C |             | 0.03                  | #10       | 0.57                    | 0.33 | 0.25 |  | 100              | 1000           |
| P14-14SLF-C |             | 0.03                  | 1/4"      | 0.66                    | 0.44 | 0.35 |  | 100              | 1000           |
| P10-5SLF-L  | 14 – 10 AWG | 0.04                  | #5        | 0.60                    | 0.25 | 0.19 | CT-100A‡, CT-200‡, CT-600-A‡, CT-1570‡, CT-1701‡, CT-2500‡ | 50               | 500            |
| P10-8SLF-L  |             | 0.04                  | #8        | 0.66                    | 0.29 | 0.23 |  | 50               | 500            |
| P10-10SLF-L |             | 0.04                  | #10       | 0.67                    | 0.33 | 0.23 |  | 50               | 500            |
| P10-14SLF-L |             | 0.04                  | 1/4"      | 0.76                    | 0.45 | 0.28 |  | 50               | 500            |

\*\*Bulk packaging may be available, contact Panduit Customer Service for additional information.

‡UL and CSA approved tooling/product combinations. For crimping tool information, see pages D1.83, D1.84, D1.86 and D1.88.



## Heat Shrink, Fork Terminal

### Type PH-F

- Heat shrink sleeving forms a protective barrier to provide environmentally sealed terminations ideal for high moisture applications
- Fork design provides for fast and easy installation, without the need to remove fastener
- Brazed seam protects terminal barrel from splitting during the crimp process
- Heat shrink insulation is completed with a standard heat gun
- Minimum continuous operating temperature -65°F (-55°C)
- Maximum continuous operation temperature 230°F (110°C)
- Shrink temperature 300°F (150°C)
- UL and CSA rated up to 600 V per UL 486A/B



| Part Number | Wire Range  | Color Code | Max. Ins. (In.) | Stud Size | Figure Dimensions (In.) |      | Wire Strip Length | Recommended Installation Tool | Std. Pkg. Qty. | Std. Ctn. Qty. |
|-------------|-------------|------------|-----------------|-----------|-------------------------|------|-------------------|-------------------------------|----------------|----------------|
|             |             |            |                 |           | L                       | W    |                   |                               |                |                |
| PH18-6F-Q   | 22 – 18 AWG | Red        | 0.170           | #6        | 1.04                    | 0.32 | 5/16              | CT-310                        | 25             | 125            |
| PH18-8F-Q   |             |            | 0.170           | #8        | 1.04                    | 0.32 | 5/16              |                               | 25             | 125            |
| PH18-10F-Q  |             |            | 0.170           | #10       | 1.04                    | 0.32 | 5/16              |                               | 25             | 125            |
| PH14-6F-Q   | 16 – 14 AWG | Blue       | 0.190           | #6        | 1.07                    | 0.38 | 5/16              | CT-310                        | 25             | 125            |
| PH14-8F-Q   |             |            | 0.190           | #8        | 1.07                    | 0.38 | 5/16              |                               | 25             | 125            |
| PH14-10F-Q  |             |            | 0.190           | #10       | 1.07                    | 0.38 | 5/16              |                               | 25             | 125            |
| PH10-8F-E   | 12 – 10 AWG | Yellow     | 0.240           | #8        | 1.20                    | 0.38 | 5/16              | CT-310                        | 20             | 100            |
| PH10-10F-E  |             |            | 0.240           | #10       | 1.20                    | 0.38 | 5/16              |                               | 20             | 100            |

For crimping tool information, see page D1.85.

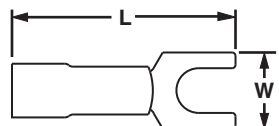

A. System Overview

B1. Cable Ties

B2. Cable Accessories

B3. Stainless Steel Ties

C1. Wiring Duct

C2. Surface Raceway

C3. Abrasion Protection

C4. Cable Management

D1. Terminals

D2. Power Connectors

D3. Grounding Connectors

E1. Labeling Systems

E2. Labels

E3. Pre-Printed & Write-On Markers

E4. Permanent Identification

E5. Lockout/Tagout & Safety Solutions

F. Index

A. System Overview

## Features and Benefits – Pan-Term® Metric Terminals

All Panduit terminals feature high quality materials made with electrolytic copper for high conductivity and are tin-plated for corrosion resistance.

B1. Cable Ties

B2. Cable Accessories

B3. Stainless Steel Ties

C1. Wiring Duct

C2. Surface Raceway

C3. Abrasion Protection

C4. Cable Management

### Nylon Insulated Terminals with Insulation Grip Sleeve Type PMN or PMNF

Internal barrel serrations assure good wire contact and maximum tensile strength



Maximum insulation temperature 221°F (105°C)

Sleeved barrel assures crimp reliability

Insulation grip sleeve provides a superior insulation crimp for high vibration and high strain relief applications

Color-coded insulation identifies wire range

Funnel entry for faster insertion and lower installed cost

Rated up to 600 V.

Flammability – UL 94V-2/HB

Proprietary blend of UL 94V-2 and UL 94HB flammability related materials.

### Vinyl Insulated Terminals with Insulation Support Type PMV

Internal barrel serrations assure good wire contact and maximum tensile strength



Maximum insulation temperature 221°F (105°C)

Color-coded insulation identifies wire range

Brazed seam assures crimp reliability

Insulation crimp provides insulation support to protect electrical crimp

Funnel entry for faster insertion and lower installed cost

Rated up to 600 V.

Flammability – UL 94V-0.

D1. Terminals

D2. Power Connectors

D3. Grounding Connectors

E1. Labeling Systems

E2. Labels

E3. Pre-Printed & Write-On Markers

E4. Permanent Identification

E5. Lockout/Tagout & Safety Solutions

F. Index

### Non-Insulated Terminals Type PM

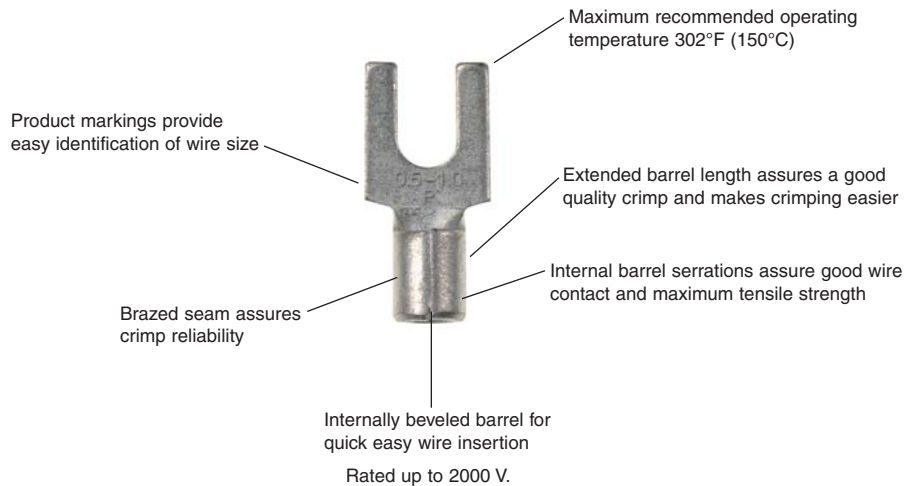

Panduit extensive line of tooling is specifically designed for optimum crimping performance.

See pages D1.83 – D1.89.



Panduit designs and manufactures a full line of labeling products, software, and printers to assist you with your labeling requirements.

See pages E1.1 – E2.28.

## Part Number System for Pan-Term® Metric Terminals

| PM                    | V   | 1   | — | 3   | R                    | — | B                     | — | C   |
|-----------------------|---|---|---|---|----------------------|---|-----------------------|---|---|
| Type                  | Insulation                                  | Wire Range  |   | Stud Size   | Tongue Configuration |   | Special Configuration |   | Std. Pkg. Size                                  |
| PM = Pan-Term® Metric | N = Nylon<br>NF = Nylon Funnel<br>V = Vinyl | 1 = 0.5 – 1.0mm <sup>2</sup><br>(22 – 18 AWG)<br>2 = 1.5 – 2.5mm <sup>2</sup><br>(16 – 14 AWG)<br>6 = 4.0 – 6.0mm <sup>2</sup><br>(12 – 10 AWG) | — | 3 = M3 (#6)<br>4 = M4 (#8)<br>5 = M5 (#10)<br>6 = M6 (1/4)<br>8 = M8 (5/16) | R = Ring<br>F = Fork | — | B = Butted Seam       | — | X = 10<br>E = 20<br>Q = 25<br>L = 50<br>C = 100 |

## Metric Ring Terminal, Nylon Insulated – Funnel Entry

### Type PMNF-R

- Ring tongue design assures a secure connection in high vibration applications
- Internal barrel serrations assure good wire contact and maximum tensile strength
- Maximum insulation temperature 221°F (105°C)
- Rated up to 600 V
- Metal insulation grip sleeve crimps to wire insulation, providing protection to the crimp joint during high vibration applications

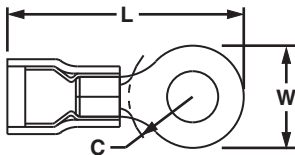

| Part Number | Wire Range (mm <sup>2</sup> ) | Color Code | Max. Ins. (mm) | Stud Size | Figure Dimensions (mm) |      |      | Recommended Installation Tool | Std. Pkg. Qty. | Std. Ctn. Qty. |
|-------------|-------------------------------|------------|----------------|-----------|------------------------|------|------|-------------------------------|----------------|----------------|
|             |                               |            |                |           | L                      | W    | C    |                               |                |                |
| PMNF1-3R-C  | 0.5 – 1.0                     | Red        | 3.76           | M3        | 19.3                   | 5.8  | 5.3  | CT-1550, CT-2500              | 100            | 500            |
| PMNF1-4R-C  |                               |            | 3.76           | M4        | 21.6                   | 7.9  | 6.4  |                               | 100            | 500            |
| PMNF1-5R-C  |                               |            | 3.76           | M5        | 21.8                   | 8.9  | 6.4  |                               | 100            | 500            |
| PMNF1-6R-C  |                               |            | 3.76           | M6        | 26.7                   | 10.9 | 9.7  |                               | 100            | 500            |
| PMNF2-3R-C  | 1.5 – 2.5                     | Blue       | 4.11           | M3        | 19.4                   | 5.9  | 4.8  | CT-1550, CT-2500              | 100            | 500            |
| PMNF2-4R-C  |                               |            | 4.11           | M4        | 21.8                   | 7.9  | 7.4  |                               | 100            | 500            |
| PMNF2-5R-C  |                               |            | 4.11           | M5        | 22.4                   | 8.9  | 7.4  |                               | 100            | 500            |
| PMNF2-6R-L  |                               |            | 4.11           | M6        | 26.5                   | 10.9 | 10.7 |                               | 50             | 500            |
| PMNF6-3R-L  | 4.0 – 6.0                     | Yellow     | 5.94           | M3        | 26.7                   | 5.8  | 9.1  | CT-1550, CT-2500              | 50             | 250            |
| PMNF6-4R-L  |                               |            | 5.94           | M4        | 27.4                   | 7.9  | 9.1  |                               | 50             | 250            |
| PMNF6-5R-L  |                               |            | 5.94           | M5        | 27.4                   | 9.7  | 9.1  |                               | 50             | 250            |
| PMNF6-6R-L  |                               |            | 5.94           | M6        | 30.2                   | 10.9 | 10.9 |                               | 50             | 250            |
| PMNF6-8R-L  |                               |            | 5.94           | M8        | 31.5                   | 13.2 | 10.9 |                               | 50             | 250            |

For crimping tool information, see pages D1.84 and D1.88.

A. System Overview

B1. Cable Ties

B2. Cable Accessories

B3. Stainless Steel Ties

C1. Wiring Duct

C2. Surface Raceway

C3. Abrasion Protection

C4. Cable Management

D1. Terminals

D2. Power Connectors

D3. Grounding Connectors

E1. Labeling Systems

E2. Labels

E3. Pre-Printed & Write-On Markers

E4. Permanent Identification

E5. Lockout/Tagout & Safety Solutions

F. Index

A. System Overview

## Metric Ring Terminal, Vinyl Insulated – Funnel Entry

B1. Cable Ties

### Type PMV-R

- Ring tongue design assures a secure connection in high vibration applications
- Insulation support helps to prevent wire damage in bending applications
- Brazed seam protects terminal barrel from splitting during the crimp process
- Internal barrel serrations assure good wire contact and maximum tensile strength
- Maximum insulation temperature 221°F (105°C)
- Rated up to 600 V

B2. Cable Accessories

B3. Stainless Steel Ties



C1. Wiring Duct



C2. Surface Raceway



C3. Abrasion Protection

C4. Cable Management

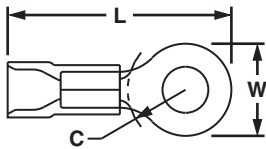

| Part Number | Wire Range (mm <sup>2</sup> ) | Color Code | Max. Ins. (mm) | Stud Size | Figure Dimensions (mm) |      |      | Recommended Installation Tool | Std. Pkg. Qty. | Std. Ctn. Qty. |
|-------------|-------------------------------|------------|----------------|-----------|------------------------|------|------|-------------------------------|----------------|----------------|
|             |                               |            |                |           | L                      | W    | C    |                               |                |                |
| PMV1-3RB-CY | 0.5 – 1.0                     | Red        | 4.01           | M3        | 20.8                   | 5.8  | 5.6  | CT-1550, CT-2500              | 100            | 500            |
| PMV1-4RB-CY |                               |            | 4.01           | M4        | 23.1                   | 7.9  | 7.4  |                               | 100            | 500            |
| PMV1-5RB-CY |                               |            | 4.01           | M5        | 23.1                   | 8.9  | 7.4  |                               | 100            | 500            |
| PMV1-6RB-CY |                               |            | 4.01           | M6        | 28.2                   | 10.9 | 10.7 |                               | 100            | 500            |
| PMV2-3RB-C  | 1.5 – 2.5                     | Blue       | 4.70           | M3        | 20.5                   | 5.8  | 6.4  | CT-1550, CT-2500              | 100            | 500            |
| PMV2-4RB-C  |                               |            | 4.70           | M4        | 23.1                   | 7.9  | 6.4  |                               | 100            | 500            |
| PMV2-5RB-C  |                               |            | 4.70           | M5        | 23.8                   | 8.9  | 6.4  |                               | 100            | 500            |
| PMV2-6RB-C  |                               |            | 4.70           | M6        | 25.7                   | 10.9 | 9.7  |                               | 100            | 500            |
| PMV6-3R-L   | 4.0 – 6.0                     | Yellow     | 6.10           | M3        | 26.1                   | 5.8  | 7.9  | CT-1550, CT-2500              | 50             | 250            |
| PMV6-4R-L   |                               |            | 6.10           | M4        | 26.5                   | 7.9  | 7.9  |                               | 50             | 250            |
| PMV6-5R-L   |                               |            | 6.10           | M5        | 27.1                   | 9.5  | 7.9  |                               | 50             | 250            |
| PMV6-6R-L   |                               |            | 6.10           | M6        | 30.3                   | 10.9 | 9.7  |                               | 50             | 250            |
| PMV6-8R-L   |                               |            | 6.10           | M8        | 31.4                   | 13.2 | 9.7  |                               | 50             | 250            |

For crimping tool information, see page D1.84 and D1.88.

D1. Terminals

D2. Power Connectors

## Metric Ring Terminal, Non-Insulated

### Type PM-R

- Ring tongue design assures a secure connection in high vibration applications
- Internal barrel serrations assure good wire contact and maximum tensile strength
- Brazed seam protects terminal barrel from splitting during the crimp process
- Barrel of terminal internally beveled to provide quick and easy wire insertion
- Maximum recommended operating temperature 302°F (150°C)
- Rated up to 2000 V

D3. Grounding Connectors

E1. Labeling Systems



E2. Labels



E3. Pre-Printed & Write-On Markers



E4. Permanent Identification

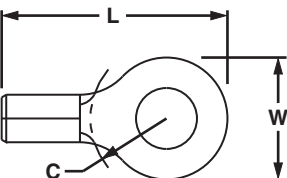

E5. Lockout/Tagout & Safety Solutions

F. Index

| Part Number | Wire Range (mm <sup>2</sup> ) | Stud Size | Figure Dimensions (mm) |      |     | Recommended Installation Tool | Std. Pkg. Qty. | Std. Ctn. Qty. |
|-------------|-------------------------------|-----------|------------------------|------|-----|-------------------------------|----------------|----------------|
|             |                               |           | L                      | W    | C   |                               |                |                |
| PM1-3R-C    | 0.5 – 1.5                     | M3        | 15.8                   | 5.8  | 5.6 | CT-1570, CT-2500              | 100            | 500            |
| PM1-4R-C    |                               | M4        | 18.0                   | 7.9  | 7.4 |                               | 100            | 500            |
| PM1-5R-C    |                               | M5        | 18.0                   | 8.9  | 7.4 |                               | 100            | 500            |
| PM2-3R-C    | 1.0 – 2.5                     | M3        | 15.8                   | 5.8  | 5.6 | CT-1570, CT-2500              | 100            | 500            |
| PM2-4R-C    |                               | M4        | 18.0                   | 7.9  | 7.4 |                               | 100            | 500            |
| PM2-5R-C    |                               | M5        | 18.0                   | 8.9  | 7.4 |                               | 100            | 500            |
| PM6-3R-L    | 2.5 – 6.0                     | M3        | 19.2                   | 5.8  | 7.9 | CT-1570, CT-2500              | 50             | 250            |
| PM6-4R-L    |                               | M4        | 19.8                   | 7.9  | 7.9 |                               | 50             | 250            |
| PM6-5R-L    |                               | M5        | 20.6                   | 9.5  | 7.9 |                               | 50             | 250            |
| PM6-6R-L    |                               | M6        | 23.5                   | 10.9 | 9.7 |                               | 50             | 250            |
| PM6-8R-L    |                               | M8        | 24.7                   | 13.3 | 9.7 |                               | 50             | 250            |

For crimping tool information, see pages D1.84 and D1.88.

## Metric Fork Terminal, Nylon Insulated – Funnel Entry

### Type PMNF-F

- Fork design provides for fast and easy installation, without the need to remove fastener
- Metal insulation grip sleeve crimps to wire insulation, providing protection to the crimp joint during high vibration applications
- Internal barrel serrations assure good wire contact and maximum tensile strength
- Maximum insulation temperature 221°F (105°C)
- Rated up to 600 V

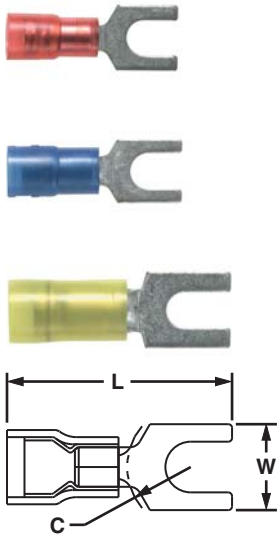

| Part Number | Wire Range (mm²) | Color Code | Max. Ins. (mm) | Stud Size | Figure Dimensions (mm) |      |     | Recommended Installation Tool | Std. Pkg. Qty. | Std. Ctn. Qty. |
|-------------|------------------|------------|----------------|-----------|------------------------|------|-----|-------------------------------|----------------|----------------|
|             |                  |            |                |           | L                      | W    | C   |                               |                |                |
| PMNF1-3F-C  | 0.5 – 1.0        | Red        | 3.76           | M3        | 21.1                   | 5.9  | 5.1 | CT-1550, CT-2500              | 100            | 500            |
| PMNF1-4F-C  |                  |            | 3.76           | M4        | 22.6                   | 8.1  | 5.8 |                               | 100            | 500            |
| PMNF1-5F-C  |                  |            | 3.76           | M5        | 22.9                   | 8.9  | 6.4 |                               | 100            | 500            |
| PMNF1-6F-C  |                  |            | 3.76           | M6        | 27.4                   | 11.2 | 8.4 |                               | 100            | 500            |
| PMNF2-3F-C  | 1.5 – 2.5        | Blue       | 4.11           | M3        | 19.8                   | 5.9  | 5.1 | CT-1550, CT-2500              | 100            | 500            |
| PMNF2-4F-C  |                  |            | 4.11           | M4        | 21.3                   | 7.9  | 5.9 |                               | 100            | 500            |
| PMNF2-5F-C  |                  |            | 4.11           | M5        | 21.9                   | 8.6  | 6.4 |                               | 100            | 500            |
| PMNF2-6F-C  |                  |            | 4.11           | M6        | 26.2                   | 11.2 | 8.5 |                               | 100            | 500            |
| PMNF6-4F-L  | 4.0 – 6.0        | Yellow     | 5.94           | M4        | 27.2                   | 7.9  | 6.2 | CT-1550, CT-2500              | 50             | 250            |
| PMNF6-5F-L  |                  |            | 5.94           | M5        | 26.9                   | 9.5  | 6.2 |                               | 50             | 250            |
| PMNF6-6F-L  |                  |            | 5.94           | M6        | 29.0                   | 11.0 | 8.2 |                               | 50             | 250            |

For crimping tool information, see pages D1.84 and D1.88.

## Metric Fork Terminal, Vinyl Insulated – Funnel Entry

### Type PMV-F

- Fork design provides for fast and easy installation, without the need to remove fastener
- Insulation support helps to prevent wire damage in bending applications
- Brazed seam protects terminal barrel from splitting during the crimp process
- Internal barrel serrations assure good wire contact and maximum tensile strength
- Maximum insulation temperature 221°F (105°C)
- Rated up to 600 V

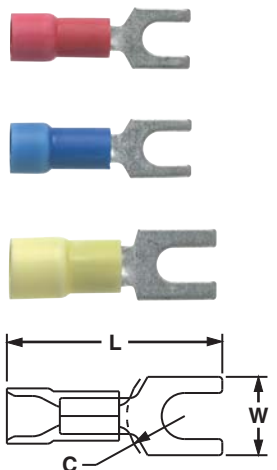

| Part Number | Wire Range (mm²) | Color Code | Max. Ins. (mm) | Stud Size | Figure Dimensions (mm) |      |     | Recommended Installation Tool | Std. Pkg. Qty. | Std. Ctn. Qty. |
|-------------|------------------|------------|----------------|-----------|------------------------|------|-----|-------------------------------|----------------|----------------|
|             |                  |            |                |           | L                      | W    | C   |                               |                |                |
| PMV1-3FB-CY | 0.5 – 1.0        | Red        | 4.01           | M3        | 21.6                   | 5.8  | 4.8 | CT-1550, CT-2500              | 100            | 500            |
| PMV1-4FB-CY |                  |            | 4.01           | M4        | 23.1                   | 8.1  | 5.8 |                               | 100            | 500            |
| PMV1-5FB-CY |                  |            | 4.01           | M5        | 23.6                   | 9.1  | 6.1 |                               | 100            | 500            |
| PMV1-6FB-CY |                  |            | 4.01           | M6        | 27.9                   | 11.2 | 8.1 |                               | 100            | 500            |
| PMV2-3FB-C  | 1.5 – 2.5        | Blue       | 4.70           | M3        | 21.3                   | 5.8  | 4.8 | CT-1550, CT-2500              | 100            | 500            |
| PMV2-4FB-C  |                  |            | 4.70           | M4        | 22.9                   | 7.9  | 5.8 |                               | 100            | 500            |
| PMV2-5FB-C  |                  |            | 4.70           | M5        | 23.4                   | 8.6  | 6.1 |                               | 100            | 500            |
| PMV2-6FB-C  |                  |            | 4.70           | M6        | 27.7                   | 11.2 | 8.1 |                               | 100            | 500            |
| PMV6-4F-L   | 2.5 – 6.0        | Yellow     | 6.10           | M4        | 26.4                   | 8.1  | 5.6 | CT-1550, CT-2500              | 50             | 250            |
| PMV6-5F-L   |                  |            | 6.10           | M5        | 26.4                   | 9.7  | 5.6 |                               | 50             | 250            |
| PMV6-6F-L   |                  |            | 6.10           | M6        | 29.5                   | 10.9 | 8.1 |                               | 50             | 250            |

For crimping tool information, see pages D1.84 and D1.88.

A. System Overview

## Metric Fork Terminal, Non-Insulated

B1. Cable Ties

### Type PM-F

- Fork design provides for fast and easy installation, without the need to remove fastener
- Internal barrel serrations assure good wire contact and maximum tensile strength
- Brazed seam protects terminal barrel from splitting during the crimp process
- Barrel of terminal internally beveled to provide quick and easy wire insertion
- Maximum recommended operating temperature 302°F (150°C)
- Rated up to 2000 V

B2. Cable Accessories

B3. Stainless Steel Ties



C1. Wiring Duct



C2. Surface Raceway



C3. Abrasion Protection

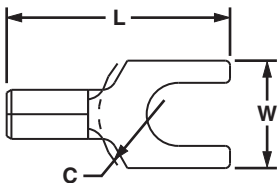

C4. Cable Management

| Part Number     | Wire Range (mm <sup>2</sup> ) | Stud Size | Figure Dimensions (mm) |      |     | Recommended Installation Tool | Std. Pkg. Qty. | Std. Ctn. Qty. |
|-----------------|-------------------------------|-----------|------------------------|------|-----|-------------------------------|----------------|----------------|
|                 |                               |           | L                      | W    | C   |                               |                |                |
| <b>PM1-3F-C</b> | 0.5 – 1.5                     | M3        | 16.0                   | 5.8  | 5.6 | CT-1570, CT-2500              | 100            | 500            |
| <b>PM1-4F-C</b> |                               | M4        | 17.5                   | 8.1  | 6.4 |                               | 100            | 500            |
| <b>PM1-5F-C</b> |                               | M5        | 18.0                   | 8.8  | 6.6 |                               | 100            | 500            |
| <b>PM2-3F-C</b> | 1.0 – 2.5                     | M3        | 16.0                   | 5.8  | 5.6 | CT-1570, CT-2500              | 100            | 500            |
| <b>PM2-4F-C</b> |                               | M4        | 17.5                   | 7.9  | 6.4 |                               | 100            | 500            |
| <b>PM2-5F-C</b> |                               | M5        | 18.0                   | 8.6  | 6.9 |                               | 100            | 500            |
| <b>PM6-5F-L</b> | 4.0 – 6.0                     | M5        | 19.4                   | 9.5  | 7.1 | CT-1570, CT-2500              | 50             | 250            |
| <b>PM6-6F-L</b> |                               | M6        | 22.6                   | 10.9 | 8.6 |                               | 50             | 250            |

For crimping tool information, see pages D1.84 and D1.88.

## Plastic Box Terminal Kits

- Ideal for maintenance and construction wiring
- Positive latching case prevents accidental opening
- With the case top closed, parts remain in their compartments
- Case features a hanging tab for storage

D1. Terminals



KP-1075Y

D2. Power Connectors

D3. Grounding Connectors



KP-1165Y

| Part Number     | Part Description   | Std. Pkg. Qty. |
|-----------------|--|----------------|
| <b>KP-1075Y</b> | Terminal kit without crimping tool. Includes the following: (20) PV18-8R; PV18-6F; PV14-8F; PV14-10R; (10) PV10-8R; PV10-10R; DNF14-250; DNF18-250; BSV18X; BSV14X; BSV10X; (10) JN418-212.                                      | 1              |
| <b>KP-1000</b>  | Empty plastic box, twelve terminal compartments and one tool compartment, measures 11" wide x 6 3/4" deep x 1 3/4" high. Positive latch prevents accidental opening. Once top is closed, terminals remain in their compartments. | 1              |
| <b>KP-1165Y</b> | Includes the following: (18) PV18-8R; PV14-10R; PV18-6F; PV14-8F; (10) PV10-8R; PV10-10R; BSV18X; BSV14X; BSV10X; DV18-250B; DV14-188B; (5) JN418-212; (1) CT-160 Tool; KP-1000 box.   | 1              |
| <b>KP-1166</b>  | Includes the following: (18) P18-8R; P14-10R; P18-6F; P14-8F; (10) P10-8R; P10-10R; BS18; BS14; BS10; D18-250; D14-188; (5) JN218-216; (1) CT-160 tool; KP-1000 box.   | 1              |

E1. Labeling Systems

E2. Labels

## **NEW!** Fabric Terminal Kit

- Versatile fabric kit stores up to five standard packs of terminals
- Kit includes pocket for storage of an installation tool or cable ties
- Zipper closure prevents accidental opening
- Kit features a hanging tab for storage

E3. Pre-Printed & Write-On Markers



E4. Permanent Identification

E5. Lockout/Tagout & Safety Solutions

F. Index

| Part Number    | Part Description   | Std. Pkg. Qty. |
|----------------|--|----------------|
| <b>KF-1005</b> | Empty fabric kit, 5 terminal compartments and one tool compartment, measures 5 1/2" wide x 2 1/2" deep x 11 1/2" high. | 1              |

Terminal parts sold separately





## Steel Kit Boxes

- Latch prevents accidental opening
- Once lid is closed, terminals remain in their compartments
- Handle for portability or as drawer pull when used in rack



- Drop-in label area on front measures: 2.13"H x 13.75"W x 9.75"D (54.0mm x 349.3mm x 247.7mm)

| Part Number | Part Description  | Std. Pkg. Qty. |
|-------------|---|----------------|
| K-1000      | Empty steel box, 20 terminal compartments and one tool compartment, dimensions: 2.00"H x 13.33"W x 9.33"D (50.8mm x 338.6mm x 237.0mm).   | 1              |
| K-1001      | Empty steel kit box, 15 terminal compartments and two tool compartments, box dimensions: 2.00"H x 13.33"W x 9.33"D (50.8mm x 338.6mm x 237.0mm).                                | 1              |
| K-1100      | Steel box and CT-100A crimping tool.  | 1              |
| K-1102Y     | Includes the following: (100) PV18-6LF; PV18-8LF; PV14-8LF; PV14-10LF; BSV18X; BSV14X; (50) PV10-10LF; BSV10X; (1) CT-100A tool; K-1000 box.                                    | 1              |
| K-1103Y     | Includes the following: (100) DV18-250B; DV14-250B; DV14-250MB; D18-250; D14-250; (50) DV10-250; D10-250; (1) CT-100A tool; K-1000 box.   | 1              |
| K-1104      | Includes the following: (50) PN18-10R; PN14-6R; PN14-10R; PN18-6F; PN14-6F; PN14-10F; (25) PN10-10R; PN10-56R; PN10-10F; BSN14; BSN10; JN418-212; (1) CT-100A tool; K-1000 box. | 1              |

## Steel Slide Racks

- Steel boxes for cable tie kits and K-1000 terminal kits
- Steel boxes, storage slide racks, and base can be combined for neat and organized storage of cable ties and terminals

- Rugged and durable steel construction
- Empty boxes, full kits, slide racks and base are purchased according to your application needs



| Part Number | Part Description  | Std. Pkg. Qty. |
|-------------|---|----------------|
| SR2         | 2-drawer slide rack to hold K-504 cable tie kit or K-1000 series terminal kit. Dimensions: 6.25"H x 15.25"W x 11.75"D (158.7mm x 387.4mm x 298.5mm) | 1              |
| SR4         | 4-drawer slide rack to hold K-1000 series terminal kit. Dimensions: 11.25"H x 15.25"W x 11.75"D (285.8mm x 387.4mm x 298.5mm)                       | 1              |
| SR6         | 6-drawer slide rack to hold K-1000 series terminal kit. Dimensions: 16.38"H x 15.25"W x 11.75"D (416.1mm x 387.4mm x 298.5mm)                       | 1              |

| Slide racks will accommodate the following Panduit kits: |           |
|--|-----------|
| K-1000   | K-1103Y   |
| K-1001   | K-1104    |
| K-1100   | K1-PNKIT  |
| K-1102Y  | K2-PVKITY |

A. System Overview

B1. Cable Ties

B2. Cable Accessories

B3. Stainless Steel Ties

C1. Wiring Duct

C2. Surface Raceway

C3. Abrasion Protection

C4. Cable Management

D1. Terminals

D2. Power Connectors

D3. Grounding Connectors

E1. Labeling Systems

E2. Labels

E3. Pre-Printed & Write-On Markers

E4. Permanent Identification

E5. Lockout/Tagout & Safety Solutions

F. Index

A. System Overview

## Industrial Maintenance Kits

B1. Cable Ties

- Steel kits have individual compartments for storage of terminals
- Convenient carrying handle
- Once top is closed, terminals remain in their compartments

B2. Cable Accessories

B3. Stainless Steel Ties

C1. Wiring Duct

C2. Surface Raceway

C3. Abrasion Protection

C4. Cable Management



K1-PNKIT



K2-PVKITY



K-205

D1. Terminals

D2. Power Connectors

D3. Grounding Connectors

E1. Labeling Systems

E2. Labels

E3. Pre-Printed & Write-On Markers

E4. Permanent Identification

E5. Lockout/Tagout & Safety Solutions

F. Index

| Part Number | Part Description   | Std. Pkg. Qty. |
|-------------|--|----------------|
| K1-PNKIT    | <p>Kit contains:</p> <ul style="list-style-type: none"> <li>(1) K-1001 steel kit box</li> <li>(1) CT-260 installation tool</li> </ul> <p><u>Cable Ties</u></p> <ul style="list-style-type: none"> <li>(100) PLT2S cable ties</li> </ul> <p><u>Terminals</u></p> <ul style="list-style-type: none"> <li>(100) PN14-610R multi-stud terminals</li> <li>(100) PN18-610R multi-stud terminals</li> <li>(100) PN18-6LF locking fork terminals</li> <li>(100) PN14-8LF locking fork terminals</li> <li>(50) PN10-10LF locking fork terminals</li> <li>(100) PN18-8F fork terminals</li> <li>(100) PN14-10R ring terminals</li> <li>(50) PN10-10R ring terminals</li> </ul> <p><u>Disconnects</u></p> <ul style="list-style-type: none"> <li>(100) DNF18-250 disconnects</li> <li>(100) DNF14-250 disconnects</li> <li>(50) DV10-250 disconnects</li> </ul> <p><u>Splices</u></p> <ul style="list-style-type: none"> <li>(50) BSN18 butt splices</li> <li>(50) BSN14 butt splices</li> <li>(25) BSN10 butt splices</li> </ul> <p><u>Marking System</u></p> <ul style="list-style-type: none"> <li>(1) PMD-0-9 marking dispenser and tape</li> <li>(100) MP150 marker tags</li> <li>(1) PX-0 marker</li> </ul>               | 1              |
| K2-PVKITY   | <p>Kit contains:</p> <ul style="list-style-type: none"> <li>(1) K-1001 steel kit box</li> <li>(1) CT-260 installation tool</li> </ul> <p><u>Cable Ties</u></p> <ul style="list-style-type: none"> <li>(100) PLT2S cable ties</li> </ul> <p><u>Terminals</u></p> <ul style="list-style-type: none"> <li>(100) PV18-8F fork terminals</li> <li>(100) PV18-6LF locking fork terminals</li> <li>(100) PV14-8LF locking fork terminals</li> <li>(50) PV10-10LF locking fork terminals</li> <li>(100) PV18-610R multi-stud terminals</li> <li>(100) PV14-10R ring terminals</li> <li>(50) PV10-10R ring terminals</li> </ul> <p><u>Disconnects</u></p> <ul style="list-style-type: none"> <li>(100) DNF18-250 disconnects</li> <li>(100) DV14-250B disconnects</li> <li>(50) DV10-250 disconnects</li> </ul> <p><u>Splices</u></p> <ul style="list-style-type: none"> <li>(50) BSV18X butt splices</li> <li>(50) BSV14X butt splices</li> <li>(25) BSV10X butt splices</li> </ul> <p><u>Wire Joints</u></p> <ul style="list-style-type: none"> <li>(30) JN224-318</li> <li>(15) JN314-412</li> </ul> <p><u>Marking System</u></p> <ul style="list-style-type: none"> <li>(1) PMD-0-9 marking dispenser and tape</li> </ul> | 1              |
| K-205*      | <p><b>Kit for Indoor Use</b></p> <p>Pan-Ty® Cable Ties, cable tie installation tool, terminals, splices and crimp tool:</p> <ul style="list-style-type: none"> <li>(1) GTS tool</li> <li>(1) CT-100A crimp tool</li> </ul> <p><u>Natural Nylon 6.6 Cable Ties</u></p> <ul style="list-style-type: none"> <li>(100) PLT1M</li> <li>(100) PLT1.5I</li> <li>(100) PLT2S</li> </ul> <p><u>Terminals</u></p> <ul style="list-style-type: none"> <li>(100) PV18-6LF</li> <li>(100) PV14-8LF</li> <li>(100) PV14-10LF</li> <li>(50) PV10-10LF</li> </ul> <p><u>Splices</u></p> <ul style="list-style-type: none"> <li>(50) BSV10X</li> <li>(100) BSV14X</li> <li>(100) BSV18X</li> </ul>  | 1              |

\*The K-205 does not fit into the SR2, SR4, or SR6.

## PAN-TERM® DISCONNECTS

Panduit® Pan-Term® Disconnects are designed and precision made to function as a reliable method of making quick, repeatable interconnections. Available with nylon, premium nylon, vinyl insulation or non-insulated.



- Fully insulated design provides excellent protection from electrical shorts and provides additional installer protection for safety from electrical shocks
- Funnel entry speeds insertion and minimizes turned back wire strands
- Integrated metal insulation grip provides double crimp insulation grip for high vibration or conductor strain environments on select Supra-Grip™ Disconnects and Disco-Lok™ Disconnects and DiscoGrip™ Disconnects
- Applicable sizes are UL Listed and CSA Certified, as noted
- Wide assortment of manual, controlled cycle, battery operated hydraulic and pneumatic crimping tools for reliable connections at the lowest installed cost

Panduit continually provides new designs to meet the application challenges encountered by our customers. Panduit offers a wide assortment of Pan-Term® termination products at the lowest installed cost.

A.  
System  
Overview

B1.  
Cable Ties

B2.  
Cable  
Accessories

B3.  
Stainless  
Steel Ties

C1.  
Wiring  
Duct

C2.  
Surface  
Raceway

C3.  
Abrasion  
Protection

C4.  
Cable  
Management

D1.  
Terminals

D2.  
Power  
Connectors

D3.  
Grounding  
Connectors

E1.  
Labeling  
Systems

E2.  
Labels

E3.  
Pre-Printed  
& Write-On  
Markers

E4.  
Permanent  
Identification

E5.  
Lockout/  
Tagout  
& Safety  
Solutions

F.  
Index

A. System Overview

## Features and Benefits – Pan-Term® Disconnects

Pan-Term® Disconnects are fabricated from brass and are electro tin-plated for a long, corrosion resistant operating life.

B1. Cable Ties

B2. Cable Accessories

B3. Stainless Steel Ties

C1. Wiring Duct

C2. Surface Raceway

C3. Abrasion Protection

C4. Cable Management

### Nylon Fully Insulated Female Receptacles and Male Tabs Type DNF-FIB

Available in tab sizes to accommodate .110", .187", .205" or .250" tabs

Fully insulated design provides protection from electrical shorts

Expanded wire entry (on select sizes) accommodates large insulation or multiple wires

Maximum insulation temperature 221°F (105°C)

Insulation support restricts excessive wire movement to minimize stress on crimp joint

Funnel entry for faster wire insertion and lower installed cost



UL and CSA rated up to 600 V per UL 310. Flammability – UL 94V-2/HB.



### Disco-Grip™ Premium Nylon Fully Insulated Female Receptacles and Male Tabs Type DPF

Available in tab sizes to accommodate .110", .187", .205" or .250" tabs

Fully insulated design provides protection from electrical shorts

Maximum insulation temperature 221°F (105°C)

Funnel entry for faster wire insertion and lower installed cost



UL and CSA rated up to 600 V per UL 310.

Flammability – UL 94V-2.

Male products available .250" width in standard and oversized housing configurations.

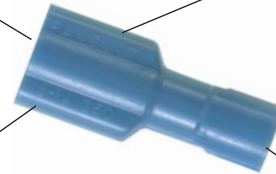

D1. Terminals

D2. Power Connectors

D3. Grounding Connectors

E1. Labeling Systems

E2. Labels

E3. Pre-Printed & Write-On Markers

E4. Permanent Identification

E5. Lockout/Tagout & Safety Solutions

F. Index

### Supra-Grip™ Nylon Fully Insulated Female Disconnects Type DNG-FB

Available in tab sizes to accommodate .187" or .250" tabs

Fully insulated design provides protection from electrical shorts

Maximum insulation temperature 221°F (105°C)

Funnel entry for faster wire insertion and lower installed cost

Fully integrated metal insulation grip for high vibration, high strain relief, and double crimp requirements



UL and CSA rated up to 600 V per UL 310. Flammability – UL 94V-2/HB.



### Disco-Lok™ Nylon Fully Insulated Locking Female Disconnects Type DNG-FL

Available in tab sizes to accommodate .250" tabs

Unique locking mechanism allows for low insertion forces (mating) and positive locking for secure connections

Maximum insulation temperature 221°F (105°C)

Funnel entry for faster wire insertion and lower installed cost

Insulation grip sleeve provides a superior insulation crimp for high vibration and high strain relief applications



UL and CSA rated up to 300 V per UL 310.

Flammability – UL 94V-2/HB.

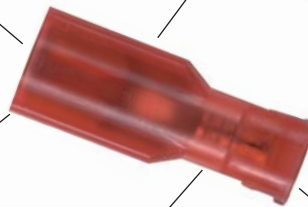

Panduit extensive line of tooling is specifically designed for optimum crimping performance.

See pages D1.83 – D1.89.



Panduit designs and manufactures a full line of labeling products, software, and printers to assist you with your labeling requirements.

See pages E1.1 – E2.28.

## Features and Benefits – Pan-Term® Disconnects (continued)

### Nylon Barrel Insulated Female Receptacles and Male Tabs Type DNF

Available in tab sizes to accommodate .110", .187", .205" or .250" tabs

Maximum insulation temperature 194°F (90°C)

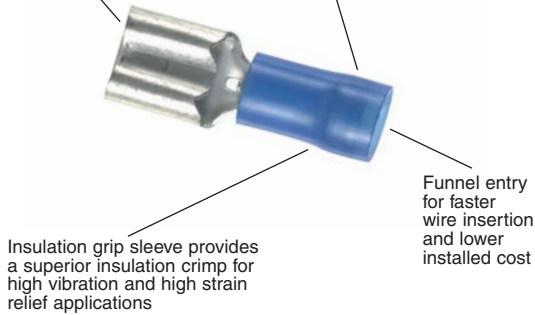

Insulation grip sleeve provides a superior insulation crimp for high vibration and high strain relief applications

Funnel entry for faster wire insertion and lower installed cost



UL and CSA rated up to 300 V per UL 310.  
Flammability – UL 94V-2/HB.  
Male products available .250" width.

### Vinyl Barrel Insulated Female Receptacles and Male Tabs Type DV and DVF

Available in tab sizes to accommodate .187", .205", or .250" tabs

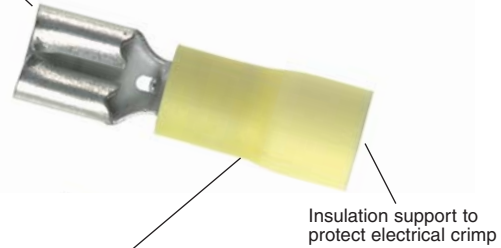

Insulation grip sleeve provides a superior insulation crimp for high vibration and high strain relief applications

Insulation support to protect electrical crimp



UL and CSA rated up to 300 V per UL 310.  
Male products available .250" width.  
Flammability – UL 94V-0.

### Non-Insulated Female Receptacles and Male Tabs Type D

Available in tab sizes to accommodate .187" or .250" tabs

Maximum recommended operating temperature 302°F (150°C)



Sleeved barrel assures crimp reliability



UL and CSA rated up to 2000 V per UL 310.  
Male products available .250" width.

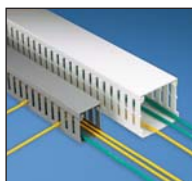

Panduit wiring duct offers a wide variety of sizes and types to meet the wire capacity needs and space constraints of the smallest wall mounted to the largest integrated systems.

See pages C1.1 – C1.52.



A comprehensive selection of cable ties used to bundle, mount, and identify wire and cable.

See pages B1.1 – B1.120.

A.  
System  
Overview

B1.  
Cable Ties

B2.  
Cable  
Accessories

B3.  
Stainless  
Steel Ties

C1.  
Wiring  
Duct

C2.  
Surface  
Raceway

C3.  
Abrasion  
Protection

C4.  
Cable  
Management

D1.  
Terminals

D2.  
Power  
Connectors

D3.  
Grounding  
Connectors

E1.  
Labeling  
Systems

E2.  
Labels

E3.  
Pre-Printed  
& Write-On  
Markers

E4.  
Permanent  
Identification

E5.  
Lockout/  
Tagout  
& Safety  
Solutions

F.  
Index

## Selection Guide – Pan-Term® Disconnects

A. System Overview

B1. Cable Ties

B2. Cable Accessories

B3. Stainless Steel Ties

C1. Wiring Duct

C2. Surface Raceway

C3. Abrasion Protection

C4. Cable Management

D1. Terminals

D2. Power Connectors

D3. Grounding Connectors

E1. Labeling Systems

E2. Labels

E3. Pre-Printed & Write-On Markers

E4. Permanent Identification

E5. Lockout/Tagout & Safety Solutions

F. Index

### Disconnects



| Material      | Style            | Design             | Feature                            | Type     | Page Number |
|---------------|------------------|--------------------|------------------------------------|----------|-------------|
| Nylon         | Fully Insulated  | Female             | Funnel Entry, Ins. Grip            | DNG-FB   | D1.43       |
|               |                  | Female             | Funnel, Ins. Grip, Locking         | DNG-FL   | D1.44       |
|               |                  | Female             | Funnel, Ins. Support, Two-Pc.      | DNF-FIB  | D1.45       |
|               |                  | Female             | Funnel, Ins. Support, Three-Pc.    | DNF-FI   | D1.45       |
|               |                  | Female             | Funnel Entry, Premium Nylon        | DPF-FIB  | D1.46       |
|               | Barrel Insulated | Male               | Funnel, Ins. Support, Two-Pc.      | DNF-FIM  | D1.44       |
|               |                  | Male               | Premium Nylon                      | DPF-FIM  | D1.46       |
|               |                  | Female Right Angle | Funnel Entry, Ins. Support         | DNFR-FIB | D1.49       |
|               |                  | Female Right Angle | Funnel Entry, Open Top             | DNFR-B   | D1.50       |
|               |                  | Female             | Funnel Entry, Ins. Grip            | DNF      | D1.47       |
| Vinyl         | Barrel Insulated | Male               | Funnel Entry, Ins. Grip            | DNF-M    | D1.52       |
|               |                  | Female             | Funnel Entry, Ins. Grip, Three-Pc. | DVF      | D1.48       |
|               |                  | Female             | Funnel Entry, Butted Seam, Two-Pc. | DV-B     | D1.48       |
|               |                  | Male               | Funnel Entry, Butted Seam, Two-Pc. | DV-MB    | D1.52       |
|               |                  | Piggyback          | Funnel Entry, Ins. Grip            | DV-P     | D1.51       |
| Heat Shrink   | Fully Insulated  | Female             | Heat Shrink Insulated              | DNH-FIB  | D1.47       |
|               |                  | Male               | Heat Shrink Insulated              | DNH-FIM  | D1.47       |
| Non-Insulated |                  | Female             | Sleeved Barrel                     | D        | D1.49       |
|               |                  | Female Right Angle | Sleeved Barrel                     | DR       | D1.50       |
|               |                  | Female Right Angle | Butted Seam                        | DR-B     | D1.51       |
|               |                  | Male               | Butted Seam                        | D-MB     | D1.53       |
|               |                  | Adapter            | Two Female to One Male             | D-A      | D1.51       |



## Part Number System for Pan-Term® Disconnects

| D               | NF  | — | 14            | 250                       | FIB   | — | M                     |
|-----------------|---|---|---------------|---------------------------|---|---|-----------------------|
| Type            | Insulation                                      |   | Wire Range    | Tab Size                  | Special Configuration                               |   | Standard Package Size |
| D = Disconnects | N = Nylon                                       |   | 18 = #22 – 18 | 110 = 0.110 x 0.032       | A = Adapter   |   | L = 50                |
|                 | NF = Nylon, Funnel Entry                        |   | 14 = #16 – 14 | 111 = 0.110 x 0.020       | B = Butted Seam                                     |   | C = 100               |
|                 | NFR = Nylon, Funnel Entry, Right Angle          |   | 10 = #12 – 10 | 145 = 0.145 x 0.032       | FB = Metal Insulation Grip, Female                  |   | D = 500               |
|                 | NG = Nylon, Funnel Entry, Metal Insulation Grip |   |               | 187 = 0.187 x 0.032       | FI = Fully Insulated, Female                        |   | M = 1000              |
|                 | NH = Heat Shrink                                |   |               | 188 = 0.187 x 0.020       | FIB = Fully Insulated, Butted Seam, Female          |   |                       |
|                 | PF = Premium Grade Nylon, Funnel Entry          |   |               | 205 = 0.187/0.205 x 0.032 | FIM = Fully Insulated, Male                         |   |                       |
|                 | R = Non-insulated, Right Angle                  |   |               | 206 = 0.187/0.205 x 0.020 | FIMB = Fully Insulated, Male with Oversized Housing |   |                       |
|                 | V = Vinyl                                       |   |               | 250 = 0.250 x 0.032       | FL = Locking, Metal Insulation Grip, Female         |   |                       |
|                 | VF = Vinyl Funnel Entry                         |   |               |                           | M = Male  |   |                       |
|                 | = Non-Insulated (leave blank)                   |   |               |                           | MB = Butted, Male                                   |   |                       |
|                 |   |   |               |                           | P = Piggyback                                       |   |                       |
|                 |   |   |               |                           | = Female (leave blank)                              |   |                       |

## Supra-Grip™ Female Disconnect, Nylon Fully Insulated – Funnel Entry

### Type DNG-FB

- Disconnect can be inserted and removed from the male tab without the use of tools for lower installed cost
- Flared barrel extension integrated into stamping to provide insulation grip for double crimp requirements
- Fully insulated design provides protection from electrical shorts
- Internal barrel serrations assure good wire contact and maximum tensile strength
- Internal wire stop assures proper length of insertion into terminal barrel, providing a higher-quality connection
- Mates with DNF-FIMB family
- UL Flammability UL 94V-2/HB, maximum insulation temperature 221°F (105°C)
- UL and CSA rated up to 600 V per UL 310

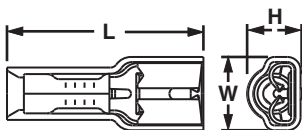

| Part Number    | Wire Range  | Color Code | Max. Ins. (In.) | Figure Dimensions (In.) |      |      | Tab Size (In.) | Recommended Installation Tool | Std. Pkg. Qty.** | Std. Ctn. Qty. |
|----------------|-------------|------------|-----------------|-------------------------|------|------|----------------|-------------------------------|------------------|----------------|
|                |             |            |                 | L                       | W    | H    |                |                               |                  |                |
| DNG18-187FB-C  | 22 – 18 AWG | Red        | 0.126           | 0.89                    | 0.29 | 0.22 | 0.187 x 0.032  | CT-1015                       | 100              | 1000           |
| DNG18-188FB-C  |             |            | 0.126           | 0.89                    | 0.29 | 0.22 | 0.187 x 0.020  |                               | 100              | 1000           |
| DNG18-250FB-L  |             |            | 0.126           | 0.93                    | 0.35 | 0.22 | 0.250 x 0.032  |                               | 50               | 250            |
| DNG14-187FB-L* | 16 – 14 AWG | Blue       | 0.153           | 0.89                    | 0.29 | 0.25 | 0.187 x 0.032  | CT-1015                       | 50               | 250            |
| DNG14-188FB-L* |             |            | 0.153           | 0.89                    | 0.29 | 0.25 | 0.187 x 0.020  |                               | 50               | 250            |
| DNG14-250FB-L  |             |            | 0.153           | 0.93                    | 0.35 | 0.25 | 0.250 x 0.032  |                               | 50               | 250            |

\*UL Recognized for use with copper alloy tabs.

\*\*Bulk packaging may be available, contact Panduit Customer Service for additional information.

For crimping tool information, see page D1.84.

A. System Overview

## Disco-Lok™ Female Disconnect, Nylon Fully Insulated – Funnel Entry

B1. Cable Ties

### Type DNG-FL

- Disconnect can be inserted and removed from the male tab without the use of tools for lower installed cost
- Unique locking mechanism design allows for low insertion forces (mating) and positive lock for high vibration applications where a secure connection is mandatory
- Fully insulated design provides protection from electrical shorts
- Flared barrel extension integrated into stamping to provide insulation grip for double crimp requirements
- Insulation housing moves back and forth to engage and disengage locking mechanism for repeated use.
- Specialty tool required to install this disconnect (CT-1014)
- Mates with DNF-FIMB family
- UL Flammability UL 94V-2/HB, maximum insulation temperature 221°F (105°C)
- UL and CSA rated up to 300 V per UL 310

B2. Cable Accessories

B3. Stainless Steel Ties



| Part Number          | Wire Range  | Color Code | Max. Ins. (In.) | Figure Dimensions (In.) |      |      | Tab Size (In.) | Recommended Installation Tool | Std. Pkg. Qty.** | Std. Ctn. Qty. |
|----------------------|-------------|------------|-----------------|-------------------------|------|------|----------------|-------------------------------|------------------|----------------|
|                      |             |            |                 | L                       | W    | H    |                |                               |                  |                |
| <b>DNG18-250FL-L</b> | 22 – 18 AWG | Red        | 0.126           | 0.97                    | 0.36 | 0.24 | 0.250 x 0.032  | CT-1014                       | 50               | 250            |
| <b>DNG14-250FL-L</b> | 16 – 14 AWG | Blue       | 0.150           | 0.97                    | 0.36 | 0.25 | 0.250 x 0.032  | CT-1014                       | 50               | 250            |

C1. Wiring Duct

C2. Surface Raceway



C3. Abrasion Protection

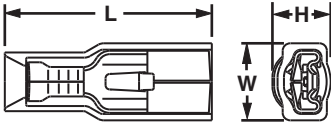

\*\*Bulk packaging may be available, contact Panduit Customer Service for additional information. For crimping tool information, see page D1.84.

C4. Cable Management

## Male/Female Coupler, Nylon Fully Insulated – Funnel Entry

### Type DNF

- Disconnect can be inserted and removed from the male tab without the use of tools for lower installed cost
- Fully insulated design provides protection from electrical shorts
- Internal barrel serrations assure good wire contact and maximum tensile strength
- Internal wire stop assures proper length of insertion into terminal barrel, providing a higher quality connection
- Coupler, male, and female parts sold separately
- UL Flammability UL 94V-2/HB, maximum insulation temperature 221°F (105°C)
- UL and CSA rated up to 600 V per UL 310

D1. Terminals

D2. Power Connectors

D3. Grounding Connectors



MALE



FEMALE

| Part Number                  | Wire Range  | Color Code | Max. Ins. (In.) | Figure Dimensions (In.) |      |      | Tab Size (In.) | Recommended Installation Tool           | Std. Pkg. Qty.** | Std. Ctn. Qty. |
|------------------------------|-------------|------------|-----------------|-------------------------|------|------|----------------|---|------------------|----------------|
|                              |             |            |                 | L                       | W    | H    |                |   |                  |                |
| <b>DNF18-250FIM-L Male</b>   | 22 – 18 AWG | Red        | 0.133           | 0.90                    | 0.42 | 0.27 | 0.250 x 0.032  | CT-100A‡, CT-600-A, CT-1525‡, CT-2500‡  | 50               | 250            |
| <b>DNF18-250FIMB-L Male</b>  |             |            | 0.136           | 0.91                    | 0.45 | 0.34 | 0.250 x 0.032  |   |                  |                |
| <b>DNF18-250FIB-C Female</b> |             |            | 0.136           | 0.84                    | 0.35 | 0.22 | 0.250 x 0.032  |   | 100              | 1000           |
| <b>DNF14-250FIM-L Male</b>   | 16 – 14 AWG | Blue       | 0.158           | 0.90                    | 0.42 | 0.27 | 0.250 x 0.032  | CT-600-A, CT-1525‡, CT-2500‡            | 50               | 250            |
| <b>DNF14-250FIMB-Q Male</b>  |             |            | 0.160           | 0.91                    | 0.45 | 0.34 | 0.250 x 0.032  |   |                  |                |
| <b>DNF14-250FIB-C Female</b> |             |            | 0.160           | 0.84                    | 0.35 | 0.22 | 0.250 x 0.032  | CT-100A, CT-600-A, CT-1525‡, CT-2500‡   | 100              | 1000           |
| <b>DNF10-250FIMB-Q Male</b>  | 12 – 10 AWG | Yellow     | 0.220           | 0.96                    | 0.45 | 0.36 | 0.250 x 0.032  | CT-600-A‡, CT-1550‡, CT-1551‡, CT-2500‡ | 25               | 125            |
| <b>DNF10-250FI-L Female</b>  |             |            | 0.220           | 0.95                    | 0.36 | 0.27 | 0.250 x 0.032  |   |                  |                |

E1. Labeling Systems

E2. Labels

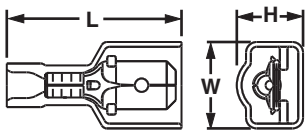

MALE

E3. Pre-Printed & Write-On Markers

E4. Permanent Identification

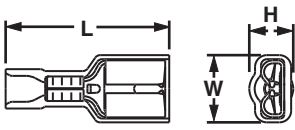

FEMALE

E5. Lockout/Tagout & Safety Solutions

F. Index

\*\*Bulk packaging may be available, contact Panduit Customer Service for additional information. ‡UL and CSA approved tooling/product combinations. For crimping tool information, see pages D1.83, D1.84, D1.86 and D1.88.



## Female Disconnect, Nylon Fully Insulated – Funnel Entry

### Type DNF-FIB

- Disconnect can be inserted and removed from the male tab without the use of tools for lower installed cost
- Fully insulated design provides protection from electrical shorts
- Internal wire stop assures proper length of insertion into terminal barrel, providing a higher quality connection
- UL Flammability UL 94V-2/HB, maximum insulation temperature 221°F (105°C)
- UL and CSA rated up to 600 V per UL 310

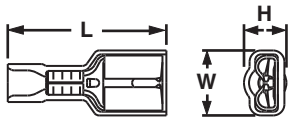

| Part Number           | Wire Range  | Color Code | Max. Ins. (In.) | Figure Dimensions (In.) |      |      | Tab Size (In.)      | Recommended Installation Tool         | Std. Pkg. Qty.** | Std. Ctn. Qty. |
|-----------------------|-------------|------------|-----------------|-------------------------|------|------|---------------------|---------------------------------------|------------------|----------------|
|                       |             |            |                 | L                       | W    | H    |                     |                                       |                  |                |
| <b>DNF18-110FIB-C</b> | 22 – 18 AWG | Red        | 0.120           | 0.71                    | 0.19 | 0.16 | 0.110 x 0.032       | CT-100A, CT-600-A, CT-1525‡, CT-2500‡ | 100              | 1000           |
| <b>DNF18-111FIB-C</b> |             |            | 0.120           | 0.71                    | 0.19 | 0.16 | 0.110 x 0.020       |                                       | 100              | 1000           |
| <b>DNF18-187FIB-C</b> |             |            | 0.136           | 0.78                    | 0.29 | 0.16 | 0.187 x 0.032       |                                       | 100              | 1000           |
| <b>DNF18-188FIB-C</b> |             |            | 0.136           | 0.78                    | 0.29 | 0.16 | 0.187 x 0.020       |                                       | 100              | 1000           |
| <b>DNF18-205FIB-L</b> |             |            | 0.136           | 0.78                    | 0.31 | 0.22 | 0.205/0.187 x 0.032 |                                       | 50               | 250            |
| <b>DNF18-206FIB-L</b> |             |            | 0.136           | 0.78                    | 0.31 | 0.22 | 0.205/0.187 x 0.020 |                                       | 50               | 250            |
| <b>DNF18-250FIB-C</b> |             |            | 0.136           | 0.84                    | 0.35 | 0.22 | 0.250 x 0.032       |                                       | 100              | 1000           |
| <b>DNF14-187FIB-C</b> | 16 – 14 AWG | Blue       | 0.160           | 0.78                    | 0.29 | 0.18 | 0.187 x 0.032       | CT-100A, CT-600-A, CT-1525‡, CT-2500‡ | 100              | 1000           |
| <b>DNF14-188FIB-C</b> |             |            | 0.160           | 0.78                    | 0.29 | 0.18 | 0.187 x 0.020       |                                       | 100              | 1000           |
| <b>DNF14-205FIB-C</b> |             |            | 0.160           | 0.78                    | 0.31 | 0.22 | 0.205/0.187 x 0.032 |                                       | 100              | 1000           |
| <b>DNF14-206FIB-C</b> |             |            | 0.160           | 0.78                    | 0.31 | 0.22 | 0.205/0.187 x 0.020 |                                       | 100              | 1000           |
| <b>DNF14-250FIB-C</b> |             |            | 0.160           | 0.84                    | 0.35 | 0.22 | 0.250 x 0.032       |                                       | 100              | 1000           |
| <b>DNF10-250FIB-L</b> | 12 – 10 AWG | Yellow     | 0.220           | 0.96                    | 0.35 | 0.23 | 0.250 x 0.032       | CT-1525‡, CT-2500‡                    | 50               | 500            |

### Female Disconnect Nylon Insulated – Expanded Entry

|                       |             |      |       |      |      |      |                     |         |    |     |
|-----------------------|-------------|------|-------|------|------|------|---------------------|---------|----|-----|
| <b>DNF18205FIBX-L</b> | 22 – 18 AWG | Red  | 0.210 | 0.87 | 0.31 | 0.22 | 0.205/0.187 x 0.032 | CT-100A | 50 | 250 |
| <b>DNF18206FIBX-L</b> |             |      | 0.210 | 0.87 | 0.31 | 0.22 | 0.205/0.187 x 0.020 |         | 50 | 250 |
| <b>DNF18250FIBX-L</b> |             |      | 0.210 | 0.93 | 0.35 | 0.22 | 0.250 x 0.032       |         | 50 | 250 |
| <b>DNF14206FIBX-L</b> | 16 – 14 AWG | Blue | 0.240 | 0.87 | 0.31 | 0.22 | 0.205/0.187 x 0.020 | CT-100A | 50 | 250 |
| <b>DNF14250FIBX-L</b> |             |      | 0.240 | 0.93 | 0.35 | 0.22 | 0.250 x 0.032       |         | 50 | 250 |

\*\*Bulk packaging may be available, contact Panduit Customer Service for additional information.

‡UL and CSA approved tooling/product combinations. For crimping tool information, see pages D1.83, D1.84, D1.86 and D1.88.



## Female Disconnect, Nylon Fully Insulated – Funnel Entry, Metal Collar

### Type DNF-FI

- Disconnect can be inserted and removed from the male tab without the use of tools for lower installed cost
- Fully insulated design provides protection from electrical shorts
- Internal wire stop assures proper length of insertion into terminal barrel, providing a higher quality connection
- Barrel design with larger outside diameter for use with more common hand tools
- UL Flammability UL 94V-2/HB, maximum insulation temperature 221°F (105°C)
- UL and CSA rated up to 600 V per UL 310

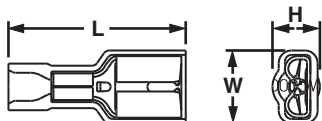

| Part Number          | Wire Range  | Color Code | Max. Ins. (In.) | Figure Dimensions (In.) |      |      | Tab Size (In.) | Recommended Installation Tool                     | Std. Pkg. Qty.** | Std. Ctn. Qty. |
|----------------------|-------------|------------|-----------------|-------------------------|------|------|----------------|---|------------------|----------------|
|                      |             |            |                 | L                       | W    | H    |                |   |                  |                |
| <b>DNF18-250FI-L</b> | 22 – 18 AWG | Red        | 0.140           | 0.94                    | 0.36 | 0.21 | 0.250 x 0.032  | CT-100A, CT-600-A, CT-1550, CT-1551, CT-2500      | 50               | 250            |
| <b>DNF14-250FI-L</b> | 16 – 14 AWG | Blue       | 0.160           | 0.94                    | 0.36 | 0.24 | 0.250 x 0.032  | CT-100A‡, CT-600-A‡, CT-1550‡, CT-1551‡, CT-2500‡ | 50               | 250            |
| <b>DNF10-250FI-L</b> | 12 – 10 AWG | Yellow     | 0.220           | 0.95                    | 0.36 | 0.27 | 0.250 x 0.032  | CT-100A‡, CT-600-A‡, CT-1550‡, CT-1551‡, CT-2500‡ | 50               | 500            |

\*\*Bulk packaging may be available, contact Panduit Customer Service for additional information.

‡UL and CSA approved tooling/product combination. For crimping tool information, see pages D1.83, D1.84, D1.86 and D1.88.

A. System Overview

B1. Cable Ties

B2. Cable Accessories

B3. Stainless Steel Ties

C1. Wiring Duct

C2. Surface Raceway

C3. Abrasion Protection

C4. Cable Management

D1. Terminals

D2. Power Connectors

D3. Grounding Connectors

E1. Labeling Systems

E2. Labels

E3. Pre-Printed & Write-On Markers

E4. Permanent Identification

E5. Lockout/Tagout & Safety Solutions

F. Index

## DiscoGrip™ Male Disconnect, Premium Nylon Fully Insulated – Funnel Entry

### Type DPF-FIM

- Disconnect can be inserted and removed from the male tab without the use of tools for lower installed cost
- Premium nylon insulation retains its shape when crimped and provides a tight grip around the wire insulation for maximum strain relief
- Fully insulated design provides protection from electrical shorts
- Oversized housing designed for maximum versatility to mate with most commercially available fully insulated female disconnects
- Internal wire stop assures proper length of insertion into terminal barrel, providing a higher quality connection
- UL Flammability UL 94V-2, maximum insulation temperature 221°F (105°C)
- UL and CSA rated up to 600 V per UL 310

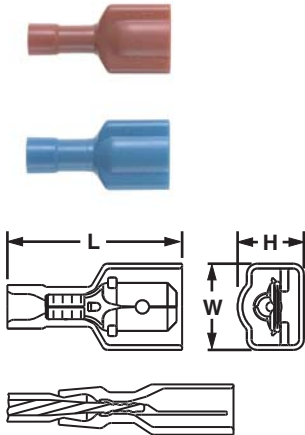

| Part Number             | Wire Range  | Color Code | Max. Ins. (In.) | Figure Dimensions (In.) |      |      | Tab Size (In.) | Recommended Installation Tool | Std. Pkg. Qty.** | Std. Ctn. Qty. |
|-------------------------|-------------|------------|-----------------|-------------------------|------|------|----------------|-------------------------------|------------------|----------------|
|                         |             |            |                 | L                       | W    | H    |                |                               |                  |                |
| <b>DPF18-250FIM-L</b>   | 22 – 18 AWG | Red        | 0.133           | 0.90                    | 0.41 | 0.29 | 0.250 x 0.032  | CT-600-A, CT-1525, CT-2500    | 50               | 250            |
| <b>DPF14-250FIM-L</b>   | 16 – 14 AWG | Blue       | 0.156           | 0.90                    | 0.41 | 0.29 | 0.250 x 0.032  |                               | 50               | 250            |
| <b>DPF18-250FIMB-L*</b> | 22 – 18 AWG | Red        | 0.133           | 0.92                    | 0.46 | 0.34 | 0.250 x 0.032  |                               | 50               | 500            |
| <b>DPF14-250FIMB-Q*</b> | 16 – 14 AWG | Blue       | 0.156           | 0.92                    | 0.46 | 0.34 | 0.250 x 0.032  |                               | 25               | 125            |

\*Oversized housing design will mate with receptacles up to .390" wide and .235" (.285" high for parts with orientation bump).

\*\*Bulk packaging may be available, contact Panduit Customer Service for additional information. For crimping tool information, see pages D1.84, D1.86, and D1.88.

## DiscoGrip™ Female Disconnect, Premium Nylon Fully Insulated – Funnel Entry

### Type DPF-FIB

- Disconnect can be inserted and removed from the male tab without the use of tools for lower installed cost
- Premium nylon insulation retains its shape when crimped and provides a tight grip around the wire insulation for maximum strain relief
- Fully insulated design provides protection from electrical shorts
- Internal wire stop assures proper length of insertion into terminal barrel, providing a higher quality connection
- UL Flammability UL 94V-2, maximum insulation temperature 221°F (105°C)
- UL and CSA rated up to 600 V per UL 310

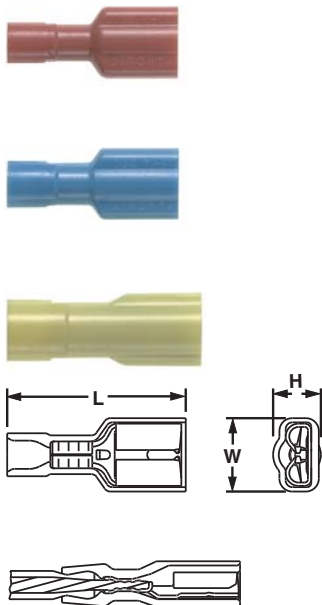

| Part Number           | Wire Range  | Color Code | Max. Ins. (In.) | Figure Dimensions (In.) |      |      | Tab Size (In.)      | Recommended Installation Tool | Std. Pkg. Qty.** | Std. Ctn. Qty. |
|-----------------------|-------------|------------|-----------------|-------------------------|------|------|---------------------|-------------------------------|------------------|----------------|
|                       |             |            |                 | L                       | W    | H    |                     |                               |                  |                |
| <b>DPF18-110FIB-C</b> | 22 – 18 AWG | Red        | 0.132           | 0.71                    | 0.19 | 0.16 | 0.110 x 0.032       | CT-600-A‡, CT-1525‡, CT-2500‡ | 100              | 1000           |
| <b>DPF18-111FIB-C</b> |             |            | 0.132           | 0.71                    | 0.19 | 0.16 | 0.110 x 0.020       |                               | 100              | 1000           |
| <b>DPF18-205FIB-C</b> |             |            | 0.133           | 0.78                    | 0.31 | 0.22 | 0.205/0.187 x 0.032 |                               | 100              | 1000           |
| <b>DPF18-206FIB-C</b> |             |            | 0.133           | 0.78                    | 0.31 | 0.22 | 0.205/0.187 x 0.020 |                               | 100              | 1000           |
| <b>DPF18-250FIB-C</b> |             |            | 0.133           | 0.84                    | 0.35 | 0.22 | 0.250 x 0.032       |                               | 100              | 1000           |
| <b>DPF14-205FIB-C</b> | 16 – 14 AWG | Blue       | 0.156           | 0.78                    | 0.31 | 0.22 | 0.205/0.187 x 0.032 | CT-600-A‡, CT-1525‡, CT-2500‡ | 100              | 1000           |
| <b>DPF14-206FIB-C</b> |             |            | 0.156           | 0.78                    | 0.31 | 0.22 | 0.205/0.187 x 0.020 |                               | 100              | 1000           |
| <b>DPF14-250FIB-C</b> |             |            | 0.156           | 0.84                    | 0.35 | 0.22 | 0.250 x 0.032       |                               | 100              | 1000           |
| <b>DPF10-250FI-L*</b> | 12 – 10 AWG | Yellow     | 0.218           | 0.95                    | 0.36 | 0.27 | 0.250 x 0.032       | CT-600-A, CT-1525, CT-2500    | 50               | 500            |
| <b>DPF10-250FIB-L</b> |             |            | 0.220           | 0.96                    | 0.35 | 0.23 | 0.250 x 0.032       |                               | 50               | 500            |

\*Not UL listed or CSA approved.

\*\*Bulk packaging may be available, contact Panduit Customer Service for additional information.

‡UL and CSA approved tooling/product combinations. For crimping tool information, see pages D1.84, D1.86, and D1.88.

## Heat Shrink Disconnects, Fully Insulated – Funnel Entry

### Type DNH

- Disconnect can be inserted and removed from the male tab without the use of tools for lower installed cost
- Fully insulated design provides protection from electrical shorts
- Heat shrink sleeving forms a protective barrier to provide environmentally sealed terminations ideal for high moisture applications
- Heat shrink sleeving provides additional level of strain relief for the wire
- Minimum continuous operating temperature -65°F (-55°C)
- Maximum continuous operation temperature 230°F (110°C)
- Shrink temperature 300°F (150°C)
- Rated up to 600 V

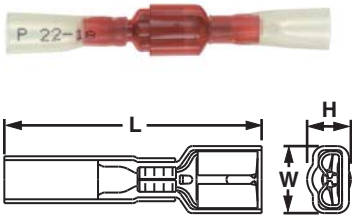

| Part Number    | Wire Range  | Color Code | Max. Ins. (In.) | Figure Dimensions (In.) |      |      | Type   | Tab Size (In.) | Recommended Installation Tool | Std. Pkg. Qty. | Std. Ctn. Qty. |    |     |
|----------------|-------------|------------|-----------------|-------------------------|------|------|--------|----------------|-------------------------------|----------------|----------------|----|-----|
|                |             |            |                 | L                       | W    | H    |        |                |                               |                |                |    |     |
| DNH18-250FIM-Q | 22 – 18 AWG | Red        | 0.133           | 1.50                    | 0.41 | 0.31 | Male   | 0.250 x 0.032  | CT-310                        | 25             | 125            |    |     |
| DNH18-250FIB-Q |             |            | 0.132           | 1.44                    | 0.35 | 0.22 | Female |                |                               |                |                |    |     |
| DNH14-250FIM-Q | 16 – 14 AWG | Blue       | 0.158           | 1.50                    | 0.41 | 0.31 | Male   |                |                               |                |                |    |     |
| DNH14-250FIB-Q |             |            | 0.156           | 1.44                    | 0.35 | 0.22 | Female |                |                               |                |                |    |     |
| DNH10-250FI-E  | 12 – 10 AWG | Yellow     | 0.230           | 1.44                    | 0.35 | 0.27 | Female |                |                               |                |                | 20 | 100 |

For crimping tool information, see page D1.85.



## Female Disconnect, Nylon Barrel Insulated – Funnel Entry

### Type DNF

- Disconnect can be inserted and removed from the male tab without the use of tools for lower installed cost
- Metal insulation grip sleeve crimps to wire insulation, providing protection to the crimp joint during high vibration applications
- Internal barrel serrations assure good wire contact and maximum tensile strength
- Internal wire stop assures proper length of insertion into terminal barrel, providing a higher quality connection
- UL Flammability UL 94V-2/HB, maximum insulation temperature 194°F (90°C)
- UL and CSA rated up to 300 V per UL 310

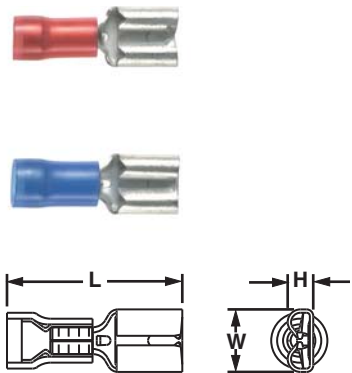

| Part Number  | Wire Range  | Color Code | Max. Ins. (In.) | Figure Dimensions (In.) |       |      | Tab Size (In.)      | Recommended Installation Tool        | Std. Pkg. Qty.** | Std. Ctn. Qty.                       |     |     |
|--------------|-------------|------------|-----------------|-------------------------|-------|------|---------------------|--------------------------------------|------------------|--------------------------------------|-----|-----|
|              |             |            |                 | L                       | W     | H    |                     |                                      |                  |                                      |     |     |
| DNF18-110-C  | 22 – 18 AWG | Red        | 0.100           | 0.69                    | 0.15  | 0.08 | 0.110 x 0.032       | CT-600-A‡, CT-1525‡, CT-2500‡        | 100              | 500                                  |     |     |
| DNF18-111-C  |             |            | 0.100           | 0.69                    | 0.15  | 0.07 | 0.110 x 0.020       |                                      |                  |                                      |     |     |
| DNF18-187-C  |             |            | 0.137           | 0.76                    | 0.23  | 0.10 | 0.187 x 0.032       |                                      |                  |                                      |     |     |
| DNF18-188-C  |             |            | 0.137           | 0.76                    | 0.23  | 0.10 | 0.187 x 0.020       | CT-600-A‡, CT-1550, CT-1551, CT-2500 | 100              | 500                                  |     |     |
| DNF18-205-C  |             |            | 0.137           | 0.76                    | 0.25  | 0.12 | 0.205/0.187 x 0.032 |                                      |                  |                                      |     |     |
| DNF18-206-C  |             |            | 0.137           | 0.76                    | 0.25  | 0.12 | 0.205/0.187 x 0.020 |                                      |                  |                                      |     |     |
| DNF18-250-C  |             |            | 0.138           | 0.81                    | 0.29  | 0.12 | 0.250 x 0.032       |                                      |                  |                                      |     |     |
| DNF14-110-C* |             |            | 16 – 14 AWG     | Blue                    | 0.162 | 0.75 | 0.15                | 0.08                                 | 0.110 x 0.032    | CT-1525, CT-2500                     | 100 | 500 |
| DNF14-111-C* |             |            |                 |                         | 0.162 | 0.75 | 0.15                | 0.07                                 | 0.110 x 0.020    |                                      |     |     |
| DNF14-187-C  |             |            |                 |                         | 0.162 | 0.76 | 0.23                | 0.10                                 | 0.187 x 0.032    | CT-600-A‡, CT-1550, CT-1551, CT-2500 | 100 | 500 |
| DNF14-188-C  | 0.162       | 0.76       |                 |                         | 0.23  | 0.10 | 0.187 x 0.020       |                                      |                  |                                      |     |     |
| DNF14-205-C  | 0.162       | 0.76       |                 |                         | 0.25  | 0.12 | 0.205/0.187 x 0.032 |                                      |                  |                                      |     |     |
| DNF14-206-C  | 0.162       | 0.76       |                 |                         | 0.25  | 0.12 | 0.205/0.187 x 0.020 |                                      |                  |                                      |     |     |
| DNF14-250-C  | 0.162       | 0.83       |                 |                         | 0.29  | 0.12 | 0.250 x 0.032       |                                      |                  |                                      |     |     |

\*Not UL Listed or CSA Certified.

\*\*Bulk packaging may be available, contact Panduit Customer Service for additional information.

‡UL and CSA approved tooling/product combinations. For crimping tool information, see pages D1.84, D1.86, and D1.88.

A. System Overview

B1. Cable Ties

B2. Cable Accessories

B3. Stainless Steel Ties

C1. Wiring Duct

C2. Surface Raceway

C3. Abrasion Protection

C4. Cable Management

D1. Terminals

D2. Power Connectors

D3. Grounding Connectors

E1. Labeling Systems

E2. Labels

E3. Pre-Printed & Write-On Markers

E4. Permanent Identification

E5. Lockout/Tagout & Safety Solutions

F. Index



A. System Overview

B1. Cable Ties

B2. Cable Accessories

B3. Stainless Steel Ties

C1. Wiring Duct

C2. Surface Raceway

C3. Abrasion Protection

C4. Cable Management

D1. Terminals

D2. Power Connectors

D3. Grounding Connectors

E1. Labeling Systems

E2. Labels

E3. Pre-Printed & Write-On Markers

E4. Permanent Identification

E5. Lockout/Tagout & Safety Solutions

F. Index



## Female Disconnect, Vinyl Barrel Insulated – Funnel Entry

### Type DVF

- Disconnect can be inserted and removed from the male tab without the use of tools for lower installed cost
- Metal insulation grip sleeve crimps to wire insulation, providing protection to the crimp joint during high vibration applications
- Internal barrel serrations assure good wire contact and maximum tensile strength

- Internal wire stop assures proper length of insertion into terminal barrel, providing a higher quality connection
- UL Flammability UL 94V-0, maximum insulation temperature 194°F (90°C)
- UL and CSA rated up to 300 V per UL 310

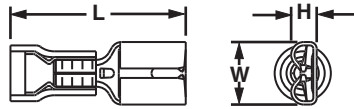

| Part Number         | Wire Range | Color Code | Max. Ins. (In.) | Figure Dimensions (In.) |      |      | Tab Size (In.)      | Recommended Installation Tool | Std. Pkg. Qty.** | Std. Ctn. Qty. |
|---------------------|------------|------------|-----------------|-------------------------|------|------|---------------------|-------------------------------|------------------|----------------|
|                     |            |            |                 | L                       | W    | H    |                     |                               |                  |                |
| <b>DVF18-187-CY</b> | 22–18 AWG  | Red        | 0.137           | 0.76                    | 0.23 | 0.10 | 0.187 x 0.032       | CT-1550‡, CT-1551‡, CT-2500‡  | 100              | 500            |
| <b>DVF18-188-CY</b> |            |            | 0.137           | 0.76                    | 0.23 | 0.10 | 0.187 x 0.020       |                               | 100              | 500            |
| <b>DVF18-205-CY</b> |            |            | 0.137           | 0.76                    | 0.25 | 0.12 | 0.205/0.187 x 0.032 |                               | 100              | 500            |
| <b>DVF18-206-CY</b> |            |            | 0.137           | 0.76                    | 0.25 | 0.12 | 0.205/0.187 x 0.020 |                               | 100              | 500            |
| <b>DVF18-250-CY</b> |            |            | 0.137           | 0.81                    | 0.29 | 0.12 | 0.250 x 0.032       |                               | 100              | 500            |
| <b>DVF14-187-C</b>  | 16–14 AWG  | Blue       | 0.162           | 0.76                    | 0.23 | 0.10 | 0.187 x 0.032       | CT-1550‡, CT-1551‡, CT-2500‡  | 100              | 500            |
| <b>DVF14-188-C</b>  |            |            | 0.162           | 0.76                    | 0.23 | 0.10 | 0.187 x 0.020       |                               | 100              | 500            |
| <b>DVF14-205-C</b>  |            |            | 0.162           | 0.76                    | 0.25 | 0.12 | 0.205/0.187 x 0.032 |                               | 100              | 500            |
| <b>DVF14-206-C</b>  |            |            | 0.162           | 0.76                    | 0.25 | 0.12 | 0.205/0.187 x 0.020 |                               | 100              | 500            |
| <b>DVF14-250-C</b>  |            |            | 0.162           | 0.81                    | 0.29 | 0.12 | 0.250 x 0.032       |                               | 100              | 500            |

\*\*Bulk packaging may be available, contact Panduit Customer Service for additional information.

‡UL and CSA approved tooling/product combinations. For crimping tool information, see pages D1.84 and D1.88.



## Female Disconnect, Vinyl Barrel Insulated – Butted Seam

### Type DV-B

- Disconnect can be inserted and removed from the male tab without the use of tools for lower installed cost
- Internal barrel serrations assure good wire contact and maximum tensile strength

- Internal wire stop assures proper length of insertion into terminal barrel, providing a higher quality connection
- UL Flammability UL 94V-0, maximum insulation temperature 221°F (105°C)
- UL and CSA rated up to 600 V per UL 310

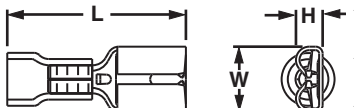

| Part Number         | Wire Range | Color Code | Max. Ins. (In.) | Figure Dimensions (In.) |      |      | Tab Size (In.)      | Recommended Installation Tool         | Std. Pkg. Qty.** | Std. Ctn. Qty. |
|---------------------|------------|------------|-----------------|-------------------------|------|------|---------------------|---------------------------------------|------------------|----------------|
|                     |            |            |                 | L                       | W    | H    |                     |                                       |                  |                |
| <b>DV18-187B-CY</b> | 22–18 AWG  | Red        | 0.150           | 0.75                    | 0.23 | 0.10 | 0.187 x 0.032       | CT-1525‡, CT-2500‡                    | 100              | 500            |
| <b>DV18-188B-CY</b> |            |            | 0.150           | 0.76                    | 0.23 | 0.10 | 0.187 x 0.020       |                                       | 100              | 500            |
| <b>DV18-205B-CY</b> |            |            | 0.150           | 0.75                    | 0.25 | 0.12 | 0.187/0.205 x 0.032 |                                       | 100              | 500            |
| <b>DV18-206B-CY</b> |            |            | 0.150           | 0.75                    | 0.25 | 0.12 | 0.187/0.205 x 0.020 |                                       | 100              | 500            |
| <b>DV18-250B-CY</b> | 16–14 AWG  | Blue       | 0.150           | 0.81                    | 0.29 | 0.12 | 0.250 x 0.032       | CT-1525^, CT-2500                     | 100              | 500            |
| <b>DV14-187B-C</b>  |            |            | 0.170           | 0.75                    | 0.23 | 0.10 | 0.187 x 0.032       |                                       | 100              | 500            |
| <b>DV14-188B-C</b>  |            |            | 0.162           | 0.79                    | 0.23 | 0.10 | 0.187 x 0.020       |                                       | 100              | 500            |
| <b>DV14-205B-C</b>  |            |            | 0.170           | 0.75                    | 0.25 | 0.12 | 0.187/0.205 x 0.032 |                                       | 100              | 500            |
| <b>DV14-206B-C</b>  |            |            | 0.170           | 0.75                    | 0.25 | 0.12 | 0.187/0.205 x 0.020 |                                       | 100              | 500            |
| <b>DV14-250B-C</b>  | 12–10 AWG  | Yellow     | 0.170           | 0.81                    | 0.29 | 0.12 | 0.250 x 0.032       | CT-600-A, CT-1550^, CT-1551^, CT-2500 | 100              | 500            |
| <b>DV10-250-L*</b>  |            |            | 0.229           | 1.03                    | 0.30 | 0.13 | 0.250 x 0.032       |                                       | 50               | 500            |

\*Sleeved barrel, maximum insulation temperature 194°F (90°C).

\*\*Bulk packaging may be available, contact Panduit Customer Service for additional information.

‡UL and CSA approved tooling/product combinations. For crimping tool information, see pages D1.84 and D1.88.

^CSA approved tooling/product combinations.

\*UL Recognized only.





## Female Disconnect, Non-Insulated – Metal Sleeve

### Type D

- Disconnect can be inserted and removed from the male tab without the use of tools for lower installed cost
- Sleeved barrel helps to facilitate high mechanical and electrical performance when crimping
- Barrel of terminal internally beveled to provide quick and easy wire insertion
- Internal barrel serrations assure good wire contact and maximum tensile strength
- Internal wire stop assures proper length of insertion into terminal barrel, providing a higher quality connection
- Maximum recommended operating temperature 302°F (150°C)
- UL and CSA rated up to 2000 V per UL 310

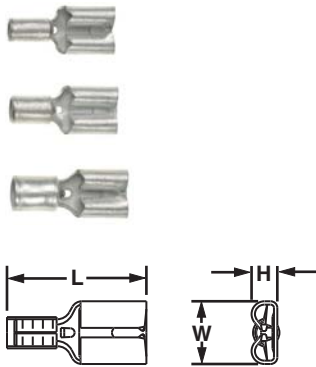

| Part Number        | Wire Range  | Figure Dimensions (In.) |      |      | Tab Size (In.) | Recommended Installation Tool               | Std. Pkg. Qty.** | Std. Ctn. Qty. |
|--------------------|-------------|-------------------------|------|------|----------------|---|------------------|----------------|
|                    |             | L                       | W    | H    |                |   |                  |                |
| <b>D18-187-C</b>   | 22 – 18 AWG | 0.58                    | 0.23 | 0.10 | 0.187 x 0.032  | CT-100A‡, CT-200‡, CT-1570‡, CT-2500‡       | 100              | 500            |
| <b>D18-188-C</b>   |             | 0.58                    | 0.23 | 0.10 | 0.187 x 0.020  |   | 100              | 500            |
| <b>D18-250-C</b>   |             | 0.66                    | 0.30 | 0.12 | 0.250 x 0.032  |   | 100              | 500            |
| ▲ <b>D14-187-C</b> | 16 – 14 AWG | 0.58                    | 0.23 | 0.10 | 0.187 x 0.032  | CT-100A, CT-200, CT-600-A, CT-1570, CT-2500 | 100              | 500            |
| ▲ <b>D14-188-C</b> |             | 0.58                    | 0.23 | 0.10 | 0.187 x 0.020  |   | 100              | 500            |
| ▲ <b>D14-250-C</b> |             | 0.66                    | 0.30 | 0.12 | 0.250 x 0.032  |   | 100              | 500            |
| <b>D10-250-L</b>   | 12 – 10 AWG | 0.72                    | 0.30 | 0.12 | 0.250 x 0.032  | CT-600-A‡, CT-1570‡, CT-1701‡, CT-2500‡     | 50               | 500            |

\*\*Bulk packaging may be available, contact Panduit Customer Service for additional information.  
 ‡UL and CSA approved tooling/product combinations. For crimping tool information, see pages D1.83, D1.84, D1.86 and D1.88.  
 \*UL Recognized only.



## Right Angle Female Disconnect, Nylon Fully Insulated – Funnel Entry

### Type DNFR-FIB

- Right angle design for use in limited space applications
- Fully insulated design provides protection from electrical shorts
- Internal wire stop assures proper length of insertion into terminal barrel, providing a higher quality connection
- Disconnect can be inserted and removed from the male tab without the use of tools for lower installed cost
- UL Flammability UL 94V-2/HB, maximum insulation temperature 221°F (105°C)
- UL and CSA rated up to 600 V per UL 310

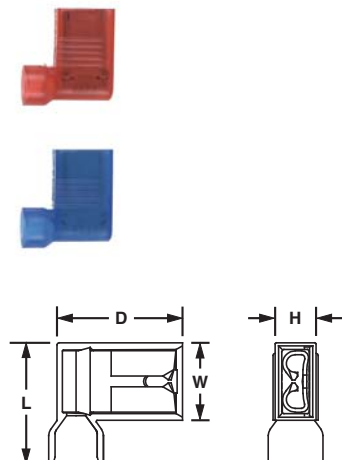

| Part Number            | Wire Range  | Color Code | Max. Ins. (In.) | Figure Dimensions (In.) |      |      |      | Tab Size (In.)      | Recommended Installation Tool | Std. Pkg. Qty.**    | Std. Ctn. Qty. |     |
|------------------------|-------------|------------|-----------------|-------------------------|------|------|------|---------------------|-------------------------------|---------------------|----------------|-----|
|                        |             |            |                 | L                       | W    | H    | D    |                     |                               |                     |                |     |
| <b>DNFR18-205FIB-L</b> | 22 – 18 AWG | Red        | 0.178           | 0.58                    | 0.37 | 0.21 | 0.60 | 0.205/0.187 x 0.032 | CT-300-1                      | 50                  | 250            |     |
| <b>DNFR18-206FIB-L</b> |             |            |                 | 0.178                   | 0.58 | 0.37 | 0.21 | 0.60                |                               | 0.205/0.187 x 0.020 | 50             | 250 |
| <b>DNFR18-250FIB-L</b> |             |            |                 | 0.178                   | 0.58 | 0.37 | 0.21 | 0.60                |                               | 0.250 x 0.032       | 50             | 250 |
| <b>DNFR14-205FIB-L</b> | 16 – 14 AWG | Blue       | 0.178           | 0.58                    | 0.37 | 0.21 | 0.60 | 0.205/0.187 x 0.032 | CT-300-1                      | 50                  | 250            |     |
| <b>DNFR14-206FIB-L</b> |             |            |                 | 0.178                   | 0.58 | 0.37 | 0.21 | 0.60                |                               | 0.205/0.187 x 0.020 | 50             | 250 |
| <b>DNFR14-250FIB-L</b> |             |            |                 | 0.178                   | 0.58 | 0.37 | 0.21 | 0.60                |                               | 0.250 x 0.032       | 50             | 250 |

\*\*Bulk packaging may be available, contact Panduit Customer Service for additional information.  
 For crimping tool information, see page D1.85.

A. System Overview

B1. Cable Ties

B2. Cable Accessories

B3. Stainless Steel Ties

C1. Wiring Duct

C2. Surface Raceway

C3. Abrasion Protection

C4. Cable Management

D1. Terminals

D2. Power Connectors

D3. Grounding Connectors

E1. Labeling Systems

E2. Labels

E3. Pre-Printed & Write-On Markers

E4. Permanent Identification

E5. Lockout/Tagout & Safety Solutions

F. Index

A. System Overview

B1. Cable Ties

B2. Cable Accessories

B3. Stainless Steel Ties

C1. Wiring Duct

C2. Surface Raceway

C3. Abrasion Protection

C4. Cable Management

D1. Terminals

D2. Power Connectors

D3. Grounding Connectors

E1. Labeling Systems

E2. Labels

E3. Pre-Printed & Write-On Markers

E4. Permanent Identification

E5. Lockout/Tagout & Safety Solutions

F. Index



## Right Angle Female Disconnect, Nylon Insulated – Funnel Entry

### Type DNFR-B

- Right angle design for use in limited space applications
- Disconnect can be inserted and removed from the male tab without the use of tools for lower installed cost
- Longer barrel design for use with Panduit standard disconnect tool
- UL Flammability UL 94V-2/HB, maximum insulation temperature 221°F (105°C)
- UL and CSA rated up to 600 V per UL 310

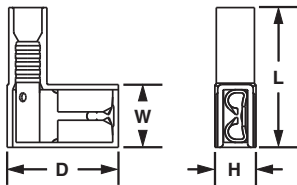

| Part Number   | Wire Range  | Color Code | Max. Ins. (In.) | Figure Dimensions (In.) |      |      |      | Tab Size (In.)      | Recommended Installation Tool | Std. Pkg. Qty. | Std. Ctn. Qty. |
|---------------|-------------|------------|-----------------|-------------------------|------|------|------|---------------------|-------------------------------|----------------|----------------|
|               |             |            |                 | L                       | W    | H    | D    |                     |                               |                |                |
| DNFR18-205B-L | 22 – 18 AWG | Red        | 0.130           | 0.78                    | 0.36 | 0.20 | 0.62 | 0.205/0.187 x 0.032 | CT-1525‡, CT-2500‡            | 50             | 500            |
| DNFR18-206B-L |             |            | 0.130           | 0.78                    | 0.36 | 0.20 | 0.62 | 0.205/0.187 x 0.020 |                               | 50             | 500            |
| DNFR18-250B-L |             |            | 0.130           | 0.78                    | 0.36 | 0.20 | 0.62 | 0.250 x 0.032       |                               | 50             | 500            |
| DNFR14-205B-L | 16 – 14 AWG | Blue       | 0.155           | 0.78                    | 0.36 | 0.20 | 0.63 | 0.205/0.187 x 0.032 | CT-1525‡, CT-2500‡            | 50             | 500            |
| DNFR14-206B-L |             |            | 0.155           | 0.78                    | 0.36 | 0.20 | 0.63 | 0.205/0.187 x 0.020 |                               | 50             | 500            |
| DNFR14-250B-L |             |            | 0.155           | 0.78                    | 0.36 | 0.20 | 0.63 | 0.250 x 0.032       |                               | 50             | 500            |

\*\*Bulk packaging may be available, contact Panduit Customer Service for additional information.

‡UL and CSA approved tooling/product combinations. For crimping tool information, see pages D1.84 and D1.88.



## Right Angle Female Disconnect, Non-Insulated – Metal Sleeve

### Type DR

- Right angle design for use in limited space applications
- Disconnect can be inserted and removed from the male tab without the use of tools for lower installed cost
- Sleeved barrel helps to facilitate high mechanical and electrical performance when crimping
- Barrel of terminal internally beveled to provide quick and easy wire insertion
- Internal barrel serrations assure good wire contact and maximum tensile strength
- Maximum recommended operating temperature 302°F (150°C)
- UL and CSA rated up to 2000 V per UL 310

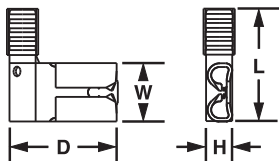

| Part Number       | Wire Range  | Figure Dimensions (In.) |      |      |      | Tab Size (In.)      | Recommended Installation Tool                              | Std. Pkg. Qty. | Std. Ctn. Qty. |
|-------------------|-------------|-------------------------|------|------|------|---------------------|--|----------------|----------------|
|                   |             | L                       | W    | H    | D    |                     |  |                |                |
| DR18-205-C        | 22 – 18 AWG | 0.54                    | 0.25 | 0.12 | 0.53 | 0.205/0.187 x 0.032 | CT-100A‡, CT-200‡, CT-600-A‡, CT-1570‡, CT-2500‡           | 100            | 1000           |
| DR18-206-C        |             | 0.54                    | 0.25 | 0.12 | 0.53 | 0.205/0.187 x 0.020 |  | 100            | 1000           |
| DR18-250-C        |             | 0.57                    | 0.30 | 0.12 | 0.54 | 0.250 x 0.032       |  | 100            | 1000           |
| DR14-205-C        | 16 – 14 AWG | 0.54                    | 0.25 | 0.12 | 0.55 | 0.205/0.187 x 0.032 | CT-100A‡, CT-200‡, CT-600-A‡, CT-1570‡, CT-2500‡           | 100            | 1000           |
| DR14-206-C        |             | 0.54                    | 0.25 | 0.12 | 0.55 | 0.205/0.187 x 0.020 |  | 100            | 1000           |
| <b>DR14-250-C</b> |             | 0.57                    | 0.30 | 0.12 | 0.55 | 0.250 x 0.032       |  | 100            | 1000           |
| <b>DR10-250-L</b> | 12 – 10 AWG | 0.61                    | 0.30 | 0.12 | 0.57 | 0.250 x 0.032       | CT-100A‡, CT-200‡, CT-600-A‡, CT-1570‡, CT-1701‡, CT-2500‡ | 50             | 500            |

\*\*Bulk packaging may be available, contact Panduit Customer Service for additional information.

‡UL and CSA approved tooling/product combinations. For crimping tool information, see pages D1.83, D1.84, D1.86 and D1.88.

\*UL Recognized only.

## Right Angle Female Disconnect Non-Insulated

### Type DR-B

- Disconnect can be inserted and removed from the male tab without the use of tools for lower installed cost
- Barrel of terminal internally beveled to provide quick and easy wire insertion
- Internal barrel serrations assure good wire contact and maximum tensile strength
- For use in limited space applications
- Maximum recommended operating temperature 302°F (150°C)
- Rated up to 2000 V



| Part Number  | Wire Range  | Figure Dimensions (In.) |      |      |      | Tab Size (In.)      | Recommended Installation Tool | Std. Pkg. Qty.** | Std. Ctn. Qty. |
|--------------|-------------|-------------------------|------|------|------|---------------------|-------------------------------|------------------|----------------|
|              |             | L                       | W    | H    | D    |                     |                               |                  |                |
| DR18-205B-C  | 22 – 18 AWG | 0.54                    | 0.25 | 0.12 | 0.53 | 0.205/0.187 x 0.032 | CT-100A, CT-200               | 100              | 1000           |
| DR18-206B-C  |             | 0.54                    | 0.25 | 0.12 | 0.53 | 0.205/0.187 x 0.020 |                               | 100              | 1000           |
| DR18-250B-C  |             | 0.55                    | 0.30 | 0.12 | 0.53 | 0.250 x 0.032       |                               | 100              | 1000           |
| DR14-205B-C* | 16 – 14 AWG | 0.54                    | 0.25 | 0.12 | 0.55 | 0.205/0.187 x 0.032 | CT-100A, CT-200               | 100              | 1000           |
| DR14-206B-C* |             | 0.54                    | 0.25 | 0.12 | 0.55 | 0.205/0.187 x 0.020 |                               | 100              | 1000           |
| DR14-250B-C  |             | 0.55                    | 0.30 | 0.12 | 0.55 | 0.250 x 0.032       |                               | 100              | 1000           |

\*Not CSA Certified.

\*\*Bulk packaging may be available, contact Panduit Customer Service for additional information. For crimping tool information, see page D1.83.

## Piggyback Disconnect, Vinyl Insulated

### Type DV-P

- Disconnect can be inserted and removed from the male tab without the use of tools for lower installed cost
- Combination of female disconnect and male tab allows versatility in points of connection
- Multiple connection points allow additional circuits to be added to existing equipment without expensive rework
- Metal insulation grip sleeve crimps to wire insulation, providing protection to the crimp joint during high vibration applications
- UL Flammability UL 94V-2/HB, maximum insulation temperature 194°F (90°C)
- Rated up to 300 V



| Part Number  | Wire Range  | Color Code | Max. Ins. (In.) | Figure Dimensions (In.) |      | Tab Size (In.) | Recommended Installation Tool              | Std. Pkg. Qty.** | Std. Ctn. Qty. |
|--------------|-------------|------------|-----------------|-------------------------|------|----------------|--|------------------|----------------|
|              |             |            |                 | L                       | W    |                |  |                  |                |
| DV18-250P-LY | 22 – 18 AWG | Red        | 0.130           | 0.88                    | 0.29 | 0.250 x 0.032  | CT-100A, CT-260, CT-1550, CT-1551, CT-2500 | 50               | 250            |
| DV14-250P-L  | 16 – 14 AWG | Blue       | 0.160           | 0.88                    | 0.29 | 0.250 x 0.032  |  | 50               | 250            |

\*\*Bulk packaging may be available, contact Panduit Customer Service for additional information. For crimping tool information, see pages D1.83, D1.84, and D1.88.

## Disconnect Adapter, Non-Insulated

### Type D-A

- Couples two female disconnects to one male disconnect (all 0.250 x 0.032)
- Multiple connection points allow additional circuits to be added to existing equipment without expensive rework
- Disconnect can be inserted and removed from the male tab without the use of tools for lower installed cost
- Maximum recommended operating temperature 302°F (150°C)
- Rated up to 2000 V



| Part Number | Figure Dimensions (In.) |      | Tab Size (In.) | Std. Pkg. Qty.** | Std. Ctn. Qty. |
|-------------|-------------------------|------|----------------|------------------|----------------|
|             | L                       | W    |                |                  |                |
| D-250A-C    | 0.82                    | 0.57 | 0.250 x 0.032  | 100              | 1000           |

\*\*Bulk packaging may be available, contact Panduit Customer Service for additional information.

A. System Overview

B1. Cable Ties

B2. Cable Accessories

B3. Stainless Steel Ties

C1. Wiring Duct

C2. Surface Raceway

C3. Abrasion Protection

C4. Cable Management

D1. Terminals

D2. Power Connectors

D3. Grounding Connectors

E1. Labeling Systems

E2. Labels

E3. Pre-Printed & Write-On Markers

E4. Permanent Identification

E5. Lockout/Tagout & Safety Solutions

F. Index

A. System Overview

B1. Cable Ties

B2. Cable Accessories

B3. Stainless Steel Ties

C1. Wiring Duct

C2. Surface Raceway

C3. Abrasion Protection

C4. Cable Management

D1. Terminals

D2. Power Connectors

D3. Grounding Connectors

E1. Labeling Systems

E2. Labels

E3. Pre-Printed & Write-On Markers

E4. Permanent Identification

E5. Lockout/Tagout & Safety Solutions

F. Index



## Male Disconnect, Nylon Barrel Insulated – Funnel Entry

### Type DNF-M

- Male tab couples with (all 0.250 x 0.032) female disconnects
- Male tab can be inserted and removed from the female disconnect without the use of tools for lower installed cost
- Metal insulation grip sleeve crimps to wire insulation, providing protection to the crimp joint during high vibration applications
- Internal barrel serrations assure good wire contact and maximum tensile strength
- UL Flammability UL 94V-2/HB, maximum insulation temperature 221°F (105°C)
- Rated up to 600 V

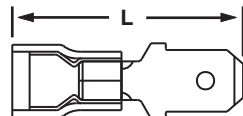

| Part Number          | Wire Range  | Color Code | Max. Ins. (In.) | Figure Dimensions (In.) |  | Tab Size (In.) | Recommended Installation Tool | Std. Pkg. Qty.** | Std. Ctn. Qty. |
|----------------------|-------------|------------|-----------------|-------------------------|--|----------------|-------------------------------|------------------|----------------|
|                      |             |            |                 | L                       |  |                |                               |                  |                |
| <b>DNF18-250M-C</b>  | 22 – 18 AWG | Red        | 0.136           | 0.90                    |  | 0.250 x 0.032  | CT-1550, CT-1551, CT-2500     | 100              | 1000           |
| <b>DNF14-250M-C</b>  | 16 – 14 AWG | Blue       | 0.162           | 0.90                    |  | 0.250 x 0.032  |                               | 100              | 1000           |
| <b>DNF10-250M-L*</b> | 12 – 10 AWG | Yellow     | 0.230           | 1.03                    |  | 0.250 x 0.032  |                               | 50               | 500            |

\*Not UL Listed or CSA Certified.

\*\*Bulk packaging may be available, contact Panduit Customer Service for additional information. For crimping tool information, see pages D1.84 and D1.88.



## Male Disconnect, Vinyl Barrel Insulated – Funnel Entry

### Type DV-MB

- Male tab couples with (all 0.250 x 0.032) female disconnects
- Insulation support helps to prevent wire damage in bending applications
- Male tab can be inserted and removed from the female disconnect without the use of tools for lower installed cost
- UL Flammability UL 94V-0, maximum insulation temperature 221°F (105°C)
- Rated up to 600 V

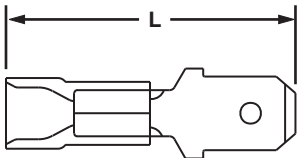

| Part Number          | Wire Range  | Color Code | Max. Ins. (In.) | Figure Dimensions (In.) |  | Tab Size (In.) | Recommended Installation Tool | Std. Pkg. Qty.** | Std. Ctn. Qty. |
|----------------------|-------------|------------|-----------------|-------------------------|--|----------------|-------------------------------|------------------|----------------|
|                      |             |            |                 | L                       |  |                |                               |                  |                |
| <b>DV18-250MB-CY</b> | 22 – 18 AWG | Red        | 0.154           | 0.98                    |  | 0.250 x 0.032  | CT-1550, CT-1551, CT-2500     | 100              | 500            |
| <b>DV14-250MB-C</b>  | 16 – 14 AWG | Blue       | 0.180           | 0.96                    |  | 0.250 x 0.032  |                               | 100              | 500            |
| <b>DV10-250M-L*</b>  | 12 – 10 AWG | Yellow     | 0.235           | 0.98                    |  | 0.250 x 0.032  |                               | 50               | 500            |

\*Not UL Listed or CSA Certified.

\*\*Bulk packaging may be available, contact Panduit Customer Service for additional information. For crimping tool information, see pages D1.84 and D1.88.

## Male Disconnect, Non-Insulated – Butted Seam

### Type D-MB

- Male tab couples with (all 0.250 x 0.032) female disconnects
- Male tab can be inserted and removed from the female disconnect without the use of tools for lower installed cost
- Internal barrel serrations assure good wire contact and maximum tensile strength
- Barrel of terminal internally beveled to provide quick and easy wire insertion
- Maximum recommended operating temperature 302°F (150°C)
- Rated up to 2000 V



| Part Number        | Wire Range  | Figure Dimensions (In.) | Tab Size (In.) | Recommended Installation Tool                         | Std. Pkg. Qty.** | Std. Ctn. Qty. |
|--------------------|-------------|-------------------------|----------------|---|------------------|----------------|
|                    |             | L                       |                |   |                  |                |
| <b>D18-250MB-C</b> | 22 – 18 AWG | 0.69                    | 0.250 x 0.032  | CT-100A   | 100              | 500            |
| <b>D14-250MB-C</b> | 16 – 14 AWG | 0.69                    | 0.250 x 0.032  |   | 100              | 500            |
| <b>D10-250M-L*</b> | 12 – 10 AWG | 0.72                    | 0.250 x 0.032  | CT-100A,<br>CT-200,<br>CT-260,<br>CT-1570,<br>CT-2500 | 50               | 500            |

\* Brazed seam.

\*\*To order in bulk, replace -C in the part number with -M for a bulk package of 1000 and replace -L with -D for a bulk package of 500.

For crimping tool information, see pages D1.83, D1.84, and D1.88.

A.  
System  
Overview

B1.  
Cable Ties

B2.  
Cable  
Accessories

B3.  
Stainless  
Steel Ties

C1.  
Wiring  
Duct

C2.  
Surface  
Raceway

C3.  
Abrasion  
Protection

C4.  
Cable  
Management

D1.  
Terminals

D2.  
Power  
Connectors

D3.  
Grounding  
Connectors

E1.  
Labeling  
Systems

E2.  
Labels

E3.  
Pre-Printed  
& Write-On  
Markers

E4.  
Permanent  
Identification

E5.  
Lockout/  
Tagout  
& Safety  
Solutions

F.  
Index

A. System Overview

## Selection Guide – Specialty Terminals

B1. Cable Ties

B2. Cable Accessories

B3. Stainless Steel Ties



| Material      | Style          | Feature            | Type | Page Number |
|---------------|----------------|--------------------|------|-------------|
| Vinyl         | Pin Terminal   | Insulation Support | PV-P | D1.54       |
|               | Blade Terminal | Insulation Support | DV-M | D1.55       |
| Non-Insulated | Pin Terminal   | Brazed Seam        | P-P  | D1.54       |
|               | Blade Terminal | Brazed Seam        | D-M  | D1.55       |

C1. Wiring Duct



### Pin Terminal, Vinyl Insulated – Funnel Entry

#### Type PV-P

C2. Surface Raceway

C3. Abrasion Protection

C4. Cable Management



D1. Terminals

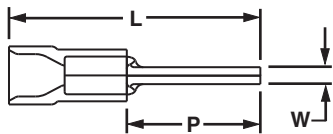

D2. Power Connectors

D3. Grounding Connectors



### Pin Terminal, Non-Insulated

#### Type P-P

E1. Labeling Systems

E2. Labels

E3. Pre-Printed & Write-On Markers

E4. Permanent Identification

E5. Lockout/Tagout & Safety Solutions

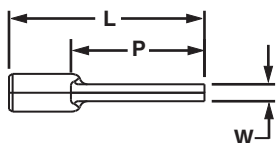

F. Index

- Solid pin designed to prevent damage to the wire from over tightening, resulting in a reliable electrical connection
- Insulation support helps to prevent wire damage in bending applications
- Brazed seam protects terminal barrel from splitting during the crimp process
- Internal barrel serrations assure good wire contact and maximum tensile strength
- For use with pin-type terminal blocks
- UL Flammability UL 94V-0, maximum insulation temperature 221°F (105°C)
- UL rated up to 600 V per UL 486A/B

| Part Number         | Wire Range  | Color Code | Max. Ins. (In.) | Figure Dimensions (In.) |      |      | Recommended Installation Tool              | Std. Pkg. Qty.** | Std. Ctn. Qty. |
|---------------------|-------------|------------|-----------------|-------------------------|------|------|--|------------------|----------------|
|                     |             |            |                 | L                       | W    | P    |  |                  |                |
| <b>PV18-P47-CY</b>  | 22 – 18 AWG | Red        | 0.150           | 0.97                    | 0.07 | 0.49 | CT-100A, CT-260, CT-1550, CT-1551, CT-2500 | 100              | 1000           |
| <b>PV14-P47-C</b>   | 16 – 14 AWG | Blue       | 0.170           | 0.97                    | 0.07 | 0.49 |  | 100              | 1000           |
| <b>PV10-P55-LY*</b> | 12 – 10 AWG | Yellow     | 0.250           | 1.10                    | 0.10 | 0.55 |  | 50               | 500            |

\*Not UL Listed.

\*\*Bulk packaging may be available, contact Panduit Customer Service for additional information. For crimping tool information, see pages D1.83, D1.84, and D1.88.

- Solid pin designed to prevent damage to the wire from over tightening, resulting in a reliable electrical connection
- Brazed seam protects terminal barrel from splitting during the crimp process
- Internal barrel serrations assure good wire contact and maximum tensile strength
- Barrel of terminal internally beveled to provide quick and easy wire insertion
- For use with pin-type terminal blocks
- Maximum recommended operating temperature 302°F (150°C)
- UL rated up to 600 V per UL 486A/B

| Part Number       | Wire Range  | Figure Dimensions (In.) |      |      | Recommended Installation Tool             | Std. Pkg. Qty.** | Std. Ctn. Qty. |
|-------------------|-------------|-------------------------|------|------|---|------------------|----------------|
|                   |             | L                       | W    | P    |   |                  |                |
| <b>P18-P47-C</b>  | 22 – 18 AWG | 0.75                    | 0.07 | 0.49 | CT-100A, CT-200, CT-260, CT-1570, CT-2500 | 100              | 1000           |
| <b>P14-P47-C</b>  | 16 – 14 AWG | 0.75                    | 0.07 | 0.49 |   | 100              | 1000           |
| <b>P10-P55-L*</b> | 12 – 10 AWG | 0.79                    | 0.11 | 0.55 |   | 50               | 500            |

\*Not UL Listed.

\*\*Bulk packaging may be available, contact Panduit Customer Service for additional information.

‡UL and CSA approved tooling/product combinations. For crimping tool information, see pages D1.83, D1.84, and D1.88.



## Male Blade Adapter, Vinyl Insulated – Funnel Entry

### Type DV-M

- Flat blade design to prevent damage to the wire from over tightening, resulting in a reliable electrical connection
- For use with blade-type terminal blocks
- Insulation support helps to prevent wire damage in bending applications
- Brazed seam protects terminal barrel from splitting during the crimp process
- UL Flammability UL 94V-0, maximum insulation temperature 221°F (105°C)
- Rated up to 600 V

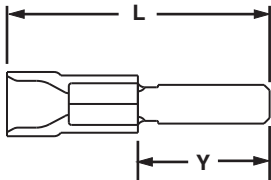

| Part Number         | Wire Range  | Color Code | Max. Ins. (In.) | Figure Dimensions (In.) |      | Tab Size (In.) | Recommended Installation Tool          | Std. Pkg. Qty.** | Std. Ctn. Qty. |
|---------------------|-------------|------------|-----------------|-------------------------|------|----------------|--|------------------|----------------|
|                     |             |            |                 | L                       | Y    |                |  |                  |                |
| <b>DV18-145M-CY</b> | 22 – 18 AWG | Red        | 0.150           | 0.97                    | 0.42 | 0.145 x 0.032  | CT-600-A, CT-1550‡, CT-1551‡, CT-2500‡ | 100              | 500            |
| <b>DV14-145M-C</b>  | 16 – 14 AWG | Blue       | 0.170           | 0.97                    | 0.42 | 0.145 x 0.032  |  | 100              | 500            |

\*\*Bulk packaging may be available, contact Panduit Customer Service for additional information.  
 ‡UL and CSA approved tooling/product combinations. For crimping tool information, see pages D1.84, D1.86, and D1.88.

## Male Blade Adapter, Non-Insulated

### Type D-M

- Flat blade design to prevent damage to the wire from over tightening, resulting in a reliable electrical connection
- For use with blade-type terminal blocks
- Internal barrel serrations assure good wire contact and maximum tensile strength
- Brazed seam protects terminal barrel from splitting during the crimp process
- Barrel of terminal internally beveled to provide quick and easy wire insertion
- Maximum recommended operating temperature 302°F (150°C)
- Rated up to 2000 V

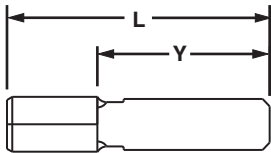

| Part Number       | Wire Range  | Figure Dimensions (In.) |      | Tab Size (In.) | Recommended Installation Tool                   | Std. Pkg. Qty.** | Std. Ctn. Qty. |
|-------------------|-------------|-------------------------|------|----------------|---|------------------|----------------|
|                   |             | L                       | Y    |                |   |                  |                |
| <b>D18-145M-C</b> | 22 – 18 AWG | 0.75                    | 0.42 | 0.145 x 0.032  | CT-100A‡, CT-200‡, CT-600-A, CT-1570‡, CT-2500‡ | 100              | 500            |
| <b>D14-145M-C</b> | 16 – 14 AWG | 0.75                    | 0.42 | 0.145 x 0.032  |   | 100              | 500            |

\*\*Bulk packaging may be available, contact Panduit Customer Service for additional information.  
 ‡UL and CSA approved tooling/product combinations. For crimping tool information, see pages D1.83, D1.84, D1.86 and D1.88.

A. System Overview

B1. Cable Ties

B2. Cable Accessories

B3. Stainless Steel Ties

C1. Wiring Duct

C2. Surface Raceway

C3. Abrasion Protection

C4. Cable Management

D1. Terminals

D2. Power Connectors

D3. Grounding Connectors

E1. Labeling Systems

E2. Labels

E3. Pre-Printed & Write-On Markers

E4. Permanent Identification

E5. Lockout/Tagout & Safety Solutions

F. Index

A. System Overview

## Features and Benefits – Pan-Term® Metric Disconnects

B1. Cable Ties

### Metric Nylon Fully Insulated Female and Male Tabs Type DMNF-FIB

Available in tab sizes to accommodate 2.8, 4.8, and 6.3mm tabs

Fully insulated design provides protection from electrical shorts

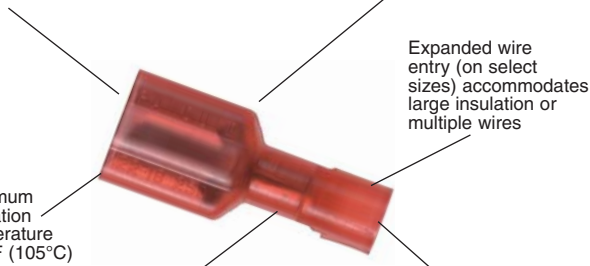

Expanded wire entry (on select sizes) accommodates large insulation or multiple wires

Maximum insulation temperature 221°F (105°C)

Insulation support restricts excessive wire movement to minimize stress on crimp joint

Funnel entry for faster wire insertion and lower installed cost

Rated at 600 V.  
Flammability UL 94V-2/HB.

B2. Cable Accessories

B3. Stainless Steel Ties

C1. Wiring Duct

C2. Surface Raceway

C3. Abrasion Protection

C4. Cable Management

### Nylon Barrel Insulated Female Receptacles and Male Tabs Type DMNF

Available in tab sizes to accommodate 2.8, 4.8, and 6.3mm tabs

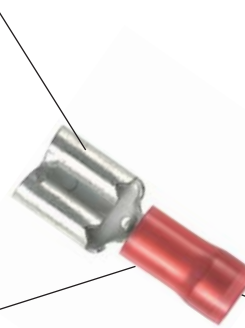

Maximum insulation temperature 221°F (105°C)

Funnel entry for faster wire insertion and lower installed cost

Rated at 600 V.  
Flammability UL 94V-2/HB.

D1. Terminals

D2. Power Connectors

D3. Grounding Connectors

E1. Labeling Systems

E2. Labels

E3. Pre-Printed & Write-On Markers

E4. Permanent Identification

E5. Lockout/Tagout & Safety Solutions

F. Index

### Vinyl Barrel Insulated Female Receptacles Type DMV

Available in tab sizes to accommodate 2.8, 4.8, and 6.3mm tabs

Maximum insulation temperature 221°F (105°C)



Insulation support to protect electrical crimp

Insulation grip sleeve provides a superior insulation crimp for high vibration and high strain relief applications

Rated at 600 V.  
Flammability UL 94V-0.

### Non-Insulated Female Receptacles and Male Tabs Type DM

Available in tab sizes to accommodate 2.8, 4.8, and 6.3mm tabs

Maximum recommended operating temperature 302°F (150°C)

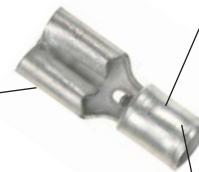

Sleeved barrel assures crimp reliability

Rated up to 2000 V.



Panduit extensive line of tooling is specifically designed for optimum crimping performance.

See pages D1.83 – D1.89.



Panduit designs and manufactures a full line of labeling products, software, and printers to assist you with your labeling requirements.

See pages E1.1 – E2.28.

## Part Number System for Pan-Term® Metric Disconnects

| <b>DM</b>              | <b>NF</b>  | <b>1</b>   | <b>—</b> | <b>285</b>  | <b>FIB</b>   | <b>—</b> | <b>C</b>  |
|------------------------|--|--|----------|---|--|----------|---|
| Type                   | Insulation   | Wire Range   |          | Size and Type   | Special Configuration  |          | Package Size                                    |
| DM = Disconnect Metric | N = Nylon<br>NF = Nylon Funnel<br>V = Vinyl<br>= Non-Insulated (leave blank) | 1 = 0.5 – 1.0mm <sup>2</sup> (22 – 18 AWG)<br>2 = 1.5 – 2.5mm <sup>2</sup> (16 – 14 AWG)<br>6 = 4.0 – 6.0mm <sup>2</sup> (12 – 10 AWG) |          | 285 = 2.8mm x 0.5mm (0.110 x 0.020)<br>288 = 2.8mm x 0.8mm (0.110 x 0.032)<br>488 = 4.8mm x 0.8mm (0.188 x 0.032)<br>63 = 6.3mm x 0.8mm (0.250 x 0.032) | B = Butted Seam, Female<br>FI = Fully Insulated, Female<br>FIB = Fully Insulated, Butted Seam, Female<br>FIM = Fully Insulated, Male<br>M = Male<br>MB = Butted Seam, Male<br>= Female (leave blank) |          | X = 10<br>E = 20<br>Q = 25<br>L = 50<br>C = 100 |

## Female Metric Disconnect, Fully Insulated Nylon – Funnel Entry

### Type DMNF-FIB

- Disconnect can be inserted and removed from the male tab without the use of tools for lower installed cost
- Fully insulated design provides protection from electrical shorts
- Internal wire stop assures proper length of insertion into terminal barrel, providing a higher quality connection
- Maximum insulation temperature 221°F (105°C)
- Rated up to 600 V



| Part Number    | Wire Range | Color Code | Max. Ins. (mm) | Figure Dimensions (mm) |     |     | Tab Size (mm) | Recommended Installation Tool | Std. Pkg. Qty.** | Std. Ctn. Qty. |
|----------------|------------|------------|----------------|------------------------|-----|-----|---------------|-------------------------------|------------------|----------------|
|                |            |            |                | L                      | W   | H   |               |                               |                  |                |
| DMNF1-285FIB-C | 0.5 – 1.0  | Red        | 3.05           | 18.0                   | 4.8 | 4.1 | 2.8 x 0.5     | CT-1525, CT-2500              | 100              | 500            |
| DMNF1-288FIB-C |            |            | 3.05           | 18.0                   | 4.8 | 4.1 | 2.8 x 0.8     |                               | 100              | 500            |
| DMNF1-488FIB-C |            |            | 3.35           | 19.8                   | 7.9 | 5.5 | 4.8 x 0.8     |                               | 100              | 1000           |
| DMNF1-63FIB-C  |            |            | 3.35           | 21.3                   | 8.9 | 5.5 | 6.3 x 0.8     |                               | 100              | 500            |
| DMNF2-488FIB-C | 1.5 – 2.5  | Blue       | 3.96           | 19.8                   | 7.9 | 5.5 | 4.8 x 0.8     | CT-1525, CT-2500              | 100              | 1000           |
| DMNF2-63FIB-C  |            |            | 3.96           | 21.3                   | 8.9 | 5.5 | 6.3 x 0.8     |                               | 100              | 500            |
| DMNF6-63FI-L   | 4.0 – 6.0  | Yellow     | 5.84           | 24.4                   | 8.9 | 6.9 | 6.3 x 0.8     | CT-1551                       | 50               | 250            |

\*\*Bulk packaging may be available, contact Panduit Customer Service for additional information. For crimping tool information, see pages D1.84 and D1.88.

A. System Overview

B1. Cable Ties

B2. Cable Accessories

B3. Stainless Steel Ties

C1. Wiring Duct

C2. Surface Raceway

C3. Abrasion Protection

C4. Cable Management

D1. Terminals

D2. Power Connectors

D3. Grounding Connectors

E1. Labeling Systems

E2. Labels

E3. Pre-Printed & Write-On Markers

E4. Permanent Identification

E5. Lockout/Tagout & Safety Solutions

F. Index

A. System Overview

## Female Metric Disconnect, Nylon Barrel Insulated – Funnel Entry

B1. Cable Ties

### Type DMNF

- Disconnect can be inserted and removed from the male tab without the use of tools for lower installed cost
- Metal insulation grip sleeve crimps to wire insulation, providing protection to the crimp joint during high vibration applications
- Internal barrel serrations assure good wire contact and maximum tensile strength
- Internal wire stop assures proper length of insertion into terminal barrel, providing a higher quality connection
- Maximum insulation temperature 221°F (105°C)
- Rated up to 300 V

B2. Cable Accessories

B3. Stainless Steel Ties



C1. Wiring Duct



C2. Surface Raceway

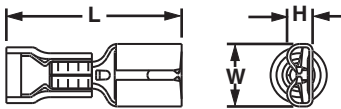

C3. Abrasion Protection

C4. Cable Management

D1. Terminals

D2. Power Connectors

D3. Grounding Connectors

| Part Number | Wire Range (mm <sup>2</sup> ) | Color Code | Max. Ins. (mm) | Figure Dimensions (mm) |     |     | Tab Size (mm) | Recommended Installation Tool | Std. Pkg. Qty. | Std. Ctn. Qty. |
|-------------|-------------------------------|------------|----------------|------------------------|-----|-----|---------------|-------------------------------|----------------|----------------|
|             |                               |            |                | L                      | W   | H   |               |                               |                |                |
| DMNF1-285-C | 0.5 – 1.0                     | Red        | 2.50           | 17.8                   | 3.8 | 2.0 | 2.8 x 0.5     | CT-1551                       | 100            | 500            |
| DMNF1-288-C |                               |            | 2.50           | 17.6                   | 3.8 | 2.0 | 2.8 x 0.8     |                               | 100            | 500            |
| DMNF1-488-C |                               |            | 3.60           | 19.6                   | 5.8 | 2.5 | 4.8 x 0.8     |                               | 100            | 500            |
| DMNF1-63-C  |                               | Red        | 3.58           | 20.7                   | 7.4 | 3.1 | 6.3 x 0.8     |                               | 100            | 500            |
| DMNF2-288-C | 1.5 – 2.5                     | Blue       | 4.20           | 18.8                   | 3.8 | 2.0 | 2.8 x 0.8     |                               | 100            | 500            |
| DMNF2-488-C |                               |            | 4.20           | 19.6                   | 5.8 | 2.5 | 4.8 x 0.8     |                               | 100            | 500            |
| DMNF2-63-C  |                               |            | 4.22           | 21.1                   | 7.4 | 3.1 | 6.3 x 0.8     | 100                           | 500            |                |

For crimping tool information, see page D1.84.

## Female Metric Disconnect, Vinyl Barrel Insulated – Funnel Entry

### Type DMV

- Disconnect can be inserted and removed from the male tab without the use of tools for lower installed cost
- Internal barrel serrations assure good wire contact and maximum tensile strength
- Internal wire stop assures proper length of insertion into terminal barrel, providing a higher quality connection
- Maximum insulation temperature 221°F (105°C)
- Rated up to 600 V

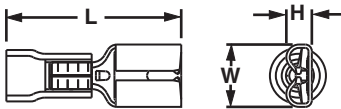

| Part Number | Wire Range (mm <sup>2</sup> ) | Color Code | Max. Ins. (mm) | Figure Dimensions (mm) |     |     | Tab Size (mm) | Recommended Installation Tool | Std. Pkg. Qty. | Std. Ctn. Qty. |
|-------------|-------------------------------|------------|----------------|------------------------|-----|-----|---------------|-------------------------------|----------------|----------------|
|             |                               |            |                | L                      | W   | H   |               |                               |                |                |
| DMV6-63-L   | 2.5 – 6.0                     | Yellow     | 5.80           | 25.7                   | 7.6 | 3.3 | 6.3 x 0.8     | CT-1551                       | 50             | 250            |

For crimping tool information, see page D1.84.

E1. Labeling Systems

## Female Metric Disconnect, Non-Insulated – Metal Sleeve

### Type DM

- Disconnect can be inserted and removed from the male tab without the use of tools for lower installed cost
- Sleeved barrel helps to facilitate high mechanical and electrical performance when crimping
- Barrel of terminal internally beveled to provide quick and easy wire insertion
- Internal barrel serrations assure good wire contact and maximum tensile strength
- Internal wire stop assures proper length of insertion into terminal barrel, providing a higher quality connection
- Maximum recommended operating temperature 302°F (150°C)
- Rated up to 2000 V

E2. Labels

E3. Pre-Printed & Write-On Markers

E4. Permanent Identification

E5. Lockout/Tagout & Safety Solutions

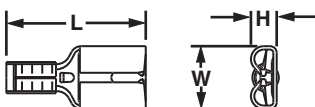

| Part Number | Wire Range (mm <sup>2</sup> ) | Figure Dimensions (mm) |     |     | Tab Size (mm) | Recommended Installation Tool | Std. Pkg. Qty. | Std. Ctn. Qty. |
|-------------|-------------------------------|------------------------|-----|-----|---------------|-------------------------------|----------------|----------------|
|             |                               | L                      | W   | H   |               |                               |                |                |
| DM1-488-C   | 0.5 – 1.0                     | 15.0                   | 5.9 | 2.5 | 4.8 x 0.8     | CT-1570, CT-2500              | 100            | 500            |
| DM1-63-C    |                               | 16.8                   | 7.6 | 3.0 | 6.3 x 0.8     |                               | 100            | 500            |
| DM2-488-C   | 1.5 – 2.5                     | 15.0                   | 5.9 | 2.5 | 4.8 x 0.8     |                               | 100            | 500            |
| DM2-63-C    |                               | 16.8                   | 7.6 | 3.0 | 6.3 x 0.8     |                               | 100            | 500            |
| DM6-63-L    | 4.0 – 6.0                     | 18.2                   | 7.6 | 3.0 | 6.3 x 0.8     |                               | 50             | 250            |

For crimping tool information, see pages D1.84 and D1.88.

## Piggyback Metric Disconnect, Vinyl Barrel Insulated

### Type DMV-P

- Combination of female disconnect and male tab allows versatility in points of connection
- Multiple connection points allow additional circuits to be added to existing equipment without expensive rework
- Metal insulation grip sleeve crimps to wire insulation, providing protection to the crimp joint during high vibration applications
- Maximum insulation temperature 194°F (90°C)
- Rated up to 600 V

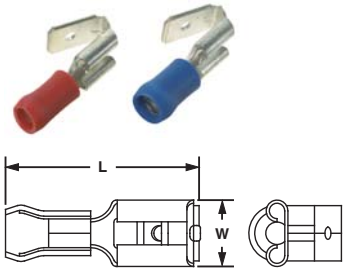

| Part Number | Wire Range (mm <sup>2</sup> ) | Color Code | Max. Ins. (mm) | Figure Dimensions (mm) |     | Tab Size (mm) | Recommended Installation Tool | Std. Pkg. Qty. | Std. Ctn. Qty. |
|-------------|-------------------------------|------------|----------------|------------------------|-----|---------------|-------------------------------|----------------|----------------|
|             |                               |            |                | L                      | W   |               |                               |                |                |
| DMV1-63P-LY | 0.5 – 1.0                     | Red        | 3.30           | 22.4                   | 7.4 | 6.3 x 0.8     | CT-1551                       | 50             | 500            |
| DMV2-63P-L  | 1.5 – 2.5                     | Blue       | 4.06           | 22.4                   | 7.4 | 6.3 x 0.8     |                               | 50             | 500            |

For crimping tool information, see page D1.84.

## Male Metric Disconnect, Fully Insulated Nylon – Funnel Entry

### Type DMNF-FIM

- Male tab couples with (all 6.3mm x 0.8mm) female disconnects
- Fully insulated design provides protection from electrical shorts
- Male tab can be inserted and removed from the female disconnect without the use of tools for lower installed cost
- Internal barrel serrations assure good wire contact and maximum tensile strength
- Maximum insulation temperature 221°F (105°C)
- Rated up to 600 V

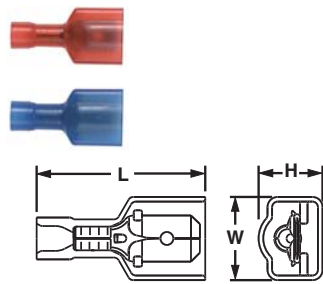

| Part Number   | Wire Range (mm <sup>2</sup> ) | Color Code | Max. Ins. (mm) | Figure Dimensions (mm) |      |      | Tab Size (mm) | Recommended Installation Tool | Std. Pkg. Qty. | Std. Ctn. Qty. |
|---------------|-------------------------------|------------|----------------|------------------------|------|------|---------------|-------------------------------|----------------|----------------|
|               |                               |            |                | L                      | W    | H    |               |                               |                |                |
| DMNF1-63FIM-L | 0.5 – 1.0                     | Red        | 3.38           | 22.9                   | 10.3 | 7.03 | 6.3 x 0.8     | CT-1525, CT-2500              | 50             | 500            |
| DMNF2-63FIM-L | 1.5 – 2.5                     | Blue       | 4.01           | 22.9                   | 10.4 | 7.05 | 6.3 x 0.8     |                               | 50             | 500            |

For crimping tool information, see pages D1.84 and D1.88.

## Male Metric Disconnect, Nylon Barrel Insulated – Funnel Entry

### Type DMNF-M

- Male tab couples with (all 6.3mm x 0.8mm) female disconnects
- Male tab can be inserted and removed from the female disconnect without the use of tools for lower installed cost
- Metal insulation grip sleeve crimps to wire insulation, providing protection to the crimp joint during high vibration applications
- Internal barrel serrations assure good wire contact and maximum tensile strength
- Maximum insulation temperature 221°F (105°C)
- Rated up to 600 V

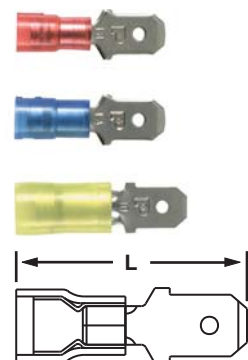

| Part Number | Wire Range (mm <sup>2</sup> ) | Color Code | Max. Ins. (mm) | Figure Dimensions (mm) | Tab Size (mm) | Recommended Installation Tool | Std. Pkg. Qty. | Std. Ctn. Qty. |
|-------------|-------------------------------|------------|----------------|------------------------|---------------|-------------------------------|----------------|----------------|
|             |                               |            |                | L                      |               |                               |                |                |
| DMNF1-63M-C | 0.5 – 1.0                     | Red        | 3.96           | 22.7                   | 6.3 x 0.8     | CT-1551                       | 100            | 500            |
| DMNF2-63M-C | 1.5 – 2.5                     | Blue       | 4.83           | 23.6                   | 6.3 x 0.8     |                               | 100            | 500            |
| DMNF6-63M-L | 4.0 – 6.0                     | Yellow     | 6.20           | 23.6                   | 6.3 x 0.8     |                               | 50             | 250            |

For crimping tool information, see page D1.84.

A. System Overview

B1. Cable Ties

B2. Cable Accessories

B3. Stainless Steel Ties

C1. Wiring Duct

C2. Surface Raceway

C3. Abrasion Protection

C4. Cable Management

D1. Terminals

D2. Power Connectors

D3. Grounding Connectors

E1. Labeling Systems

E2. Labels

E3. Pre-Printed & Write-On Markers

E4. Permanent Identification

E5. Lockout/Tagout & Safety Solutions

F. Index

A. System Overview

## Male Metric Disconnect, Non-Insulated – Butted Seam

B1. Cable Ties

### Type DM-M

- Male tab couples with (all 6.3mm x 0.8mm) female disconnects
- Male tab can be inserted and removed from the female disconnect without the use of tools for lower installed cost
- Internal barrel serrations assure good wire contact and maximum tensile strength
- Barrel of terminal internally beveled to provide quick and easy wire insertion
- Maximum recommended operating temperature 302°F (150°C)
- Rated up to 2000 V

B2. Cable Accessories

B3. Stainless Steel Ties



C1. Wiring Duct



C2. Surface Raceway

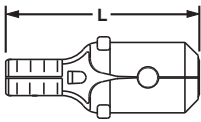

C3. Abrasion Protection

C4. Cable Management

D1. Terminals

D2. Power Connectors

D3. Grounding Connectors

## Metric Pin Terminal, Vinyl Insulated – Funnel Entry

### Type PMV-P

- Solid pin designed to prevent damage to the wire from over tightening, resulting in a reliable electrical connection
- For use with pin-type terminal blocks
- Insulation support helps to prevent wire damage in bending applications
- Brazed seam protects terminal barrel from splitting during the crimp process
- Internal barrel serrations assure good wire contact and maximum tensile strength
- Maximum insulation temperature 221°F (105°C)
- Rated up to 600 V

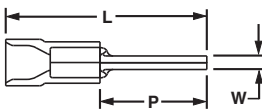

E1. Labeling Systems

E2. Labels

E3. Pre-Printed & Write-On Markers

E4. Permanent Identification

E5. Lockout/Tagout & Safety Solutions

F. Index

| Part Number | Wire Range (mm <sup>2</sup> ) | Figure Dimensions (mm) |     |     | Recommended Installation Tool | Std. Pkg. Qty. | Std. Ctn. Qty. |
|-------------|-------------------------------|------------------------|-----|-----|-------------------------------|----------------|----------------|
|             |                               | L                      | W   | P   |                               |                |                |
| DM1-63M-C   | 0.5 – 1.0                     | 19.2                   | 6.3 | 0.8 | CT-1570, CT-2500              | 100            | 500            |
| DM2-63M-C   | 1.5 – 2.5                     | 19.2                   | 6.3 | 0.8 |                               | 100            | 500            |
| DM6-63M-L*  | 4.0 – 6.0                     | 18.2                   | 6.3 | 0.8 |                               | 50             | 250            |

\*Brazed seam.  
For crimping tool information, see pages D1.84 and D1.88.

## Metric Pin Terminal, Non-Insulated

### Type PM-P

- Solid pin designed to prevent damage to the wire from over tightening, resulting in a reliable electrical connection
- For use with pin-type terminal blocks
- Insulation support helps to prevent wire damage in bending applications
- Brazed seam protects terminal barrel from splitting during the crimp process
- Internal barrel serrations assure good wire contact and maximum tensile strength
- Maximum recommended operating temperature 302°F (150°C)
- Rated up to 2000 V

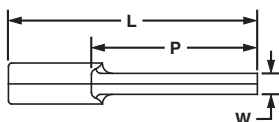

| Part Number | Wire Range (mm <sup>2</sup> ) | Figure Dimensions (mm) |     |      | Recommended Installation Tool | Std. Pkg. Qty. | Std. Ctn. Qty. |
|-------------|-------------------------------|------------------------|-----|------|-------------------------------|----------------|----------------|
|             |                               | L                      | W   | P    |                               |                |                |
| PM1-P10-C   | 0.5 – 1.0                     | 19.0                   | 1.8 | 12.4 | CT-1570, CT-2500              | 100            | 500            |
| PM2-P10-C   | 1.5 – 2.5                     | 19.0                   | 1.8 | 12.4 |                               | 100            | 500            |
| PM6-P10-L   | 4.0 – 6.0                     | 20.1                   | 2.8 | 14.0 |                               | 50             | 250            |

For crimping tool information, see pages D1.84 and D1.88.



## PAN-TERM® SPLICES

Panduit® Pan-Term® Splices are designed and manufactured for fast assembly, and long reliable performance. As the demand for splices increases, it becomes essential to provide a complete system for termination products. We provide an extensive line of tooling designed specifically to provide optimum performance when used as a system for terminating.



- Suitable for in-line, parallel, and group splicing of wires
- Nylon and vinyl insulated as well as non-insulated
- Available in sizes from #26 – 10 AWG
- Internal wire stops on butt splices prevent over insertion of wires
- Applicable sizes are UL Listed and CSA Certified, as noted
- Wide assortment of manual, controlled cycle, battery operated hydraulic and pneumatic crimping tools for reliable connections at the lowest installed cost

Panduit continually provides new designs to meet the application challenges encountered by our customers. Panduit offers a wide assortment of Pan-Term® termination products to meet customer needs at the lowest installed cost.

A.  
System  
Overview

B1.  
Cable Ties

B2.  
Cable  
Accessories

B3.  
Stainless  
Steel Ties

C1.  
Wiring  
Duct

C2.  
Surface  
Raceway

C3.  
Abrasion  
Protection

C4.  
Cable  
Management

D1.  
Terminals

D2.  
Power  
Connectors

D3.  
Grounding  
Connectors

E1.  
Labeling  
Systems

E2.  
Labels

E3.  
Pre-Printed  
& Write-On  
Markers

E4.  
Permanent  
Identification

E5.  
Lockout/  
Tagout  
& Safety  
Solutions

F.  
Index

A. System Overview

## Features and Benefits – Pan-Term® Splices and Wire Joints

B1. Cable Ties

B2. Cable Accessories

B3. Stainless Steel Ties

C1. Wiring Duct

C2. Surface Raceway

C3. Abrasion Protection

C4. Cable Management

D1. Terminals

D2. Power Connectors

D3. Grounding Connectors

E1. Labeling Systems

E2. Labels

E3. Pre-Printed & Write-On Markers

E4. Permanent Identification

E5. Lockout/Tagout & Safety Solutions

F. Index

### Non-Insulated Wire Joints Type J

Only one crimp needed to complete splice

Maximum recommended operating temperature 302°F (150°C)



Internally beveled barrel for quick easy wire insertion

UL and CSA rated up to 2000 V per UL 486C.

### Non-Insulated Parallel Splices Type PS

Seamless tubular barrel provides consistent high performance quality crimps

Maximum recommended operating temperature 302°F (150°C)



Only one crimp needed to complete splice

UL and CSA rated up to 2000 V per UL 486C.

### Nylon Wire Joints Type JN

Fully insulated housing protects crimp joint

Maximum insulation temperature 221°F (105°C)



Only one crimp needed to complete splice

Deep skirt to accommodate multiple variations of wire combinations

UL and CSA rated up to 600 V per UL 486C.  
Metric versions available.  
Flammability – UL 94V-2/HB.

### Nylon Parallel Splices Type PSN

Maximum insulation temperature 221°F (105°C)



Only one crimp needed to complete splice

Rated up to 300 V.  
Flammability – UL 94V-2/HB.



Panduit extensive line of tooling is specifically designed for optimum crimping performance.

See pages D1.83 – D1.89.



Panduit designs and manufactures a full line of labeling products, software, and printers to assist you with your labeling requirements.

See pages E1.1 – E2.28.

## Features and Benefits – Pan-Term® Splices

### Nylon Butt Splices Type BSN

Internal wire stops assure proper insertion length



Maximum insulation temperature 221°F (105°C)

Brazed seam assures crimp reliability

UL and CSA rated up to 600 V per UL 486C.  
Flammability – UL 94V-2/HB.

### Vinyl Butt Splices Type BSV

Internal wire stops assure proper insertion, length



Maximum insulation temperature 221°F (105°C)

Brazed seam assures crimp reliability

Expanded wire entry accommodates larger insulation

UL and CSA rated up to 600 V per UL 486C.  
Flammability – UL 94V-0.  
Metric versions available.

### Non-Insulated Butt Splices Type BS

Internal wire stops assure proper insertion length



Brazed seam assures crimp reliability

Maximum recommended operating temperature 302°F (150°C)

Internally beveled barrel for quick easy wire insertion

UL and CSA rated up to 2000 V per UL 486C.  
Metric versions available.

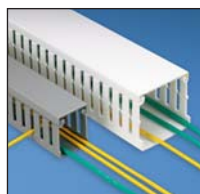

Panduit wiring duct offers a wide variety of sizes and types to meet the wire capacity needs and space constraints of the smallest wall mounted to the largest integrated systems.

See pages C1.1 – C1.52.



A comprehensive selection of cable ties used to bundle, mount, and identify wire and cable.

See pages B1.1 – B1.120.

A.  
System  
Overview

B1.  
Cable Ties

B2.  
Cable  
Accessories

B3.  
Stainless  
Steel Ties

C1.  
Wiring  
Duct

C2.  
Surface  
Raceway

C3.  
Abrasion  
Protection

C4.  
Cable  
Management

D1.  
Terminals

D2.  
Power  
Connectors

D3.  
Grounding  
Connectors

E1.  
Labeling  
Systems

E2.  
Labels

E3.  
Pre-Printed  
& Write-On  
Markers

E4.  
Permanent  
Identification

E5.  
Lockout/  
Tagout  
& Safety  
Solutions

F.  
Index

A. System Overview

## Selection Guide – Pan-Term® Splices and Wire Joints

B1. Cable Ties

B2. Cable Accessories

B3. Stainless Steel Ties

C1. Wiring Duct

C2. Surface Raceway

C3. Abrasion Protection

C4. Cable Management

D1. Terminals

D2. Power Connectors

D3. Grounding Connectors

E1. Labeling Systems

E2. Labels

E3. Pre-Printed & Write-On Markers

E4. Permanent Identification

E5. Lockout/Tagout & Safety Solutions

F. Index



**Splices and Wire Joints**

| Material      | Style           | Feature                 | Type | Page Number |
|---------------|-----------------|-------------------------|------|-------------|
| Nylon         | Butt Splice     | Brazed Seam             | BSN  | D1.65       |
|               | Parallel Splice | Seamless Barrel         | PSN  | D1.66       |
|               | Wire Joint      | Multiple Wire Connector | JN   | D1.67       |
| Vinyl         | Butt Splice     | Expanded Insulation     | BSV  | D1.65       |
| Heat Shrink   | Butt Splice     | Heat Shrink Insulation  | BSH  | D1.68       |
| Non-Insulated | Butt Splice     | Brazed Seam             | BS   | D1.66       |
|               | Parallel Splice | Seamless Barrel         | PS   | D1.67       |
|               | Wire Joint      |                         | J    | D1.68       |

## Part Number System for Pan-Term® Splices

|  |  |   |                              |   |   |
|--|--|---|------------------------------|---|---|
| <b>BS</b>                                | <b>V</b>   | <b>14</b>   | <b>X</b>                     | — | <b>M</b>  |
|  |  |   |                              |   |   |
| <b>Type</b>                              | <b>Insulation</b>  | <b>Wire Range</b>   | <b>Special Configuration</b> |   | <b>Standard Package Size</b>  |
| BS = Butt Splice<br>PS = Parallel Splice | H = Heat Shrink<br>N = Nylon<br>V = Vinyl<br>= Non-Insulated (leave blank) | 22 = #26 – 22<br>18 = #22 – 18<br>14 = #16 – 14<br>13 = #14 – 12<br>10 = #12 – 10 | X = Expanded Insulation      |   | X = 10<br>Q = 25<br>L = 50<br>C = 100<br>T = 200<br>D = 500<br>M = 1000 |

## Part Number System for Pan-Term® Wire Joints

|   |  |   |   |
|---|--|---|---|
| <b>JN</b>                                 | <b>418-212</b>   | — | <b>C</b>  |
|   |  |   |   |
| <b>Type</b>                               | <b>Wire Range</b>  |   | <b>Standard Package Size</b>  |
| J = Non-Insulated<br>JN = Nylon-Insulated | <b>J Types</b><br>214 – 312 = (2) #14 – (3) #12<br>318 – 412 = (3) #14 – (4) #12<br>216 – 410 = (2) #16 – (4) #10<br><br><b>JN Types</b><br>224 – 318 = (2) #24 – (3) #18<br>218 – 216 = (2) #18 – (2) #16<br>418 – 212 = (4) #18 – (2) #12<br>314 – 412 = (3) #14 – (4) #12 |   | X = 10<br>Q = 25<br>L = 50<br>C = 100<br>T = 200<br>D = 500<br>M = 1000 |



## Butt Splice, Nylon Insulated

### Type BSN

- Designed to splice two solid or stranded wires together to repair or lengthen wires
- Butted configuration provides low profile for limited space applications
- Brazed seam protects terminal barrel from splitting during the crimp process
- Internal wire stop assures proper length of insertion into terminal barrel
- UL Flammability UL 94V-2/HB, maximum insulation temperature 221°F (105°C)
- UL and CSA rated up to 600 V per UL 486C

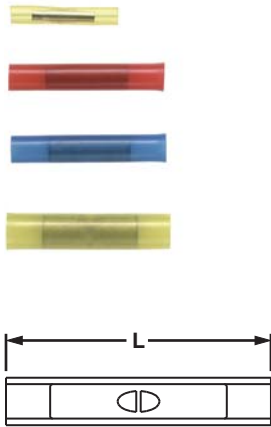

| Part Number     | Wire Range  | Color Code | Max. Ins. (In.) | Figure Dimensions (In.) | Recommended Installation Tool                | Std. Pkg. Qty.** | Std. Ctn. Qty. |
|-----------------|-------------|------------|-----------------|-------------------------|--|------------------|----------------|
|                 |             |            |                 | L                       |  |                  |                |
| <b>BSN22-C*</b> | 26 – 22 AWG | Yellow     | 0.080           | 0.79                    | CT-1525, CT-2500                             | 100              | 1000           |
| <b>BSN18-C</b>  | 22 – 18 AWG | Red        | 0.115           | 1.15                    | CT-100A, CT-600-A, CT-1550, CT-1551, CT-2500 | 100              | 1000           |
| <b>BSN14-C</b>  | 16 – 14 AWG | Blue       | 0.148           | 1.15                    | CT-100A, CT-600-A, CT-1550, CT-1551, CT-2500 | 100              | 1000           |
| <b>BSN10-L</b>  | 12 – 10 AWG | Yellow     | 0.210           | 1.14                    | CT-100A, CT-600-A, CT-1550, CT-1551, CT-2500 | 50               | 500            |

\*Not UL Listed.

\*\*Bulk packaging may be available, contact Panduit Customer Service for additional information. For crimping tool information, see pages D1.83, D1.84, D1.86 and D1.88.



## Butt Splice, Vinyl Insulated

### Type BSV

- Expanded wire entry designed to accommodate wire with a larger insulation thickness
- Designed to splice two solid or stranded wires together to repair or lengthen wires
- Brazed seam protects terminal barrel from splitting during the crimp process
- Internal wire stop assures proper length of insertion into terminal barrel
- UL Flammability UL 94V-0, maximum insulation temperature 221°F (105°C)
- UL and CSA rated up to 600 V per UL 486C

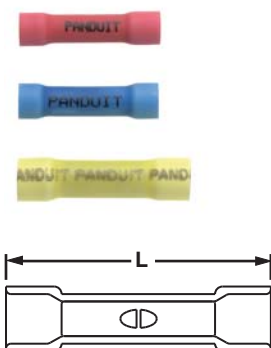

| Part Number      | Wire Range  | Color Code | Max. Ins. (In.) | Figure Dimensions (In.) | Recommended Installation Tool                | Std. Pkg. Qty.** | Std. Ctn. Qty. |
|------------------|-------------|------------|-----------------|-------------------------|--|------------------|----------------|
|                  |             |            |                 | L                       |  |                  |                |
| <b>BSV18X-LY</b> | 22 – 18 AWG | Red        | 0.170           | 1.03                    | CT-100A, CT-600-A, CT-1550, CT-1551, CT-2500 | 50               | 500            |
| <b>BSV14X-L</b>  | 16 – 14 AWG | Blue       | 0.211           | 1.04                    |  | 50               | 500            |
| <b>BSV10X-Q</b>  | 12 – 10 AWG | Yellow     | 0.260           | 1.17                    |  | 25               | 250            |

\*\*Bulk packaging may be available, contact Panduit Customer Service for additional information. For crimping tool information, see pages D1.83, D1.84, D1.86 and D1.88.

A. System Overview

B1. Cable Ties

B2. Cable Accessories

B3. Stainless Steel Ties

C1. Wiring Duct

C2. Surface Raceway

C3. Abrasion Protection

C4. Cable Management

D1. Terminals

D2. Power Connectors

D3. Grounding Connectors

E1. Labeling Systems

E2. Labels

E3. Pre-Printed & Write-On Markers

E4. Permanent Identification

E5. Lockout/Tagout & Safety Solutions

F. Index

A. System Overview

B1. Cable Ties



## Butt Splice, Non-Insulated

### Type BS

- Designed to splice two solid or stranded wires together to repair or lengthen wires
- Butted configuration provides low profile for limited space applications
- Brazed seam protects terminal barrel from splitting during the crimp process

- Internal wire stop assures proper length of insertion into terminal barrel
- Non-insulated barrel can be used to provide an economical termination when insulation is not required
- Maximum recommended operating temperature 302°F (150°C)
- UL and CSA rated up to 2000 V per UL 486C

B2. Cable Accessories

B3. Stainless Steel Ties



C1. Wiring Duct



C2. Surface Raceway



C3. Abrasion Protection

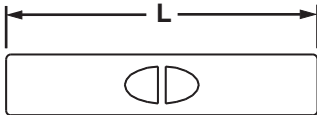

C4. Cable Management

| Part Number    | Wire Range  | Figure Dimensions (In.) | Recommended Installation Tool                         | Std. Pkg. Qty.** | Std. Ctn. Qty. |
|----------------|-------------|-------------------------|---|------------------|----------------|
|                |             | L                       |   |                  |                |
| <b>BS22-C*</b> | 26 – 22 AWG | 0.47                    | CT-100A   | 100              | 1000           |
| <b>BS18-C</b>  | 22 – 18 AWG | 0.62                    | CT-100A, CT-200, CT-600-A, CT-1570, CT-2500           | 100              | 1000           |
| <b>BS14-C</b>  | 16 – 14 AWG | 0.62                    | CT-100A, CT-200, CT-600-A, CT-1570, CT-2500           | 100              | 1000           |
| <b>BS10-L</b>  | 12 – 10 AWG | 0.63                    | CT-100A, CT-200, CT-600-A, CT-1570, CT-2500, CT-1701‡ | 50               | 500            |

\*Not UL Listed.

\*\*Bulk packaging may be available, contact Panduit Customer Service for additional information.

‡UL and CSA approved tooling/product combinations. For crimping tool information, see pages D1.83, D1.84, D1.86 and D1.88.

D1. Terminals

D2. Power Connectors

D3. Grounding Connectors

## Parallel Splice, Nylon Insulated

### Type PSN

- Designed to splice two solid or stranded wires together to repair or lengthen wires
- Parallel design results in only one crimp required to complete splice

- Seamless tubular barrel provides a consistent high performance quality crimp
- Maximum insulation temperature 221°F (105°C)
- Rated up to 300 V

E1. Labeling Systems

E2. Labels



E3. Pre-Printed & Write-On Markers



E4. Permanent Identification



E5. Lockout/Tagout & Safety Solutions

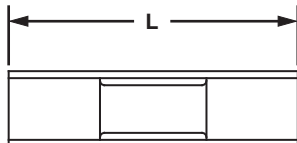

| Part Number    | Wire Range  | Color Code | Max. Ins. (In.) | Figure Dimensions (In.) | Wire Strip Length (In.) | Recommended Installation Tool | Std. Pkg. Qty.** | Std. Ctn. Qty. |
|----------------|-------------|------------|-----------------|-------------------------|-------------------------|-------------------------------|------------------|----------------|
|                |             |            |                 | L                       |                         |                               |                  |                |
| <b>PSN18-C</b> | 22 – 18 AWG | Red        | 0.120           | 0.75                    | 5/16                    | CT-100A, CT-1525, CT-2500     | 100              | 500            |
| <b>PSN16-C</b> | 20 – 16 AWG | Blue       | 0.150           | 0.75                    | 5/16                    |                               | 100              | 500            |
| <b>PSN12-L</b> | 14 – 12 AWG | Yellow     | 0.210           | 0.83                    | 7/16                    | CT-100A                       | 50               | 500            |

\*\*Bulk packaging may be available, contact Panduit Customer Service for additional information.

For crimping tool information, see pages D1.83, D1.84, and D1.88.

F. Index





## Parallel Splice, Non-Insulated

### Type PS

- Designed to splice two solid or stranded wires together to repair or lengthen wires
- Parallel design results in only one crimp required to complete splice
- Seamless tubular barrel provides a consistent high performance quality crimp

- Non-insulated barrel can be used to provide an economical termination when insulation is not required
- Maximum recommended operating temperature 302°F (150°C)
- UL and CSA rated up to 2000 V per UL 486C



| Part Number   | Wire Range  | Figure Dimensions (In.) |  | Wire Strip Length (In.) | Recommended Installation Tool | Std. Pkg. Qty.** | Std. Ctn. Qty. |
|---------------|-------------|-------------------------|--|-------------------------|-------------------------------|------------------|----------------|
|               |             | L                       |  |                         |                               |                  |                |
| <b>PS18-C</b> | 22 – 18 AWG | 0.29                    |  | 5/16                    | CT-100A,<br>CT-200            | 100              | 500            |
| <b>PS16-C</b> | 20 – 16 AWG | 0.29                    |  | 5/16                    |                               | 100              | 500            |
| <b>PS12-L</b> | 14 – 12 AWG | 0.38                    |  | 7/16                    |                               | 50               | 500            |

\*\*Bulk packaging may be available, contact Panduit Customer Service for additional information. For crimping tool information, see page D1.83.

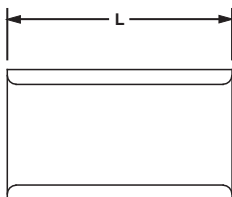

## Wire Joint, Nylon Insulated

### Type JN

- Large barrel, designed to accommodate from one to seven wires with just one crimp
- Accommodates multiple wire sizes in varying combinations
- Barrel of terminal internally beveled to provide quick and easy wire insertion

- UL Flammability UL 94V-2/HB, maximum insulation temperature 221°F (105°C)
- UL and CSA rated up to 600 V per UL 486C



| Part Number         | Wire Range        | Color Code | CMA Range |       | Figure Dimensions (In.) |  | Wire Strip Length (In.) | Recommended Installation Tool          | Std. Pkg. Qty.** | Std. Ctn. Qty. |
|---------------------|-------------------|------------|-----------|-------|-------------------------|--|-------------------------|--|------------------|----------------|
|                     |                   |            | Min.      | Max.  | L                       |  |                         |  |                  |                |
| <b>JN224-318-C</b>  | (2) #24 – (2) #16 | Red        | 808       | 5160  | 0.79                    |  | 7/16                    | CT-1550‡, CT-1551‡, CT-2500‡           | 100              | 1000           |
| <b>JN218-216-C</b>  | (2) #22 – (2) #16 | Clear      | 1284      | 5160  | 0.78                    |  | 7/16                    | CT-1550‡, CT-1551‡, CT-2500‡           | 100              | 1000           |
| <b>JN418-212-C</b>  | (4) #18 – (2) #12 | Clear      | 6480      | 14750 | 0.93                    |  | 1/2                     | CT-100A‡, CT-1550‡, CT-1551‡, CT-2500‡ | 100              | 1000           |
| <b>JN314-412-C*</b> | (3) #14 – (4) #12 | Clear      | 10320     | 26120 | 0.97                    |  | 5/8                     | CT-100A, CT-160, CT-260                | 100              | 1000           |

\*Not UL Listed.

\*\*Bulk packaging may be available, contact Panduit Customer Service for additional information.

‡UL and CSA approved tooling/product combinations. For crimping tool information, see pages D1.83, D1.84, and D1.88.

Note: Wire combinations using #24 AWG wire are not UL Listed or CSA Certified.

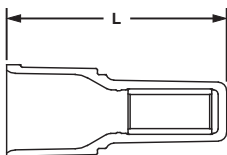

A. System Overview

B1. Cable Ties

B2. Cable Accessories

B3. Stainless Steel Ties

C1. Wiring Duct

C2. Surface Raceway

C3. Abrasion Protection

C4. Cable Management

D1. Terminals

D2. Power Connectors

D3. Grounding Connectors

E1. Labeling Systems

E2. Labels

E3. Pre-Printed & Write-On Markers

E4. Permanent Identification

E5. Lockout/Tagout & Safety Solutions

F. Index

A. System Overview

B1. Cable Ties

B2. Cable Accessories

B3. Stainless Steel Ties

C1. Wiring Duct

C2. Surface Raceway

C3. Abrasion Protection

C4. Cable Management

D1. Terminals

D2. Power Connectors

D3. Grounding Connectors

E1. Labeling Systems

E2. Labels

E3. Pre-Printed & Write-On Markers

E4. Permanent Identification

E5. Lockout/Tagout & Safety Solutions

F. Index



## Wire Joint, Non-Insulated Type J

- Large barrel, designed to accommodate from one to seven wires with just one crimp
- Accommodates multiple wire sizes in varying combinations
- Non-insulated barrel can be used to provide an economical termination when insulation is not required
- Barrel of terminal internally beveled to provide quick and easy wire insertion
- Maximum recommended operating temperature 302°F (150°C)
- UL and CSA rated up to 2000 V per UL 486C

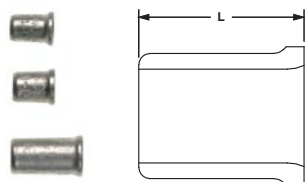

| Part Number        | Wire Range        | CMA Range |       | Figure Dimensions (In.) | Wire Strip Length (In.) | Recommended Installation Tool | Std. Pkg. Qty.** | Std. Ctn. Qty. |
|--------------------|-------------------|-----------|-------|-------------------------|-------------------------|-------------------------------|------------------|----------------|
|                    |                   | Min.      | Max.  | L                       |                         |                               |                  |                |
| <b>J214-312-T</b>  | (2) #14 – (3) #12 | 5760      | 19590 | 0.37                    | 1/2                     | CT-100A‡, CT-200‡             | 200              | 2000           |
| <b>J318-412-T</b>  | (3) #18 – (4) #12 | 4860      | 27330 | 0.37                    | 1/2                     | CT-100A‡, CT-200‡             | 200              | 2000           |
| <b>J216-410-L*</b> | (2) #16 – (4) #10 | 5160      | 41600 | 0.62                    | 3/4                     | CT-100A‡, CT-200‡             | 50               | 500            |

\*Part number J216-410, is not UL Listed or CSA Certified.  
 \*\*Bulk packaging may be available, contact Panduit Customer Service for additional information.  
 ‡UL and CSA approved tooling/product combinations. For crimping tool information, see page D1.83.



## Heat Shrink, Butt Splices Type BSH

- Designed to splice two solid or stranded wires together to repair or lengthen wires
- Butted configuration provides low profile for limited space applications
- Heat shrink polyolefin sleeve with hot melt adhesive protects against moisture
- After crimping, heat shrink insulation is completed with a standard heat gun
- Minimum continuous operating temperature -65°F (-55°C)
- Maximum continuous operation temperature 230°F (110°C)
- Shrink temperature 300°F (150°C)
- UL and CSA rated up to 600 V per UL 486C

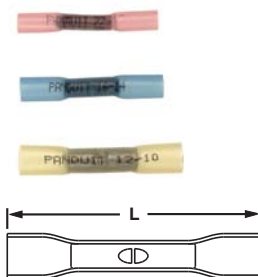

| Part Number    | Wire Range  | Color Code | Max. Ins. (In.) | Figure Dimensions (In.) | Wire Strip Length (In.) | Recommended Installation Tool | Std. Pkg. Qty.** | Std. Ctn. Qty. |
|----------------|-------------|------------|-----------------|-------------------------|-------------------------|-------------------------------|------------------|----------------|
|                |             |            |                 | L                       |                         |                               |                  |                |
| <b>BSH18-Q</b> | 22 – 18 AWG | Red        | 0.170           | 1.45                    | 5/16                    | CT-310                        | 25               | 125            |
| <b>BSH14-Q</b> | 16 – 14 AWG | Blue       | 0.190           | 1.45                    | 5/16                    | CT-310                        | 25               | 125            |
| <b>BSH10-E</b> | 12 – 10 AWG | Yellow     | 0.240           | 1.64                    | 5/16                    | CT-310                        | 20               | 100            |

\*\*Bulk packaging may be available, contact Panduit Customer Service for additional information.  
 For crimping tool information, see page D1.85.

## Metric Butt Splice, Vinyl Insulated Type BSMV

- Expanded wire entry designed to accommodate wire with a larger insulation thickness
- Designed to splice two solid or stranded wires together to repair or lengthen wires
- Brazed seam protects terminal barrel from splitting during the crimp process
- Internal wire stop assures proper length of insertion into terminal barrel
- Maximum insulation temperature 221°F (105°C)
- Rated up to 600 V

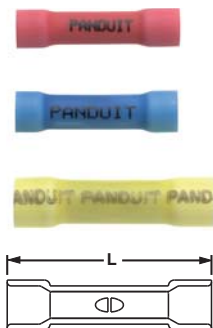

| Part Number        | Wire Range (mm²) | Color Code | Max Ins. (mm) | Figure Dimensions (mm) | Recommended Installation Tool | Std. Pkg. Qty.** | Std. Ctn. Qty. |
|--------------------|------------------|------------|---------------|------------------------|-------------------------------|------------------|----------------|
|                    |                  |            |               | L                      |                               |                  |                |
| <b>BSMV1BX-LY^</b> | 0.5 – 1.0        | Red        | 4.3           | 26.4                   | CT-1551                       | 50               | 500            |
| <b>BSMV2BX-L^</b>  | 1.5 – 2.5        | Blue       | 5.1           | 26.4                   | CT-1551                       | 50               | 500            |
| <b>BSMV6X-Q*</b>   | 4.0 – 6.0        | Yellow     | 6.4           | 30.0                   | CT-1551                       | 25               | 250            |

\*Brazed seam.  
 \*\*Bulk packaging may be available, contact Panduit Customer Service for additional information.  
 ^Butted seam.  
 For crimping tool information, see page D1.84.

## Metric Butt Splice, Non-Insulated

### Type BSM

- Designed to splice two solid or stranded wires together to repair or lengthen wires
- Butted configuration provides low profile for limited space applications
- Brazed seam protects terminal barrel from splitting during the crimp process
- Internal wire stop assures proper length of insertion into terminal barrel
- Non-insulated barrel can be used to provide an economical termination when insulation is not required
- Maximum recommended operating temperature 302°F (150°C)
- Rated up to 2000 V

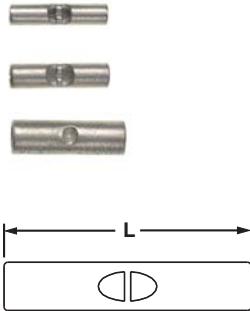

| Part Number | Wire Range (mm <sup>2</sup> ) | Figure Dimensions (mm) | Recommended Installation Tool | Std. Pkg. Qty. | Std. Ctn. Qty. |
|-------------|-------------------------------|------------------------|-------------------------------|----------------|----------------|
|             |                               | L                      |                               |                |                |
| BSM1-C      | 0.5 – 1.0                     | 15.7                   | CT-1570,<br>CT-2500           | 100            | 500            |
| BSM2-C      | 1.5 – 2.5                     | 15.7                   |                               | 100            | 500            |
| BSM6-L      | 4.0 – 6.0                     | 18.2                   |                               | 50             | 250            |

For crimping tool information, see pages D1.84 and D1.88.

## Metric Wire Joints, Nylon Insulated

### Type JMN

- Large barrel, designed to accommodate from one to seven wires with just one crimp
- Accommodates multiple wire sizes in varying combinations
- Barrel of terminal internally beveled to provide quick and easy wire insertion
- Maximum insulation temperature 221°F (105°C)
- Rated up to 600 V

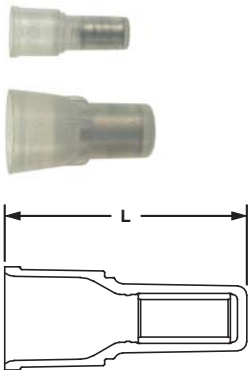

| Part Number | Wire Range (mm <sup>2</sup> ) | Color Code | CMA Range Min. | CMA Range Max. | Figure Dimensions (mm) | Recommended Installation Tool | Std. Pkg. Qty. | Std. Ctn. Qty. |
|-------------|-------------------------------|------------|----------------|----------------|------------------------|-------------------------------|----------------|----------------|
|             |                               |            |                |                | L                      |                               |                |                |
| JMN2-C      | 0.5 – 2.5                     | Clear      | 1284           | 5160           | 19.9                   | CT-1551                       | 100            | 500            |
| JMN6-C      | 0.75 – 6.0                    | Clear      | 6480           | 14750          | 23.9                   | CT-1551                       | 100            | 500            |

For crimping tool information, see page D1.84.

A.  
System  
Overview

B1.  
Cable Ties

B2.  
Cable  
Accessories

B3.  
Stainless  
Steel Ties

C1.  
Wiring  
Duct

C2.  
Surface  
Raceway

C3.  
Abrasion  
Protection

C4.  
Cable  
Management

D1.  
Terminals

D2.  
Power  
Connectors

D3.  
Grounding  
Connectors

E1.  
Labeling  
Systems

E2.  
Labels

E3.  
Pre-Printed  
& Write-On  
Markers

E4.  
Permanent  
Identification

E5.  
Lockout/  
Tagout  
& Safety  
Solutions

F.  
Index

A. System Overview

B1. Cable Ties

B2. Cable Accessories

B3. Stainless Steel Ties

## PAN-TERM® FERRULES

Panduit® Pan-Term® Ferrule end sleeves terminate stranded wire into terminal blocks with superior termination performance. A wide assortment of ferrule styles and tool designs provide a proven way to make reliable connections, especially for limited space applications. Insulation flare allows for ease of wire insertion and eliminates loose strands of wire. Encapsulated crimp contains loose wires to eliminate stray wire breakage.



- Ideal for control panel and terminal block applications
- Insulated single wire range of #26 – 1 AWG, sizes meets French and DIN color code standards
- Insulated twin wire end sleeve range of #22 – 10 AWG, sizes meets DIN color code standard
- Non-insulated wire range of #24 – 1 AWG
- Insulated ferrules single wire range #20 – 14 AWG, available in strips of 50 for use with the semiautomatic ferrule crimping tool, CT-1000, for improved reliability and productivity
- Wide assortment of controlled cycle, crimping tools for reliable connections at the lowest installed cost

C1. Wiring Duct

C2. Surface Raceway

C3. Abrasion Protection

C4. Cable Management



D1. Terminals

D2. Power Connectors

D3. Grounding Connectors

Panduit continually provides new designs to meet the application challenges encountered by our customers. Panduit offers a wide assortment of Pan-Term® termination products to meet customer needs at the lowest installed cost.

E1. Labeling Systems

E2. Labels

E3. Pre-Printed & Write-On Markers

E4. Permanent Identification

E5. Lockout/Tagout & Safety Solutions

F. Index

## Features and Benefits – Pan-Term® Ferrules

Panduit ferrules are available for wiring applications from #26 – 1 AWG. Offerings include insulated and non-insulated ferrules, in single-wire or double-wire configurations. Insulated ferrules are color-coded to DIN or French standards. Crimped on the metal barrel these ferrules provide improved performance for terminal block and panel building applications.

|   |   |
|---|---|
| <p style="text-align: center;"><b>Insulated Ferrules – Single Wire<br/>Type FSF and FSD</b></p> | <p style="text-align: center;"><b>Insulated Ferrules – Twin Wire<br/>Type FTD</b></p> |
|---|---|

### Non-Insulated Ferrules

#### Type F



Panduit provides a wide assortment of crimping tools for reliable connections at the lowest installed cost.

See page D1.85.



Panduit designs and manufactures a full line of labeling products, software, and printers to assist you with your labeling requirements.

See pages E1.1 – E2.28.

A.  
System  
Overview

B1.  
Cable Ties

B2.  
Cable  
Accessories

B3.  
Stainless  
Steel Ties

C1.  
Wiring  
Duct

C2.  
Surface  
Raceway

C3.  
Abrasion  
Protection

C4.  
Cable  
Management

D1.  
Terminals

D2.  
Power  
Connectors

D3.  
Grounding  
Connectors

E1.  
Labeling  
Systems

E2.  
Labels

E3.  
Pre-Printed  
& Write-On  
Markers

E4.  
Permanent  
Identification

E5.  
Lockout/  
Tagout  
& Safety  
Solutions

F.  
Index

A. System Overview

## Selection Guide – Pan-Term® Ferrules

B1. Cable Ties

B2. Cable Accessories

B3. Stainless Steel Ties

C1. Wiring Duct

C2. Surface Raceway

C3. Abrasion Protection

C4. Cable Management

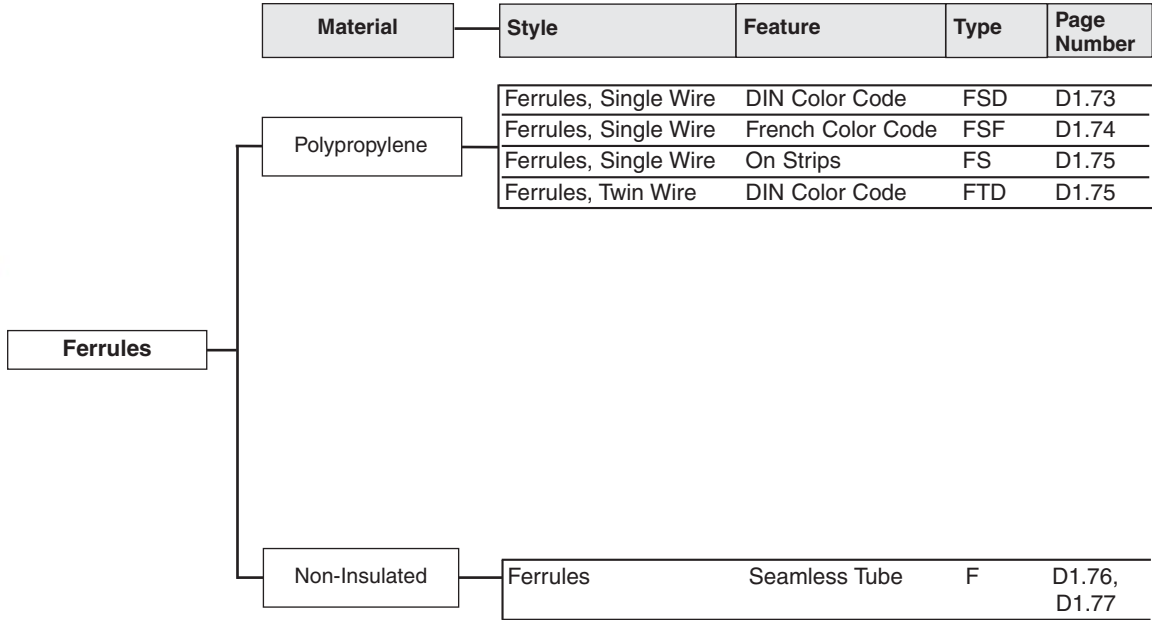

D1. Terminals

## Part Number System for Pan-Term® Ferrules

D2. Power Connectors

D3. Grounding Connectors

**F**

**S**

**D**

**72**

**8**

Type

Wire Type

Color Code

Wire Size

DIN/French Length

F = Ferrule

S = Single

D = DIN

T = Twin

F = French

Blank = Non-Insulated

E2. Labels

E3. Pre-Printed & Write-On Markers

E4. Permanent Identification

E5. Lockout/Tagout & Safety Solutions

F. Index





## Insulated Ferrules – Single Wire DIN End Sleeve

### Type FSD

- Polypropylene insulation housing conforms to DIN color requirements
- Meets DIN standards for single wire containment
- Funnel entry for faster insertion and lower installed cost
- Designed with a seamless barrel to contain loose wire strands for superior terminations
- Eases insertion of wire into terminal block
- Suitable for limited space panel applications
- Multiple pin lengths available for a variety of terminal blocks



| Part Number | Wire Size |                 | Color Code | Max. Wire Insul. Dia. |      | Figure Dimensions |      |      |      |      |      | Wire Strip Length |      | Recommended Installation Tool      | Std. Pkg. Qty. |
|-------------|-----------|-----------------|------------|-----------------------|------|-------------------|------|------|------|------|------|-------------------|------|------------------------------------|----------------|
|             | AWG       | mm <sup>2</sup> |            | In.                   | mm   | L                 |      | P    |      | ID   |      | In.               | mm   |                                    |                |
| FSD72-6-D   | 26 AWG    | 0.14            | Gray       | 0.07                  | 2.0  | 0.41              | 10.5 | 0.24 | 6.0  | 0.03 | 0.8  | 3/8               | 9.5  | CT-1002, CT-1123                   | 500            |
| FSD72-8-D   |           |                 |            | 0.07                  | 2.0  | 0.49              | 12.5 | 0.31 | 8.0  | 0.03 | 0.8  | 15/32             | 11.9 |                                    | 500            |
| FSD73-6-D   | 24 AWG    | 0.25            | Yellow     | 0.07                  | 2.0  | 0.41              | 10.5 | 0.24 | 6.0  | 0.03 | 0.8  | 3/8               | 9.5  | CT-1002, CT-1123                   | 500            |
| FSD73-8-D   |           |                 |            | 0.07                  | 2.0  | 0.49              | 12.5 | 0.31 | 8.0  | 0.03 | 0.8  | 15/32             | 11.9 |                                    | 500            |
| FSD74-6-D   | 24 AWG    | 0.34            | Turquoise  | 0.07                  | 2.0  | 0.41              | 10.5 | 0.24 | 6.0  | 0.03 | 0.8  | 3/8               | 9.5  | CT-1002, CT-1123                   | 500            |
| FSD74-8-D   |           |                 |            | 0.07                  | 2.0  | 0.49              | 12.5 | 0.31 | 8.0  | 0.03 | 0.8  | 15/32             | 11.9 |                                    | 500            |
| FSD75-6-D   | 22 AWG    | 0.5             | White      | 0.09                  | 2.5  | 0.45              | 11.5 | 0.24 | 6.0  | 0.04 | 1.1  | 3/8               | 9.5  | CT-1002, CT-1123                   | 500            |
| FSD75-8-D   |           |                 |            | 0.09                  | 2.5  | 0.53              | 13.5 | 0.31 | 8.0  | 0.04 | 1.1  | 15/32             | 11.9 |                                    | 500            |
| FSD75-10-D  |           |                 |            | 0.09                  | 2.5  | 0.61              | 15.5 | 0.39 | 10.0 | 0.04 | 1.1  | 17/32             | 13.5 |                                    | 500            |
| FSD76-6-D   | 20 AWG    | 0.75            | Gray       | 0.11                  | 2.8  | 0.47              | 12.0 | 0.24 | 6.0  | 0.05 | 1.3  | 3/8               | 9.5  | CT-1002, CT-1123                   | 500            |
| FSD76-8-D   |           |                 |            | 0.11                  | 2.8  | 0.55              | 14.0 | 0.31 | 8.0  | 0.05 | 1.3  | 15/32             | 11.9 |                                    | 500            |
| FSD76-10-D  |           |                 |            | 0.11                  | 2.8  | 0.63              | 16.0 | 0.39 | 10.0 | 0.05 | 1.3  | 17/32             | 13.5 |                                    | 500            |
| FSD76-12-D  | 20 AWG    | 0.75            | Gray       | 0.11                  | 2.8  | 0.71              | 18.0 | 0.47 | 12.0 | 0.05 | 1.3  | 5/8               | 15.9 | CT-1002, CT-1003, CT-1123          | 500            |
| FSD77-6-D   |           |                 |            | 0.12                  | 3.0  | 0.49              | 12.5 | 0.24 | 6.0  | 0.06 | 1.5  | 3/8               | 9.5  |                                    | 500            |
| FSD77-8-D   |           |                 |            | 0.12                  | 3.0  | 0.57              | 14.5 | 0.31 | 8.0  | 0.06 | 1.5  | 15/32             | 11.9 |                                    | 500            |
| FSD77-10-D  | 18 AWG    | 1.0             | Red        | 0.12                  | 3.0  | 0.65              | 16.5 | 0.39 | 10.0 | 0.06 | 1.5  | 17/32             | 13.5 | CT-1002, CT-1003, CT-1123          | 500            |
| FSD77-12-D  |           |                 |            | 0.12                  | 3.0  | 0.73              | 18.5 | 0.47 | 12.0 | 0.06 | 1.5  | 5/8               | 15.9 |                                    | 500            |
| FSD78-6-D   | 16 AWG    | 1.5             | Black      | 0.12                  | 3.0  | 0.49              | 12.5 | 0.24 | 6.0  | 0.07 | 1.8  | 3/8               | 9.5  | CT-1002, CT-1003, CT-1123          | 500            |
| FSD78-8-D   |           |                 |            | 0.12                  | 3.0  | 0.57              | 14.5 | 0.31 | 8.0  | 0.07 | 1.8  | 15/32             | 11.9 |                                    | 500            |
| FSD78-10-D  |           |                 |            | 0.12                  | 3.0  | 0.65              | 16.5 | 0.39 | 10.0 | 0.07 | 1.8  | 17/32             | 13.5 |                                    | 500            |
| FSD78-12-D  |           |                 |            | 0.12                  | 3.0  | 0.73              | 18.5 | 0.47 | 12.0 | 0.07 | 1.8  | 5/8               | 15.9 |                                    | 500            |
| FSD78-18-D  |           |                 |            | 0.12                  | 3.0  | 0.96              | 24.5 | 0.71 | 18.0 | 0.07 | 1.8  | 7/8               | 22.2 |                                    | 500            |
| FSD79-8-D   | 14 AWG    | 2.08            | Yellow     | 0.14                  | 3.6  | 0.57              | 14.5 | 0.31 | 8.0  | 0.08 | 2.1  | 15/32             | 11.9 | CT-1003, CT-1004, CT-1123, CT-1104 | 500            |
| FSD80-8-D   |           |                 |            | 0.17                  | 4.2  | 0.59              | 15.0 | 0.31 | 8.0  | 0.09 | 2.3  | 15/32             | 11.9 |                                    | 500            |
| FSD80-12-D  | 14 AWG    | 2.5             | Blue       | 0.17                  | 4.2  | 0.75              | 19.0 | 0.47 | 12.0 | 0.09 | 2.3  | 5/8               | 15.9 | CT-1003, CT-1004, CT-1123, CT-1104 | 500            |
| FSD80-18-D  |           |                 |            | 0.17                  | 4.2  | 0.98              | 25.0 | 0.71 | 18.0 | 0.09 | 2.3  | 7/8               | 22.2 |                                    | 500            |
| FSD81-10-D  | 12 AWG    | 4.0             | Gray       | 0.19                  | 4.8  | 0.69              | 17.5 | 0.39 | 10.0 | 0.11 | 2.9  | 17/32             | 13.5 | CT-1003, CT-1004, CT-1123, CT-1104 | 500            |
| FSD81-12-C  |           |                 |            | 0.19                  | 4.8  | 0.79              | 20.0 | 0.47 | 12.0 | 0.11 | 2.9  | 5/8               | 15.9 |                                    | 100            |
| FSD81-18-C  |           |                 |            | 0.19                  | 4.8  | 1.02              | 26.0 | 0.71 | 18.0 | 0.11 | 2.9  | 7/8               | 22.2 |                                    | 100            |
| FSD82-12-C  | 10 AWG    | 6.0             | Yellow     | 0.24                  | 6.2  | 0.79              | 20.0 | 0.47 | 12.0 | 0.14 | 3.6  | 5/8               | 15.9 | CT-1003, CT-1004, CT-1123, CT-1104 | 100            |
| FSD82-18-C  |           |                 |            | 0.24                  | 6.2  | 1.02              | 26.0 | 0.71 | 18.0 | 0.14 | 3.6  | 7/8               | 22.2 |                                    | 100            |
| FSD83-12-C  | 8 AWG     | 10.0            | Red        | 0.30                  | 7.5  | 0.83              | 21.0 | 0.47 | 12.0 | 0.18 | 4.6  | 5/8               | 15.9 | CT-1003, CT-1004, CT-1123, CT-1104 | 100            |
| FSD83-18-C  |           |                 |            | 0.30                  | 7.5  | 1.06              | 27.0 | 0.71 | 18.0 | 0.18 | 4.6  | 7/8               | 22.2 |                                    | 100            |
| FSD84-12-C  | 6 AWG     | 16.0            | Blue       | 0.35                  | 8.8  | 0.91              | 23.0 | 0.47 | 12.0 | 0.24 | 6.0  | 5/8               | 15.9 | CT-1004, CT-1104                   | 100            |
| FSD84-18-C  |           |                 |            | 0.35                  | 8.8  | 1.14              | 29.0 | 0.71 | 18.0 | 0.24 | 6.0  | 7/8               | 22.2 |                                    | 100            |
| FSD85-16-L  | 4 AWG     | 25.0            | Yellow     | 0.43                  | 11.0 | 1.14              | 29.0 | 0.63 | 16.0 | 0.30 | 7.5  | 3/4               | 19.1 | CT-1005                            | 50             |
| FSD85-18-L  |           |                 |            | 0.43                  | 11.0 | 1.22              | 31.0 | 0.71 | 18.0 | 0.30 | 7.5  | 7/8               | 22.2 |                                    | 50             |
| FSD85-22-L  |           |                 |            | 0.43                  | 11.0 | 1.38              | 35.0 | 0.87 | 22.0 | 0.30 | 7.5  | 1                 | 25.4 |                                    | 50             |
| FSD86-16-L  | 2 AWG     | 35.0            | Red        | 0.49                  | 12.5 | 1.18              | 30.0 | 0.63 | 16.0 | 0.33 | 8.5  | 3/4               | 19.1 | CT-1005                            | 50             |
| FSD86-18-L  |           |                 |            | 0.49                  | 12.5 | 1.26              | 32.0 | 0.71 | 18.0 | 0.33 | 8.5  | 7/8               | 22.2 |                                    | 50             |
| FSD86-25-L  |           |                 |            | 0.49                  | 12.5 | 1.54              | 39.0 | 0.98 | 25.0 | 0.33 | 8.5  | 1 1/8             | 28.6 |                                    | 50             |
| FSD87-20-L  | 1 AWG     | 50.0            | Blue       | 0.59                  | 15.0 | 1.42              | 36.0 | 0.79 | 20.0 | 0.41 | 10.5 | 15/16             | 23.8 | CT-1006                            | 50             |
| FSD87-25-Q  |           |                 |            | 0.59                  | 15.0 | 1.61              | 41.0 | 0.98 | 25.0 | 0.41 | 10.5 | 1 1/8             | 28.6 |                                    | 25             |

For crimping tool information, see page D1.85

For technical assistance in the U.S., call 866-405-6654 (outside the U.S., see inside back cover for directory)

A.  
System  
Overview

B1.  
Cable Ties

B2.  
Cable  
Accessories

B3.  
Stainless  
Steel Ties

C1.  
Wiring  
Duct

C2.  
Surface  
Raceway

C3.  
Abrasion  
Protection

C4.  
Cable  
Management

D1.  
Terminals

D2.  
Power  
Connectors

D3.  
Grounding  
Connectors

E1.  
Labeling  
Systems

E2.  
Labels

E3.  
Pre-Printed  
& Write-On  
Markers

E4.  
Permanent  
Identification

E5.  
Lockout/  
Tagout  
& Safety  
Solutions

F.  
Index

A. System Overview



## Insulated Ferrules – Single Wire French End Sleeve

### Type FSF

B1. Cable Ties

- Polypropylene insulation housing conforms to French color requirements
- Meets DIN standards for single wire containment
- Funnel entry for faster insertion and lower installed cost

- Eases insertion of wire into terminal block
- Suitable for limited space panel applications
- Multiple pin lengths available for a variety of terminal blocks

B2. Cable Accessories

- Designed with a seamless barrel to contain loose wire strands for superior terminations



B3. Stainless Steel Ties

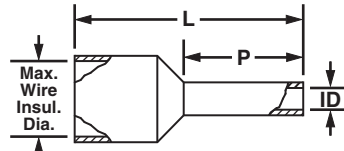

C1. Wiring Duct

C2. Surface Raceway

C3. Abrasion Protection

C4. Cable Management

D1. Terminals

D2. Power Connectors

D3. Grounding Connectors

E1. Labeling Systems

E2. Labels

E3. Pre-Printed & Write-On Markers

E4. Permanent Identification

E5. Lockout/Tagout & Safety Solutions

F. Index

| Part Number       | Wire Size |                 | Color  | Maximum Wire Insulation |      | Figure Dimensions |      |      |      |      |      | Wire Strip Length |      | Recommended Installation Tool      | Std. Pkg. Qty. |
|-------------------|-----------|-----------------|--------|-------------------------|------|-------------------|------|------|------|------|------|-------------------|------|------------------------------------|----------------|
|                   | AWG       | mm <sup>2</sup> |        | In.                     | mm   | L                 |      | P    |      | ID   |      | In.               | mm   |                                    |                |
| <b>FSF72-6-D</b>  | 26 AWG    | 0.14            | Brown  | 0.07                    | 1.7  | 0.41              | 10.5 | 0.24 | 6.0  | 0.03 | 0.8  | 3/8               | 9.5  | CT-1002, CT-1123                   | 500            |
| <b>FSF72-8-D</b>  |           |                 |        | 0.07                    | 1.7  | 0.49              | 12.5 | 0.31 | 8.0  | 0.03 | 0.8  | 15/32             | 11.9 |                                    | 500            |
| <b>FSF73-6-D</b>  | 24 AWG    | 0.25            | Violet | 0.07                    | 1.7  | 0.41              | 10.5 | 0.24 | 6.0  | 0.03 | 0.8  | 3/8               | 9.5  | CT-1002, CT-1123                   | 500            |
| <b>FSF73-8-D</b>  |           |                 |        | 0.07                    | 1.7  | 0.49              | 12.5 | 0.31 | 8.0  | 0.03 | 0.8  | 15/32             | 11.9 |                                    | 500            |
| <b>FSF74-6-D</b>  | 24 AWG    | 0.34            | Pink   | 0.07                    | 1.7  | 0.41              | 10.5 | 0.24 | 6.0  | 0.03 | 0.8  | 3/8               | 9.5  | CT-1002, CT-1123                   | 500            |
| <b>FSF74-8-D</b>  |           |                 |        | 0.07                    | 1.7  | 0.49              | 12.5 | 0.31 | 8.0  | 0.03 | 0.8  | 15/32             | 11.9 |                                    | 500            |
| <b>FSF75-6-D</b>  | 22 AWG    | 0.50            | White  | 0.09                    | 2.2  | 0.45              | 11.5 | 0.24 | 6.0  | 0.04 | 1.1  | 3/8               | 9.5  | CT-1002, CT-1123                   | 500            |
| <b>FSF75-8-D</b>  |           |                 |        | 0.09                    | 2.2  | 0.53              | 13.5 | 0.31 | 8.0  | 0.04 | 1.1  | 15/32             | 11.9 |                                    | 500            |
| <b>FSF75-10-D</b> | 20 AWG    | 0.75            | Blue   | 0.09                    | 2.2  | 0.61              | 15.5 | 0.39 | 10.0 | 0.04 | 1.1  | 17/32             | 13.5 | CT-1002, CT-1123                   | 500            |
| <b>FSF76-6-D</b>  |           |                 |        | 0.09                    | 2.4  | 0.47              | 12.0 | 0.24 | 6.0  | 0.05 | 1.3  | 3/8               | 9.5  |                                    | 500            |
| <b>FSF76-8-D</b>  | 20 AWG    | 0.75            | Blue   | 0.09                    | 2.4  | 0.55              | 14.0 | 0.31 | 8.0  | 0.05 | 1.3  | 15/32             | 11.9 | CT-1002, CT-1123                   | 500            |
| <b>FSF76-10-D</b> |           |                 |        | 0.09                    | 2.4  | 0.63              | 16.0 | 0.39 | 10.0 | 0.05 | 1.3  | 17/32             | 13.5 |                                    | 500            |
| <b>FSF76-12-D</b> | 18 AWG    | 1.0             | Red    | 0.09                    | 2.4  | 0.71              | 18.0 | 0.47 | 12.0 | 0.05 | 1.3  | 5/8               | 15.9 | CT-1002, CT-1123                   | 500            |
| <b>FSF77-6-D</b>  |           |                 |        | 0.11                    | 2.7  | 0.49              | 12.5 | 0.24 | 6.0  | 0.06 | 1.5  | 3/8               | 9.5  |                                    | 500            |
| <b>FSF77-8-D</b>  | 18 AWG    | 1.0             | Red    | 0.11                    | 2.7  | 0.57              | 14.5 | 0.31 | 8.0  | 0.06 | 1.5  | 15/32             | 11.9 | CT-1002, CT-1123                   | 500            |
| <b>FSF77-10-D</b> |           |                 |        | 0.11                    | 2.7  | 0.65              | 16.5 | 0.39 | 10.0 | 0.06 | 1.5  | 17/32             | 13.5 |                                    | 500            |
| <b>FSF77-12-D</b> | 16 AWG    | 1.5             | Black  | 0.11                    | 2.7  | 0.73              | 18.5 | 0.47 | 12.0 | 0.06 | 1.5  | 5/8               | 15.9 | CT-1002, CT-1123                   | 500            |
| <b>FSF78-6-D</b>  |           |                 |        | 0.12                    | 3.0  | 0.49              | 12.5 | 0.24 | 6.0  | 0.07 | 1.8  | 3/8               | 9.5  |                                    | 500            |
| <b>FSF78-8-D</b>  | 16 AWG    | 1.5             | Black  | 0.12                    | 3.0  | 0.57              | 14.5 | 0.31 | 8.0  | 0.07 | 1.8  | 15/32             | 11.9 | CT-1002, CT-1123                   | 500            |
| <b>FSF78-10-D</b> |           |                 |        | 0.12                    | 3.0  | 0.65              | 16.5 | 0.39 | 10.0 | 0.07 | 1.8  | 17/32             | 13.5 |                                    | 500            |
| <b>FSF78-12-D</b> | 14 AWG    | 2.1             | Yellow | 0.12                    | 3.0  | 0.73              | 18.5 | 0.47 | 12.0 | 0.07 | 1.8  | 5/8               | 15.9 | CT-1002, CT-1123                   | 500            |
| <b>FSF78-18-D</b> |           |                 |        | 0.12                    | 3.0  | 0.96              | 24.5 | 0.71 | 18.0 | 0.07 | 1.8  | 7/8               | 22.2 |                                    | 500            |
| <b>FSF79-8-D</b>  | 14 AWG    | 2.5             | Gray   | 0.13                    | 3.2  | 0.57              | 14.5 | 0.31 | 8.0  | 0.08 | 2.1  | 15/32             | 11.9 | CT-1003, CT-1004, CT-1123, CT-1104 | 100            |
| <b>FSF80-8-D</b>  |           |                 |        | 0.15                    | 3.7  | 0.59              | 15.0 | 0.31 | 8.0  | 0.09 | 2.3  | 15/32             | 11.9 |                                    | 100            |
| <b>FSF80-12-D</b> | 12 AWG    | 4.0             | Orange | 0.15                    | 3.7  | 0.75              | 19.0 | 0.47 | 12.0 | 0.09 | 2.3  | 5/8               | 15.9 | CT-1003, CT-1004, CT-1123, CT-1104 | 100            |
| <b>FSF80-18-D</b> |           |                 |        | 0.15                    | 3.7  | 0.98              | 25.0 | 0.71 | 18.0 | 0.09 | 2.3  | 7/8               | 22.2 |                                    | 100            |
| <b>FSF81-10-D</b> | 10 AWG    | 6.0             | Green  | 0.17                    | 4.3  | 0.69              | 17.5 | 0.39 | 10.0 | 0.11 | 2.9  | 17/32             | 13.5 | CT-1005                            | 50             |
| <b>FSF81-12-C</b> |           |                 |        | 0.17                    | 4.3  | 0.79              | 20.0 | 0.47 | 12.0 | 0.11 | 2.9  | 5/8               | 15.9 |                                    | 50             |
| <b>FSF81-18-C</b> | 8 AWG     | 10.0            | Brown  | 0.17                    | 4.3  | 1.02              | 26.0 | 0.71 | 18.0 | 0.11 | 2.9  | 7/8               | 22.2 | CT-1005                            | 50             |
| <b>FSF82-12-C</b> |           |                 |        | 0.22                    | 5.5  | 0.79              | 20.0 | 0.47 | 12.0 | 0.14 | 3.6  | 5/8               | 15.9 |                                    | 50             |
| <b>FSF82-18-C</b> | 6 AWG     | 16.0            | White  | 0.22                    | 5.5  | 1.02              | 26.0 | 0.71 | 18.0 | 0.14 | 3.6  | 7/8               | 22.2 | CT-1005                            | 50             |
| <b>FSF83-12-C</b> |           |                 |        | 0.27                    | 6.8  | 0.83              | 21.0 | 0.47 | 12.0 | 0.18 | 4.6  | 5/8               | 15.9 |                                    | 50             |
| <b>FSF83-18-C</b> | 4 AWG     | 25.0            | Black  | 0.27                    | 6.8  | 1.06              | 27.0 | 0.71 | 18.0 | 0.18 | 4.6  | 7/8               | 22.2 | CT-1006                            | 25             |
| <b>FSF84-12-C</b> |           |                 |        | 0.35                    | 8.8  | 0.91              | 23.0 | 0.47 | 12.0 | 0.24 | 6.0  | 5/8               | 15.9 |                                    | 50             |
| <b>FSF84-18-C</b> | 2 AWG     | 35.0            | Red    | 0.35                    | 8.8  | 1.14              | 29.0 | 0.71 | 18.0 | 0.24 | 6.0  | 7/8               | 22.2 | CT-1006                            | 25             |
| <b>FSF85-16-L</b> |           |                 |        | 0.41                    | 10.3 | 1.14              | 29.0 | 0.63 | 16.0 | 0.30 | 7.5  | 3/4               | 19.1 |                                    | 50             |
| <b>FSF85-18-L</b> | 1 AWG     | 50.0            | Blue   | 0.41                    | 10.3 | 1.22              | 31.0 | 0.71 | 18.0 | 0.30 | 7.5  | 7/8               | 22.2 | CT-1006                            | 25             |
| <b>FSF85-22-L</b> |           |                 |        | 0.41                    | 10.3 | 1.38              | 35.0 | 0.87 | 22.0 | 0.30 | 7.5  | 1                 | 25.4 |                                    | 50             |
| <b>FSF86-16-L</b> | 2 AWG     | 35.0            | Red    | 0.45                    | 11.5 | 1.18              | 30.0 | 0.63 | 16.0 | 0.33 | 8.5  | 3/4               | 19.1 | CT-1006                            | 25             |
| <b>FSF86-18-L</b> |           |                 |        | 0.45                    | 11.5 | 1.26              | 32.0 | 0.71 | 18.0 | 0.33 | 8.5  | 7/8               | 22.2 |                                    | 50             |
| <b>FSF86-25-L</b> | 1 AWG     | 50.0            | Blue   | 0.45                    | 11.5 | 1.54              | 39.0 | 0.98 | 25.0 | 0.33 | 8.5  | 1 1/8             | 28.6 | CT-1006                            | 25             |
| <b>FSF87-20-L</b> |           |                 |        | 0.54                    | 13.7 | 1.42              | 36.0 | 0.79 | 20.0 | 0.41 | 10.5 | 15/16             | 23.8 |                                    | 50             |
| <b>FSF87-25-Q</b> |           |                 |        | 0.54                    | 13.7 | 1.61              | 41.0 | 0.98 | 25.0 | 0.41 | 10.5 | 1 1/8             | 28.6 |                                    | 25             |

For crimping tool information, see page D1.85.



## Insulated Ferrules – Twin Wire DIN End Sleeve

### Type FTD

- Meets DIN standards for twin wire containment
- Polypropylene insulation housing conforms to DIN color requirements
- Funnel entry for faster insertion and lower installed cost
- Designed with a seamless barrel to contain loose wire strands for superior terminations

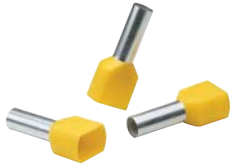

- Eases insertion of wire into terminal block
- Suitable for limited space panel applications
- Multiple pin lengths available for a variety of terminal blocks

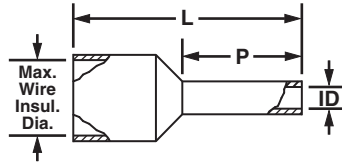

| Part Number        | Wire Size |      | Color  | Max. Wire Insul. Dia. |     | Figure Dimensions |      |      |      |      |     | Wire Strip Length |      | Recommended Installation Tool | Std. Pkg. Qty. |
|--------------------|-----------|------|--------|-----------------------|-----|-------------------|------|------|------|------|-----|-------------------|------|-------------------------------|----------------|
|                    | AWG       | mm'  |        | In.                   | mm  | L                 |      | P    |      | ID   |     | In.               | mm   |                               |                |
| <b>FTD75-8-D</b>   | 22 AWG    | 0.5  | White  | 0.87                  | 2.2 | 0.59              | 15.0 | 0.31 | 8.0  | 0.06 | 1.5 | 7/16              | 11.2 | CT-1002, CT-1003, CT-1123     | 500            |
| <b>FTD76-8-D</b>   | 20 AWG    | 0.75 | Gray   | 0.09                  | 2.4 | 0.59              | 15.0 | 0.31 | 8.0  | 0.07 | 1.8 | 7/16              | 11.2 |                               | 500            |
| <b>FTD76-10-D</b>  |           |      |        | 0.09                  | 2.4 | 0.67              | 17.0 | 0.39 | 10.0 | 0.07 | 1.8 | 9/16              | 14.0 |                               | 500            |
| <b>FTD77-8-D</b>   | 18 AWG    | 1.0  | Red    | 0.11                  | 2.7 | 0.59              | 15.0 | 0.31 | 8.0  | 0.08 | 2.1 | 7/16              | 11.2 |                               | 500            |
| <b>FTD77-10-D</b>  |           |      |        | 0.11                  | 2.7 | 0.67              | 17.0 | 0.39 | 10.0 | 0.08 | 2.1 | 9/16              | 14.0 |                               | 500            |
| <b>FTD78-8-D</b>   | 16 AWG    | 1.5  | Black  | 0.12                  | 3.0 | 0.63              | 16.0 | 0.31 | 8.0  | 0.09 | 2.3 | 7/16              | 11.2 |                               | 500            |
| <b>FTD78-12-D</b>  |           |      |        | 0.12                  | 3.0 | 0.79              | 20.0 | 0.47 | 12.0 | 0.09 | 2.3 | 21/32             | 16.8 |                               | 500            |
| <b>FTD80-10-TL</b> | 14 AWG    | 2.5  | Blue   | 0.15                  | 3.7 | 0.73              | 18.5 | 0.39 | 10.0 | 0.11 | 2.9 | 9/16              | 14.0 |                               | 250            |
| <b>FTD80-13-TL</b> |           |      |        | 0.15                  | 3.7 | 0.85              | 21.5 | 0.51 | 13.0 | 0.11 | 2.9 | 23/32             | 16.2 |                               | 250            |
| <b>FTD81-12-C</b>  | 12 AWG    | 4.0  | Gray   | 0.17                  | 4.3 | 0.91              | 23.0 | 0.47 | 12.0 | 0.15 | 3.8 | 21/32             | 16.8 |                               | 100            |
| <b>FTD82-14-C</b>  | 10 AWG    | 6.0  | Yellow | 0.19                  | 4.8 | 0.98              | 25.0 | 0.55 | 14.0 | 0.18 | 4.6 | 25/32             | 19.6 | CT-1003, CT-1004, CT-1104     | 100            |

For crimping tool information, see page D1.85.



## Insulated Ferrules on Strips – Single Wire

### Type FS

- Polypropylene insulation housing available in DIN standard colors in strips of 50
- Continuously molded design provides consistent placement of ferrules in tool to ensure fast, reliable terminations

- Available in #20 – 14 AWG featuring a seamless barrel design to contain loose wire strands for superior terminations
- Designed for use with the Semiautomatic Ferrule Crimping Tool CT-1000 for medium volume applications

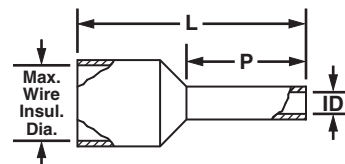
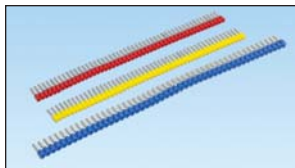

| Part Number          | Wire Size |      | Color | Max. Wire Insul. Dia. |     | Figure Dimensions |      |      |     |      |     | Wire Strip Length |      | Recommended Installation Tool | Std. Pkg. Qty. |
|----------------------|-----------|------|-------|-----------------------|-----|-------------------|------|------|-----|------|-----|-------------------|------|-------------------------------|----------------|
|                      | AWG       | mm2  |       | In.                   | mm  | L                 |      | P    |     | ID   |     | In.               | mm   |                               |                |
| <b>FSD75-8-DSL10</b> | 20 AWG    | 0.50 | White | 0.10                  | 2.6 | 0.60              | 15.2 | 0.31 | 8.0 | 0.04 | 1.0 | 13/32             | 10.0 | CT-1000                       | 500            |
| <b>FSD76-8-DSL8</b>  | 18 AWG    | 0.75 | Gray  | 0.11                  | 2.7 | 0.60              | 15.2 | 0.31 | 8.0 | 0.06 | 1.5 | 13/32             | 10.0 |                               | 500            |
| <b>FSD77-8-DSL2</b>  |           | 1.00 | Red   | 0.12                  | 3.0 | 0.60              | 15.2 | 0.31 | 8.0 | 0.07 | 1.8 | 13/32             | 10.0 |                               | 500            |
| <b>FSD78-8-DSL0</b>  |           | 1.50 | Black | 0.13                  | 3.2 | 0.60              | 15.2 | 0.31 | 8.0 | 0.09 | 2.3 | 13/32             | 10.0 |                               | 500            |
| <b>FSD80-8-DSL6</b>  | 14 AWG    | 2.50 | Blue  | 0.16                  | 4.0 | 0.60              | 15.2 | 0.31 | 8.0 | 0.09 | 2.3 | 13/32             | 10.0 |                               | 500            |

### Additional Colored End Sleeves

|                     |        |      |            |        |      |      |      |      |      |      |      |       |       |         |      |
|---------------------|--------|------|------------|--------|------|------|------|------|------|------|------|-------|-------|---------|------|
| <b>FS75-8-DSL3</b>  | 20 AWG | 0.50 | Orange     | 0.10   | 2.6  | 0.60 | 15.2 | 0.31 | 8.0  | 0.04 | 1.0  | 13/32 | 10.0  | CT-1000 | 500  |
| <b>FS76-8-DSL10</b> | 18 AWG | 0.75 | White      | 0.11   | 2.7  | 0.60 | 15.2 | 0.31 | 8.0  | 0.05 | 1.2  | 13/32 | 10.0  |         | 500  |
| <b>FS76-8-DSL7</b>  |        |      | Light Blue | 0.11   | 2.7  | 0.60 | 15.2 | 0.31 | 8.0  | 0.05 | 1.2  | 13/32 | 10.0  |         | 500  |
| <b>FS77-8-DSL4</b>  |        |      | 1.00       | Yellow | 0.12 | 3.0  | 0.60 | 15.2 | 0.31 | 8.0  | 0.06 | 1.5   | 13/32 |         | 10.0 |
| <b>FS78-8-DSL2</b>  | 16 AWG | 1.50 | Red        | 0.13   | 3.2  | 0.60 | 15.2 | 0.31 | 8.0  | 0.07 | 1.8  | 13/32 | 10.0  |         | 500  |
| <b>FS80-8-DSL8</b>  | 14 AWG | 2.50 | Gray       | 0.16   | 4.0  | 0.60 | 15.2 | 0.31 | 8.0  | 0.09 | 2.3  | 13/32 | 10.0  |         | 500  |

For crimping tool information, see page D1.86.

A. System Overview

## Ferrules, Non-Insulated

B1. Cable Ties

### Type F

B2. Cable Accessories

- Designed with a seamless barrel to contain loose wire strands for superior terminations
- Eases insertion of wire into terminal block
- Meets DIN standards for wire containment
- Suitable for limited space panel applications
- Multiple pin lengths available for a variety of terminal blocks

B3. Stainless Steel Ties

C1. Wiring Duct

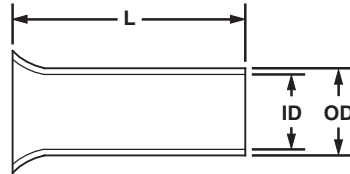

C2. Surface Raceway

C3. Abrasion Protection

C4. Cable Management

D1. Terminals

D2. Power Connectors

D3. Grounding Connectors

E1. Labeling Systems

E2. Labels

E3. Pre-Printed & Write-On Markers

E4. Permanent Identification

E5. Lockout/Tagout & Safety Solutions

F. Index

| Part Number     | Wire Size |                 | Figure Dimensions |      |      |      |      |       | Wire Strip Length |                                 | Recommended Installation Tool   | Std. Pkg. Qty. |
|-----------------|-----------|-----------------|-------------------|------|------|------|------|-------|-------------------|---------------------------------|---------------------------------|----------------|
|                 |           |                 | L                 |      | ID   |      | OD   |       |                   |                                 |                                 |                |
|                 | AWG       | mm <sup>2</sup> | In.               | mm   | In.  | mm   | In.  | mm    | In.               | mm                              |                                 |                |
| <b>F73-5-M</b>  | 24 AWG    | 0.25            | 0.20              | 5.0  | 0.03 | 0.80 | 0.04 | 1.1   | 7/32              | 5.0                             | CT-1002,<br>CT-1003             | 1000           |
| <b>F73-7-M</b>  |           |                 | 0.28              | 7.0  | 0.03 | 0.80 | 0.04 | 1.1   | 9/32              | 7.0                             |                                 | 1000           |
| <b>F74-5-M</b>  |           | 0.34            | 0.20              | 5.0  | 0.04 | 0.90 | 0.05 | 1.2   | 7/32              | 5.0                             |                                 | 1000           |
| <b>F74-7-M</b>  |           |                 | 0.28              | 7.0  | 0.04 | 0.90 | 0.05 | 1.2   | 9/32              | 7.0                             |                                 | 1000           |
| <b>F75-6-M</b>  | 22 AWG    | 0.50            | 0.24              | 6.0  | 0.04 | 1.0  | 0.05 | 1.3   | 1/4               | 6.0                             | CT-1002,<br>CT-1003,<br>CT-1123 | 1000           |
| <b>F75-8-M</b>  |           |                 | 0.31              | 8.0  | 0.04 | 1.0  | 0.05 | 1.3   | 5/16              | 8.0                             |                                 | 1000           |
| <b>F75-10-M</b> | 20 AWG    | 0.75            | 0.39              | 10.0 | 0.04 | 1.0  | 0.05 | 1.3   | 13/32             | 10.0                            | CT-1002,<br>CT-1003,<br>CT-1123 | 1000           |
| <b>F76-6-M</b>  |           |                 | 0.24              | 6.0  | 0.05 | 1.2  | 0.06 | 1.5   | 1/4               | 6.0                             |                                 | 1000           |
| <b>F76-8-M</b>  |           |                 | 0.31              | 8.0  | 0.05 | 1.2  | 0.06 | 1.5   | 5/16              | 8.0                             |                                 | 1000           |
| <b>F76-10-M</b> |           |                 | 0.39              | 10.0 | 0.05 | 1.2  | 0.06 | 1.5   | 13/32             | 10.0                            |                                 | 1000           |
| <b>F76-12-M</b> | 18 AWG    | 1.0             | 0.47              | 12.0 | 0.05 | 1.2  | 0.06 | 1.5   | 15/32             | 12.0                            | CT-1002,<br>CT-1003,<br>CT-1123 | 1000           |
| <b>F77-6-M</b>  |           |                 | 0.24              | 6.0  | 0.06 | 1.4  | 0.07 | 1.7   | 1/4               | 6.0                             |                                 | 1000           |
| <b>F77-7-M</b>  |           |                 | 0.28              | 7.0  | 0.06 | 1.4  | 0.07 | 1.7   | 9/32              | 7.0                             |                                 | 1000           |
| <b>F77-8-M</b>  |           |                 | 0.31              | 8.0  | 0.06 | 1.4  | 0.07 | 1.7   | 5/16              | 8.0                             |                                 | 1000           |
| <b>F77-10-M</b> | 16 AWG    | 1.5             | 0.39              | 10.0 | 0.06 | 1.4  | 0.07 | 1.7   | 13/32             | 10.0                            | CT-1002,<br>CT-1003,<br>CT-1123 | 1000           |
| <b>F77-12-M</b> |           |                 | 0.47              | 12.0 | 0.06 | 1.4  | 0.07 | 1.7   | 15/32             | 12.0                            |                                 | 1000           |
| <b>F78-7-M</b>  |           |                 | 0.28              | 7.0  | 0.07 | 1.7  | 0.08 | 2.0   | 9/32              | 7.0                             |                                 | 1000           |
| <b>F78-8-M</b>  |           |                 | 0.31              | 8.0  | 0.07 | 1.7  | 0.08 | 2.0   | 5/16              | 8.0                             |                                 | 1000           |
| <b>F78-10-M</b> | 1.5       | 0.39            | 10.0              | 0.07 | 1.7  | 0.08 | 2.0  | 13/32 | 10.0              | CT-1002,<br>CT-1003,<br>CT-1123 | 1000                            |                |
| <b>F78-12-M</b> |           | 0.47            | 12.0              | 0.07 | 1.7  | 0.08 | 2.0  | 15/32 | 12.0              |                                 | 1000                            |                |
| <b>F78-15-M</b> |           | 0.59            | 15.0              | 0.07 | 1.7  | 0.08 | 2.0  | 19/32 | 15.0              |                                 | 1000                            |                |
| <b>F78-18-M</b> | 1.5       | 0.71            | 18.0              | 0.07 | 1.7  | 0.08 | 2.0  | 23/32 | 18.0              | CT-1002,<br>CT-1003,<br>CT-1123 | 1000                            |                |
| <b>F78-20-M</b> |           | 0.79            | 20.0              | 0.07 | 1.7  | 0.08 | 2.0  | 25/32 | 20.0              |                                 | 1000                            |                |

For crimping tool information, see page D1.85.

## Ferrules, Non-Insulated (continued)

### Type F

| Part Number | Wire Size |      | Figure Dimensions |      |      |      |      |      | Wire Strip Length |      | Recommended Installation Tool | Std. Pkg. Qty. |
|-------------|-----------|------|-------------------|------|------|------|------|------|-------------------|------|-------------------------------|----------------|
|             |           |      | L                 |      | ID   |      | OD   |      |                   |      |                               |                |
|             | In.       | mm   | In.               | mm   | In.  | mm   | In.  | mm   |                   |      |                               |                |
| F80-7-M     | 14 AWG    | 2.5  | 0.28              | 7.0  | 0.09 | 2.2  | 0.10 | 2.5  | 9/32              | 7.0  | CT-1002, CT-1003, CT-1123     | 1000           |
| F80-8-M     |           |      | 0.31              | 8.0  | 0.09 | 2.2  | 0.10 | 2.5  | 5/16              | 8.0  |                               | 1000           |
| F80-10-M    |           |      | 0.39              | 10.0 | 0.09 | 2.2  | 0.10 | 2.5  | 13/32             | 10.0 |                               | 1000           |
| F80-12-M    |           |      | 0.47              | 12.0 | 0.09 | 2.2  | 0.10 | 2.5  | 15/32             | 12.0 |                               | 1000           |
| F80-15-M    |           |      | 0.59              | 15.0 | 0.09 | 2.2  | 0.10 | 2.5  | 19/32             | 15.0 |                               | 1000           |
| F80-18-M    |           |      | 0.71              | 18.0 | 0.09 | 2.2  | 0.10 | 2.5  | 23/32             | 18.0 |                               | 1000           |
| F80-20-M    |           |      | 0.79              | 20.0 | 0.09 | 2.2  | 0.10 | 2.5  | 25/32             | 20.0 |                               | 1000           |
| F81-9-M     | 12 AWG    | 4.0  | 0.35              | 9.0  | 0.11 | 2.8  | 0.13 | 3.2  | 11/32             | 8.0  | CT-1002, CT-1003, CT-1123     | 1000           |
| F81-10-M    |           |      | 0.39              | 10.0 | 0.11 | 2.8  | 0.13 | 3.2  | 13/32             | 10.0 |                               | 1000           |
| F81-12-M    |           |      | 0.47              | 12.0 | 0.11 | 2.8  | 0.13 | 3.2  | 15/32             | 12.0 |                               | 1000           |
| F81-15-M    |           |      | 0.59              | 15.0 | 0.11 | 2.8  | 0.13 | 3.2  | 19/32             | 15.0 |                               | 1000           |
| F81-18-M    |           |      | 0.71              | 18.0 | 0.11 | 2.8  | 0.13 | 3.2  | 23/32             | 18.0 |                               | 1000           |
| F81-20-M    |           |      | 0.79              | 20.0 | 0.11 | 2.8  | 0.13 | 3.2  | 25/32             | 20.0 |                               | 1000           |
| F82-10-M    | 10 AWG    | 6.0  | 0.39              | 10.0 | 0.14 | 3.5  | 0.15 | 3.9  | 13/32             | 10.0 | CT-1002, CT-1003, CT-1123     | 1000           |
| F82-12-M    |           |      | 0.47              | 12.0 | 0.14 | 3.5  | 0.15 | 3.9  | 15/32             | 12.0 |                               | 1000           |
| F82-15-M    |           |      | 0.59              | 15.0 | 0.14 | 3.5  | 0.15 | 3.9  | 19/32             | 15.0 |                               | 1000           |
| F82-18-M    |           |      | 0.71              | 18.0 | 0.14 | 3.5  | 0.15 | 3.9  | 23/32             | 18.0 |                               | 1000           |
| F82-20-M    |           |      | 0.79              | 20.0 | 0.14 | 3.5  | 0.15 | 3.9  | 25/32             | 20.0 |                               | 1000           |
| F83-12-D    | 8 AWG     | 10.0 | 0.47              | 12.0 | 0.18 | 4.5  | 0.19 | 4.9  | 15/32             | 12.0 | CT-1003, CT-1004, CT-1123     | 500            |
| F83-15-D    |           |      | 0.59              | 15.0 | 0.18 | 4.5  | 0.19 | 4.9  | 19/32             | 15.0 |                               | 500            |
| F83-18-D    |           |      | 0.71              | 18.0 | 0.18 | 4.5  | 0.19 | 4.9  | 23/32             | 18.0 |                               | 500            |
| F83-20-D    |           |      | 0.79              | 20.0 | 0.18 | 4.5  | 0.19 | 4.9  | 25/32             | 20.0 |                               | 500            |
| F83-25-D    |           |      | 0.98              | 25.0 | 0.18 | 4.5  | 0.19 | 4.9  | 31/32             | 25.0 |                               | 500            |
| F84-12-TL   | 6 AWG     | 16.0 | 0.47              | 12.0 | 0.23 | 5.8  | 0.24 | 6.2  | 15/32             | 12.0 | CT-1004                       | 250            |
| F84-15-TL   |           |      | 0.59              | 15.0 | 0.23 | 5.8  | 0.24 | 6.2  | 19/32             | 15.0 |                               | 250            |
| F84-18-TL   |           |      | 0.71              | 18.0 | 0.23 | 5.8  | 0.24 | 6.2  | 23/32             | 18.0 |                               | 250            |
| F84-20-TL   |           |      | 0.79              | 20.0 | 0.23 | 5.8  | 0.24 | 6.2  | 25/32             | 20.0 |                               | 250            |
| F84-25-TL   |           |      | 0.98              | 25.0 | 0.23 | 5.8  | 0.24 | 6.2  | 31/32             | 25.0 |                               | 250            |
| F84-32-TL   |           |      | 1.26              | 32.0 | 0.23 | 5.8  | 0.24 | 6.2  | 1 1/4             | 32.0 |                               | 250            |
| F85-12-C    |           |      | 4 AWG             | 25.0 | 0.47 | 12.0 | 0.29 | 7.3  | 0.30              | 7.7  |                               | 15/32          |
| F85-15-C    | 0.59      | 15.0 |                   |      | 0.29 | 7.3  | 0.30 | 7.7  | 19/32             | 15.0 | 100                           |                |
| F85-18-C    | 0.71      | 18.0 |                   |      | 0.29 | 7.3  | 0.30 | 7.7  | 23/32             | 18.0 | 100                           |                |
| F85-25-C    | 0.98      | 25.0 |                   |      | 0.29 | 7.3  | 0.30 | 7.7  | 31/32             | 25.0 | 100                           |                |
| F85-32-C    | 1.26      | 32.0 |                   |      | 0.29 | 7.3  | 0.30 | 7.7  | 1 1/4             | 32.0 | 100                           |                |
| F86-18-C    | 0.71      | 18.0 |                   |      | 0.33 | 8.3  | 0.34 | 8.7  | 23/32             | 18.0 | 100                           |                |
| F86-20-C    | 2 AWG     | 35.0 | 0.79              | 20.0 | 0.33 | 8.3  | 0.34 | 8.7  | 25/32             | 20.0 | CT-1006                       | 100            |
| F86-25-C    |           |      | 0.98              | 25.0 | 0.33 | 8.3  | 0.34 | 8.7  | 31/32             | 25.0 |                               | 100            |
| F86-32-C    |           |      | 1.26              | 32.0 | 0.33 | 8.3  | 0.34 | 8.7  | 1 1/4             | 32.0 |                               | 100            |
| F87-18-C    | 1 AWG     | 50.0 | 0.71              | 18.0 | 0.41 | 10.3 | 0.43 | 10.9 | 23/32             | 18.0 | CT-1006                       | 100            |
| F87-22-C    |           |      | 0.87              | 22.0 | 0.41 | 10.3 | 0.43 | 10.9 | 7/8               | 22.0 |                               | 100            |
| F87-25-C    |           |      | 0.98              | 25.0 | 0.41 | 10.3 | 0.43 | 10.9 | 31/32             | 25.0 |                               | 100            |
| F87-32-C    |           |      | 1.26              | 32.0 | 0.41 | 10.3 | 0.43 | 10.9 | 1 1/4             | 32.0 |                               | 100            |

For crimping tool information, see page D1.85.

A. System Overview

B1. Cable Ties

B2. Cable Accessories

B3. Stainless Steel Ties

C1. Wiring Duct

C2. Surface Raceway

C3. Abrasion Protection

C4. Cable Management

D1. Terminals

D2. Power Connectors

D3. Grounding Connectors

E1. Labeling Systems

E2. Labels

E3. Pre-Printed & Write-On Markers

E4. Permanent Identification

E5. Lockout/Tagout & Safety Solutions

F. Index

A.  
System  
Overview

## Ferrule Assortment Kits

B1.  
Cable Ties

- Large selection of ferrules in a convenient compact case
- Plastic case is both durable and reusable keeping ferrules organized and separated

B2.  
Cable  
Accessories



KP-FSD1, KP-FSD2,  
and KP-FSD3

B3.  
Stainless  
Steel Ties

| Part Number | Part Description   | Std. Pkg. Qty. |
|-------------|--|----------------|
| KP-FSD1     | Ferrule kit includes: #24 – 18 AWG insulated DIN ferrules. Case includes: 30 pieces each of FSD73-6, FSD74-6, FSD75-8, FSD76-8 and FSD77-8.  | 1              |
| KP-FSD2     | Ferrule kit includes: #22 – 14 AWG insulated DIN ferrules. Case includes: 100 pieces each of FSD76-8, FSD77-8, FSD78-8<br>50 pieces each of FSD75-8 and FSD80-8.                   | 1              |
| KP-FSD3     | Ferrule kit includes: #12 – 6 AWG insulated DIN ferrules. Case includes: 50 pieces of FSD81-10<br>20 pieces each of FSD82-12 and FSD83-12<br>10 pieces of FSD84-12.                | 1              |
| KP-F1       | Ferrule kit includes: #22 – 14 AWG non-insulated ferrules. Case includes: 500 pieces of F75-6<br>400 pieces each of F76-6 and F77-6<br>300 pieces of F78-7<br>200 pieces of F80-7. | 1              |
| KP-F2       | Ferrule kit includes: #12 – 6 AWG non-insulated ferrules. Case includes: 150 pieces of F81-9<br>100 pieces of F82-10<br>80 pieces of F83-12<br>40 pieces of F84-12.                | 1              |

Ferrule kits do not include crimping tool.

C1.  
Wiring  
Duct

C2.  
Surface  
Raceway



KP-F1 and KP-F2

C3.  
Abrasion  
Protection

C4.  
Cable  
Management

D1.  
Terminals

D2.  
Power  
Connectors

D3.  
Grounding  
Connectors

E1.  
Labeling  
Systems

E2.  
Labels

E3.  
Pre-Printed  
& Write-On  
Markers

E4.  
Permanent  
Identification

E5.  
Lockout/  
Tagout  
& Safety  
Solutions

F.  
Index



## TERMINAL CRIMPING TOOLS

Panduit offers a wide assortment of tools to provide solutions for installing terminals, disconnects, splices, ferrules and lugs. Panduit installation tools provide quality performance and ease of installation at the lowest installed cost. The long-term reliability of Panduit installation tools provides the highest level of service to meet customer requirements.



- Ergonomic design to minimize operator effort
- Features crimping tools with a controlled cycle mechanism ensuring repeat reliability in every crimp
- Superior locator ensures proper location of the terminal barrel or insulated disconnect in the crimp pocket
- Battery powered, hydraulic tools with fingertip operation are available to meet a variety of installation needs
- UL Listed and CSA Certified tooling/product combinations, as noted

Panduit terminal crimping tools are available in an assortment of styles to meet a variety of installation needs. The installer can control the crimp with the plier type hand operated crimping tool. Hand operated Contour Crimp™ Controlled Cycle Crimping Tools feature ergonomically designed cushioned grips with low handle effort. Panduit terminal crimping tools are designed for use with Panduit terminals, providing the right solution for your termination needs.

A.  
System  
Overview

B1.  
Cable Ties

B2.  
Cable  
Accessories

B3.  
Stainless  
Steel Ties

C1.  
Wiring  
Duct

C2.  
Surface  
Raceway

C3.  
Abrasion  
Protection

C4.  
Cable  
Management

D1.  
Terminals

D2.  
Power  
Connectors

D3.  
Grounding  
Connectors

E1.  
Labeling  
Systems

E2.  
Labels

E3.  
Pre-Printed  
& Write-On  
Markers

E4.  
Permanent  
Identification

E5.  
Lockout/  
Tagout  
& Safety  
Solutions

F.  
Index

A. System Overview

B1. Cable Ties

B2. Cable Accessories

B3. Stainless Steel Ties

C1. Wiring Duct

C2. Surface Raceway

C3. Abrasion Protection

C4. Cable Management

D1. Terminals

D2. Power Connectors

D3. Grounding Connectors

E1. Labeling Systems

E2. Labels

E3. Pre-Printed & Write-On Markers

E4. Permanent Identification

E5. Lockout/Tagout & Safety Solutions

F. Index

## Crimping Guidelines for Panduit® Pan-Term® Terminals, Disconnects, Splices and Wire Joints

### 1. Select the proper Panduit terminal for the application and wire size used

- Ring terminals are used for high vibration and grounding applications
- Fork terminals are used for static (non-vibration) applications
- Disconnects are used for applications that require quick connection of wires without the use of tools
- Splices and wire joints are used to join wires together



### 2. Strip wire to the proper length as specified on:

- Panduit product packaging label
- Packaging instructions included with the Panduit product
- Or if no packaging instructions are available, plan your strip length so that 1/32" of wire can be seen protruding through the tongue end of the terminal barrel



### 3. Select the proper crimp tool to be used

- Use crimping tools that provide a UL Listed and/or CSA Certified electrical termination, to assure a safe and reliable connection
- Panduit terminals are UL Listed and CSA Certified when crimped with Panduit plier type crimping tool or with the preferred Contour Crimp™ Controlled Cycle Crimping Tool specified on the packaging label



Plier Type Crimping Tool



Contour Crimp™ Controlled Cycle Crimping Tool

### 4. Select the proper crimp pocket for the terminals and wire size you are using

- Panduit crimping tools simplify this process with color-coded crimp pockets. The yellow, blue, and red pockets are specifically designed for the industry standard barrel sizes, each with a specific color code.



### 5. Perform the electrical crimp for the plier type tool Insulated Terminals and Disconnects

- Locate terminal in appropriate size color-coded crimp die pocket with tool centered on insulation sleeve. (See Note 1, page D1.82)
- Rotate terminal so tongue is level with crimp die.
- Insert properly stripped wire into terminal until a minimum of 1/32" of wire extends beyond the terminal barrel.
- Squeeze tool handles firmly to perform the electrical crimp. (See Note 2, page D1.82)
- Provide second crimp on the flared portion of the insulation housing to close the insulation as shown. Caution: When using plier type crimping tools, do not squeeze as firmly as you did for the electrical crimp. (See Note 3, page D1.82)



Step A



Step B



Steps C and D



Step E



Complete Crimp

## Crimping Guidelines for Panduit® Pan-Term® Terminals, Disconnects, Splices and Wire Joints (continued)

### Non-Insulated Terminals and Disconnects

- Locate terminal in appropriate wire gauge crimp die pocket with indenter centered on barrel seam.
- Rotate terminal so tongue is level with crimp die.
- Insert properly stripped wire (based on recommendations on package label) into terminal until a minimum of 1/32" of wire extends beyond the terminal barrel.
- Squeeze tool handles firmly to perform the electrical crimp. (See Note 2, page D1.82)

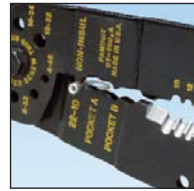

Step A



Step B

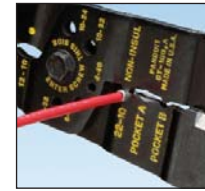

Steps C and D



Complete Crimp

### Insulated and Non-Insulated Parallel Splices

- Locate parallel splice in appropriate wire gauge crimp die pocket and position tool on the center of the splice.
- Rotate terminal so tongue is level with crimp die.
- Insert properly stripped wire (based on recommendations on package label) into each end of the parallel splice.
- Squeeze tool handles firmly. (See Note 2, page D1.82)
- An insulation crimp is not required on an insulated parallel splice.

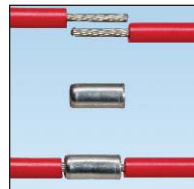

Steps A and B

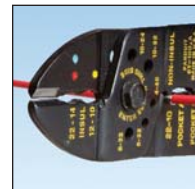

Steps C and D



Complete Crimp

### Insulated and Non-Insulated Butt Splices

- Locate butt splice in appropriate color-coded crimp die pocket and position crimp halfway between the wire stop (center of splice) and the end of the insulation crimp area. (See Note 4, page D1.82)
- Insert properly stripped wire (based on recommendations on package label) into one end of butt splice.
- Squeeze tool handles firmly to perform the electrical crimp. (See Note 2, page D1.82)
- Provide second crimp on the flared portion of the insulation housing to close the insulation. Caution: When using plier type crimping tools, do not squeeze as firmly as you did for the electrical crimp. (See Note 3, page D1.82)
- Repeat steps 1 – 4 for opposite end of butt splice. (See Note 3, page D1.82)



Steps A and B



Step C

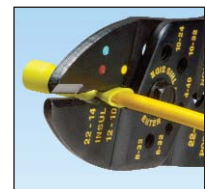

Steps D and E



Complete Crimp

A.  
System  
Overview

B1.  
Cable Ties

B2.  
Cable  
Accessories

B3.  
Stainless  
Steel Ties

C1.  
Wiring  
Duct

C2.  
Surface  
Raceway

C3.  
Abrasion  
Protection

C4.  
Cable  
Management

D1.  
Terminals

D2.  
Power  
Connectors

D3.  
Grounding  
Connectors

E1.  
Labeling  
Systems

E2.  
Labels

E3.  
Pre-Printed  
& Write-On  
Markers

E4.  
Permanent  
Identification

E5.  
Lockout/  
Tagout  
& Safety  
Solutions

F.  
Index

A. System Overview

B1. Cable Ties

B2. Cable Accessories

B3. Stainless Steel Ties

C1. Wiring Duct

C2. Surface Raceway

C3. Abrasion Protection

C4. Cable Management

D1. Terminals

D2. Power Connectors

D3. Grounding Connectors

E1. Labeling Systems

E2. Labels

E3. Pre-Printed & Write-On Markers

E4. Permanent Identification

E5. Lockout/Tagout & Safety Solutions

F. Index

## Crimping Guidelines for Panduit® Pan-Term® Terminals, Disconnects, Splices and Wire Joints (continued)

### Insulated and Non-Insulated Wire Joints

- A. Properly strip wires per manufacturer's recommendations on product package label.
- B. Twist stripped wire ends together and insert wires into wire joint.
- C. Locate wire joint in appropriate wire gauge crimp die pocket and position crimp in the center of the metal insert.
- D. Squeeze tool handles firmly to perform the electrical crimp. *(See Note 2 below)*

Note: An insulation crimp is not required on an insulated wire joint.

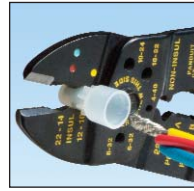

Steps A and B

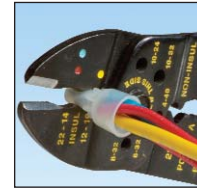

Steps C and D

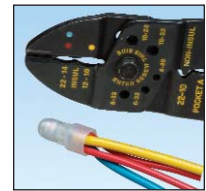

Complete Crimp

### NOTES for Crimping with the Preferred Hand Operated Controlled Cycle Crimping Tools:

1. Panduit controlled cycle crimping tools properly locate rings, forks, and barrel insulated disconnects, pins, and blades. No further positioning is required.
2. When using the preferred controlled cycle tool, once a crimp has been started, the ratchet device of controlled cycle tools will not release until the crimp is complete, independent of operator expertise.
3. Controlled cycle tools provide the electrical crimp and the insulation closure in a single cycle of the tool.
4. When using controlled cycle tooling, insulated butt splices must be inserted from the back of the tool to ensure that the electrical and insulation closure crimp pockets are properly aligned with the splice.

### 5. Perform the electrical crimp using the preferred controlled cycle tool

- A. Make sure the terminal barrel is centered correctly in the right die pocket by using the product locator on the backside of the tool.
- B. Determine the correct die pocket to use based on the color code of the terminal.
- C. Squeeze the handles of the tool until one click is heard; this click indicates the terminal is now held in place securely to insert the wire.
- D. Insert the wire and complete cycle to perform the electrical and insulation crimp simultaneously.
- E. Crimp is complete.



Step A



Step B



Step C



Step D



Complete Crimp

### 6. Inspect the crimp

Note: If your crimp looks like any of the examples shown below, cut off the terminal and re-crimp. These crimps would provide a poor connection!



Bent Back Strands



Over Crimp

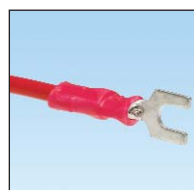

Rotated Crimp



## Hand Operated Plier Type Tools

- Installer controlled crimp
- Available with wire stripping and cutting features

- Plier type crimp for #22 – 10 AWG insulated and non-insulated terminal products



CT-260



CT-200



CT-160



CT-100A

| Part Number | Part Description   | Std. Pkg. Qty. |
|-------------|--|----------------|
| CT-260      | Crimps most Panduit #22 – 10 AWG insulated and non-insulated terminals. Forged steel tool. Cuts wire.  | 1              |
| CT-200      | Forged steel tool. Crimps most Panduit #22 – 10 AWG non-insulated terminals, disconnects and splices. Cuts wire.   | 1              |
| CT-160      | Crimps most Panduit #22 – 10 AWG insulated and non-insulated terminals disconnects and splices. Cuts three U.S. and three metric screw sizes. Cuts and strips wire. Has insulation closure pocket.   | 1              |
| CT-100A     | Crimps most Panduit #22 – 10 AWG insulated and non-insulated terminals, disconnects, and splices. Cuts #4, #6, #8 and #10 screw sizes. Cuts and strips wire. Excellent all-around application tool of heat treated finished steel with comfortable cushioned plastic grip handles. | 1              |

## Wire and Cable Stripping Tools

- Strips and cuts #20 – 10 AWG wire
- Lightweight and durable for comfortable long use

- Rust resistant coating included to improve durability of tool



| Part Number | Wire Range (O.D.) | Part Description          | Std. Pkg. Qty. |
|-------------|-------------------|---------------------------|----------------|
| CST115      | #20 – 10 AWG      | Plier nose wire stripper. | 1              |

A. System Overview

B1. Cable Ties

B2. Cable Accessories

B3. Stainless Steel Ties

C1. Wiring Duct

C2. Surface Raceway

C3. Abrasion Protection

C4. Cable Management

D1. Terminals

D2. Power Connectors

D3. Grounding Connectors

E1. Labeling Systems

E2. Labels

E3. Pre-Printed & Write-On Markers

E4. Permanent Identification

E5. Lockout/Tagout & Safety Solutions

F. Index

A. System Overview

## Contour Crimp™ Controlled Cycle Tools

B1. Cable Ties

- Controlled cycle mechanism assures high quality, consistent terminations
- Ergonomic tool design assures operator comfort, safety, and performance

- Polypropylene handles provide chemical resistance and a cushioned, non-slip grip

B2. Cable Accessories

B3. Stainless Steel Ties



C1. Wiring Duct



C2. Surface Raceway



C3. Abrasion Protection



C4. Cable Management



D1. Terminals



D2. Power Connectors



D3. Grounding Connectors



E1. Labeling Systems

E2. Labels

E3. Pre-Printed & Write-On Markers

E4. Permanent Identification

E5. Lockout/Tagout & Safety Solutions

F. Index

| Part Number    | Part Description  | Std. Pkg. Qty. |
|----------------|---|----------------|
| <b>CT-1525</b> | Crimps Panduit #26 – 22 AWG insulated terminals and splices, #22 – 10 AWG fully insulated disconnects and insulated parallel splices. Crimps Panduit #22 – 14 AWG barrel insulated disconnects.   | 1              |
| <b>CT-1550</b> | Crimps most Pan-Term® #22 – 10 AWG nylon and vinyl insulated terminals, splices, and disconnects. The CT-1550 has the red/blue pocket closest to the pivot which provides a reduced crimp effort for those who make red/blue terminations.  | 1              |
| <b>CT-1551</b> | Crimps most Pan-Term® #22 – 10 AWG nylon and vinyl insulated terminals, splices, and disconnects. The CT-1551 has the yellow pocket closest to the pivot which provides a reduced crimp effort for those who make yellow terminations.  | 1              |
| <b>CT-1570</b> | Crimps most Pan-Term® #22 – 10 AWG and .5 – 6.0mm <sup>2</sup> non-insulated terminals and disconnects. Crimps Panduit #22 – 10 AWG and .5 – 6.0mm <sup>2</sup> non-insulated splices and #10 AWG compression lugs.   | 1              |
| <b>CT-1700</b> | Crimps Panduit #8 – 2 AWG non-insulated tubular terminals (S series), #8 – 1 AWG copper code conductor lugs and splices, #8 – 2 AWG copper flex conductor lugs, #6 – 4 AWG dual rated aluminum lugs and splices and CTAPF10-16 to CTAPF3-12 copper taps. Includes 5-position, color coded rotating die. | 1              |
| <b>CT-1701</b> | Crimps Panduit #10 – 2 AWG non-insulated large gauge ring terminals (P series), #12 – 4 AWG non-insulated heavy duty ring terminals (P series), and #14 – 10 AWG copper code conductor lugs. Includes 5-position, rotating die.   | 1              |
| <b>CT-1014</b> | Crimps Panduit #22 – 14 AWG loose piece Disco-Lok™ Disconnects.   | 1              |
| <b>CT-1015</b> | Crimps Panduit #22 – 14 AWG loose piece Supra-Grip™ Disconnects.  | 1              |



## Controlled Cycle Crimping Tools

- Specialty crimping tools for fully insulated right angle disconnects and heat shrink insulated terminals, disconnects, and splices
- Controlled cycle mechanism assures high quality, consistent terminations



| Part Number | Part Description   | Std. Pkg. Qty. |
|-------------|--|----------------|
| CT-300-1    | Crimps Panduit #22 – 14 AWG fully insulated right angle disconnects (DNFR-FIB series). | 1              |
| CT-310      | Crimps Panduit #22 – 10 AWG heat shrink insulated terminals, disconnects, and splices. | 1              |

## Controlled Cycle Crimping Tools – Ferrule End Sleeve

- Specifically designed for the installation of Pan-Term® Ferrules
- Ergonomic tool design assures operator comfort, safety, and performance
- Controlled cycle mechanism assures high quality, consistent terminations
- Multi-position locator facilitates a high quality repeatable crimp



CT-1002



CT-1003



CT-1004



CT-1005



CT-1006



CT-1104



CT-1123

| Part Number | Part Description  | Std. Pkg. Qty. |
|-------------|---|----------------|
| CT-1002     | Controlled cycle crimp tool with trapezoid profile for #26 – 10 AWG (0.14 – 6.0mm <sup>2</sup> ) insulated and non-insulated single wire ferrules and #22 – 12 AWG (0.50 – 4.0mm <sup>2</sup> ) insulated twin wire ferrules. | 1              |
| CT-1003     | Controlled cycle crimp tool with trapezoid profile for #22 – 8 AWG (0.50 – 10.0mm <sup>2</sup> ) insulated and non-insulated ferrules and #22 – 10 AWG (0.50 – 6.0mm <sup>2</sup> ) insulated twin wire ferrules.             | 1              |
| CT-1004     | Controlled cycle crimp tool with trapezoid profile for #8 – 6 AWG (10.0 – 16.0mm <sup>2</sup> ) insulated and non-insulated ferrules and #10 AWG (6.0mm <sup>2</sup> ) insulated twin wire ferrules.                          | 1              |
| CT-1005     | Controlled cycle crimp tool with trapezoid profile for #4 – 2 AWG (26.0 – 35.0mm <sup>2</sup> ) insulated and non-insulated ferrules.   | 1              |
| CT-1006     | Controlled cycle crimp tool with trapezoid profile for #1 AWG (50.0mm <sup>2</sup> ) insulated and non-insulated ferrules.  | 1              |
| CT-1104     | Controlled cycle crimp tool with square profile for #8 – 6 AWG (10.0 – 16.0mm <sup>2</sup> ) insulated and non-insulated ferrules and #10 AWG (6.0mm <sup>2</sup> ) insulated twin wire ferrules.                             | 1              |
| CT-1123     | Controlled cycle crimp tool with square profile for #26 – 8 AWG (0.14 – 10.0mm <sup>2</sup> ) insulated and non-insulated ferrules and #22 – 12 AWG (0.50 – 4.0mm <sup>2</sup> ) insulated twin wire ferrules.                | 1              |

A.  
System  
Overview

B1.  
Cable Ties

B2.  
Cable  
Accessories

B3.  
Stainless  
Steel Ties

C1.  
Wiring  
Duct

C2.  
Surface  
Raceway

C3.  
Abrasion  
Protection

C4.  
Cable  
Management

D1.  
Terminals

D2.  
Power  
Connectors

D3.  
Grounding  
Connectors

E1.  
Labeling  
Systems

E2.  
Labels

E3.  
Pre-Printed  
& Write-On  
Markers

E4.  
Permanent  
Identification

E5.  
Lockout/  
Tagout  
& Safety  
Solutions

F.  
Index

A. System Overview

## Semiautomatic Ferrule Crimping Tool CT-1000

B1. Cable Ties

- Innovative rapid load design utilizes continuously molded ferrules to significantly reduce installation time
- Adjustable die setting allows termination of all Panduit #20 – 14 AWG continuously molded ferrules with a single tool
- Controlled cycle tool cuts, strips, and crimps wire to maximize efficiency

B2. Cable Accessories



B3. Stainless Steel Ties

| Part Number    | Part Description  | Std. Pkg. Qty. |
|----------------|---|----------------|
| <b>CT-1000</b> | Controlled cycle crimp tool with trapezoid profile for #20 – 14 AWG (0.50 – 2.5mm <sup>2</sup> ) insulated continuously molded ferrules on strips. Also cuts and strips wire. | 1              |

C1. Wiring Duct

C2. Surface Raceway

## Controlled Cycle Crimping Tools – In-Line

- Military specialty tools help meet military and nuclear test requirements for Class 2 applications
- Calibration-recalibration is possible for maintaining exact crimp dimensions
- In-line crimp action for greater dielectric strength with uniform insulation compression

C3. Abrasion Protection



C4. Cable Management

| Part Number   | Part Description   | Std. Pkg. Qty. |
|---------------|--|----------------|
| <b>CT-400</b> | Crimps #22 – 14 Panduit insulated terminals, disconnects, and splices. Comes complete with tools for calibration. Has adjustable pre-load and emergency ratchet. Helps meet military and nuclear requirements. | 1              |
| <b>CT-460</b> | Crimps #16 – 10 Panduit insulated terminals, disconnects, and splices. Has same features as CT-400 above.  | 1              |

For proper crimp head selection, see the tooling selection guide for Panduit terminals, splices, and disconnects on pages D1.90 – D1.92, in this catalog.

D1. Terminals

D2. Power Connectors

## Pneumatic Crimping Tool

D3. Grounding Connectors

- Quickly crimps a variety of loose piece terminals in a variety of wire sizes for medium volume production
- Portable – the small size, ease of bench mounting and quick pneumatic connection allow the tool to be moved from one work station to another or to the work itself
- Versatile interchangeable crimping heads let you switch terminal types quickly to meet changing production requirements; this tool, when used with only four crimp heads, can crimp a full range of #26 – 10 AWG insulated and non-insulated terminal products

E1. Labeling Systems



E2. Labels

E3. Pre-Printed & Write-On Markers

E4. Permanent Identification

E5. Lockout/Tagout & Safety Solutions

F. Index

| Part Number      | Part Description  | Std. Pkg. Qty. |
|------------------|---|----------------|
| <b>CT-600-A</b>  | Pneumatic tool, 6' air hose and carrying case. Does not include crimping heads (ordered separately).  | 1              |
| <b>CT-500CH</b>  | Crimping head for most #22 – 14 insulated terminals, splices, and disconnects.  | 1              |
| <b>CT-520CH</b>  | Crimping head for most #22 – 14 insulated butted seam disconnects and #26 – 22 insulated terminals.   | 1              |
| <b>CT-550CH</b>  | Crimping head for most #22 – 10 insulated terminals and splices.  | 1              |
| <b>CT-570CH</b>  | Crimping head for #22 – 10 non-insulated terminals, splices, and disconnects.   | 1              |
| <b>PD-600-A</b>  | Positioning device (for bench mounting of CT-600-A).  | 1              |
| <b>FPC-600-A</b> | Foot actuator operating air pressure: 80 – 100 psi .233 SCFM type of air: lubricated. Recommend using Norgren (Brand) #FLR222-012-043008 filter lubricator regulator. | 1              |
| <b>K600-A</b>    | Update kit for foot pedal control and positioning device to work with new CT-600-A pneumatic crimping tool.   | 1              |

For proper crimp head selection, see the tooling selection guide for Panduit terminals, splices, and disconnects on pages D1.90 – D1.92, in this catalog.

## Die Type, Manual, Crimping Tool

- High quality, durable tool construction provides long term dependability
- Develops 6 tons of crimping force, crimps copper compression lugs and splices up to 500 kcmil
- Provides UL Listed and CSA Certified connections on Panduit copper and aluminum lugs, splices insulated terminals



| Part Number | Part Description  | Std. Pkg. Qty. |
|-------------|---|----------------|
| CT-720      | Manual crimping tool for UL Listed or Recognized and CSA Certified terminations of Panduit® Pan-Lug™ copper compression lugs and splices for #8 AWG – 500 kcmil copper code conductor and aluminum compression lugs and splices for #6 AWG – 350 kcmil copper and aluminum code conductors. Provides UL Listed terminations of Panduit® Pan-Term® #8 – 2 AWG vinyl insulated terminals.<br><br>Color-coded CD-720 crimping dies, carrying/storage case, and controlled cycle mechanism must be purchased separately.<br><br>Specifications:<br>Output: 6 tons<br>Weight: 7.7 lbs.<br>Length: 26"<br>Handle span: 58" (open), 2.5" (closed)<br>Warranty: 90 days | 1              |
| CC-720      | Optional controlled cycle mechanism only. Total weight of tool with CC-720 is 8.25 lbs.   | 1              |
| C-720       | Black steel carrying case for CT-720 crimping tool.   | 1              |

For battery powered crimping tools, see compression connector tools selection guide on pages D3.30 – D3.32.

## CD-720 Crimping Dies

- Color-coded for easy matching to color-coding marked on connectors
- Embosses die index number on connector barrels to provide post crimp inspection except CD-720PV8-2
- Part number permanently marked on crimping die for easy identification
- Provides 5-sided crimp results in terminations with premium electrical and mechanical performance



CD-720PV8-2

| Part Number | Used to Install Panduit Compression Lug and Splice Sizes |  |                         |  | Std. Pkg. Qty. |
|-------------|--|--|-------------------------|--|----------------|
|             | Copper Conductor Size                                    | Copper Die Color and Die No.                     | Aluminum Conductor Size | Aluminum Die Color and Die No.               |                |
| CD-720-1    | #8 – 2 AWG   | Red P21<br>Blue P24<br>Gray P29<br>Brown P33     | #6 AWG                  | Gray P29                                     | 1              |
| CD-720-2    | #1 – 3/0 AWG   | Green P37<br>Pink P42<br>Black P45<br>Orange P50 | #4 – 1/0 AWG            | Green P37<br>Pink P42<br>Gold P45<br>Tan P50 | 1              |
| CD-720-3    | 4/0 AWG – 250 kcmil                                      | Purple P54<br>Yellow P62                         | 2/0 – 3/0 AWG           | Olive P54<br>Ruby P62                        | 1              |
| CD-720-4    | 300 kcmil  | White P66  | 4/0 AWG                 | White P66                                    | 1              |
| CD-720-5    | 350 kcmil  | Red P71  | 250 kcmil               | Red P71                                      | 1              |
| CD-720-6    | 400 kcmil  | Blue P76   | 300 kcmil               | Blue P76                                     | 1              |
| CD-720-7    | 500 kcmil  | Brown P87  | 350 kcmil               | Brown P87                                    | 1              |
| CD-720PV8-2 | #8 – 2 AWG, Vinyl Insulated Pan-Term® Terminals          | Red, Blue, Yellow                                | —                       | —  | 1              |

See pages D3.30 – D3.32 for connector and tool selection information.

A.  
System  
Overview

## CT-2500 Battery Powered Crimping Tool

B1.  
Cable Ties

- Quick two-second crimping cycle results in less time to crimp terminals compared to conventional methods
- Interchangeable crimp heads for termination of all Panduit #22 – 10 AWG terminals, disconnects, and splices
- Lightweight 3.3 lb. design provides maximum productivity and ease of use in continuous workflow operations

B2.  
Cable  
Accessories



CT-2500

B3.  
Stainless  
Steel Ties

C1.  
Wiring  
Duct

C2.  
Surface  
Raceway



CT-2550CH

C3.  
Abrasion  
Protection

C4.  
Cable  
Management



CT-2500BC

D1.  
Terminals

D2.  
Power  
Connectors

D3.  
Grounding  
Connectors

E1.  
Labeling  
Systems

E2.  
Labels

E3.  
Pre-Printed  
& Write-On  
Markers

E4.  
Permanent  
Identification

E5.  
Lockout/  
Tagout  
& Safety  
Solutions

F.  
Index

| Part Number           | Part Description   | Std. Pkg. Qty. |
|-----------------------|--|----------------|
| <b>Crimping Tools</b> |  |                |
| <b>CT-2500</b>        | Crimps Panduit #22 – 10 AWG insulated and non-insulated terminals, disconnects and splices. Includes tool, two battery cartridges (CT-2500BC), battery charger (CT-2500CHR) and molded carrying case (CT-2500CASE). These parts are also compatible with the CT-2600. Crimp heads not included. Meets U.S. voltage requirements.         | 1              |
| <b>CT-2500/E</b>      | Crimps Panduit #22 – 10 AWG insulated and non-insulated terminals, disconnects and splices. Includes tool, two battery cartridges (CT-2500BC), battery charger (CT-2500CHR/E) and molded carrying case (CT-2500CASE). These parts are also compatible with the CT-2600/E. Crimp heads not included. Meets European voltage requirements. | 1              |

### Crimp Head Frames

|                  |   |   |
|------------------|---|---|
| <b>CT-2550CH</b> | Crimps Panduit #22 – 10 AWG insulated terminals, disconnects, and splices.              | 1 |
| <b>CT-2525CH</b> | Crimps Panduit #22 – 10 AWG fully insulated disconnects and insulated parallel splices. | 1 |
| <b>CT-2570CH</b> | Crimps Panduit #22 – 10 AWG non-insulated terminals, disconnects, and splices.          | 1 |

### Die Inserts For Use With CT-2500CH Crimp Head Frame

|               |  |   |
|---------------|--|---|
| <b>CD-525</b> | Die insert used with CT-2500CH (sold separately) to crimp Panduit #22 – 10 AWG fully insulated disconnects and insulated parallel splices. | 1 |
| <b>CD-550</b> | Die insert used with CT-2500CH (sold separately) to crimp Panduit #22 – 10 AWG insulated terminals, disconnects, and splices.              | 1 |
| <b>CD-570</b> | Die insert used with CT-2500CH (sold separately) to crimp Panduit #22 – 10 AWG non-insulated terminals, disconnects, and splices.          | 1 |

### Accessories

|                     |   |   |
|---------------------|---|---|
| <b>CT-2500CHR</b>   | U.S. compatible battery charger for use with the CT-2500 and the CT-2600.     | 1 |
| <b>CT-2500CHR/E</b> | European compatible battery charger for use with the CT-2500/E and CT-2600/E. | 1 |
| <b>CT-2500BC</b>    | Rechargeable tool battery for use with the CT-2500 and CT-2600.               | 1 |
| <b>CT-2500CASE</b>  | Carrying case, holds tool (CT-2500 or CT-2600) and accessories.               | 1 |



## CT-2600 Battery Powered Hydraulic, 4 Ton, Crimping Tool

- Battery powered hydraulic design delivers quick termination of #8 – 2 AWG large wire insulated and non-insulated ring terminals
- Quick 4 second crimping cycle results in less time to crimp terminals compared to conventional methods
- Compact, portable, and lightweight (3.5 lbs.) construction allows simple one hand crimp capability
- Ram retracts automatically to signal crimp is complete
- Retractable slide button allows ram to retract in mid-cycle for manual adjustment of terminals
- Snap in crimp die provides quick change of Panduit interchangeable crimp dies without the use of tools
- 360° rotating, crimp head design allows use in limited space areas



CT-2600



CT-2500BC

| Part Number              | Part Description   | Std. Pkg. Qty. |
|--------------------------|--|----------------|
| <b>Crimping Tools</b>    |  |                |
| CT-2600                  | Crimps Panduit tin and nickel plated #8 – 2 AWG high temperature large wire, non-insulated, vinyl and KYNAR® insulated ring terminals. Includes tool with crimp head, two battery cartridges (CT-2500BC), battery charger (CT-2500CHR) and molded carrying case (CT-2500CASE). These parts are also compatible with the CT-2500. Crimp dies not included. Meets U.S. voltage requirements.         | 1              |
| CT-2600/E                | Crimps Panduit tin and nickel plated #8 – 2 AWG high temperature large wire, non-insulated, vinyl and KYNAR® insulated ring terminals. Includes tool with crimp head, two battery cartridges (CT-2500BC), battery charger (CT-2500CHR/E) and molded carrying case (CT-2500CASE). These parts are also compatible with the CT-2500/E. Crimp dies not included. Meets European voltage requirements. | 1              |
| <b>Crimp Die Inserts</b> |  |                |
| CD-2600-P8               | Used with CT-2600 to install Panduit P8 and P8-RHT6 series large wire, high temperature, non-insulated ring terminals.   | 1              |
| CD-2600-P6               | Used with CT-2600 to install Panduit P6 and P6-RHT6 series large wire, high temperature, non-insulated ring terminals.   | 1              |
| CD-2600-P4               | Used with CT-2600 to install Panduit P4 and P4-RHT6 series large wire, high temperature, non-insulated ring terminals.   | 1              |
| CD-2600-P2               | Used with CT-2600 to install Panduit P2 and P2-RHT6 series large wire, high temperature, non-insulated ring terminals.   | 1              |
| CD-2600-PV8              | Used with CT-2600 to install Panduit PV8 and PK8 series large wire, vinyl and KYNAR® insulated ring terminals.   | 1              |
| CD-2600-PV6              | Used with CT-2600 to install Panduit PV6 and PK6 series large wire, vinyl and KYNAR® insulated ring terminals.   | 1              |
| CD-2600-PV4              | Used with CT-2600 to install Panduit PV4 and PK4 series large wire, vinyl and KYNAR® insulated ring terminals.   | 1              |
| CD-2600-PV2              | Used with CT-2600 to install Panduit PV2 and PK2 series large wire, vinyl and KYNAR® insulated ring terminals.   | 1              |
| <b>Accessories</b>       |  |                |
| CT-2500CHR               | U.S. compatible battery charger for use with the CT-2500 and the CT-2600.  | 1              |
| CT-2500CHR/E             | European compatible battery charger for use with the CT-2500/E and CT-2600/E.  | 1              |
| CT-2500BC                | Rechargeable tool battery for use with the CT-2500 and CT-2600.  | 1              |

®KYNAR is a registered trademark of Atofina Chemicals, Inc.

A. System Overview

B1. Cable Ties

B2. Cable Accessories

B3. Stainless Steel Ties

C1. Wiring Duct

C2. Surface Raceway

C3. Abrasion Protection

C4. Cable Management

D1. Terminals

D2. Power Connectors

D3. Grounding Connectors

E1. Labeling Systems

E2. Labels

E3. Pre-Printed & Write-On Markers

E4. Permanent Identification

E5. Lockout/Tagout & Safety Solutions

F. Index





## Tooling Selection Guide for Panduit Terminals, Splices, and Disconnects (continued)

| Panduit Terminal Series | Terminal Description  | Std. Wire Range (AWG) | Wire Strip Length (In.) | Plier Tools |        |        |        | Controlled Cycle Hand Tools |          |        |        |        |         |         |         |         |         |         |         | Crimp Heads for Pneumatic CT-600-A Tool |         |          |          |          |          |
|-------------------------|---|-----------------------|-------------------------|-------------|--------|--------|--------|-----------------------------|----------|--------|--------|--------|---------|---------|---------|---------|---------|---------|---------|---|---------|----------|----------|----------|----------|
|                         |   |                       |                         | CT-100A     | CT-160 | CT-200 | CT-260 | CT-720                      | CT-300-1 | CT-310 | CT-400 | CT-460 | CT-1014 | CT-1015 | CT-1525 | CT-1550 | CT-1551 | CT-1570 | CT-1701 | CT-2500                                 | CT-2600 | CT-500CH | CT-520CH | CT-550CH | CT-570CH |
|                         |   |                       |                         |             |        |        |        |                             |          |        |        |        |         |         |         |         |         |         |         |   |         |          |          |          |          |
| DNF-M                   | Nylon insulated, funnel entry, barrel insulated, male disconnects                   | 22-18                 | 9/32                    | X           | X      |        | X      |                             |          |        |        |        |         |         | X       | X       |         |         | X       |   | X       |          | X        |          |          |
|                         |   | 16-14                 | 9/32                    | X           | X      |        | X      |                             |          |        |        |        |         |         | X       | X       |         |         | X       |   | X       |          | X        |          |          |
|                         |   | 12-10                 | 9/32                    | X           | X      |        | X      |                             |          |        | X      |        |         |         | X       | X       |         |         | X       |   |         |          | X        |          |          |
| DNFR-B                  | Nylon pre-insulated, right angle disconnects  | 22-18                 | 9/32                    | X           |        |        |        |                             |          |        |        |        |         | X       |         |         |         |         |         |   |         |          |          |          |          |
|                         |   | 16-14                 | 9/32                    | X           |        |        |        |                             |          |        |        |        |         | X       |         |         |         |         |         |   |         |          |          |          |          |
| DNFR-FIB                | Nylon butted seam, right angle disconnects  | 22-18                 | 11/32                   |             |        |        |        |                             | X        |        |        |        |         |         |         |         |         |         |         |   |         |          |          |          |          |
|                         |   | 16-14                 | 11/32                   |             |        |        |        |                             | X        |        |        |        |         |         |         |         |         |         |         |   |         |          |          |          |          |
| DNG-FB                  | Supra Grip™ Nylon, Fully Insulated Disconnects (except DNG14-187FB and DNG14-188FB) | 22-18                 | 1/4                     |             |        |        |        |                             |          |        |        |        |         | X       |         |         |         |         |         |   |         |          |          |          |          |
|                         |   | 16-14                 | 1/4                     |             |        |        |        |                             |          |        |        |        |         | X       |         |         |         |         |         |   |         |          |          |          |          |
| DNG-FL                  | Disco-Lok™ Nylon, Fully Insulated Disconnects                                       | 22-18                 | 1/4                     |             |        |        |        |                             |          |        |        |        |         | X       |         |         |         |         |         |   |         |          |          |          |          |
|                         |   | 16-14                 | 1/4                     |             |        |        |        |                             |          |        |        |        |         | X       |         |         |         |         |         |   |         |          |          |          |          |
| DNH                     | Heat shrink disconnects   | 22-18                 | 5/16                    |             |        |        |        |                             | X        |        |        |        |         |         |         |         |         |         |         |   |         |          |          |          |          |
|                         |   | 16-14                 | 5/16                    |             |        |        |        |                             | X        |        |        |        |         |         |         |         |         |         |         |   |         |          |          |          |          |
|                         |   | 12-10                 | 5/16                    |             |        |        |        |                             | X        |        |        |        |         |         |         |         |         |         |         |   |         |          |          |          |          |
| DV                      | Vinyl barrel insulated sleeved disconnects  | 12-10                 | 9/32                    | X           |        |        |        |                             |          |        |        |        |         | X       | X       |         |         | X       |         |   |         | X        |          |          |          |
| DV-B                    | Vinyl insulated, butted seam disconnects  | 22-18                 | 1/4                     | X           |        |        |        |                             |          |        |        |        |         | X       |         |         |         | X       |         |   |         | X        |          |          |          |
|                         |   | 16-14                 | 1/4                     | X           |        |        |        |                             |          |        |        |        |         | X       |         |         |         | X       |         |   |         | X        |          |          |          |
| DV-M                    | Vinyl barrel insulated male blade adapters  | 22-18                 | 9/32                    | X           | X      |        | X      |                             |          | X      |        |        |         | X       | X       |         |         | X       |         | X                                       |         | X        | X        |          |          |
|                         |   | 16-14                 | 9/32                    | X           | X      |        | X      |                             |          | X      | X      |        |         | X       | X       |         |         | X       |         | X                                       |         | X        | X        |          |          |
| DV-M                    | Vinyl insulated male disconnects  | 12-10                 | 9/32                    | X           |        |        | X      |                             |          |        |        |        |         |         |         |         |         |         |         |   |         | X        |          |          |          |
| DV-MB                   | Vinyl insulated butted seam male disconnects  | 22-18                 | 9/32                    | X           |        |        |        |                             |          | X      |        |        |         | X       |         |         |         | X       |         | X                                       |         | X        | X        |          |          |
|                         |   | 16-14                 | 9/32                    | X           |        |        |        |                             |          | X      | X      |        |         | X       |         |         |         | X       |         | X                                       |         | X        | X        |          |          |
| DV-P                    | Vinyl insulated piggyback disconnects   | 22-18                 | 1/4                     | X           | X      |        | X      |                             |          |        |        |        |         | X       | X       |         |         | X       |         | X                                       |         | X        | X        |          |          |
|                         |   | 16-14                 | 1/4                     | X           | X      |        | X      |                             |          |        |        |        |         | X       | X       |         |         | X       |         | X                                       |         | X        | X        |          |          |
| DVF                     | Vinyl funnel entry barrel insulated female disconnect                               | 22-18                 | 9/32                    |             |        |        |        |                             |          |        |        |        |         | X       | X       |         |         | X       |         | X                                       |         | X        | X        |          |          |
|                         |   | 16-14                 | 9/32                    |             |        |        |        |                             |          |        |        |        |         | X       | X       |         |         | X       |         | X                                       |         | X        | X        |          |          |
| J                       | Non-insulated wire joints   | J214-312              | 14-12                   | 1/2         | X      |        | X      |                             |          |        |        |        |         |         |         |         |         |         |         |   |         |          |          |          |          |
|                         |   | J318-412              | 18-12                   | 1/2         | X      |        | X      |                             |          |        |        |        |         |         |         |         |         |         |         |   |         |          |          |          |          |
|                         |   | J216-410              | 16-10                   | 3/4         |        |        |        | X                           |          |        |        |        |         |         |         |         |         |         |         |   |         |          |          |          |          |
|                         |   | JN224-318             | 24-16                   | 7/16        | X      | X      |        | X                           |          |        | X      |        |         |         | X       | X       |         |         | X       |   | X       |          | X        |          |          |
| JN                      | Nylon insulated wire joints   | JN218-216             | 22-16                   | 7/16        | X      | X      |        |                             |          | X      |        |        |         | X       | X       |         |         | X       |         | X                                       |         | X        |          |          |          |
|                         |   | JN418-212             | 18-12                   | 1/2         | X      | X      |        |                             |          |        | X      |        |         | X       | X       |         |         | X       |         | X                                       |         | X        |          |          |          |
|                         |   | JN314-412             | 14-12                   | 5/8         |        | X      |        |                             |          |        |        |        |         |         |         |         |         |         |         |   |         |          |          |          |          |
|                         |   | JN224-318             | 24-16                   | 7/16        | X      | X      |        | X                           |          |        | X      |        |         |         | X       | X       |         |         | X       |   | X       |          | X        |          |          |
| P-HDR                   | Non-insulated heavy duty rings  | 16-12                 | 9/32                    | X           |        | X      | X      |                             |          |        |        |        |         |         |         |         | X       | X       | X       |   |         |          | X        |          |          |
| P-P                     | Non-insulated pin terminals   | 22-18                 | 9/32                    | X           | X      | X      | X      |                             |          |        |        |        |         |         |         |         |         | X       |         | X                                       |         |          | X        |          |          |
|                         |   | 16-14                 | 9/32                    | X           | X      | X      | X      |                             |          |        |        |        |         |         |         |         |         | X       |         | X                                       |         |          | X        |          |          |
|                         |   | 12-10                 | 9/32                    | X           | X      | X      | X      |                             |          |        |        |        |         |         |         |         |         | X       | X       | X                                       |         |          | X        |          |          |
| P-R                     | Non-insulated large ring terminals  | 8                     | 3/8                     |             |        |        |        |                             |          |        |        |        |         |         |         |         |         |         | X       |   |         |          |          |          |          |
|                         |   | 6                     | 7/16                    |             |        |        |        |                             |          |        |        |        |         |         |         |         |         |         | X       |   |         |          |          |          |          |
|                         |   | 4                     | 1/2                     |             |        |        |        |                             |          |        |        |        |         |         |         |         |         |         | X       |   |         |          |          |          |          |
|                         |   | 2                     | 1/2                     |             |        |        |        |                             |          |        |        |        |         |         |         |         |         |         | X       |   |         |          |          |          |          |

Tool/product approved combinations indicated on individual product pages.

Table continues on page D1.92

A. System Overview

B1. Cable Ties

B2. Cable Accessories

B3. Stainless Steel Ties

C1. Wiring Duct

C2. Surface Raceway

C3. Abrasion Protection

C4. Cable Management

D1. Terminals

D2. Power Connectors

D3. Grounding Connectors

E1. Labeling Systems

E2. Labels

E3. Pre-Printed & Write-On Markers

E4. Permanent Identification

E5. Lockout/Tagout & Safety Solutions

F. Index



## Tooling Selection Guide for Panduit Tubular Ring Terminals

| Tooling                    | CT-1700  | CT-720                 | CT-930, CT-930CH,<br>CT-920, CT-920CH,<br>CT-2920, CT-940CH | CT-980, CT-980CH,<br>CT-2950, CT-2980 | CT-2001                   |
|----------------------------|--|------------------------|---|---------------------------------------|---------------------------|
| <b>Panduit Part Number</b> | <b>Panduit Die Part Number<br/>Die Index Number<br/>(Number of Crimps)</b> |                        |   |                                       |                           |
| S8-10R-Q                   | P21<br>(2)   | CD-720-1<br>P21<br>(1) | CD-920-8<br>P21<br>(1)                                      | —                                     | CD-2001-8<br>P21<br>(1)   |
| S8-14R-Q                   |  |                        |   |                                       |                           |
| S8-56R-Q                   |  |                        |   |                                       |                           |
| S8-38R-Q                   |  |                        |   |                                       |                           |
| S6-10R-E                   | P24<br>(2)   | CD-720-1<br>P24<br>(1) | CD-920-6<br>P24<br>(1)                                      | —                                     | CD-2001-6<br>P24<br>(1)   |
| S6-14R-E                   |  |                        |   |                                       |                           |
| S6-56R-E                   |  |                        |   |                                       |                           |
| S6-38R-E                   |  |                        |   |                                       |                           |
| S4-10R-E                   | P29<br>(2)   | CD-720-1<br>P29<br>(1) | CD-920-4<br>P28<br>(1)                                      | STD<br>(1)                            | CD-2001-4<br>P29<br>(1)   |
| S4-14R-E                   |  |                        |   |                                       |                           |
| S4-56R-E                   |  |                        |   |                                       |                           |
| S4-38R-E                   |  |                        |   |                                       |                           |
| S2-10R-X                   | P37<br>(3)   | CD-720-2<br>P37<br>(1) | CD-920-1<br>P37<br>(1)                                      | STD<br>(1)                            | CD-2001-1<br>P37<br>(1)   |
| S2-14R-X                   |  |                        |   |                                       |                           |
| S2-56R-X                   |  |                        |   |                                       |                           |
| S2-38R-X                   |  |                        |   |                                       |                           |
| S2-12R-X                   | —  | CD-720-2<br>P42<br>(1) | CD-920-1/0<br>P42<br>(1)                                    | STD<br>(1)                            | CD-2001-1/0<br>P42<br>(1) |
| S1/0-14R-X                 |  |                        |   |                                       |                           |
| S1/0-56R-X                 |  |                        |   |                                       |                           |
| S1/0-38R-X                 |  |                        |   |                                       |                           |
| S1/0-12R-X                 | —  | CD-720-2<br>P45<br>(2) | CD-920-2/0<br>P45<br>(1)                                    | STD<br>(1)                            | CD-2001-2/0<br>P45<br>(2) |
| S2/0-14R-X                 |  |                        |   |                                       |                           |
| S2/0-56R-X                 |  |                        |   |                                       |                           |
| S2/0-38R-X                 |  |                        |   |                                       |                           |
| S2/0-76R-X                 | —  | CD-720-2<br>P50<br>(2) | CD-920-3/0<br>P50<br>(1)                                    | STD<br>(1)                            | CD-2001-3/0<br>P50<br>(2) |
| S2/0-12R-X                 |  |                        |   |                                       |                           |
| S3/0-14R-5                 |  |                        |   |                                       |                           |
| S3/0-56R-5                 |  |                        |   |                                       |                           |
| S3/0-38R-5                 | —  | CD-720-2<br>P50<br>(2) | CD-920-3/0<br>P50<br>(1)                                    | STD<br>(1)                            | CD-2001-3/0<br>P50<br>(2) |
| S3/0-76R-5                 |  |                        |   |                                       |                           |
| S3/0-12R-5                 |  |                        |   |                                       |                           |
| S4/0-38R-5                 |  |                        |   |                                       |                           |
| S4/0-76R-5                 | —  | CD-720-3<br>P54<br>(2) | CD-920-4/0<br>P54<br>(1)                                    | STD<br>(1)                            | CD-2001-4/0<br>P54<br>(2) |
| S4/0-12R-5                 |  |                        |   |                                       |                           |
| S250-56R-5                 |  |                        |   |                                       |                           |
| S250-38R-5                 |  |                        |   |                                       |                           |
| S250-76R-5                 | —  | CD-720-3<br>P62<br>(2) | CD-920-250<br>P62<br>(1)                                    | STD<br>(1)                            | CD-2001-250<br>P62<br>(2) |
| S250-12R-5                 |  |                        |   |                                       |                           |

A.  
System  
Overview

B1.  
Cable Ties

B2.  
Cable  
Accessories

B3.  
Stainless  
Steel Ties

C1.  
Wiring  
Duct

C2.  
Surface  
Raceway

C3.  
Abrasion  
Protection

C4.  
Cable  
Management

D1.  
Terminals

D2.  
Power  
Connectors

D3.  
Grounding  
Connectors

E1.  
Labeling  
Systems

E2.  
Labels

E3.  
Pre-Printed  
& Write-On  
Markers

E4.  
Permanent  
Identification

E5.  
Lockout/  
Tagout  
& Safety  
Solutions

F.  
Index

A.  
System  
Overview

B1.  
Cable Ties

B2.  
Cable  
Accessories

B3.  
Stainless  
Steel Ties

C1.  
Wiring  
Duct

C2.  
Surface  
Raceway

C3.  
Abrasion  
Protection

C4.  
Cable  
Management

D1.  
Terminals

D2.  
Power  
Connectors

D3.  
Grounding  
Connectors

E1.  
Labeling  
Systems

E2.  
Labels

E3.  
Pre-Printed  
& Write-On  
Markers

E4.  
Permanent  
Identification

E5.  
Lockout/  
Tagout  
& Safety  
Solutions

F.  
Index

## Tooling Selection Guide for Panduit Ferrules

| Panduit Ferrule Series | Ferrule Description  | Wire Range (AWG) | Wire Range (mm²)  | Wire Strip Length                              | Controlled Cycle Hand Tools |             |         |         |         |         |         |         |   |  |   |
|------------------------|--|------------------|---|--|-----------------------------|-------------|---------|---------|---------|---------|---------|---------|---|--|---|
|                        |  |                  |   |  | CT-1000                     | CT-1002     | CT-1003 | CT-1004 | CT-1005 | CT-1006 | CT-1104 | CT-1123 |   |  |   |
| F                      | Non-insulated ferrules   | 24               | 0.25  | Please See Ferrule Tables – Pgs. D1.73 – D1.77 |                             | X           | X       |         |         |         |         |         |   |  |   |
|                        |  | 22 – 18          | 0.50 – 1.00   |  |                             | X           | X       |         |         |         |         | X       |   |  |   |
|                        |  | 16               | 1.50  |  |                             | X           | X       |         |         |         |         | X       |   |  |   |
|                        |  | 14               | 2.50  |  |                             | X           | X       |         |         |         |         |         |   |  |   |
|                        |  | 12               | 4.00  |  |                             | X           | X       |         |         |         |         | X       |   |  |   |
|                        |  | 10               | 6.00  |  |                             | X           | X       |         |         |         |         | X       |   |  |   |
|                        |  | 8                | 10.0  |  |                             |             |         | X       | X       |         |         | X       |   |  |   |
|                        |  | 6                | 16.0  |  |                             |             |         | X       | X       |         |         | X       |   |  |   |
|                        |  | 4 – 2            | 25.0 – 35.0   |  |                             |             |         |         |         |         | X       |         | X |  |   |
|                        |  | 1                | 50.0  |  |                             |             |         |         |         |         | X       |         |   |  |   |
|                        |  | FSD, FSF         | Insulated single wire ferrules (DIN or French color code) |  | 26 – 18                     | 0.41 – 1.00 |         | X       | X       |         |         |         |   |  | X |
|                        |  |                  |   |  | 16 – 14                     | 1.50 – 2.00 |         | X       | X       |         |         |         |   |  | X |
|                        |  |                  |   |  | 12 – 10                     | 4.00 – 6.00 |         | X       | X       |         |         |         |   |  | X |
| 8                      | 10.0   |                  |   |  |                             | X           | X       |         |         |         | X       | X       |   |  |   |
| 6                      | 16.0   |                  |   |  |                             | X           | X       |         |         |         | X       |         |   |  |   |
| 4 – 2                  | 25.0 – 35.0  |                  |   |  |                             |             |         |         | X       |         |         |         |   |  |   |
| 1                      | 50.0   |                  |   |  |                             |             |         |         |         | X       |         |         |   |  |   |
| FTD                    | Insulated twin wire ferrules   | 22 – 18          | 0.50 – 1.00   |  | X                           | X           |         |         |         |         |         | X       |   |  |   |
|                        |  | 16 – 14          | 1.50 – 2.00   |  | X                           | X           |         |         |         |         |         | X       |   |  |   |
|                        |  | 12               | 4.00  |  |                             | X           | X       |         |         |         |         | X       |   |  |   |
|                        |  | 10               | 6.00  |  |                             | X           | X       |         |         |         | X       |         |   |  |   |
| FSD-DSL<br>FS-DSL      | Insulated single wire ferrules on strips of 50 (DIN or other color code) | 20 – 14          | 0.50 – 2.50   | 0.31" (8mm)                                    | X                           |             |         |         |         |         |         |         |   |  |   |

## Technical Specification and Selection Information

The following pages provide information helpful in specifying Panduit terminals and selecting the appropriate terminal and tooling for your applications.



### Panduit Terminal Approvals

| Logo (Symbol) | Agency   | Spec/Approval   | Requirement   | Applicable Products  |
|---------------|--|---|---|--|
|               | Underwriters Laboratories, Inc.                          | #E52164 – UL 486A   | Minimum tensile strength (pull out force for the crimp terminal) and test current for max. 50°C rise (amps)   | All Ring and Fork Terminals  |
|               |  | #E78522 – UL 310  | Minimum tensile strength (pull out force for the crimp terminal) and continuous test current for max. 30°C rise (amps) (for .187", .205", .250" tab widths) and (.110" tab width) | All Disconnects  |
|               |  | #E52164 – UL 486C   | Minimum tensile strength (pull out force for the crimp terminal) and test current for max. 50°C rise (amps)   | All Splices  |
|               | Canadian Standards Association                           | #LR31212 – C22.2 No. 65   | Minimum tensile Strength (pull out force for the crimp terminal) and test current for max. 50°C rise (amps)   | All Ring and Fork Terminals  |
|               |  | #LR31212 – C22.2 No. 153  |   | All Disconnects  |
|               | American Bureau of Shipping                              | ABS Rules, Steel Vessel Rules 1-1-4/7.7, 4-8-3/9.19, 4-8-4/21.28                      | Passed extensive testing requirements to verify that product will perform reliably in marine and offshore environments  | Fork Terminals: P-F, PN-F, PV-F, PN-LF, PNF-LF, PV-LF, P-LF<br>Ring Terminals: P-R, PN-R, PNF-R, RV-R, S-R<br>Wire Joints: JN224-318, JN218-216, JN418-212<br>Splices: BSN, BSV, BS<br>Disconnects: DNF, DNF-FIB, DVF, D, DNF-FL, DNF-M, DNF18-250M, DNF14-250M, DNF18-250FIM, FIMB, FIB, 14-250FIM, FIMB, FIB |
| <b>DFARS</b>  | U.S. Code, Title 10, Section 2533a                       | The Berry Amendment 252.225-7014 for Specialty Metals                                 | Bans the use of various metals manufactured outside of the United States  | All Ring, Fork, Pin and Blade Terminals, Splices, Ferrules, Wire Joints and Disconnects  |
|               | IEEE (Institute of Electrical and Electronics Engineers) | IEEE std 323-2003 for Qualifying Class 1E Eqpt. for Nuclear Power Generating Stations | Meets criteria for use in harsh, high radiation environments in nuclear power plants  | ■KYNAR Ring Terminals  |
|               | Dept. of Defense   | Mil Spec Qualification Test Ref #01017302.AB/08-31-2006                               | Approved for listing on QPL AS 7928 Class I and Class II  | Ring Terminals   |

■KYNAR is a registered trademark of Atofina Chemicals, Inc.

A. System Overview

B1. Cable Ties

B2. Cable Accessories

B3. Stainless Steel Ties

C1. Wiring Duct

C2. Surface Raceway

C3. Abrasion Protection

C4. Cable Management

D1. Terminals

D2. Power Connectors

D3. Grounding Connectors

E1. Labeling Systems

E2. Labels

E3. Pre-Printed & Write-On Markers

E4. Permanent Identification

E5. Lockout/Tagout & Safety Solutions

F. Index

A. System Overview

## Performance Requirements

B1. Cable Ties

|  | Wire Size (AWG) |     |     |     |     |     |     |     |     |
|--|-----------------|-----|-----|-----|-----|-----|-----|-----|-----|
|  | #26             | #24 | #22 | #20 | #18 | #16 | #14 | #12 | #10 |

### UL 486A (TERMINALS), UL 310 (MALE BLADE ADAPTERS)

|  |     |   |   |    |    |    |    |    |    |
|--|-----|---|---|----|----|----|----|----|----|
| Test Current for Max. 50°C Rise (Amps) | 3.5 | 7 | 9 | 12 | 17 | 18 | 30 | 35 | 50 |
| Min. Tensile Strength* (Lbs.)          | 3   | 5 | 8 | 13 | 20 | 30 | 50 | 70 | 80 |

### UL 486C (SPLICES)

|  |     |   |   |    |    |    |    |    |    |
|--|-----|---|---|----|----|----|----|----|----|
| Test Current for Max. 50°C Rise (Amps) | 5.5 | 7 | 9 | 12 | 17 | 18 | 30 | 35 | 50 |
| Min. Tensile Strength* (Lbs.)          | 3   | 5 | 8 | 10 | 10 | 15 | 25 | 35 | 40 |

\*Pull-out force of the crimped terminal.

Applicable Pan-Term® products meet or exceed the following test specifications:

- UL 486A (Terminals)
- UL 486C (Splices)
- UL 310 (Blade Adapters)
- CSA C22.2 No. 65 (all designs)

UL and CSA approved products are shown with the applicable logos in the product section. UL file #E52164, CSA File #LR31212.

C1. Wiring Duct

C2. Surface Raceway

|  | Wire Size (AWG) |     |     |     |      |     |     |
|--|-----------------|-----|-----|-----|------|-----|-----|
|  | #22             | #20 | #18 | #16 | *#14 | #12 | #10 |

### UL 310 (DISCONNECTS)

|   |   |    |    |    |                |    |    |
|---|---|----|----|----|----------------|----|----|
| Continuous Test Current for Max. 30°C Rise (amps) (for 187", 205", 250" tab widths) | 3 | 4  | 7  | 10 | 15             | 20 | 24 |
| Continuous Test Current for Max. 30°C Rise (amps) (for .110", tab width)            | 2 | 3  | 4  | 5  | Not Applicable |    |    |
| Min. Tensile Strength* (Lbs.)   | 8 | 13 | 20 | 30 | 50             | 70 | 80 |

\*Pull-out force of the crimped disconnect.

Applicable Pan-Term® products meet or exceed the following test specifications:

- UL 310 (Disconnects)
- CSA C22.2 No. 153 (all designs)

UL and CSA Listed products are shown with the applicable logos in the product section. UL file #E78522 and CSA file #LR31212.

C4. Cable Management

D1. Terminals

## Panduit® Pan-Term® Terminal Military Cross Reference

|                                       | Current Mil. Std Part No., Class 1 | Ring Terminals Nylon Insulated | Current Mil. Std. Part No., Class 2 | Ring Terminals, Nylon Insulated or Nylon Insulated with Funnel Entry | Current Mil. Std. Part No., Class 1 | Ring Terminals Non-Insulated |
|---------------------------------------|------------------------------------|--------------------------------|-------------------------------------|--|-------------------------------------|------------------------------|
| D2. Power Connectors                  | MS25036-101                        | PN18-6RN                       | MS25036-101                         | PN18-6RN or PNF18-6RN  | MS20659-165                         | P10-6R                       |
| D3. Grounding Connectors              | MS25036-102                        | PN18-6R                        | MS25036-102                         | PN18-6R or PNF18-6R  | MS20659-105                         | P10-10R                      |
|                                       | MS25036-103                        | PN18-10R                       | MS25036-103                         | PN18-10R or PNF18-10R  | MS20659-106                         | P10-56R                      |
|                                       | MS25036-104                        | PN18-56R                       | MS25036-104                         | PN18-56R or PNF18-56R  | MS20659-128                         | P10-38R                      |
|                                       | MS25036-105                        | PN18-38R                       | MS25036-105                         | PN18-38R or PNF18-38R  |                                     |                              |
| E1. Labeling Systems                  | MS25036-106                        | PN14-6RN                       | MS25036-106                         | PN14-6RN or PNF14-6RN  |                                     |                              |
|                                       | MS25036-107                        | PN14-6R                        | MS25036-107                         | PN14-6R or PNF14-6R  |                                     |                              |
|                                       | MS25036-108                        | PN14-10R                       | MS25036-108                         | PN14-10R or PNF14-10R  |                                     |                              |
|                                       | MS25036-109                        | PN14-56R                       | MS25036-109                         | PN14-56R or PNF14-56R  |                                     |                              |
| E2. Labels                            | MS25036-110                        | PN14-38R                       | MS25036-110                         | PN14-38R or PNF14-38R  |                                     |                              |
|                                       | MS25036-111                        | PN10-6R                        | MS25036-111                         | PN10-6R or PNF10-6R  |                                     |                              |
|                                       | MS25036-112                        | PN10-10R                       | MS25036-112                         | PN10-10R or PNF10-10R  |                                     |                              |
|                                       | MS25036-113                        | PN10-56R                       | MS25036-113                         | PN10-56R or PNF10-56R  |                                     |                              |
| E3. Pre-Printed & Write-On Markers    | MS25036-114                        | PN10-38R                       | MS25036-114                         | PN10-38R or PNF10-38R  |                                     |                              |
|                                       | MS25036-148                        | PN18-4RN                       | MS25036-148                         | PN18-4RN or PNF18-4RN  |                                     |                              |
|                                       | MS25036-149                        | PN18-8R                        | MS25036-149                         | PN18-8R or PNF18-8R  |                                     |                              |
| E4. Permanent Identification          | MS25036-150                        | PN18-14R                       | MS25036-150                         | PN18-14R or PNF18-14R  |                                     |                              |
|                                       | MS25036-152                        | PN14-4R                        | MS25036-152                         | PN14-4R or PNF14-4R  |                                     |                              |
|                                       | MS25036-153                        | PN14-8R                        | MS25036-153                         | PN14-8R or PNF14-8R  |                                     |                              |
| E5. Lockout/Tagout & Safety Solutions | MS25036-154                        | PN14-14R                       | MS25036-154                         | PN14-14R or PNF14-14R  |                                     |                              |
|                                       | MS25036-156                        | PN10-8R                        | MS25036-156                         | PN10-8R or PNF10-8R  |                                     |                              |
|                                       | MS25036-157                        | PN10-14R                       | MS25036-157                         | PN10-14R or PNF10-14R  |                                     |                              |
| F. Index                              | Crimping Tools: CT-400 and CT-460  |                                |                                     |  |                                     |                              |



## Stud Size Chart (Inches/Millimeters)

|  |  |  |  |  |  |  |  |  |  |  |
|--|---|---|---|---|---|---|--|---|---|---|
| Standard Stud Size                           | #2  | #4  | #5  | #6  | #8  | #10   | 1/4"   | 5/16"   | 3/8"  | 7/16"   |
| Metric Stud Size (mm)                        | M2  | M2.5  | M3  | M.35  | M4  | M5  | M6   | M8  | M10   | M11   |
| Stud Size Decimal Equivalent                 | .086"   | .112"   | .127"   | .138"   | .164"   | .190"   | .250"  | .312"   | .375"   | .438"   |
| Metric Diameter (mm)                         | 2.18  | 2.84  | 3.18  | 3.51  | 4.17  | 4.83  | 6.35   | 7.92  | 9.53  | 11.13   |
| Terminal Hole Diameter                       | .090"   | .118"   | .130"   | .147"   | .173"   | .204"   | .270"  | .343"   | .392**<br>.406***   | .456"   |
| Terminal Hole Diameter Metric (mm)           | 2.29  | 3.0   | 3.23  | 3.71  | 4.39  | 5.18  | 6.86   | 8.71  | 9.78  | 11.58   |
| Stud Size Designation in Panduit Part Number | 2   | 4   | 5   | 6   | 8   | 10  | 14   | 56  | 38  | 76  |

\*Terminal stud.

\*\*Power Connector stud.

|  |  |  |  |  |  |
|--|--|--|--|---|--|
| Standard Stud Size                           | 1/2"   | 5/8"   | 3/4"   | 7/8"  | 1"   |
| Metric Stud Size (mm)                        | M12  | M16  | M18  | M20   | M25  |
| Stud Size Decimal Equivalent                 | .500"  | .625"  | .750"  | .875"   | 1.00"  |
| Metric Diameter (mm)                         | 12.7   | 15.88  | 19.05  | 22.23   | 25.4   |
| Terminal Hole Diameter                       | .531"  | .656"  | .810"  | .906"   | 1.031"   |
| Terminal Hole Diameter Metric (mm)           | 13.49  | 16.66  | 20.57  | 23.01   | 26.19  |
| Stud Size Designation in Panduit Part Number | 12   | 58   | 34   | 78  | 1  |

Note: Stud hole diagrams are for U.S. reference only.

A.  
System  
Overview

B1.  
Cable Ties

B2.  
Cable  
Accessories

B3.  
Stainless  
Steel Ties

C1.  
Wiring  
Duct

C2.  
Surface  
Raceway

C3.  
Abrasion  
Protection

C4.  
Cable  
Management

D1.  
Terminals

D2.  
Power  
Connectors

D3.  
Grounding  
Connectors

E1.  
Labeling  
Systems

E2.  
Labels

E3.  
Pre-Printed  
& Write-On  
Markers

E4.  
Permanent  
Identification

E5.  
Lockout/  
Tagout  
& Safety  
Solutions











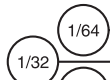



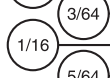
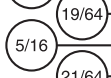
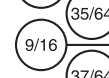
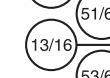
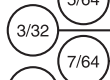
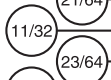

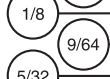
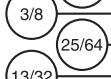





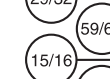
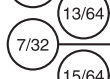
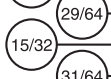
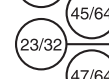
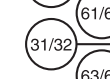
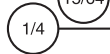
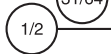

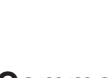





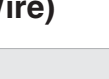

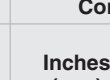

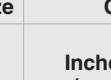

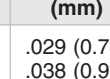

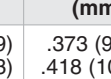

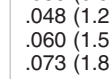

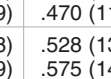

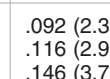
F.  
Index

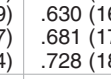
A. System Overview

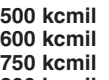
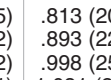
## Equivalent Tables

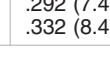
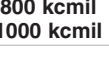
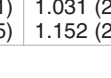
B1. Cable Ties

### Decimal/Inches/Millimeters

|   |       |       |   |       |        |   |       |        |   |       |        |
|---|-------|-------|---|-------|--------|---|-------|--------|---|-------|--------|
|    | .0156 | 0,396 |    | .2656 | 6,746  |    | .5156 | 13,100 |    | .7656 | 19,446 |
|    | 0.312 | 0,792 |    | .2812 | 7,143  |    | .5312 | 13,492 |    | .7812 | 14,842 |
|    | .0468 | 1,189 |    | .2968 | 7,541  |    | .5468 | 13,891 |    | .7968 | 20,241 |
|    | .0625 | 1,588 |    | .3125 | 7,938  |    | .5625 | 14,288 |    | .8125 | 20,637 |
|    | .0781 | 1,984 |    | .3281 | 8,337  |    | .5781 | 14,684 |    | .8281 | 21,034 |
|    | .0937 | 2,380 |    | .3437 | 8,730  |    | .5937 | 15,080 |    | .8437 | 21,480 |
|    | .1093 | 2,779 |    | .3593 | 9,129  |    | .6093 | 15,479 |    | .8593 | 21,828 |
|    | .125  | 3,175 |    | .375  | 9,525  |    | .625  | 15,875 |    | .875  | 22,225 |
|   | .1406 | 3,571 |   | .3906 | 9,921  |   | .6406 | 16,271 |   | .8906 | 22,620 |
|  | .1562 | 3,968 |  | .4062 | 10,317 |  | .6562 | 16,667 |  | .9062 | 23,017 |
|  | .1718 | 4,366 |  | .4218 | 10,716 |  | .6718 | 17,066 |  | .9218 | 23,416 |
|  | .1875 | 4,763 |  | .4375 | 11,113 |  | .6875 | 17,463 |  | .9375 | 23,810 |
|  | .2031 | 5,159 |  | .4531 | 11,509 |  | .7031 | 17,859 |  | .9531 | 24,208 |
|  | .2187 | 5,555 |  | .4687 | 11,905 |  | .7187 | 18,255 |  | .9687 | 24,605 |
|  | .2343 | 5,954 |  | .4843 | 12,304 |  | .7343 | 18,654 |  | .9843 | 25,001 |
|  | .25   | 6,350 |  | .5    | 12,700 |  | .75   | 19,050 |  | 1.    | 25,400 |

C4. Cable Management

### Common Conductor Size Chart (Stranded Wire)

| Size          | No. of Strands | Individual Strand Size |             | Conductor Size |                                    | Size | No. of Strands | Individual Strand Size |                 | Conductor Size                     |  |
|---------------|----------------|------------------------|-------------|----------------|------------------------------------|------|----------------|------------------------|-----------------|------------------------------------|--|
|               |                | Inches (mm)            | Inches (mm) | Inches (mm)    | Circle Mil Area (mm <sup>2</sup> ) |      |                | Inches (mm)            | Inches (mm)     | Circle Mil Area (mm <sup>2</sup> ) |  |
| <b>22 AWG</b> | 7              | .0096 (0.24)           | .029 (0.74) | 640 (0.324)    | <b>1/0 AWG</b>                     | 19   | .0745 (1.89)   | .373 (9.47)            | 105,600 (0.823) |                                    |  |
| <b>20 AWG</b> | 10             | .0100 (0.25)           | .038 (0.97) | 1020 (0.519)   | <b>2/0 AWG</b>                     | 19   | .0837 (2.13)   | .418 (10.62)           | 133,100 (67.43) |                                    |  |
| <b>18 AWG</b> | 16             | .0100 (0.25)           | .048 (1.22) | 1620 (0.823)   | <b>3/0 AWG</b>                     | 19   | .0940 (2.39)   | .470 (11.94)           | 167,800 (85.01) |                                    |  |
| <b>16 AWG</b> | 26             | .0100 (0.25)           | .060 (1.52) | 2580 (1.310)   | <b>4/0 AWG</b>                     | 19   | .1055 (2.68)   | .528 (13.41)           | 211,600 (107.2) |                                    |  |
| <b>14 AWG</b> | 7              | .0242 (0.61)           | .073 (1.85) | 4110 (2.080)   | <b>250 kcmil</b>                   | 37   | .0822 (2.09)   | .575 (14.61)           | 250,000 (127)   |                                    |  |
| <b>12 AWG</b> | 7              | .0305 (0.77)           | .092 (2.34) | 6530 (3.310)   | <b>300 kcmil</b>                   | 37   | .0900 (2.29)   | .630 (16.00)           | 300,000 (152)   |                                    |  |
| <b>10 AWG</b> | 7              | .0385 (0.98)           | .116 (2.95) | 10,380 (5.261) | <b>350 kcmil</b>                   | 37   | .0973 (2.47)   | .681 (17.29)           | 350,000 (177)   |                                    |  |
| <b>8 AWG</b>  | 7              | .0486 (1.23)           | .146 (3.71) | 16,510 (8.367) | <b>400 kcmil</b>                   | 37   | .1040 (2.64)   | .728 (18.49)           | 400,000 (203)   |                                    |  |
| <b>6 AWG</b>  | 7              | .0612 (1.55)           | .184 (4.67) | 26,240 (13.30) | <b>500 kcmil</b>                   | 37   | .1162 (2.95)   | .813 (20.65)           | 500,000 (253)   |                                    |  |
| <b>4 AWG</b>  | 7              | .0772 (1.96)           | .232 (5.89) | 41,740 (21.15) | <b>600 kcmil</b>                   | 61   | .0992 (2.52)   | .893 (22.68)           | 600,000 (304)   |                                    |  |
| <b>2 AWG</b>  | 7              | .0974 (2.47)           | .292 (7.42) | 66,360 (33.62) | <b>750 kcmil</b>                   | 61   | .1109 (2.82)   | .998 (25.35)           | 750,000 (380)   |                                    |  |
| <b>1 AWG</b>  | 19             | .0664 (1.69)           | .332 (8.43) | 83,690 (42.41) | <b>800 kcmil</b>                   | 61   | .1145 (2.91)   | 1.031 (26.19)          | 800,000 (405)   |                                    |  |
|               |                |                        |             |                | <b>1000 kcmil</b>                  | 61   | .1280 (3.25)   | 1.152 (29.26)          | 1,000,000 (507) |                                    |  |

E2. Labels

E3. Pre-Printed & Write-On Markers

E4. Permanent Identification

E5. Lockout/Tagout & Safety Solutions

F. Index

## Common Conductor Sizes and Strandings Reference Chart

| Conductor |                        | Individual Strands |          |       | Overall Conductor Size |       |            | Conductor |                        | Individual Strands |          |       | Overall Conductor Size |       |            |
|-----------|------------------------|--------------------|----------|-------|------------------------|-------|------------|-----------|------------------------|--------------------|----------|-------|------------------------|-------|------------|
| AWG       | Metric mm <sup>2</sup> | No.                | Diameter |       | Diameter               |       | Circ. MILS | AWG       | Metric mm <sup>2</sup> | No.                | Diameter |       | Diameter               |       | Circ. MILS |
|           |                        |                    | mm       | In.   | mm                     | In.   |            |           |                        |                    | mm       | In.   | mm                     | In.   |            |
|           | 0.05                   | 25                 | 0.05     | 0.002 | 0.25                   | 0.010 | 97         |           | 1.0                    | 19                 | 0.25     | 0.010 | 1.30                   | 0.051 | 1841       |
|           | 0.06                   | 41                 | 0.05     | 0.002 | 0.36                   | 0.014 | 159        |           |                        | 1                  | 1.13     | 0.044 | 1.13                   | 0.044 | 1979       |
| 26        |                        | 10                 | 0.13     | 0.005 | 0.53                   | 0.021 | 250        | 16        |                        | 32                 | 0.20     | 0.008 | 1.30                   | 0.051 | 1984       |
|           |                        | 1                  | 0.41     | 0.016 | 0.41                   | 0.016 | 256        |           |                        | 7                  | 0.43     | 0.017 | 1.30                   | 0.051 | 2006       |
|           |                        | 7                  | 0.16     | 0.006 | 0.48                   | 0.019 | 278        |           |                        | 19                 | 0.29     | 0.011 | 1.47                   | 0.058 | 2426       |
|           |                        | 19                 | 0.10     | 0.004 | 0.51                   | 0.020 | 304        |           |                        | 65                 | 0.16     | 0.006 | 1.50                   | 0.059 | 2580       |
| 24        |                        | 41                 | 0.08     | 0.003 | 0.58                   | 0.023 | 384        | 16        |                        | *26                | 0.25     | 0.010 | 1.50                   | 0.059 | 2600       |
|           |                        | 10                 | 0.16     | 0.006 | 0.58                   | 0.023 | 397        |           |                        | 1                  | 1.30     | 0.051 | 1.30                   | 0.051 | 2601       |
|           |                        | 1                  | 0.51     | 0.020 | 0.51                   | 0.020 | 400        |           |                        | 105                | 0.13     | 0.005 | 1.50                   | 0.059 | 2625       |
|           |                        | 7                  | 0.20     | 0.008 | 0.61                   | 0.024 | 448        |           |                        | *7                 | 0.51     | 0.020 | 1.52                   | 0.060 | 2828       |
|           | 0.25                   | 19                 | 0.13     | 0.005 | 0.61                   | 0.024 | 475        | 16        |                        | 30                 | 0.25     | 0.010 | 1.70                   | 0.067 | 2906       |
|           |                        | 65                 | 0.07     | 0.003 | 0.65                   | 0.026 | 484        |           |                        | 21                 | 0.30     | 0.012 | 1.60                   | 0.063 | 2930       |
|           |                        | 128                | 0.05     | 0.002 | 0.65                   | 0.026 | 496        |           |                        | 189                | 0.10     | 0.004 | 1.90                   | 0.075 | 2930       |
|           |                        | 32                 | 0.10     | 0.004 | 0.65                   | 0.026 | 496        |           |                        | 7                  | 0.52     | 0.020 | 1.60                   | 0.063 | 2934       |
| 22        |                        | 14                 | 0.16     | 0.006 | 0.65                   | 0.026 | 556        | 14        |                        | 1                  | 1.38     | 0.054 | 1.38                   | 0.054 | 2952       |
|           |                        | 1                  | 0.64     | 0.025 | 0.64                   | 0.025 | 625        |           |                        | 45                 | 0.16     | 0.006 | 1.85                   | 0.073 | 3786       |
|           |                        | 16                 | 0.16     | 0.006 | 0.76                   | 0.03  | 635        |           |                        | 19                 | 0.38     | 0.014 | 1.85                   | 0.073 | 3831       |
|           |                        | 26                 | 0.13     | 0.005 | 0.76                   | 0.03  | 650        |           |                        | 1                  | 1.63     | 0.064 | 1.63                   | 0.064 | 4096       |
|           | 0.38                   | 7                  | 0.25     | 0.010 | 0.76                   | 0.030 | 700        | 14        |                        | *41                | 0.25     | 0.010 | 1.85                   | 0.073 | 4100       |
|           |                        | 19                 | 0.16     | 0.006 | 0.79                   | 0.031 | 754        |           |                        | *7                 | 0.64     | 0.025 | 1.85                   | 0.073 | 4481       |
|           |                        | 48                 | 0.10     | 0.004 | 0.80                   | 0.031 | 744        |           |                        | 50                 | 0.25     | 0.010 | 2.20                   | 0.087 | 4844       |
|           |                        | 194                | 0.05     | 0.002 | 0.8                    | 0.031 | 752        |           |                        | 7                  | 0.67     | 0.026 | 2.10                   | 0.083 | 4871       |
|           | 0.5                    | 100                | 0.07     | 0.003 | 0.8                    | 0.031 | 760        | 12        |                        | 35                 | 0.30     | 0.012 | 2.20                   | 0.087 | 4883       |
|           |                        | 7                  | 0.27     | 0.011 | 0.8                    | 0.031 | 791        |           |                        | 315                | 0.10     | 0.004 | 2.20                   | 0.087 | 4883       |
|           |                        | 12                 | 0.21     | 0.008 | 0.8                    | 0.031 | 820        |           |                        | 1                  | 1.78     | 0.070 | 1.78                   | 0.070 | 4911       |
|           |                        | 21                 | 0.16     | 0.006 | 0.8                    | 0.031 | 833        |           |                        | 19                 | 0.45     | 0.018 | 2.36                   | 0.093 | 6088       |
| 20        |                        | 7                  | 0.30     | 0.012 | 0.90                   | 0.035 | 977        | 12        |                        | *65                | 0.25     | 0.010 | 2.41                   | 0.095 | 6500       |
|           |                        | 16                 | 0.20     | 0.008 | 0.90                   | 0.035 | 992        |           |                        | 165                | 0.16     | 0.006 | 2.41                   | 0.095 | 6549       |
|           |                        | 1                  | 0.80     | 0.031 | 0.80                   | 0.031 | 992        |           |                        | 1                  | 2.06     | 0.081 | 2.06                   | 0.081 | 6561       |
|           |                        | *10                | 0.25     | 0.010 | 0.89                   | 0.035 | 1000       |           |                        | *7                 | 0.81     | 0.032 | 2.44                   | 0.096 | 7168       |
|           | 0.75                   | 1                  | 0.81     | 0.032 | 0.81                   | 0.032 | 1024       | 10        |                        | 56                 | 0.30     | 0.012 | 3.10                   | 0.122 | 7812       |
|           |                        | 41                 | 0.13     | 0.005 | 0.91                   | 0.036 | 1025       |           |                        | 1                  | 2.26     | 0.089 | 2.26                   | 0.089 | 7917       |
|           |                        | 26                 | 0.16     | 0.006 | 0.91                   | 0.036 | 1032       |           |                        | 511                | 0.10     | 0.004 | 3.00                   | 0.118 | 7921       |
|           |                        | *7                 | 0.32     | 0.013 | 0.97                   | 0.038 | 1111       |           |                        | 19                 | 0.52     | 0.020 | 2.70                   | 0.106 | 7963       |
| 18        |                        | 19                 | 0.20     | 0.008 | 0.94                   | 0.037 | 1216       | 10        |                        | 37                 | 0.40     | 0.016 | 2.92                   | 0.115 | 9354       |
|           |                        | 7                  | 0.37     | 0.015 | 1.10                   | 0.043 | 1485       |           |                        | 49                 | 0.36     | 0.014 | 2.95                   | 0.116 | 9880       |
|           |                        | 24                 | 0.20     | 0.008 | 1.20                   | 0.047 | 1488       |           |                        | *7                 | 0.98     | 0.039 | 2.95                   | 0.116 | 10376      |
|           |                        | 1                  | 1.00     | 0.039 | 1.00                   | 0.039 | 1550       |           |                        | 1                  | 2.59     | 0.102 | 2.59                   | 0.102 | 10404      |
|           | 0.75                   | *16                | 0.25     | 0.010 | 1.19                   | 0.047 | 1600       | 10        |                        | *105               | 0.25     | 0.010 | 2.95                   | 0.116 | 10500      |
|           |                        | 1                  | 1.02     | 0.040 | 1.02                   | 0.040 | 1600       |           |                        | 84                 | 0.30     | 0.012 | 3.50                   | 0.138 | 11718      |
|           |                        | 65                 | 0.13     | 0.005 | 1.19                   | 0.047 | 1625       |           |                        | 756                | 0.10     | 0.004 | 3.70                   | 0.146 | 11718      |
|           |                        | 41                 | 0.16     | 0.006 | 1.19                   | 0.047 | 1627       |           |                        | 1                  | 2.76     | 0.109 | 2.76                   | 0.109 | 11807      |
|           | 0.75                   | *7                 | 0.40     | 0.016 | 1.22                   | 0.048 | 1770       | 10        |                        | 7                  | 1.05     | 0.041 | 3.20                   | 0.126 | 11962      |
|           |                        | 19                 | 0.25     | 0.010 | 1.24                   | 0.049 | 1900       |           |                        | 19                 | 0.64     | 0.025 | 3.30                   | 0.130 | 12063      |

\*Strandings required for UL and CSA certification testing.

This chart details the different conductors commonly used in the industry. For each size, either AWG or metric, various stranding options are listed. Typically the higher stranding is used in applications requiring greater conductor flexibility.

| AWG to Metric Wire Crosses |                           |
|----------------------------|---------------------------|
| AWG                        | Metric (mm <sup>2</sup> ) |
| 26 – 22                    | 0.1 – 0.5                 |
| 22 – 18                    | 0.5 – 1.0                 |
| 16 – 14                    | 1.5 – 2.5                 |
| 12 – 10                    | 4.0 – 6.0                 |

(continued on page D1.100)

A. System Overview

B1. Cable Ties

B2. Cable Accessories

B3. Stainless Steel Ties

C1. Wiring Duct

C2. Surface Raceway

C3. Abrasion Protection

C4. Cable Management

D1. Terminals

D2. Power Connectors

D3. Grounding Connectors

E1. Labeling Systems

E2. Labels

E3. Pre-Printed & Write-On Markers

E4. Permanent Identification

E5. Lockout/Tagout & Safety Solutions

F. Index

## Common Conductor Sizes and Strandings Reference Chart (continued)

| Conductor |                        | Individual Strands |          |        | Overall Conductor Size |       |        | Conductor  |                        | Individual Strands |          |        | Overall Conductor Size |       |              |
|-----------|------------------------|--------------------|----------|--------|------------------------|-------|--------|------------|------------------------|--------------------|----------|--------|------------------------|-------|--------------|
| AWG       | Metric mm <sup>2</sup> | No.                | Diameter |        | Diameter               |       | Area   | AWG        | Metric mm <sup>2</sup> | No.                | Diameter |        | Diameter               |       | Area         |
|           |                        |                    | mm       | In.    | mm                     | In.   |        |            |                        |                    | mm       | In.    | mm                     | In.   |              |
|           | 6                      | 7                  | 0.107    | 0.042  | 3.21                   | 0.126 | 11840  |            | 95                     | 19                 | 2.57     | 0.101  | 12.8                   | 0.505 | 187500       |
|           |                        | 1                  | 2.77     | 0.109  | 2.77                   | 0.109 | 11840  |            |                        | 37                 | 1.83     | 0.072  | 12.5                   | 0.504 | 187500       |
| 9         |                        | 7                  | 1.1      | 0.0432 | 3.3                    | 0.13  | 13000  | 4/0        |                        | 19                 | 2.89     | 0.1055 | 13.4                   | 0.528 | 211600       |
|           |                        | 1                  | 2.91     | 0.1144 | 2.91                   | 0.114 | 13090  |            |                        | 120                | 37       | 2.06   | 0.081                  | 14.4  | 0.567        |
| 8         |                        | 1                  | 3.26     | 0.1285 | 3.25                   | 0.128 | 16510  | 250 kcmil  |                        | 37                 | 2.07     | 0.0822 | 14.6                   | 0.575 | 250 kcmil    |
|           |                        | 7                  | 1.23     | 0.0486 | 3.7                    | 0.146 | 16510  |            |                        | 300 kcmil          | 150      | 37     | 2.29                   | 0.09  | 16           |
|           | 10                     | 7                  | 1.37     | 0.054  | 4.12                   | 0.162 | 19740  | 350 kcmil  |                        | 37                 | 2.47     | 0.0973 | 17.3                   | 0.681 | 350 kcmil    |
|           |                        | 1                  | 3.58     | 0.141  | 3.58                   | 0.141 | 19740  |            |                        | 185                | 37       | 2.54   | 0.1                    | 17.8  | 0.7          |
| 7         |                        | 7                  | 1.38     | 0.0545 | 4.15                   | 0.164 | 20520  | 400 kcmil  |                        | 37                 | 2.64     | 0.104  | 18.5                   | 0.728 | 400 kcmil    |
|           |                        | 1                  | 3.67     | 0.1443 | 3.67                   | 0.144 | 20520  |            |                        | 240                | 37       | 2.9    | 0.114                  | 20.3  | 0.798        |
| 6         |                        | 7                  | 1.55     | 0.0612 | 4.66                   | 0.184 | 26240  |            |                        | 61                 | 2.26     | 0.089  | 20.3                   | 0.801 | 473.6 kcmil  |
|           |                        | 1                  | 4.11     | 0.162  | 4.11                   | 0.162 | 26240  |            |                        | 500 kcmil          | 37       | 2.95   | 0.1162                 | 20.7  | 0.813        |
|           | 16                     | 7                  | 1.73     | 0.008  | 5.13                   | 0.204 | 31580  |            |                        | 61                 | 2.3      | 0.0905 | 20.7                   | 0.814 | 500 kcmil    |
| 5         |                        | 7                  | 1.75     | 0.0688 | 5.24                   | 0.206 | 33090  |            | 300 kcmil              | 61                 | 2.51     | 0.099  | 22.6                   | 0.891 | 592.1 kcmil  |
| 4         |                        | 7                  | 1.96     | 0.0772 | 5.88                   | 0.232 | 41740  | 600 kcmil  |                        | 61                 | 2.52     | 0.0992 | 22.7                   | 0.893 | 600 kcmil    |
|           | 25                     | 7                  | 2.16     | 0.085  | 6.48                   | 0.255 | 49340  | 700 kcmil  |                        | 61                 | 2.72     | 0.1071 | 24.5                   | 0.964 | 700 kcmil    |
|           |                        | 19                 | 1.32     | 0.052  | 6.6                    | 0.26  | 49340  | 750 kcmil  |                        | 61                 | 2.82     | 0.1109 | 25.4                   | 0.998 | 750 kcmil    |
| 3         |                        | 7                  | 2.2      | 0.0867 | 6.61                   | 0.26  | 52620  |            |                        | 91                 | 2.31     | 0.0908 | 25.4                   | 0.998 | 750 kcmil    |
| 2         |                        | 7                  | 2.47     | 0.0974 | 7.42                   | 0.292 | 66300  |            | 400                    | 61                 | 2.9      | 0.114  | 26.1                   | 1.026 | 798.4 kcmil  |
|           | 35                     | 7                  | 2.54     | 0.1    | 7.62                   | 0.300 | 69070  | 800 kcmil  |                        | 61                 | 2.91     | 0.1145 | 26.2                   | 1.031 | 800 kcmil    |
|           |                        | 19                 | 1.55     | 0.001  | 7.75                   | 0.305 | 69070  |            |                        | 91                 | 2.38     | 0.0938 | 26.2                   | 1.032 | 800 kcmil    |
| 1         |                        | 19                 | 1.5      | 0.0064 | 8.43                   | 0.332 | 83690  | 1000 kcmil | 500                    | 61                 | 3.25     | 0.128  | 28.3                   | 1.152 | 986.8 kcmil  |
|           | 50                     | 19                 | 1.85     | 0.073  | 9.27                   | 0.365 | 98680  |            |                        | 91                 | 2.66     | 0.1048 | 29.3                   | 1.153 | 1000 kcmil   |
| 1/0       |                        | 19                 | 1.59     | 0.0745 | 9.46                   | 0.373 | 10500  |            | 625                    | 91                 | 2.97     | 0.117  | 32.7                   | 1.287 | 1233.7 kcmil |
| 2/0       |                        | 19                 | 2.13     | 0.0837 | 10.6                   | 0.419 | 133100 |            |                        |                    |          |        |                        |       |              |
| 3/0       | 70                     | 19                 | 2.18     | 0.086  | 10.9                   | 0.43  | 138100 |            |                        |                    |          |        |                        |       |              |
|           |                        | 19                 | 2.59     | 0.094  | 11.9                   | 0.47  | 167800 |            |                        |                    |          |        |                        |       |              |
|           |                        | 36                 | 1.71     | 0.0673 | 12                     | 0.471 | 167800 |            |                        |                    |          |        |                        |       |              |

This chart details the different conductors commonly used in the industry. For each size, either AWG or metric, various stranding options are listed. Typically the higher stranding is used in applications requiring greater conductor flexibility.

| AWG to Metric Wire Crosses |                           |
|----------------------------|---------------------------|
| AWG                        | Metric (mm <sup>2</sup> ) |
| <b>26 – 22</b>             | <b>0.1 – 0.5</b>          |
| <b>22 – 18</b>             | <b>0.5 – 1.0</b>          |
| <b>16 – 14</b>             | <b>1.5 – 2.5</b>          |
| <b>12 – 10</b>             | <b>4.0 – 6.0</b>          |

## REEL SMART™ SYSTEM



The Panduit® Reel Smart™ System provides the best solution for quality, high volume terminations designed to dramatically reduce set-up time and production downtime. This increased efficiency translates into real cost savings throughout the termination process from start to finish.



- One applicator system terminates over 400 continuously molded terminals, reducing cost of ownership
- Continuously molded integrated carrier guarantees alignment of terminal; front to back and side to side to eliminate skewing of product resulting in consistent, high quality low cost termination
- Available in large reels requiring less product changeover, resulting in less downtime
- Applicable sizes are UL Listed and CSA Certified, as noted
- Panduit® CA9 Ezair™ Universal Applicator works with Reel Smart™ Reel-Fed Terminals to deliver the ultimate fully automatic, high-capacity termination performance
- Panduit reel fed strip ferrules combine with tooling options to support wire harness, control panel, and automatic wire processing applications

Panduit continually provides new designs with innovative features to meet the application challenges encountered by customers, while providing the lowest installed cost.

A.  
System  
Overview

B1.  
Cable Ties

B2.  
Cable  
Accessories

B3.  
Stainless  
Steel Ties

C1.  
Wiring  
Duct

C2.  
Surface  
Raceway

C3.  
Abrasion  
Protection

C4.  
Cable  
Management

D1.  
Terminals

D2.  
Power  
Connectors

D3.  
Grounding  
Connectors

E1.  
Labeling  
Systems

E2.  
Labels

E3.  
Pre-Printed  
& Write-On  
Markers

E4.  
Permanent  
Identification

E5.  
Lockout/  
Tagout  
& Safety  
Solutions

F.  
Index



|                                       |
|---------------------------------------|
| A. System Overview                    |
| B1. Cable Ties                        |
| B2. Cable Accessories                 |
| B3. Stainless Steel Ties              |
| C1. Wiring Duct                       |
| C2. Surface Raceway                   |
| C3. Abrasion Protection               |
| C4. Cable Management                  |
| D1. Terminals                         |
| D2. Power Connectors                  |
| D3. Grounding Connectors              |
| E1. Labeling Systems                  |
| E2. Labels                            |
| E3. Pre-Printed & Write-On Markers    |
| E4. Permanent Identification          |
| E5. Lockout/Tagout & Safety Solutions |
| F. Index                              |

## Features and Benefits – Reel Smart™ Termination System

The Panduit continuously molded Reel Smart™ products are designed such that the terminal, disconnect, and butt splice housings are connected by an integral molded carrier in the barrel crimp zone, producing a continuous length of product. Plated metal terminals, disconnects, and splices are then assembled into the housings. During termination, the continuously molded components are fed into a universal applicator. This process produces a reel-fed solution that eliminates a variety of problems associated with other reel-fed designs and provides high quality, high capacity product on reels for longer, uninterrupted production runs – resulting in the lowest installed cost.

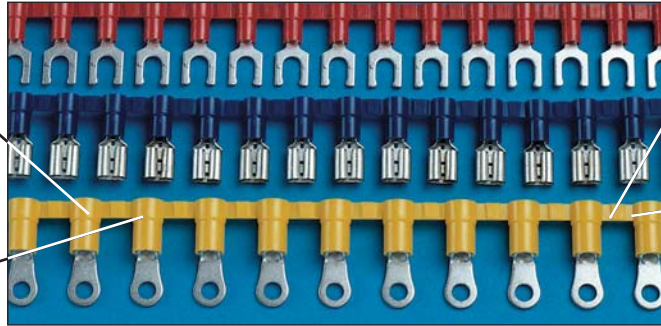

Pre-insulated design eliminates the need for post-insulation – resulting in labor savings

Continuously molded design always aligns product with the carrier strip – resulting in trouble free tool operation

Barrel position is controlled for consistent wire feed targeting to deliver high process capability

Plastic carrier strip eliminates sharp, unplated edges as found on metal strip-fed carriers – providing better corrosion resistance

## Reel Smart™ CA9 Ezair™ Universal Applicator

The Panduit® CA9 Ezair™ applicator automatically adjusts feed stroke to the correct pitch and length for the entire product line of continuously molded products. The need for multiple applicators is eliminated. The applicator, in conjunction with the precision, continuously molded product provides perfect front-to-back and side-to-side alignment in the die pocket for a high quality termination every time – resulting in the most optimum system to terminate terminals.

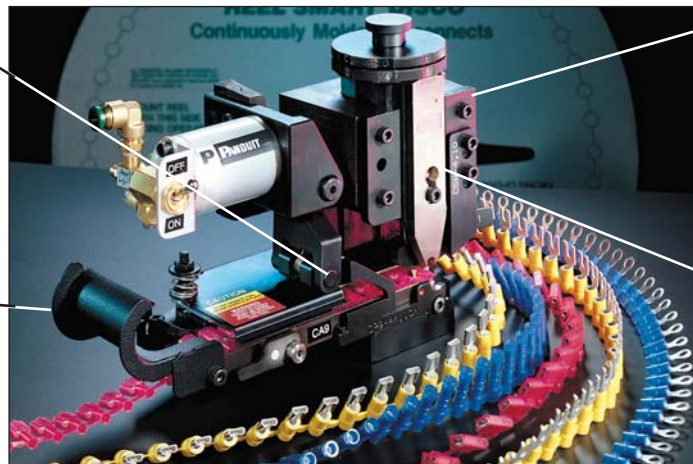

Automatic, self-adjusting feed stroke – resulting in correct pitch and length

Universal applicator installs Reel Smart™ product line – resulting in lower tooling inventory costs

Versatile applicator design – allows for installation in bench presses, and most automatic wire processing systems of 3rd party manufacturers

Quick change dies – provide fast product change-over and reduction in set-up time

## Nylon Insulated Terminals with Insulation Grip Sleeve (Funnel and Non-Funnel Entry Types)

The three-piece design terminal provides a permanently attached tin plated brass sleeve for insulation grip in funnel and straight entry sleeve designs. This product feature offers the most reliable terminations. Nylon insulation is rated up to 600 V maximum and designed for up to 221°F (105°C) operating temperature maximum. Supplied on rings, forks, locking forks, short locking forks and flanged forks in wire sizes #22 through #10.



- Sleeved barrel – assures crimp reliability
- PNF – funnel entry styles available
- Metal insulation crimp – provides DOUBLE CRIMP wire insulation grip sleeve for high vibration and to meet conductor strain environments

- Internal wire barrel serrations – provides increased wire contact and maximum tensile strength
- Product markings – UL and CSA rated – up to 600 V, maximum operating temperature 221°F (105°C)



## Part Number System for Reel Smart™ Terminals

| P                                | NF  | 14   | 6  | R  | N   | 3K                                 |
|----------------------------------|---|--|--|--|---|------------------------------------|
| Type                             | Insulation  | Wire Range   | Stud Size  | Tongue Configuration   | Special Configuration   | Std. Pkg. Size                     |
| P = Terminal<br>BS = Butt Splice | N = Nylon Insulated<br>NF = Nylon Insulated Funnel Entry<br>V = Vinyl Insulated | 18 = #22 – 18<br>14 = #16 – 14<br>12 = #16 – 12<br>10 = #12 – 10 | 4 = #4<br>5 = #5<br>6 = #6<br>8 = #8<br>10 = #10<br>14 = 1/4"<br>56 = 5/16"<br>38 = 3/8" | R = Ring<br>HDR = Heavy Duty Ring<br>F = Fork<br>FF = Fanged Fork<br>LF = Locking Fork<br>SLF = Short Locking Fork | N = Narrow Tongue<br>W = Wide Tongue<br>B = Butted Seam<br>= Standard (leave blank) | 2K = 2,000 pcs.<br>3K = 3,000 pcs. |



### Ring Terminals, Nylon Insulated – Non-Funnel Entry

#### Type PN-R

- Continuously molded design provides reliable, consistent performance through the applicator for a high quality termination every time
- Ring tongue design assures a secure connection in high vibration applications
- Metal insulation grip sleeve crimps to wire insulation, providing protection to the crimp joint during high vibration applications

- Internal barrel serrations assure good wire contact and maximum tensile strength
- UL Flammability UL 94V-2/HB, maximum insulation temperature 221°F (105°C)
- UL and CSA rated up to 600 V per UL 486A/B

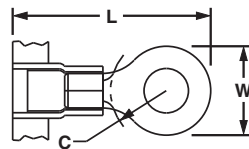

| Part Number | Wire Range  | Color Code | Stock Thickness (In.) | Max. Ins. (In.) | Stud Size | Figure Dimension (In.) |      |      | CA9 Series Crimp Die | CA-800/EZ Series Crimp Die | Pieces Per Reel |
|-------------|-------------|------------|-----------------------|-----------------|-----------|------------------------|------|------|----------------------|----------------------------|-----------------|
|             |             |            |                       |                 |           | L                      | W    | C    |                      |                            |                 |
| PN18-4R-3K  | 22 – 18 AWG | Red        | 0.03                  | 0.145           | #4        | 0.80                   | 0.25 | 0.22 | CD9-1A               | CD-800-1                   | 3000            |
| PN18-6RN-3K |             |            |                       |                 | #6        | 0.74                   | 0.22 | 0.18 |                      |                            | 3000            |
| PN18-6R-3K  |             |            |                       |                 | #6        | 0.78                   | 0.25 | 0.22 |                      |                            | 3000            |
| PN18-8R-3K  |             |            |                       |                 | #8        | 0.86                   | 0.31 | 0.25 |                      |                            | 3000            |
| PN18-10R-3K |             |            |                       |                 | #10       | 0.86                   | 0.31 | 0.25 |                      |                            | 3000            |
| PN18-14R-3K |             |            |                       |                 | 1/4"      | 1.05                   | 0.45 | 0.38 |                      |                            | 3000            |
| PN14-4R-3K  | 16 – 14 AWG | Blue       | 0.03                  | 0.162           | #4        | 0.76                   | 0.25 | 0.22 | CD9-2A               | CD-800-2                   | 3000            |
| PN14-6RN-3K |             |            |                       |                 | #6        | 0.76                   | 0.25 | 0.22 |                      |                            | 3000            |
| PN14-6R-3K  |             |            |                       |                 | #6        | 0.86                   | 0.31 | 0.25 |                      |                            | 3000            |
| PN14-8R-3K  |             |            |                       |                 | #8        | 0.86                   | 0.31 | 0.25 |                      |                            | 3000            |
| PN14-10R-3K |             |            |                       |                 | #10       | 0.86                   | 0.31 | 0.25 |                      |                            | 3000            |
| PN14-14R-3K |             |            |                       |                 | 1/4"      | 1.06                   | 0.44 | 0.38 |                      |                            | 3000            |
| PN10-6R-2K  | 12 – 10 AWG | Yellow     | 0.04                  | 0.225           | #6        | 1.06                   | 0.38 | 0.31 | CD9-3B               | CD-800-3                   | 2000            |
| PN10-8R-2K  |             |            |                       |                 | #8        | 1.06                   | 0.38 | 0.31 |                      |                            | 2000            |
| PN10-10R-2K |             |            |                       |                 | #10       | 1.06                   | 0.38 | 0.31 |                      |                            | 2000            |
| PN10-14R-2K |             |            |                       |                 | 1/4"      | 1.21                   | 0.52 | 0.38 |                      |                            | 2000            |
| PN10-56R-2K |             |            |                       |                 | 5/16"     | 1.21                   | 0.52 | 0.38 |                      |                            | 2000            |
| PN10-38R-2K |             |            |                       |                 | 3/8"      | 1.29                   | 0.58 | 0.43 |                      |                            | 2000            |

For applicator information, see page D1.143.

A. System Overview



## Ring Terminals, Nylon Insulated – Funnel Entry

B1. Cable Ties

### Type PNF-R

- Continuously molded design provides reliable, consistent performance through the applicator for a high quality termination every time

B2. Cable Accessories

- Ring tongue design assures a secure connection in high vibration applications

B3. Stainless Steel Ties

- Metal insulation grip sleeve crimps to wire insulation, providing protection to the crimp joint during high vibration applications

- Internal barrel serrations assure good wire contact and maximum tensile strength

- UL Flammability UL 94V-2/HB, maximum insulation temperature 221°F (105°C)

- UL and CSA rated up to 600 V per UL 486A/B

C1. Wiring Duct



C2. Surface Raceway

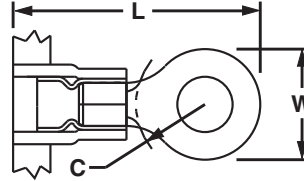

C3. Abrasion Protection

C4. Cable Management

| Part Number         | Wire Range  | Color Code | Stock Thickness (In.) | Max. Ins. (In.) | Stud Size | Figure Dimensions (In.) |      |      | CA9 Series Crimp Die | CA-800/EZ Series Crimp Die | Pieces Per Reel |
|---------------------|-------------|------------|-----------------------|-----------------|-----------|-------------------------|------|------|----------------------|----------------------------|-----------------|
|                     |             |            |                       |                 |           | L                       | W    | C    |                      |                            |                 |
| <b>PNF18-4RN-3K</b> | 22 – 18 AWG | Red        | 0.03                  | 0.145           | #4        | 0.74                    | 0.22 | 0.19 | CD9-1A               | CD-800-1                   | 3000            |
| <b>PNF18-4R-3K</b>  |             |            |                       |                 | #4        | 0.78                    | 0.25 | 0.21 |                      |                            | 3000            |
| <b>PNF18-6RN-3K</b> |             |            |                       |                 | #6        | 0.74                    | 0.22 | 0.16 |                      |                            | 3000            |
| <b>PNF18-6R-3K</b>  |             |            |                       |                 | #6        | 0.78                    | 0.25 | 0.21 |                      |                            | 3000            |
| <b>PNF18-8R-3K</b>  |             |            |                       |                 | #8        | 0.86                    | 0.31 | 0.25 |                      |                            | 3000            |
| <b>PNF18-10R-3K</b> |             |            |                       |                 | #10       | 0.86                    | 0.31 | 0.25 |                      |                            | 3000            |
| <b>PNF18-14R-3K</b> |             |            |                       |                 | 1/4"      | 1.06                    | 0.46 | 0.38 |                      |                            | 3000            |
| <b>PNF14-4R-3K</b>  | 16 – 14 AWG | Blue       | 0.03                  | 0.162           | #4        | 0.78                    | 0.25 | 0.18 | CD9-2A               | CD-800-2                   | 3000            |
| <b>PNF14-6RN-3K</b> |             |            |                       |                 | #6        | 0.78                    | 0.25 | 0.18 |                      |                            | 3000            |
| <b>PNF14-6R-3K</b>  |             |            |                       |                 | #6        | 0.87                    | 0.31 | 0.24 |                      |                            | 3000            |
| <b>PNF14-8R-3K</b>  |             |            |                       |                 | #8        | 0.87                    | 0.31 | 0.25 |                      |                            | 3000            |
| <b>PNF14-10R-3K</b> |             |            |                       |                 | #10       | 0.85                    | 0.31 | 0.29 |                      |                            | 3000            |
| <b>PNF14-14R-3K</b> |             |            |                       |                 | 1/4"      | 1.06                    | 0.46 | 0.40 |                      |                            | 3000            |
| <b>PNF10-6R-2K</b>  | 12 – 10 AWG | Yellow     | 0.04                  | 0.225           | #6        | 1.06                    | 0.38 | 0.31 | CD9-3B               | CD-800-3                   | 2000            |
| <b>PNF10-8R-2K</b>  |             |            |                       |                 | #8        | 1.06                    | 0.38 | 0.31 |                      |                            | 2000            |
| <b>PNF10-10R-2K</b> |             |            |                       |                 | #10       | 1.06                    | 0.38 | 0.31 |                      |                            | 2000            |
| <b>PNF10-14R-2K</b> |             |            |                       |                 | 1/4"      | 1.21                    | 0.52 | 0.38 |                      |                            | 2000            |
| <b>PNF10-56R-2K</b> |             |            |                       |                 | 5/16"     | 1.21                    | 0.52 | 0.38 |                      |                            | 2000            |
| <b>PNF10-38R-2K</b> | 3/8"        | 1.29       | 0.58                  | 0.43            | 2000      |                         |      |      |                      |                            |                 |

For applicator information, see page D1.143.

E1. Labeling Systems

E2. Labels

E3. Pre-Printed & Write-On Markers

E4. Permanent Identification

E5. Lockout/Tagout & Safety Solutions

F. Index



## Ring Terminals, Vinyl Insulated – Funnel Entry

### Type PV-RB

- Continuously molded design provides reliable, consistent performance through the applicator for a high quality termination every time
- Ring tongue design assures a secure connection in high vibration applications



- Insulation support helps to prevent wire damage in bending applications
- UL Flammability UL 94V-0, maximum insulation temperature 221°F (105°C)
- UL and CSA rated up to 600 V per UL 486A/B

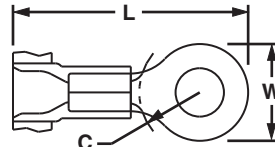

| Part Number  | Wire Range  | Color Code | Stock Thickness (In.) | Max. Ins. (In.) | Stud Size   | Figure Dimensions (In.) |      |       | CA9 Series Crimp Die | CA-800/EZ Series Crimp Die | Pieces Per Reel |      |        |          |        |          |      |
|--------------|-------------|------------|-----------------------|-----------------|-------------|-------------------------|------|-------|----------------------|----------------------------|-----------------|------|--------|----------|--------|----------|------|
|              |             |            |                       |                 |             | L                       | W    | C     |                      |                            |                 |      |        |          |        |          |      |
| PV18-4RNB-3K | 22 – 18 AWG | Red        | 0.03                  | 0.150           | #4          | 0.74                    | 0.21 | 0.19  | CD9-1A               | CD-800-1                   | 3000            |      |        |          |        |          |      |
| PV18-4RB-3K  |             |            |                       |                 | #4          | 0.78                    | 0.25 | 0.20  |                      |                            | 3000            |      |        |          |        |          |      |
| PV18-6RNB-3K |             |            |                       |                 | #6          | 0.75                    | 0.23 | 0.19  |                      |                            | 3000            |      |        |          |        |          |      |
| PV18-6RB-3K  |             |            |                       |                 | #6          | 0.78                    | 0.25 | 0.20  |                      |                            | 3000            |      |        |          |        |          |      |
| PV18-8RB-3K  |             |            |                       |                 | #8          | 0.86                    | 0.31 | 0.25  |                      |                            | 3000            |      |        |          |        |          |      |
| PV18-10RB-3K |             |            |                       |                 | #10         | 0.86                    | 0.31 | 0.25  |                      |                            | 3000            |      |        |          |        |          |      |
| PV18-14RB-3K |             |            |                       |                 | 1/4"        | 1.06                    | 0.45 | 0.38  |                      |                            | 3000            |      |        |          |        |          |      |
| PV18-56RB-2K |             |            |                       |                 | 5/16"       | 1.06                    | 0.46 | 0.38  |                      |                            | 2000            |      |        |          |        |          |      |
| PV18-38RB-2K |             |            |                       |                 | 3/8"        | 1.15                    | 0.53 | 0.43  |                      |                            | 2000            |      |        |          |        |          |      |
| PV14-4RB-3K  |             |            |                       |                 | 16 – 14 AWG | Blue                    | 0.03 | 0.170 |                      |                            | #4              | 0.76 | 0.25   | 0.22     | CD9-2A | CD-800-2 | 3000 |
| PV14-6RNB-3K | #6          | 0.76       | 0.25                  | 0.22            |             |                         |      |       | 3000                 |                            |                 |      |        |          |        |          |      |
| PV14-6RB-3K  | #6          | 0.86       | 0.31                  | 0.25            |             |                         |      |       | 3000                 |                            |                 |      |        |          |        |          |      |
| PV14-8RB-3K  | #8          | 0.86       | 0.31                  | 0.25            |             |                         |      |       | 3000                 |                            |                 |      |        |          |        |          |      |
| PV14-10RB-3K | #10         | 0.86       | 0.31                  | 0.25            |             |                         |      |       | 3000                 |                            |                 |      |        |          |        |          |      |
| PV14-14RB-3K | 1/4"        | 1.05       | 0.45                  | 0.38            |             |                         |      |       | 3000                 |                            |                 |      |        |          |        |          |      |
| PV14-56RB-2K | 5/16"       | 1.06       | 0.46                  | 0.38            |             |                         |      |       | 2000                 |                            |                 |      |        |          |        |          |      |
| PV14-38RB-2K | 3/8"        | 1.15       | 0.53                  | 0.43            |             |                         |      |       | 2000                 |                            |                 |      |        |          |        |          |      |
| PV10-6RB-2K  | 12 – 10 AWG | Yellow     | 0.04                  | 0.225           |             |                         |      |       | #6                   | 1.02                       | 0.31            | 0.31 | CD9-3B | CD-800-3 |        |          | 2000 |
| PV10-8RB-2K  |             |            |                       |                 |             |                         |      |       | #8                   | 1.02                       | 0.31            | 0.31 |        |          |        |          | 2000 |
| PV10-10RB-2K |             |            |                       |                 | #10         | 1.02                    | 0.31 | 0.31  | 2000                 |                            |                 |      |        |          |        |          |      |
| PV10-14RB-2K |             |            |                       |                 | 1/4"        | 1.20                    | 0.52 | 0.38  | 2000                 |                            |                 |      |        |          |        |          |      |
| PV10-56RB-2K |             |            |                       |                 | 5/16"       | 1.20                    | 0.52 | 0.38  | 2000                 |                            |                 |      |        |          |        |          |      |
| PV10-38RB-2K |             |            |                       |                 | 3/8"        | 1.23                    | 0.58 | 0.38  | 2000                 |                            |                 |      |        |          |        |          |      |

For applicator information, see page D1.143.



## Multiple Stud Ring Terminals, Vinyl Insulated – Funnel Entry

### Type PV-610RB

- Continuously molded design provides reliable, consistent performance through the applicator for a high quality termination every time
- Teardrop shaped mounting hole of multiple stud terminals permits use with #6, #8, or #10 size studs
- Ring tongue design assures a secure connection in high vibration applications



- Insulation support helps to prevent wire damage in bending applications
- UL Flammability UL 94V-0, maximum insulation temperature 221°F (105°C)
- UL and CSA rated up to 600 V per UL 486A/B

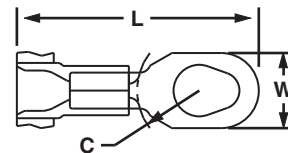

| Part Number   | Wire Range  | Color Code | Stock Thickness (In.) | Max. Ins. (In.) | Stud Size   | Figure Dimensions (In.) |      |      | CA9 Series Crimp Die | CA-800/EZ Series Crimp Die | Pieces Per Reel |
|---------------|-------------|------------|-----------------------|-----------------|-------------|-------------------------|------|------|----------------------|----------------------------|-----------------|
|               |             |            |                       |                 |             | L                       | W    | C    |                      |                            |                 |
| PV18-610RB-3K | 22 – 18 AWG | Red        | 0.03                  | 0.150           | #6, #8, #10 | 0.95                    | 0.31 | 0.25 | CD9-1A               | CD-800-1                   | 3000            |
| PV14-610RB-3K | 16 – 14 AWG | Blue       | 0.03                  | 0.170           |             | 0.95                    | 0.31 | 0.25 | CD9-2A               | CD-800-2                   | 3000            |
| PV10-610RB-2K | 12 – 10 AWG | Yellow     | 0.04                  | 0.225           |             | 1.17                    | 0.37 | 0.31 | CD9-3B               | CD-800-3                   | 2000            |

For applicator information, see page D1.143.

A. System Overview

B1. Cable Ties

B2. Cable Accessories

B3. Stainless Steel Ties

C1. Wiring Duct

C2. Surface Raceway

C3. Abrasion Protection

C4. Cable Management

D1. Terminals

D2. Power Connectors

D3. Grounding Connectors

E1. Labeling Systems

E2. Labels

E3. Pre-Printed & Write-On Markers

E4. Permanent Identification

E5. Lockout/Tagout & Safety Solutions

F. Index

A. System Overview



## Ring Terminals, Nylon Insulated – Heavy Duty

B1. Cable Ties

### Type PN-HDR

B2. Cable Accessories

B3. Stainless Steel Ties

C1. Wiring Duct

C2. Surface Raceway

C3. Abrasion Protection

C4. Cable Management

- Continuously molded design provides reliable, consistent performance through the applicator for a high quality termination every time
- Manufactured from stock 56% thicker than a standard #16 – 14 AWG terminal for use in heavy duty application
- Ring tongue design assures a secure connection in high vibration applications

- Metal insulation grip sleeve crimps to wire insulation, providing protection to the crimp joint during high vibration applications
- Internal barrel serrations assure good wire contact and maximum tensile strength
- UL Flammability UL 94V-2/HB, maximum insulation temperature 221°F (105°C)
- UL and CSA rated up to 600 V per UL 486A/B

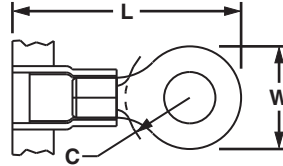

| Part Number   | Wire Range  | Color Code | Stock Thickness (In.) | Max. Ins. (In.) | Stud Size | Figure Dimensions (In.) |      |      | CA9 Series Crimp Die | CA-800/EZ Series Crimp Die | Pieces Per Reel |
|---------------|-------------|------------|-----------------------|-----------------|-----------|-------------------------|------|------|----------------------|----------------------------|-----------------|
|               |             |            |                       |                 |           | L                       | W    | C    |                      |                            |                 |
| PN12-6HDR-2K  | 16 – 12 AWG | Yellow     | 0.05                  | 0.225           | #6        | 1.02                    | 0.31 | 0.31 | CD9-3B               | CD-800-3                   | 2000            |
| PN12-8HDR-2K  |             |            |                       |                 | #8        | 1.02                    | 0.31 | 0.31 |                      |                            | 2000            |
| PN12-10HDR-2K |             |            |                       |                 | #10       | 1.05                    | 0.38 | 0.31 |                      |                            | 2000            |
| PN12-14HDR-2K |             |            |                       |                 | 1/4"      | 1.20                    | 0.52 | 0.38 |                      |                            | 2000            |
| PN12-56HDR-2K |             |            |                       |                 | 5/16"     | 1.20                    | 0.52 | 0.38 |                      |                            | 2000            |
| PN12-38HDR-2K |             |            |                       |                 | 3/8"      | 1.28                    | 0.58 | 0.38 |                      |                            | 2000            |

For applicator information, see page D1.143.

D1. Terminals



## Ring Terminals, Vinyl Insulated – Heavy Duty

D2. Power Connectors

### Type PV-HDRB

D3. Grounding Connectors

E1. Labeling Systems

E2. Labels

- Continuously molded design provides reliable, consistent performance through the applicator for a high quality termination every time
- Manufactured from stock 56% thicker than a standard #16 – 14 AWG terminal for use in heavy-duty applications
- Ring tongue design assures a secure connection in high vibration applications

- Insulation support helps to prevent wire damage in bending applications
- UL Flammability UL 94V-0, maximum insulation temperature 221°F (105°C)
- UL and CSA rated up to 600 V per UL 486A/B

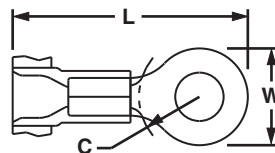

| Part Number           | Wire Range  | Color Code | Stock Thickness (In.) | Max. Ins. (In.) | Stud Size | Figure Dimensions (In.) |      |      | CA9 Series Crimp Die | CA-800/EZ Series Crimp Die | Pieces Per Reel |
|-----------------------|-------------|------------|-----------------------|-----------------|-----------|-------------------------|------|------|----------------------|----------------------------|-----------------|
|                       |             |            |                       |                 |           | L                       | W    | C    |                      |                            |                 |
| PV12-6HDRB-2K         | 16 – 12 AWG | Yellow     | 0.05                  | 0.225           | #6        | 1.03                    | 0.31 | 0.36 | CD9-3B               | CD-800-3                   | 2000            |
| PV12-8HDRB-2K         |             |            |                       |                 | #8        | 1.03                    | 0.31 | 0.36 |                      |                            | 2000            |
| PV12-10HDRB-2K        |             |            |                       |                 | #10       | 1.06                    | 0.37 | 0.36 |                      |                            | 2000            |
| PV12-14HDRB-2K        |             |            |                       |                 | 1/4"      | 1.23                    | 0.52 | 0.43 |                      |                            | 2000            |
| <b>PV12-56HDRB-2K</b> |             |            |                       |                 | 5/16"     | 1.23                    | 0.52 | 0.43 |                      |                            | 2000            |
| PV12-38HDRB-2K        |             |            |                       |                 | 3/8"      | 1.30                    | 0.58 | 0.48 |                      |                            | 2000            |

For applicator information, see page D1.143.

F. Index



## Fork Terminals, Nylon Insulated – Non-Funnel Entry

### Type PN-F

- Continuously molded design provides reliable, consistent performance through the applicator for a high quality termination every time
- Fork design provides for fast and easy installation, without the need to remove fastener
- Metal insulation grip sleeve crimps to wire insulation, providing protection to the crimp joint during high vibration applications

- Internal barrel serrations assure good wire contact and maximum tensile strength
- UL Flammability UL 94V-2/HB, maximum insulation temperature 221°F (105°C)
- UL and CSA rated up to 600 V per UL 486A/B

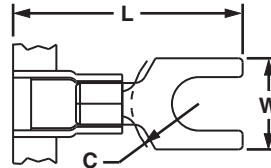

| Part Number  | Wire Range  | Color Code | Stock Thickness (In.) | Max. Ins. (In.) | Stud Size | Figure Dimensions (In.) |      |      | CA9 Series Crimp Die | CA-800/EZ Series Crimp Die | Pieces Per Reel |
|--------------|-------------|------------|-----------------------|-----------------|-----------|-------------------------|------|------|----------------------|----------------------------|-----------------|
|              |             |            |                       |                 |           | L                       | W    | C    |                      |                            |                 |
| PN18-6FN-3K  | 22 – 18 AWG | Red        | 0.03                  | 0.145           | #6        | 0.78                    | 0.25 | 0.20 | CD9-1A               | CD-800-1                   | 3000            |
| PN18-6F-3K   |             |            |                       |                 | #6        | 0.78                    | 0.30 | 0.20 |                      |                            | 3000            |
| PN18-8F-3K   |             |            |                       |                 | #8        | 0.84                    | 0.32 | 0.23 |                      |                            | 3000            |
| PN18-10FN-3K |             |            |                       |                 | #10       | 0.86                    | 0.31 | 0.25 |                      |                            | 3000            |
| PN18-10F-3K  |             |            |                       |                 | #10       | 0.86                    | 0.35 | 0.25 |                      |                            | 3000            |
| PN18-14F-3K  |             |            |                       |                 | 1/4"      | 1.03                    | 0.44 | 0.33 |                      |                            | 3000            |
| PN14-6FN-3K  | 16 – 14 AWG | Blue       | 0.03                  | 0.162           | #6        | 0.78                    | 0.24 | 0.19 | CD9-2A               | CD-800-2                   | 3000            |
| PN14-6F-3K   |             |            |                       |                 | #6        | 0.78                    | 0.28 | 0.19 |                      |                            | 3000            |
| PN14-8F-3K   |             |            |                       |                 | #8        | 0.84                    | 0.31 | 0.23 |                      |                            | 3000            |
| PN14-10FN-3K |             |            |                       |                 | #10       | 0.86                    | 0.31 | 0.24 |                      |                            | 3000            |
| PN14-10F-3K  |             |            |                       |                 | #10       | 0.86                    | 0.34 | 0.24 |                      |                            | 3000            |
| PN14-14F-3K  |             |            |                       |                 | 1/4"      | 1.03                    | 0.44 | 0.32 |                      |                            | 3000            |
| PN10-6F-2K   | 12 – 10 AWG | Yellow     | 0.04                  | 0.225           | #6        | 1.00                    | 0.31 | 0.24 | CD9-3B               | CD-800-3                   | 2000            |
| PN10-8F-2K   |             |            |                       |                 | #8        | 1.03                    | 0.37 | 0.24 |                      |                            | 2000            |
| PN10-10F-2K  |             |            |                       |                 | #10       | 1.04                    | 0.37 | 0.24 |                      |                            | 2000            |
| PN10-14F-2K  |             |            |                       |                 | 1/4"      | 1.14                    | 0.49 | 0.32 |                      |                            | 2000            |

For applicator information, see page D1.143.

A. System Overview

B1. Cable Ties

B2. Cable Accessories

B3. Stainless Steel Ties

C1. Wiring Duct

C2. Surface Raceway

C3. Abrasion Protection

C4. Cable Management

D1. Terminals

D2. Power Connectors

D3. Grounding Connectors

E1. Labeling Systems

E2. Labels

E3. Pre-Printed & Write-On Markers

E4. Permanent Identification

E5. Lockout/Tagout & Safety Solutions

F. Index

A. System Overview



## Fork Terminals, Nylon Insulated – Funnel Entry

B1. Cable Ties

### Type PNF-F

- Continuously molded design provides reliable, consistent performance through the applicator for a high quality termination every time
- Fork design provides for fast and easy installation, without the need to remove fastener
- Metal insulation grip sleeve crimps to wire insulation, providing protection to the crimp joint during high vibration applications

- Internal barrel serrations assure good wire contact and maximum tensile strength
- UL Flammability UL 94V-2/HB, maximum insulation temperature 221°F (105°C)
- UL and CSA rated up to 600 V per UL 486A/B

B2. Cable Accessories

B3. Stainless Steel Ties

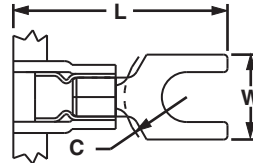

C1. Wiring Duct

C2. Surface Raceway

C3. Abrasion Protection

C4. Cable Management

D1. Terminals

D2. Power Connectors

D3. Grounding Connectors

E1. Labeling Systems

E2. Labels

E3. Pre-Printed & Write-On Markers

E4. Permanent Identification

E5. Lockout/Tagout & Safety Solutions

F. Index

| Part Number          | Wire Range  | Color Code | Stock Thickness (In.) | Max. Ins. (In.) | Stud Size | Figure Dimensions (In.) |      |      | CA9 Series Crimp Die | CA-800/EZ Series Crimp Die | Pieces Per Reel |
|----------------------|-------------|------------|-----------------------|-----------------|-----------|-------------------------|------|------|----------------------|----------------------------|-----------------|
|                      |             |            |                       |                 |           | L                       | W    | C    |                      |                            |                 |
| <b>PNF18-6F-3K</b>   | 22 – 18 AWG | Red        | 0.03                  | 0.145           | #6        | 0.77                    | 0.24 | 0.19 | CD9-1A               | CD-800-1                   | 3000            |
| <b>PNF18-6FN-3K</b>  |             |            |                       |                 | #6        | 0.78                    | 0.30 | 0.19 |                      |                            | 3000            |
| <b>PNF18-8F-3K</b>   |             |            |                       |                 | #8        | 0.83                    | 0.32 | 0.22 |                      |                            | 3000            |
| <b>PNF18-10F-3K</b>  |             |            |                       |                 | #10       | 0.85                    | 0.35 | 0.24 |                      |                            | 3000            |
| <b>PNF18-14F-3K</b>  |             |            |                       |                 | 1/4"      | 1.02                    | 0.44 | 0.33 |                      |                            | 3000            |
| <b>PNF14-6FN-3K*</b> | 16 – 14 AWG | Blue       | 0.03                  | 0.162           | #6        | 0.78                    | 0.24 | 0.19 | CD9-2A               | CD-800-2                   | 3000            |
| <b>PNF14-6F-3K</b>   |             |            |                       |                 | #6        | 0.78                    | 0.28 | 0.19 |                      |                            | 3000            |
| <b>PNF14-8F-3K</b>   |             |            |                       |                 | #8        | 0.84                    | 0.31 | 0.23 |                      |                            | 3000            |
| <b>PNF14-10F-3K</b>  |             |            |                       |                 | #10       | 0.86                    | 0.34 | 0.24 |                      |                            | 3000            |
| <b>PNF14-14F-3K</b>  |             |            |                       |                 | 1/4"      | 1.03                    | 0.44 | 0.32 |                      |                            | 3000            |
| <b>PNF10-6F-2K</b>   | 12 – 10 AWG | Yellow     | 0.04                  | 0.225           | #6        | 1.01                    | 0.31 | 0.24 | CD9-3B               | CD-800-3                   | 2000            |
| <b>PNF10-8F-2K</b>   |             |            |                       |                 | #8        | 1.02                    | 0.37 | 0.24 |                      |                            | 2000            |
| <b>PNF10-14F-2K</b>  |             |            |                       |                 | 1/4"      | 1.13                    | 0.49 | 0.32 |                      |                            | 2000            |

\*Not UL Listed or CSA Certified.  
For applicator information, see page D1.143.





## Fork Terminals, Vinyl Insulated – Funnel Entry

### Type PV-FB

- Continuously molded design provides reliable, consistent performance through the applicator for a high quality termination every time
- Fork design provides for fast and easy installation, without the need to remove fastener

- Insulation support helps to prevent wire damage in bending applications
- UL Flammability UL 94V-0, maximum insulation temperature 221°F (105°C)
- UL and CSA rated up 600 V per UL 486A/B

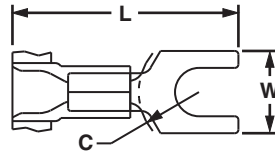

| Part Number           | Wire Range  | Color Code | Stock Thickness (In.) | Max. Ins. (In.) | Stud Size | Figure Dimensions (In.) |      |      | CA9 Series Crimp Die | CA-800/EZ Series Crimp Die | Pieces Per Reel |
|-----------------------|-------------|------------|-----------------------|-----------------|-----------|-------------------------|------|------|----------------------|----------------------------|-----------------|
|                       |             |            |                       |                 |           | L                       | W    | C    |                      |                            |                 |
| <b>PV18-6FB-3K</b>    | 22 – 18 AWG | Red        | 0.03                  | 0.150           | #6        | 0.78                    | 0.25 | 0.20 | CD9-1A               | CD-800-1                   | 3000            |
| <b>PV18-6FNB-3K</b>   |             |            |                       |                 | #6        | 0.78                    | 0.30 | 0.20 |                      |                            | 3000            |
| <b>PV18-8FB-3K</b>    |             |            |                       |                 | #8        | 0.84                    | 0.32 | 0.23 |                      |                            | 3000            |
| <b>PV18-10FB-3K</b>   |             |            |                       |                 | #10       | 0.86                    | 0.35 | 0.25 |                      |                            | 3000            |
| <b>PV18-14FB-3K</b>   |             |            |                       |                 | 1/4"      | 1.03                    | 0.44 | 0.33 |                      |                            | 3000            |
| <b>PV14-6FB-3K</b>    | 16 – 14 AWG | Blue       | 0.03                  | 0.170           | #6        | 0.78                    | 0.24 | 0.19 | CD9-2A               | CD-800-2                   | 3000            |
| <b>PV14-6FNB-3K*</b>  |             |            |                       |                 | #6        | 0.78                    | 0.28 | 0.19 |                      |                            | 3000            |
| <b>PV14-8FB-3K</b>    |             |            |                       |                 | #8        | 0.84                    | 0.31 | 0.23 |                      |                            | 3000            |
| <b>PV14-10FB-3K</b>   |             |            |                       |                 | #10       | 0.86                    | 0.31 | 0.24 |                      |                            | 3000            |
| <b>PV14-10FNB-3K*</b> |             |            |                       |                 | #10       | 0.86                    | 0.34 | 0.24 |                      |                            | 3000            |
| <b>PV14-14FB-3K</b>   | 1/4"        | 1.03       | 0.44                  | 0.32            | 3000      |                         |      |      |                      |                            |                 |
| <b>PV10-6FB-2K</b>    | 12 – 10 AWG | Yellow     | 0.04                  | 0.225           | #6        | 0.99                    | 0.31 | 0.22 | CD9-3B               | CD-800-3                   | 2000            |
| <b>PV10-8FB-2K</b>    |             |            |                       |                 | #8        | 1.00                    | 0.38 | 0.22 |                      |                            | 2000            |
| <b>PV10-10FB-2K</b>   |             |            |                       |                 | #10       | 1.04                    | 0.38 | 0.22 |                      |                            | 2000            |
| <b>PV10-14FB-2K</b>   |             |            |                       |                 | 1/4"      | 1.13                    | 0.49 | 0.32 |                      |                            | 2000            |

\*CSA Certified only.  
For applicator information, see page D1.143.

A. System Overview

B1. Cable Ties

B2. Cable Accessories

B3. Stainless Steel Ties

C1. Wiring Duct

C2. Surface Raceway

C3. Abrasion Protection

C4. Cable Management

D1. Terminals

D2. Power Connectors

D3. Grounding Connectors

E1. Labeling Systems

E2. Labels

E3. Pre-Printed & Write-On Markers

E4. Permanent Identification

E5. Lockout/Tagout & Safety Solutions

F. Index

A. System Overview



## Locking Fork Terminals, Nylon Insulated – Non-Funnel Entry

### Type PN-LF

B1. Cable Ties

B2. Cable Accessories

B3. Stainless Steel Ties

C1. Wiring Duct



- Continuously molded design provides reliable, consistent performance through the applicator for a high quality termination every time
- Snap in place for secure connection
- Fork design provides for fast and easy installation, without the need to remove fastener
- Metal insulation grip sleeve crimps to wire insulation, providing protection to the crimp joint during high vibration applications
- Internal barrel serrations assure good wire contact and maximum tensile strength
- UL Flammability UL 94V-2/HB, maximum insulation temperature 221°F (105°C)
- UL and CSA rated up to 600 V per UL 486A/B

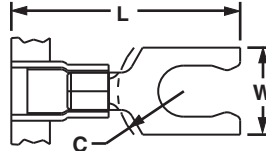

C2. Surface Raceway

C3. Abrasion Protection

C4. Cable Management

| Part Number  | Wire Range  | Color Code | Stock Thickness (In.) | Max. Ins. (In.) | Stud Size | Figure Dimensions (In.) |      |      | CA9 Series Crimp Die | CA-800/EZ Series Crimp Die | Pieces Per Reel |
|--------------|-------------|------------|-----------------------|-----------------|-----------|-------------------------|------|------|----------------------|----------------------------|-----------------|
|              |             |            |                       |                 |           | L                       | W    | C    |                      |                            |                 |
| PN18-6LF-3K  | 22 – 18 AWG | Red        | 0.03                  | 0.145           | #6        | 0.82                    | 0.27 | 0.19 | CD9-1A               | CD-800-1                   | 3000            |
| PN18-8LF-3K  |             |            |                       |                 | #8        | 0.89                    | 0.29 | 0.23 |                      |                            | 3000            |
| PN18-10LF-3K |             |            |                       |                 | #10       | 0.89                    | 0.33 | 0.23 |                      |                            | 3000            |
| PN14-6LF-3K  | 16 – 14 AWG | Blue       | 0.03                  | 0.162           | #6        | 0.85                    | 0.25 | 0.18 | CD9-2A               | CD-800-2                   | 3000            |
| PN14-8LF-3K  |             |            |                       |                 | #8        | 0.92                    | 0.29 | 0.23 |                      |                            | 3000            |
| PN14-10LF-3K |             |            |                       |                 | #10       | 0.92                    | 0.33 | 0.23 |                      |                            | 3000            |
| PN10-6LF-2K  | 12 – 10 AWG | Yellow     | 0.04                  | 0.225           | #6        | 1.02                    | 0.30 | 0.21 | CD9-3B               | CD-800-3                   | 2000            |
| PN10-8LF-2K  |             |            |                       |                 | #8        | 1.05                    | 0.30 | 0.21 |                      |                            | 2000            |
| PN10-10LF-2K |             |            |                       |                 | #10       | 1.05                    | 0.34 | 0.21 |                      |                            | 2000            |

For applicator information, see page D1.143.

D1. Terminals



## Locking Fork Terminals, Nylon Insulated – Funnel Entry

### Type PNF-LF

D2. Power Connectors

D3. Grounding Connectors

E1. Labeling Systems

E2. Labels

E3. Pre-Printed & Write-On Markers

E4. Permanent Identification

E5. Lockout/Tagout & Safety Solutions

F. Index



- Continuously molded design provides reliable, consistent performance through the applicator for a high quality termination every time
- Snap in place for secure connection
- Fork design provides for fast and easy installation, without the need to remove fastener
- Metal insulation grip sleeve crimps to wire insulation, providing protection to the crimp joint during high vibration applications
- Internal barrel serrations assure good wire contact and maximum tensile strength
- UL Flammability UL 94V-2/HB, maximum insulation temperature 221°F (105°C)
- UL and CSA rated up to 600 V per UL 486A/B

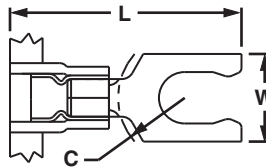

| Part Number    | Wire Range  | Color Code | Stock Thickness (In.) | Max. Ins. (In.) | Stud Size | Figure Dimensions (In.) |      |      | CA9 Series Crimp Die | CA-800/EZ Series Crimp Die | Pieces Per Reel |
|----------------|-------------|------------|-----------------------|-----------------|-----------|-------------------------|------|------|----------------------|----------------------------|-----------------|
|                |             |            |                       |                 |           | L                       | W    | C    |                      |                            |                 |
| PNF18-6LF-3K   | 22 – 18 AWG | Red        | 0.03                  | 0.145           | #6        | 0.85                    | 0.27 | 0.19 | CD9-1A               | CD-800-1                   | 3000            |
| PNF18-6LFW-3K  |             |            |                       |                 | #6        | 0.85                    | 0.29 | 0.19 |                      |                            | 3000            |
| PNF18-8LF-3K   |             |            |                       |                 | #8        | 0.89                    | 0.29 | 0.23 |                      |                            | 3000            |
| PNF18-10LF-3K  | 16 – 14 AWG | Blue       | 0.03                  | 0.162           | #10       | 0.89                    | 0.33 | 0.23 | CD9-2A               | CD-800-2                   | 3000            |
| PNF14-6LF-3K   |             |            |                       |                 | #6        | 0.85                    | 0.25 | 0.18 |                      |                            | 3000            |
| PNF14-8LF-3K   |             |            |                       |                 | #8        | 0.92                    | 0.29 | 0.23 |                      |                            | 3000            |
| PNF14-10LFN-3K | 12 – 10 AWG | Yellow     | 0.04                  | 0.225           | #10       | 0.92                    | 0.33 | 0.23 | CD9-3B               | CD-800-3                   | 3000            |
| PNF14-10LF-3K  |             |            |                       |                 | #10       | 0.92                    | 0.33 | 0.23 |                      |                            | 3000            |
| PNF10-6LF-2K   |             |            |                       |                 | #6        | 1.02                    | 0.30 | 0.21 |                      |                            | 2000            |
| PNF10-8LF-2K   | 12 – 10 AWG | Yellow     | 0.04                  | 0.225           | #8        | 1.05                    | 0.30 | 0.21 | CD9-3B               | CD-800-3                   | 2000            |
| PNF10-10LF-2K  |             |            |                       |                 | #10       | 1.05                    | 0.34 | 0.21 |                      |                            | 2000            |
| PNF10-14LF-2K  |             |            |                       |                 | 1/4"      | 1.19                    | 0.46 | 0.32 |                      |                            | 2000            |

For applicator information, see page D1.143.



## Locking Fork Terminals, Vinyl Insulated – Funnel Entry

### Type PV-LFB

- Continuously molded design provides reliable, consistent performance through the applicator for a high quality termination every time
- Snap in place for secure connection
- Fork design provides for fast and easy installation, without the need to remove fastener
- Insulation support helps to prevent wire damage in bending applications
- UL Flammability UL 94V-0, maximum insulation temperature 221 °F (105°C)
- UL and CSA rated to 600 V per UL 486A/B

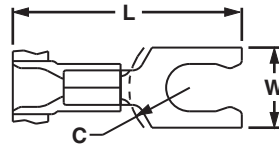

| Part Number            | Wire Range  | Color Code | Stock Thickness (In.) | Max. Ins. (In.) | Stud Size | Figure Dimensions (In.) |      |      | CA9 Series Crimp Die | CA-800/EZ Series Crimp Die | Pieces Per Reel |
|------------------------|-------------|------------|-----------------------|-----------------|-----------|-------------------------|------|------|----------------------|----------------------------|-----------------|
|                        |             |            |                       |                 |           | L                       | W    | C    |                      |                            |                 |
| <b>PV18-6LFB-3K</b>    | 22 – 18 AWG | Red        | 0.03                  | 0.150           | #6        | 0.80                    | 0.27 | 0.19 | CD9-1A               | CD-800-1                   | 3000            |
| <b>PV18-6LFWB-3K</b>   |             |            |                       |                 | #6        | 0.83                    | 0.29 | 0.19 |                      |                            | 3000            |
| <b>PV18-8LFB-3K</b>    |             |            |                       |                 | #8        | 0.87                    | 0.29 | 0.23 |                      |                            | 3000            |
| <b>PV18-10LFNB-3K*</b> |             |            |                       |                 | #10       | 0.87                    | 0.29 | 0.23 |                      |                            | 3000            |
| <b>PV18-10LFB-3K</b>   |             |            |                       |                 | #10       | 0.87                    | 0.33 | 0.23 |                      |                            | 3000            |
| <b>PV14-6LFB-3K</b>    | 16 – 14 AWG | Blue       | 0.03                  | 0.170           | #6        | 0.85                    | 0.25 | 0.18 | CD9-2A               | CD-800-2                   | 3000            |
| <b>PV14-6LFWB-3K</b>   |             |            |                       |                 | #6        | 0.85                    | 0.29 | 0.18 |                      |                            | 3000            |
| <b>PV14-8LFB-3K</b>    |             |            |                       |                 | #8        | 0.92                    | 0.29 | 0.23 |                      |                            | 3000            |
| <b>PV14-10LFB-3K</b>   | 12 – 10 AWG | Yellow     | 0.04                  | 0.225           | #10       | 0.92                    | 0.33 | 0.23 | CD9-3B               | CD-800-3                   | 3000            |
| <b>PV10-6LFB-2K</b>    |             |            |                       |                 | #6        | 1.02                    | 0.30 | 0.21 |                      |                            | 2000            |
| <b>PV10-8LFB-2K</b>    |             |            |                       |                 | #8        | 1.04                    | 0.30 | 0.21 |                      |                            | 2000            |
| <b>PV10-10LFB-2K</b>   |             |            |                       |                 | #10       | 1.04                    | 0.34 | 0.21 |                      |                            | 2000            |
| <b>PV10-14LFB-2K</b>   |             |            |                       |                 | 1/4"      | 1.16                    | 0.46 | 0.32 |                      |                            | 2000            |

\*Not UL Listed or CSA Certified.  
For applicator information, see page D1.143.

A. System Overview

B1. Cable Ties

B2. Cable Accessories

B3. Stainless Steel Ties

C1. Wiring Duct

C2. Surface Raceway

C3. Abrasion Protection

C4. Cable Management

D1. Terminals

D2. Power Connectors

D3. Grounding Connectors

E1. Labeling Systems

E2. Labels

E3. Pre-Printed & Write-On Markers

E4. Permanent Identification

E5. Lockout/Tagout & Safety Solutions

F. Index

A. System Overview



## Short Locking Fork Terminals, Nylon Insulated – Non-Funnel Entry

### Type PN-SLF

B1. Cable Ties

- Continuously molded design provides reliable, consistent performance through the applicator for a high quality termination every time

- Internal barrel serrations assure good wire contact and maximum tensile strength

B2. Cable Accessories

- Lock in place for a secure connection in limited spaces
- Fork design provides for fast and easy installation, without the need to remove fastener

- UL Flammability UL 94V-2/HB, maximum insulation temperature 221°F (105°C)

B3. Stainless Steel Ties

- Metal insulation grip sleeve crimps to wire insulation, providing protection to the crimp joint during high vibration applications

- UL and CSA rated up to 600 V per UL 486A/B

C1. Wiring Duct

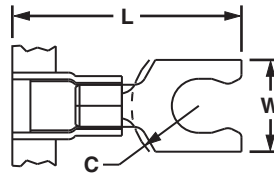

C2. Surface Raceway

| Part Number   | Wire Range  | Color Code | Stock Thickness (In.) | Max. Ins. (In.) | Stud Size | Figure Dimensions (In.) |      |      | CA9 Series Crimp Die | CA-800/EZ Series Crimp Die | Pieces Per Reel |
|---------------|-------------|------------|-----------------------|-----------------|-----------|-------------------------|------|------|----------------------|----------------------------|-----------------|
|               |             |            |                       |                 |           | L                       | W    | C    |                      |                            |                 |
| PN18-5SLF-3K  | 22 – 18 AWG | Red        | 0.03                  | 0.145           | #5        | 0.75                    | 0.26 | 0.19 | CD9-1A               | CD-800-1                   | 3000            |
| PN18-6SLF-3K  |             |            |                       |                 | #6        | 0.75                    | 0.27 | 0.19 |                      |                            | 3000            |
| PN18-8SLF-3K  |             |            |                       |                 | #8        | 0.79                    | 0.29 | 0.23 |                      |                            | 3000            |
| PN18-10SLF-3K |             |            |                       |                 | #10       | 0.80                    | 0.33 | 0.23 |                      |                            | 3000            |
| PN14-5SLF-3K  | 16 – 14 AWG | Blue       | 0.03                  | 0.162           | #5        | 0.75                    | 0.25 | 0.19 | CD9-2A               | CD-800-2                   | 3000            |
| PN14-6SLF-3K  |             |            |                       |                 | #6        | 0.75                    | 0.25 | 0.19 |                      |                            | 3000            |
| PN14-8SLF-3K  |             |            |                       |                 | #8        | 0.80                    | 0.29 | 0.23 |                      |                            | 3000            |
| PN14-10SLF-3K |             |            |                       |                 | #10       | 0.81                    | 0.33 | 0.23 |                      |                            | 3000            |
| PN10-8SLF-2K  | 12 – 10 AWG | Yellow     | 0.04                  | 0.225           | #8        | 0.92                    | 0.29 | 0.22 | CD9-3B               | CD-800-3                   | 2000            |
| PN10-10SLF-2K |             |            |                       |                 | #10       | 0.92                    | 0.33 | 0.22 |                      |                            | 2000            |

For applicator information, see page D1.143.

D1. Terminals



## Short Locking Fork Terminals, Nylon Insulated – Funnel Entry

### Type PNF-SLF

D2. Power Connectors

- Continuously molded design provides reliable, consistent performance through the applicator for a high quality termination every time

- Internal barrel serrations assure good wire contact and maximum tensile strength

D3. Grounding Connectors

- Lock in place for a secure connection in limited spaces
- Fork design provides for fast and easy installation, without the need to remove fastener

- UL Flammability UL 94V-2/HB, maximum insulation temperature 221°F (105°C)

- Metal insulation grip sleeve crimps to wire insulation, providing protection to the crimp joint during high vibration applications

- UL and CSA rated up to 600 V per UL 486A/B

E1. Labeling Systems

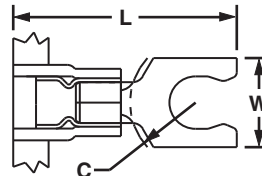

E2. Labels

E3. Pre-Printed & Write-On Markers

| Part Number          | Wire Range  | Color Code | Stock Thickness (In.) | Max. Ins. (In.) | Stud Size | Figure Dimensions (In.) |      |      | CA9 Series Crimp Die | CA-800/EZ Series Crimp Die | Pieces Per Reel |
|----------------------|-------------|------------|-----------------------|-----------------|-----------|-------------------------|------|------|----------------------|----------------------------|-----------------|
|                      |             |            |                       |                 |           | L                       | W    | C    |                      |                            |                 |
| PNF18-5SLF-3K        | 22 – 18 AWG | Red        | 0.03                  | 0.145           | #5        | 0.73                    | 0.26 | 0.19 | CD9-1A               | CD-800-1                   | 3000            |
| <b>PNF18-6SLF-3K</b> |             |            |                       |                 | #6        | 0.74                    | 0.27 | 0.19 |                      |                            | 3000            |
| PNF18-8SLF-3K        |             |            |                       |                 | #8        | 0.80                    | 0.29 | 0.23 |                      |                            | 3000            |
| PNF18-10SLF-3K       |             |            |                       |                 | #10       | 0.80                    | 0.33 | 0.23 |                      |                            | 3000            |
| PNF14-6SLF-3K        | 16 – 14 AWG | Blue       | 0.03                  | 0.162           | #6        | 0.75                    | 0.25 | 0.19 | CD9-2A               | CD-800-2                   | 3000            |
| PNF14-10SLF-3K       |             |            |                       |                 | #10       | 0.81                    | 0.33 | 0.23 |                      |                            | 3000            |
| PNF10-6SLF-2K        | 12 – 10 AWG | Yellow     | 0.04                  | 0.225           | #6        | 0.91                    | 0.25 | 0.17 | CD9-3B               | CD-800-3                   | 2000            |
| PNF10-8SLF-2K        |             |            |                       |                 | #8        | 0.92                    | 0.29 | 0.22 |                      |                            | 2000            |
| PNF10-10SLF-2K       |             |            |                       |                 | #10       | 0.93                    | 0.33 | 0.22 |                      |                            | 2000            |

For applicator information, see page D1.143.

F. Index



## Short Locking Fork Terminals, Vinyl Insulated – Funnel Entry

### Type PV-SLFB

- Continuously molded design provides reliable, consistent performance through the applicator for a high quality termination every time
- Lock in place for a secure connection in limited spaces
- Fork design provides for fast and easy installation, without the need to remove fastener

- Insulation support helps to prevent wire damage in bending applications
- UL Flammability UL 94V-0, maximum insulation temperature 221°F (105°C)
- UL and CSA rated up to 600 V per UL 486A/B

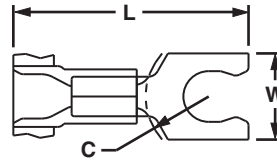

| Part Number    | Wire Range  | Color Code | Stock Thickness (In.) | Max. Ins. (In.) | Stud Size | Figure Dimensions (In.) |      |      | CA9 Series Crimp Die | CA-800/EZ Series Crimp Die | Pieces Per Reel |
|----------------|-------------|------------|-----------------------|-----------------|-----------|-------------------------|------|------|----------------------|----------------------------|-----------------|
|                |             |            |                       |                 |           | L                       | W    | C    |                      |                            |                 |
| PV18-5SLFB-3K  | 22 – 18 AWG | Red        | 0.03                  | 0.150           | #5        | 0.72                    | 0.26 | 0.19 | CD9-1A               | CD-800-1                   | 3000            |
| PV18-6SLFB-3K  |             |            |                       |                 | #6        | 0.72                    | 0.27 | 0.19 |                      |                            | 3000            |
| PV18-8SLFB-3K  |             |            |                       |                 | #8        | 0.77                    | 0.29 | 0.23 |                      |                            | 3000            |
| PV18-10SLFB-3K |             |            |                       |                 | #10       | 0.78                    | 0.33 | 0.23 |                      |                            | 3000            |
| PV14-6SLFB-3K  | 16 – 14 AWG | Blue       | 0.03                  | 0.170           | #6        | 0.75                    | 0.25 | 0.19 | CD9-2A               | CD-800-2                   | 3000            |
| PV14-8SLFB-3K  |             |            |                       |                 | #8        | 0.80                    | 0.29 | 0.23 |                      |                            | 3000            |
| PV14-10SLFB-3K |             |            |                       |                 | #10       | 0.81                    | 0.33 | 0.23 |                      |                            | 3000            |
| PV14-14SLFB-3K |             |            |                       |                 | 1/4"      | 0.90                    | 0.44 | 0.29 |                      |                            | 3000            |
| PV10-6SLFB-2K  | 12 – 10 AWG | Yellow     | 0.04                  | 0.225           | #6        | 0.84                    | 0.25 | 0.17 | CD9-3B               | CD-800-3                   | 2000            |
| PV10-8SLFB-2K  |             |            |                       |                 | #8        | 0.90                    | 0.29 | 0.22 |                      |                            | 2000            |
| PV10-10SLFB-2K |             |            |                       |                 | #10       | 0.91                    | 0.33 | 0.22 |                      |                            | 2000            |

For applicator information, see page D1.143.



## Flanged Fork Terminals, Nylon Insulated – Non-Funnel Entry

### Type PN-FF

- Continuously molded design provides reliable, consistent performance through the applicator for a high quality termination every time
- Flange design provides extra secure connection on a variety of applications
- Fork design provides for fast and easy installation, without the need to remove fastener

- Metal insulation grip sleeve crimps to wire insulation, providing protection to the crimp joint during high vibration applications
- Internal barrel serrations assure good wire contact and maximum tensile strength
- UL Flammability UL 94V-2/HB, maximum insulation temperature 221°F (105°C)
- UL and CSA rated up to 600 V per UL 486A/B

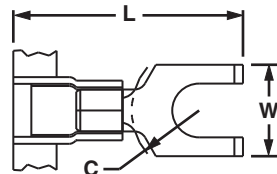

| Part Number  | Wire Range  | Color Code | Stock Thickness (In.) | Max. Ins. (In.) | Stud Size | Figure Dimensions (In.) |      |      | CA9 Series Crimp Die | CA-800/EZ Series Crimp Die | Pieces Per Reel |
|--------------|-------------|------------|-----------------------|-----------------|-----------|-------------------------|------|------|----------------------|----------------------------|-----------------|
|              |             |            |                       |                 |           | L                       | W    | C    |                      |                            |                 |
| PN18-6FF-3K  | 22 – 18 AWG | Red        | 0.03                  | 0.136           | #6        | 0.80                    | 0.28 | 0.19 | CD9-1A               | CD-800-1                   | 3000            |
| PN18-8FF-3K  |             |            |                       |                 | #8        | 0.87                    | 0.31 | 0.23 |                      |                            | 3000            |
| PN18-10FF-3K |             |            |                       |                 | #10       | 0.87                    | 0.35 | 0.23 |                      |                            | 3000            |
| PN14-6FF-3K  | 16 – 14 AWG | Blue       | 0.03                  | 0.162           | #6        | 0.80                    | 0.28 | 0.19 | CD9-2A               | CD-800-2                   | 3000            |
| PN14-8FF-3K  |             |            |                       |                 | #8        | 0.87                    | 0.31 | 0.23 |                      |                            | 3000            |
| PN14-10FF-3K |             |            |                       |                 | #10       | 0.87                    | 0.35 | 0.23 |                      |                            | 3000            |
| PN10-8FF-2K  | 12 – 10 AWG | Yellow     | 0.04                  | 0.225           | #8        | 1.05                    | 0.38 | 0.22 | CD9-3B               | CD-800-3                   | 2000            |
| PN10-10FF-2K |             |            |                       |                 | #10       | 1.05                    | 0.38 | 0.22 |                      |                            | 2000            |

For applicator information, see page D1.143.

A. System Overview



## Flanged Fork Terminals, Nylon Insulated – Funnel Entry

B1. Cable Ties

### Type PNF-FF

- Continuously molded design provides reliable, consistent performance through the applicator for a high quality termination every time
- Flange design provides extra secure connection on a variety of applications
- Fork design provides for fast and easy installation, without the need to remove fastener

- Metal insulation grip sleeve crimps to wire insulation, providing protection to the crimp joint during high vibration applications
- Internal barrel serrations assure good wire contact and maximum tensile strength
- UL Flammability UL 94V-2/HB, maximum insulation temperature 221°F (105°C)
- UL and CSA rated up to 600 V per UL 486A/B

B2. Cable Accessories

B3. Stainless Steel Ties

C1. Wiring Duct

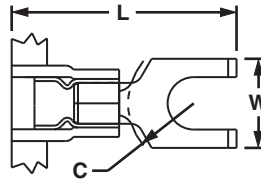

C2. Surface Raceway

C3. Abrasion Protection

C4. Cable Management

| Part Number         | Wire Range  | Color Code | Stock Thickness (In.) | Max. Ins. (In.) | Stud Size | Figure Dimensions (In.) |      |      | CA9 Series Crimp Die | CA-800/EZ Series Crimp Die | Pieces Per Reel |
|---------------------|-------------|------------|-----------------------|-----------------|-----------|-------------------------|------|------|----------------------|----------------------------|-----------------|
|                     |             |            |                       |                 |           | L                       | W    | C    |                      |                            |                 |
| PNF18-6FF-3K        | 22 – 18 AWG | Red        | 0.03                  | 0.145           | #6        | 0.80                    | 0.28 | 0.19 | CD9-1A               | CD-800-1                   | 3000            |
| <b>PNF18-8FF-3K</b> |             |            |                       |                 | #8        | 0.87                    | 0.31 | 0.23 |                      |                            | 3000            |
| PNF18-10FF-3K       |             |            |                       |                 | #10       | 0.86                    | 0.35 | 0.23 |                      |                            | 3000            |
| PNF14-6FF-3K        | 16 – 14 AWG | Blue       | 0.03                  | 0.162           | #6        | 0.80                    | 0.28 | 0.19 | CD9-2A               | CD-800-2                   | 3000            |
| PNF14-8FF-3K        |             |            |                       |                 | #8        | 0.87                    | 0.31 | 0.23 |                      |                            | 3000            |
| PNF14-10FF-3K       |             |            |                       |                 | #10       | 0.87                    | 0.35 | 0.23 |                      |                            | 3000            |
| PNF10-8FF-2K        | 12 – 10 AWG | Yellow     | 0.04                  | 0.225           | #8        | 1.05                    | 0.38 | 0.24 | CD9-3B               | CD-800-3                   | 2000            |
| PNF10-10FF-2K       |             |            |                       |                 | #10       | 1.05                    | 0.38 | 0.24 |                      |                            | 2000            |

For applicator information, see page D1.143.

D1. Terminals



## Flanged Fork Terminals, Vinyl Insulated – Funnel Entry

D2. Power Connectors

### Type PV-FFB

- Continuously molded design provides reliable, consistent performance through the applicator for a high quality termination every time
- Flange design provides extra secure connection on a variety of applications
- Fork design provides for fast and easy installation, without the need to remove fastener

- Insulation support helps to prevent wire damage in bending applications
- UL Flammability UL 94V-0, maximum insulation temperature 221°F (105°C)
- UL and CSA rated up to 600 V per UL 486A/B

D3. Grounding Connectors

E1. Labeling Systems

E2. Labels

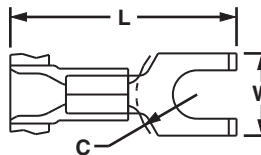

E3. Pre-Printed & Write-On Markers

E4. Permanent Identification

E5. Lockout/Tagout & Safety Solutions

| Part Number          | Wire Range  | Color Code | Stock Thickness (In.) | Max. Ins. (In.) | Stud Size | Figure Dimensions (In.) |      |      | CA9 Series Crimp Die | CA-800/EZ Series Crimp Die | Pieces Per Reel |
|----------------------|-------------|------------|-----------------------|-----------------|-----------|-------------------------|------|------|----------------------|----------------------------|-----------------|
|                      |             |            |                       |                 |           | L                       | W    | C    |                      |                            |                 |
| PV18-6FFB-3K         | 22 – 18 AWG | Red        | 0.03                  | 0.150           | #6        | 0.80                    | 0.28 | 0.19 | CD9-1A               | CD-800-1                   | 3000            |
| <b>PV18-8FFB-3K</b>  |             |            |                       |                 | #8        | 0.87                    | 0.31 | 0.23 |                      |                            | 3000            |
| PV18-10FFB-3K        |             |            |                       |                 | #10       | 0.86                    | 0.35 | 0.23 |                      |                            | 3000            |
| PV14-6FFB-3K         | 16 – 14 AWG | Blue       | 0.03                  | 0.170           | #6        | 0.80                    | 0.28 | 0.19 | CD9-2A               | CD-800-2                   | 3000            |
| PV14-8FFB-3K         |             |            |                       |                 | #8        | 0.86                    | 0.31 | 0.23 |                      |                            | 3000            |
| PV14-10FFB-3K        |             |            |                       |                 | #10       | 0.86                    | 0.35 | 0.23 |                      |                            | 3000            |
| PV10-8FFB-2K         | 12 – 10 AWG | Yellow     | 0.04                  | 0.225           | #8        | 1.03                    | 0.37 | 0.22 | CD9-3B               | CD-800-3                   | 2000            |
| <b>PV10-10FFB-2K</b> |             |            |                       |                 | #10       | 1.03                    | 0.37 | 0.22 |                      |                            | 2000            |

For applicator information, see page D1.143.



## Features and Benefits – Reel Smart™ Metric Terminals

### Metric Nylon Insulated Funnel Terminals with Insulation Grip Sleeve Type PMN or PMNF

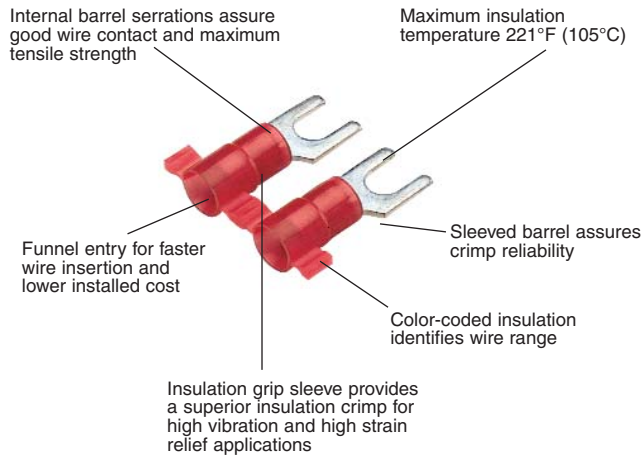

UL and CSA rated up to 600 V per UL 486A/B.  
Flammability – UL 94V-2/HB.

### Metric Nylon Insulated Funnel Terminals with Insulation Support Type PMV

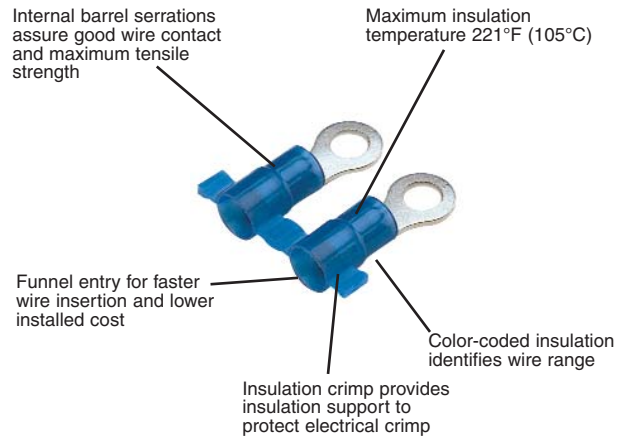

UL and CSA rated up to 600 V per UL 486A/B.  
Flammability UL 94V-0.

## Part Number System for Reel Smart™ Metric Terminals

| <u>PM</u>             | <u>V</u>  | <u>1</u>   | — | <u>3</u>  | <u>R</u>             | <u>B</u>                                    | <u>3K</u>                          |
|-----------------------|---|--|---|---|----------------------|---|------------------------------------|
| Type                  | Insulation  | Wire Range   |   | Stud Size   | Tongue Configuration | Special Configuration                       | Std. Pkg. Size                     |
| PM = Pan-Term® Metric | N = Nylon<br>NF = Nylon Funnel Entry<br>V = Vinyl | 1 = 0.5 – 1.0mm <sup>2</sup><br>or 0.5 – 1.5mm <sup>2</sup><br>2 = 1.5 – 2.5mm <sup>2</sup><br>6 = 2.5 – 6.0mm <sup>2</sup><br>or 4.0 – 6.0mm <sup>2</sup> |   | 3 = M3 (#5)<br>35 = M3.5 (#6)<br>4 = M4 (#8)<br>5 = M5 (#10)<br>6 = M6 (1/4")<br>8 = M8 (5/16") | R = Ring<br>F = Fork | B = Butted Seam<br>= Standard (leave blank) | 2K = 2,000 pcs.<br>3K = 3,000 pcs. |

A. System Overview



## Metric Ring Terminals, Nylon Insulated – Non-Funnel Entry

B1. Cable Ties

### Type PMN-R

B2. Cable Accessories

B3. Stainless Steel Ties

C1. Wiring Duct

C2. Surface Raceway

C3. Abrasion Protection

C4. Cable Management

D1. Terminals

D2. Power Connectors

D3. Grounding Connectors

E1. Labeling Systems

E2. Labels

E3. Pre-Printed & Write-On Markers

E4. Permanent Identification

E5. Lockout/Tagout & Safety Solutions

F. Index

- Continuously molded design provides reliable, consistent performance through the applicator for a high quality termination every time
- Ring tongue design assures a secure connection in high vibration applications

- Metal insulation grip sleeve crimps to wire insulation, providing protection to the crimp joint during high vibration applications
- Internal barrel serrations assure good wire contact and maximum tensile strength
- UL Flammability UL 94V-2/HB, maximum insulation temperature 221°F (105°C)
- UL and CSA rated up to 600 V per UL 486A/B

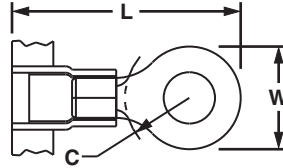

| Part Number | Wire Range (mm²) | Color Code | Max. Ins. (mm) | Stud Size | Figure Dimensions (mm) |      |     | CA9 Series Crimp Die | CA-800/EZ Series Crimp Die | Pieces Per Reel |
|-------------|------------------|------------|----------------|-----------|------------------------|------|-----|----------------------|----------------------------|-----------------|
|             |                  |            |                |           | L                      | W    | C   |                      |                            |                 |
| PMN1-3R-3K  | 0.5 – 1.0        | Red        | 3.7            | M3        | 19.3                   | 5.8  | 5.2 | CD9-1A               | CD-800-1                   | 3000            |
| PMN1-35R-3K |                  |            |                | M3.5      | 19.3                   | 5.8  | 5.2 |                      |                            | 3000            |
| PMN1-4R-3K  |                  |            |                | M4        | 21.9                   | 7.9  | 6.4 |                      |                            | 3000            |
| PMN1-5R-3K  |                  |            |                | M5        | 22.4                   | 8.9  | 6.4 |                      |                            | 3000            |
| PMN1-6R-3K  |                  |            |                | M6        | 26.7                   | 10.9 | 9.7 |                      |                            | 3000            |
| PMN2-3R-3K  |                  |            |                | 1.5 – 2.5 | Blue                   | 4.1  | M3  |                      |                            | 21.6            |
| PMN2-35R-3K | M3.5             | 21.6       | 5.8            |           |                        |      | 5.1 | 3000                 |                            |                 |
| PMN2-4R-3K  | M4               | 24.1       | 7.9            |           |                        |      | 6.5 | 3000                 |                            |                 |
| PMN2-5R-3K  | M5               | 24.6       | 8.9            |           |                        |      | 6.5 | 3000                 |                            |                 |
| PMN2-6R-3K  | M6               | 26.7       | 10.9           |           |                        |      | 9.7 | 3000                 |                            |                 |
| PMN6-3R-2K  | 4.0 – 6.0        | Yellow     | 5.7            |           |                        |      | M3  | 24.7                 | 5.8                        | 7.9             |
| PMN6-35R-2K |                  |            |                | M3.5      | 24.7                   | 5.8  | 7.9 | 2000                 |                            |                 |
| PMN6-4R-2K  |                  |            |                | M4        | 25.7                   | 7.9  | 7.9 | 2000                 |                            |                 |
| PMN6-5R-2K  |                  |            |                | M5        | 26.4                   | 9.7  | 7.9 | 2000                 |                            |                 |
| PMN6-6R-2K  |                  |            |                | M6        | 29.0                   | 10.9 | 9.7 | 2000                 |                            |                 |
| PMN6-8R-2K  |                  |            |                | M8        | 30.0                   | 13.2 | 9.7 | 2000                 |                            |                 |

For applicator information, see page D1.143.



## Metric Ring Terminals, Nylon Insulated – Funnel Entry

### Type PMNF-R

- Continuously molded design provides reliable, consistent performance through the applicator for a high quality termination every time
- Ring tongue design assures a secure connection in high vibration applications

- Metal insulation grip sleeve crimps to wire insulation, providing protection to the crimp joint during high vibration applications
- Internal barrel serrations assure good wire contact and maximum tensile strength
- UL Flammability UL 94V-2/HB, maximum insulation temperature 221°F (105°C)
- UL and CSA rated up to 600 V per UL 486A/B

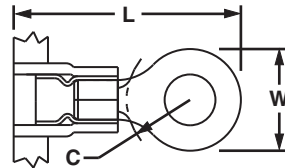

| Part Number  | Wire Range (mm <sup>2</sup> ) | Color Code | Max. Ins. (mm) | Stud Size | Figure Dimensions (mm) |      |     | CA9 Series Crimp Die | CA-800/EZ Series Crimp Die | Pieces Per Reel |
|--------------|-------------------------------|------------|----------------|-----------|------------------------|------|-----|----------------------|----------------------------|-----------------|
|              |                               |            |                |           | L                      | W    | C   |                      |                            |                 |
| PMNF1-3R-3K  | 0.5 – 1.0                     | Red        | 3.7            | M3        | 19.3                   | 5.8  | 5.2 | CD9-1A               | CD-800-1                   | 3000            |
| PMNF1-35R-3K |                               |            |                | M3.5      | 19.3                   | 5.8  | 5.2 |                      |                            | 3000            |
| PMNF1-4R-3K  |                               |            |                | M4        | 21.9                   | 7.9  | 6.4 |                      |                            | 3000            |
| PMNF1-5R-3K  |                               |            |                | M5        | 22.4                   | 8.9  | 6.4 |                      |                            | 3000            |
| PMNF1-6R-3K  |                               |            |                | M6        | 26.7                   | 10.9 | 9.7 |                      |                            | 3000            |
| PMNF2-3R-3K  | 1.5 – 2.5                     | Blue       | 4.1            | M3        | 19.4                   | 5.8  | 5.1 | CD9-2A               | CD-800-2                   | 3000            |
| PMNF2-35R-3K |                               |            |                | M3.5      | 19.4                   | 5.8  | 5.1 |                      |                            | 3000            |
| PMNF2-4R-3K  |                               |            |                | M4        | 21.8                   | 7.9  | 6.5 |                      |                            | 3000            |
| PMNF2-5R-3K  |                               |            |                | M5        | 22.4                   | 8.9  | 6.5 |                      |                            | 3000            |
| PMNF2-6R-3K  |                               |            |                | M6        | 26.5                   | 10.9 | 9.7 |                      |                            | 3000            |
| PMNF6-3R-2K  | 4.0 – 6.0                     | Yellow     | 5.7            | M3        | 24.7                   | 5.8  | 7.9 | CD9-3B               | CD-800-3                   | 2000            |
| PMNF6-35R-2K |                               |            |                | M3.5      | 24.7                   | 5.8  | 7.9 |                      |                            | 2000            |
| PMNF6-4R-2K  |                               |            |                | M4        | 25.7                   | 7.9  | 7.9 |                      |                            | 2000            |
| PMNF6-5R-2K  |                               |            |                | M5        | 26.4                   | 9.7  | 7.9 |                      |                            | 2000            |
| PMNF6-6R-2K  |                               |            |                | M6        | 29.0                   | 10.9 | 9.7 |                      |                            | 2000            |
| PMNF6-8R-2K  | M8                            | 30.0       | 13.2           | 9.7       | 2000                   |      |     |                      |                            |                 |

For applicator information, see page D1.143.

A. System Overview

B1. Cable Ties

B2. Cable Accessories

B3. Stainless Steel Ties

C1. Wiring Duct

C2. Surface Raceway

C3. Abrasion Protection

C4. Cable Management

D1. Terminals

D2. Power Connectors

D3. Grounding Connectors

E1. Labeling Systems

E2. Labels

E3. Pre-Printed & Write-On Markers

E4. Permanent Identification

E5. Lockout/Tagout & Safety Solutions

F. Index

A. System Overview



## Metric Ring Terminals, Vinyl Insulated – Funnel Entry

B1. Cable Ties

### Type PMV-RB

- Continuously molded design provides reliable, consistent performance through the applicator for a high quality termination every time
- Insulation support helps to prevent wire damage in bending applications

- Ring tongue design assures a secure connection in high vibration applications
- UL Flammability UL 94V-0, maximum insulation temperature 221°F (105°C)
- UL and CSA rated up to 600 V per UL 486A/B

B2. Cable Accessories

B3. Stainless Steel Ties

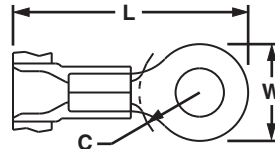

C1. Wiring Duct

C2. Surface Raceway

C3. Abrasion Protection

C4. Cable Management

D1. Terminals

D2. Power Connectors

D3. Grounding Connectors

E1. Labeling Systems

E2. Labels

E3. Pre-Printed & Write-On Markers

E4. Permanent Identification

E5. Lockout/Tagout & Safety Solutions

F. Index

| Part Number  | Wire Range (mm <sup>2</sup> ) | Color Code | Max. Ins. (mm) | Stud Size | Figure Dimensions (mm) |      |     | CA9 Series Crimp Die | CA-800/EZ Series Crimp Die | Pieces Per Reel |
|--------------|-------------------------------|------------|----------------|-----------|------------------------|------|-----|----------------------|----------------------------|-----------------|
|              |                               |            |                |           | L                      | W    | C   |                      |                            |                 |
| PMV1-3RB-3K  | 0.5 – 1.0                     | Red        | 3.7            | M3        | 19.3                   | 5.8  | 5.2 | CD9-1A               | CD-800-1                   | 3000            |
| PMV1-35RB-3K |                               |            |                | M3.5      | 19.3                   | 5.8  | 5.2 |                      |                            | 3000            |
| PMV1-4RB-3K  |                               |            |                | M4        | 21.8                   | 7.9  | 6.4 |                      |                            | 3000            |
| PMV1-5RB-3K  |                               |            |                | M5        | 22.4                   | 8.9  | 6.4 |                      |                            | 3000            |
| PMV1-6RB-3K  |                               |            |                | M6        | 26.4                   | 10.9 | 9.7 |                      |                            | 3000            |
| PMV2-3RB-3K  | 1.5 – 2.5                     | Blue       | 4.3            | M3        | 21.3                   | 5.8  | 5.1 | CD9-2A               | CD-800-2                   | 3000            |
| PMV2-35RB-3K |                               |            |                | M3.5      | 21.3                   | 5.8  | 5.1 |                      |                            | 3000            |
| PMV2-4RB-3K  |                               |            |                | M4        | 23.9                   | 7.9  | 6.5 |                      |                            | 3000            |
| PMV2-5RB-3K  |                               |            |                | M5        | 24.4                   | 8.9  | 6.5 |                      |                            | 3000            |
| PMV2-6RB-3K  |                               |            |                | M6        | 26.7                   | 10.9 | 9.7 |                      |                            | 3000            |
| PMV6-3RB-2K  | 4.0 – 6.0                     | Yellow     | 5.7            | M3        | 24.9                   | 6.1  | 7.9 | CD9-3B               | CD-800-3                   | 2000            |
| PMV6-35RB-2K |                               |            |                | M3.5      | 24.9                   | 6.1  | 7.9 |                      |                            | 2000            |
| PMV6-4RB-2K  |                               |            |                | M4        | 25.9                   | 7.9  | 7.9 |                      |                            | 2000            |
| PMV6-5RB-2K  |                               |            |                | M5        | 26.7                   | 9.4  | 7.9 |                      |                            | 2000            |
| PMV6-6RB-2K  |                               |            |                | M6        | 29.2                   | 10.9 | 9.7 |                      |                            | 2000            |
| PMV6-8RB-2K  | M8                            | 30.5       | 13.2           | 9.7       | 2000                   |      |     |                      |                            |                 |

For applicator information, see page D1.143.



## Metric Fork Terminals, Nylon Insulated – Non-Funnel Entry

### Type PMN-F

- Continuously molded design provides reliable, consistent performance through the applicator for a high quality termination every time
- Fork design provides for fast and easy installation, without the need to remove fastener
- Metal insulation grip sleeve crimps to wire insulation, providing protection to the crimp joint during high vibration applications

- Internal barrel serrations assure good wire contact and maximum tensile strength
- UL Flammability UL 94V-2/HB, maximum insulation temperature 221°F (105°C)
- UL and CSA rated up to 600 V per UL 486A/B

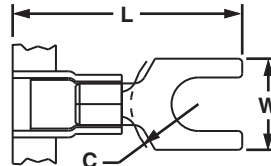

| Part Number | Wire Range (mm <sup>2</sup> ) | Color Code | Max. Ins. (mm) | Stud Size | Figure Dimensions (mm) |      |     | CA9 Series Crimp Die | CA-800/EZ Series Crimp Die | Pieces Per Reel |        |          |        |          |      |
|-------------|-------------------------------|------------|----------------|-----------|------------------------|------|-----|----------------------|----------------------------|-----------------|--------|----------|--------|----------|------|
|             |                               |            |                |           | L                      | W    | C   |                      |                            |                 |        |          |        |          |      |
| PMN1-3F-3K  | 0.5 – 1.0                     | Red        | 3.7            | M3        | 19.9                   | 5.9  | 5.0 | CD9-1A               | CD-800-1                   | 3000            |        |          |        |          |      |
| PMN1-4F-3K  |                               |            |                | M4        | 21.6                   | 8.2  | 5.8 |                      |                            | 3000            |        |          |        |          |      |
| PMN1-5F-3K  |                               |            |                | M5        | 21.8                   | 8.9  | 6.3 |                      |                            | 3000            |        |          |        |          |      |
| PMN1-6F-3K  |                               |            |                | M6        | 26.4                   | 11.2 | 8.4 |                      |                            | 3000            |        |          |        |          |      |
| PMN2-3F-3K  |                               |            |                | 1.5 – 2.5 | Blue                   | 4.1  | M3  |                      |                            | 19.8            | 5.9    | 5.1      | CD9-2A | CD-800-2 | 3000 |
| PMN2-4F-3K  |                               |            |                |           |                        |      | M4  |                      |                            | 21.3            | 7.9    | 5.9      |        |          | 3000 |
| PMN2-5F-3K  | M5                            | 21.9       | 8.6            |           |                        |      | 6.4 | 3000                 |                            |                 |        |          |        |          |      |
| PMN2-6F-3K  | M6                            | 26.2       | 11.2           |           |                        |      | 8.5 | 3000                 |                            |                 |        |          |        |          |      |
| PMN6-4F-2K  | 4.0 – 6.0                     | Yellow     | 5.7            |           |                        |      | M4  | 25.7                 | 7.9                        | 6.1             | CD9-3B | CD-800-3 |        |          | 2000 |
| PMN6-5F-2K  |                               |            |                |           |                        |      | M5  | 25.7                 | 9.5                        | 6.1             |        |          |        |          | 2000 |
| PMN6-6F-2K  |                               |            |                | M6        | 28.5                   | 11.0 | 8.2 | 2000                 |                            |                 |        |          |        |          |      |

For applicator information, see page D1.143.



## Metric Fork Terminals, Nylon Insulated – Funnel Entry

### Type PMNF-F

- Continuously molded design provides reliable, consistent performance through the applicator for a high quality termination every time
- Flange design provides extra secure connection on a variety of applications
- Fork design provides for fast and easy installation, without the need to remove fastener

- Metal insulation grip sleeve crimps to wire insulation, providing protection to the crimp joint during high vibration applications
- Internal barrel serrations assure good wire contact and maximum tensile strength
- UL Flammability UL 94V-2/HB, maximum insulation temperature 221°F (105°C)
- UL and CSA rated up to 600 V per UL 486A/B

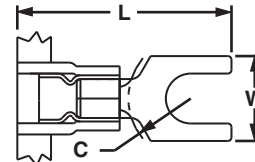

| Part Number | Wire Range (mm <sup>2</sup> ) | Color Code | Max. Ins. (mm) | Stud Size | Figure Dimensions (mm) |      |     | CA9 Series Crimp Die | CA-800/EZ Series Crimp Die | Pieces Per Reel |        |          |        |          |      |
|-------------|-------------------------------|------------|----------------|-----------|------------------------|------|-----|----------------------|----------------------------|-----------------|--------|----------|--------|----------|------|
|             |                               |            |                |           | L                      | W    | C   |                      |                            |                 |        |          |        |          |      |
| PMNF1-3F-3K | 0.5 – 1.0                     | Red        | 3.7            | M3        | 20.0                   | 5.9  | 5.0 | CD9-1A               | CD-800-1                   | 3000            |        |          |        |          |      |
| PMNF1-4F-3K |                               |            |                | M4        | 21.6                   | 8.2  | 5.8 |                      |                            | 3000            |        |          |        |          |      |
| PMNF1-5F-3K |                               |            |                | M5        | 21.8                   | 8.9  | 6.3 |                      |                            | 3000            |        |          |        |          |      |
| PMNF1-6F-3K |                               |            |                | M6        | 26.4                   | 11.2 | 8.4 |                      |                            | 3000            |        |          |        |          |      |
| PMNF2-3F-3K |                               |            |                | 1.5 – 2.5 | Blue                   | 4.1  | M3  |                      |                            | 19.8            | 5.9    | 5.1      | CD9-2A | CD-800-2 | 3000 |
| PMNF2-4F-3K |                               |            |                |           |                        |      | M4  |                      |                            | 21.3            | 7.9    | 5.9      |        |          | 3000 |
| PMNF2-5F-3K | M5                            | 21.9       | 8.6            |           |                        |      | 6.4 | 3000                 |                            |                 |        |          |        |          |      |
| PMNF2-6F-3K | M6                            | 26.2       | 11.2           |           |                        |      | 8.5 | 3000                 |                            |                 |        |          |        |          |      |
| PMNF6-4F-2K | 4.0 – 6.0                     | Yellow     | 5.7            |           |                        |      | M4  | 25.7                 | 7.9                        | 6.1             | CD9-3B | CD-800-3 |        |          | 2000 |
| PMNF6-5F-2K |                               |            |                |           |                        |      | M5  | 25.7                 | 9.5                        | 6.1             |        |          |        |          | 2000 |
| PMNF6-6F-2K |                               |            |                | M6        | 28.5                   | 11.0 | 8.2 | 2000                 |                            |                 |        |          |        |          |      |

For applicator information, see page D1.143.

A. System Overview

B1. Cable Ties

B2. Cable Accessories

B3. Stainless Steel Ties

C1. Wiring Duct

C2. Surface Raceway

C3. Abrasion Protection

C4. Cable Management

D1. Terminals

D2. Power Connectors

D3. Grounding Connectors

E1. Labeling Systems

E2. Labels

E3. Pre-Printed & Write-On Markers

E4. Permanent Identification

E5. Lockout/Tagout & Safety Solutions

F. Index

A. System Overview



## Metric Fork Terminals, Vinyl Insulated – Funnel Entry

B1. Cable Ties

### Type PMV-FB

- Continuously molded design provides reliable, consistent performance through the applicator for a high quality termination every time
- Fork design provides for fast and easy installation, without the need to remove fastener
- Insulation support helps to prevent wire damage in bending applications
- UL Flammability UL 94V-0, maximum insulation temperature 221°F (105°C)
- UL and CSA rated up to 600 V per UL 486A/B

B2. Cable Accessories

B3. Stainless Steel Ties

C1. Wiring Duct

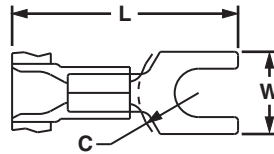

C2. Surface Raceway

C3. Abrasion Protection

C4. Cable Management

D1. Terminals

D2. Power Connectors

D3. Grounding Connectors

E1. Labeling Systems

E2. Labels

E3. Pre-Printed & Write-On Markers

E4. Permanent Identification

E5. Lockout/Tagout & Safety Solutions

F. Index

| Part Number | Wire Range (mm <sup>2</sup> ) | Color Code | Max. Ins. (mm) | Stud Size | Figure Dimensions (mm) |      |     | CA9 Series Crimp Die | CA-800/EZ Series Crimp Die | Pieces Per Reel |
|-------------|-------------------------------|------------|----------------|-----------|------------------------|------|-----|----------------------|----------------------------|-----------------|
|             |                               |            |                |           | L                      | W    | C   |                      |                            |                 |
| PMV1-3FB-3K | 0.5 – 1.0                     | Red        | 3.7            | M3        | 19.8                   | 5.8  | 5.1 | CD9-1A               | CD-800-1                   | 3000            |
| PMV1-4FB-3K |                               |            |                | M4        | 21.3                   | 8.1  | 5.8 |                      |                            | 3000            |
| PMV1-5FB-3K |                               |            |                | M5        | 21.8                   | 9.0  | 6.4 |                      |                            | 3000            |
| PMV1-6FB-3K |                               |            |                | M6        | 26.2                   | 11.2 | 8.4 |                      |                            | 3000            |
| PMV2-3FB-3K | 1.5 – 2.5                     | Blue       | 4.3            | M3        | 19.8                   | 5.9  | 5.1 | CD9-2A               | CD-800-2                   | 3000            |
| PMV2-4FB-3K |                               |            |                | M4        | 21.3                   | 7.9  | 5.8 |                      |                            | 3000            |
| PMV2-5FB-3K |                               |            |                | M5        | 21.8                   | 8.6  | 6.4 |                      |                            | 3000            |
| PMV2-6FB-3K |                               |            |                | M6        | 26.2                   | 11.2 | 8.5 |                      |                            | 3000            |
| PMV6-4FB-2K | 4.0 – 6.0                     | Yellow     | 5.7            | M4        | 25.9                   | 7.9  | 6.2 | CD9-3B               | CD-800-3                   | 2000            |
| PMV6-5FB-2K |                               |            |                | M5        | 25.9                   | 9.7  | 6.2 |                      |                            | 2000            |
| PMV6-6FB-2K |                               |            |                | M6        | 28.7                   | 11.0 | 8.2 |                      |                            | 2000            |

For applicator information, see page D1.143.



## Features and Benefits – Reel Smart™ Disconnects

### Supra-Grip™ Nylon Fully Insulated Funnel Entry, Female Receptacle Type DNG-FB

Available in tab sizes to accommodate .187" or .250" tabs

Fully insulated design provides protection from electrical shorts

Maximum insulation temperature 221°F (105°C)

Continuously molded design provides reliable, consistent performance through applicator

Funnel entry for faster wire insertion and lower installed cost

Fully integrated metal insulation grip for high vibration, high strain relief, and double crimp requirements



UL and CSA Rated up to 600 V per UL 310.  
Flammability UL 94V-2/HB.

### Disco-Lok™ Nylon Fully Insulated, Funnel Entry, Female Receptacle Type DNG-FL

Available in tab sizes to accommodate .250" tabs

Maximum insulation temperature 221°F (105°C)

Continuously molded design provides reliable, consistent performance through applicator

Funnel entry for faster wire insertion and lower installed cost

Unique locking mechanism allows for low insertion (mating) and positive locking for secure connections

Insulation grip sleeve provides a superior insulation crimp for high vibration and high strain relief applications



UL and CSA rated up to 300 V.  
Flammability UL 94V-2/HB.

### Standard and Premium Nylon Fully Insulated, Funnel Entry, Females Receptacles and Male Tabs Type DPF

Available in tab sizes to accommodate .110", .187", .205" or .250" tabs

Maximum insulation temperature 257°F (125°C)

Continuously molded design provides reliable, consistent performance through applicator

Funnel entry for faster wire insertion and lower installed cost

Fully insulated design provides protection from electrical shorts

Insulation support restricts excessive wire movement to minimize stress on crimp joint

Expanded wire entry (on select sizes) accommodates large insulation or multiple wires

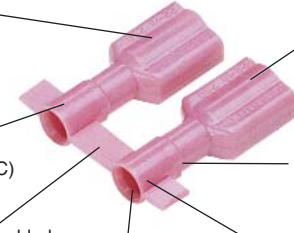

UL and CSA Rated up to 600 V per UL 310.  
Flammability UL 94V-2.

### Vinyl Barrel Insulated Funnel Entry, Female Receptacles and Male Tabs Type DV

Available in tab sizes to accommodate .187", .205", or .250" tabs

Continuously molded design provides reliable, consistent performance through applicator

Insulation grip sleeve provides a superior insulation crimp for high vibration and high strain relief applications

Insulation support to protect electrical crimp

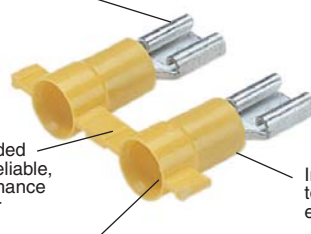

UL and CSA Rated up to 600 V.  
Flammability UL 94V-0.



High speed electric presses provide for fast terminations.

See page D1.144.



Fully Automatic Cable Tie Installation Systems offer an efficient solution for high volume harnessing, assembly, fastening and packaging applications.

See pages B1.113 – B1.122.

A. System Overview

B1. Cable Ties

B2. Cable Accessories

B3. Stainless Steel Ties

C1. Wiring Duct

C2. Surface Raceway

C3. Abrasion Protection

C4. Cable Management

D1. Terminals

D2. Power Connectors

D3. Grounding Connectors

E1. Labeling Systems

E2. Labels

E3. Pre-Printed & Write-On Markers

E4. Permanent Identification

E5. Lockout/Tagout & Safety Solutions

F. Index

## Part Number System for Reel Smart™ Disconnects

| D               | NF   | 14  | — | 250   | FIB   | 3K  |
|-----------------|--|---|---|---|---|---|
| Type            | Insulation   | Wire Range                                      |   | Size and Type   | Special Configuration   | Std. Pkg. Size                                      |
| D = Disconnects | NF = Nylon Funnel Entry<br>NG = Nylon Funnel Entry Metal Insulation Grip<br>NFR = Nylon Funnel Entry Right Angle<br>PF = Premium Grade Nylon (Double Crimp)<br>V = Vinyl | 18 = #22 – 18<br>14 = #16 – 14<br>10 = #12 – 10 |   | 110 = 0.110 x 0.032 tab size<br>111 = 0.110 x 0.020 tab size<br>145 = 0.145 x 0.032 tab size<br>187 = 0.187 x 0.032 tab size<br>188 = 0.187 x 0.020 tab size<br>205 = 0.187/0.205 x 0.032 tab size<br>206 = 0.187/0.205 x 0.020 tab size<br>250 = 0.250 x 0.032 tab size<br><br>0.187/0.205: Expandable receptacle will accept male tabs from 0.187" to 0.205" widths in 0.032" or 0.020" thick styles. Fully reliable connection through all widths. | B = Butted seam<br>C = Compression Tab<br>FB = Metal Insulation Grip, Female<br>FL = Fully Insulated Positive Locking Female<br>FIB = Fully Insulated, Butted Seam, Female<br>FIBX = Fully Insulated, Butted Seam, Female, Expanded Wire Entry<br>FIM = Fully Insulated Male<br>FIMB = Fully Insulated, Male, Oversized Housing<br>FIMX = Fully Insulated, Male, Expanded Wire Entry<br>M = Male<br>MB = Male Butted Seam | K = 1,000<br>KD = 1,500<br>2K = 2,000<br>3K = 3,000 |

### UL LISTED CERTIFIED Supra-Grip™ Female Disconnects, Nylon Fully Insulated – Funnel Entry

#### Type DNG-FB

- Continuously molded design provides reliable, consistent performance through the applicator for a high quality termination every time
- Disconnect can be inserted and removed from the male tab without the use of tools for lower installed cost
- Flared barrel extension integrated into stamping to provide insulation grip for double crimp requirements
- Internal barrel serrations assure good wire contact and maximum tensile strength
- Internal wire stop assures proper length of insertion into terminal barrel, providing a higher-quality connection
- Mates with DNF-FIMB family
- UL Flammability UL 94V-2/HB, maximum insulation temperature 221°F (105°C)
- UL and CSA rated up to 600 V per UL 310



| Part Number            | Wire Range  | Color Code | Max. Ins. (In.) | Figure Dimensions (In.) |      |      | Tab Size      |           | CA9 Series Crimp Die | CA-800/EZ Series Crimp Die | Pieces Per Reel |
|------------------------|-------------|------------|-----------------|-------------------------|------|------|---------------|-----------|----------------------|----------------------------|-----------------|
|                        |             |            |                 | L                       | W    | H    | In.           | mm        |                      |                            |                 |
| <b>DNG18-187FB-3K</b>  | 22 – 18 AWG | Red        | 0.126           | 0.89                    | 0.29 | 0.22 | 0.187 x 0.032 | 4.8 x 0.8 | CD9-15A              | CD-800-15                  | 3000            |
| <b>DNG18-188FB-3K</b>  |             |            |                 | 0.89                    | 0.29 | 0.22 | 0.187 x 0.020 | 4.8 x 0.5 |                      |                            | 3000            |
| <b>DNG18-250FB-3K</b>  |             |            |                 | 0.93                    | 0.35 | 0.23 | 0.250 x 0.032 | 6.3 x 0.8 |                      |                            | 3000            |
| <b>DNG14-187FB-3K*</b> | 16 – 14 AWG | Blue       | 0.153           | 0.89                    | 0.29 | 0.25 | 0.187 x 0.032 | 4.8 x 0.8 | CD9-16A              | CD-800-16                  | 3000            |
| <b>DNG14-188FB-3K</b>  |             |            |                 | 0.89                    | 0.29 | 0.25 | 0.187 x 0.020 | 4.8 x 0.5 |                      |                            | 3000            |
| <b>DNG14-250FB-3K</b>  |             |            |                 | 0.93                    | 0.35 | 0.25 | 0.250 x 0.032 | 6.3 x 0.8 |                      |                            | 3000            |

\*UL Recognized for copper alloy tabs only.  
For applicator information, see page D1.143.

## Disco-Lok™ Female Disconnects, Nylon Fully Insulated – Funnel Entry

### Type DNG-FL

- Continuously molded design provides reliable, consistent performance through the applicator for a high quality termination every time
- Disconnect can be inserted and removed from the male tab without the use of tools for lower installed cost
- Unique locking mechanism design allows for low insertion forces (mating) and positive lock for high vibration applications where a secure connection is mandatory
- Fully insulated design provides protection from electrical shorts
- Flared barrel extension integrated into stamping to provide insulation grip for double crimp requirements
- Insulation housing moves back and forth to engage and disengage locking mechanism for repeated use
- Specialty tool required to install this disconnect (CT-1014)
- Mates with DNF-FIMB family
- UL Flammability UL 94V-2/HB, maximum insulation temperature 221°F (105°C)
- Rated up to 300 V

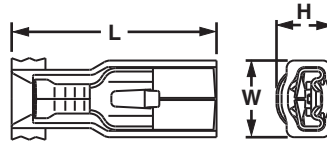

| Part Number           | Wire Range  | Color Code | Max. Ins. (In.) | Figure Dimensions (In.) |      |      | Tab Size      |           | CA9 Series Crimp Die | CA-800/EZ Series Crimp Die | Pieces Per Reel |
|-----------------------|-------------|------------|-----------------|-------------------------|------|------|---------------|-----------|----------------------|----------------------------|-----------------|
|                       |             |            |                 | L                       | W    | H    | In.           | mm        |                      |                            |                 |
| <b>DNG18-250FL-3K</b> | 22 – 18 AWG | Red        | 0.126           | 0.97                    | 0.36 | 0.24 | 0.250 x 0.032 | 6.3 x 0.8 | CD9-14A              | CD-800-14                  | 3000            |
| <b>DNG14-250FL-3K</b> | 16 – 14 AWG | Blue       | 0.150           | 0.97                    | 0.36 | 0.25 | 0.250 x 0.032 | 6.3 x 0.8 | CD9-14A              | CD-800-14                  | 3000            |

For applicator information, see page D1.143.

## Female Disconnects, Nylon Fully Insulated – Funnel Entry

### Type DNF-FIB

- Continuously molded design provides reliable, consistent performance through the applicator for a high quality termination every time
- Disconnect can be inserted and removed from the male tab without the use of tools for lower installed cost
- Fully insulated design provides protection from electrical shorts
- Disconnects available in common industry tab sizes
- Internal wire stop assures proper length of insertion into terminal barrel, providing a higher quality connection
- UL Flammability UL 94V-2/HB, maximum insulation temperature 221°F (105°C)
- UL and CSA rated up to 600 V per UL 310

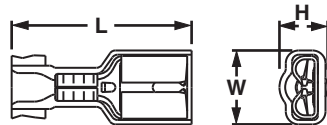

| Part Number              | Wire Range  | Color Code | Max. Ins. (In.) | Figure Dimensions (In.) |      |      | Tab Size            |               | CA9 Series Crimp Die | CA-800/EZ Series Crimp Die | Pieces Per Reel |
|--------------------------|-------------|------------|-----------------|-------------------------|------|------|---------------------|---------------|----------------------|----------------------------|-----------------|
|                          |             |            |                 | L                       | W    | H    | In.                 | mm            |                      |                            |                 |
| <b>DNF18-110FIB-3K</b>   | 22 – 18 AWG | Red        | 0.120           | 0.71                    | 0.19 | 0.15 | 0.110 x 0.032       | 2.8 x 0.8     | CD9-7A               | CD-800-7                   | 3000            |
| <b>DNF18-111FIB-3K</b>   |             | Red        | 0.120           | 0.71                    | 0.19 | 0.15 | 0.110 x 0.020       | 2.8 x 0.5     | CD9-7A               | CD-800-7                   | 3000            |
| <b>DNF18-112FIB-3K*</b>  |             | Natural    | 0.120           | 0.71                    | 0.19 | 0.15 | 0.110 x 0.010       | 2.8 x 0.3     | CD9-7A               | CD-800-7                   | 3000            |
| <b>DNF18-187FIB-3K</b>   |             | Red        | 0.136           | 0.78                    | 0.29 | 0.16 | 0.187 x 0.032       | 4.8 x 0.8     | CD9-4A               | CD-800-4                   | 3000            |
| <b>DNF18-188FIB-3K</b>   |             | Red        | 0.136           | 0.78                    | 0.29 | 0.16 | 0.187 x 0.020       | 4.8 x 0.5     | CD9-4A               | CD-800-4                   | 3000            |
| <b>DNF18-205FIB-3K</b>   |             | Red        | 0.136           | 0.78                    | 0.31 | 0.22 | 0.187/0.205 x 0.032 | 4.8/5.2 x 0.8 | CD9-4A               | CD-800-4                   | 3000            |
| <b>DNF18-206FIB-3K</b>   |             | Red        | 0.136           | 0.78                    | 0.31 | 0.22 | 0.187/0.205 x 0.020 | 4.8/5.2 x 0.5 | CD9-4A               | CD-800-4                   | 3000            |
| <b>DNF18-250FIB-3K**</b> |             | Red        | 0.136           | 0.84                    | 0.35 | 0.22 | 0.250 x 0.032       | 6.3 x 0.8     | CD9-4A               | CD-800-4                   | 3000            |
| <b>DNF14-187FIB-3K</b>   | 16 – 14 AWG | Blue       | 0.160           | 0.78                    | 0.29 | 0.18 | 0.187 x 0.032       | 4.8 x 0.8     | CD9-5A               | CD-800-5                   | 3000            |
| <b>DNF14-188FIB-3K</b>   |             |            | 0.160           | 0.78                    | 0.29 | 0.18 | 0.187 x 0.020       | 4.8 x 0.5     | CD9-5A               | CD-800-5                   | 3000            |
| <b>DNF14-205FIB-3K</b>   |             |            | 0.160           | 0.78                    | 0.31 | 0.22 | 0.187/0.205 x 0.032 | 4.8/5.2 x 0.8 | CD9-5A               | CD-800-5                   | 3000            |
| <b>DNF14-206FIB-3K</b>   |             |            | 0.160           | 0.78                    | 0.31 | 0.22 | 0.187/0.205 x 0.020 | 4.8/5.2 x 0.5 | CD9-5A               | CD-800-5                   | 3000            |
| <b>DNF14-250FIB-3K</b>   |             |            | 0.160           | 0.84                    | 0.35 | 0.22 | 0.250 x 0.032       | 6.3 x 0.8     | CD9-5A               | CD-800-5                   | 3000            |
| <b>DNF10-250FIB-2K</b>   | 12 – 10 AWG | Yellow     | 0.220           | 0.96                    | 0.35 | 0.23 | 0.250 x 0.032       | 6.3 x 0.8     | CD9-13B              | CD-800-13                  | 2000            |
| <b>DNF10250FIB-2K†</b>   |             |            | 0.220           | 0.96                    | 0.35 | 0.23 | 0.250 x 0.032       | 6.4 x 0.8     | CD9-13B              | CD-800-13                  | 2000            |

\*UL/CSA standards do not exist for 0.110" x 0.010" receptacles.

\*\*UL with 17 AWG wire.

†Compressor tab disconnect to fit 0.250" tabs with a post style support.

For applicator information, see page D1.143.

A. System Overview



## Disco™ Female Disconnects, Nylon Fully Insulated – Expanded Wire Entry

B1. Cable Ties

### Type DNF-FIBX

- Continuously molded design provides reliable, consistent performance through the applicator for a high quality termination every time
- Disconnect can be inserted and removed from the male tab without the use of tools for lower installed cost
- Expanded wire entry designed to accommodate wire with a larger insulation thickness
- Fully insulated design provides protection from electrical shorts
- Internal wire stop assures proper length of insertion into terminal barrel, providing a higher quality connection
- UL Flammability UL 94V-2/HB, maximum insulation temperature 221°F (105°C)
- UL and CSA rated up to 600 V per UL 310

B2. Cable Accessories

B3. Stainless Steel Ties

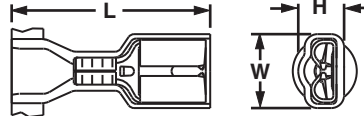

C1. Wiring Duct

C2. Surface Raceway

| Part Number            | Wire Range  | Color Code | Max. Ins. (In.) | Figure Dimensions (In.) |      |      | Tab Size            |               | CA9 Series Crimp Die | CA-800/EZ Series Crimp Die | Pieces Per Reel |
|------------------------|-------------|------------|-----------------|-------------------------|------|------|---------------------|---------------|----------------------|----------------------------|-----------------|
|                        |             |            |                 | L                       | W    | H    | In.                 | mm            |                      |                            |                 |
| <b>DNF18205FIBX-2K</b> | 22 – 18 AWG | Red        | 0.210           | 0.87                    | 0.31 | 0.22 | 0.187/0.205 x 0.032 | 4.8/5.2 x 0.8 | CD9-6B               | CD-800-6                   | 2000            |
| <b>DNF18206FIBX-2K</b> |             |            |                 | 0.87                    | 0.31 | 0.22 | 0.187/0.205 x 0.020 | 4.8/5.2 x 0.5 |                      |                            | 2000            |
| <b>DNF18250FIBX-2K</b> |             |            |                 | 0.93                    | 0.35 | 0.22 | 0.250 x 0.032       | 6.3 x 0.8     |                      |                            | 2000            |
| <b>DNF14205FIBX-2K</b> | 16 – 14 AWG | Blue       | 0.240           | 0.87                    | 0.31 | 0.22 | 0.187/0.205 x 0.032 | 4.8/5.2 x 0.8 | CD9-8B               | CD-800-8                   | 2000            |
| <b>DNF14206FIBX-2K</b> |             |            |                 | 0.87                    | 0.31 | 0.22 | 0.187/0.205 x 0.020 | 4.8/5.2 x 0.5 |                      |                            | 2000            |
| <b>DNF14250FIBX-2K</b> |             |            |                 | 0.93                    | 0.35 | 0.22 | 0.250 x 0.032       | 6.3 x 0.8     |                      |                            | 2000            |

For applicator information, see page D1.143.

D1. Terminals



## Disco™ Female Disconnects, Nylon Fully Insulated – Right Angle

D2. Power Connectors

### Type DNFR-FIB

- Continuously molded design provides reliable, consistent performance through the applicator for a high quality termination every time
- Right angle design for use in limited space applications
- Fully insulated design provides protection from electrical shorts
- Internal wire stop assures proper length of insertion into terminal barrel, providing a higher quality connection
- Disconnect can be inserted and removed from the male tab without the use of tools for lower installed cost
- UL Flammability UL 94V-2/HB, maximum insulation temperature 221°F (105°C)
- UL and CSA rated up to 600 V per UL 310

D3. Grounding Connectors

E1. Labeling Systems

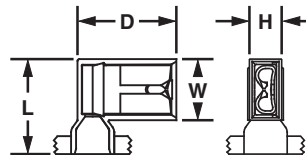

E2. Labels

E3. Pre-Printed & Write-On Markers

| Part Number            | Wire Range  | Color Code | Max. Ins. (In.) | Figure Dimensions (In.) |      |      |      | Tab Size            |               | CA9 Series Crimp Die | CA-800/EZ Series Crimp Die | Pieces Per Reel |
|------------------------|-------------|------------|-----------------|-------------------------|------|------|------|---------------------|---------------|----------------------|----------------------------|-----------------|
|                        |             |            |                 | L                       | W    | H    | D    | In.                 | mm            |                      |                            |                 |
| <b>DNFR18205FIB-KD</b> | 22 – 18 AWG | Red        | 0.178           | 0.57                    | 0.37 | 0.21 | 0.60 | 0.187/0.205 x 0.032 | 4.8/5.2 x 0.8 | CD9-9C               | CD-800-9                   | 1500            |
| <b>DNFR18206FIB-KD</b> |             |            |                 | 0.57                    | 0.37 | 0.21 | 0.60 | 0.187/0.205 x 0.020 | 4.8/5.2 x 0.5 |                      |                            | 1500            |
| <b>DNFR18250FIB-KD</b> |             |            |                 | 0.57                    | 0.37 | 0.21 | 0.60 | 0.250 x 0.032       | 6.3 x 0.8     |                      |                            | 1500            |
| <b>DNFR14205FIB-KD</b> | 16 – 14 AWG | Blue       | 0.178           | 0.57                    | 0.37 | 0.21 | 0.60 | 0.187/0.205 x 0.032 | 4.8/5.2 x 0.8 | CD9-9C               | CD-800-9                   | 1500            |
| <b>DNFR14206FIB-KD</b> |             |            |                 | 0.57                    | 0.37 | 0.21 | 0.60 | 0.187/0.205 x 0.020 | 4.8/5.2 x 0.5 |                      |                            | 1500            |
| <b>DNFR14250FIB-KD</b> |             |            |                 | 0.57                    | 0.37 | 0.21 | 0.60 | 0.250 x 0.032       | 6.3 x 0.8     |                      |                            | 1500            |

For applicator information, see page D1.143.

F. Index



## Disco™ Female Disconnects, Vinyl Barrel Insulated – Funnel Entry

### Type DV-B

- Continuously molded design provides reliable, consistent performance through the applicator for a high quality termination every time
- Disconnect can be inserted and removed from the male tab without the use of tools for lower installed cost
- Internal barrel serrations assure good wire contact and maximum tensile strength
- Internal wire stop assures proper length of insertion into terminal barrel, providing a higher quality connection
- UL Flammability UL 94V-0, maximum insulation temperature 221°F (105°C)
- UL and CSA rated up to 600 V per UL 310

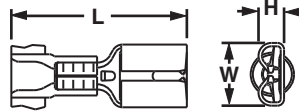

| Part Number     | Wire Range  | Color Code | Max. Ins. (In.) | Figure Dimensions (In.) |      |      | Tab Size            |               | CA9 Series Crimp Die | CA-800/EZ Series Crimp Die | Pieces Per Reel |
|-----------------|-------------|------------|-----------------|-------------------------|------|------|---------------------|---------------|----------------------|----------------------------|-----------------|
|                 |             |            |                 | L                       | W    | H    | In.                 | mm            |                      |                            |                 |
| DV18-187B-3K    | 22 – 18 AWG | Red        | 0.150           | 0.77                    | 0.23 | 0.10 | 0.187 x 0.032       | 4.8 x 0.8     | CD9-1A               | CD-800-1                   | 3000            |
| DV18-188B-3K    |             |            | 0.150           | 0.77                    | 0.23 | 0.09 | 0.187 x 0.020       | 4.8 x 0.5     |                      |                            | 3000            |
| DV18-205B-3K    |             |            | 0.150           | 0.77                    | 0.25 | 0.12 | 0.187/0.205 x 0.032 | 4.8/5.2 x 0.8 |                      |                            | 3000            |
| DV18-206B-3K    |             |            | 0.150           | 0.77                    | 0.25 | 0.11 | 0.187/0.205 x 0.020 | 4.8/5.2 x 0.5 |                      |                            | 3000            |
| DV18-250B-3K    |             |            | 0.150           | 0.83                    | 0.29 | 0.12 | 0.250 x 0.032       | 6.3 x 0.8     |                      |                            | 3000            |
| DV14-187B-3K    | 16 – 14 AWG | Blue       | 0.170           | 0.77                    | 0.23 | 0.10 | 0.187 x 0.032       | 4.8 x 0.8     | CD9-2A               | CD-800-2                   | 3000            |
| DV14-188B-3K    |             |            | 0.170           | 0.77                    | 0.23 | 0.09 | 0.187 x 0.020       | 4.8 x 0.5     |                      |                            | 3000            |
| DV14-205B-3K    |             |            | 0.170           | 0.77                    | 0.25 | 0.12 | 0.187/0.205 x 0.032 | 4.8/5.2 x 0.8 |                      |                            | 3000            |
| DV14-206B-3K    |             |            | 0.170           | 0.77                    | 0.25 | 0.11 | 0.187/0.205 x 0.020 | 4.5/5.2 x 0.5 |                      |                            | 3000            |
| DV14-250B-3K    |             |            | 0.170           | 0.83                    | 0.29 | 0.12 | 0.250 x 0.032       | 6.3 x 0.8     |                      |                            | 3000            |
| DV10-250-2K*    | 12 – 10 AWG | Yellow     | 0.230           | 0.95                    | 0.29 | 0.12 | 0.250 x 0.032       | 6.3 x 0.8     | CD9-3B               | CD-800-3                   | 2000            |
| DV10-250C-2K†** |             |            | 0.230           | 0.95                    | 0.29 | 0.12 | 0.250 x 0.032       | 6.4 x 0.8     |                      |                            | 2000            |

\*Not UL Listed or CSA Certified.

\*\*UL Recognized and CSA Certified.

†Compression tab disconnect to fit 0.250" tabs with a post style support.

For applicator information, see page D1.143.

A. System Overview

B1. Cable Ties

B2. Cable Accessories

B3. Stainless Steel Ties

C1. Wiring Duct

C2. Surface Raceway

C3. Abrasion Protection

C4. Cable Management

D1. Terminals

D2. Power Connectors

D3. Grounding Connectors

E1. Labeling Systems

E2. Labels

E3. Pre-Printed & Write-On Markers

E4. Permanent Identification

E5. Lockout/Tagout & Safety Solutions

F. Index



A. System Overview



## DiscoGrip™ Female Disconnects, Fully Insulated

B1. Cable Ties

### Type DPF-FIB

B2. Cable Accessories

B3. Stainless Steel Ties

C1. Wiring Duct

C2. Surface Raceway

C3. Abrasion Protection

C4. Cable Management

D1. Terminals

D2. Power Connectors

D3. Grounding Connectors

E1. Labeling Systems

E2. Labels

E3. Pre-Printed & Write-On Markers

E4. Permanent Identification

E5. Lockout/Tagout & Safety Solutions

F. Index

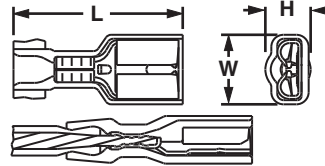

Cross section of DiscoGrip™ Crimp showing insulation crimp of the wire insulation.

- Continuously molded design provides reliable, consistent performance through the applicator for a high quality termination every time
- Disconnect can be inserted and removed from the male tab without the use of tools for lower installed cost
- Premium nylon insulation retains its shape when crimped and provides a tight grip around the wire insulation for maximum strain relief
- Fully insulated design provides protection from electrical shorts
- Internal wire stop assures proper length of insertion into terminal barrel, providing a higher quality connection
- UL Flammability UL 94V-2, maximum insulation temperature 221°F (105°C)
- UL and CSA rated up to 600 V per UL 310

| Part Number            | Wire Range  | Color Code | Max. Ins. (In.) | Figure Dimensions (In.) |       |      | Tab Size            |               | CA9 Series Crimp Die | CA-800/EZ Series Crimp Die | Pieces Per Reel |
|------------------------|-------------|------------|-----------------|-------------------------|-------|------|---------------------|---------------|----------------------|----------------------------|-----------------|
|                        |             |            |                 | L                       | W     | H    | In.                 | mm            |                      |                            |                 |
| <b>DPF18-110FIB-3K</b> | 22 – 18 AWG | Red        | 0.132           | 0.71                    | 0.19  | 0.17 | 0.110 x 0.032       | 2.8 x 0.8     | CD9-12A              | CD-800-12                  | 3000            |
| <b>DPF18-111FIB-3K</b> |             |            | 0.132           | 0.71                    | 0.19  | 0.17 | 0.110 x 0.020       | 2.8 x 0.5     |                      |                            | 3000            |
| <b>DPF18-187FIB-3K</b> |             |            | 0.136           | 0.78                    | 0.29  | 0.16 | 0.187 x 0.032       | 4.8 x 0.8     |                      |                            | 3000            |
| <b>DPF18-188FIB-3K</b> |             |            | 0.136           | 0.78                    | 0.29  | 0.16 | 0.187 x 0.020       | 4.8 x 0.5     | CD9-10A              | CD-800-10                  | 3000            |
| <b>DPF18-205FIB-3K</b> |             |            | 0.136           | 0.78                    | 0.31  | 0.22 | 0.187/0.205 x 0.032 | 4.8/5.2 x 0.8 |                      |                            | 3000            |
| <b>DPF18-206FIB-3K</b> |             |            | 0.136           | 0.78                    | 0.31  | 0.22 | 0.187/0.205 x 0.020 | 4.8/5.2 x 0.5 |                      |                            | 3000            |
| <b>DPF18-250FIB-3K</b> |             |            | 0.136           | 0.84                    | 0.35  | 0.22 | 0.250 x 0.032       | 6.3 x 0.8     | CD9-11A              | CD-800-11                  | 3000            |
| <b>DPF14-187FIB-3K</b> |             |            | 16 – 14 AWG     | Blue                    | 0.160 | 0.78 | 0.29                | 0.18          |                      |                            | 0.187 x 0.032   |
| <b>DPF14-205FIB-3K</b> | 0.160       | 0.78       |                 |                         | 0.31  | 0.22 | 0.187/0.205 x 0.032 | 4.8/5.2 x 0.8 |                      |                            | 3000            |
| <b>DPF14-206FIB-3K</b> | 0.160       | 0.78       |                 |                         | 0.31  | 0.22 | 0.187/0.205 x 0.020 | 4.8/5.2 x 0.5 |                      |                            | 3000            |
| <b>DPF14-250FIB-3K</b> | 0.160       | 0.84       |                 |                         | 0.35  | 0.22 | 0.250 x 0.032       | 6.3 x 0.8     | 3000                 |                            |                 |
| <b>DPF10-250FIB-2K</b> | 12 – 10 AWG | Yellow     | 0.220           | 0.96                    | 0.35  | 0.23 | 0.250 x 0.032       | 6.3 x 0.8     | CD9-13B              | CD-800-13                  | 2000            |

For applicator information, see page D1.143.





## DiscoGrip™ Male Disconnects, Fully Insulated

### Type DPF-FIM

- Continuously molded design provides reliable, consistent performance through the applicator for a high quality termination every time
- Disconnect can be inserted and removed from the male tab without the use of tools for lower installed cost
- Fully insulated design provides protection from electrical shorts
- Premium nylon insulation retains its shape when crimped and provides a tight grip around the wire insulation for maximum strain relief

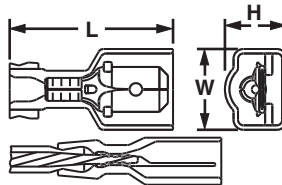

Cross section of DiscoGrip™ Crimp showing insulation crimp of the wire insulation.

- Oversized housing designed for maximum versatility to mate with most commercially available fully insulated female disconnects
- Internal wire stop assures proper length of insertion into terminal barrel, providing a higher quality connection
- UL Flammability UL 94V-2, maximum insulation temperature 221°F (105°C)
- UL and CSA rated up to 600 V per UL 310

| Part Number              | Wire Range  | Color Code | Max. Ins. (In.) | Figure Dimensions (In.) |      |      | Tab Size      |           | CA9 Series Crimp Die | CA-800/EZ Series Crimp Die | Pieces Per Reel |
|--------------------------|-------------|------------|-----------------|-------------------------|------|------|---------------|-----------|----------------------|----------------------------|-----------------|
|                          |             |            |                 | L                       | W    | H    | In.           | mm        |                      |                            |                 |
| <b>Standard Housing</b>  |             |            |                 |                         |      |      |               |           |                      |                            |                 |
| DPF18-250FIM-2K          | 22 – 18 AWG | Red        | 0.133           | 0.90                    | 0.41 | 0.29 | 0.250 x 0.032 | 6.3 x 0.8 | CD9-10B              | CD-800-10                  | 2000            |
| DPF14-250FIM-2K          | 16 – 14 AWG | Blue       | 0.156           |                         |      |      |               |           | CD9-11B              | CD-800-11                  | 2000            |
| <b>Oversized Housing</b> |             |            |                 |                         |      |      |               |           |                      |                            |                 |
| DPF18-250FIMB-K*         | 22 – 18 AWG | Red        | 0.133           | 0.92                    | 0.46 | 0.34 | 0.250 x 0.032 | 6.3 x 0.8 | CD9-10B              | CD-800-10                  | 1000            |
| DPF14-250FIMB-K*         | 16 – 14 AWG | Blue       | 0.156           |                         |      |      |               |           | CD9-11B              | CD-800-11                  | 1000            |

\*To mate with other manufacturers fully insulated 0.250 x 0.032 female receptacles. For applicator information, see page D1.143.

A. System Overview

B1. Cable Ties

B2. Cable Accessories

B3. Stainless Steel Ties

C1. Wiring Duct

C2. Surface Raceway

C3. Abrasion Protection

C4. Cable Management

D1. Terminals

D2. Power Connectors

D3. Grounding Connectors

E1. Labeling Systems

E2. Labels

E3. Pre-Printed & Write-On Markers

E4. Permanent Identification

E5. Lockout/Tagout & Safety Solutions

F. Index

A. System Overview



## Disco™ Male Disconnects, Nylon Fully Insulated – Funnel Entry

B1. Cable Ties

### Type DNF-FIM

- Continuously molded design provides reliable, consistent performance through the applicator for a high quality termination every time
- Male tab couples with (all 0.250 x 0.032) female disconnects
- Fully insulated design provides protection from electrical shorts

- Male tab can be inserted and removed from the female disconnect without the use of tools for lower installed cost
- UL Flammability UL 94V-2/HB, maximum insulation temperature 221°F (105°C)
- UL and CSA rated up to 600 V per UL 310

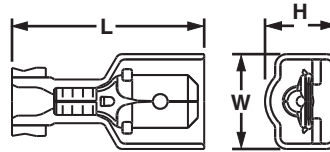

B2. Cable Accessories

B3. Stainless Steel Ties

C1. Wiring Duct

C2. Surface Raceway

C3. Abrasion Protection

C4. Cable Management

D1. Terminals

D2. Power Connectors

D3. Grounding Connectors

E1. Labeling Systems

E2. Labels

E3. Pre-Printed & Write-On Markers

E4. Permanent Identification

E5. Lockout/Tagout & Safety Solutions

F. Index

| Part Number              | Wire Range  | Color Code | Max. Ins. (In.) | Figure Dimensions (In.) |      |      | Tab Size      |           | CA9 Series Crimp Die | CA-800/EZ Series Crimp Die | Pieces Per Reel |
|--------------------------|-------------|------------|-----------------|-------------------------|------|------|---------------|-----------|----------------------|----------------------------|-----------------|
|                          |             |            |                 | L                       | W    | H    | In.           | mm        |                      |                            |                 |
| <b>Standard Housing</b>  |             |            |                 |                         |      |      |               |           |                      |                            |                 |
| <b>DNF18-250FIM-2K</b>   | 22 – 18 AWG | Red        | 0.133           | 0.90                    | 0.42 | 0.30 | 0.250 x 0.032 | 6.3 x 0.8 | CD9-4B               | CD-800-4                   | 2000            |
| <b>DNF14-250FIM-2K</b>   | 16 – 14 AWG | Blue       | 0.158           | 0.90                    | 0.42 | 0.30 | 0.250 x 0.032 | 6.3 x 0.8 | CD9-5B               | CD-800-5                   | 2000            |
| <b>Oversized Housing</b> |             |            |                 |                         |      |      |               |           |                      |                            |                 |
| <b>DNF18-250FIMB-K*</b>  | 22 – 18 AWG | Red        | 0.135           | 0.91                    | 0.45 | 0.34 | 0.250 x 0.032 | 6.3 x 0.8 | CD9-4B               | CD-800-4                   | 1000            |
| <b>DNF14-250FIMB-K*</b>  | 16 – 14 AWG | Blue       | 0.160           | 0.91                    | 0.46 | 0.34 | 0.250 x 0.032 | 6.3 x 0.8 | CD9-5B               | CD-800-5                   | 1000            |
| <b>DNF10-250FIMB-K</b>   | 12 – 10 AWG | Yellow     | 0.220           | 0.96                    | 0.45 | 0.36 | 0.250 x 0.032 | 6.3 x 0.8 | CD9-18B              | CD-800-18                  | 1000            |

\*To mate with other manufacturers' fully insulated 0.250 x 0.032 female receptacles. For applicator information, see page D1.143.



## Disco™ Male Disconnects, Nylon Fully Insulated – Expanded Wire Entry

### Type DNF-FIMX

- Continuously molded design provides reliable, consistent performance through the applicator for a high quality termination every time
- Expanded wire entry designed to accommodate wire with a larger insulation thickness
- Male tab couples with (all 0.250 x 0.032) female disconnects
- Fully insulated design provides protection from electrical shorts

- Male tab can be inserted and removed from the female disconnect without the use of tools for lower installed cost
- Internal barrel serrations assure good wire contact and maximum tensile strength
- UL Flammability UL 94V-2/HB, maximum insulation temperature 221°F (105°C)
- UL and CSA rated up to 600 V per UL 310

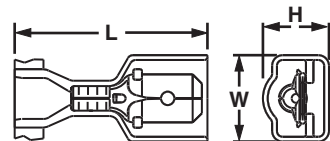

| Part Number              | Wire Range  | Color Code | Max. Ins. (In.) | Figure Dimensions (In.) |      |      | Tab Size      |           | CA9 Series Crimp Die | CA-800/EZ Series Crimp Die | Pieces Per Reel |
|--------------------------|-------------|------------|-----------------|-------------------------|------|------|---------------|-----------|----------------------|----------------------------|-----------------|
|                          |             |            |                 | L                       | W    | H    | In.           | mm        |                      |                            |                 |
| <b>DNF18250FIMX-2K*</b>  | 22 – 18 AWG | Red        | 0.244           | 0.97                    | 0.41 | 0.29 | 0.250 x 0.032 | 6.3 x 0.8 | CD9-8B               | CD-800-8                   | 2000            |
| <b>DNF14250FIMX-2K**</b> | 16 – 14 AWG | Blue       |                 |                         |      |      |               |           |                      |                            | 2000            |

\*CSA Certified for use with (2) #18 AWG, (2) #20 AWG, or (2) #22 AWG wires.

\*\*CSA Certified for use with (2) #16 AWG or (2) #18 AWG wires.

For applicator information, see page D1.143.



## Disco™ Male Disconnects, Nylon Barrel Insulated – Funnel Entry

### Type DNF-M

- Continuously molded design provides reliable, consistent performance through the applicator for a high quality termination every time
- Male tab couples with (all 0.250 x 0.032) female disconnects
- Male tab can be inserted and removed from the female disconnect without the use of tools for lower installed cost
- Metal insulation grip sleeve crimps to wire insulation, providing protection to the crimp joint during high vibration applications
- Internal barrel serrations assure good wire contact and maximum tensile strength
- UL Flammability UL 94V-2/HB, maximum insulation temperature 221 °F (105°C)
- Rated up to 600 V

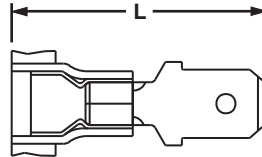

| Part Number   | Wire Range  | Color Code | Max. Ins. (In.) | Figure Dimensions (In.) |               | Tab Size  |        | CA9 Series Crimp Die | CA-800/EZ Series Crimp Die | Pieces Per Reel |
|---------------|-------------|------------|-----------------|-------------------------|---------------|-----------|--------|----------------------|----------------------------|-----------------|
|               |             |            |                 | L                       | In.           | mm        |        |                      |                            |                 |
| DNF18-250M-3K | 22 – 18 AWG | Red        | 0.145           | 0.90                    | 0.250 x 0.032 | 6.3 x 0.8 | CD9-1A | CD-800-1             | 3000                       |                 |
| DNF14-250M-3K | 16 – 14 AWG | Blue       | 0.162           | 0.90                    | 0.250 x 0.032 | 6.3 x 0.8 | CD9-2A | CD-800-2             | 3000                       |                 |
| DNF10-250M-2K | 12 – 10 AWG | Yellow     | 0.225           | 0.95                    | 0.250 x 0.032 | 6.3 x 0.8 | CD9-3B | CD-800-3             | 2000                       |                 |

For applicator information, see page D1.143.



## Disco™ Male Disconnects, Vinyl Barrel Insulated – Funnel Entry

### Type DV-MB

- Continuously molded design provides reliable, consistent performance through the applicator for a high quality termination every time
- Male tab couples with (all 0.250 x 0.032) female disconnects
- Insulation support helps to prevent wire damage in bending applications
- Male tab can be inserted and removed from the female disconnect without the use of tools for lower installed cost
- UL Flammability UL 94V-0, maximum insulation temperature 221°F (105°C)
- UL and CSA rated up to 600 V per UL 310

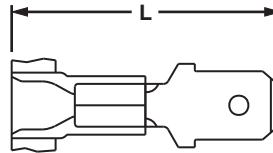

| Part Number   | Wire Range  | Color Code | Max. Ins. (In.) | Figure Dimensions (In.) |               | Tab Size  |        | CA9 Series Crimp Die | CA-800/EZ Series Crimp Die | Pieces Per Reel |
|---------------|-------------|------------|-----------------|-------------------------|---------------|-----------|--------|----------------------|----------------------------|-----------------|
|               |             |            |                 | L                       | In.           | mm        |        |                      |                            |                 |
| DV18-250MB-3K | 22 – 18 AWG | Red        | 0.155           | 0.90                    | 0.250 x 0.032 | 6.3 x 0.8 | CD9-1A | CD800-1              | 3000                       |                 |
| DV14-250MB-3K | 16 – 14 AWG | Blue       | 0.175           |                         |               |           | CD9-2A | CD-800-2             | 3000                       |                 |
| DV10-250M-2K* | 12 – 10 AWG | Yellow     | 0.225           |                         |               |           | CD9-3B | CD-800-3             | 2000                       |                 |

\*Rated up to 300 V.

For applicator information, see page D1.143.

A. System Overview

B1. Cable Ties

B2. Cable Accessories

B3. Stainless Steel Ties

C1. Wiring Duct

C2. Surface Raceway

C3. Abrasion Protection

C4. Cable Management

D1. Terminals

D2. Power Connectors

D3. Grounding Connectors

E1. Labeling Systems

E2. Labels

E3. Pre-Printed & Write-On Markers

E4. Permanent Identification

E5. Lockout/Tagout & Safety Solutions

F. Index

A. System Overview

## Pin Terminals, Vinyl Insulated – Funnel Entry

### Type PV-PB

B1. Cable Ties

- Continuously molded design provides reliable, consistent performance through the applicator for a high quality termination every time

B2. Cable Accessories

- Solid pin designed to prevent damage to the wire from over tightening, resulting in a reliable electrical connection
- For use with pin-type terminal blocks

B3. Stainless Steel Ties



- Insulation support helps to prevent wire damage in bending applications
- UL Flammability UL 94V-0, maximum insulation temperature 221°F (105°C)
- UL rated up to 600 V per UL 486A/B

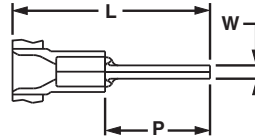

C1. Wiring Duct

| Part Number         | Wire Range  | Color Code | Max. Ins. (In.) | Figure Dimensions (In.) |      |      | CA9 Series Crimp Die | CA-800/EZ Series Crimp Die | Pieces Per Reel |
|---------------------|-------------|------------|-----------------|-------------------------|------|------|----------------------|----------------------------|-----------------|
|                     |             |            |                 | L                       | W    | P    |                      |                            |                 |
| <b>PV18-P47B-3K</b> | 22 – 18 AWG | Red        | 0.150           | 0.90                    | 0.07 | 0.49 | CD9-1A               | CD-800-1                   | 3000            |
| <b>PV14-P47B-3K</b> | 16 – 14 AWG | Blue       | 0.170           | 0.90                    | 0.07 | 0.49 | CD9-2A               | CD-800-2                   | 3000            |

C2. Surface Raceway

For applicator information, see page D1.143.

## Male Blade Adapters, Vinyl Insulated – Funnel Entry

### Type DV-MB

C3. Abrasion Protection

- Continuously molded design provides reliable, consistent performance through the applicator for a high quality termination every time

C4. Cable Management

- Flat blade design to prevent damage to the wire from over tightening, resulting in a reliable electrical connection
- For use with blade-type terminal blocks

- Insulation support helps to prevent wire damage in bending applications
- UL Flammability UL 94V-0, maximum insulation temperature 221°F (105°C)
- Rated up to 600 V

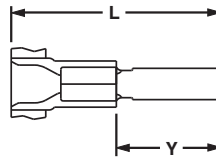

D1. Terminals

| Part Number          | Wire Range  | Color Code | Max. Ins. (In.) | Figure Dimensions (In.) |      | Tab Size (In.) | CA9 Series Crimp Die | CA-800/EZ Series Crimp Die | Pieces Per Reel |
|----------------------|-------------|------------|-----------------|-------------------------|------|----------------|----------------------|----------------------------|-----------------|
|                      |             |            |                 | L                       | Y    |                |                      |                            |                 |
| <b>DV18-145MB-3K</b> | 22 – 18 AWG | Red        | 0.155           | 0.90                    | 0.42 | 0.145 x 0.032  | CD9-1A               | CD-800-1                   | 3000            |
| <b>DV14-145MB-3K</b> | 16 – 14 AWG | Blue       | 0.175           | 0.90                    | 0.42 | 0.145 x 0.032  | CD9-2A               | CD-800-2                   | 3000            |

D2. Power Connectors

For applicator information, see page D1.143.

D3. Grounding Connectors

## Butt Splices Nylon Insulated and Premium Grade Nylon

LISTED CERTIFIED

### Type BSN, BSP

E1. Labeling Systems

- Continuously molded design provides reliable, consistent performance through the applicator for a high quality termination every time

E2. Labels

- Designed to splice two solid or stranded wires together to repair or lengthen wires
- Butted configuration provides low profile for limited space applications

E3. Pre-Printed & Write-On Markers

- Brazed seam protects terminal barrel from splitting during the crimp process

- Internal wire stop assures proper length of insertion into terminal barrel
- Premium grade nylon insulation available for applications requiring a tighter grip around the wire insulation for maximum strain relief
- UL Flammability UL 94V-2/HB, maximum insulation temperature 221°F (105°C)
- UL and CSA rated up to 600 V per UL 486C

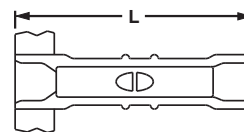

E4. Permanent Identification

| Part Number     | Wire Range  | Color Code | Max. Ins. (In.) | Figure Dimensions (In.) | CA9 Series Crimp Die | CA-800/EZ Series Crimp Die | Pieces Per Reel |
|-----------------|-------------|------------|-----------------|-------------------------|----------------------|----------------------------|-----------------|
|                 |             |            |                 | L                       |                      |                            |                 |
| <b>BSN18-3K</b> | 22 – 16 AWG | Red        | 0.150           | 0.95                    | CD9-1A               | CD-800-1                   | 3000            |
| <b>BSN14-3K</b> | 18 – 14 AWG | Blue       | 0.170           | 0.95                    | CD9-2A               | CD-800-2                   | 3000            |
| <b>BSN10-2K</b> | 12 – 10 AWG | Yellow     | 0.230           | 0.95                    | CD9-17B              | CD-800-17                  | 2000            |
| <b>BSP18-3K</b> | 22 – 16 AWG | Red        | 0.150           | 0.96                    | CD9-1A               | CD-800-1                   | 3000            |
| <b>BSP14-3K</b> | 18 – 14 AWG | Blue       | 0.170           | 0.96                    | CD9-2A               | CD-800-2                   | 3000            |

E5. Lockout/Tagout & Safety Solutions

For applicator information, see page D1.143.

F. Index

## Features and Benefits – Reel Smart™ Metric Disconnects

### Metric Supra-Grip™ Nylon Fully Insulated Female Disconnects Type DMNG-FB

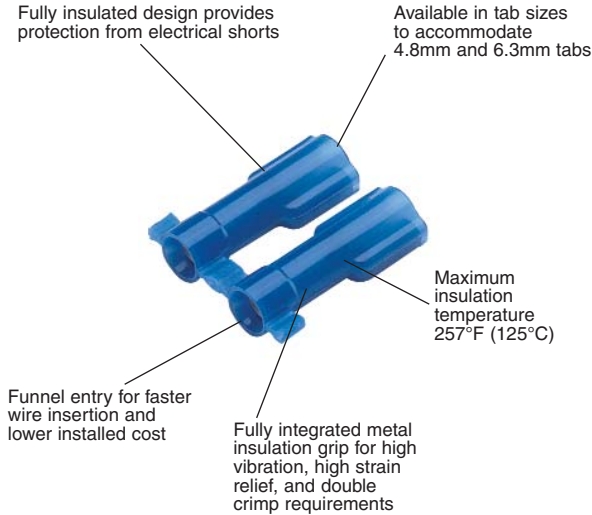

UL and CSA rated up to 600 V per UL 310.  
Flammability – UL 94V-2/HB.

### Metric Disco-Lok™ Nylon Fully Insulated, Funnel Entry, Female Receptacle Type DMNG-FL

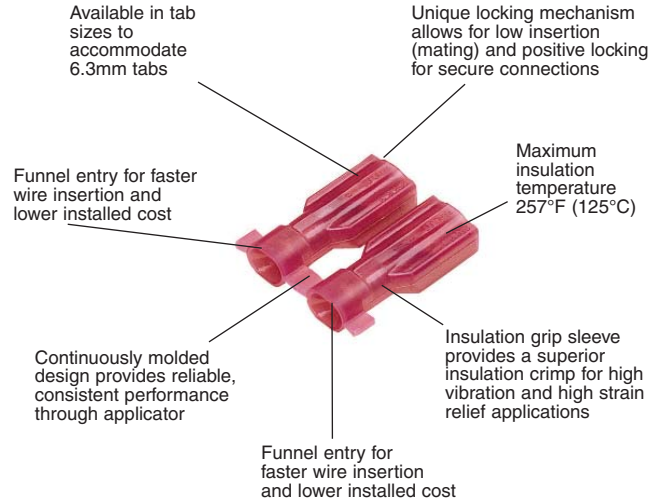

Rated up to 300 V.  
Flammability UL 94V-2/HB.

### Metric Standard and Premium Nylon Fully Insulated, Funnel Entry, Female Receptacles and Male Tabs Type DMNF and DMPF

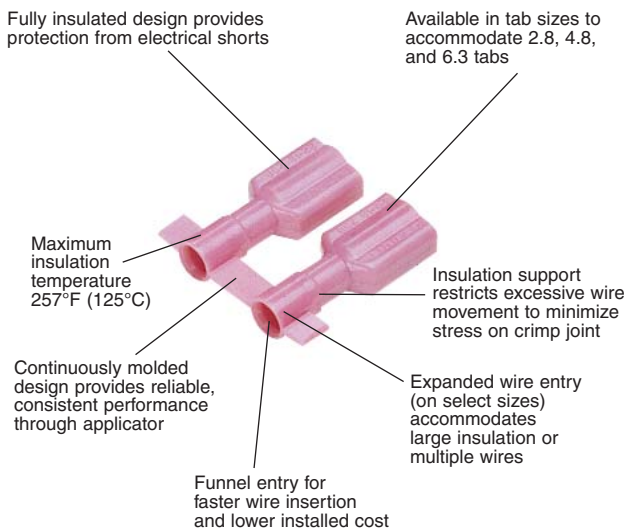

UL and CSA rated up to 600 V per UL 310.  
Flammability – UL 94V-2.

### Metric Vinyl Barrel Insulated Funnel Entry, Female Receptacles and Male Tabs Type DMV

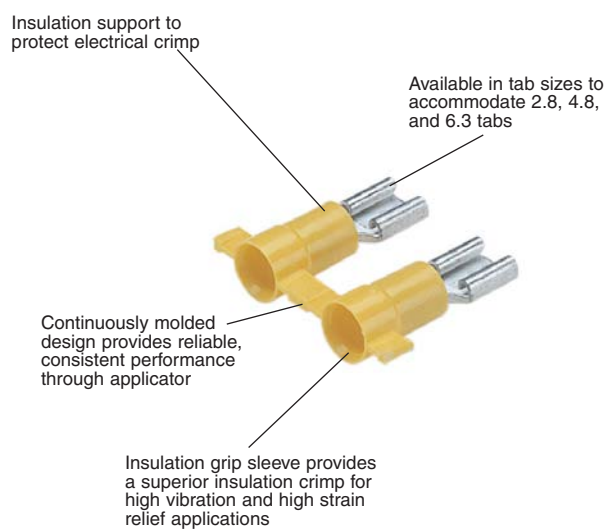

Rated up to 600 V.  
Flammability UL 94V-0.

A. System Overview

B1. Cable Ties

B2. Cable Accessories

B3. Stainless Steel Ties

C1. Wiring Duct

C2. Surface Raceway

C3. Abrasion Protection

C4. Cable Management

D1. Terminals

D2. Power Connectors

D3. Grounding Connectors

E1. Labeling Systems

E2. Labels

E3. Pre-Printed & Write-On Markers

E4. Permanent Identification

E5. Lockout/Tagout & Safety Solutions

F. Index

A. System Overview

## Part Number System for Reel Smart™ Metric Disconnects

B1. Cable Ties

B2. Cable Accessories

B3. Stainless Steel Ties

C1. Wiring Duct

C2. Surface Raceway

C3. Abrasion Protection

C4. Cable Management

D1. Terminals

D2. Power Connectors

D3. Grounding Connectors

E1. Labeling Systems

E2. Labels

E3. Pre-Printed & Write-On Markers

E4. Permanent Identification

E5. Lockout/Tagout & Safety Solutions

F. Index

**DM**

Type

D = Disconnect Metric

**NF**

Insulation

N = Nylon  
NF = Nylon Funnel Entry  
V = Vinyl

**1**

Wire Range

1 = 0.5 – 1.0mm<sup>2</sup>  
2 = 1.5 – 2.5mm<sup>2</sup>  
6 = 4.0 – 6.0mm<sup>2</sup>

—

**285**

Size and Type

283 = 2.8mm x 0.3mm Tab Size  
285 = 2.8mm x 0.5mm Tab Size  
288 = 2.8mm x 0.8mm Tab Size  
485 = 4.8mm x 0.5mm Tab Size  
488 = 4.8mm x 0.8mm Tab Size  
63 = 6.3mm x 0.8mm Tab Size

**FIB**

Special Configuration

B = Butted Seam  
FB = Metal Insulation Grip, Female  
FL = Fully Insulated Positive Locking Female  
FIB = Fully Insulated, Butted Seam, Female  
FIBX = Fully Insulated, Butted Seam, Female, Expanded Wire Entry  
FIM = Fully Insulated Male  
FIMB = Fully Insulated, Male, Oversized Housing  
FIMX = Fully Insulated, Male, Expanded Wire Entry  
M = Male  
MB = Male Butted Seam

**3K**

Std. Pkg. Size

K = 1,000  
KD = 1,500  
2K = 2,000  
3K = 3,000



## Metric Supra-Grip™ Female Disconnects, Nylon Fully Insulated – Funnel Entry

### Type DMNG-FB

- Continuously molded design provides reliable, consistent performance through the applicator for a high quality termination every time
- Disconnect can be inserted and removed from the male tab without the use of tools for lower installed cost
- Flared barrel extension integrated into stamping to provide insulation grip for double crimp requirements

- Internal barrel serrations assure good wire contact and maximum tensile strength
- Internal wire stop assures proper length of insertion into terminal barrel, providing a higher quality connection
- Mates with DNF-FIMB family
- UL Flammability UL 94V-2/HB, maximum insulation temperature 257°F (125°C)
- UL and CSA rated up to 600 V per UL 310

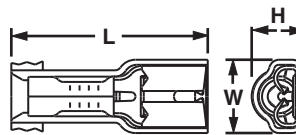

| Part Number     | Wire Range (mm <sup>2</sup> ) | Color Code | Max. Ins. (mm) | Figure Dimensions (mm) |     |     | Tab Size (mm) | CA9 Series Crimp Die | CA-800/EZ Series Crimp Die | Pieces Per Reel |
|-----------------|-------------------------------|------------|----------------|------------------------|-----|-----|---------------|----------------------|----------------------------|-----------------|
|                 |                               |            |                | L                      | W   | H   |               |                      |                            |                 |
| DMNG1-485FB-3K  | 0.5 – 1.0                     | Red        | 3.2            | 22.6                   | 7.4 | 6.1 | 4.8 x 0.5     | CD9-15A              | CD-800-15                  | 3000            |
| DMNG1-488FB-3K  |                               |            | 3.2            | 22.6                   | 7.4 | 6.1 | 4.8 x 0.8     |                      |                            | 3000            |
| DMNG1-63FB-3K   |                               |            | 3.2            | 23.6                   | 8.9 | 6.1 | 6.3 x 0.8     |                      |                            | 3000            |
| DMNG2-485FB-3K* | 1.5 – 2.5                     | Blue       | 3.9            | 22.6                   | 7.4 | 6.1 | 4.8 x 0.5     | CD9-16A              | CD-800-16                  | 3000            |
| DMNG2-488FB-3K  |                               |            | 3.9            | 22.6                   | 7.4 | 6.1 | 4.8 x 0.8     |                      |                            | 3000            |
| DMNG2-63FB-3K   |                               |            | 3.9            | 23.6                   | 8.9 | 6.1 | 6.3 x 0.8     |                      |                            | 3000            |

\*For #14 AWG wire applications, part to be used with copper alloy tabs only and is UL Recognized. For applicator information, see page D1.143.



## Metric Disco-Lok™ Female Disconnects, Nylon Fully Insulated – Funnel Entry

### Type DMNG-FL

- Continuously molded design provides reliable, consistent performance through the applicator for a high quality termination every time
- Disconnect can be inserted and removed from the male tab without the use of tools for lower installed cost
- Unique locking mechanism design allows for low insertion forces (mating) and positive lock for high vibration applications where a secure connection is mandatory
- Fully insulated design provides protection from electrical shorts
- Flared barrel extension integrated into stamping to provide insulation grip for double crimp requirements
- Insulation housing moves back and forth to engage and disengage locking mechanism for repeated use
- Specialty tool required to install this disconnect (CT-1014)
- Mates with DNF-FIMB family
- UL Flammability UL 94V-2/HB, maximum insulation temperature 257°F (125°C)
- Rated up to 300 V

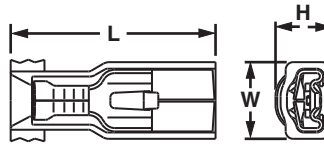

| Part Number   | Wire Range (mm²) | Color Code | Max. Ins. (mm) | Figure Dimensions (mm) |     |     | Tab Size (mm) | CA9 Series Crimp Die | CA-800/EZ Series Crimp Die | Pieces Per Reel |
|---------------|------------------|------------|----------------|------------------------|-----|-----|---------------|----------------------|----------------------------|-----------------|
|               |                  |            |                | L                      | W   | H   |               |                      |                            |                 |
| DMNG1-63FL-3K | 0.5 – 1.0        | Red        | 3.2            | 24.6                   | 9.1 | 6.1 | 6.3 x 0.8     | CD9-14A              | CD-800-14                  | 3000            |
| DMNG2-63FL-3K | 1.5 – 2.5        | Blue       | 3.8            | 24.6                   | 9.1 | 6.4 | 6.3 x 0.8     | CD9-14A              | CD-800-14                  | 3000            |

For applicator information, see page D1.143.

## Metric Female Disconnects, Nylon Fully Insulated – Funnel Entry

### Type DMNF-FIB

- Continuously molded design provides reliable, consistent performance through the applicator for a high quality termination every time
- Disconnect can be inserted and removed from the male tab without the use of tools for lower installed cost
- Fully insulated design provides protection from electrical shorts
- Internal wire stop assures proper length of insertion into terminal barrel, providing a higher quality connection
- UL Flammability UL 94V-2/HB, maximum insulation temperature 221°F (105°C)
- UL and CSA rated up to 600 V per UL 310

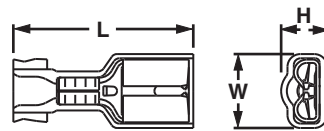

| Part Number      | Wire Range (mm²) | Color Code | Max. Ins. (mm) | Figure Dimensions (mm) |      |      | Tab Size (mm) | CA9 Series Crimp Die | CA-800/EZ Series Crimp Die | Pieces Per Reel |           |
|------------------|------------------|------------|----------------|------------------------|------|------|---------------|----------------------|----------------------------|-----------------|-----------|
|                  |                  |            |                | L                      | W    | H    |               |                      |                            |                 |           |
| DMNF1-283FIB-3K* | 0.5 – 1.0        | Natural    | 3.0            | 18.0                   | 4.8  | 3.8  | 2.8 x 0.3     | CD9-7A               | CD-800-7                   | 3000            |           |
| DMNF1-285FIB-3K  |                  |            | 3.0            | 18.0                   | 4.8  | 3.8  | 2.8 x 0.5     |                      |                            | 3000            |           |
| DMNF1-288FIB-3K  |                  |            | 3.0            | 18.0                   | 4.8  | 3.8  | 2.8 x 0.8     |                      |                            | 3000            |           |
| DMNF1-485FIB-3K  |                  |            | Red            | 3.4                    | 19.8 | 7.4  | 4.1           | 4.8 x 0.5            | CD9-4A                     | CD-800-4        | 3000      |
| DMNF1-488FIB-3K  |                  |            |                | 3.4                    | 19.8 | 7.4  | 4.1           | 4.8 x 0.8            |                            |                 | 3000      |
| DMNF1-63FIB-3K   |                  |            |                | 3.4                    | 21.3 | 8.9  | 5.6           | 6.3 x 0.8            |                            |                 | 3000      |
| DMNF2-485FIB-3K  | 1.5 – 2.5        | Blue       | 4.0            | 19.8                   | 7.4  | 4.6  | 4.8 x 0.5     | CD9-5A               | CD-800-5                   | 3000            |           |
| DMNF2-488FIB-3K  |                  |            | 4.0            | 19.8                   | 7.4  | 4.6  | 4.8 x 0.8     |                      |                            | 3000            |           |
| DMNF2-63FIB-3K   |                  |            | 4.1            | 21.3                   | 8.9  | 5.6  | 6.3 x 0.8     |                      |                            | 3000            |           |
| DMNF6-63FIB-2K   |                  |            | 4.0 – 6.0      | Yellow                 | 5.6  | 24.4 | 8.9           |                      |                            | 5.8             | 6.3 x 0.8 |

\*UL/CSA standards do not exist for 2.8mm x 0.3mm (0.110" x 0.010") receptacles. For applicator information, see page D1.143.

A. System Overview



## Metric Disco™ Female Disconnect, Nylon Fully Insulated – Expanded Wire Entry

B1. Cable Ties

### Type DMNF-FIBX

- Continuously molded design provides reliable, consistent performance through the applicator for a high quality termination every time
- Expanded wire entry designed to accommodate wire with a larger insulation thickness
- Disconnect can be inserted and removed from the male tab without the use of tools for lower installed cost
- Fully insulated design provides protection from electrical shorts
- Internal wire stop assures proper length of insertion into terminal barrel, providing a higher quality connection
- UL Flammability UL 94V-2/HB, maximum insulation temperature 221°F (105°C)
- UL and CSA rated up to 600 V per UL 310

B2. Cable Accessories

B3. Stainless Steel Ties

C1. Wiring Duct

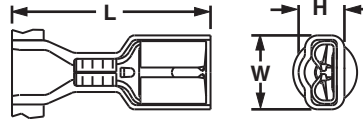

C2. Surface Raceway

C3. Abrasion Protection

C4. Cable Management

| Part Number     | Wire Range (mm <sup>2</sup> ) | Color Code | Max. Ins. (mm) | Figure Dimensions (mm) |     |     | Tab Size (mm) | CA9 Series Crimp Die | CA-800/EZ Series Crimp Die | Pieces Per Reel |
|-----------------|-------------------------------|------------|----------------|------------------------|-----|-----|---------------|----------------------|----------------------------|-----------------|
|                 |                               |            |                | L                      | W   | H   |               |                      |                            |                 |
| DMNF1485FIBX-2K | 0.5 – 1.0                     | Red        | 5.3            | 22.1                   | 7.9 | 5.5 | 5.2/4.8 x 0.5 | CD9-6B               | CD-800-6                   | 2000            |
| DMNF1488FIBX-2K |                               |            | 5.3            | 22.1                   | 7.9 | 5.5 | 5.2/4.8 x 0.8 |                      |                            | 2000            |
| DMNF1-63FIBX-2K |                               |            | 5.3            | 23.6                   | 8.9 | 5.5 | 6.3 x 0.8     |                      |                            | 2000            |
| DMNF2485FIBX-2K | 1.5 – 2.5                     | Blue       | 6.1            | 22.1                   | 7.9 | 5.5 | 5.2/4.8 x 0.5 | CD9-8B               | CD-800-8                   | 2000            |
| DMNF2488FIBX-2K |                               |            | 6.1            | 22.1                   | 7.9 | 5.5 | 5.2/4.8 x 0.8 |                      |                            | 2000            |
| DMNF2-63FIBX-2K |                               |            | 6.1            | 23.6                   | 8.9 | 5.5 | 6.3 x 0.8     |                      |                            | 2000            |

For applicator information, see page D1.143.

D1. Terminals



## Metric Disco™ Female Disconnects, Nylon Fully Insulated – Right Angle

D2. Power Connectors

### Type DMNFR-FIB

D3. Grounding Connectors

- Continuously molded design provides reliable, consistent performance through the applicator for a high quality termination every time
- Right angle design for use in limited space applications
- Fully insulated design provides protection from electrical shorts
- Internal wire stop assures proper length of insertion into terminal barrel, providing a higher quality connection
- Disconnect can be inserted and removed from the male tab without the use of tools for lower installed cost
- UL Flammability UL 94V-2/HB, maximum insulation temperature 221°F (105°C)
- UL and CSA rated up to 600 V per UL 310

E1. Labeling Systems

E2. Labels

E3. Pre-Printed & Write-On Markers

E4. Permanent Identification

E5. Lockout/Tagout & Safety Solutions

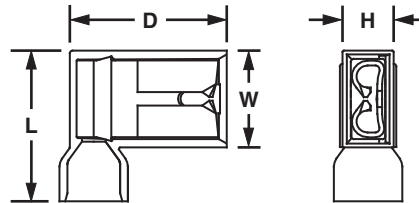

| Part Number     | Wire Range (mm <sup>2</sup> ) | Color Code | Max. Ins. (mm) | Figure Dimension (mm) |      |     |     | Tab Size (mm) | CA9 Series Crimp Die | CA-800/EZ Series Crimp Die | Pieces Per Reel |
|-----------------|-------------------------------|------------|----------------|-----------------------|------|-----|-----|---------------|----------------------|----------------------------|-----------------|
|                 |                               |            |                | D                     | L    | W   | H   |               |                      |                            |                 |
| DMNFR1485FIB-KD | 0.5 – 1.0                     | Red        | 4.5            | 15.2                  | 14.5 | 9.4 | 2.8 | 5.2/4.8 x 0.5 | CD9-9C               | CD-800-9                   | 1500            |
| DMNFR1488FIB-KD |                               |            | 4.5            | 15.2                  | 14.5 | 9.4 | 3.1 | 5.2/4.8 x 0.8 |                      |                            | 1500            |
| DMNFR163FIB-KD  |                               |            | 4.5            | 15.2                  | 14.5 | 9.4 | 3.1 | 6.3 x 0.8     |                      |                            | 1500            |
| DMNFR2485FIB-KD | 1.5 – 2.5                     | Blue       | 4.5            | 15.2                  | 14.5 | 9.4 | 2.8 | 5.2/4.8 x 0.5 | CD9-9C               | CD-800-9                   | 1500            |
| DMNFR2488FIB-KD |                               |            | 4.5            | 15.2                  | 14.5 | 9.4 | 3.1 | 5.2/4.8 x 0.8 |                      |                            | 1500            |
| DMNFR263FIB-KD  |                               |            | 4.5            | 15.2                  | 14.5 | 9.4 | 3.1 | 6.3 x 0.8     |                      |                            | 1500            |

For applicator information, see page D1.143.

F. Index



## Metric Disco™ Female Disconnects, Vinyl Barrel Insulated – Funnel Entry

### Type DMV-B

- Continuously molded design provides reliable, consistent performance through the applicator for a high quality termination every time
- Disconnect can be inserted and removed from the male tab without the use of tools for lower installed cost

- Internal barrel serrations assure good wire contact and maximum tensile strength
- Internal wire stop assures proper length of insertion into terminal barrel, providing a higher quality connection
- UL Flammability UL 94V-0, maximum insulation temperature 221°F (105°C)
- UL and CSA rated up to 600 V per UL 310

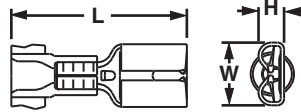

| Part Number  | Wire Range (mm <sup>2</sup> ) | Color Code | Max. Ins. (mm) | Figure Dimension (mm) |     |     | Tab Size (mm) | CA9 Series Crimp Die | CA-800/EZ Series Crimp Die | Pieces Per Reel |
|--------------|-------------------------------|------------|----------------|-----------------------|-----|-----|---------------|----------------------|----------------------------|-----------------|
|              |                               |            |                | L                     | W   | H   |               |                      |                            |                 |
| DMV1-485B-3K | 0.5 – 1.0                     | Red        | 4.06           | 19.3                  | 5.8 | 2.5 | 4.8 x 0.5     | CD9-1A               | CD-800-1                   | 3000            |
| DMV1-488B-3K |                               |            | 4.06           | 18.8                  | 5.8 | 2.5 | 4.8 x 0.8     | CD9-2A               | CD-800-2                   | 3000            |
| DMV1-63B-3K  |                               |            | 4.06           | 21.1                  | 7.4 | 3.0 | 6.3 x 0.8     | CD9-2A               | CD-800-2                   | 3000            |
| DMV2-485B-3K | 1.5 – 2.5                     | Blue       | 4.52           | 19.6                  | 5.3 | 2.5 | 4.8 x 0.5     | CD9-2A               | CD-800-2                   | 3000            |
| DMV2-488B-3K |                               |            | 4.52           | 19.6                  | 5.3 | 2.5 | 4.8 x 0.8     | CD9-1A               | CD-800-1                   | 3000            |
| DMV2-63B-3K  |                               |            | 4.52           | 21.1                  | 7.4 | 3.0 | 6.3 x 0.8     | CD9-2A               | CD-800-2                   | 3000            |
| DMV6-63-2K*  | 4.0 – 6.0                     | Yellow     | 5.84           | 24.1                  | 7.4 | 3.0 | 6.3 x 0.8     | CD9-3B               | CD-800-8                   | 2000            |

\*Not UL Listed or CSA Certified.  
For applicator information, see page D1.143.



## Metric DiscoGrip™ Female Disconnects, Fully Insulated – Funnel Entry

### Type DMPF-FIB

- Continuously molded design provides reliable, consistent performance through the applicator for a high quality termination every time
- Disconnect can be inserted and removed from the male tab without the use of tools for lower installed cost
- Premium nylon insulation retains its shape when crimped and provides a tight grip around the wire insulation for maximum strain relief

- Fully insulated design provides protection from electrical shorts
- Internal wire stop assures proper length of insertion into terminal barrel, providing a higher quality connection
- Male tab couples with (all 6.3mm x 0.8mm) female disconnects
- UL Flammability UL 94V-2, maximum insulation temperature 221°F (105°C)
- UL and CSA rated up to 600 V per UL 310

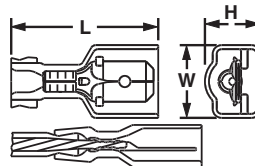

Cross section of DiscoGrip™ Crimp showing insulation crimp of the wire insulation.

| Part Number     | Wire Range (mm <sup>2</sup> ) | Color Code | Max. Ins. (mm) | Figure Dimensions (mm) |     |     | Tab Size (mm) | CA9 Series Crimp Die | CA-800/EZ Series Crimp Die | Pieces Per Reel |
|-----------------|-------------------------------|------------|----------------|------------------------|-----|-----|---------------|----------------------|----------------------------|-----------------|
|                 |                               |            |                | L                      | W   | H   |               |                      |                            |                 |
| DMPF1-285FIB-3K | 0.5 – 1.0                     | Red        | 3.4            | 18.0                   | 4.8 | 4.3 | 2.8 x 0.5     | CD9-12A              | CD-800-12                  | 3000            |
| DMPF1-288FIB-3K |                               |            | 3.4            | 18.0                   | 4.8 | 4.3 | 2.8 x 0.8     | CD9-12A              | CD-800-12                  | 3000            |
| DMPF1-485FIB-3K |                               |            | 3.4            | 19.8                   | 7.9 | 4.3 | 4.8 x 0.5     | CD9-10A              | CD-800-10                  | 3000            |
| DMPF1-488FIB-3K |                               |            | 3.4            | 19.8                   | 7.9 | 4.3 | 4.8 x 0.8     | CD9-10A              | CD-800-10                  | 3000            |
| DMPF1-63FIB-3K  |                               |            | 3.4            | 21.3                   | 8.9 | 5.6 | 6.3 x 0.8     | CD9-13A              | CD-800-13                  | 3000            |
| DMPF2-485FIB-3K | 1.5 – 2.5                     | Blue       | 4.0            | 19.8                   | 7.9 | 4.8 | 4.8 x 0.5     | CD9-11A              | CD-800-11                  | 3000            |
| DMPF2-488FIB-3K |                               |            | 4.0            | 19.8                   | 7.9 | 4.8 | 4.8 x 0.8     | CD9-11A              | CD-800-11                  | 3000            |
| DMPF2-63FIB-3K  |                               |            | 4.0            | 21.3                   | 8.9 | 5.6 | 6.3 x 0.8     | CD9-11A              | CD-800-11                  | 3000            |
| DMPF6-63FIB-2K* | 4.0 – 6.0                     | Yellow     | 5.5            | 24.4                   | 8.9 | 5.8 | 6.3 x 0.8     | CD9-13A              | CD-800-13                  | 2000            |

\*Also approved for use with (2) 1.5 (#16) wires.  
For applicator information, see page D1.143.

A. System Overview

B1. Cable Ties

B2. Cable Accessories

B3. Stainless Steel Ties

C1. Wiring Duct

C2. Surface Raceway

C3. Abrasion Protection

C4. Cable Management

D1. Terminals

D2. Power Connectors

D3. Grounding Connectors

E1. Labeling Systems

E2. Labels

E3. Pre-Printed & Write-On Markers

E4. Permanent Identification

E5. Lockout/Tagout & Safety Solutions

F. Index

A. System Overview



## Metric DiscoGrip™ Male Disconnects, Fully Insulated – Funnel Entry

B1. Cable Ties

### Type DMPF-FIM

- Continuously molded design provides reliable, consistent performance through the applicator for a high quality termination every time
- Male tab can be inserted and removed from the female disconnect without the use of tools for lower installed cost
- Fully insulated design provides protection from electrical shorts
- Premium nylon insulation retains its shape when crimped and provides a tight grip around the wire insulation for maximum strain relief
- Oversized housing designed for maximum versatility to mate with most commercially available fully insulated female disconnects
- Internal wire stop assures proper length of insertion into terminal barrel, providing a higher quality connection
- Male tab couples with (all 6.3mm x 0.8mm) female disconnects
- UL Flammability UL 94V-2, maximum insulation temperature 221°F (105°C)
- UL and CSA rated up to 600 V per UL 310

B2. Cable Accessories

B3. Stainless Steel Ties

C1. Wiring Duct

C2. Surface Raceway

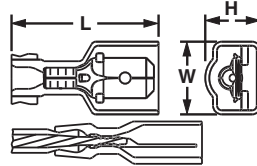

Cross section of DiscoGrip™ Crimp showing insulation crimp of the wire insulation.

C3. Abrasion Protection

C4. Cable Management

| Part Number              | Wire Range (mm <sup>2</sup> ) | Color Code | Max. Ins. (mm) | Figure Dimensions (mm) |      |     | Tab Size (mm) | CA9 Series Crimp Die | CA-800/EZ Series Crimp Die | Pieces Per Reel |
|--------------------------|-------------------------------|------------|----------------|------------------------|------|-----|---------------|----------------------|----------------------------|-----------------|
|                          |                               |            |                | L                      | W    | H   |               |                      |                            |                 |
| <b>Standard Housing</b>  |                               |            |                |                        |      |     |               |                      |                            |                 |
| DMPF1-63FIM-2K           | 0.5 – 1.0                     | Red        | 3.4            | 22.9                   | 10.4 | 7.4 | 6.3 x 0.8     | CD9-10B              | CD-800-10                  | 2000            |
| DMPF2-63FIM-2K           | 1.5 – 2.5                     | Blue       | 4.0            | 22.9                   | 10.4 | 7.4 | 6.3 x 0.8     | CD9-11B              | CD-800-11                  | 2000            |
| <b>Oversized Housing</b> |                               |            |                |                        |      |     |               |                      |                            |                 |
| DMPF1-63FIMB-K*          | 0.5 – 1.0                     | Red        | 3.4            | 23.4                   | 11.7 | 8.6 | 6.3 x 0.8     | CD9-10B              | CD-800-10                  | 1000            |
| DMPF2-63FIMB-K*          | 1.5 – 2.5                     | Blue       | 4.1            | 23.4                   | 11.7 | 8.6 | 6.3 x 0.8     | CD9-11B              | CD-800-11                  | 1000            |

\*To mate with other manufacturers' fully insulated 6.3mm x 0.8mm female receptacles. For applicator information, see page D1.143.

D1. Terminals

D2. Power Connectors



## Metric Disco™ Male Disconnects, Nylon Fully Insulated – Funnel Entry

D3. Grounding Connectors

### Type DMNF-FIM

- Continuously molded design provides reliable, consistent performance through the applicator for a high quality termination every time
- Male tab can be inserted and removed from the female disconnect without the use of tools for lower installed cost
- Internal barrel serrations assure good wire contact and maximum tensile strength
- UL Flammability UL 94V-2/HB, maximum insulation temperature 221°F (105°C)
- UL and CSA rated up to 600 V per UL 310
- Male tab couples with (all 6.3mm x 0.8mm) female disconnects
- Fully insulated design provides protection from electrical shorts

E1. Labeling Systems

E2. Labels

E3. Pre-Printed & Write-On Markers

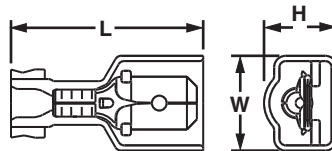

E4. Permanent Identification

E5. Lockout/Tagout & Safety Solutions

| Part Number              | Wire Range (mm <sup>2</sup> ) | Color Code | Max. Ins. (mm) | Figure Dimensions (mm) |      |     | Tab Size (mm) | CA9 Series Crimp Die | CA-800/EZ Series Crimp Die | Pieces Per Reel |
|--------------------------|-------------------------------|------------|----------------|------------------------|------|-----|---------------|----------------------|----------------------------|-----------------|
|                          |                               |            |                | L                      | W    | H   |               |                      |                            |                 |
| <b>Standard Housing</b>  |                               |            |                |                        |      |     |               |                      |                            |                 |
| DMNF1-63FIM-2K           | 0.5 – 1.0                     | Red        | 3.4            | 22.9                   | 10.7 | 7.5 | 6.3 x 0.8     | CD9-4B               | CD-800-4                   | 2000            |
| DMNF2-63FIM-2K           | 1.5 – 2.5                     | Blue       | 4.0            | 22.9                   | 10.7 | 7.5 | 6.3 x 0.8     | CD9-5B               | CD-800-5                   | 2000            |
| <b>Oversized Housing</b> |                               |            |                |                        |      |     |               |                      |                            |                 |
| DMNF1-63FIMB-K*          | 0.5 – 1.0                     | Red        | 3.4            | 23.1                   | 11.4 | 8.6 | 6.3 x 0.8     | CD9-4B               | CD-800-4                   | 1000            |
| DMNF2-63FIMB-K*          | 1.5 – 2.5                     | Blue       | 4.1            | 23.1                   | 11.7 | 8.4 | 6.3 x 0.8     | CD9-5B               | CD-800-5                   | 1000            |

\*To mate with other manufacturers' fully insulated 6.3mm x 0.8mm female receptacles. For applicator information, see page D1.143.

F. Index



## Metric Disco™ Male Disconnects, Nylon Fully Insulated – Expanded Wire Entry

### Type DMNF-FIMX

- Continuously molded design provides reliable, consistent performance through the applicator for a high quality termination every time
- Expanded wire entry designed to accommodate wire with a larger insulation thickness
- Male tab couples with (all 6.3mm x 0.8mm) female disconnects
- Fully insulated design provides protection from electrical shorts

- Male tab can be inserted and removed from the female disconnect without the use of tools for lower installed cost
- Internal barrel serrations assure good wire contact and maximum tensile strength
- UL Flammability UL 94V-2/HB, maximum insulation temperature 221°F (105°C)
- UL and CSA rated up to 600 V per UL 310

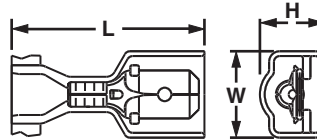

| Part Number       | Wire Range (mm <sup>2</sup> ) | Color Code | Max. Ins. (mm) | Figure Dimensions (mm) |      |     | Tab Size (mm) | CA9 Series Crimp Die | CA-800/EZ Series Crimp Die | Pieces Per Reel |
|-------------------|-------------------------------|------------|----------------|------------------------|------|-----|---------------|----------------------|----------------------------|-----------------|
|                   |                               |            |                | L                      | W    | H   |               |                      |                            |                 |
| DMNF1-63FIMX-2K*  | 0.5 – 1.0                     | Red        | 6.2            | 24.6                   | 10.4 | 7.4 | 6.3 x 0.8     | CD9-8B               | CD-800-8                   | 2000            |
| DMNF2-63FIMX-2K** | 1.5 – 2.5                     | Blue       | 6.2            | 24.6                   | 10.4 | 7.4 | 6.3 x 0.8     | CD9-8B               | CD-800-8                   | 2000            |

\*CSA Certified for use with (2) #16 AWG or (2) #18 AWG wires.

\*\*CSA Certified for use with (2) #18 AWG, (2) #20 AWG, or (2) #22 AWG wires.

For applicator information, see page D1.143.



## Metric Disco™ Male Disconnects, Nylon Barrel Insulated – Funnel Entry

### Type DMNF-M

- Continuously molded design provides reliable, consistent performance through the applicator for a high quality termination every time
- Male tab couples with (all 6.3mm x 0.8mm) female disconnects
- Male tab can be inserted and removed from the female disconnect without the use of tools for lower installed cost

- Metal insulation grip sleeve crimps to wire insulation, providing protection to the crimp joint during high vibration applications
- Internal barrel serrations assure good wire contact and maximum tensile strength
- UL Flammability UL 94V-2/HB, maximum insulation temperature 221°F (105°C)
- Rated up to 600 V

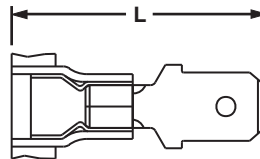

| Part Number   | Wire Range (mm <sup>2</sup> ) | Color Code | Max. Ins. (mm) | Figure Dimensions (mm) | Tab Size (mm) | CA9 Series Crimp Die | CA-800/EZ Series Crimp Die | Pieces Per Reel |
|---------------|-------------------------------|------------|----------------|------------------------|---------------|----------------------|----------------------------|-----------------|
|               |                               |            |                | L                      |               |                      |                            |                 |
| DMNF1-63M-3K  | 0.5 – 1.0                     | Red        | 3.7            | 22.9                   | 6.3 x 0.8     | CD9-1A               | CD-800-1                   | 3000            |
| DMNF2-63M-3K  | 1.5 – 2.5                     | Blue       | 4.1            | 22.9                   | 6.3 x 0.8     | CD9-2A               | CD-800-2                   | 3000            |
| DMNF6-63M-2K* | 4.0 – 6.0                     | Yellow     | 5.7            | 24.1                   | 6.3 x 0.8     | CD9-3B               | CD-800-3                   | 2000            |

\*Not CSA Certified.

For applicator information, see page D1.143.

A. System Overview

B1. Cable Ties

B2. Cable Accessories

B3. Stainless Steel Ties

C1. Wiring Duct

C2. Surface Raceway

C3. Abrasion Protection

C4. Cable Management

D1. Terminals

D2. Power Connectors

D3. Grounding Connectors

E1. Labeling Systems

E2. Labels

E3. Pre-Printed & Write-On Markers

E4. Permanent Identification

E5. Lockout/Tagout & Safety Solutions

F. Index



A. System Overview



## Metric Disco™ Male Disconnects, Vinyl Barrel Insulated – Funnel Entry

B1. Cable Ties

### Type DMV-MB

B2. Cable Accessories

B3. Stainless Steel Ties

C1. Wiring Duct

- Continuously molded design provides reliable, consistent performance through the applicator for a high quality termination every time
- Male tab couples with (all 6.3mm x 0.8mm) female disconnects
- Insulation support helps to prevent wire damage in bending applications

- Male tab can be inserted and removed from the female disconnect without the use of tools for lower installed cost
- UL Flammability UL 94V-0, maximum insulation temperature 194°F (90°C)
- Rated up to 600 V

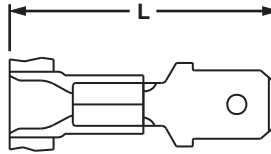

C2. Surface Raceway

C3. Abrasion Protection

C4. Cable Management

| Part Number         | Wire Range (mm <sup>2</sup> ) | Color Code | Max. Ins. (mm) | Figure Dimension (mm) |               |  | CA9 Series Crimp Die | CA-800/EZ Series Crimp Die | Pieces Per Reel |
|---------------------|-------------------------------|------------|----------------|-----------------------|---------------|--|----------------------|----------------------------|-----------------|
|                     |                               |            |                | L                     | Tab Size (mm) |  |                      |                            |                 |
| <b>DMV1-63MB-3K</b> | 0.5 – 1.0                     | Red        | 3.9            | 22.9                  | 6.3 x 0.8     |  | CD9-1A               | CD-800-1                   | 3000            |
| <b>DMV2-63MB-3K</b> | 1.5 – 2.5                     | Blue       | 4.5            | 22.9                  | 6.3 x 0.8     |  | CD9-2A               | CD-800-2                   | 3000            |
| <b>DMV6-63M-2K*</b> | 4.0 – 6.0                     | Yellow     | 6.1            | 24.4                  | 6.3 x 0.8     |  | CD9-3B               | CD-800-3                   | 2000            |

\*DMV6-63M-2K is not CSA Certified.  
For applicator information, see page D1.143.

D1. Terminals

## Metric Pin Terminals, Vinyl Insulated – Funnel Entry

D2. Power Connectors

D3. Grounding Connectors

### Type PMV-P

- Continuously molded design provides reliable, consistent performance through the applicator for a high quality termination every time
- Solid pin designed to prevent damage to the wire from over tightening, resulting in a reliable electrical connection

- Insulation support helps to prevent wire damage in bending applications
- For use with pin-type terminal blocks
- UL Flammability UL 94V-0, maximum insulation temperature 221°F (105°C)
- Rated up to 600 V

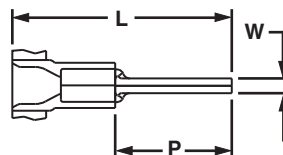

E1. Labeling Systems

E2. Labels

E3. Pre-Printed & Write-On Markers

E4. Permanent Identification

E5. Lockout/Tagout & Safety Solutions

F. Index

| Part Number         | Wire Range (mm <sup>2</sup> ) | Color Code | Max. Ins. (mm) | Figure Dimensions (mm) |     |      | CA9 Series Crimp Die | CA-800/EZ Series Crimp Die | Pieces Per Reel |
|---------------------|-------------------------------|------------|----------------|------------------------|-----|------|----------------------|----------------------------|-----------------|
|                     |                               |            |                | L                      | W   | P    |                      |                            |                 |
| <b>PMV1-P12B-3K</b> | 0.5 – 1.0                     | Red        | 3.8            | 22.6                   | 2.0 | 10.0 | CD9-1A               | CD-800-1                   | 3000            |
| <b>PMV2-P12B-3K</b> | 1.5 – 2.5                     | Blue       | 4.3            | 22.6                   | 2.0 | 10.0 | CD9-2A               | CD-800-2                   | 3000            |

For applicator information, see page D1.143.



## Metric Male Blade Adapters, Vinyl Insulated – Funnel Entry

### Type DMV-MB

- Continuously molded design provides reliable, consistent performance through the applicator for a high quality termination every time
- Flat blade design to prevent damage to the wire from over tightening, resulting in a reliable electrical connection
- For use with blade-type terminal blocks
- Insulation support helps to prevent wire damage in bending applications
- UL Flammability UL 94V-0, maximum insulation temperature 194°F (90°C)
- Rated up to 600 V

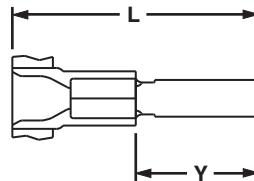

| Part Number  | Wire Range (mm <sup>2</sup> ) | Color Code | Max. Ins. (mm) | Figure Dimensions (mm) |      | Tab Size (mm) | CA9 Series Crimp Die | CA-800/EZ Series Crimp Die | Pieces Per Reel |
|--------------|-------------------------------|------------|----------------|------------------------|------|---------------|----------------------|----------------------------|-----------------|
|              |                               |            |                | L                      | Y    |               |                      |                            |                 |
| DMV1-37MB-3K | 0.5 – 1.0                     | Red        | 3.9            | 22.9                   | 10.5 | 3.7 x 0.8     | CD9-1A               | CD-800-1                   | 3000            |
| DMV2-37MB-3K | 1.5 – 2.5                     | Blue       | 4.5            | 22.9                   | 10.5 | 3.7 x 0.8     | CD9-2A               | CD-800-2                   | 3000            |

For applicator information, see page D1.143.

## UL LISTED Metric Butt Splices, Nylon Insulated

### Type BSMN, BSMP

- One-side machine applied termination replaces manual crimping
- Funnel entry on machine termination side to increase productivity
- Also hand crimped with Panduit CT-100A, CT-1550, or CT-1551 crimping tools
- Barrel locating ribs provide for accurate hand tool placement
- Available with insulation crimp premium grade nylon
- Brazed seam with center wire stop for increased performance and productivity
- UL Flammability UL 94V-2/HB, maximum insulation temperature 221°F (105°C)
- UL and CSA rated up to 600 V per UL 486C

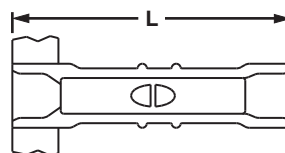

| Part Number | Wire Range (mm <sup>2</sup> ) | Color Code | Max. Ins. (mm) | Figure Dimension (mm) | CA9 Series Crimp Die | CA-800/EZ Series Crimp Die | Pieces Per Reel |
|-------------|-------------------------------|------------|----------------|-----------------------|----------------------|----------------------------|-----------------|
|             |                               |            |                | L                     |                      |                            |                 |
| BSMN1-3K    | 0.5 – 1.5                     | Red        | 3.8            | 24.1                  | CD9-1A               | CD-800-1                   | 3000            |
| BSMN2-3K    | 1.5 – 2.5                     | Blue       | 4.3            | 24.1                  | CD9-2A               | CD-800-2                   | 3000            |
| BSMN6-2K    | 4.0 – 6.0                     | Yellow     | 5.8            | 24.1                  | CD9-3B               | CD-800-3                   | 2000            |
| BSMP1-3K    | 0.5 – 1.5                     | Red        | 3.8            | 24.1                  | CD9-1A               | CD-800-1                   | 3000            |
| BSMP2-3K    | 1.5 – 2.5                     | Blue       | 4.3            | 24.1                  | CD9-2A               | CD-800-2                   | 3000            |

For applicator information, see page D1.143.

A. System Overview

## Features and Benefits – Reel Smart™ Ferrules

B1. Cable Ties

Panduit ferrules are available in strips and reels for wiring applications from #20 – 14 AWG. Offerings include insulated ferrules in single wire configurations. These insulated ferrules are color-coded to DIN standards.

B2. Cable Accessories

B3. Stainless Steel Ties

C1. Wiring Duct

C2. Surface Raceway

C3. Abrasion Protection

C4. Cable Management

### Insulated Ferrules – Single Wire Type FS and FSD

Seamless tubular barrel provides consistent quality crimps

Maximum insulation temperature 192°F (89°C)



Color-coded polypropylene identifies wire size

D1. Terminals

### Part Number System for Reel Smart® Ferrules

|             |            |  |                              |   |            |                                      |  |
|-------------|------------|--|------------------------------|---|------------|--------------------------------------|--|
| <b>F</b>    | <b>S</b>   | <b>D</b>                               | <b>75</b>                    | — | <b>8</b>   | <b>5K or DSL</b>                     | <b>10</b>  |
| Type        | Wire Type  | Color Code                             | Wire Size (mm <sup>2</sup> ) |   | DIN Length | Std. Pkg. Size                       | Color-Code Number  |
| F = Ferrule | S = Single | D = DIN<br>= Standard<br>(leave blank) |                              |   |            | 3K = 3,000<br>5K = 5,000<br>DSL = 50 | 0 = Black<br>2 = Red<br>3 = Orange<br>4 = Yellow<br>6 = Blue<br>7 = Light Blue<br>8 = Gray<br>10 = White |

D2. Power Connectors

D3. Grounding Connectors

E1. Labeling Systems

E2. Labels

E3. Pre-Printed & Write-On Markers

E4. Permanent Identification

E5. Lockout/Tagout & Safety Solutions

F. Index



## Insulated Ferrules on Strips – Single Wire

### Type FS

- Polypropylene insulation housing available in DIN standard colors in strips of 50
- Continuously molded design provides consistent placement of ferrules in tool to ensure fast, reliable terminations
- Available in #20 – 14 AWG featuring a seamless barrel design to contain loose wire strands for superior terminations
- Designed for use with the Semiautomatic Ferrule Crimping Tool CT-1000 for medium volume applications

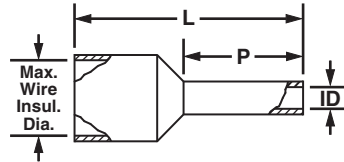
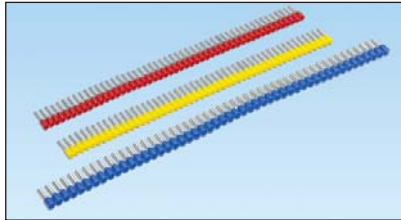

| Part Number | Wire Size |                 | Color | Max. Wire Insul. Dia. |    | Figure Dimensions |  |   |  |    |  | Wire Strip Length |    | Recommended Installation Tool | Std. Pkg. Qty. |
|-------------|-----------|-----------------|-------|-----------------------|----|-------------------|--|---|--|----|--|-------------------|----|-------------------------------|----------------|
|             | AWG       | mm <sup>2</sup> |       | In.                   | mm | L                 |  | P |  | ID |  | In.               | mm |                               |                |

### DIN End Sleeves

|               |        |      |       |      |     |      |      |      |     |      |     |       |      |         |     |
|---------------|--------|------|-------|------|-----|------|------|------|-----|------|-----|-------|------|---------|-----|
| FSD75-8-DSL10 | 20 AWG | 0.50 | White | 0.10 | 2.6 | 0.60 | 15.2 | 0.31 | 8.0 | 0.04 | 1.0 | 13/32 | 10.0 | CT-1000 | 500 |
| FSD76-8-DSL8  | 18 AWG | 0.75 | Gray  | 0.11 | 2.7 | 0.60 | 15.2 | 0.31 | 8.0 | 0.06 | 1.5 | 13/32 | 10.0 |         | 500 |
| FSD77-8-DSL2  |        | 1.00 | Red   | 0.12 | 3.0 | 0.60 | 15.2 | 0.31 | 8.0 | 0.07 | 1.8 | 13/32 | 10.0 |         | 500 |
| FSD78-8-DSL0  | 16 AWG | 1.50 | Black | 0.13 | 3.2 | 0.60 | 15.2 | 0.31 | 8.0 | 0.09 | 2.3 | 13/32 | 10.0 |         | 500 |
| FSD80-8-DSL6  | 14 AWG | 2.50 | Blue  | 0.16 | 4.0 | 0.60 | 15.2 | 0.31 | 8.0 | 0.09 | 2.3 | 13/32 | 10.0 |         | 500 |

### Additional Colored End Sleeves

|              |        |      |            |      |     |      |      |      |     |      |     |       |      |         |     |
|--------------|--------|------|------------|------|-----|------|------|------|-----|------|-----|-------|------|---------|-----|
| FS75-8-DSL3  | 20 AWG | 0.50 | Orange     | 0.10 | 2.6 | 0.60 | 15.2 | 0.31 | 8.0 | 0.04 | 1.0 | 13/32 | 10.0 | CT-1000 | 500 |
| FS76-8-DSL10 | 18 AWG | 0.75 | White      | 0.11 | 2.7 | 0.60 | 15.2 | 0.31 | 8.0 | 0.05 | 1.2 | 13/32 | 10.0 |         | 500 |
| FS76-8-DSL7  |        |      | Light Blue | 0.11 | 2.7 | 0.60 | 15.2 | 0.31 | 8.0 | 0.05 | 1.2 | 13/32 | 10.0 |         | 500 |
| FS77-8-DSL4  |        | 1.00 | Yellow     | 0.12 | 3.0 | 0.60 | 15.2 | 0.31 | 8.0 | 0.06 | 1.5 | 13/32 | 10.0 |         | 500 |
| FS78-8-DSL2  | 16 AWG | 1.50 | Red        | 0.13 | 3.2 | 0.60 | 15.2 | 0.31 | 8.0 | 0.07 | 1.8 | 13/32 | 10.0 |         | 500 |
| FS80-8-DSL8  | 14 AWG | 2.50 | Gray       | 0.16 | 4.0 | 0.60 | 15.2 | 0.31 | 8.0 | 0.09 | 2.3 | 13/32 | 10.0 |         | 500 |

A.  
System  
Overview

B1.  
Cable Ties

B2.  
Cable  
Accessories

B3.  
Stainless  
Steel Ties

C1.  
Wiring  
Duct

C2.  
Surface  
Raceway

C3.  
Abrasion  
Protection

C4.  
Cable  
Management

D1.  
Terminals

D2.  
Power  
Connectors

D3.  
Grounding  
Connectors

E1.  
Labeling  
Systems

E2.  
Labels

E3.  
Pre-Printed  
& Write-On  
Markers

E4.  
Permanent  
Identification

E5.  
Lockout/  
Tagout  
& Safety  
Solutions

F.  
Index

A. System Overview

## Semiautomatic Ferrule Crimping Tool – CT-1000

B1. Cable Ties

- Innovative rapid load design utilizes continuously molded ferrules to significantly reduce installation time
- Adjustable die setting allows termination of all Panduit #20 – 14 AWG continuously molded ferrules with a single tool
- Controlled cycle tool cuts, strips, and crimps wire to maximize efficiency

B2. Cable Accessories



B3. Stainless Steel Ties

| Part Number | Part Description  | Std. Pkg. Qty. |
|-------------|---|----------------|
| CT-1000     | Controlled cycle crimp tool with trapezoid profile for #20 – 14 AWG (0.50 – 2.5mm <sup>2</sup> ) insulated continuously molded ferrules on strips. Also cuts and strips wire. | 1              |

C1. Wiring Duct

C2. Surface Raceway

C3. Abrasion Protection



## Insulated Ferrules on Reels – Single Wire

### Type FS

C4. Cable Management

- Polypropylene insulation housing available in DIN standard colors in reels of 3000 and 5000
- Designed specifically for use with the Ferrule Applicator (CA10) for high volume applications
- Continuously molded design provides consistent placement of ferrules in applicator to ensure fast, reliable terminations
- Available in #20 – 14 AWG featuring a seamless barrel design to contain loose wire strands for superior terminations

D1. Terminals

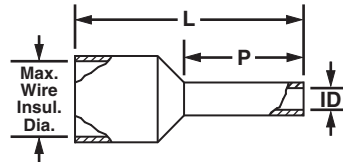

D2. Power Connectors

D3. Grounding Connectors

| Part Number | Wire Size |                 | Color | Max. Wire Insul. Dia. |    | Figure Dimensions |  |   |  |    |  | Wire Strip Length |    | CA10 Series Dies | Pieces Per Reel |
|-------------|-----------|-----------------|-------|-----------------------|----|-------------------|--|---|--|----|--|-------------------|----|------------------|-----------------|
|             | AWG       | mm <sup>2</sup> |       | In.                   | mm | L                 |  | P |  | ID |  | In.               | mm |                  |                 |

E1. Labeling Systems

### DIN End Sleeves

|              |        |      |       |      |     |      |      |      |     |      |     |       |      |        |      |
|--------------|--------|------|-------|------|-----|------|------|------|-----|------|-----|-------|------|--------|------|
| FSD75-8-5K10 | 20 AWG | 0.50 | White | 0.10 | 2.6 | 0.57 | 14.5 | 0.31 | 8.0 | 0.04 | 1.0 | 13/32 | 10.0 | CD10-1 | 5000 |
| FSD76-8-5K8  | 18 AWG | 0.75 | Gray  | 0.11 | 2.7 | 0.57 | 14.5 | 0.31 | 8.0 | 0.05 | 1.2 | 13/32 | 10.0 |        | 5000 |
| FSD77-8-5K2  | 18 AWG | 1.00 | Red   | 0.12 | 3.0 | 0.57 | 14.5 | 0.31 | 8.0 | 0.06 | 1.5 | 13/32 | 10.0 |        | 5000 |
| FSD78-8-5K0  | 16 AWG | 1.50 | Black | 0.13 | 3.2 | 0.57 | 14.5 | 0.31 | 8.0 | 0.07 | 1.8 | 13/32 | 10.0 | CD10-2 | 5000 |
| FSD80-8-3K6  | 14 AWG | 2.50 | Blue  | 0.16 | 4.0 | 0.57 | 14.5 | 0.31 | 8.0 | 0.09 | 2.3 | 13/32 | 10.0 |        | 3000 |

E2. Labels

### Additional Colored End Sleeves

|             |        |      |            |      |     |      |      |      |     |      |     |       |      |        |      |
|-------------|--------|------|------------|------|-----|------|------|------|-----|------|-----|-------|------|--------|------|
| FS75-8-5K3  | 20 AWG | 0.50 | Orange     | 0.10 | 2.6 | 0.57 | 14.5 | 0.31 | 8.0 | 0.04 | 1.0 | 13/32 | 10.0 | CD10-1 | 5000 |
| FS76-8-5K10 | 18 AWG | 0.75 | White      | 0.11 | 2.7 | 0.57 | 14.5 | 0.31 | 8.0 | 0.05 | 1.2 | 13/32 | 10.0 |        | 5000 |
| FS76-8-5K7  | 18 AWG | 0.75 | Light Blue | 0.11 | 2.7 | 0.57 | 14.5 | 0.31 | 8.0 | 0.05 | 1.2 | 13/32 | 10.0 |        | 5000 |
| FS77-8-5K4  | 18 AWG | 1.00 | Yellow     | 0.12 | 3.0 | 0.57 | 14.5 | 0.31 | 8.0 | 0.06 | 1.5 | 13/32 | 10.0 | CD10-2 | 5000 |
| FS78-8-5K2  | 16 AWG | 1.50 | Red        | 0.13 | 3.2 | 0.57 | 14.5 | 0.31 | 8.0 | 0.07 | 1.8 | 13/32 | 10.0 |        | 5000 |
| FS80-8-3K8  | 14 AWG | 2.50 | Gray       | 0.16 | 4.0 | 0.57 | 14.5 | 0.31 | 8.0 | 0.09 | 2.3 | 13/32 | 10.0 | CD10-3 | 3000 |

E5. Lockout/Tagout & Safety Solutions

F. Index

## Reel Smart™ Ferrule Applicator – CA10

- Designed for use with continuously molded ferrules in reels of 3,000 or 5,000 for high volume applications
- Precision ferrule indexing through applicator for optimum reliability and productivity

- Universal base plate allows compatibility with the Panduit CP-871 electric press, and other commercially available bench presses and automatic wire processing (AWP) machines
- Quick change die sets terminate the entire ferrule line to provide fast product change over and reduction in setup time; dies sold separately



| Part Number | Part Description  | Std. Pkg. Qty. |
|-------------|---|----------------|
| CA10        | Applicator used to terminate entire line of Reel Smart™ Continuously Molded Ferrules on reels. For use with CP-871 Electric Press and CD10 series die sets. | 1              |
| CD10-1      | Die insert to be used with the CA10 applicator to terminate FS75, FSD75, FS76 and FSD76 Reel Smart™ Continuously Molded Ferrules.                           | 1              |
| CD10-2      | Die insert to be used with the CA10 applicator to terminate FS77, FSD77, FS78 and FSD78 Reel Smart™ Continuously Molded Ferrules.                           | 1              |
| CD10-3      | Die insert to be used with the CA10 applicator to terminate FS80 and FSD80 Reel Smart™ Continuously Molded Ferrules.  | 1              |

## CA9 Ezair™ and CA-800EZ Applicators

- Designed to terminate all continuously molded terminals, disconnects, and splices in reels of 3,000 or 5,000 for high volume applications
- Precision terminal indexing through applicator for optimum reliability and productivity

- Universal base plate allows compatibility with the Panduit CP-871 electric press, and other commercially available bench presses and automatic wire processing (AWP) machines
- Quick change die sets allow for fast product change over and reduction in setup time; dies sold separately



| Part Number | Part Description  | Std. Pkg. Qty. |
|-------------|---|----------------|
| CA-800EZ*   | Applicator: runs in the AMP* Model T and K bench presses. True “quick change” applicator — no additional plates are necessary. Slide right into the press for easy changeover. Uses CD-800 series die inserts.  | 1              |
| CA9         | CA9 Ezair™ Applicator: terminates the entire Reel Smart™ product line. This greatly reduces set up and maintenance time and increases productivity. This patented applicator is so smart it automatically adjusts feed stroke to the correct pitch and length for the entire product line. Crimp die changeover in less than 1 minute, minimizes downtime and increases productivity. Fast, easy loading of terminal parts without special instructions or setup personnel. Simply feed the parts strip into the applicator. All the necessary adjustments are made by the dies and the automatic feed stroke.<br>Used in CP-871 electric press.<br>Safety lockout guard ensures operator safety.<br>Positive stop adjustment rings allow for electrical and insulation crimp adjustments as desired. | 1              |

\*AMP is a registered trademark of Tyco Electronics.  
For crimp die information, refer to pages D1.145 and D1.146.

A.  
System  
Overview

B1.  
Cable Ties

B2.  
Cable  
Accessories

B3.  
Stainless  
Steel Ties

C1.  
Wiring  
Duct

C2.  
Surface  
Raceway

C3.  
Abrasion  
Protection

C4.  
Cable  
Management

D1.  
Terminals

D2.  
Power  
Connectors

D3.  
Grounding  
Connectors

E1.  
Labeling  
Systems

E2.  
Labels

E3.  
Pre-Printed  
& Write-On  
Markers

E4.  
Permanent  
Identification

E5.  
Lockout/  
Tagout  
& Safety  
Solutions

F.  
Index

A.  
System  
Overview

## Electric Bench Press

B1.  
Cable Ties

- For use with Panduit Applicators and Reel Smart™ Continuously Molded Terminals and Ferrules to provide a superior solution for quality, high volume terminations

- Tool crimp height adjustment feature allows user to easily set and maintain desired crimp height for consistent performance

B2.  
Cable  
Accessories

- CP-871 press has a microprocessor based controller and LCD that displays text messages and cycle count with multi-language capability

- Applicator can be changed without the use of tools to facilitate faster changeover for lower cost of ownership

B3.  
Stainless  
Steel Ties



| Part Number | Part Description   | Std. Pkg. Qty. |
|-------------|--|----------------|
| CP-871      | Electric press:<br>4000+ terminations per hour.<br>Operates on 110 VAC current/60 Hz, 220 VAC current/50 Hz (field convertible).<br>Overall size (without reel): 13" x 33" x 16".<br>Total weight (without reel): 176 lbs.<br>Includes foot pedal. | 1              |

C1.  
Wiring  
Duct

C2.  
Surface  
Raceway

C3.  
Abrasion  
Protection

C4.  
Cable  
Management

## Die Sharpening Kits

- Used to resharpen cutting edges and maintain reliability of CD-800 and CD9 series cutter dies

| Part Number | Part Description                        | Std. Pkg. Qty. |
|-------------|---|----------------|
| DSF-RS      | For use with black oxide cutter dies.   | 1              |
| DSF-NP      | For use with nickel-plated cutter dies. | 1              |

D1.  
Terminals

D2.  
Power  
Connectors

D3.  
Grounding  
Connectors

E1.  
Labeling  
Systems

E2.  
Labels

E3.  
Pre-Printed  
& Write-On  
Markers

E4.  
Permanent  
Identification

E5.  
Lockout/  
Tagout  
& Safety  
Solutions

F.  
Index



## Die Information

| Part Number  | AWG Wire Range                  | Color Code   | (1) Wire Insulation Strain Relief  | Part No. Prefix   | 60/40 Solder Slug Dia. |      | Spare Part Number          |                              |                         |
|--------------|---------------------------------|--------------|--|---|------------------------|------|----------------------------|------------------------------|-------------------------|
|              |                                 |              |  |   | In.                    | mm   | Crimp Die                  | Cutter Die                   | Lower Die               |
| CD-800-1     | 22 – 18,<br>22 – 16             | Red          | Plastic Ins. Crimp,<br>Insulation Support,<br>Metal Ins. Crimp,<br>Plastic Ins. Crimp                      | PV, DV-MB, DV-B, BSN,<br>PN, PNF, DNF-M, BSP<br>(Premium Nylon) | 0.188                  | 4.78 | TD13471C06<br>CD-800-1     | TD13483C02<br>CD-800 C1      | TD17755B01<br>CD-1      |
| CD-800-1D*** | 22-18                           |              |  |   |                        |      |                            |                              |                         |
| CD-800-2     | 16 – 14,<br>18 – 14             | Blue         | Plastic Ins. Crimp,<br>Insulation Support,<br>Metal Ins. Crimp,<br>Plastic Ins. Crimp                      | PV, DV-MB, DV-B, BSN,<br>PN, PNF, DNF-M, BSP<br>(Premium Nylon) |                        |      | TD13473C05<br>CD-800-2     | TD13486C03<br>CD-800C-2      | TD17756B01<br>C-2       |
| CD-800-2D*** | 16 – 14                         |              |  |   |                        |      |                            |                              |                         |
| CD-800-3     | 12 – 10,<br>14 – 10,<br>16 – 12 | Yellow       | Plastic Ins. Crimp,<br>Plastic Ins. Crimp,<br>Metal Ins. Crimp,<br>Plastic Ins. Crimp,<br>Metal Ins. Crimp | PV, PV12, DV, DV-C,<br>PN12, PV12, DV-M,<br>PN, PNF, DNF-M      |                        |      | TD13475C06<br>CD-800-3     | TD13489C02<br>CD-800C-3      | TD17757B01<br>C-3       |
| CD-800-4     | 12 – 18                         | Red          | Insulation Support   | DNF-FIB, DNF-FIM,<br>DNF-FIMB, DNF-LPB                          |                        |      |                            |                              |                         |
| CD-800-5     | 16 – 14                         | Blue         | Insulation Support   | DNF-FIB, DNF-FIM,<br>DNF-FIMB, DNF-LPB                          |                        |      | TD13634C05<br>CD-800-5, 11 | TD13508C02<br>CD-800<br>C-5  | TD17759B01<br>C-5, 11   |
| CD-800-6     | 22 – 18                         | Red          | Insulation Support   | DNF-FIBX  |                        |      |                            |                              |                         |
| CD-800-7     | 22 – 18                         | Red          | Insulation Support   | DNF-110FIB,<br>DNF-111FIB,<br>DNF-112FIB                        | 0.125                  | 3.18 | TD13477C05<br>CD-800-7, 12 | TD13492C03<br>CD-800<br>C-7  | TD17761B01<br>C-7, 12   |
| CD-800-8     | 22 – 18,<br>16 – 14             | Red/<br>Blue | Insulation Support   | DNF-FIBX, DNF-FIMX,<br>DNF-FIMX                                 | 0.188                  | 4.78 | TD13481C06<br>CD-800-8     | TD13502C03<br>CD-800<br>C-8  | TD17762B01<br>C-8       |
| CD-800-9     | 22 – 14                         | Red/<br>Blue | Insulation Support   | DNFR-FIB  | 0.125                  | 3.18 | TD13479C05<br>CD-800-9     | TD13495C02<br>CD-800<br>C-9  | TD17763B01<br>C-9       |
| CD-800-10    | 22 – 18                         | Red          | DiscoGrip™<br>Insulation Crimp   | DPF-FIB, DPF-FIM,<br>DPF-FIMB, DPF-LPB                          | 0.188                  | 4.78 | TD13633C06<br>CD-800-4, 10 | TD16233C02<br>CD-800<br>C-10 | TD17758B01<br>C-4, 10   |
| CD-800-11    | 16 – 14                         | Blue         | DiscoGrip™<br>Insulation Crimp   | DPF-FIM, DPF-FIMB,<br>DPF-FIB, DPF-LPB                          |                        |      |                            |                              |                         |
| CD-800-12    | 22 – 18                         | Red          | DiscoGrip™<br>Insulation Crimp   | DPF-110FIB,<br>DPF-111FIB                                       | 0.125                  | 3.18 | TD13477C05<br>CD-800-7, 12 | TD16235C02<br>CD-800<br>C-12 | TD17761B01<br>C-7, 12   |
| CD-800-13    | 12 – 10                         | Yellow       | Insulation Support,<br>DiscoGrip™<br>Insulation Crimp  | DNF-FIB, DPF-FIB  | 0.188                  | 4.78 | TD19116C03<br>CD-800-13    | TD19115C05<br>CD-800<br>C-13 | TD19424B01<br>C-13      |
| CD-800-14    | 22 – 18,<br>16 – 14             | Red/<br>Blue | Metal Insulation<br>Crimp  | DNG-FL  | 0.125                  | 3.18 | TD22943C01<br>CD-800-14    | TD22944C01<br>CD-800<br>C-14 | TD22960B01<br>C-14      |
| CD-800-15    | 22 – 18                         | Red          | Metal Insulation<br>Crimp  | DNG-FB  | 0.188                  | 4.78 | TD22945C01<br>CD-800-15    | TD22946C01<br>CD-800<br>C-15 | TD22961B01<br>C-15      |
| CD-800-16    | 16 – 14                         | Blue         | Metal Insulation<br>Crimp  | DNG-FB  |                        |      |                            |                              |                         |
| CD-800-17    | 12 – 10                         | Yellow       | Insulation Support   | BSN   | 0.188                  | 4.78 | TD23601C01<br>CD-800-17    | TD23600C01<br>CD-800-17      | TD23612B01<br>CD-800-17 |
| CD-800-18    | 12 – 10                         | Yellow       | Plastic Insulation<br>Crimp  | DNF-FIMB  |                        |      |                            |                              |                         |

TA13721A01 = 60/40 Solder Slug with 1/8" (.125) outer diameter.

TA13722A01 = 60/40 Solder Slug with 3/16" (.188) outer diameter.

(1) Insulation Support: Minimum wire insulation strain relief for normal applications.

Plastic and DiscoGrip™ Insulation Crimp: Secondary wire insulation strain relief for high vibration or conductor strain applications.

Metal Insulation Grip: Maximum wire insulation strain relief for high vibration or conductor strain applications.

\*\*\*Modified lower die for barrel insulated disconnects DV-B series. Available as a complete die set or just lower die assembly.

Table continues on page D1.146

A. System Overview

## Die Information (continued)

B1. Cable Ties

B2. Cable Accessories

B3. Stainless Steel Ties

C1. Wiring Duct

C2. Surface Raceway

C3. Abrasion Protection

C4. Cable Management

D1. Terminals

D2. Power Connectors

D3. Grounding Connectors

E1. Labeling Systems

E2. Labels

E3. Pre-Printed & Write-On Markers

E4. Permanent Identification

E5. Lockout/Tagout & Safety Solutions

F. Index

| Part Number       | Color Code   | AWG Wire Range      | Wire Insulation Strain Relief   | Part No. Prefix                                | 60/40 Solder Slug Diameter |      | Spare Part Number |            |                          |
|-------------------|--------------|---------------------|---|--|----------------------------|------|-------------------|------------|--------------------------|
|                   |              |                     |   |  | In.                        | mm   | Crimp Die         | Cutter Die | Lower Die                |
| <b>CD9-1A</b>     | Red          | 22 – 16,<br>22 – 18 | Insulation Support, Plastic Ins. Crimp, Plastic Ins. Crimp, Metal Ins. Grip                     | BSN, BSP, PV, DV-B, DV-MB, PN, PNF, DNF-M      | 0.188                      | 4.78 | TD24129C01        | TD24139C01 | TD24149C01               |
| <b>CD9-1AD***</b> |              | 22 – 18             | Plastic Insulation Crimp, Metal Insulation Grip   | PV, DV-B, DV-MB, PN, PNF, DNF-M                | 0.188                      | 4.78 |                   |            |                          |
| <b>CD9-1B</b>     |              | 22 – 18             | Plastic Insulation Crimp  | PV-56R, PV-38R                                 | 0.188                      | 4.78 |                   |            |                          |
| <b>CD9-2A</b>     | Blue         | 18 – 14,<br>16 – 14 | Insulation Support, Plastic Ins. Crimp, Insulation Support, Plastic Ins. Crimp, Metal Ins. Grip | BSN, BSP, BSN, PV, DV-B, DV-MB, PN, PNF, DNF-M | 0.188                      | 4.78 | TD24130C01        | TD24140C01 | TD23712C01               |
| <b>CD9-2AD***</b> |              | 16 – 14             | Insulation Support, Plastic Insulation Crimp, Metal Insulation Grip                             | BSN, PV, DV-B, DV-MB, PN, PNF, DNF-M           | 0.188                      | 4.78 |                   |            |                          |
| <b>CD9-2B</b>     |              | 16 – 14             | Plastic Insulation Crimp  | PV-56R, PV-38R                                 | 0.188                      | 4.78 |                   |            |                          |
| <b>CD9-3B</b>     | Yellow       | 12 – 10,<br>16 – 12 | Plastic Ins. Crimp, Metal Ins. Grip, Plastic Ins. Crimp   | PV, DV, DV-M, PN, PNF, DNF-M, PV12, PN12       | 0.188                      | 4.78 | TD24131C01        | TD24141C01 | TD23713C01               |
| <b>CD9-4A</b>     | Red          | 22 – 18             | Insulation Support  | DNF-FIB, DNF-LPB                               | 0.188                      | 4.78 | TD24132C01        | TD24142C01 | TD24150C01               |
| <b>CD9-4B</b>     |              | 22 – 18             | Insulation Support  | DNF-FIM, DNF-FIMB                              | 0.188                      | 4.78 |                   |            |                          |
| <b>CD9-5A</b>     | Blue         | 16 – 14             | Insulation Support  | DNF-FIB, DNF-LPB                               | 0.188                      | 4.78 | TD24133C01        | TD24143C01 | TD24151C01               |
| <b>CD9-5B</b>     |              | 16 – 14             | Insulation Support  | DNF-FIM, DNF-FIMB                              | 0.188                      | 4.78 |                   |            |                          |
| <b>CD9-6B</b>     | Red          | 22 – 18             | Insulation Support  | DNF-FIBX                                       | 0.188                      | 4.78 | TD23700C01        | TD23683C01 | TD23716C01               |
| <b>CD9-7A</b>     | Red          | 22 – 18             | Insulation Support  | DNF-110, 111, 112FIB                           | 0.125                      | 3.18 | TD23701C02        | TD23684C01 | TD23717C01               |
| <b>CD9-8B</b>     | Blue/<br>Red | 16 – 14,<br>22 – 14 | Insulation Support  | DNF-FIBX, DNF-FIMX                             | 0.188                      | 4.78 | TD23702C01        | TD23685C01 | TD23718C01               |
| <b>CD9-9C</b>     | Red/<br>Blue | 22 – 14             | Insulation Support  | DNFR-FIB                                       | 0.125                      | 3.18 | TD23703C01        | TD23686C01 | TD23719C01               |
| <b>CD9-10A</b>    | Red          | 22 – 18             | DiscoGrip™ Insulation Crimp   | DPF-FIB, DPF-LPB                               | 0.188                      | 4.78 | TD24132C01        | TD24144C01 | TD24150C01               |
| <b>CD9-10B</b>    | Red          | 22 – 18             | DiscoGrip™ Insulation Crimp   | DPF-FIM, DPF-FIMB                              | 0.188                      | 4.78 |                   |            |                          |
| <b>CD9-11A</b>    | Blue         | 16 – 14             | DiscoGrip™ Insulation Crimp   | DPF-FIB, DPF-LPB                               | 0.188                      | 4.78 | TD24133C01        | TD23688C01 | TD24151C01               |
| <b>CD9-11B</b>    | Blue         | 16 – 14             | DiscoGrip™ Insulation Crimp   | DPF-FIM, DPF-FIMB                              | 0.188                      | 4.78 |                   |            |                          |
| <b>CD9-12A</b>    | Red          | 22 – 18             | DiscoGrip™ Insulation Crimp   | DPF-110FIB, DFP-111FIB                         | 0.125                      | 3.18 | TD23701C02        | TD23689C01 | TD23717C01               |
| <b>CD9-13B</b>    | Yellow       | 12 – 10             | Insulation Support, DiscoGrip™ Insulation Crimp   | DNF-FIB, DPF-FIB                               | 0.188                      | 4.78 | TD24134C01        | TD24145C01 | TD24152C01               |
| <b>CD9-14A</b>    | Red/<br>Blue | 22 – 18,<br>16 – 14 | Metal Insulation Grip   | DNG-FL   | 0.125                      | 3.18 | TD23705C01        | TD23691C01 | TD23721C01               |
| <b>CD9-15A</b>    | Red          | 22 – 18             | Metal Insulation Grip   | DNG-FB   | 0.188                      | 4.78 | TD24135C01        | TD24146C01 | TD24153C01               |
| <b>CD9-16A</b>    | Blue         | 16 – 14             | Metal Insulation Grip   | DNG-FB   | 0.188                      | 4.78 | TD24136C01        | TD24147C01 | TD24154C01               |
| <b>CD9-17B</b>    | Yellow       | 12 – 10             | Insulation Support  | BSN  | 0.188                      | 4.78 | TD24110C01        | TD24109C01 | TD24111C01<br>TD24112C01 |
| <b>CD9-18B</b>    | Yellow       | 12 – 10             | Insulation Support  | DNF-FIMB                                       | 0.188                      | 4.78 | TD24131C01        | TD23766C01 | TD23713C01               |
| <b>CD10-1</b>     | —            | 20 – 18             | Insulation Support  | FS75, FSD75, FS76, FSD76                       | —                          | —    | —                 | —          | —                        |
| <b>CD10-2</b>     | —            | 18 – 16             | Insulation Support  | FS77, FSD77, FS78, FSD78                       | —                          | —    | —                 | —          | —                        |
| <b>CD10-3</b>     | —            | 14                  | Insulation Support  | FS80, FSD80                                    | —                          | —    | —                 | —          | —                        |

TA13721A01 = 60/40 Solder Slug with 1/8" (.125) outer diameter.

TA13722A01 = 60/40 Solder Slug with 3/16" (.188) outer diameter.

(1) Insulation Support: Minimum wire insulation strain relief for normal applications.

Plastic and DiscoGrip™ Insulation Crimp: Secondary wire insulation strain relief for high vibration or conductor strain applications.

Metal Insulation Grip: Maximum wire insulation strain relief for high vibration or conductor strain applications.

\*\*\*Modified lower die for barrel insulated disconnects DV-B series. Available as a complete die set or just lower die assembly.

## CA10, CA9 Ezair™, and CA-800EZ Applicators Wire Processing Machine Manufacturer/Press Compatibility

| Manufacturer     | Wire Processing Machine with (WPM) or Bench Press Only  | CA10             | Panduit Applicators  |                                  |
|------------------|---|------------------|--|----------------------------------|
|                  |   |                  | CA9 Ezair™   | CA-800EZ*                        |
| PANDUIT          | CP-851 bench press only<br>CP-861 bench press only<br>CP-862 bench press only<br>CP-871 bench press only  | A                | A <sup>1</sup><br>A <sup>1</sup>   | A                                |
| T/E CONNECTIVITY | CLS III G with G press (AWP)<br>CLS IV with G press (AWP)<br>CLS IV G plus with G press (AWP)<br>G bench press only<br>CLS II with T press (AWP)<br>CLS III with T press (AWP)<br>T bench press only<br>K bench press only  | A<br>A<br>A<br>A | A <sup>1</sup><br>A <sup>1</sup><br>A <sup>1</sup><br>A <sup>1</sup><br>A <sup>1</sup><br>A <sup>1</sup><br>A <sup>3</sup> | A<br>A<br>A                      |
| ARTOS            | CS-600 with AMP G press (AWP)<br>CS-600 with TU7M press (AWP)<br>CS-600 with TU-10 press (AWP)<br>MTX Series 5 with TU-10 press (AWP)   | A                | A <sup>1</sup><br>A <sup>1</sup><br>A <sup>1</sup>   | A                                |
| GAMMA MECCANICA  | T20P-110V bench press only  |                  | A <sup>1</sup>   |                                  |
| KODERA           | Series C451/C450 (AWP)<br>Series C551/C550 (AWP)  | A                | A <sup>1</sup><br>A <sup>1</sup>   |                                  |
| KOMAX            | Gamma 311 with Mecal K300 press (AWP)<br>Gamma 333 with mci 711 press (AWP)<br>Alpha 411 with Mecal PE7 or P107 press (AWP)<br>Alpha 433 with Mecal PE7 or P107 press (AWP)<br>40T with Mecal PE7 press (AWP)<br>40T with Panduit CP-861 press (AWP)<br>bt711 bench press only<br>bt722 | A<br>A           | A <sup>1</sup><br>A <sup>1</sup><br>A <sup>1</sup><br>A <sup>1</sup><br>A <sup>1</sup>                                     | A <sup>2</sup><br>A <sup>2</sup> |
| MEGOMAT          | AMS 3001A/APE 300 press (AWP)<br>Contact (AWP)<br>Primo with MP-3.0 press (AWP)   |                  | A <sup>1</sup><br>A <sup>1</sup><br>A <sup>1</sup>   |                                  |
| MOLEX            | EP-20 bench press only<br>TM-2000 bench press only  |                  |  | A<br>A                           |
| SCHLEUNIGER      | Crimp center 12 with ACP01 press (AWP)<br>Crimp center 64 (AWP)<br>UC-200 bench press   | A<br>A           | A <sup>1</sup><br>A <sup>1</sup><br>A <sup>1</sup>   | A                                |
| SHINMAYWA        | TR101 (AWP)<br>TRD111/TR111 (AWP)   |                  | A <sup>1</sup>   | A<br>A                           |

A = Compatible with Press.

Special Requirements: \*Refer to the specific applicator operation manual for installation instructions.

<sup>1</sup> See specific section of installation manual for details.

<sup>2</sup> Komax press shim is required to operate CA-800EZ Applicator.

<sup>3</sup> Bench press air feed capability is required.

<sup>4</sup> Remove press wire stripper.

A.  
System  
Overview

B1.  
Cable Ties

B2.  
Cable  
Accessories

B3.  
Stainless  
Steel Ties

C1.  
Wiring  
Duct

C2.  
Surface  
Raceway

C3.  
Abrasion  
Protection

C4.  
Cable  
Management

D1.  
Terminals

D2.  
Power  
Connectors

D3.  
Grounding  
Connectors

E1.  
Labeling  
Systems

E2.  
Labels

E3.  
Pre-Printed  
& Write-On  
Markers

E4.  
Permanent  
Identification

E5.  
Lockout/  
Tagout/  
& Safety  
Solutions

F.  
Index

A. System Overview

## Performance Requirements

B1. Cable Ties

|  | Wire Size (AWG) |     |     |     |     |     |     |     |
|--|-----------------|-----|-----|-----|-----|-----|-----|-----|
|  | #26             | #24 | #22 | #20 | #18 | #16 | #14 | #12 |

**UL 486A (Terminals), UL 310 (Male Blade Adapters)**

|                                       |     |   |   |    |    |    |    |    |    |
|---------------------------------------|-----|---|---|----|----|----|----|----|----|
| Test current for max. 50° rise (amps) | 3.5 | 7 | 9 | 12 | 17 | 18 | 30 | 35 | 50 |
| Min. tensile strength* (lbs.)         | 3   | 5 | 8 | 13 | 20 | 30 | 50 | 70 | 80 |

**UL 486C (Splices)**

|  |     |   |   |    |    |    |    |    |    |
|--|-----|---|---|----|----|----|----|----|----|
| Test current for max. 50°C rise (amps) | 5.5 | 7 | 9 | 12 | 17 | 18 | 30 | 35 | 50 |
| Min. tensile strength* (lbs.)          | 3   | 5 | 8 | 10 | 10 | 15 | 25 | 35 | 40 |

\*Pull-out force of the crimped terminal.

C1. Wiring Duct

C2. Surface Raceway

|  | Wire Size (AWG) |     |     |     |     |     |     |
|--|-----------------|-----|-----|-----|-----|-----|-----|
|  | #22             | #20 | #18 | #16 | #14 | #12 | #10 |

**UL 310 (Disconnects)**

|  |   |   |   |    |    |    |    |
|--|---|---|---|----|----|----|----|
| Continuous test current for max. 30°C rise (amps) (for .187", .205", .250" tab widths) | 3 | 4 | 7 | 10 | 15 | 20 | 24 |
|--|---|---|---|----|----|----|----|

|   |   |   |   |   |                |  |  |
|---|---|---|---|---|----------------|--|--|
| Continuous test current for max. 30°C rise (amps) (for .110" tab width) | 2 | 3 | 4 | 5 | Not Applicable |  |  |
|---|---|---|---|---|----------------|--|--|

|                               |   |    |    |    |    |    |    |
|-------------------------------|---|----|----|----|----|----|----|
| Min. tensile strength* (lbs.) | 8 | 13 | 20 | 30 | 50 | 70 | 80 |
|-------------------------------|---|----|----|----|----|----|----|

\*Pull-out force of the crimped disconnect.

C4. Cable Management

D1. Terminals

D2. Power Connectors

D3. Grounding Connectors

E1. Labeling Systems

E2. Labels

E3. Pre-Printed & Write-On Markers

E4. Permanent Identification

E5. Lockout/Tagout & Safety Solutions

F. Index

**Applicable Pan-Term® products meet or exceed the following test specifications:**

- UL 486A (Terminals)
- UL 486C (Splices)
- UL 310 (Blade Adapters)
- CSA C22.2 No. 65 (all designs)
- UL and CSA approved products are shown with the applicable logos in the product section.
- UL file #E52164, CSA File #LR31212

**Applicable Reel Smart™ products meet or exceed the following test specifications:**

- Listed per Underwriters Laboratories, Inc. Standard UL 310 (Disconnects)
- Recognized under the Component Recognition Program of Underwriters Laboratories Inc.
- Certified by Canadian Standards Association (Disconnects)
- UL and CSA listed products are shown with the applicable logos in the product section.
- UL file #E78526, CSA file #LR31212

# NOTES

A.  
System  
Overview

B1.  
Cable Ties

B2.  
Cable  
Accessories

B3.  
Stainless  
Steel Ties

C1.  
Wiring  
Duct

C2.  
Surface  
Raceway

C3.  
Abrasion  
Protection

C4.  
Cable  
Management

D1.  
Terminals

D2.  
Power  
Connectors

D3.  
Grounding  
Connectors

E1.  
Labeling  
Systems

E2.  
Labels

E3.  
Pre-Printed  
& Write-On  
Markers

E4.  
Permanent  
Identification

E5.  
Lockout/  
Tagout  
& Safety  
Solutions

F.  
Index

A. System Overview

B1. Cable Ties

B2. Cable Accessories

B3. Stainless Steel Ties

C1. Wiring Duct

C2. Surface Raceway

C3. Abrasion Protection

C4. Cable Management

D1. Terminals

D2. Power Connectors

D3. Grounding Connectors

E1. Labeling Systems

E2. Labels

E3. Pre-Printed & Write-On Markers

E4. Permanent Identification

E5. Lockout/Tagout & Safety Solutions

F. Index

## Compression Connector Reference Information

**Selection Guide - Pand-Loc® Copper Compression Connectors for Copper Code Conductor**

| Connector         | Barrel Style    | Type                | Page Number   |
|-------------------|-----------------|---------------------|---|
| Short barrel lug  | Standard barrel | Standard barrel lug | 02-01, 02-02, 02-03, 02-04, 02-05, 02-06, 02-07, 02-08, 02-09, 02-10, 02-11, 02-12, 02-13, 02-14, 02-15, 02-16, 02-17, 02-18, 02-19, 02-20, 02-21, 02-22, 02-23, 02-24, 02-25, 02-26, 02-27, 02-28, 02-29, 02-30, 02-31, 02-32, 02-33, 02-34, 02-35, 02-36, 02-37, 02-38, 02-39, 02-40, 02-41, 02-42, 02-43, 02-44, 02-45, 02-46, 02-47, 02-48, 02-49, 02-50, 02-51, 02-52, 02-53, 02-54, 02-55, 02-56, 02-57, 02-58, 02-59, 02-60, 02-61, 02-62, 02-63, 02-64, 02-65, 02-66, 02-67, 02-68, 02-69, 02-70, 02-71, 02-72, 02-73, 02-74, 02-75, 02-76, 02-77, 02-78, 02-79, 02-80, 02-81, 02-82, 02-83, 02-84, 02-85, 02-86, 02-87, 02-88, 02-89, 02-90, 02-91, 02-92, 02-93, 02-94, 02-95, 02-96, 02-97, 02-98, 02-99, 02-100 |
| Double barrel lug | Standard barrel | Double barrel lug   | 02-01, 02-02, 02-03, 02-04, 02-05, 02-06, 02-07, 02-08, 02-09, 02-10, 02-11, 02-12, 02-13, 02-14, 02-15, 02-16, 02-17, 02-18, 02-19, 02-20, 02-21, 02-22, 02-23, 02-24, 02-25, 02-26, 02-27, 02-28, 02-29, 02-30, 02-31, 02-32, 02-33, 02-34, 02-35, 02-36, 02-37, 02-38, 02-39, 02-40, 02-41, 02-42, 02-43, 02-44, 02-45, 02-46, 02-47, 02-48, 02-49, 02-50, 02-51, 02-52, 02-53, 02-54, 02-55, 02-56, 02-57, 02-58, 02-59, 02-60, 02-61, 02-62, 02-63, 02-64, 02-65, 02-66, 02-67, 02-68, 02-69, 02-70, 02-71, 02-72, 02-73, 02-74, 02-75, 02-76, 02-77, 02-78, 02-79, 02-80, 02-81, 02-82, 02-83, 02-84, 02-85, 02-86, 02-87, 02-88, 02-89, 02-90, 02-91, 02-92, 02-93, 02-94, 02-95, 02-96, 02-97, 02-98, 02-99, 02-100 |
| T-Splines         | Standard barrel | T-Spline            | 02-01, 02-02, 02-03, 02-04, 02-05, 02-06, 02-07, 02-08, 02-09, 02-10, 02-11, 02-12, 02-13, 02-14, 02-15, 02-16, 02-17, 02-18, 02-19, 02-20, 02-21, 02-22, 02-23, 02-24, 02-25, 02-26, 02-27, 02-28, 02-29, 02-30, 02-31, 02-32, 02-33, 02-34, 02-35, 02-36, 02-37, 02-38, 02-39, 02-40, 02-41, 02-42, 02-43, 02-44, 02-45, 02-46, 02-47, 02-48, 02-49, 02-50, 02-51, 02-52, 02-53, 02-54, 02-55, 02-56, 02-57, 02-58, 02-59, 02-60, 02-61, 02-62, 02-63, 02-64, 02-65, 02-66, 02-67, 02-68, 02-69, 02-70, 02-71, 02-72, 02-73, 02-74, 02-75, 02-76, 02-77, 02-78, 02-79, 02-80, 02-81, 02-82, 02-83, 02-84, 02-85, 02-86, 02-87, 02-88, 02-89, 02-90, 02-91, 02-92, 02-93, 02-94, 02-95, 02-96, 02-97, 02-98, 02-99, 02-100 |

### Selection Guide

- Provides a quick and easy method to select the proper connector to meet the specific application requirements

Conductor Type

Stud Hole Configuration

Barrel Style

Product Type and Page Number

**Pand-Loc® Conductor, Blank Tongue, Long Barrel Lug (continued)**

Agency Listings: UL, CSA, IEC, etc.

Features and Benefits: High strength, easy installation, etc.

| Part Number | Conductor Size | Die Part Number | Die Index Number | Number of Crimps | Color Code |
|-------------|----------------|-----------------|------------------|------------------|------------|
| LCCB-001    | 1/2"           | 02-001          | 01               | 1                | Blue       |
| LCCB-002    | 3/8"           | 02-002          | 01               | 1                | Blue       |
| LCCB-003    | 1/4"           | 02-003          | 01               | 1                | Blue       |

### Product Page

- Includes all necessary information for part identification and selection

Agency Listings

Features and Benefits

Full Color Photo and 2-View Drawing

Panduit and Competitor Die Information

Page Reference for Panduit and Competitor Installation Tooling and Die Selection Charts

**Installation Tooling and Die Selections for LCCB, LCCB, LCCB and SCL**

| Conductor Size | Tool Part Number | Die Part Number | Die Index Number | Number of Crimps |
|----------------|------------------|-----------------|------------------|------------------|
| 1/2"           | 02-001           | 02-001          | 01               | 1                |
| 3/8"           | 02-002           | 02-002          | 01               | 1                |
| 1/4"           | 02-003           | 02-003          | 01               | 1                |

### Installation Tooling and Die Selection Chart

- Contains comprehensive tool and die installation information for Panduit compression connectors with both Panduit and competitor tools

Page Reference to Compression Connector Tools Selection Guide for Detailed Information on Panduit Tools

Panduit and Competitor Tools

Product Type Listed by Conductor Size

Die Part Number, Color Code, Die Index Number and Number of Crimps for Each Product Type and Tool Combination



## PAN-LUG™ COMPRESSION CONNECTORS

Panduit® Pan-Lug™ Compression Connectors provide permanent terminations for a variety of power and grounding applications, with innovation, highest reliability, and lowest installed cost. Panduit offers the first and only copper compression lugs and splices that meet Network Equipment-Building Systems (NEBS) Level 3 requirements as tested by Telcordia Technologies. NEBS Level 3 assures that product performance is suitable for equipment applications that demand minimal service interruptions over the life span of the equipment.



- **Functional product information is marked directly on the connector, facilitating the identification, ordering, and usage of the compression connector**
- **Color-coded to facilitate quick identification of the proper crimping die**
- **Made from high strength, high conductivity electrolytic copper and aluminum alloy materials to provide optimum connectivity for power and grounding applications**
- **UL Listed or Recognized, CSA Certified, ABS Type Approved and tested by Telcordia – meets NEBS Level 3, as noted**
- **Terminations using Panduit® Pan-Lug™ Compression Connectors are also UL Listed and CSA Certified with specified competitor tools**
- **Wide assortment of manual, controlled cycle, battery operated hydraulic and pneumatic crimping tools for reliable connections at the lowest installed cost**

Panduit® Pan-Lug™ Compression Connectors are designed for use with many different code and flex conductor types and are available in a broad range of styles and sizes including copper one-hole, two-hole, and blank tongue lugs and splices; aluminum one-hole and two-hole lugs and splices; and copper in-line reducing splices. Panduit offers a wide assortment of Pan-Lug™ Power Connectors to meet customer needs and today's application requirements.

A.  
System  
Overview

B1.  
Cable Ties

B2.  
Cable  
Accessories

B3.  
Stainless  
Steel Ties

C1.  
Wiring  
Duct

C2.  
Surface  
Raceway

C3.  
Abrasion  
Protection

C4.  
Cable  
Management

D1.  
Terminals

D2.  
Power  
Connectors

D3.  
Grounding  
Connectors

E1.  
Labeling  
Systems

E2.  
Labels

E3.  
Pre-Printed  
& Write-On  
Markers

E4.  
Permanent  
Identification

E5.  
Lockout/  
Tagout  
& Safety  
Solutions

F.  
Index

A. System Overview

## Features and Benefits – Pan-Lug™ Compression Connectors

B1. Cable Ties

**Bolded features are unique to Panduit.**

B2. Cable Accessories

B3. Stainless Steel Ties

C1. Wiring Duct

C2. Surface Raceway

C3. Abrasion Protection

C4. Cable Management

D1. Terminals

D2. Power Connectors

D3. Grounding Connectors

E1. Labeling Systems

E2. Labels

E3. Pre-Printed & Write-On Markers

E4. Permanent Identification

E5. Lockout/Tagout & Safety Solutions

F. Index

### Copper Lugs

Color-coded bands for proper die selection and crimp placement

Internally beveled barrel end for easy conductor insertion (types LCCF and LCAF available with flared entry for flex conductor)

Easy-to-read, color-coded die index numbers for Panduit and specified competitor crimping dies for selection

Inspection windows available to assure complete conductor insertion

Made from seamless, high conductivity copper tubing and electro tin-plated and burnished to inhibit corrosion

Part number, stud size, and conductor size marked on part for easy identification



### Flex Lugs

Color-coded bands for proper die selection and crimp placement

Inspection window to assure complete conductor insertion

Made from seamless, high conductivity copper tubing and electro tin-plated and burnished to inhibit corrosion

Easy-to-read, color-coded die index numbers for Panduit and specified competitor crimping dies for selection

Product information marked on part for easy identification

Can be used with code conductor and flex conductor class: G, H, I, K, M and Diesel Locomotive



### Narrow Tongue Lugs

Color-coded bands for proper die selection and crimp placement

Inspection window to assure complete conductor insertion

Easy-to-read, color-coded die index numbers for Panduit and specified competitor crimping dies for selection

Narrow tongue width for limited space applications

Made from seamless, high conductivity copper tubing and electro tin-plated and burnished to inhibit corrosion

Product information marked on part for easy identification



### Copper Metric Lugs

Internally beveled barrel ends for easy conductor insertion

Product information marked on part for easy identification

Inspection window to assure complete conductor insertion

Made from 99.9% pure copper for high quality connection and tin-plated to inhibit corrosion



### Copper Parallel Splice

Chamfered on both ends for fast and easy conductor insertion

Made from seamless, high conductivity copper tubing and electro tin-plated and burnished to inhibit corrosion

Largest part marking in the industry – easier to read in low light conditions

Intuitive part numbering for fast and accurate part selection in the field

Industry recognized color-coding for selection



### Aluminum Lugs

Easy-to-read die index numbers for Panduit and specified competitor crimping dies for selection

Color-coded end plugs for proper die selection

Part number and conductor size marked on part for easy identification

Made from seamless wrought aluminum and electro tin-plated to inhibit corrosion

Crimping areas marked on part for proper crimp placement

Factory pre-filled with oxide inhibitor to prevent oxidation



Compression connector crimping tools speed installation and reduce total installed cost. See pages D3.31 – D3.94.











Panduit designs and manufactures a full line of labeling products, software and printers to assist you with your labeling requirements. See pages E1.1 – E2.22.



Heat shrink tubing provides an economical and easy way to insulate, protect, harness and color code electrical and electronic components. See pages C3.22 – C3.44.

## Selection Guide – Pan-Lug™ Copper Compression Connectors for Copper Code Conductor



| Connector   | Barrel Style                           | Type                           | Page Number    |
|---|--|--------------------------------|----------------|
|    | Short Barrel with Inspection Window    | LCAS                           | D2.7, D2.8     |
|   |  | LCAS-H 45° bent                | D2.9, D2.10    |
|   |  | LCAS-F 90° bent                | D2.11, D2.12   |
|   | Standard Barrel with Inspection Window | LCA                            | D2.13, D2.14   |
|   |  | LCA-H 45° bent                 | D2.15, D2.16   |
|   |  | LCA-F 90° bent                 | D2.17, D2.18   |
|   |  | LCAN narrow tongue             | D2.19, D2.20   |
|   |  | LCA-00 blank tongue            | D2.21          |
|   | Long Barrel no Inspection Window       | LCB                            | D2.22, D2.23   |
|   |  | LCB-H 45° bent                 | D2.24, D2.25   |
|   |  | LCB-F 90° bent                 | D2.26, D2.27   |
|   | Long Barrel with Inspection Window     | LCBH with corona relief taper  | D2.30          |
| LCB-W   |  | D2.28                          |                |
| LCB-WH 45° bent   |  | D2.29                          |                |
|  | Standard Barrel with Inspection Window | LCD                            | D2.31, D2.32   |
|   |  | LCD-H 45° bent                 | D2.33, D2.34   |
|   |  | LCD-F 90° bent                 | D2.35, D2.36   |
|   |  | LCDN narrow tongue             | D2.37          |
|   | Long Barrel no Inspection Window       | LCDN-H 45° bent narrow tongue  | D2.38          |
|   |  | LCDN-F 90° bent narrow tongue  | D2.39          |
|   |  | LCD-00 blank tongue            | D2.40          |
|   |  | LCC                            | D2.41, D2.42   |
|   |  | LCC-H 45° bent                 | D2.43, D2.44   |
|   |  | LCC-F 90° bent                 | D2.45, D2.46   |
| Long Barrel with Inspection Window  | LCCH with corona relief taper          | D2.56                          |                |
|   | LCC-00 blank tongue                    | D2.57                          |                |
|   | LCC-W                                  | D2.47, D2.48, D2.49            |                |
|   | LCC-WH 45° bent                        | D2.50, D2.51, D2.52            |                |
|   | LCC-WF 90° bent                        | D2.53, D2.54, D2.55            |                |
|   | LCCN-W narrow tongue                   | D2.55                          |                |
|   | LCC-00W blank tongue                   | D2.58                          |                |
|  | Short Barrel                           | SCSS                           | D2.59          |
|   | Standard Barrel                        | SCS                            | D2.60          |
|   | Long Barrel                            | SCL                            | D2.61          |
|   |  | SCH with corona relief chamfer | D2.62          |
|  |  | SCT                            | D2.63          |
|  |  | PSC                            | D2.64          |
|  |  | LCMA                           | D2.107, D2.108 |
|  |  | LCMD                           | D2.109, D2.110 |
|  |  | SCMS                           | D2.111         |

A. System Overview

B1. Cable Ties

B2. Cable Accessories

B3. Stainless Steel Ties

C1. Wiring Duct

C2. Surface Raceway

C3. Abrasion Protection

C4. Cable Management

D1. Terminals

D2. Power Connectors

D3. Grounding Connectors

E1. Labeling Systems

E2. Labels

E3. Pre-Printed & Write-On Markers

E4. Permanent Identification

E5. Lockout/Tagout & Safety Solutions

F. Index

A. System Overview

B1. Cable Ties

B2. Cable Accessories

B3. Stainless Steel Ties

C1. Wiring Duct

C2. Surface Raceway

C3. Abrasion Protection

C4. Cable Management

D1. Terminals

D2. Power Connectors

D3. Grounding Connectors

E1. Labeling Systems

E2. Labels

E3. Pre-Printed & Write-On Markers





E4. Permanent Identification

E5. Lockout/Tagout & Safety Solutions

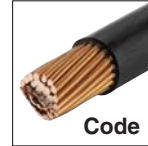





F. Index

## Selection Guide – Pan-Lug™ Copper Compression Connectors for Copper Code and/or Flex Conductor



| Connector   | Barrel Style   | Type   | Page Number    |
|---|--|--|----------------|
|  <p><b>One-Hole Lugs</b></p>   | Standard Barrel with Inspection Window Code and Flex         | LCAX   | D2.66, D2.67   |
|   |  | LCAX-H 45° bent                                      | D2.68, D2.69   |
|   |  | LCAX-F 90° bent                                      | D2.70, D2.71   |
|   |  | LCAXN narrow tongue                                  | D2.72          |
|   | Standard Barrel with Inspection Window and Flared Entry Flex | LCAF   | D2.73, D2.74   |
|   |  | LCAF-H 45° bent                                      | D2.75, D2.76   |
|   |  | LCAF-F 90° bent                                      | D2.77, D2.78   |
|   | Long Barrel with Inspection Window Code and Flex             | LCBX   | D2.79          |
|   |  | LCBX-H 45° bent                                      | D2.80          |
|   |  | LCBX-F 90° bent                                      | D2.81          |
|  <p><b>Two-Hole Lugs</b></p>   | Standard Barrel with Inspection Window Code and Flex         | LCDX   | D2.82, D2.83   |
|   |  | LCDX-H 45° bent                                      | D2.84, D2.85   |
|   |  | LCDX-F 90° bent                                      | D2.86, D2.87   |
|   |  | LCDXN narrow tongue                                  | D2.88          |
|   |  | LCDXN-H 45° bent narrow tongue                       | D2.89          |
|   | LCDXN-F 90° bent narrow tongue                               | D2.89  |                |
|   | Long Barrel no Inspection Window Flared Entry Flex           | LCCF   | D2.96, D2.97   |
|   |  | LCCF-H 45° bent                                      | D2.98, D2.99   |
|   |  | LCCF-F 90° bent                                      | D2.100, D2.101 |
|   | Long Barrel with Inspection Window Code and Flex             | LCCX   | D2.90, D2.91   |
| LCCX-H 45° bent   |  | D2.92, D2.93   |                |
| LCCX-F 90° bent   |  | D2.94, D2.95   |                |
| LCCXN narrow tongue   |  | D2.95  |                |
|  <p><b>Butt Splices with Flared Entry for Flex</b></p>                   |  | SCSF   | D2.102         |
|  <p><b>Reducing Splices with Inspection Window for Code and Flex</b></p> |  | RSCK kits with reducing splice and clear heat shrink | D2.103, D2.104 |
|   |  | RSC reducing splices                                 | D2.105, D2.106 |

## Selection Guide – Pan-Lug™ Aluminum Compression Connectors for Aluminum or Copper Code Conductor

| Connector   | Type  | Page Number    |
|---|---|----------------|
|    | One-Hole Lugs — LAA   | D2.112         |
|    | Two-Hole Lugs — LAB   | D2.113         |
|    | Butt Splices — SA   | D2.115         |
|  | Reducing Splices — SAR  | D2.116         |
|  | Bi-Metallic Pin Connectors for Aluminum Conductors Only — BPC | D2.117         |
|  | Belleville Washers — CW                                       | D2.114, D2.155 |
|  | Joint Compounds — CMP   | D2.118, D2.155 |

A.  
System  
Overview

B1.  
Cable Ties

B2.  
Cable  
Accessories

B3.  
Stainless  
Steel Ties

C1.  
Wiring  
Duct

C2.  
Surface  
Raceway

C3.  
Abrasion  
Protection

C4.  
Cable  
Management

D1.  
Terminals

D2.  
Power  
Connectors

D3.  
Grounding  
Connectors

E1.  
Labeling  
Systems

E2.  
Labels

E3.  
Pre-Printed  
& Write-On  
Markers

E4.  
Permanent  
Identification

E5.  
Lockout/  
Tagout  
& Safety  
Solutions

F.  
Index

A.  
System  
Overview

B1.  
Cable Ties

B2.  
Cable  
Accessories

B3.  
Stainless  
Steel Ties

C1.  
Wiring  
Duct

C2.  
Surface  
Raceway

C3.  
Abrasion  
Protection

C4.  
Cable  
Management

D1.  
Terminals

D2.  
Power  
Connectors

D3.  
Grounding  
Connectors

E1.  
Labeling  
Systems

E2.  
Labels

E3.  
Pre-Printed  
& Write-On  
Markers

E4.  
Permanent  
Identification

E5.  
Lockout/  
Tagout  
& Safety  
Solutions

F.  
Index

## Part Number System for Pan-Lug™ Compression AWG Lugs

**LCD**

Type

**2/0**

Conductor  
Size

**38**

Stud Hole  
Size

**D**

Two Stud  
Hole Spacing

**F**

Tongue Angle

**X**

Standard Package Size

Ex: LCD Lug, Copper  
Two-Hole  
Standard Barrel

10 = #10

14 = 1/4"

56 = 5/16"

38 = 3/8"

12 = 1/2"

58 = 5/8"

34 = 3/4"

78 = 7/8"

00 = Blank Tongue\*

\* LCA, LCC  
and LCD  
styles only

A = .625"

B = .750"

C = .875"

D = 1.0"

E = 1.25"

G = 1.5"

J = .5"

K = 2"

M = 1.375"

P = .688"

Q = 1.125"

No Letter = 1.75"

H = 45° Angle

F = 90° Angle

No Letter = Straight

1 = 1

2 = 2

3 = 3

5 = 5

6 = 6

X = 10

E = 20

Q = 25

L = 50





## Code Conductor, One-Hole, Short Barrel with Window Lug

For Use with Stranded Copper Conductors

### Type LCAS

- Short barrel for limited space applications
- Color-coded barrels marked with Panduit and specified competitor die index numbers for proper crimp die selection
- Inspection window to visually assure full conductor insertion
- Tin-plated to inhibit corrosion
- UL Listed and CSA Certified to 35 KV\*\* and temperature rated to 90°C when crimped with Panduit and specified competitor crimping tools and dies
- Tested by Telcordia – meets NEBS Level 3
- American Bureau of Shipping approved

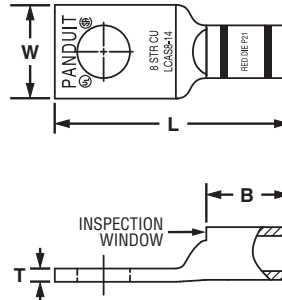

| Part Number         | Copper Conductor Size | Stud Hole Size (In.) | Figure Dimensions (In.) |      |      |      | Panduit Color Code | Panduit Die Index No.‡ | Burdny Die Index No.‡ | T&B Die Index No.‡ | Wire Strip Length (In.) | Std. Pkg. Qty. |
|---------------------|-----------------------|----------------------|-------------------------|------|------|------|--------------------|------------------------|-----------------------|--------------------|-------------------------|----------------|
|                     |                       |                      | W                       | B    | T    | L    |                    |                        |                       |                    |                         |                |
| <b>LCAS8-10-L</b>   | #8 AWG                | #10                  | 0.41                    | 0.42 | 0.08 | 1.11 | Red                | P21                    | 49                    | 21                 | 1/2                     | 50             |
| <b>LCAS8-14-L</b>   |                       | 1/4                  | 0.48                    | 0.42 | 0.07 | 1.20 | Red                | P21                    | 49                    | 21                 | 1/2                     | 50             |
| <b>LCAS8-56-L</b>   |                       | 5/16                 | 0.56                    | 0.42 | 0.05 | 1.32 | Red                | P21                    | 49                    | 21                 | 1/2                     | 50             |
| <b>LCAS8-38-L</b>   |                       | 3/8                  | 0.60                    | 0.42 | 0.05 | 1.42 | Red                | P21                    | 49                    | 21                 | 1/2                     | 50             |
| <b>LCAS6-10-L</b>   | #6 AWG                | #10                  | 0.45                    | 0.48 | 0.09 | 1.19 | Blue               | P24                    | 7                     | 24                 | 9/16                    | 50             |
| <b>LCAS6-14-L</b>   |                       | 1/4                  | 0.48                    | 0.48 | 0.08 | 1.28 | Blue               | P24                    | 7                     | 24                 | 9/16                    | 50             |
| <b>LCAS6-56-L</b>   |                       | 5/16                 | 0.56                    | 0.48 | 0.07 | 1.40 | Blue               | P24                    | 7                     | 24                 | 9/16                    | 50             |
| <b>LCAS6-38-L</b>   |                       | 3/8                  | 0.62                    | 0.48 | 0.06 | 1.50 | Blue               | P24                    | 7                     | 24                 | 9/16                    | 50             |
| <b>LCAS4-10-L</b>   | #4 AWG                | #10                  | 0.55                    | 0.53 | 0.09 | 1.26 | Gray               | P29                    | 8                     | 29                 | 5/8                     | 50             |
| <b>LCAS4-14-L</b>   |                       | 1/4                  | 0.55                    | 0.53 | 0.09 | 1.35 | Gray               | P29                    | 8                     | 29                 | 5/8                     | 50             |
| <b>LCAS4-56-L</b>   |                       | 5/16                 | 0.55                    | 0.53 | 0.09 | 1.47 | Gray               | P29                    | 8                     | 29                 | 5/8                     | 50             |
| <b>LCAS4-38-L</b>   |                       | 3/8                  | 0.62                    | 0.53 | 0.07 | 1.57 | Gray               | P29                    | 8                     | 29                 | 5/8                     | 50             |
| <b>LCAS2-14-Q</b>   | #2 AWG                | 1/4                  | 0.60                    | 0.57 | 0.10 | 1.46 | Brown              | P33                    | 10                    | 33                 | 5/8                     | 25             |
| <b>LCAS2-56-Q</b>   |                       | 5/16                 | 0.66                    | 0.57 | 0.10 | 1.58 | Brown              | P33                    | 10                    | 33                 | 5/8                     | 25             |
| <b>LCAS2-38-Q</b>   |                       | 3/8                  | 0.66                    | 0.57 | 0.10 | 1.66 | Brown              | P33                    | 10                    | 33                 | 5/8                     | 25             |
| <b>LCAS2-12-Q</b>   |                       | 1/2                  | 0.75                    | 0.57 | 0.08 | 1.89 | Brown              | P33                    | 10                    | 33                 | 5/8                     | 25             |
| <b>LCAS1-14-E</b>   | #1 AWG                | 1/4                  | 0.70                    | 0.59 | 0.11 | 1.50 | Green              | P37                    | 11                    | 37                 | 11/16                   | 20             |
| <b>LCAS1-56-E</b>   |                       | 5/16                 | 0.70                    | 0.59 | 0.11 | 1.63 | Green              | P37                    | 11                    | 37                 | 11/16                   | 20             |
| <b>LCAS1-38-E</b>   |                       | 3/8                  | 0.70                    | 0.59 | 0.11 | 1.70 | Green              | P37                    | 11                    | 37                 | 11/16                   | 20             |
| <b>LCAS1-12-E</b>   |                       | 1/2                  | 0.75                    | 0.59 | 0.09 | 1.94 | Green              | P37                    | 11                    | 37                 | 11/16                   | 20             |
| <b>LCAS1/0-14-X</b> | 1/0 AWG               | 1/4                  | 0.76                    | 0.66 | 0.12 | 1.67 | Pink               | P42                    | 12                    | 42                 | 3/4                     | 10             |
| <b>LCAS1/0-56-X</b> |                       | 5/16                 | 0.76                    | 0.66 | 0.12 | 1.72 | Pink               | P42                    | 12                    | 42                 | 3/4                     | 10             |
| <b>LCAS1/0-38-X</b> |                       | 3/8                  | 0.76                    | 0.66 | 0.12 | 1.80 | Pink               | P42                    | 12                    | 42                 | 3/4                     | 10             |
| <b>LCAS1/0-12-X</b> |                       | 1/2                  | 0.80                    | 0.66 | 0.12 | 2.03 | Pink               | P42                    | 12                    | 42                 | 3/4                     | 10             |
| <b>LCAS2/0-14-X</b> | 2/0 AWG               | 1/4                  | 0.85                    | 0.72 | 0.13 | 1.82 | Black              | P45                    | 13                    | 45                 | 3/4                     | 10             |
| <b>LCAS2/0-56-X</b> |                       | 5/16                 | 0.85                    | 0.72 | 0.13 | 1.82 | Black              | P45                    | 13                    | 45                 | 3/4                     | 10             |
| <b>LCAS2/0-38-X</b> |                       | 3/8                  | 0.85                    | 0.72 | 0.13 | 1.89 | Black              | P45                    | 13                    | 45                 | 3/4                     | 10             |
| <b>LCAS2/0-12-X</b> |                       | 1/2                  | 0.85                    | 0.72 | 0.13 | 2.14 | Black              | P45                    | 13                    | 45                 | 3/4                     | 10             |

‡See pages D3.56, D3.57 for tool and die information.

\*\*Consult cable manufacturer for voltage stress relief instructions with applications greater than 2000 V.

Table continues on page D2.8

A. System Overview

B1. Cable Ties

B2. Cable Accessories

B3. Stainless Steel Ties

C1. Wiring Duct

C2. Surface Raceway

C3. Abrasion Protection

C4. Cable Management

D1. Terminals

D2. Power Connectors

D3. Grounding Connectors

E1. Labeling Systems

E2. Labels

E3. Pre-Printed & Write-On Markers

E4. Permanent Identification

E5. Lockout/Tagout & Safety Solutions

F. Index

A.  
System  
Overview

B1.  
Cable Ties

B2.  
Cable  
Accessories

B3.  
Stainless  
Steel Ties

C1.  
Wiring  
Duct

C2.  
Surface  
Raceway

C3.  
Abrasion  
Protection

C4.  
Cable  
Management

D1.  
Terminals

D2.  
Power  
Connectors

D3.  
Grounding  
Connectors

E1.  
Labeling  
Systems

E2.  
Labels

E3.  
Pre-Printed  
& Write-On  
Markers

E4.  
Permanent  
Identification

E5.  
Lockout/  
Tagout  
& Safety  
Solutions

F.  
Index



## Code Conductor, One-Hole, Short Barrel with Window Lug (continued)

| Part Number         | Copper Conductor Size | Stud Hole Size (In.) | Figure Dimensions (In.) |      |      |      | Panduit Color Code | Panduit Die Index No.‡ | Burndy Die Index No.‡ | T&B Die Index No.‡ | Wire Strip Length (In.) | Std. Pkg. Qty. |
|---------------------|-----------------------|----------------------|-------------------------|------|------|------|--------------------|------------------------|-----------------------|--------------------|-------------------------|----------------|
|                     |                       |                      | W                       | B    | T    | L    |                    |                        |                       |                    |                         |                |
| <b>LCAS3/0-14-X</b> | 3/0 AWG               | 1/4                  | 0.96                    | 0.83 | 0.13 | 1.97 | Orange             | P50                    | 14                    | 50                 | 7/8                     | 10             |
| <b>LCAS3/0-56-X</b> |                       | 5/16                 | 0.96                    | 0.83 | 0.13 | 1.97 | Orange             | P50                    | 14                    | 50                 | 7/8                     | 10             |
| <b>LCAS3/0-38-X</b> |                       | 3/8                  | 0.96                    | 0.83 | 0.13 | 2.03 | Orange             | P50                    | 14                    | 50                 | 7/8                     | 10             |
| <b>LCAS3/0-12-X</b> |                       | 1/2                  | 0.96                    | 0.83 | 0.13 | 2.28 | Orange             | P50                    | 14                    | 50                 | 7/8                     | 10             |
| <b>LCAS4/0-14-X</b> | 4/0 AWG               | 1/4                  | 1.06                    | 0.91 | 0.14 | 2.08 | Purple             | P54                    | 15                    | 54                 | 1                       | 10             |
| <b>LCAS4/0-56-X</b> |                       | 5/16                 | 1.06                    | 0.91 | 0.14 | 2.10 | Purple             | P54                    | 15                    | 54                 | 1                       | 10             |
| <b>LCAS4/0-38-X</b> |                       | 3/8                  | 1.06                    | 0.91 | 0.14 | 2.17 | Purple             | P54                    | 15                    | 54                 | 1                       | 10             |
| <b>LCAS4/0-12-X</b> |                       | 1/2                  | 1.06                    | 0.91 | 0.14 | 2.40 | Purple             | P54                    | 15                    | 54                 | 1                       | 10             |
| <b>LCAS250-14-X</b> | 250 kcmil             | 1/4                  | 1.17                    | 1.03 | 0.14 | 2.25 | Yellow             | P62                    | 16                    | 62                 | 1 1/8                   | 10             |
| <b>LCAS250-56-X</b> |                       | 5/16                 | 1.17                    | 1.03 | 0.14 | 2.25 | Yellow             | P62                    | 16                    | 62                 | 1 1/8                   | 10             |
| <b>LCAS250-38-X</b> |                       | 3/8                  | 1.17                    | 1.03 | 0.14 | 2.32 | Yellow             | P62                    | 16                    | 62                 | 1 1/8                   | 10             |
| <b>LCAS250-12-X</b> |                       | 1/2                  | 1.17                    | 1.03 | 0.14 | 2.56 | Yellow             | P62                    | 16                    | 62                 | 1 1/8                   | 10             |

‡See pages D3.56, D3.57 for tool and die information.

\*\*Consult cable manufacturer for voltage stress relief instructions with applications greater than 2000 V.



## Code Conductor, One-Hole, Short Barrel with Window Lug, 45° Angle

For Use with Stranded Copper Conductors

### Type LCAS-H

- Short barrel for limited space applications
- Color-coded barrels marked with Panduit and specified competitor die index numbers for proper crimp die selection
- Inspection window to visually assure full conductor insertion
- Tin-plated to inhibit corrosion

- UL Listed and CSA Certified to 35 KV\*\* and temperature rated to 90°C when crimped with Panduit and specified competitor crimping tools and dies
- Tested by Telcordia – meets NEBS Level 3
- American Bureau of Shipping approved

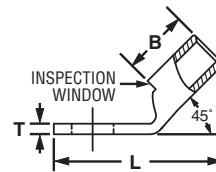
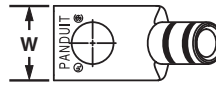

| Part Number   | Copper Conductor Size | Stud Hole Size (In.) | Figure Dimensions (In.) |      |      |      | Panduit Color Code | Panduit Die Index No.‡ | Burdndy Die Index No.‡ | T&B Die Index No.‡ | Wire Strip Length (In.) | Std. Pkg. Qty. |
|---------------|-----------------------|----------------------|-------------------------|------|------|------|--------------------|------------------------|------------------------|--------------------|-------------------------|----------------|
|               |                       |                      | W                       | B    | T    | L    |                    |                        |                        |                    |                         |                |
| LCAS8-10H-L   | #8 AWG                | #10                  | 0.41                    | 0.42 | 0.08 | 1.00 | Red                | P21                    | 49                     | 21                 | 1/2                     | 50             |
| LCAS8-14H-L   |                       | 1/4                  | 0.48                    | 0.42 | 0.07 | 1.09 | Red                | P21                    | 49                     | 21                 | 1/2                     | 50             |
| LCAS8-56H-L   |                       | 5/16                 | 0.56                    | 0.42 | 0.05 | 1.20 | Red                | P21                    | 49                     | 21                 | 1/2                     | 50             |
| LCAS8-38H-L   |                       | 3/8                  | 0.60                    | 0.42 | 0.05 | 1.30 | Red                | P21                    | 49                     | 21                 | 1/2                     | 50             |
| LCAS6-10H-L   | #6 AWG                | #10                  | 0.45                    | 0.48 | 0.09 | 1.06 | Blue               | P24                    | 7                      | 24                 | 9/16                    | 50             |
| LCAS6-14H-L   |                       | 1/4                  | 0.48                    | 0.48 | 0.08 | 1.14 | Blue               | P24                    | 7                      | 24                 | 9/16                    | 50             |
| LCAS6-56H-L   |                       | 5/16                 | 0.56                    | 0.48 | 0.07 | 1.26 | Blue               | P24                    | 7                      | 24                 | 9/16                    | 50             |
| LCAS6-38H-L   |                       | 3/8                  | 0.62                    | 0.48 | 0.06 | 1.35 | Blue               | P24                    | 7                      | 24                 | 9/16                    | 50             |
| LCAS4-10H-L   | #4 AWG                | #10                  | 0.55                    | 0.53 | 0.09 | 1.12 | Gray               | P29                    | 8                      | 29                 | 5/8                     | 50             |
| LCAS4-14H-L   |                       | 1/4                  | 0.55                    | 0.53 | 0.09 | 1.21 | Gray               | P29                    | 8                      | 29                 | 5/8                     | 50             |
| LCAS4-56H-L   |                       | 5/16                 | 0.55                    | 0.53 | 0.09 | 1.33 | Gray               | P29                    | 8                      | 29                 | 5/8                     | 50             |
| LCAS4-38H-L   |                       | 3/8                  | 0.62                    | 0.53 | 0.07 | 1.42 | Gray               | P29                    | 8                      | 29                 | 5/8                     | 50             |
| LCAS2-14H-Q   | #2 AWG                | 1/4                  | 0.60                    | 0.57 | 0.10 | 1.27 | Brown              | P33                    | 10                     | 33                 | 5/8                     | 25             |
| LCAS2-56H-Q   |                       | 5/16                 | 0.66                    | 0.57 | 0.10 | 1.39 | Brown              | P33                    | 10                     | 33                 | 5/8                     | 25             |
| LCAS2-38H-Q   |                       | 3/8                  | 0.66                    | 0.57 | 0.10 | 1.46 | Brown              | P33                    | 10                     | 33                 | 5/8                     | 25             |
| LCAS2-12H-Q   |                       | 1/2                  | 0.75                    | 0.57 | 0.08 | 1.68 | Brown              | P33                    | 10                     | 33                 | 5/8                     | 25             |
| LCAS1-14H-E   | #1 AWG                | 1/4                  | 0.70                    | 0.59 | 0.11 | 1.29 | Green              | P37                    | 11                     | 37                 | 11/16                   | 20             |
| LCAS1-56H-E   |                       | 5/16                 | 0.70                    | 0.59 | 0.11 | 1.42 | Green              | P37                    | 11                     | 37                 | 11/16                   | 20             |
| LCAS1-38H-E   |                       | 3/8                  | 0.70                    | 0.59 | 0.11 | 1.49 | Green              | P37                    | 11                     | 37                 | 11/16                   | 20             |
| LCAS1-12H-E   |                       | 1/2                  | 0.75                    | 0.59 | 0.09 | 1.73 | Green              | P37                    | 11                     | 37                 | 11/16                   | 20             |
| LCAS1/0-14H-X | 1/0 AWG               | 1/4                  | 0.76                    | 0.66 | 0.12 | 1.43 | Pink               | P42                    | 12                     | 42                 | 3/4                     | 10             |
| LCAS1/0-56H-X |                       | 5/16                 | 0.76                    | 0.66 | 0.12 | 1.49 | Pink               | P42                    | 12                     | 42                 | 3/4                     | 10             |
| LCAS1/0-38H-X |                       | 3/8                  | 0.76                    | 0.66 | 0.12 | 1.56 | Pink               | P42                    | 12                     | 42                 | 3/4                     | 10             |
| LCAS1/0-12H-X |                       | 1/2                  | 0.80                    | 0.66 | 0.12 | 1.79 | Pink               | P42                    | 12                     | 42                 | 3/4                     | 10             |
| LCAS2/0-14H-X | 2/0 AWG               | 1/4                  | 0.85                    | 0.72 | 0.13 | 1.58 | Black              | P45                    | 13                     | 45                 | 3/4                     | 10             |
| LCAS2/0-56H-X |                       | 5/16                 | 0.85                    | 0.72 | 0.13 | 1.58 | Black              | P45                    | 13                     | 45                 | 3/4                     | 10             |
| LCAS2/0-38H-X |                       | 3/8                  | 0.85                    | 0.72 | 0.13 | 1.64 | Black              | P45                    | 13                     | 45                 | 3/4                     | 10             |
| LCAS2/0-12H-X |                       | 1/2                  | 0.85                    | 0.72 | 0.13 | 1.89 | Black              | P45                    | 13                     | 45                 | 3/4                     | 10             |

‡See pages D3.56, D3.57 for tool and die information.

\*\*Consult cable manufacturer for voltage stress relief instructions with applications greater than 2000 V.

Table continues on page D2.10

A. System Overview

B1. Cable Ties

B2. Cable Accessories

B3. Stainless Steel Ties

C1. Wiring Duct

C2. Surface Raceway

C3. Abrasion Protection

C4. Cable Management

D1. Terminals

D2. Power Connectors

D3. Grounding Connectors

E1. Labeling Systems

E2. Labels

E3. Pre-Printed & Write-On Markers

E4. Permanent Identification

E5. Lockout/Tagout & Safety Solutions

F. Index

A.  
System  
Overview

B1.  
Cable Ties



## Code Conductor, One-Hole, Short Barrel with Window Lug, 45° Angle (continued)

B2.  
Cable  
Accessories

B3.  
Stainless  
Steel Ties

C1.  
Wiring  
Duct

C2.  
Surface  
Raceway

C3.  
Abrasion  
Protection

C4.  
Cable  
Management

D1.  
Terminals

D2.  
Power  
Connectors

D3.  
Grounding  
Connectors

E1.  
Labeling  
Systems

E2.  
Labels

E3.  
Pre-Printed  
& Write-On  
Markers

E4.  
Permanent  
Identification

E5.  
Lockout/  
Tagout  
& Safety  
Solutions

F.  
Index

| Part Number   | Copper Conductor Size | Stud Hole Size (In.) | Figure Dimensions (In.) |      |      |      | Panduit Color Code | Panduit Die Index No.‡ | Burndy Die Index No.‡ | T&B Die Index No.‡ | Wire Strip Length (In.) | Std. Pkg. Qty. |
|---------------|-----------------------|----------------------|-------------------------|------|------|------|--------------------|------------------------|-----------------------|--------------------|-------------------------|----------------|
|               |                       |                      | W                       | B    | T    | L    |                    |                        |                       |                    |                         |                |
| LCAS3/0-14H-X | 3/0 AWG               | 1/4                  | 0.96                    | 0.83 | 0.13 | 1.68 | Orange             | P50                    | 14                    | 50                 | 7/8                     | 10             |
| LCAS3/0-56H-X |                       | 5/16                 | 0.96                    | 0.83 | 0.13 | 1.68 | Orange             | P50                    | 14                    | 50                 | 7/8                     | 10             |
| LCAS3/0-38H-X |                       | 3/8                  | 0.96                    | 0.83 | 0.13 | 1.74 | Orange             | P50                    | 14                    | 50                 | 7/8                     | 10             |
| LCAS3/0-12H-X |                       | 1/2                  | 0.96                    | 0.83 | 0.13 | 1.99 | Orange             | P50                    | 14                    | 50                 | 7/8                     | 10             |
| LCAS4/0-14H-X | 4/0 AWG               | 1/4                  | 1.06                    | 0.91 | 0.14 | 1.77 | Purple             | P54                    | 15                    | 54                 | 1                       | 10             |
| LCAS4/0-56H-X |                       | 5/16                 | 1.06                    | 0.91 | 0.14 | 1.78 | Purple             | P54                    | 15                    | 54                 | 1                       | 10             |
| LCAS4/0-38H-X |                       | 3/8                  | 1.06                    | 0.91 | 0.14 | 1.85 | Purple             | P54                    | 15                    | 54                 | 1                       | 10             |
| LCAS4/0-12H-X |                       | 1/2                  | 1.06                    | 0.91 | 0.14 | 2.08 | Purple             | P54                    | 15                    | 54                 | 1                       | 10             |
| LCAS250-14H-X | 250 kcmil             | 1/4                  | 1.17                    | 1.03 | 0.14 | 1.89 | Yellow             | P62                    | 16                    | 62                 | 1 1/8                   | 10             |
| LCAS250-56H-X |                       | 5/16                 | 1.17                    | 1.03 | 0.14 | 1.90 | Yellow             | P62                    | 16                    | 62                 | 1 1/8                   | 10             |
| LCAS250-38H-X |                       | 3/8                  | 1.17                    | 1.03 | 0.14 | 1.97 | Yellow             | P62                    | 16                    | 62                 | 1 1/8                   | 10             |
| LCAS250-12H-X |                       | 1/2                  | 1.17                    | 1.03 | 0.14 | 2.20 | Yellow             | P62                    | 16                    | 62                 | 1 1/8                   | 10             |

‡See pages D3.56, D3.57 for tool and die information.

\*\*Consult cable manufacturer for voltage stress relief instructions with applications greater than 2000 V.



## Code Conductor, One-Hole, Short Barrel with Window Lug, 90° Angle

For Use with Stranded Copper Conductors

### Type LCAS-F

- Short barrel for limited space applications
- Color-coded barrels marked with Panduit and specified competitor die index numbers for proper crimp die selection
- Inspection window to visually assure full conductor insertion
- Tin-plated to inhibit corrosion

- UL Listed and CSA Certified to 35 KV\*\* and temperature rated to 90°C when crimped with Panduit and specified competitor crimping tools and dies
- Tested by Telcordia – meets NEBS Level 3
- American Bureau of Shipping approved

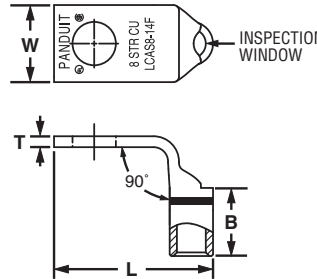

| Part Number   | Copper Conductor Size | Stud Hole Size (In.) | Figure Dimensions (In.) |      |      |      | Panduit Color Code | Panduit Die Index No.‡ | Burdny Die Index No.‡ | T&B Die Index No.‡ | Wire Strip Length (In.) | Std. Pkg. Qty. |
|---------------|-----------------------|----------------------|-------------------------|------|------|------|--------------------|------------------------|-----------------------|--------------------|-------------------------|----------------|
|               |                       |                      | W                       | B    | T    | L    |                    |                        |                       |                    |                         |                |
| LCAS8-10F-L   | #8 AWG                | #10                  | 0.41                    | 0.42 | 0.08 | 0.90 | Red                | P21                    | 49                    | 21                 | 1/2                     | 50             |
| LCAS8-14F-L   |                       | 1/4                  | 0.48                    | 0.42 | 0.07 | 0.99 | Red                | P21                    | 49                    | 21                 | 1/2                     | 50             |
| LCAS8-56F-L   |                       | 5/16                 | 0.56                    | 0.42 | 0.05 | 1.11 | Red                | P21                    | 49                    | 21                 | 1/2                     | 50             |
| LCAS8-38F-L   |                       | 3/8                  | 0.60                    | 0.42 | 0.05 | 1.21 | Red                | P21                    | 49                    | 21                 | 1/2                     | 50             |
| LCAS6-10F-L   | #6 AWG                | #10                  | 0.45                    | 0.48 | 0.09 | 0.94 | Blue               | P24                    | 7                     | 24                 | 9/16                    | 50             |
| LCAS6-14F-L   |                       | 1/4                  | 0.48                    | 0.48 | 0.08 | 1.03 | Blue               | P24                    | 7                     | 24                 | 9/16                    | 50             |
| LCAS6-56F-L   |                       | 5/16                 | 0.56                    | 0.48 | 0.07 | 1.15 | Blue               | P24                    | 7                     | 24                 | 9/16                    | 50             |
| LCAS6-38F-L   |                       | 3/8                  | 0.62                    | 0.48 | 0.06 | 1.25 | Blue               | P24                    | 7                     | 24                 | 9/16                    | 50             |
| LCAS4-10F-L   | #4 AWG                | #10                  | 0.55                    | 0.53 | 0.09 | 1.03 | Gray               | P29                    | 8                     | 29                 | 5/8                     | 50             |
| LCAS4-14F-L   |                       | 1/4                  | 0.55                    | 0.53 | 0.09 | 1.12 | Gray               | P29                    | 8                     | 29                 | 5/8                     | 50             |
| LCAS4-56F-L   |                       | 5/16                 | 0.55                    | 0.53 | 0.09 | 1.24 | Gray               | P29                    | 8                     | 29                 | 5/8                     | 50             |
| LCAS4-38F-L   |                       | 3/8                  | 0.62                    | 0.53 | 0.07 | 1.34 | Gray               | P29                    | 8                     | 29                 | 5/8                     | 50             |
| LCAS2-14F-Q   | #2 AWG                | 1/4                  | 0.60                    | 0.57 | 0.10 | 1.24 | Brown              | P33                    | 10                    | 33                 | 5/8                     | 25             |
| LCAS2-56F-Q   |                       | 5/16                 | 0.66                    | 0.57 | 0.10 | 1.36 | Brown              | P33                    | 10                    | 33                 | 5/8                     | 25             |
| LCAS2-38F-Q   |                       | 3/8                  | 0.66                    | 0.57 | 0.10 | 1.44 | Brown              | P33                    | 10                    | 33                 | 5/8                     | 25             |
| LCAS2-12F-Q   |                       | 1/2                  | 0.75                    | 0.57 | 0.08 | 1.67 | Brown              | P33                    | 10                    | 33                 | 5/8                     | 25             |
| LCAS1-14F-E   | #1 AWG                | 1/4                  | 0.70                    | 0.59 | 0.11 | 1.31 | Green              | P37                    | 11                    | 37                 | 11/16                   | 20             |
| LCAS1-56F-E   |                       | 5/16                 | 0.70                    | 0.59 | 0.11 | 1.44 | Green              | P37                    | 11                    | 37                 | 11/16                   | 20             |
| LCAS1-38F-E   |                       | 3/8                  | 0.70                    | 0.59 | 0.11 | 1.51 | Green              | P37                    | 11                    | 37                 | 11/16                   | 20             |
| LCAS1-12F-E   |                       | 1/2                  | 0.75                    | 0.59 | 0.09 | 1.75 | Green              | P37                    | 11                    | 37                 | 11/16                   | 20             |
| LCAS1/0-14F-X | 1/0 AWG               | 1/4                  | 0.76                    | 0.66 | 0.12 | 1.45 | Pink               | P42                    | 12                    | 42                 | 3/4                     | 10             |
| LCAS1/0-56F-X |                       | 5/16                 | 0.76                    | 0.66 | 0.12 | 1.51 | Pink               | P42                    | 12                    | 42                 | 3/4                     | 10             |
| LCAS1/0-38F-X |                       | 3/8                  | 0.76                    | 0.66 | 0.12 | 1.58 | Pink               | P42                    | 12                    | 42                 | 3/4                     | 10             |
| LCAS1/0-12F-X |                       | 1/2                  | 0.80                    | 0.66 | 0.12 | 1.82 | Pink               | P42                    | 12                    | 42                 | 3/4                     | 10             |
| LCAS2/0-14F-X | 2/0 AWG               | 1/4                  | 0.85                    | 0.72 | 0.13 | 1.59 | Black              | P45                    | 13                    | 45                 | 3/4                     | 10             |
| LCAS2/0-56F-X |                       | 5/16                 | 0.85                    | 0.72 | 0.13 | 1.59 | Black              | P45                    | 13                    | 45                 | 3/4                     | 10             |
| LCAS2/0-38F-X |                       | 3/8                  | 0.85                    | 0.72 | 0.13 | 1.66 | Black              | P45                    | 13                    | 45                 | 3/4                     | 10             |
| LCAS2/0-12F-X |                       | 1/2                  | 0.85                    | 0.72 | 0.13 | 1.91 | Black              | P45                    | 13                    | 45                 | 3/4                     | 10             |

‡See pages D3.56, D3.57 for tool and die information.

\*\*Consult cable manufacturer for voltage stress relief instructions with applications greater than 2000 V.

Table continues on page D2.12

A. System Overview

B1. Cable Ties

B2. Cable Accessories

B3. Stainless Steel Ties

C1. Wiring Duct

C2. Surface Raceway

C3. Abrasion Protection

C4. Cable Management

D1. Terminals

D2. Power Connectors

D3. Grounding Connectors

E1. Labeling Systems

E2. Labels

E3. Pre-Printed & Write-On Markers

E4. Permanent Identification

E5. Lockout/Tagout & Safety Solutions

F. Index

A.  
System  
Overview

B1.  
Cable Ties



## Code Conductor, One-Hole, Short Barrel with Window Lug, 90° Angle (continued)

B2.  
Cable  
Accessories

B3.  
Stainless  
Steel Ties

C1.  
Wiring  
Duct

C2.  
Surface  
Raceway

C3.  
Abrasion  
Protection

C4.  
Cable  
Management

D1.  
Terminals

D2.  
Power  
Connectors

D3.  
Grounding  
Connectors

E1.  
Labeling  
Systems

E2.  
Labels

E3.  
Pre-Printed  
& Write-On  
Markers

E4.  
Permanent  
Identification

E5.  
Lockout/  
Tagout  
& Safety  
Solutions

F.  
Index

| Part Number   | Copper Conductor Size | Stud Hole Size (In.) | Figure Dimensions (In.) |      |      |      | Panduit Color Code | Panduit Die Index No.‡ | Burdny Die Index No.‡ | T&B Die Index No.‡ | Wire Strip Length (In.) | Std. Pkg. Qty. |
|---------------|-----------------------|----------------------|-------------------------|------|------|------|--------------------|------------------------|-----------------------|--------------------|-------------------------|----------------|
|               |                       |                      | W                       | B    | T    | L    |                    |                        |                       |                    |                         |                |
| LCAS3/0-14F-X | 3/0 AWG               | 1/4                  | 0.96                    | 0.83 | 0.13 | 1.67 | Orange             | P50                    | 14                    | 50                 | 7/8                     | 10             |
| LCAS3/0-56F-X |                       | 5/16                 | 0.96                    | 0.83 | 0.13 | 1.67 | Orange             | P50                    | 14                    | 50                 | 7/8                     | 10             |
| LCAS3/0-38F-X |                       | 3/8                  | 0.96                    | 0.83 | 0.13 | 1.73 | Orange             | P50                    | 14                    | 50                 | 7/8                     | 10             |
| LCAS3/0-12F-X |                       | 1/2                  | 0.96                    | 0.83 | 0.13 | 1.98 | Orange             | P50                    | 14                    | 50                 | 7/8                     | 10             |
| LCAS4/0-14F-X | 4/0 AWG               | 1/4                  | 1.06                    | 0.91 | 0.14 | 1.75 | Purple             | P54                    | 15                    | 54                 | 1                       | 10             |
| LCAS4/0-56F-X |                       | 5/16                 | 1.06                    | 0.91 | 0.14 | 1.77 | Purple             | P54                    | 15                    | 54                 | 1                       | 10             |
| LCAS4/0-38F-X |                       | 3/8                  | 1.06                    | 0.91 | 0.14 | 1.84 | Purple             | P54                    | 15                    | 54                 | 1                       | 10             |
| LCAS4/0-12F-X |                       | 1/2                  | 1.06                    | 0.91 | 0.14 | 2.07 | Purple             | P54                    | 15                    | 54                 | 1                       | 10             |
| LCAS250-14F-X | 250 kcmil             | 1/4                  | 1.17                    | 1.03 | 0.14 | 1.82 | Yellow             | P62                    | 16                    | 62                 | 1 1/8                   | 10             |
| LCAS250-56F-X |                       | 5/16                 | 1.17                    | 1.03 | 0.14 | 1.83 | Yellow             | P62                    | 16                    | 62                 | 1 1/8                   | 10             |
| LCAS250-38F-X |                       | 3/8                  | 1.17                    | 1.03 | 0.14 | 1.90 | Yellow             | P62                    | 16                    | 62                 | 1 1/8                   | 10             |
| LCAS250-12F-X |                       | 1/2                  | 1.17                    | 1.03 | 0.14 | 2.13 | Yellow             | P62                    | 16                    | 62                 | 1 1/8                   | 10             |

‡See pages D3.56, D3.57 for tool and die information.

\*\*Consult cable manufacturer for voltage stress relief instructions with applications greater than 2000 V.





## Code Conductor, One-Hole, Standard Barrel with Window Lug

For Use with Stranded Copper Conductors

### Type LCA

- Color-coded barrels marked with Panduit and specified competitor die index numbers for proper crimp die selection
- Inspection window to visually assure full conductor insertion
- Tin-plated to inhibit corrosion
- UL Listed and CSA Certified to 35 KV\*\* and temperature rated to 90°C when crimped with Panduit and specified competitor crimping tools and dies
- UL Listed and CSA Certified for wide wire range-taking capability when crimped with Panduit® Uni-Die™ Dieless Crimping Tools‡
- Tested by Telcordia – meets NEBS Level 3
- American Bureau of Shipping Approved

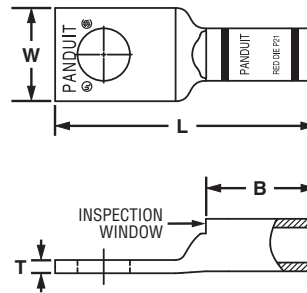

| Part Number | Copper Conductor Size       | Stud Hole Size (In.) | Figure Dimensions (In.) |      |      |      | Panduit Color Code | Panduit Die Index No.‡ | Burdny Die Index No.‡ | T&B Die Index No.‡ | Wire Strip Length (In.) | Std. Pkg. Qty. |
|-------------|-----------------------------|----------------------|-------------------------|------|------|------|--------------------|------------------------|-----------------------|--------------------|-------------------------|----------------|
|             |                             |                      | W                       | B    | T    | L    |                    |                        |                       |                    |                         |                |
| LCA10-10-L* |                             | #10                  | 0.38                    | 0.38 | 0.06 | 1.07 | —                  | —                      | —                     | —                  | 7/16                    | 50             |
| LCA10-14-L* |                             | 1/4                  | 0.42                    | 0.38 | 0.05 | 1.16 | —                  | —                      | —                     | —                  | 7/16                    | 50             |
| LCA10-56-L* |                             | 5/16                 | 0.54                    | 0.38 | 0.04 | 1.28 | —                  | —                      | —                     | —                  | 7/16                    | 50             |
| LCA10-38-L* |                             | 3/8                  | 0.56                    | 0.38 | 0.04 | 1.38 | —                  | —                      | —                     | —                  | 7/16                    | 50             |
| LCA8-10-L   | #8 AWG                      | #10                  | 0.41                    | 0.56 | 0.08 | 1.25 | Red                | P21                    | 49                    | 21                 | 5/8                     | 50             |
| LCA8-14-L   |                             | 1/4                  | 0.48                    | 0.56 | 0.07 | 1.34 | Red                | P21                    | 49                    | 21                 | 5/8                     | 50             |
| LCA8-56-L   |                             | 5/16                 | 0.56                    | 0.56 | 0.05 | 1.46 | Red                | P21                    | 49                    | 21                 | 5/8                     | 50             |
| LCA8-38-L   |                             | 3/8                  | 0.60                    | 0.56 | 0.05 | 1.56 | Red                | P21                    | 49                    | 21                 | 5/8                     | 50             |
| LCA6-10-L   | #6 AWG                      | #10                  | 0.45                    | 0.81 | 0.09 | 1.52 | Blue               | P24                    | 7                     | 24                 | 7/8                     | 50             |
| LCA6-14-L   |                             | 1/4                  | 0.48                    | 0.81 | 0.08 | 1.61 | Blue               | P24                    | 7                     | 24                 | 7/8                     | 50             |
| LCA6-56-L   |                             | 5/16                 | 0.56                    | 0.81 | 0.07 | 1.73 | Blue               | P24                    | 7                     | 24                 | 7/8                     | 50             |
| LCA6-38-L   |                             | 3/8                  | 0.62                    | 0.81 | 0.06 | 1.83 | Blue               | P24                    | 7                     | 24                 | 7/8                     | 50             |
| LCA6-12-L   |                             | 1/2                  | 0.75                    | 0.81 | 0.07 | 2.23 | Blue               | P24                    | 7                     | 24                 | 7/8                     | 50             |
| LCA4-10-L   | #4 – #3 AWG STR, #2 AWG SOL | #10                  | 0.55                    | 0.81 | 0.09 | 1.54 | Gray               | P29                    | 8                     | 29                 | 7/8                     | 50             |
| LCA4-14-L   |                             | 1/4                  | 0.55                    | 0.81 | 0.09 | 1.63 | Gray               | P29                    | 8                     | 29                 | 7/8                     | 50             |
| LCA4-56-L   |                             | 5/16                 | 0.55                    | 0.81 | 0.09 | 1.75 | Gray               | P29                    | 8                     | 29                 | 7/8                     | 50             |
| LCA4-38-L   |                             | 3/8                  | 0.62                    | 0.81 | 0.07 | 1.85 | Gray               | P29                    | 8                     | 29                 | 7/8                     | 50             |
| LCA4-12-L   |                             | 1/2                  | 0.75                    | 0.81 | 0.07 | 2.23 | Gray               | P29                    | 8                     | 29                 | 7/8                     | 50             |
| LCA2-14-Q   | #2 AWG                      | 1/4                  | 0.60                    | 0.88 | 0.10 | 1.77 | Brown              | P33                    | 10                    | 33                 | 15/16                   | 25             |
| LCA2-56-Q   |                             | 5/16                 | 0.66                    | 0.88 | 0.10 | 1.90 | Brown              | P33                    | 10                    | 33                 | 15/16                   | 25             |
| LCA2-38-Q   |                             | 3/8                  | 0.66                    | 0.88 | 0.10 | 1.97 | Brown              | P33                    | 10                    | 33                 | 15/16                   | 25             |
| LCA2-12-Q   |                             | 1/2                  | 0.75                    | 0.88 | 0.08 | 2.21 | Brown              | P33                    | 10                    | 33                 | 15/16                   | 25             |
| LCA1-14-E   | #1 AWG                      | 1/4                  | 0.70                    | 0.88 | 0.11 | 1.79 | Green              | P37                    | 11                    | 37                 | 15/16                   | 20             |
| LCA1-56-E   |                             | 5/16                 | 0.70                    | 0.88 | 0.11 | 1.92 | Green              | P37                    | 11                    | 37                 | 15/16                   | 20             |
| LCA1-38-E   |                             | 3/8                  | 0.70                    | 0.88 | 0.11 | 1.99 | Green              | P37                    | 11                    | 37                 | 15/16                   | 20             |
| LCA1-12-E   |                             | 1/2                  | 0.75                    | 0.88 | 0.09 | 2.23 | Green              | P37                    | 11                    | 37                 | 15/16                   | 20             |

‡See pages D3.58 – D3.61 for tool and die information.

\*Not tested to NEBS Level 3 requirements.

\*\*Consult cable manufacturer for voltage stress relief instructions with applications greater than 2000 V.

Table continues on page D2.14

A. System Overview

B1. Cable Ties

B2. Cable Accessories

B3. Stainless Steel Ties

C1. Wiring Duct

C2. Surface Raceway

C3. Abrasion Protection

C4. Cable Management

D1. Terminals

D2. Power Connectors

D3. Grounding Connectors

E1. Labeling Systems

E2. Labels

E3. Pre-Printed & Write-On Markers

E4. Permanent Identification

E5. Lockout/Tagout & Safety Solutions

F. Index

A.  
System  
Overview

B1.  
Cable Ties

B2.  
Cable  
Accessories

B3.  
Stainless  
Steel Ties

C1.  
Wiring  
Duct

C2.  
Surface  
Raceway

C3.  
Abrasion  
Protection

C4.  
Cable  
Management

D1.  
Terminals

D2.  
Power  
Connectors

D3.  
Grounding  
Connectors

E1.  
Labeling  
Systems

E2.  
Labels

E3.  
Pre-Printed  
& Write-On  
Markers

E4.  
Permanent  
Identification

E5.  
Lockout/  
Tagout  
& Safety  
Solutions

F.  
Index



## Code Conductor, One-Hole, Standard Barrel with Window Lug (continued)

| Part Number        | Copper Conductor Size | Stud Hole Size (In.) | Figure Dimensions (In.) |      |      |      | Panduit Color Code | Panduit Die Index No.‡ | Burndy Die Index No.‡ | T&B Die Index No.‡ | Wire Strip Length (In.) | Std. Pkg. Qty. |
|--------------------|-----------------------|----------------------|-------------------------|------|------|------|--------------------|------------------------|-----------------------|--------------------|-------------------------|----------------|
|                    |                       |                      | W                       | B    | T    | L    |                    |                        |                       |                    |                         |                |
| <b>LCA1/0-14-X</b> | 1/0 AWG               | 1/4                  | 0.76                    | 0.94 | 0.12 | 1.95 | Pink               | P42                    | 12                    | 42                 | 1                       | 10             |
| <b>LCA1/0-56-X</b> |                       | 5/16                 | 0.76                    | 0.94 | 0.12 | 2.00 | Pink               | P42                    | 12                    | 42                 | 1                       | 10             |
| <b>LCA1/0-38-X</b> |                       | 3/8                  | 0.76                    | 0.94 | 0.12 | 2.08 | Pink               | P42                    | 12                    | 42                 | 1                       | 10             |
| <b>LCA1/0-12-X</b> | 2/0 AWG               | 1/2                  | 0.80                    | 0.94 | 0.12 | 2.31 | Pink               | P42                    | 12                    | 42                 | 1                       | 10             |
| <b>LCA2/0-14-X</b> |                       | 1/4                  | 0.85                    | 0.98 | 0.13 | 2.09 | Black              | P45                    | 13                    | 45                 | 1 1/16                  | 10             |
| <b>LCA2/0-56-X</b> |                       | 5/16                 | 0.85                    | 0.98 | 0.13 | 2.09 | Black              | P45                    | 13                    | 45                 | 1 1/16                  | 10             |
| <b>LCA2/0-38-X</b> | 3/0 AWG               | 3/8                  | 0.85                    | 0.98 | 0.13 | 2.15 | Black              | P45                    | 13                    | 45                 | 1 1/16                  | 10             |
| <b>LCA2/0-12-X</b> |                       | 1/2                  | 0.85                    | 0.98 | 0.13 | 2.40 | Black              | P45                    | 13                    | 45                 | 1 1/16                  | 10             |
| <b>LCA3/0-14-X</b> |                       | 1/4                  | 0.96                    | 1.14 | 0.13 | 2.28 | Orange             | P50                    | 14                    | 50                 | 1 3/16                  | 10             |
| <b>LCA3/0-56-X</b> | 4/0 AWG               | 5/16                 | 0.96                    | 1.14 | 0.13 | 2.28 | Orange             | P50                    | 14                    | 50                 | 1 3/16                  | 10             |
| <b>LCA3/0-38-X</b> |                       | 3/8                  | 0.96                    | 1.14 | 0.13 | 2.34 | Orange             | P50                    | 14                    | 50                 | 1 3/16                  | 10             |
| <b>LCA3/0-12-X</b> |                       | 1/2                  | 0.96                    | 1.14 | 0.13 | 2.59 | Orange             | P50                    | 14                    | 50                 | 1 3/16                  | 10             |
| <b>LCA4/0-14-X</b> | 250 kcmil             | 1/4                  | 1.06                    | 1.19 | 0.14 | 2.36 | Purple             | P54                    | 15                    | 54                 | 1 1/4                   | 10             |
| <b>LCA4/0-56-X</b> |                       | 5/16                 | 1.06                    | 1.19 | 0.14 | 2.38 | Purple             | P54                    | 15                    | 54                 | 1 1/4                   | 10             |
| <b>LCA4/0-38-X</b> |                       | 3/8                  | 1.06                    | 1.19 | 0.14 | 2.45 | Purple             | P54                    | 15                    | 54                 | 1 1/4                   | 10             |
| <b>LCA4/0-12-X</b> | 300 kcmil             | 1/2                  | 1.06                    | 1.19 | 0.14 | 2.68 | Purple             | P54                    | 15                    | 54                 | 1 1/4                   | 10             |
| <b>LCA250-14-X</b> |                       | 1/4                  | 1.17                    | 1.25 | 0.14 | 2.47 | Yellow             | P62                    | 16                    | 62                 | 1 5/16                  | 10             |
| <b>LCA250-56-X</b> |                       | 5/16                 | 1.17                    | 1.25 | 0.14 | 2.48 | Yellow             | P62                    | 16                    | 62                 | 1 5/16                  | 10             |
| <b>LCA250-38-X</b> | 350 kcmil             | 3/8                  | 1.17                    | 1.25 | 0.14 | 2.55 | Yellow             | P62                    | 16                    | 62                 | 1 5/16                  | 10             |
| <b>LCA250-12-X</b> |                       | 1/2                  | 1.17                    | 1.25 | 0.14 | 2.78 | Yellow             | P62                    | 16                    | 62                 | 1 5/16                  | 10             |
| <b>LCA300-56-X</b> |                       | 5/16                 | 1.19                    | 1.44 | 0.16 | 2.94 | White              | P66                    | 17                    | 66                 | 1 1/2                   | 10             |
| <b>LCA300-38-X</b> | 400 kcmil             | 3/8                  | 1.19                    | 1.44 | 0.16 | 2.94 | White              | P66                    | 17                    | 66                 | 1 1/2                   | 10             |
| <b>LCA300-12-X</b> |                       | 1/2                  | 1.19                    | 1.44 | 0.16 | 3.05 | White              | P66                    | 17                    | 66                 | 1 1/2                   | 10             |
| <b>LCA300-58-X</b> |                       | 5/8                  | 1.19                    | 1.44 | 0.16 | 3.26 | White              | P66                    | 17                    | 66                 | 1 1/2                   | 10             |
| <b>LCA300-78-X</b> | 500 kcmil             | 7/8                  | 1.19                    | 1.44 | 0.16 | 3.70 | White              | P66                    | 17                    | 66                 | 1 1/2                   | 10             |
| <b>LCA350-38-X</b> |                       | 3/8                  | 1.28                    | 1.44 | 0.17 | 2.98 | Red                | P71                    | 18                    | 71                 | 1 1/2                   | 10             |
| <b>LCA350-12-X</b> |                       | 1/2                  | 1.28                    | 1.44 | 0.17 | 3.09 | Red                | P71                    | 18                    | 71                 | 1 1/2                   | 10             |
| <b>LCA350-58-X</b> | 600 kcmil             | 5/8                  | 1.28                    | 1.44 | 0.17 | 3.30 | Red                | P71                    | 18                    | 71                 | 1 1/2                   | 10             |
| <b>LCA350-78-X</b> |                       | 7/8                  | 1.28                    | 1.44 | 0.17 | 3.74 | Red                | P71                    | 18                    | 71                 | 1 1/2                   | 10             |
| <b>LCA400-38-6</b> |                       | 3/8                  | 1.39                    | 1.50 | 0.18 | 3.22 | Blue               | P76                    | 19                    | 76                 | 1 9/16                  | 6              |
| <b>LCA400-12-6</b> | 750 kcmil             | 1/2                  | 1.39                    | 1.50 | 0.18 | 3.22 | Blue               | P76                    | 19                    | 76                 | 1 9/16                  | 6              |
| <b>LCA400-58-6</b> |                       | 5/8                  | 1.39                    | 1.50 | 0.18 | 3.43 | Blue               | P76                    | 19                    | 76                 | 1 9/16                  | 6              |
| <b>LCA400-78-6</b> |                       | 7/8                  | 1.39                    | 1.50 | 0.18 | 3.82 | Blue               | P76                    | 19                    | 76                 | 1 9/16                  | 6              |
| <b>LCA500-38-6</b> | E1, E2, E3, E4        | 3/8                  | 1.54                    | 1.75 | 0.22 | 3.39 | Brown              | P87                    | 20                    | 87                 | 1 13/16                 | 6              |
| <b>LCA500-12-6</b> |                       | 1/2                  | 1.54                    | 1.75 | 0.22 | 3.55 | Brown              | P87                    | 20                    | 87                 | 1 13/16                 | 6              |
| <b>LCA500-58-6</b> |                       | 5/8                  | 1.54                    | 1.75 | 0.22 | 3.76 | Brown              | P87                    | 20                    | 87                 | 1 13/16                 | 6              |
| <b>LCA500-34-6</b> | E1, E2, E3, E4        | 3/4                  | 1.54                    | 1.75 | 0.22 | 3.90 | Brown              | P87                    | 20                    | 87                 | 1 13/16                 | 6              |
| <b>LCA500-78-6</b> |                       | 7/8                  | 1.54                    | 1.75 | 0.22 | 4.15 | Brown              | P87                    | 20                    | 87                 | 1 13/16                 | 6              |
| <b>LCA500-1-6</b>  |                       | 1                    | 1.54                    | 1.75 | 0.22 | 4.27 | Brown              | P87                    | 20                    | 87                 | 1 13/16                 | 6              |
| <b>LCA600-12-6</b> | E1, E2, E3, E4        | 1/2                  | 1.70                    | 1.75 | 0.26 | 4.20 | Green              | P94                    | 22                    | 94                 | 1 13/16                 | 6              |
| <b>LCA600-58-6</b> |                       | 5/8                  | 1.70                    | 1.75 | 0.26 | 4.20 | Green              | P94                    | 22                    | 94                 | 1 13/16                 | 6              |
| <b>LCA600-78-6</b> |                       | 7/8                  | 1.70                    | 1.75 | 0.26 | 4.20 | Green              | P94                    | 22                    | 94                 | 1 13/16                 | 6              |
| <b>LCA750-58-6</b> | E1, E2, E3, E4        | 5/8                  | 1.89                    | 1.88 | 0.26 | 4.59 | Black              | P106                   | 24                    | 106                | 1 15/16                 | 6              |

‡See pages D3.58 – D3.61 for tool and die information.

\*Not tested to NEBS Level 3 requirements.

\*\*Consult cable manufacturer for voltage stress relief instructions with applications greater than 2000 V.



## Code Conductor, One-Hole, Standard Barrel with Window Lug, 45° Angle

For Use with Stranded Copper Conductors

### Type LCA-H

- Color-coded barrels marked with Panduit and specified competitor die index numbers for proper crimp die selection
- Inspection window to visually assure full conductor insertion
- Tin-plated to inhibit corrosion
- UL Listed and CSA Certified to 35 KV\*\* and temperature rated to 90°C when crimped with Panduit and specified competitor crimping tools and dies

- UL Listed and CSA Certified for wide wire range-taking capability when crimped with Panduit® Uni-Die™ Dieless Crimping Tools‡
- Tested by Telcordia – meets NEBS Level 3
- American Bureau of Shipping approved

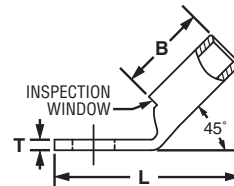
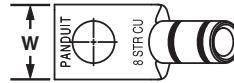

| Part Number  | Copper Conductor Size                | Stud Hole Size (In.) | Figure Dimensions (In.) |      |      |      | Panduit Color Code | Panduit Die Index No.‡ | Burndy Die Index No.‡ | T&B Die Index No.‡ | Wire Strip Length (In.) | Std. Pkg. Qty. |
|--------------|--------------------------------------|----------------------|-------------------------|------|------|------|--------------------|------------------------|-----------------------|--------------------|-------------------------|----------------|
|              |                                      |                      | W                       | B    | T    | L    |                    |                        |                       |                    |                         |                |
| LCA10-14H-L* | #14 – #10 AWG STR, #12 – #10 AWG SOL | 1/4                  | 0.42                    | 0.38 | 0.05 | 1.05 | —                  | —                      | —                     | —                  | 7/16                    | 50             |
| LCA8-10H-L   | #8 AWG                               | #10                  | 0.41                    | 0.56 | 0.08 | 1.10 | Red                | P21                    | 49                    | 21                 | 5/8                     | 50             |
| LCA8-14H-L   |                                      | 1/4                  | 0.48                    | 0.56 | 0.07 | 1.19 | Red                | P21                    | 49                    | 21                 | 5/8                     | 50             |
| LCA8-56H-L   |                                      | 5/16                 | 0.56                    | 0.56 | 0.05 | 1.30 | Red                | P21                    | 49                    | 21                 | 5/8                     | 50             |
| LCA8-38H-L   |                                      | 3/8                  | 0.60                    | 0.56 | 0.05 | 1.40 | Red                | P21                    | 49                    | 21                 | 5/8                     | 50             |
| LCA6-10H-L   | #6 AWG                               | #10                  | 0.45                    | 0.81 | 0.09 | 1.29 | Blue               | P24                    | 7                     | 24                 | 7/8                     | 50             |
| LCA6-14H-L   |                                      | 1/4                  | 0.48                    | 0.81 | 0.08 | 1.38 | Blue               | P24                    | 7                     | 24                 | 7/8                     | 50             |
| LCA6-56H-L   |                                      | 5/16                 | 0.56                    | 0.81 | 0.07 | 1.49 | Blue               | P24                    | 7                     | 24                 | 7/8                     | 50             |
| LCA6-38H-L   |                                      | 3/8                  | 0.62                    | 0.81 | 0.06 | 1.59 | Blue               | P24                    | 7                     | 24                 | 7/8                     | 50             |
| LCA4-10H-L   | #4 – #3 AWG STR, #2 AWG SOL          | #10                  | 0.55                    | 0.81 | 0.09 | 1.31 | Gray               | P29                    | 8                     | 29                 | 7/8                     | 50             |
| LCA4-14H-L   |                                      | 1/4                  | 0.55                    | 0.81 | 0.09 | 1.40 | Gray               | P29                    | 8                     | 29                 | 7/8                     | 50             |
| LCA4-56H-L   |                                      | 5/16                 | 0.55                    | 0.81 | 0.09 | 1.52 | Gray               | P29                    | 8                     | 29                 | 7/8                     | 50             |
| LCA4-38H-L   |                                      | 3/8                  | 0.62                    | 0.81 | 0.07 | 1.61 | Gray               | P29                    | 8                     | 29                 | 7/8                     | 50             |
| LCA2-14H-Q   | #2 AWG                               | 1/4                  | 0.60                    | 0.88 | 0.10 | 1.49 | Brown              | P33                    | 10                    | 33                 | 15/16                   | 25             |
| LCA2-56H-Q   |                                      | 5/16                 | 0.66                    | 0.88 | 0.10 | 1.61 | Brown              | P33                    | 10                    | 33                 | 15/16                   | 25             |
| LCA2-38H-Q   |                                      | 3/8                  | 0.66                    | 0.88 | 0.10 | 1.68 | Brown              | P33                    | 10                    | 33                 | 15/16                   | 25             |
| LCA2-12H-Q   |                                      | 1/2                  | 0.75                    | 0.88 | 0.08 | 1.90 | Brown              | P33                    | 10                    | 33                 | 15/16                   | 25             |

‡See pages D3.58 – D3.61 for tool and die information.

\*Not tested to NEBS Level 3 requirements.

\*\*Consult cable manufacturer for voltage stress relief instructions with applications greater than 2000 V.

Table continues on page D2.16

A. System Overview

B1. Cable Ties

B2. Cable Accessories

B3. Stainless Steel Ties

C1. Wiring Duct

C2. Surface Raceway

C3. Abrasion Protection

C4. Cable Management

D1. Terminals

D2. Power Connectors

D3. Grounding Connectors

E1. Labeling Systems

E2. Labels

E3. Pre-Printed & Write-On Markers

E4. Permanent Identification

E5. Lockout/Tagout & Safety Solutions

F. Index

A. System Overview



## Code Conductor, One-Hole, Standard Barrel with Window Lug, 45° Angle (continued)

B1. Cable Ties

B2. Cable Accessories

B3. Stainless Steel Ties

C1. Wiring Duct

C2. Surface Raceway

C3. Abrasion Protection

C4. Cable Management

D1. Terminals

D2. Power Connectors

D3. Grounding Connectors

E1. Labeling Systems

E2. Labels

E3. Pre-Printed & Write-On Markers

E4. Permanent Identification

E5. Lockout/Tagout & Safety Solutions

F. Index

| Part Number         | Copper Conductor Size | Stud Hole Size (In.) | Figure Dimensions (In.) |      |      |      | Panduit Color Code | Panduit Die Index No.‡ | Burdny Die Index No.‡ | T&B Die Index No.‡ | Wire Strip Length (In.) | Std. Pkg. Qty. |
|---------------------|-----------------------|----------------------|-------------------------|------|------|------|--------------------|------------------------|-----------------------|--------------------|-------------------------|----------------|
|                     |                       |                      | W                       | B    | T    | L    |                    |                        |                       |                    |                         |                |
| LCA1-14H-E          | #1 AWG                | 1/4                  | 0.70                    | 0.88 | 0.11 | 1.50 | Green              | P37                    | 11                    | 37                 | 15/16                   | 20             |
| LCA1-56H-E          |                       | 5/16                 | 0.70                    | 0.88 | 0.11 | 1.62 | Green              | P37                    | 11                    | 37                 | 15/16                   | 20             |
| LCA1-38H-E          |                       | 3/8                  | 0.70                    | 0.88 | 0.11 | 1.70 | Green              | P37                    | 11                    | 37                 | 15/16                   | 20             |
| LCA1-12H-E          |                       | 1/2                  | 0.75                    | 0.88 | 0.09 | 1.93 | Green              | P37                    | 11                    | 37                 | 15/16                   | 20             |
| LCA1/0-14H-X        | 1/0 AWG               | 1/4                  | 0.76                    | 0.94 | 0.12 | 1.63 | Pink               | P42                    | 12                    | 42                 | 1                       | 10             |
| LCA1/0-56H-X        |                       | 5/16                 | 0.76                    | 0.94 | 0.12 | 1.69 | Pink               | P42                    | 12                    | 42                 | 1                       | 10             |
| LCA1/0-38H-X        |                       | 3/8                  | 0.76                    | 0.94 | 0.12 | 1.76 | Pink               | P42                    | 12                    | 42                 | 1                       | 10             |
| LCA1/0-12H-X        |                       | 1/2                  | 0.80                    | 0.94 | 0.12 | 1.99 | Pink               | P42                    | 12                    | 42                 | 1                       | 10             |
| LCA2/0-14H-X        | 2/0 AWG               | 1/4                  | 0.85                    | 0.98 | 0.13 | 1.77 | Black              | P45                    | 13                    | 45                 | 1 1/16                  | 10             |
| LCA2/0-56H-X        |                       | 5/16                 | 0.85                    | 0.98 | 0.13 | 1.77 | Black              | P45                    | 13                    | 45                 | 1 1/16                  | 10             |
| LCA2/0-38H-X        |                       | 3/8                  | 0.85                    | 0.98 | 0.13 | 1.83 | Black              | P45                    | 13                    | 45                 | 1 1/16                  | 10             |
| LCA2/0-12H-X        |                       | 1/2                  | 0.85                    | 0.98 | 0.13 | 2.08 | Black              | P45                    | 13                    | 45                 | 1 1/16                  | 10             |
| LCA2/0-34H-X        | 3/0 AWG               | 3/4                  | 1.06                    | 0.98 | 0.09 | 2.66 | Black              | P45                    | 13                    | 45                 | 1 1/16                  | 10             |
| LCA3/0-14H-X        |                       | 1/4                  | 0.96                    | 1.14 | 0.13 | 1.90 | Orange             | P50                    | 14                    | 50                 | 1 3/16                  | 10             |
| LCA3/0-56H-X        |                       | 5/16                 | 0.96                    | 1.14 | 0.13 | 1.90 | Orange             | P50                    | 14                    | 50                 | 1 3/16                  | 10             |
| <b>LCA3/0-38H-X</b> |                       | 3/8                  | 0.96                    | 1.14 | 0.13 | 1.96 | Orange             | P50                    | 14                    | 50                 | 1 3/16                  | 10             |
| LCA3/0-12H-X        | 4/0 AWG               | 1/2                  | 0.96                    | 1.14 | 0.13 | 2.21 | Orange             | P50                    | 14                    | 50                 | 1 3/16                  | 10             |
| LCA4/0-14H-X        |                       | 1/4                  | 1.06                    | 1.19 | 0.14 | 1.97 | Purple             | P54                    | 15                    | 54                 | 1 1/4                   | 10             |
| LCA4/0-56H-X        |                       | 5/16                 | 1.06                    | 1.19 | 0.14 | 1.98 | Purple             | P54                    | 15                    | 54                 | 1 1/4                   | 10             |
| LCA4/0-38H-X        |                       | 3/8                  | 1.06                    | 1.19 | 0.14 | 2.05 | Purple             | P54                    | 15                    | 54                 | 1 1/4                   | 10             |
| LCA4/0-12H-X        | 250 kcmil             | 1/2                  | 1.06                    | 1.19 | 0.14 | 2.28 | Purple             | P54                    | 15                    | 54                 | 1 1/4                   | 10             |
| LCA250-14H-X        |                       | 1/4                  | 1.17                    | 1.25 | 0.14 | 2.05 | Yellow             | P62                    | 16                    | 62                 | 1 5/16                  | 10             |
| LCA250-56H-X        |                       | 5/16                 | 1.17                    | 1.25 | 0.14 | 2.06 | Yellow             | P62                    | 16                    | 62                 | 1 5/16                  | 10             |
| <b>LCA250-38H-X</b> |                       | 3/8                  | 1.17                    | 1.25 | 0.14 | 2.13 | Yellow             | P62                    | 16                    | 62                 | 1 5/16                  | 10             |
| LCA250-12H-X        | 300 kcmil             | 1/2                  | 1.17                    | 1.25 | 0.14 | 2.36 | Yellow             | P62                    | 16                    | 62                 | 1 5/16                  | 10             |
| LCA300-56H-X        |                       | 5/16                 | 1.19                    | 1.44 | 0.16 | 2.55 | White              | P66                    | 17                    | 66                 | 1 1/2                   | 10             |
| LCA300-38H-X        |                       | 3/8                  | 1.19                    | 1.44 | 0.16 | 2.55 | White              | P66                    | 17                    | 66                 | 1 1/2                   | 10             |
| LCA300-12H-X        |                       | 1/2                  | 1.19                    | 1.44 | 0.16 | 2.66 | White              | P66                    | 17                    | 66                 | 1 1/2                   | 10             |
| LCA300-58H-X        | 350 kcmil             | 5/8                  | 1.19                    | 1.44 | 0.16 | 2.87 | White              | P66                    | 17                    | 66                 | 1 1/2                   | 10             |
| LCA300-78H-X        |                       | 7/8                  | 1.19                    | 1.44 | 0.16 | 3.31 | White              | P66                    | 17                    | 66                 | 1 1/2                   | 10             |
| LCA350-38H-X        |                       | 3/8                  | 1.28                    | 1.44 | 0.17 | 2.59 | Red                | P71                    | 18                    | 71                 | 1 1/2                   | 10             |
| LCA350-12H-X        |                       | 1/2                  | 1.28                    | 1.44 | 0.17 | 2.70 | Red                | P71                    | 18                    | 71                 | 1 1/2                   | 10             |
| LCA350-58H-X        | 400 kcmil             | 5/8                  | 1.28                    | 1.44 | 0.17 | 2.91 | Red                | P71                    | 18                    | 71                 | 1 1/2                   | 10             |
| LCA350-78H-X        |                       | 7/8                  | 1.28                    | 1.44 | 0.17 | 3.35 | Red                | P71                    | 18                    | 71                 | 1 1/2                   | 10             |
| LCA400-38H-6        |                       | 3/8                  | 1.39                    | 1.50 | 0.18 | 2.85 | Blue               | P76                    | 19                    | 76                 | 1 9/16                  | 6              |
| LCA400-12H-6        |                       | 1/2                  | 1.39                    | 1.50 | 0.18 | 2.85 | Blue               | P76                    | 19                    | 76                 | 1 9/16                  | 6              |
| LCA400-58H-6        | 500 kcmil             | 5/8                  | 1.39                    | 1.50 | 0.18 | 3.06 | Blue               | P76                    | 19                    | 76                 | 1 9/16                  | 6              |
| LCA400-78H-6        |                       | 7/8                  | 1.39                    | 1.50 | 0.18 | 3.45 | Blue               | P76                    | 19                    | 76                 | 1 9/16                  | 6              |
| LCA500-38H-6        |                       | 3/8                  | 1.54                    | 1.75 | 0.22 | 2.94 | Brown              | P87                    | 20                    | 87                 | 1 13/16                 | 6              |
| LCA500-12H-6        |                       | 1/2                  | 1.54                    | 1.75 | 0.22 | 3.10 | Brown              | P87                    | 20                    | 87                 | 1 13/16                 | 6              |
| LCA500-58H-6        | 600 kcmil             | 5/8                  | 1.54                    | 1.75 | 0.22 | 3.31 | Brown              | P87                    | 20                    | 87                 | 1 13/16                 | 6              |
| LCA500-34H-6        |                       | 3/4                  | 1.54                    | 1.75 | 0.22 | 3.45 | Brown              | P87                    | 20                    | 87                 | 1 13/16                 | 6              |
| LCA500-78H-6        |                       | 7/8                  | 1.54                    | 1.75 | 0.22 | 3.70 | Brown              | P87                    | 20                    | 87                 | 1 13/16                 | 6              |
| LCA500-1H-6         |                       | 1                    | 1.54                    | 1.75 | 0.22 | 3.82 | Brown              | P87                    | 20                    | 87                 | 1 13/16                 | 6              |
| LCA600-12H-6        | 600 kcmil             | 1/2                  | 1.70                    | 1.75 | 0.26 | 3.76 | Green              | P94                    | 22                    | 94                 | 1 13/16                 | 6              |
| LCA600-58H-6        |                       | 5/8                  | 1.70                    | 1.75 | 0.26 | 3.76 | Green              | P94                    | 22                    | 94                 | 1 13/16                 | 6              |
| LCA600-78H-6        |                       | 7/8                  | 1.70                    | 1.75 | 0.26 | 3.76 | Green              | P94                    | 22                    | 94                 | 1 13/16                 | 6              |

‡See pages D3.58 – D3.61 for tool and die information.

\*Not tested to NEBS Level 3 requirements.

\*\*Consult cable manufacturer for voltage stress relief instructions with applications greater than 2000 V.



## Code Conductor, One-Hole, Standard Barrel with Window Lug, 90° Angle

For Use with Stranded Copper Conductors

### Type LCA-F

- Color-coded barrels marked with Panduit and specified competitor die index numbers for proper crimp die selection
- Inspection window to visually assure full conductor insertion
- Tin-plated to inhibit corrosion
- UL Listed and CSA Certified to 35 KV\*\* and temperature rated to 90°C when crimped with Panduit and specified competitor crimping tools and dies

- UL Listed and CSA Certified for wide wire range-taking capability when crimped with Panduit® Uni-Die™ Dieless Crimping Tools‡
- Tested by Telcordia – meets NEBS Level 3
- American Bureau of Shipping Approved

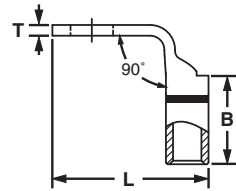
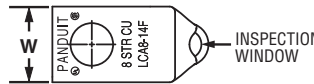

| Part Number  | Copper Conductor Size                | Stud Hole Size (In.) | Figure Dimensions (In.) |      |      |       | Panduit Color Code | Panduit Die Index No.‡ | Burdny Die Index No.‡ | T&B Die Index No.‡ | Wire Strip Length (In.) | Std. Pkg. Qty. |
|--------------|--------------------------------------|----------------------|-------------------------|------|------|-------|--------------------|------------------------|-----------------------|--------------------|-------------------------|----------------|
|              |                                      |                      | W                       | B    | T    | L     |                    |                        |                       |                    |                         |                |
| LCA10-14F-L* | #14 – #10 AWG STR, #12 – #10 AWG SOL | 1/4                  | 0.42                    | 0.38 | 0.05 | 0.94  | —                  | —                      | —                     | —                  | 7/16                    | 50             |
| LCA8-10F-L   | #8 AWG                               | #10                  | 0.41                    | 0.56 | 0.08 | 0.90  | Red                | P21                    | 49                    | 21                 | 5/8                     | 50             |
| LCA8-14F-L   |                                      | 1/4                  | 0.48                    | 0.56 | 0.07 | 0.99  | Red                | P21                    | 49                    | 21                 | 5/8                     | 50             |
| LCA8-56F-L   |                                      | 5/16                 | 0.56                    | 0.56 | 0.05 | 1.11  | Red                | P21                    | 49                    | 21                 | 5/8                     | 50             |
| LCA8-38F-L   |                                      | 3/8                  | 0.60                    | 0.56 | 0.05 | 1.21  | Red                | P21                    | 49                    | 21                 | 5/8                     | 50             |
| LCA6-10F-L   | #6 AWG                               | #10                  | 0.45                    | 0.81 | 0.09 | 0.94  | Blue               | P24                    | 7                     | 24                 | 7/8                     | 50             |
| LCA6-14F-L   |                                      | 1/4                  | 0.48                    | 0.81 | 0.08 | 1.03  | Blue               | P24                    | 7                     | 24                 | 7/8                     | 50             |
| LCA6-56F-L   |                                      | 5/16                 | 0.56                    | 0.81 | 0.07 | 1.15  | Blue               | P24                    | 7                     | 24                 | 7/8                     | 50             |
| LCA6-38F-L   |                                      | 3/8                  | 0.62                    | 0.81 | 0.06 | 1.25  | Blue               | P24                    | 7                     | 24                 | 7/8                     | 50             |
| LCA4-10F-L   | #4 – #3 AWG STR, #2 AWG SOL          | #10                  | 0.55                    | 0.81 | 0.09 | 1.03  | Gray               | P29                    | 8                     | 29                 | 7/8                     | 50             |
| LCA4-14F-L   |                                      | 1/4                  | 0.55                    | 0.81 | 0.09 | 1.12  | Gray               | P29                    | 8                     | 29                 | 7/8                     | 50             |
| LCA4-56F-L   |                                      | 5/16                 | 0.55                    | 0.81 | 0.09 | 1.24  | Gray               | P29                    | 8                     | 29                 | 7/8                     | 50             |
| LCA4-38F-L   |                                      | 3/8                  | 0.62                    | 0.81 | 0.07 | 1.34  | Gray               | P29                    | 8                     | 29                 | 7/8                     | 50             |
| LCA4-12F-L   | #2 AWG                               | 1/2                  | 0.75                    | 0.81 | 0.07 | 1.59  | Gray               | P29                    | 8                     | 29                 | 7/8                     | 50             |
| LCA2-14F-Q   |                                      | 1/4                  | 0.60                    | 0.88 | 0.10 | 1.24  | Brown              | P33                    | 10                    | 33                 | 15/16                   | 25             |
| LCA2-56F-Q   |                                      | 5/16                 | 0.66                    | 0.88 | 0.10 | 1.36  | Brown              | P33                    | 10                    | 33                 | 15/16                   | 25             |
| LCA2-38F-Q   |                                      | 3/8                  | 0.66                    | 0.88 | 0.10 | 1.44  | Brown              | P33                    | 10                    | 33                 | 15/16                   | 25             |
| LCA2-12F-Q   | 1/2                                  | 0.75                 | 0.88                    | 0.08 | 1.67 | Brown | P33                | 10                     | 33                    | 15/16              | 25                      |                |

‡See pages D3.58 – D3.61 for tool and die information.

\*Not tested to NEBS Level 3 requirements.

\*\*Consult cable manufacturer for voltage stress relief instructions with applications greater than 2000 V.

Table continues on page D2.18

A. System Overview

B1. Cable Ties

B2. Cable Accessories

B3. Stainless Steel Ties

C1. Wiring Duct

C2. Surface Raceway

C3. Abrasion Protection

C4. Cable Management

D1. Terminals

D2. Power Connectors

D3. Grounding Connectors

E1. Labeling Systems

E2. Labels

E3. Pre-Printed & Write-On Markers

E4. Permanent Identification

E5. Lockout/Tagout & Safety Solutions

F. Index



## Code Conductor, One-Hole, Standard Barrel with Window Lug, 90° Angle (continued)

| Part Number         | Copper Conductor Size | Stud Hole Size (In.) | Figure Dimensions (In.) |      |      |      | Panduit Color Code | Panduit Die Index No.‡ | Burdny Die Index No.‡ | T&B Die Index No.‡ | Wire Strip Length (In.) | Std. Pkg. Qty. |
|---------------------|-----------------------|----------------------|-------------------------|------|------|------|--------------------|------------------------|-----------------------|--------------------|-------------------------|----------------|
|                     |                       |                      | W                       | B    | T    | L    |                    |                        |                       |                    |                         |                |
| LCA1-14F-E          | #1 AWG                | 1/4                  | 0.70                    | 0.88 | 0.11 | 1.31 | Green              | P37                    | 11                    | 37                 | 15/16                   | 20             |
| LCA1-56F-E          |                       | 5/16                 | 0.70                    | 0.88 | 0.11 | 1.44 | Green              | P37                    | 11                    | 37                 | 15/16                   | 20             |
| <b>LCA1-38F-E</b>   |                       | 3/8                  | 0.70                    | 0.88 | 0.11 | 1.51 | Green              | P37                    | 11                    | 37                 | 15/16                   | 20             |
| <b>LCA1-12F-E</b>   |                       | 1/2                  | 0.75                    | 0.88 | 0.09 | 1.75 | Green              | P37                    | 11                    | 37                 | 15/16                   | 20             |
| LCA1/0-14F-X        | 1/0 AWG               | 1/4                  | 0.76                    | 0.94 | 0.12 | 1.45 | Pink               | P42                    | 12                    | 42                 | 1                       | 10             |
| LCA1/0-56F-X        |                       | 5/16                 | 0.76                    | 0.94 | 0.12 | 1.51 | Pink               | P42                    | 12                    | 42                 | 1                       | 10             |
| LCA1/0-38F-X        |                       | 3/8                  | 0.76                    | 0.94 | 0.12 | 1.58 | Pink               | P42                    | 12                    | 42                 | 1                       | 10             |
| LCA1/0-12F-X        |                       | 1/2                  | 0.80                    | 0.94 | 0.12 | 1.82 | Pink               | P42                    | 12                    | 42                 | 1                       | 10             |
| LCA2/0-14F-X        | 2/0 AWG               | 1/4                  | 0.85                    | 0.98 | 0.13 | 1.61 | Black              | P45                    | 13                    | 45                 | 1 1/16                  | 10             |
| LCA2/0-56F-X        |                       | 5/16                 | 0.85                    | 0.98 | 0.13 | 1.59 | Black              | P45                    | 13                    | 45                 | 1 1/16                  | 10             |
| LCA2/0-38F-X        |                       | 3/8                  | 0.85                    | 0.98 | 0.13 | 1.66 | Black              | P45                    | 13                    | 45                 | 1 1/16                  | 10             |
| LCA2/0-12F-X        |                       | 1/2                  | 0.85                    | 0.98 | 0.13 | 1.91 | Black              | P45                    | 13                    | 45                 | 1 1/16                  | 10             |
| LCA3/0-14F-X        | 3/0 AWG               | 1/4                  | 0.96                    | 1.14 | 0.13 | 1.67 | Orange             | P50                    | 14                    | 50                 | 1 3/16                  | 10             |
| LCA3/0-56F-X        |                       | 5/16                 | 0.96                    | 1.14 | 0.13 | 1.67 | Orange             | P50                    | 14                    | 50                 | 1 3/16                  | 10             |
| LCA3/0-38F-X        |                       | 3/8                  | 0.96                    | 1.14 | 0.13 | 1.73 | Orange             | P50                    | 14                    | 50                 | 1 3/16                  | 10             |
| LCA3/0-12F-X        |                       | 1/2                  | 0.96                    | 1.14 | 0.13 | 1.98 | Orange             | P50                    | 14                    | 50                 | 1 3/16                  | 10             |
| LCA4/0-14F-X        | 4/0 AWG               | 1/4                  | 1.06                    | 1.19 | 0.14 | 1.75 | Purple             | P54                    | 15                    | 54                 | 1 1/4                   | 10             |
| LCA4/0-56F-X        |                       | 5/16                 | 1.06                    | 1.19 | 0.14 | 1.77 | Purple             | P54                    | 15                    | 54                 | 1 1/4                   | 10             |
| LCA4/0-38F-X        |                       | 3/8                  | 1.06                    | 1.19 | 0.14 | 1.84 | Purple             | P54                    | 15                    | 54                 | 1 1/4                   | 10             |
| LCA4/0-12F-X        |                       | 1/2                  | 1.06                    | 1.19 | 0.14 | 2.07 | Purple             | P54                    | 15                    | 54                 | 1 1/4                   | 10             |
| LCA250-14F-X        | 250 kcmil             | 1/4                  | 1.17                    | 1.25 | 0.14 | 1.82 | Yellow             | P62                    | 16                    | 62                 | 1 5/16                  | 10             |
| <b>LCA250-56F-X</b> |                       | 5/16                 | 1.17                    | 1.25 | 0.14 | 1.83 | Yellow             | P62                    | 16                    | 62                 | 1 5/16                  | 10             |
| LCA250-38F-X        |                       | 3/8                  | 1.17                    | 1.25 | 0.14 | 1.90 | Yellow             | P62                    | 16                    | 62                 | 1 5/16                  | 10             |
| LCA250-12F-X        |                       | 1/2                  | 1.17                    | 1.25 | 0.14 | 2.13 | Yellow             | P62                    | 16                    | 62                 | 1 5/16                  | 10             |
| LCA300-56F-X        | 300 kcmil             | 5/16                 | 1.19                    | 1.44 | 0.16 | 2.07 | White              | P66                    | 17                    | 66                 | 1 1/2                   | 10             |
| LCA300-38F-X        |                       | 3/8                  | 1.19                    | 1.44 | 0.16 | 2.07 | White              | P66                    | 17                    | 66                 | 1 1/2                   | 10             |
| LCA300-12F-X        |                       | 1/2                  | 1.19                    | 1.44 | 0.16 | 2.18 | White              | P66                    | 17                    | 66                 | 1 1/2                   | 10             |
| LCA300-58F-X        |                       | 5/8                  | 1.19                    | 1.44 | 0.16 | 2.39 | White              | P66                    | 17                    | 66                 | 1 1/2                   | 10             |
| LCA300-78F-X        | 350 kcmil             | 7/8                  | 1.19                    | 1.44 | 0.16 | 2.83 | White              | P66                    | 17                    | 66                 | 1 1/2                   | 10             |
| LCA350-38F-X        |                       | 3/8                  | 1.28                    | 1.44 | 0.17 | 2.13 | Red                | P71                    | 18                    | 71                 | 1 1/2                   | 10             |
| LCA350-12F-X        |                       | 1/2                  | 1.28                    | 1.44 | 0.17 | 2.24 | Red                | P71                    | 18                    | 71                 | 1 1/2                   | 10             |
| LCA350-58F-X        |                       | 5/8                  | 1.28                    | 1.44 | 0.17 | 2.45 | Red                | P71                    | 18                    | 71                 | 1 1/2                   | 10             |
| LCA350-78F-X        | 400 kcmil             | 7/8                  | 1.28                    | 1.44 | 0.17 | 2.89 | Red                | P71                    | 18                    | 71                 | 1 1/2                   | 10             |
| LCA400-38F-6        |                       | 3/8                  | 1.39                    | 1.50 | 0.18 | 2.37 | Blue               | P76                    | 19                    | 76                 | 1 9/16                  | 6              |
| LCA400-12F-6        |                       | 1/2                  | 1.39                    | 1.50 | 0.18 | 2.37 | Blue               | P76                    | 19                    | 76                 | 1 9/16                  | 6              |
| LCA400-58F-6        |                       | 5/8                  | 1.39                    | 1.50 | 0.18 | 2.58 | Blue               | P76                    | 19                    | 76                 | 1 9/16                  | 6              |
| LCA400-78F-6        | 500 kcmil             | 7/8                  | 1.39                    | 1.50 | 0.18 | 2.97 | Blue               | P76                    | 19                    | 76                 | 1 9/16                  | 6              |
| LCA500-38F-6        |                       | 3/8                  | 1.54                    | 1.75 | 0.22 | 2.32 | Brown              | P87                    | 20                    | 87                 | 1 13/16                 | 6              |
| LCA500-12F-6        |                       | 1/2                  | 1.54                    | 1.75 | 0.22 | 2.48 | Brown              | P87                    | 20                    | 87                 | 1 13/16                 | 6              |
| LCA500-58F-6        |                       | 5/8                  | 1.54                    | 1.75 | 0.22 | 2.69 | Brown              | P87                    | 20                    | 87                 | 1 13/16                 | 6              |
| LCA500-34F-6        | 600 kcmil             | 3/4                  | 1.54                    | 1.75 | 0.22 | 2.83 | Brown              | P87                    | 20                    | 87                 | 1 13/16                 | 6              |
| LCA500-78F-6        |                       | 7/8                  | 1.54                    | 1.75 | 0.22 | 3.08 | Brown              | P87                    | 20                    | 87                 | 1 13/16                 | 6              |
| LCA500-1F-6         |                       | 1                    | 1.54                    | 1.75 | 0.22 | 3.20 | Brown              | P87                    | 20                    | 87                 | 1 13/16                 | 6              |
| LCA600-12F-6        |                       | 1/2                  | 1.70                    | 1.75 | 0.26 | 3.21 | Green              | P94                    | 22                    | 94                 | 1 13/16                 | 6              |
| LCA600-58F-6        | 600 kcmil             | 5/8                  | 1.70                    | 1.75 | 0.26 | 3.21 | Green              | P94                    | 22                    | 94                 | 1 13/16                 | 6              |
| LCA600-78F-6        |                       | 7/8                  | 1.70                    | 1.75 | 0.26 | 3.21 | Green              | P94                    | 22                    | 94                 | 1 13/16                 | 6              |

‡See pages D3.58 – D3.61 for tool and die information.

\*Not tested to NEBS Level 3 requirements.

\*\*Consult cable manufacturer for voltage stress relief instructions with applications greater than 2000 V.





## Code Conductor, One-Hole, Standard Barrel with Window, Narrow Tongue Lug

For Use with Stranded Copper Conductors

### Type L CAN

- Narrow tongue width for limited space applications
- Color-coded barrels marked with Panduit and specified competitor die index numbers for proper crimp die selection
- Inspection window to visually assure full conductor insertion
- Tin-plated to inhibit corrosion

- UL Listed and CSA Certified to 35 KV\*\* and temperature rated to 90°C when crimped with Panduit and specified competitor crimping tools and dies
- UL Listed and CSA Certified for wide wire range-taking capability when crimped with Panduit® Uni-Die™ Dieless Crimping Tools‡



| Part Number  | Copper Conductor Size       | Stud Hole Size (In.) | Figure Dimensions (In.) |      |      |      | Panduit Color Code | Panduit Die Index No.‡ | Burdny Die Index No.‡ | T&B Die Index No.‡ | Wire Strip Length (In.) | Std. Pkg. Qty. |
|--------------|-----------------------------|----------------------|-------------------------|------|------|------|--------------------|------------------------|-----------------------|--------------------|-------------------------|----------------|
|              |                             |                      | W                       | B    | T    | L    |                    |                        |                       |                    |                         |                |
| LCAN8-6-L    | #8 AWG                      | #6                   | 0.27                    | 0.56 | 0.10 | 1.24 | Red                | P21                    | 49                    | 21                 | 5/8                     | 50             |
| LCAN6-6-L    | #6 AWG                      | #6                   | 0.31                    | 0.81 | 0.10 | 1.51 | Blue               | P24                    | 7                     | 24                 | 7/8                     | 50             |
| LCAN4-10-L   | #4 – #3 AWG STR, #2 AWG SOL | #10                  | 0.40                    | 0.81 | 0.11 | 1.54 | Gray               | P29                    | 8                     | 29                 | 7/8                     | 50             |
| LCAN4-14-L   |                             | 1/4                  | 0.40                    | 0.81 | 0.11 | 1.63 | Gray               | P29                    | 8                     | 29                 | 7/8                     | 50             |
| LCAN2-10-Q   | #2 AWG                      | #10                  | 0.42                    | 0.88 | 0.12 | 1.67 | Brown              | P33                    | 10                    | 33                 | 15/16                   | 25             |
| LCAN2-14-Q   |                             | 1/4                  | 0.42                    | 0.88 | 0.12 | 1.77 | Brown              | P33                    | 10                    | 33                 | 15/16                   | 25             |
| LCAN1-10-E   | #1 AWG                      | #10                  | 0.47                    | 0.88 | 0.11 | 1.69 | Green              | P37                    | 11                    | 37                 | 15/16                   | 20             |
| LCAN1-14-E   |                             | 1/4                  | 0.47                    | 0.88 | 0.12 | 1.79 | Green              | P37                    | 11                    | 37                 | 15/16                   | 20             |
| LCAN1/0-10-X | 1/0 AWG                     | #10                  | 0.52                    | 0.94 | 0.13 | 1.78 | Pink               | P42                    | 12                    | 42                 | 1                       | 10             |
| LCAN1/0-14-X |                             | 1/4                  | 0.52                    | 0.94 | 0.13 | 1.95 | Pink               | P42                    | 12                    | 42                 | 1                       | 10             |
| LCAN1/0-56-X |                             | 5/16                 | 0.52                    | 0.94 | 0.13 | 2.00 | Pink               | P42                    | 12                    | 42                 | 1                       | 10             |
| LCAN2/0-10-X | 2/0 AWG                     | #10                  | 0.58                    | 0.98 | 0.13 | 1.84 | Black              | P45                    | 13                    | 45                 | 1 1/16                  | 10             |
| LCAN2/0-14-X |                             | 1/4                  | 0.58                    | 0.98 | 0.14 | 2.09 | Black              | P45                    | 13                    | 45                 | 1 1/16                  | 10             |
| LCAN2/0-56-X |                             | 5/16                 | 0.58                    | 0.98 | 0.14 | 2.09 | Black              | P45                    | 13                    | 45                 | 1 1/16                  | 10             |
| LCAN2/0-38-X |                             | 3/8                  | 0.58                    | 0.98 | 0.13 | 2.15 | Black              | P45                    | 13                    | 45                 | 1 1/16                  | 10             |
| LCAN3/0-14-X | 3/0 AWG                     | 1/4                  | 0.64                    | 1.14 | 0.14 | 2.28 | Orange             | P50                    | 14                    | 50                 | 1 3/16                  | 10             |
| LCAN3/0-56-X |                             | 5/16                 | 0.64                    | 1.14 | 0.13 | 2.28 | Orange             | P50                    | 14                    | 50                 | 1 3/16                  | 10             |
| LCAN3/0-38-X |                             | 3/8                  | 0.64                    | 1.14 | 0.13 | 2.34 | Orange             | P50                    | 14                    | 50                 | 1 3/16                  | 10             |
| LCAN4/0-14-X | 4/0 AWG                     | 1/4                  | 0.71                    | 1.19 | 0.14 | 2.36 | Purple             | P54                    | 15                    | 54                 | 1 1/4                   | 10             |
| LCAN4/0-56-X |                             | 5/16                 | 0.71                    | 1.19 | 0.14 | 2.38 | Purple             | P54                    | 15                    | 54                 | 1 1/4                   | 10             |
| LCAN4/0-38-X |                             | 3/8                  | 0.71                    | 1.19 | 0.15 | 2.45 | Purple             | P54                    | 15                    | 54                 | 1 1/4                   | 10             |

‡See pages D3.58 – D3.61 for tool and die information.

\*\*Consult cable manufacturer for voltage stress relief instructions with applications greater than 2000 V.

Table continues on page D2.20

A. System Overview

B1. Cable Ties

B2. Cable Accessories

B3. Stainless Steel Ties

C1. Wiring Duct

C2. Surface Raceway

C3. Abrasion Protection

C4. Cable Management

D1. Terminals

D2. Power Connectors

D3. Grounding Connectors

E1. Labeling Systems

E2. Labels

E3. Pre-Printed & Write-On Markers

E4. Permanent Identification

E5. Lockout/Tagout & Safety Solutions

F. Index

A.  
System  
Overview



## Code Conductor, One-Hole, Standard Barrel with Window, Narrow Tongue Lug (continued)

B1.  
Cable Ties

B2.  
Cable  
Accessories

B3.  
Stainless  
Steel Ties

C1.  
Wiring  
Duct

C2.  
Surface  
Raceway

C3.  
Abrasion  
Protection

C4.  
Cable  
Management

D1.  
Terminals

D2.  
Power  
Connectors

D3.  
Grounding  
Connectors

E1.  
Labeling  
Systems

E2.  
Labels

E3.  
Pre-Printed  
& Write-On  
Markers

E4.  
Permanent  
Identification

E5.  
Lockout/  
Tagout  
& Safety  
Solutions

F.  
Index

| Part Number         | Copper Conductor Size | Stud Hole Size (In.) | Figure Dimensions (In.) |      |      |      | Panduit Color Code | Panduit Die Index No.‡ | Burndy Die Index No.‡ | T&B Die Index No.‡ | Wire Strip Length (In.) | Std. Pkg. Qty. |
|---------------------|-----------------------|----------------------|-------------------------|------|------|------|--------------------|------------------------|-----------------------|--------------------|-------------------------|----------------|
|                     |                       |                      | W                       | B    | T    | L    |                    |                        |                       |                    |                         |                |
| <b>LCAN250-14-X</b> | 250 kcmil             | 1/4                  | 0.77                    | 1.25 | 0.14 | 2.47 | Yellow             | P62                    | 16                    | 62                 | 1 5/16                  | 10             |
| <b>LCAN250-38-X</b> |                       | 3/8                  | 0.77                    | 1.25 | 0.15 | 2.55 | Yellow             | P62                    | 16                    | 62                 | 1 5/16                  | 10             |
| <b>LCAN300-14-X</b> | 300 kcmil             | 1/4                  | 0.81                    | 1.44 | 0.16 | 2.90 | White              | P66                    | 17                    | 66                 | 1 1/2                   | 10             |
| <b>LCAN300-38-X</b> |                       | 3/8                  | 0.81                    | 1.44 | 0.16 | 2.94 | White              | P66                    | 17                    | 66                 | 1 1/2                   | 10             |
| <b>LCAN350-38-X</b> | 350 kcmil             | 3/8                  | 0.88                    | 1.44 | 0.17 | 2.98 | Red                | P71                    | 18                    | 71                 | 1 1/2                   | 10             |
| <b>LCAN350-12-X</b> |                       | 1/2                  | 0.88                    | 1.44 | 0.17 | 3.09 | Red                | P71                    | 18                    | 71                 | 1 1/2                   | 10             |
| <b>LCAN400-38-6</b> | 400 kcmil             | 3/8                  | 0.95                    | 1.50 | 0.18 | 3.22 | Blue               | P76                    | 19                    | 76                 | 1 9/16                  | 6              |
| <b>LCAN400-12-6</b> |                       | 1/2                  | 0.95                    | 1.50 | 0.18 | 3.22 | Blue               | P76                    | 19                    | 76                 | 1 9/16                  | 6              |
| <b>LCAN500-38-6</b> | 500 kcmil             | 3/8                  | 1.06                    | 1.75 | 0.23 | 3.39 | Brown              | P87                    | 20                    | 87                 | 1 13/16                 | 6              |
| <b>LCAN500-12-6</b> |                       | 1/2                  | 1.06                    | 1.75 | 0.22 | 3.55 | Brown              | P87                    | 20                    | 87                 | 1 13/16                 | 6              |
| <b>LCAN600-38-6</b> | 600 kcmil             | 3/8                  | 1.19                    | 1.75 | 0.27 | 3.44 | Green              | P94                    | 22                    | 94                 | 1 13/16                 | 6              |
| <b>LCAN600-12-6</b> |                       | 1/2                  | 1.19                    | 1.75 | 0.27 | 4.20 | Green              | P94                    | 22                    | 94                 | 1 13/16                 | 6              |
| <b>LCAN750-38-6</b> | 750 kcmil             | 3/8                  | 1.30                    | 1.88 | 0.28 | 3.84 | Black              | P106                   | 24                    | 106                | 1 15/16                 | 6              |
| <b>LCAN750-12-6</b> |                       | 1/2                  | 1.30                    | 1.88 | 0.28 | 4.03 | Black              | P106                   | 24                    | 106                | 1 15/16                 | 6              |
| <b>LCAN750-58-6</b> |                       | 5/8                  | 1.30                    | 1.88 | 0.28 | 4.59 | Black              | P106                   | 24                    | 106                | 1 15/16                 | 6              |

‡See pages D3.58 – D3.61 for tool and die information.

\*\*Consult cable manufacturer for voltage stress relief instructions with applications greater than 2000 V.



## Code Conductor, Short Blank Tongue, Standard Barrel with Window Lug

For Use with Stranded Copper Conductors

### Type LCA-00

- Color-coded barrels marked with Panduit and specified competitor die index numbers for proper crimp die selection
- Inspection window to visually assure full conductor insertion
- Tin-plated to inhibit corrosion
- UL Recognized and CSA Certified to 35 KV\*\* and temperature rated to 90°C when crimped with Panduit and specified competitor crimping tools and dies



| Part Number | Copper Conductor Size       | Figure Dimensions (In.) |      |      |      | Panduit Color Code | Panduit Die Index No.‡ | Burdny Die Index No.‡ | T&B Die Index No.‡ | Wire Strip Length (In.) | Std. Pkg. Qty. |
|-------------|-----------------------------|-------------------------|------|------|------|--------------------|------------------------|-----------------------|--------------------|-------------------------|----------------|
|             |                             | W                       | B    | T    | L    |                    |                        |                       |                    |                         |                |
| LCA8-00-L   | #8 AWG                      | 0.60                    | 0.56 | 0.05 | 1.56 | Red                | P21                    | 49                    | 21                 | 5/8                     | 50             |
| LCA6-00-L   | #6 AWG                      | 0.62                    | 0.81 | 0.06 | 1.83 | Blue               | P24                    | 7                     | 24                 | 7/8                     | 50             |
| LCA4-00-L   | #4 - #3 AWG STR, #2 AWG SOL | 0.62                    | 0.81 | 0.07 | 1.85 | Gray               | P29                    | 8                     | 29                 | 7/8                     | 50             |
| LCA2-00-Q   | #2 AWG                      | 0.75                    | 0.88 | 0.08 | 2.21 | Brown              | P33                    | 10                    | 33                 | 15/16                   | 25             |
| LCA1-00-E   | #1 AWG                      | 0.75                    | 0.88 | 0.09 | 2.23 | Green              | P37                    | 11                    | 37                 | 15/16                   | 20             |
| LCA1/0-00-X | 1/0 AWG                     | 0.80                    | 0.94 | 0.12 | 2.31 | Pink               | P42                    | 12                    | 42                 | 1                       | 10             |
| LCA2/0-00-X | 2/0 AWG                     | 0.85                    | 0.98 | 0.13 | 2.40 | Black              | P45                    | 13                    | 45                 | 1 1/16                  | 10             |
| LCA3/0-00-X | 3/0 AWG                     | 0.96                    | 1.14 | 0.13 | 2.59 | Orange             | P50                    | 14                    | 50                 | 1 3/16                  | 10             |
| LCA4/0-00-X | 4/0 AWG                     | 1.06                    | 1.19 | 0.14 | 2.68 | Purple             | P54                    | 15                    | 54                 | 1 1/4                   | 10             |
| LCA300-00-X | 300 kcmil                   | 1.19                    | 1.44 | 0.16 | 3.70 | White              | P66                    | 17                    | 66                 | 1 1/2                   | 10             |
| LCA350-00-X | 350 kcmil                   | 1.28                    | 1.44 | 0.17 | 3.74 | Red                | P71                    | 18                    | 71                 | 1 1/2                   | 10             |
| LCA400-00-6 | 400 kcmil                   | 1.39                    | 1.50 | 0.18 | 3.82 | Blue               | P76                    | 19                    | 76                 | 1 9/16                  | 6              |
| LCA500-00-6 | 500 kcmil                   | 1.54                    | 1.75 | 0.22 | 4.27 | Brown              | P87                    | 20                    | 87                 | 1 13/16                 | 6              |
| LCA600-00-6 | 600 kcmil                   | 1.70                    | 1.75 | 0.26 | 4.20 | Green              | P94                    | 22                    | 94                 | 1 13/16                 | 6              |

‡See pages D3.58 – D3.61 for tool and die information.

\*\*Consult cable manufacturer for voltage stress relief instructions with applications greater than 2000 V.

- A. System Overview
- B1. Cable Ties
- B2. Cable Accessories
- B3. Stainless Steel Ties
- C1. Wiring Duct
- C2. Surface Raceway
- C3. Abrasion Protection
- C4. Cable Management
- D1. Terminals
- D2. Power Connectors
- D3. Grounding Connectors
- E1. Labeling Systems
- E2. Labels
- E3. Pre-Printed & Write-On Markers
- E4. Permanent Identification
- E5. Lockout/Tagout & Safety Solutions
- F. Index

A. System Overview



## Code Conductor, One-Hole, Long Barrel Lug

B1. Cable Ties

### For Use with Stranded Copper Conductors

B2. Cable Accessories

#### Type LCB

B3. Stainless Steel Ties

- Long barrel maximizes number of crimps and provides premium wire pull-out strength and electrical performance
- Color-coded barrels marked with Panduit and specified competitor die index numbers for proper crimp die selection
- Enclosed barrel prevents corrosive material from entering barrel when used in harsh environments
- Tin-plated to inhibit corrosion

- UL Listed and CSA Certified to 35 KV\*\* and temperature rated to 90°C when crimped with Panduit and specified competitor crimping tools and dies
- UL Listed and CSA Certified for wide wire range-taking capability when crimped with Panduit® Uni-Die™ Dieless Crimping Tools‡
- **Tested by Telcordia – meets NEBS Level 3**
- American Bureau of Shipping Approved

C1. Wiring Duct



C2. Surface Raceway

C3. Abrasion Protection

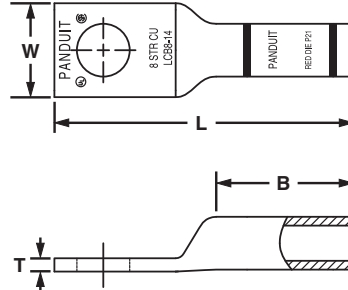

C4. Cable Management

| Part Number        | Copper Conductor Size       | Stud Hole Size (in.) | Figure Dimensions (in.) |      |      |      | Panduit Color Code | Panduit Die Index No.‡ | Burdndy Die Index No.‡ | T&B Die Index No.‡ | Wire Strip Length (in.) | Std. Pkg. Qty. |
|--------------------|-----------------------------|----------------------|-------------------------|------|------|------|--------------------|------------------------|------------------------|--------------------|-------------------------|----------------|
|                    |                             |                      | W                       | B    | T    | L    |                    |                        |                        |                    |                         |                |
| LCB8-10-L          | #8 AWG                      | #10                  | 0.41                    | 0.70 | 0.08 | 1.44 | Red                | P21                    | 49                     | 21                 | 3/4                     | 50             |
| LCB8-14-L          |                             | 1/4                  | 0.48                    | 0.70 | 0.07 | 1.53 | Red                | P21                    | 49                     | 21                 | 3/4                     | 50             |
| LCB8-38-L          |                             | 3/8                  | 0.60                    | 0.70 | 0.05 | 1.75 | Red                | P21                    | 49                     | 21                 | 3/4                     | 50             |
| LCB6-10-L          | #6 AWG                      | #10                  | 0.45                    | 1.07 | 0.09 | 1.84 | Blue               | P24                    | 7                      | 24                 | 1 1/8                   | 50             |
| <b>LCB6-14-L</b>   |                             | 1/4                  | 0.48                    | 1.07 | 0.08 | 1.93 | Blue               | P24                    | 7                      | 24                 | 1 1/8                   | 50             |
| LCB6-38-L          |                             | 3/8                  | 0.62                    | 1.07 | 0.05 | 2.15 | Blue               | P24                    | 7                      | 24                 | 1 1/8                   | 50             |
| LCB4-10-L          | #4 – #3 AWG STR, #2 AWG SOL | #10                  | 0.55                    | 1.05 | 0.09 | 1.86 | Gray               | P29                    | 8                      | 29                 | 1 1/8                   | 50             |
| <b>LCB4-14-L</b>   |                             | 1/4                  | 0.55                    | 1.05 | 0.09 | 1.95 | Gray               | P29                    | 8                      | 29                 | 1 1/8                   | 50             |
| LCB4-56-L          |                             | 5/16                 | 0.62                    | 1.05 | 0.07 | 2.13 | Gray               | P29                    | 8                      | 29                 | 1 1/8                   | 50             |
| LCB4-38-L          |                             | 3/8                  | 0.62                    | 1.05 | 0.07 | 2.17 | Gray               | P29                    | 8                      | 29                 | 1 1/8                   | 50             |
| LCB2-10-Q          | #2 AWG                      | #10                  | 0.60                    | 1.16 | 0.10 | 2.07 | Brown              | P33                    | 10                     | 33                 | 1 1/4                   | 25             |
| LCB2-14-Q          |                             | 1/4                  | 0.60                    | 1.16 | 0.10 | 2.14 | Brown              | P33                    | 10                     | 33                 | 1 1/4                   | 25             |
| <b>LCB2-56-Q</b>   |                             | 5/16                 | 0.66                    | 1.16 | 0.10 | 2.27 | Brown              | P33                    | 10                     | 33                 | 1 1/4                   | 25             |
| LCB2-38-Q          |                             | 3/8                  | 0.66                    | 1.16 | 0.10 | 2.34 | Brown              | P33                    | 10                     | 33                 | 1 1/4                   | 25             |
| LCB2-12-Q          |                             | 1/2                  | 0.75                    | 1.16 | 0.08 | 2.58 | Brown              | P33                    | 10                     | 33                 | 1 1/4                   | 25             |
| LCB1-10-E          | #1 AWG                      | #10                  | 0.70                    | 1.36 | 0.11 | 2.30 | Green              | P37                    | 11                     | 37                 | 1 7/16                  | 20             |
| LCB1-56-E          |                             | 5/16                 | 0.70                    | 1.36 | 0.11 | 2.50 | Green              | P37                    | 11                     | 37                 | 1 7/16                  | 20             |
| LCB1-38-E          |                             | 3/8                  | 0.70                    | 1.36 | 0.11 | 2.57 | Green              | P37                    | 11                     | 37                 | 1 7/16                  | 20             |
| LCB1-12-E          |                             | 1/2                  | 0.75                    | 1.36 | 0.09 | 2.81 | Green              | P37                    | 11                     | 37                 | 1 7/16                  | 20             |
| LCB1/0-10-X        | 1/0 AWG                     | #10                  | 0.76                    | 1.44 | 0.12 | 2.41 | Pink               | P42                    | 12                     | 42                 | 1 1/2                   | 10             |
| LCB1/0-56-X        |                             | 5/16                 | 0.76                    | 1.44 | 0.12 | 2.61 | Pink               | P42                    | 12                     | 42                 | 1 1/2                   | 10             |
| <b>LCB1/0-38-X</b> |                             | 3/8                  | 0.76                    | 1.44 | 0.12 | 2.69 | Pink               | P42                    | 12                     | 42                 | 1 1/2                   | 10             |
| LCB1/0-12-X        |                             | 1/2                  | 0.80                    | 1.44 | 0.12 | 2.92 | Pink               | P42                    | 12                     | 42                 | 1 1/2                   | 10             |

‡See pages D3.62 – D3.65 for tool and die information.

\*\*Consult cable manufacturer for voltage stress relief instructions with applications greater than 2000 V.

E4. Permanent Identification

E5. Lockout/Tagout & Safety Solutions

F. Index



## Code Conductor, One-Hole, Long Barrel Lug (continued)

| Part Number         | Copper Conductor Size | Stud Hole Size (In.) | Figure Dimensions (In.) |      |      |      | Panduit Color Code | Panduit Die Index No.‡ | Burndy Die Index No.‡ | T&B Die Index No.‡ | Wire Strip Length (In.) | Std. Pkg. Qty. |
|---------------------|-----------------------|----------------------|-------------------------|------|------|------|--------------------|------------------------|-----------------------|--------------------|-------------------------|----------------|
|                     |                       |                      | W                       | B    | T    | L    |                    |                        |                       |                    |                         |                |
| <b>LCB2/0-38-X</b>  | 2/0 AWG               | 3/8                  | 0.85                    | 1.50 | 0.13 | 2.82 | Black              | P45                    | 13                    | 45                 | 1 9/16                  | 10             |
| LCB2/0-12-X         |                       | 1/2                  | 0.85                    | 1.50 | 0.13 | 3.07 | Black              | P45                    | 13                    | 45                 | 1 9/16                  | 10             |
| <b>LCB3/0-38-X</b>  | 3/0 AWG               | 3/8                  | 0.96                    | 1.50 | 0.13 | 2.87 | Orange             | P50                    | 14                    | 50                 | 1 9/16                  | 10             |
| LCB3/0-12-X         |                       | 1/2                  | 0.96                    | 1.50 | 0.13 | 3.12 | Orange             | P50                    | 14                    | 50                 | 1 9/16                  | 10             |
| <b>LCB4/0-38-X</b>  | 4/0 AWG               | 3/8                  | 1.06                    | 1.56 | 0.14 | 3.03 | Purple             | P54                    | 15                    | 54                 | 1 5/8                   | 10             |
| LCB4/0-12-X         |                       | 1/2                  | 1.06                    | 1.56 | 0.14 | 3.22 | Purple             | P54                    | 15                    | 54                 | 1 5/8                   | 10             |
| <b>LCB250-12-X</b>  | 250 kcmil             | 1/2                  | 1.17                    | 1.61 | 0.14 | 3.32 | Yellow             | P62                    | 16                    | 62                 | 1 11/16                 | 10             |
| LCB250-78-X         |                       | 7/8                  | 1.25                    | 1.61 | 0.12 | 3.85 | Yellow             | P62                    | 16                    | 62                 | 1 11/16                 | 10             |
| <b>LCB300-56-X</b>  | 300 kcmil             | 5/16                 | 1.19                    | 2.24 | 0.16 | 3.95 | White              | P66                    | 17                    | 66                 | 2 5/16                  | 10             |
| LCB300-38-X         |                       | 3/8                  | 1.19                    | 2.24 | 0.16 | 3.95 | White              | P66                    | 17                    | 66                 | 2 5/16                  | 10             |
| LCB300-12-X         |                       | 1/2                  | 1.19                    | 2.24 | 0.16 | 4.06 | White              | P66                    | 17                    | 66                 | 2 5/16                  | 10             |
| <b>LCB350-12-X</b>  | 350 kcmil             | 1/2                  | 1.28                    | 2.24 | 0.17 | 4.11 | Red                | P71                    | 18                    | 71                 | 2 5/16                  | 10             |
| LCB350-78-X         |                       | 7/8                  | 1.28                    | 2.24 | 0.17 | 4.78 | Red                | P71                    | 18                    | 71                 | 2 5/16                  | 10             |
| <b>LCB400-38-6</b>  | 400 kcmil             | 3/8                  | 1.39                    | 2.30 | 0.18 | 4.27 | Blue               | P76                    | 19                    | 76                 | 2 3/8                   | 6              |
| LCB400-12-6         |                       | 1/2                  | 1.39                    | 2.30 | 0.18 | 4.27 | Blue               | P76                    | 19                    | 76                 | 2 3/8                   | 6              |
| LCB400-58-6         |                       | 5/8                  | 1.39                    | 2.30 | 0.18 | 4.48 | Blue               | P76                    | 19                    | 76                 | 2 3/8                   | 6              |
| LCB400-78-6         |                       | 7/8                  | 1.39                    | 2.30 | 0.18 | 4.88 | Blue               | P76                    | 19                    | 76                 | 2 3/8                   | 6              |
| <b>LCB500-12-6</b>  | 500 kcmil             | 1/2                  | 1.54                    | 2.50 | 0.22 | 4.53 | Brown              | P87                    | 20                    | 87                 | 2 9/16                  | 6              |
| LCB500-58-6         |                       | 5/8                  | 1.54                    | 2.50 | 0.22 | 4.74 | Brown              | P87                    | 20                    | 87                 | 2 9/16                  | 6              |
| LCB500-78-6         |                       | 7/8                  | 1.54                    | 2.50 | 0.22 | 5.13 | Brown              | P87                    | 20                    | 87                 | 2 9/16                  | 6              |
| <b>LCB600-12-6</b>  | 600 kcmil             | 1/2                  | 1.70                    | 2.69 | 0.26 | 5.40 | Green              | P94                    | 22                    | 94                 | 2 3/4                   | 6              |
| LCB600-58-6         |                       | 5/8                  | 1.70                    | 2.69 | 0.26 | 5.40 | Green              | P94                    | 22                    | 94                 | 2 3/4                   | 6              |
| <b>LCB750-58-6</b>  | 750 kcmil             | 5/8                  | 1.89                    | 2.88 | 0.26 | 5.98 | Black              | P106                   | 24                    | 106                | 2 15/16                 | 6              |
| LCB750-78-6         |                       | 7/8                  | 1.89                    | 2.88 | 0.26 | 6.07 | Black              | P106                   | 24                    | 106                | 2 15/16                 | 6              |
| <b>LCB800-58-6</b>  | 800 kcmil             | 5/8                  | 1.95                    | 2.94 | 0.29 | 6.06 | Orange             | P107                   | 25                    | 107                | 3                       | 6              |
| <b>LCB1000-58-3</b> | 1000 kcmil            | 5/8                  | 2.17                    | 3.00 | 0.32 | 6.32 | White              | P125                   | 27                    | 125                | 3 1/16                  | 3              |

‡See pages D3.62 – D3.65 for tool and die information.

\*\*Consult cable manufacturer for voltage stress relief instructions with applications greater than 2000 V.

A.  
System  
Overview

B1.  
Cable Ties

B2.  
Cable  
Accessories

B3.  
Stainless  
Steel Ties

C1.  
Wiring  
Duct

C2.  
Surface  
Raceway

C3.  
Abrasion  
Protection

C4.  
Cable  
Management

D1.  
Terminals

D2.  
Power  
Connectors

D3.  
Grounding  
Connectors

E1.  
Labeling  
Systems

E2.  
Labels

E3.  
Pre-Printed  
& Write-On  
Markers

E4.  
Permanent  
Identification

E5.  
Lockout/  
Tagout  
& Safety  
Solutions

F.  
Index

A. System Overview



## Code Conductor, One-Hole, Long Barrel Lug, 45° Angle

B1. Cable Ties

### For Use with Stranded Copper Conductors

B2. Cable Accessories

#### Type LCB-H

B3. Stainless Steel Ties

- Long barrel maximizes number of crimps and provides premium wire pull-out strength and electrical performance
- Color-coded barrels marked with Panduit and specified competitor die index numbers for proper crimp die selection
- Enclosed barrel prevents corrosive material from entering barrel when used in harsh environments
- Tin-plated to inhibit corrosion

- UL Listed and CSA Certified to 35 KV\*\* and temperature rated to 90°C when crimped with Panduit and specified competitor crimping tools and dies
- UL Listed and CSA Certified for wide wire range-taking capability when crimped with Panduit® Uni-Die™ Dieless Crimping Tools‡
- **Tested by Telcordia – meets NEBS Level 3**
- American Bureau of Shipping approved

C1. Wiring Duct



C2. Surface Raceway

C3. Abrasion Protection

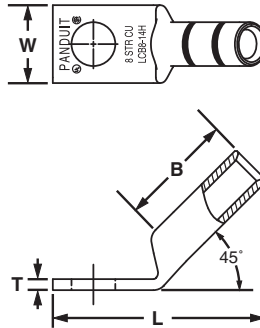

C4. Cable Management

| Part Number         | Copper Conductor Size       | Stud Hole Size (In.) | Figure Dimensions (In.) |      |      |      | Panduit Color Code | Panduit Die Index No.‡ | Burdndy Die Index No.‡ | T&B Die Index No.‡ | Wire Strip Length (In.) | Std. Pkg. Qty. |
|---------------------|-----------------------------|----------------------|-------------------------|------|------|------|--------------------|------------------------|------------------------|--------------------|-------------------------|----------------|
|                     |                             |                      | W                       | B    | T    | L    |                    |                        |                        |                    |                         |                |
| <b>LCB8-10H-L</b>   | #8 AWG                      | #10                  | 0.41                    | 0.70 | 0.08 | 1.23 | Red                | P21                    | 49                     | 21                 | 3/4                     | 50             |
| <b>LCB8-14H-L</b>   |                             | 1/4                  | 0.48                    | 0.70 | 0.07 | 1.31 | Red                | P21                    | 49                     | 21                 | 3/4                     | 50             |
| <b>LCB6-10H-L</b>   | #6 AWG                      | #10                  | 0.45                    | 1.07 | 0.09 | 1.52 | Blue               | P24                    | 7                      | 24                 | 1 1/8                   | 50             |
| <b>LCB6-14H-L</b>   |                             | 1/4                  | 0.48                    | 1.07 | 0.08 | 1.60 | Blue               | P24                    | 7                      | 24                 | 1 1/8                   | 50             |
| <b>LCB6-38H-L</b>   |                             | 3/8                  | 0.62                    | 1.07 | 0.05 | 1.81 | Blue               | P24                    | 7                      | 24                 | 1 1/8                   | 50             |
| <b>LCB4-10H-L</b>   | #4 – #3 AWG STR, #2 AWG SOL | #10                  | 0.55                    | 1.05 | 0.09 | 1.54 | Gray               | P29                    | 8                      | 29                 | 1 1/8                   | 50             |
| <b>LCB4-14H-L</b>   |                             | 1/4                  | 0.55                    | 1.05 | 0.09 | 1.63 | Gray               | P29                    | 8                      | 29                 | 1 1/8                   | 50             |
| <b>LCB2-10H-Q</b>   | #2 AWG                      | #10                  | 0.60                    | 1.16 | 0.10 | 1.68 | Brown              | P33                    | 10                     | 33                 | 1 1/4                   | 25             |
| <b>LCB2-56H-Q</b>   |                             | 5/16                 | 0.66                    | 1.16 | 0.10 | 1.87 | Brown              | P33                    | 10                     | 33                 | 1 1/4                   | 25             |
| <b>LCB1-10H-E</b>   | #1 AWG                      | #10                  | 0.70                    | 1.36 | 0.11 | 1.83 | Green              | P37                    | 11                     | 37                 | 1 7/16                  | 20             |
| <b>LCB1-56H-E</b>   |                             | 5/16                 | 0.70                    | 1.36 | 0.11 | 2.03 | Green              | P37                    | 11                     | 37                 | 1 7/16                  | 20             |
| <b>LCB1/0-10H-X</b> |                             | #10                  | 0.76                    | 1.44 | 0.12 | 1.92 | Pink               | P42                    | 12                     | 42                 | 1 1/2                   | 10             |
| <b>LCB1/0-56H-X</b> | 1/0 AWG                     | 5/16                 | 0.76                    | 1.44 | 0.12 | 2.12 | Pink               | P42                    | 12                     | 42                 | 1 1/2                   | 10             |
| <b>LCB1/0-38H-X</b> |                             | 3/8                  | 0.76                    | 1.44 | 0.12 | 2.19 | Pink               | P42                    | 12                     | 42                 | 1 1/2                   | 10             |
| <b>LCB1/0-12H-X</b> |                             | 1/2                  | 0.80                    | 1.44 | 0.11 | 2.42 | Pink               | P42                    | 12                     | 42                 | 1 1/2                   | 10             |
| <b>LCB2/0-38H-X</b> | 2/0 AWG                     | 3/8                  | 0.85                    | 1.50 | 0.13 | 2.31 | Black              | P45                    | 13                     | 45                 | 1 9/16                  | 10             |
| <b>LCB2/0-12H-X</b> |                             | 1/2                  | 0.85                    | 1.50 | 0.13 | 2.53 | Black              | P45                    | 13                     | 45                 | 1 9/16                  | 10             |
| <b>LCB3/0-38H-X</b> | 3/0 AWG                     | 3/8                  | 0.96                    | 1.50 | 0.13 | 2.33 | Orange             | P50                    | 14                     | 50                 | 1 9/16                  | 10             |
| <b>LCB3/0-12H-X</b> |                             | 1/2                  | 0.96                    | 1.50 | 0.13 | 2.58 | Orange             | P50                    | 14                     | 50                 | 1 9/16                  | 10             |

‡See pages D3.62 – D3.65 for tool and die information.

\*\*Consult cable manufacturer for voltage stress relief instructions with applications greater than 2000 V.

E4. Permanent Identification

E5. Lockout/Tagout & Safety Solutions

F. Index





## Code Conductor, One-Hole, Long Barrel Lug, 45° Angle (continued)

| Part Number  | Copper Conductor Size | Stud Hole Size (In.) | Figure Dimensions (In.) |      |      |      | Panduit Color Code | Panduit Die Index No.‡ | Burndy Die Index No.‡ | T&B Die Index No.‡ | Wire Strip Length (In.) | Std. Pkg. Qty. |
|--------------|-----------------------|----------------------|-------------------------|------|------|------|--------------------|------------------------|-----------------------|--------------------|-------------------------|----------------|
|              |                       |                      | W                       | B    | T    | L    |                    |                        |                       |                    |                         |                |
| LCB4/0-38H-X | 4/0 AWG               | 3/8                  | 1.06                    | 1.56 | 0.14 | 2.48 | Purple             | P54                    | 15                    | 54                 | 1 5/8                   | 10             |
| LCB4/0-12H-X |                       | 1/2                  | 1.06                    | 1.56 | 0.14 | 2.67 | Purple             | P54                    | 15                    | 54                 | 1 5/8                   | 10             |
| LCB250-12H-X | 250 kcmil             | 1/2                  | 1.17                    | 1.61 | 0.14 | 2.74 | Yellow             | P62                    | 16                    | 62                 | 1 11/16                 | 10             |
| LCB250-78H-X |                       | 7/8                  | 1.25                    | 1.61 | 0.12 | 3.27 | Yellow             | P62                    | 16                    | 62                 | 1 11/16                 | 10             |
| LCB300-56H-X | 300 kcmil             | 5/16                 | 1.19                    | 2.24 | 0.16 | 3.24 | White              | P66                    | 17                    | 66                 | 2 5/16                  | 10             |
| LCB300-38H-X |                       | 3/8                  | 1.19                    | 2.24 | 0.16 | 3.24 | White              | P66                    | 17                    | 66                 | 2 5/16                  | 10             |
| LCB300-12H-X |                       | 1/2                  | 1.19                    | 2.24 | 0.16 | 3.35 | White              | P66                    | 17                    | 66                 | 2 5/16                  | 10             |
| LCB350-12H-X | 350 kcmil             | 1/2                  | 1.28                    | 2.24 | 0.17 | 3.39 | Red                | P71                    | 18                    | 71                 | 2 5/16                  | 10             |
| LCB350-78H-X |                       | 7/8                  | 1.28                    | 2.24 | 0.17 | 4.04 | Red                | P71                    | 18                    | 71                 | 2 5/16                  | 10             |
| LCB400-12H-6 | 400 kcmil             | 1/2                  | 1.39                    | 2.30 | 0.18 | 3.53 | Blue               | P76                    | 19                    | 76                 | 2 3/8                   | 6              |
| LCB400-58H-6 |                       | 5/8                  | 1.39                    | 2.30 | 0.18 | 3.74 | Blue               | P76                    | 19                    | 76                 | 2 3/8                   | 6              |
| LCB400-78H-6 |                       | 7/8                  | 1.39                    | 2.30 | 0.18 | 4.13 | Blue               | P76                    | 19                    | 76                 | 2 3/8                   | 6              |
| LCB500-12H-6 | 500 kcmil             | 1/2                  | 1.54                    | 2.50 | 0.22 | 3.74 | Brown              | P87                    | 20                    | 87                 | 2 9/16                  | 6              |
| LCB500-58H-6 |                       | 5/8                  | 1.54                    | 2.50 | 0.22 | 3.95 | Brown              | P87                    | 20                    | 87                 | 2 9/16                  | 6              |
| LCB500-78H-6 |                       | 7/8                  | 1.54                    | 2.50 | 0.22 | 4.34 | Brown              | P87                    | 20                    | 87                 | 2 9/16                  | 6              |
| LCB600-12H-6 | 600 kcmil             | 1/2                  | 1.70                    | 2.69 | 0.26 | 4.56 | Green              | P94                    | 22                    | 94                 | 2 3/4                   | 6              |
| LCB600-58H-6 |                       | 5/8                  | 1.70                    | 2.69 | 0.26 | 4.56 | Green              | P94                    | 22                    | 94                 | 2 3/4                   | 6              |

‡See pages D3.62 – D3.65 for tool and die information.

\*\*Consult cable manufacturer for voltage stress relief instructions with applications greater than 2000 V.

A.  
System  
Overview

B1.  
Cable Ties

B2.  
Cable  
Accessories

B3.  
Stainless  
Steel Ties

C1.  
Wiring  
Duct

C2.  
Surface  
Raceway

C3.  
Abrasion  
Protection

C4.  
Cable  
Management

D1.  
Terminals

D2.  
Power  
Connectors

D3.  
Grounding  
Connectors

E1.  
Labeling  
Systems

E2.  
Labels

E3.  
Pre-Printed  
& Write-On  
Markers

E4.  
Permanent  
Identification

E5.  
Lockout/  
Tagout  
& Safety  
Solutions

F.  
Index

A. System Overview



## Code Conductor, One-Hole, Long Barrel Lug, 90° Angle

B1. Cable Ties

### For Use with Stranded Copper Conductors

#### Type LCB-F

B2. Cable Accessories

- Long barrel maximizes number of crimps and provides premium wire pull-out strength and electrical performance
- Color-coded barrels marked with Panduit and specified competitor die index numbers for proper crimp die selection
- Enclosed barrel prevents corrosive material from entering barrel when used in harsh environments
- Tin-plated to inhibit corrosion

- UL Listed and CSA Certified to 35 KV\*\* and temperature rated to 90°C when crimped with Panduit and specified competitor crimping tools and dies
- UL Listed and CSA Certified for wide wire range-taking capability when crimped with Panduit® Uni-Die™ Dieless Crimping Tools‡
- **Tested by Telcordia – meets NEBS Level 3**
- American Bureau of Shipping approved

B3. Stainless Steel Ties

C1. Wiring Duct



C2. Surface Raceway

C3. Abrasion Protection

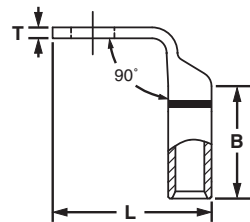

C4. Cable Management

| Part Number  | Copper Conductor Size       | Stud Hole Size (In.) | Figure Dimensions (In.) |      |      |      | Panduit Color Code | Panduit Die Index No.‡ | Burdny Die Index No.‡ | T&B Die Index No.‡ | Wire Strip Length (In.) | Std. Pkg. Qty. |
|--------------|-----------------------------|----------------------|-------------------------|------|------|------|--------------------|------------------------|-----------------------|--------------------|-------------------------|----------------|
|              |                             |                      | W                       | B    | T    | L    |                    |                        |                       |                    |                         |                |
| LCB8-10F-L   | #8 AWG                      | #10                  | 0.41                    | 0.70 | 0.08 | 1.08 | Red                | P21                    | 49                    | 21                 | 3/4                     | 50             |
| LCB8-14F-L   |                             | 1/4                  | 0.48                    | 0.70 | 0.07 | 1.07 | Red                | P21                    | 49                    | 21                 | 3/4                     | 50             |
| LCB6-10F-L   | #6 AWG                      | #10                  | 0.45                    | 1.07 | 0.09 | 1.49 | Blue               | P24                    | 7                     | 24                 | 1 1/8                   | 50             |
| LCB6-14F-L   |                             | 1/4                  | 0.48                    | 1.07 | 0.08 | 1.48 | Blue               | P24                    | 7                     | 24                 | 1 1/8                   | 50             |
| LCB6-38F-L   |                             | 3/8                  | 0.62                    | 1.07 | 0.05 | 1.45 | Blue               | P24                    | 7                     | 24                 | 1 1/8                   | 50             |
| LCB4-10F-L   | #4 – #3 AWG STR, #2 AWG SOL | #10                  | 0.55                    | 1.05 | 0.09 | 1.53 | Gray               | P29                    | 8                     | 29                 | 1 1/8                   | 50             |
| LCB4-14F-L   |                             | 1/4                  | 0.55                    | 1.05 | 0.09 | 1.53 | Gray               | P29                    | 8                     | 29                 | 1 1/8                   | 50             |
| LCB2-10F-Q   | #2 AWG                      | #10                  | 0.60                    | 1.16 | 0.10 | 1.75 | Brown              | P33                    | 10                    | 33                 | 1 1/4                   | 25             |
| LCB2-56F-Q   |                             | 5/16                 | 0.66                    | 1.16 | 0.10 | 1.74 | Brown              | P33                    | 10                    | 33                 | 1 1/4                   | 25             |
| LCB1-10F-E   | #1 AWG                      | #10                  | 0.70                    | 1.36 | 0.11 | 2.00 | Green              | P37                    | 11                    | 37                 | 1 7/16                  | 20             |
| LCB1-56F-E   |                             | 5/16                 | 0.70                    | 1.36 | 0.11 | 2.00 | Green              | P37                    | 11                    | 37                 | 1 7/16                  | 20             |
| LCB1/0-10F-X |                             | #10                  | 0.76                    | 1.44 | 0.12 | 2.15 | Pink               | P42                    | 12                    | 42                 | 1 1/2                   | 10             |
| LCB1/0-56F-X | 1/0 AWG                     | 5/16                 | 0.76                    | 1.44 | 0.12 | 2.15 | Pink               | P42                    | 12                    | 42                 | 1 1/2                   | 10             |
| LCB1/0-38F-X |                             | 3/8                  | 0.76                    | 1.44 | 0.12 | 2.15 | Pink               | P42                    | 12                    | 42                 | 1 1/2                   | 10             |
| LCB1/0-12F-X | 2/0 AWG                     | 1/2                  | 0.80                    | 1.44 | 0.12 | 2.14 | Pink               | P42                    | 12                    | 42                 | 1 1/2                   | 10             |
| LCB2/0-38F-X |                             | 3/8                  | 0.85                    | 1.50 | 0.13 | 2.30 | Black              | P45                    | 13                    | 45                 | 1 9/16                  | 10             |
| LCB3/0-38F-X |                             | 3/8                  | 0.96                    | 1.50 | 0.13 | 2.35 | Orange             | P50                    | 14                    | 50                 | 1 9/16                  | 10             |
| LCB3/0-12F-X | 3/0 AWG                     | 1/2                  | 0.96                    | 1.50 | 0.13 | 2.35 | Orange             | P50                    | 14                    | 50                 | 1 9/16                  | 10             |
| LCB4/0-38F-X |                             | 3/8                  | 1.06                    | 1.56 | 0.14 | 2.48 | Purple             | P54                    | 15                    | 54                 | 1 5/8                   | 10             |
| LCB4/0-12F-X | 4/0 AWG                     | 1/2                  | 1.06                    | 1.56 | 0.14 | 2.48 | Purple             | P54                    | 15                    | 54                 | 1 5/8                   | 10             |

‡See pages D3.62 – D3.65 for tool and die information.

\*\*Consult cable manufacturer for voltage stress relief instructions with applications greater than 2000 V.

E4. Permanent Identification

E5. Lockout/Tagout & Safety Solutions

F. Index



## Code Conductor, One-Hole, Long Barrel Lug, 90° Angle (continued)

| Part Number  | Copper Conductor Size | Stud Hole Size (In.) | Figure Dimensions (In.) |      |      |      | Panduit Color Code | Panduit Die Index No.‡ | Burndy Die Index No.‡ | T&B Die Index No.‡ | Wire Strip Length (In.) | Std. Pkg. Qty. |
|--------------|-----------------------|----------------------|-------------------------|------|------|------|--------------------|------------------------|-----------------------|--------------------|-------------------------|----------------|
|              |                       |                      | W                       | B    | T    | L    |                    |                        |                       |                    |                         |                |
| LCB250-12F-X | 250 kcmil             | 1/2                  | 1.17                    | 1.61 | 0.14 | 2.57 | Yellow             | P62                    | 16                    | 62                 | 1 11/16                 | 10             |
| LCB250-78F-X |                       | 7/8                  | 1.25                    | 1.61 | 0.12 | 2.49 | Yellow             | P62                    | 16                    | 62                 | 1 11/16                 | 10             |
| LCB350-12F-X | 350 kcmil             | 1/2                  | 1.28                    | 2.24 | 0.17 | 3.34 | Red                | P71                    | 18                    | 71                 | 2 5/16                  | 10             |
| LCB350-78F-X |                       | 7/8                  | 1.28                    | 2.24 | 0.17 | 3.34 | Red                | P71                    | 18                    | 71                 | 2 5/16                  | 10             |
| LCB400-58F-6 | 400 kcmil             | 5/8                  | 1.39                    | 2.30 | 0.18 | 3.47 | Blue               | P76                    | 19                    | 76                 | 2 3/8                   | 6              |
| LCB400-78F-6 |                       | 7/8                  | 1.39                    | 2.30 | 0.18 | 3.47 | Blue               | P76                    | 19                    | 76                 | 2 3/8                   | 6              |
| LCB500-12F-6 | 500 kcmil             | 1/2                  | 1.54                    | 2.50 | 0.22 | 3.77 | Brown              | P87                    | 20                    | 87                 | 2 9/16                  | 6              |
| LCB500-58F-6 |                       | 5/8                  | 1.54                    | 2.50 | 0.22 | 3.77 | Brown              | P87                    | 20                    | 87                 | 2 9/16                  | 6              |
| LCB500-78F-6 |                       | 7/8                  | 1.54                    | 2.50 | 0.22 | 3.77 | Brown              | P87                    | 20                    | 87                 | 2 9/16                  | 6              |
| LCB600-12F-6 | 600 kcmil             | 1/2                  | 1.70                    | 2.69 | 0.26 | 4.08 | Green              | P94                    | 22                    | 94                 | 2 3/4                   | 6              |
| LCB600-58F-6 |                       | 5/8                  | 1.70                    | 2.69 | 0.26 | 4.08 | Green              | P94                    | 22                    | 94                 | 2 3/4                   | 6              |

‡See pages D3.62 – D3.65 for tool and die information.

\*\*Consult cable manufacturer for voltage stress relief instructions with applications greater than 2000 V.

A.  
System  
Overview

B1.  
Cable Ties

B2.  
Cable  
Accessories

B3.  
Stainless  
Steel Ties

C1.  
Wiring  
Duct

C2.  
Surface  
Raceway

C3.  
Abrasion  
Protection

C4.  
Cable  
Management

D1.  
Terminals

D2.  
Power  
Connectors

D3.  
Grounding  
Connectors

E1.  
Labeling  
Systems

E2.  
Labels

E3.  
Pre-Printed  
& Write-On  
Markers

E4.  
Permanent  
Identification

E5.  
Lockout/  
Tagout  
& Safety  
Solutions

F.  
Index

A. System Overview



## Code Conductor, One-Hole, Long Barrel with Window Lug

B1. Cable Ties

### For Use with Stranded Copper Conductors

#### Type LCB-W

B2. Cable Accessories

- Long barrel maximizes number of crimps and provides premium wire pull-out strength and electrical performance
- Inspection window to visually assure full conductor insertion
- Color-coded barrels marked with Panduit and specified competitor die index numbers for proper crimp die selection
- Tin-plated to inhibit corrosion
- UL Listed and CSA Certified to 35 KV\*\* and temperature rated to 90°C when crimped with Panduit and specified competitor crimping tools and dies

- UL Listed and CSA Certified for wide wire range-taking capability when crimped with Panduit® Uni-Die™ Dieless Crimping Tools‡
- **Tested by Telcordia – meets NEBS Level 3**
- Meets J-STD-607-A and TIA-942 requirements for network systems grounding applications

C1. Wiring Duct

C2. Surface Raceway

C3. Abrasion Protection

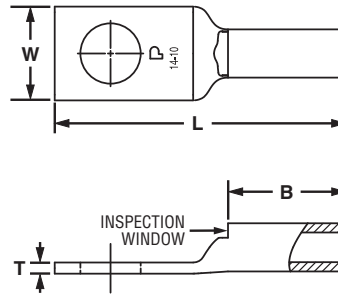

C4. Cable Management

| Part Number          | Copper Conductor Size                | Stud Hole Size (In.) | Figure Dimensions (In.) |      |      |      | Panduit Color Code | Panduit Die Index No.‡ | Burdny Die Index No.‡ | T&B Die Index No.‡ | Wire Strip Length (In.) | Std. Pkg. Qty. |
|----------------------|--------------------------------------|----------------------|-------------------------|------|------|------|--------------------|------------------------|-----------------------|--------------------|-------------------------|----------------|
|                      |                                      |                      | W                       | B    | T    | L    |                    |                        |                       |                    |                         |                |
| <b>LCB10-14W-L*</b>  | #14 – #10 AWG STR, #12 – #10 AWG SOL | 1/4                  | 0.42                    | 0.53 | 0.05 | 1.31 | —                  | —                      | —                     | —                  | 9/16                    | 50             |
| <b>LCB750-38W-6</b>  | 750 kcmil                            | 3/8                  | 1.89                    | 2.88 | 0.26 | 4.83 | Black              | P106                   | 24                    | 106                | 2 15/16                 | 6              |
| <b>LCB750-12W-6</b>  |                                      | 1/2                  | 1.89                    | 2.88 | 0.26 | 5.03 | Black              | P106                   | 24                    | 106                | 2 15/16                 | 6              |
| <b>LCB750-58W-6</b>  |                                      | 5/8                  | 1.89                    | 2.88 | 0.26 | 5.58 | Black              | P106                   | 24                    | 106                | 2 15/16                 | 6              |
| <b>LCB750-78W-6</b>  |                                      | 7/8                  | 1.89                    | 2.88 | 0.26 | 5.68 | Black              | P106                   | 24                    | 106                | 2 15/16                 | 6              |
| <b>LCB800-12W-6</b>  | 800 kcmil                            | 1/2                  | 1.95                    | 2.94 | 0.30 | 5.11 | Orange             | P107                   | 25                    | 107                | 3                       | 6              |
| <b>LCB800-58W-6</b>  |                                      | 5/8                  | 1.95                    | 2.94 | 0.30 | 5.68 | Orange             | P107                   | 25                    | 107                | 3                       | 6              |
| <b>LCB1000-38W-3</b> | 1000 kcmil                           | 3/8                  | 2.17                    | 3.00 | 0.32 | 5.08 | White              | P125                   | 27                    | 125                | 3 1/16                  | 3              |
| <b>LCB1000-12W-3</b> |                                      | 1/2                  | 2.17                    | 3.00 | 0.32 | 5.27 | White              | P125                   | 27                    | 125                | 3 1/16                  | 3              |
| <b>LCB1000-58W-3</b> |                                      | 5/8                  | 2.17                    | 3.00 | 0.32 | 5.92 | White              | P125                   | 27                    | 125                | 3 1/16                  | 3              |

‡See pages D3.62 – D3.65 for tool and die information.

\*Not tested to NEBS Level 3 requirements.

\*\*Consult cable manufacturer for voltage stress relief instructions with applications greater than 2000 V.

E1. Labeling Systems

E2. Labels

E3. Pre-Printed & Write-On Markers

E4. Permanent Identification

E5. Lockout/Tagout & Safety Solutions

F. Index



## Code Conductor, One-Hole, Long Barrel with Window Lug, 45° Angle

For Use with Stranded Copper Conductors

### Type LCB-WH

- Long barrel maximizes number of crimps and provides premium wire pull-out strength and electrical performance
- Inspection window to visually assure full conductor insertion
- Tin-plated to inhibit corrosion

- UL Listed and CSA Certified to 35 KV\*\* and temperature rated to 90°C when crimped with Panduit crimping tools and dies
- Meets J-STD-607-A and TIA-942 requirements for network systems grounding applications

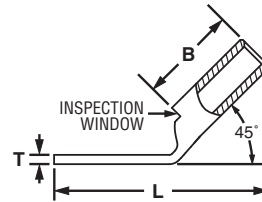
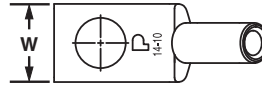

| Part Number  | Copper Conductor Size                | Stud Hole Size (In.) | Figure Dimensions (In.) |      |      |      | Panduit Color Code | Panduit Die Index No.‡ | Burndy Die Index No.‡ | T&B Die Index No.‡ | Wire Strip Length (In.) | Std. Pkg. Qty. |
|--------------|--------------------------------------|----------------------|-------------------------|------|------|------|--------------------|------------------------|-----------------------|--------------------|-------------------------|----------------|
|              |                                      |                      | W                       | B    | T    | L    |                    |                        |                       |                    |                         |                |
| LCB10-14WH-L | #14 – #10 AWG STR, #12 – #10 AWG SOL | 1/4                  | 0.42                    | 0.53 | 0.05 | 1.15 | —                  | —                      | —                     | —                  | 9/16                    | 50             |

‡See pages D3.62 – D3.65 for tool and die information.

\*\*Consult cable manufacturer for voltage stress relief instructions with applications greater than 2000 V.



## Code Conductor, One-Hole, Long Barrel with Window Lug, 90° Angle

For Use with Stranded Copper Conductors

### Type LCB-WF

- Long barrel maximizes number of crimps and provides premium wire pull-out strength and electrical performance
- Inspection window to visually assure full conductor insertion
- Tin-plated to inhibit corrosion

- UL Listed and CSA Certified to 35 KV\*\* and temperature rated to 90°C when crimped with Panduit crimping tools and dies
- Meets J-STD-607-A and TIA-942 requirements for network systems grounding applications

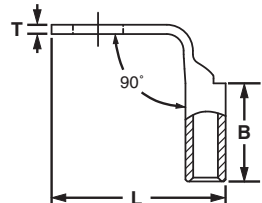

| Part Number  | Copper Conductor Size                | Stud Hole Size (In.) | Figure Dimensions (In.) |      |      |      | Panduit Color Code | Panduit Die Index No.‡ | Burndy Die Index No.‡ | T&B Die Index No.‡ | Wire Strip Length (In.) | Std. Pkg. Qty. |
|--------------|--------------------------------------|----------------------|-------------------------|------|------|------|--------------------|------------------------|-----------------------|--------------------|-------------------------|----------------|
|              |                                      |                      | W                       | B    | T    | L    |                    |                        |                       |                    |                         |                |
| LCB10-14WF-L | #14 – #10 AWG STR, #12 – #10 AWG SOL | 1/4                  | 0.42                    | 0.53 | 0.05 | 0.94 | —                  | —                      | —                     | —                  | 9/16                    | 50             |

‡See pages D3.62 – D3.65 for tool and die information.

\*\*Consult cable manufacturer for voltage stress relief instructions with applications greater than 2000 V.

A. System Overview

B1. Cable Ties

B2. Cable Accessories

B3. Stainless Steel Ties

C1. Wiring Duct

C2. Surface Raceway

C3. Abrasion Protection

C4. Cable Management

D1. Terminals

D2. Power Connectors

D3. Grounding Connectors

E1. Labeling Systems

E2. Labels

E3. Pre-Printed & Write-On Markers

E4. Permanent Identification

E5. Lockout/Tagout & Safety Solutions

F. Index

A. System Overview



## Code Conductor, One-Hole, Long Barrel with Corona Relief Taper Lug

B1. Cable Ties

**To Facilitate Use with Stranded Copper Conductors in Applications of 5000 V or More**

### Type LCBH

B2. Cable Accessories

- Externally chamfered barrel end inhibits Corona effect when used in high voltage applications
- Long barrel maximizes number of crimps and provides premium wire pull-out strength and electrical performance
- Color-coded barrels marked with Panduit and specified competitor die index numbers for proper crimp die selection

- Enclosed barrel prevents corrosive material from entering barrel when used in harsh environments
- Tin-plated to inhibit corrosion
- UL Listed and CSA Certified to 35 KV\*\* and temperature rated to 90°C when crimped with Panduit and specified competitor crimping tools and dies

B3. Stainless Steel Ties



Corona Relief Taper

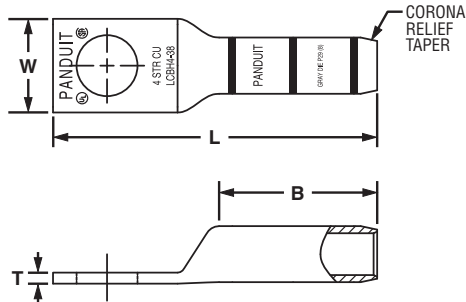

C1. Wiring Duct

C2. Surface Raceway

C3. Abrasion Protection

C4. Cable Management

| Part Number         | Copper Conductor Size | Stud Hole Size (In.) | Figure Dimensions (In.) |      |      |      | Panduit Color Code | Panduit Die Index No.‡ | Burndy Die Index No.‡ | T&B Die Index No.‡ | Wire Strip Length (In.) | Std. Pkg. Qty. |
|---------------------|-----------------------|----------------------|-------------------------|------|------|------|--------------------|------------------------|-----------------------|--------------------|-------------------------|----------------|
|                     |                       |                      | W                       | B    | T    | L    |                    |                        |                       |                    |                         |                |
| <b>LCBH4-38-L</b>   | #4 AWG                | 3/8                  | 0.62                    | 1.05 | 0.07 | 2.16 | Gray               | P29                    | 8                     | 29                 | 1 1/8                   | 50             |
| <b>LCBH2-38-Q</b>   | #2 AWG                | 3/8                  | 0.66                    | 1.16 | 0.10 | 2.34 | Brown              | P33                    | 10                    | 33                 | 1 1/4                   | 25             |
| <b>LCBH1-38-E</b>   | #1 AWG                | 3/8                  | 0.70                    | 1.36 | 0.10 | 2.57 | Green              | P37                    | 11                    | 37                 | 1 7/16                  | 20             |
| <b>LCBH1/0-38-X</b> | 1/0 AWG               | 3/8                  | 0.76                    | 1.44 | 0.12 | 2.69 | Pink               | P42                    | 12                    | 42                 | 1 1/2                   | 10             |
| <b>LCBH2/0-12-X</b> | 2/0 AWG               | 1/2                  | 0.85                    | 1.50 | 0.13 | 3.07 | Black              | P45                    | 13                    | 45                 | 1 9/16                  | 10             |
| <b>LCBH3/0-12-X</b> | 3/0 AWG               | 1/2                  | 0.96                    | 1.50 | 0.13 | 3.12 | Orange             | P50                    | 14                    | 50                 | 1 9/16                  | 10             |
| <b>LCBH4/0-12-X</b> | 4/0 AWG               | 1/2                  | 1.06                    | 1.56 | 0.14 | 3.22 | Purple             | P54                    | 15                    | 54                 | 1 5/8                   | 10             |
| <b>LCBH250-12-X</b> | 250 kcmil             | 1/2                  | 1.17                    | 1.61 | 0.14 | 3.32 | Yellow             | P62                    | 16                    | 62                 | 1 11/16                 | 10             |

‡See pages D3.66, D3.67 for tool and die information.

\*\*Consult cable manufacturer for voltage stress relief instructions with applications greater than 2000 V.

E1. Labeling Systems

E2. Labels

E3. Pre-Printed & Write-On Markers

E4. Permanent Identification

E5. Lockout/Tagout & Safety Solutions

F. Index





## Code Conductor, Two-Hole, Standard Barrel with Window Lug

For Use with Stranded Copper Conductors

### Type LCD

- Color-coded barrels marked with Panduit and specified competitor die index numbers for proper crimp die selection
- Inspection window to visually assure full conductor insertion
- Tin-plated to inhibit corrosion
- UL Listed and CSA Certified to 35 KV\*\* and temperature rated to 90°C when crimped with Panduit and specified competitor crimping tools and dies
- UL Listed and CSA Certified for wide wire range-taking capability when crimped with Panduit® Uni-Die™ Dieless Crimping Tools‡
- Tested by Telcordia – meets NEBS Level 3
- American Bureau of Shipping approved
- Available with NEMA hole sizes and spacing

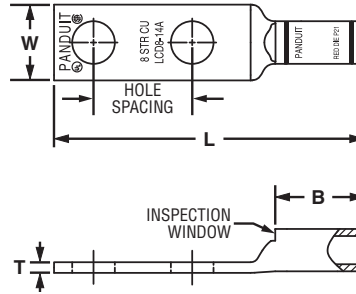

| Part Number  | Copper Conductor Size                | Stud Hole Size (In.) | Stud Hole Spacing (In.) | Figure Dimensions (In.) |      |      |      | Panduit Color Code | Panduit Die Index No.‡ | Burndy Die Index No.‡ | T&B Die Index No.‡ | Wire Strip Length (In.) | Std. Pkg. Qty. |
|--------------|--------------------------------------|----------------------|-------------------------|-------------------------|------|------|------|--------------------|------------------------|-----------------------|--------------------|-------------------------|----------------|
|              |                                      |                      |                         | W                       | B    | T    | L    |                    |                        |                       |                    |                         |                |
| LCD10-10A-L* | #14 – #10 AWG STR, #12 – #10 AWG SOL | #10                  | 0.63                    | 0.38                    | 0.38 | 0.06 | 1.69 | —                  | —                      | —                     | —                  | 7/16                    | 50             |
| LCD10-14A-L* |                                      | 1/4                  | 0.63                    | 0.42                    | 0.38 | 0.05 | 1.78 | —                  | —                      | —                     | —                  | 7/16                    | 50             |
| LCD10-14B-L* |                                      | 1/4                  | 0.75                    | 0.42                    | 0.38 | 0.05 | 1.91 | —                  | —                      | —                     | —                  | 7/16                    | 50             |
| LCD10-14D-L* |                                      | 1/4                  | 1.00                    | 0.42                    | 0.38 | 0.05 | 2.16 | —                  | —                      | —                     | —                  | 7/16                    | 50             |
| LCD10-38D-L* |                                      | 3/8                  | 1.00                    | 0.56                    | 0.38 | 0.04 | 2.38 | —                  | —                      | —                     | —                  | 7/16                    | 50             |
| LCD8-10A-L   | #8 AWG                               | #10                  | 0.63                    | 0.41                    | 0.56 | 0.08 | 1.88 | Red                | P21                    | 49                    | 21                 | 5/8                     | 50             |
| LCD8-14A-L   |                                      | 1/4                  | 0.63                    | 0.48                    | 0.56 | 0.07 | 1.97 | Red                | P21                    | 49                    | 21                 | 5/8                     | 50             |
| LCD8-14B-L   |                                      | 1/4                  | 0.75                    | 0.48                    | 0.56 | 0.07 | 2.09 | Red                | P21                    | 49                    | 21                 | 5/8                     | 50             |
| LCD8-14D-L   |                                      | 1/4                  | 1.00                    | 0.48                    | 0.56 | 0.07 | 2.34 | Red                | P21                    | 49                    | 21                 | 5/8                     | 50             |
| LCD8-38D-L   |                                      | 3/8                  | 1.00                    | 0.60                    | 0.56 | 0.05 | 2.56 | Red                | P21                    | 49                    | 21                 | 5/8                     | 50             |
| LCD6-10A-L   | #6 AWG                               | #10                  | 0.63                    | 0.46                    | 0.81 | 0.08 | 2.15 | Blue               | P24                    | 7                     | 24                 | 7/8                     | 50             |
| LCD6-10B-L   |                                      | #10                  | 0.75                    | 0.46                    | 0.81 | 0.08 | 2.27 | Blue               | P24                    | 7                     | 24                 | 7/8                     | 50             |
| LCD6-10D-L   |                                      | #10                  | 1.00                    | 0.46                    | 0.81 | 0.08 | 2.52 | Blue               | P24                    | 7                     | 24                 | 7/8                     | 50             |
| LCD6-14A-L   |                                      | 1/4                  | 0.63                    | 0.48                    | 0.81 | 0.08 | 2.24 | Blue               | P24                    | 7                     | 24                 | 7/8                     | 50             |
| LCD6-14B-L   |                                      | 1/4                  | 0.75                    | 0.48                    | 0.81 | 0.08 | 2.36 | Blue               | P24                    | 7                     | 24                 | 7/8                     | 50             |
| LCD6-14D-L   |                                      | 1/4                  | 1.00                    | 0.48                    | 0.81 | 0.08 | 2.61 | Blue               | P24                    | 7                     | 24                 | 7/8                     | 50             |
| LCD6-56D-L   |                                      | 5/16                 | 1.00                    | 0.56                    | 0.81 | 0.07 | 2.73 | Blue               | P24                    | 7                     | 24                 | 7/8                     | 50             |
| LCD6-38D-L   |                                      | 3/8                  | 1.00                    | 0.62                    | 0.81 | 0.06 | 2.83 | Blue               | P24                    | 7                     | 24                 | 7/8                     | 50             |
| LCD4-10A-L   | #4 – #3 AWG STR, #2 AWG SOL          | #10                  | 0.63                    | 0.55                    | 0.81 | 0.09 | 2.17 | Gray               | P29                    | 8                     | 29                 | 7/8                     | 50             |
| LCD4-10B-L   |                                      | #10                  | 0.75                    | 0.55                    | 0.81 | 0.09 | 2.29 | Gray               | P29                    | 8                     | 29                 | 7/8                     | 50             |
| LCD4-14A-L   |                                      | 1/4                  | 0.63                    | 0.55                    | 0.81 | 0.09 | 2.26 | Gray               | P29                    | 8                     | 29                 | 7/8                     | 50             |
| LCD4-14B-L   |                                      | 1/4                  | 0.75                    | 0.55                    | 0.81 | 0.09 | 2.38 | Gray               | P29                    | 8                     | 29                 | 7/8                     | 50             |
| LCD4-14D-L   |                                      | 1/4                  | 1.00                    | 0.55                    | 0.81 | 0.09 | 2.63 | Gray               | P29                    | 8                     | 29                 | 7/8                     | 50             |
| LCD4-38D-L   |                                      | 3/8                  | 1.00                    | 0.62                    | 0.81 | 0.08 | 2.85 | Gray               | P29                    | 8                     | 29                 | 7/8                     | 50             |
| LCD2-14A-Q   | #2 AWG                               | 1/4                  | 0.63                    | 0.60                    | 0.88 | 0.10 | 2.40 | Brown              | P33                    | 10                    | 33                 | 15/16                   | 25             |
| LCD2-14B-Q   |                                      | 1/4                  | 0.75                    | 0.60                    | 0.88 | 0.10 | 2.52 | Brown              | P33                    | 10                    | 33                 | 15/16                   | 25             |
| LCD2-14D-Q   |                                      | 1/4                  | 1.00                    | 0.60                    | 0.88 | 0.10 | 2.77 | Brown              | P33                    | 10                    | 33                 | 15/16                   | 25             |
| LCD2-56B-Q   |                                      | 5/16                 | 0.75                    | 0.66                    | 0.88 | 0.10 | 2.65 | Brown              | P33                    | 10                    | 33                 | 15/16                   | 25             |
| LCD2-38D-Q   |                                      | 3/8                  | 1.00                    | 0.66                    | 0.88 | 0.10 | 3.00 | Brown              | P33                    | 10                    | 33                 | 15/16                   | 25             |
| LCD2-12-Q    |                                      | 1/2                  | 1.75                    | 0.75                    | 0.88 | 0.08 | 4.14 | Brown              | P33                    | 10                    | 33                 | 15/16                   | 25             |

‡See pages D3.58 – D3.61 for tool and die information.

\*Not tested to NEBS Level 3 requirements.

\*\*Consult cable manufacturer for voltage stress relief instructions with applications greater than 2000 V.

Table continues on page D2.32

A. System Overview

B1. Cable Ties

B2. Cable Accessories

B3. Stainless Steel Ties

C1. Wiring Duct

C2. Surface Raceway

C3. Abrasion Protection

C4. Cable Management

D1. Terminals

D2. Power Connectors

D3. Grounding Connectors

E1. Labeling Systems

E2. Labels

E3. Pre-Printed & Write-On Markers

E4. Permanent Identification

E5. Lockout/Tagout & Safety Solutions

F. Index



## Code Conductor, Two-Hole, Standard Barrel with Window Lug (continued)

| Part Number         | Copper Conductor Size | Stud Hole Size (In.) | Stud Hole Spacing (In.) | Figure Dimensions (In.) |      |      |      | Panduit Color Code | Panduit Die Index No.‡ | Burdny Die Index No.‡ | T&B Die Index No.‡ | Wire Strip Length (In.) | Std. Pkg. Qty. |    |
|---------------------|-----------------------|----------------------|-------------------------|-------------------------|------|------|------|--------------------|------------------------|-----------------------|--------------------|-------------------------|----------------|----|
|                     |                       |                      |                         | W                       | B    | T    | L    |                    |                        |                       |                    |                         |                |    |
| <b>LCD1-14A-E</b>   | #1 AWG                | 1/4                  | 0.63                    | 0.70                    | 0.88 | 0.11 | 2.42 | Green              | P37                    | 11                    | 37                 | 15/16                   | 20             |    |
| LCD1-14B-E          |                       | 1/4                  | 0.75                    | 0.70                    | 0.88 | 0.11 | 2.54 | Green              | P37                    | 11                    | 37                 | 15/16                   | 20             |    |
| LCD1-56C-E          |                       | 5/16                 | 0.88                    | 0.70                    | 0.88 | 0.11 | 2.79 | Green              | P37                    | 11                    | 37                 | 15/16                   | 20             |    |
| <b>LCD1-38D-E</b>   |                       | 3/8                  | 1.00                    | 0.70                    | 0.88 | 0.11 | 2.99 | Green              | P37                    | 11                    | 37                 | 15/16                   | 20             |    |
| LCD1-12-E           |                       | 1/2                  | 1.75                    | 0.75                    | 0.88 | 0.09 | 4.16 | Green              | P37                    | 11                    | 37                 | 15/16                   | 20             |    |
| LCD1/0-14A-X        | 1/0 AWG               | 1/4                  | 0.63                    | 0.76                    | 0.94 | 0.12 | 2.57 | Pink               | P42                    | 12                    | 42                 | 1                       | 10             |    |
| LCD1/0-14B-X        |                       | 1/4                  | 0.75                    | 0.76                    | 0.94 | 0.12 | 2.70 | Pink               | P42                    | 12                    | 42                 | 1                       | 10             |    |
| LCD1/0-56C-X        |                       | 5/16                 | 0.88                    | 0.76                    | 0.94 | 0.12 | 2.88 | Pink               | P42                    | 12                    | 42                 | 1                       | 10             |    |
| <b>LCD1/0-38D-X</b> |                       | 3/8                  | 1.00                    | 0.76                    | 0.94 | 0.12 | 3.08 | Pink               | P42                    | 12                    | 42                 | 1                       | 10             |    |
| LCD1/0-12-X         |                       | 1/2                  | 1.75                    | 0.80                    | 0.94 | 0.12 | 4.25 | Pink               | P42                    | 12                    | 42                 | 1                       | 10             |    |
| LCD2/0-14A-X        | 2/0 AWG               | 1/4                  | 0.63                    | 0.85                    | 0.98 | 0.13 | 2.70 | Black              | P45                    | 13                    | 45                 | 1 1/16                  | 10             |    |
| <b>LCD2/0-14B-X</b> |                       | 1/4                  | 0.75                    | 0.85                    | 0.98 | 0.13 | 2.83 | Black              | P45                    | 13                    | 45                 | 1 1/16                  | 10             |    |
| LCD2/0-56C-X        |                       | 5/16                 | 0.88                    | 0.85                    | 0.98 | 0.13 | 2.95 | Black              | P45                    | 13                    | 45                 | 1 1/16                  | 10             |    |
| LCD2/0-38D-X        |                       | 3/8                  | 1.00                    | 0.85                    | 0.98 | 0.13 | 3.14 | Black              | P45                    | 13                    | 45                 | 1 1/16                  | 10             |    |
| LCD2/0-12-X         |                       | 1/2                  | 1.75                    | 0.85                    | 0.98 | 0.13 | 4.30 | Black              | P45                    | 13                    | 45                 | 1 1/16                  | 10             |    |
| LCD3/0-14B-X        | 3/0 AWG               | 1/4                  | 0.75                    | 0.96                    | 1.14 | 0.13 | 3.02 | Orange             | P50                    | 14                    | 50                 | 1 3/16                  | 10             |    |
| <b>LCD3/0-56D-X</b> |                       | 5/16                 | 1.00                    | 0.96                    | 1.14 | 0.13 | 3.27 | Orange             | P50                    | 14                    | 50                 | 1 3/16                  | 10             |    |
| LCD3/0-38D-X        |                       | 3/8                  | 1.00                    | 0.96                    | 1.14 | 0.13 | 3.33 | Orange             | P50                    | 14                    | 50                 | 1 3/16                  | 10             |    |
| LCD3/0-12-X         |                       | 1/2                  | 1.75                    | 0.96                    | 1.14 | 0.13 | 4.49 | Orange             | P50                    | 14                    | 50                 | 1 3/16                  | 10             |    |
| LCD4/0-14B-X        |                       | 4/0 AWG              | 1/4                     | 0.75                    | 1.06 | 1.19 | 0.14 | 3.10               | Purple                 | P54                   | 15                 | 54                      | 1 1/4          | 10 |
| <b>LCD4/0-38D-X</b> | 3/8                   |                      | 1.00                    | 1.06                    | 1.19 | 0.14 | 3.44 | Purple             | P54                    | 15                    | 54                 | 1 1/4                   | 10             |    |
| ◆ LCD4/0-12-X       | 1/2                   |                      | 1.75                    | 1.06                    | 1.19 | 0.14 | 4.58 | Purple             | P54                    | 15                    | 54                 | 1 1/4                   | 10             |    |
| <b>LCD250-38D-X</b> | 250 kcmil             |                      | 3/8                     | 1.00                    | 1.17 | 1.25 | 0.14 | 3.54               | Yellow                 | P62                   | 16                 | 62                      | 1 5/16         | 10 |
| ◆ LCD250-12-X       |                       |                      | 1/2                     | 1.75                    | 1.17 | 1.25 | 0.14 | 4.68               | Yellow                 | P62                   | 16                 | 62                      | 1 5/16         | 10 |
| LCD300-38D-X        | 300 kcmil             | 3/8                  | 1.00                    | 1.19                    | 1.44 | 0.16 | 3.74 | White              | P66                    | 17                    | 66                 | 1 1/2                   | 10             |    |
| ◆ LCD300-12-X       |                       | 1/2                  | 1.75                    | 1.19                    | 1.44 | 0.16 | 4.92 | White              | P66                    | 17                    | 66                 | 1 1/2                   | 10             |    |
| LCD350-14B-X        | 350 kcmil             | 1/4                  | 0.75                    | 1.28                    | 1.44 | 0.17 | 3.30 | Red                | P71                    | 18                    | 71                 | 1 1/2                   | 10             |    |
| LCD350-38D-X        |                       | 3/8                  | 1.00                    | 1.28                    | 1.44 | 0.17 | 3.78 | Red                | P71                    | 18                    | 71                 | 1 1/2                   | 10             |    |
| LCD350-12E-X        |                       | 1/2                  | 1.25                    | 1.28                    | 1.44 | 0.17 | 4.33 | Red                | P71                    | 18                    | 71                 | 1 1/2                   | 10             |    |
| ◆ LCD350-12-X       |                       | 1/2                  | 1.75                    | 1.28                    | 1.44 | 0.17 | 4.96 | Red                | P71                    | 18                    | 71                 | 1 1/2                   | 10             |    |
| LCD400-38D-6        |                       | 400 kcmil            | 3/8                     | 1.00                    | 1.39 | 1.50 | 0.18 | 3.86               | Blue                   | P76                   | 19                 | 76                      | 1 9/16         | 6  |
| ◆ LCD400-12-6       | 1/2                   |                      | 1.75                    | 1.39                    | 1.50 | 0.18 | 5.04 | Blue               | P76                    | 19                    | 76                 | 1 9/16                  | 6              |    |
| LCD500-14B-6        | 500 kcmil             | 1/4                  | 0.75                    | 1.54                    | 1.75 | 0.22 | 3.71 | Brown              | P87                    | 20                    | 87                 | 1 13/16                 | 6              |    |
| LCD500-38D-6        |                       | 3/8                  | 1.00                    | 1.54                    | 1.75 | 0.22 | 4.19 | Brown              | P87                    | 20                    | 87                 | 1 13/16                 | 6              |    |
| LCD500-12E-6        |                       | 1/2                  | 1.25                    | 1.54                    | 1.75 | 0.22 | 4.74 | Brown              | P87                    | 20                    | 87                 | 1 13/16                 | 6              |    |
| ◆ LCD500-12-6       |                       | 1/2                  | 1.75                    | 1.54                    | 1.75 | 0.22 | 5.37 | Brown              | P87                    | 20                    | 87                 | 1 13/16                 | 6              |    |
| LCD600-38D-6        |                       | 600 kcmil            | 3/8                     | 1.00                    | 1.70 | 1.75 | 0.26 | 4.24               | Green                  | P94                   | 22                 | 94                      | 1 13/16        | 6  |
| ◆ LCD600-12-6       | 1/2                   |                      | 1.75                    | 1.70                    | 1.75 | 0.26 | 5.42 | Green              | P94                    | 22                    | 94                 | 1 13/16                 | 6              |    |
| LCD750-38D-6        | 750 kcmil             | 3/8                  | 1.00                    | 1.89                    | 1.88 | 0.26 | 4.71 | Black              | P106                   | 24                    | 106                | 1 15/16                 | 6              |    |
| ◆ LCD750-12-6       |                       | 1/2                  | 1.75                    | 1.89                    | 1.88 | 0.26 | 5.65 | Black              | P106                   | 24                    | 106                | 1 15/16                 | 6              |    |
| LCD750-58G-6        | 750 kcmil             | 5/8                  | 1.50                    | 1.89                    | 1.88 | 0.26 | 5.46 | Black              | P106                   | 24                    | 106                | 1 15/16                 | 6              |    |
| ◆ LCD1000-12-3      | 1000 kcmil            | 1/2                  | 1.75                    | 2.17                    | 1.88 | 0.32 | 5.77 | White              | P125                   | 27                    | 125                | 1 15/16                 | 3              |    |
| LCD1000-12E-3       |                       | 1/2                  | 1.25                    | 2.17                    | 1.88 | 0.32 | 5.27 | White              | P125                   | 27                    | 125                | 1 15/16                 | 3              |    |

‡See pages D3.58 – D3.61 for tool and die information.

\*\*Consult cable manufacturer for voltage stress relief instructions with applications greater than 2000 V.

◆NEMA hole sizes and spacing.



## Code Conductor, Two-Hole, Standard Barrel with Window Lug, 45° Angle

For Use with Stranded Copper Conductors

### Type LCD-H

- Color-coded barrels marked with Panduit and specified competitor die index numbers for proper crimp die selection
- Inspection window to visually assure full conductor insertion
- Tin-plated to inhibit corrosion
- UL Listed and CSA Certified to 35 KV\*\* and temperature rated to 90°C when crimped with Panduit and specified competitor crimping tools and dies

- UL Listed and CSA Certified for wide wire range-taking capability when crimped with Panduit® Uni-Die™ Dieless Crimping Tools‡
- **Tested by Telcordia – meets NEBS Level 3**
- American Bureau of Shipping approved
- Available with NEMA hole sizes and spacing

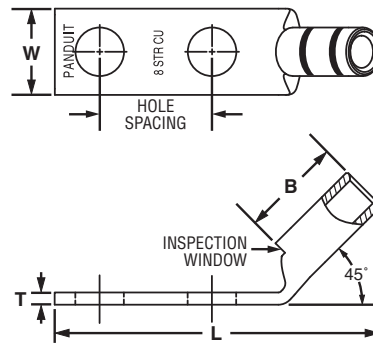

| Part Number   | Copper Conductor Size       | Stud Hole Size (In.) | Stud Hole Spacing (In.) | Figure Dimensions (In.) |      |      |      | Panduit Color Code | Panduit Die Index No.‡ | Burdny Die Index No.‡ | T&B Die Index No.‡ | Wire Strip Length (In.) | Std. Pkg. Qty. |
|---------------|-----------------------------|----------------------|-------------------------|-------------------------|------|------|------|--------------------|------------------------|-----------------------|--------------------|-------------------------|----------------|
|               |                             |                      |                         | W                       | B    | T    | L    |                    |                        |                       |                    |                         |                |
| LCD10-10AH-L* | #14 – #10                   | #10                  | 0.63                    | 0.38                    | 0.38 | 0.06 | 1.59 | —                  | —                      | —                     | —                  | 7/16                    | 50             |
| LCD10-14AH-L* | #12 – #10                   | 1/4                  | 0.63                    | 0.42                    | 0.38 | 0.05 | 1.67 | —                  | —                      | —                     | —                  | 7/16                    | 50             |
| LCD10-38DH-L* | #12 – #10                   | 3/8                  | 1.00                    | 0.56                    | 0.38 | 0.04 | 2.28 | —                  | —                      | —                     | —                  | 7/16                    | 50             |
| LCD8-10AH-L   | #8 AWG                      | #10                  | 0.63                    | 0.41                    | 0.56 | 0.08 | 1.73 | Red                | P21                    | 49                    | 21                 | 5/8                     | 50             |
| LCD8-14AH-L   |                             | 1/4                  | 0.63                    | 0.48                    | 0.56 | 0.07 | 1.81 | Red                | P21                    | 49                    | 21                 | 5/8                     | 50             |
| LCD8-14BH-L   |                             | 1/4                  | 0.75                    | 0.48                    | 0.56 | 0.07 | 1.94 | Red                | P21                    | 49                    | 21                 | 5/8                     | 50             |
| LCD8-14DH-L   |                             | 1/4                  | 1.00                    | 0.48                    | 0.56 | 0.07 | 2.19 | Red                | P21                    | 49                    | 21                 | 5/8                     | 50             |
| LCD8-38DH-L   |                             | 3/8                  | 1.00                    | 0.63                    | 0.56 | 0.05 | 2.40 | Red                | P21                    | 49                    | 21                 | 5/8                     | 50             |
| LCD6-10AH-L   | #6 AWG                      | #10                  | 0.63                    | 0.46                    | 0.81 | 0.08 | 1.92 | Blue               | P24                    | 7                     | 24                 | 7/8                     | 50             |
| LCD6-10BH-L   |                             | #10                  | 0.75                    | 0.46                    | 0.81 | 0.08 | 2.04 | Blue               | P24                    | 7                     | 24                 | 7/8                     | 50             |
| LCD6-10DH-L   |                             | #10                  | 1.00                    | 0.46                    | 0.81 | 0.08 | 2.29 | Blue               | P24                    | 7                     | 24                 | 7/8                     | 50             |
| LCD6-14AH-L   |                             | 1/4                  | 0.63                    | 0.48                    | 0.81 | 0.08 | 2.00 | Blue               | P24                    | 7                     | 24                 | 7/8                     | 50             |
| LCD6-14BH-L   |                             | 1/4                  | 0.75                    | 0.48                    | 0.81 | 0.08 | 2.13 | Blue               | P24                    | 7                     | 24                 | 7/8                     | 50             |
| LCD6-14DH-L   |                             | 1/4                  | 1.00                    | 0.48                    | 0.81 | 0.08 | 2.38 | Blue               | P24                    | 7                     | 24                 | 7/8                     | 50             |
| LCD6-56DH-L   |                             | 5/16                 | 1.00                    | 0.56                    | 0.81 | 0.07 | 2.49 | Blue               | P24                    | 7                     | 24                 | 7/8                     | 50             |
| LCD6-38DH-L   |                             | 3/8                  | 1.00                    | 0.62                    | 0.81 | 0.06 | 2.59 | Blue               | P24                    | 7                     | 24                 | 7/8                     | 50             |
| LCD4-10AH-L   | #4 – #3 AWG STR, #2 AWG SOL | #10                  | 0.63                    | 0.55                    | 0.81 | 0.09 | 1.94 | Gray               | P29                    | 8                     | 29                 | 7/8                     | 50             |
| LCD4-10BH-L   |                             | #10                  | 0.75                    | 0.55                    | 0.81 | 0.09 | 2.06 | Gray               | P29                    | 8                     | 29                 | 7/8                     | 50             |
| LCD4-14AH-L   |                             | 1/4                  | 0.63                    | 0.55                    | 0.81 | 0.09 | 2.03 | Gray               | P29                    | 8                     | 29                 | 7/8                     | 50             |
| LCD4-14BH-L   |                             | 1/4                  | 0.75                    | 0.55                    | 0.81 | 0.09 | 2.15 | Gray               | P29                    | 8                     | 29                 | 7/8                     | 50             |
| LCD4-14DH-L   |                             | 1/4                  | 1.00                    | 0.55                    | 0.81 | 0.09 | 2.40 | Gray               | P29                    | 8                     | 29                 | 7/8                     | 50             |
| LCD4-38DH-L   |                             | 3/8                  | 1.00                    | 0.62                    | 0.81 | 0.08 | 2.62 | Gray               | P29                    | 8                     | 29                 | 7/8                     | 50             |

‡See pages D3.58 – D3.61 for tool and die information.

\*Not tested to NEBS Level 3 requirements.

\*\*Consult cable manufacturer for voltage stress relief instructions with applications greater than 2000 V.

◆NEMA hole sizes and spacing.

Table continues on page D2.34

A. System Overview

B1. Cable Ties

B2. Cable Accessories

B3. Stainless Steel Ties

C1. Wiring Duct

C2. Surface Raceway

C3. Abrasion Protection

C4. Cable Management

D1. Terminals

D2. Power Connectors

D3. Grounding Connectors

E1. Labeling Systems

E2. Labels

E3. Pre-Printed & Write-On Markers

E4. Permanent Identification

E5. Lockout/Tagout & Safety Solutions

F. Index



## Code Conductor, Two-Hole, Standard Barrel with Window Lug, 45° Angle (continued)

| Part Number   | Copper Conductor Size | Stud Hole Size (In.) | Stud Hole Spacing (In.) | Figure Dimensions (In.) |      |      |      | Panduit Color Code | Panduit Die Index No.‡ | Burndy Die Index No.‡ | T&B Die Index No.‡ | Wire Strip Length (In.) | Std. Pkg. Qty. |
|---------------|-----------------------|----------------------|-------------------------|-------------------------|------|------|------|--------------------|------------------------|-----------------------|--------------------|-------------------------|----------------|
|               |                       |                      |                         | W                       | B    | T    | L    |                    |                        |                       |                    |                         |                |
| LCD2-14AH-Q   | #2 AWG                | 1/4                  | 0.63                    | 0.60                    | 0.88 | 0.10 | 2.11 | Brown              | P33                    | 10                    | 33                 | 15/16                   | 25             |
| LCD2-14BH-Q   |                       | 1/4                  | 0.75                    | 0.60                    | 0.88 | 0.10 | 2.24 | Brown              | P33                    | 10                    | 33                 | 15/16                   | 25             |
| LCD2-14DH-Q   |                       | 1/4                  | 1.00                    | 0.60                    | 0.88 | 0.10 | 2.49 | Brown              | P33                    | 10                    | 33                 | 15/16                   | 25             |
| LCD2-56BH-Q   |                       | 5/16                 | 0.75                    | 0.66                    | 0.88 | 0.10 | 2.36 | Brown              | P33                    | 10                    | 33                 | 15/16                   | 25             |
| LCD2-38DH-Q   |                       | 3/8                  | 1.00                    | 0.66                    | 0.88 | 0.10 | 2.71 | Brown              | P33                    | 10                    | 33                 | 15/16                   | 25             |
| LCD2-12H-Q    |                       | 1/2                  | 1.75                    | 0.75                    | 0.88 | 0.08 | 3.84 | Brown              | P33                    | 10                    | 33                 | 15/16                   | 25             |
| LCD1-14AH-E   | #1 AWG                | 1/4                  | 0.63                    | 0.70                    | 0.88 | 0.11 | 2.12 | Green              | P37                    | 11                    | 37                 | 15/16                   | 20             |
| LCD1-14BH-E   |                       | 1/4                  | 0.75                    | 0.70                    | 0.88 | 0.11 | 2.25 | Green              | P37                    | 11                    | 37                 | 15/16                   | 20             |
| LCD1-56CH-E   |                       | 5/16                 | 0.88                    | 0.70                    | 0.88 | 0.11 | 2.50 | Green              | P37                    | 11                    | 37                 | 15/16                   | 20             |
| LCD1-38DH-E   |                       | 3/8                  | 1.00                    | 0.70                    | 0.88 | 0.11 | 2.70 | Green              | P37                    | 11                    | 37                 | 15/16                   | 20             |
| LCD1-12H-E    | 1/0 AWG               | 1/2                  | 1.75                    | 0.75                    | 0.88 | 0.09 | 3.87 | Green              | P37                    | 11                    | 37                 | 15/16                   | 20             |
| LCD1/0-14AH-X |                       | 1/4                  | 0.63                    | 0.76                    | 0.94 | 0.12 | 2.26 | Pink               | P42                    | 12                    | 42                 | 1                       | 10             |
| LCD1/0-14BH-X |                       | 1/4                  | 0.75                    | 0.76                    | 0.94 | 0.12 | 2.38 | Pink               | P42                    | 12                    | 42                 | 1                       | 10             |
| LCD1/0-56CH-X |                       | 5/16                 | 0.88                    | 0.76                    | 0.94 | 0.12 | 2.56 | Pink               | P42                    | 12                    | 42                 | 1                       | 10             |
| LCD1/0-38DH-X |                       | 3/8                  | 1.00                    | 0.76                    | 0.94 | 0.12 | 2.76 | Pink               | P42                    | 12                    | 42                 | 1                       | 10             |
| LCD1/0-12H-X  |                       | 1/2                  | 1.75                    | 0.80                    | 0.94 | 0.12 | 3.93 | Pink               | P42                    | 12                    | 42                 | 1                       | 10             |
| LCD2/0-14AH-X | 2/0 AWG               | 1/4                  | 0.63                    | 0.85                    | 0.98 | 0.13 | 2.39 | Black              | P45                    | 13                    | 45                 | 1 1/16                  | 10             |
| LCD2/0-14BH-X |                       | 1/4                  | 0.75                    | 0.85                    | 0.98 | 0.13 | 2.52 | Black              | P45                    | 13                    | 45                 | 1 1/16                  | 10             |
| LCD2/0-56CH-X |                       | 5/16                 | 0.88                    | 0.85                    | 0.98 | 0.13 | 2.64 | Black              | P45                    | 13                    | 45                 | 1 1/16                  | 10             |
| LCD2/0-38DH-X |                       | 3/8                  | 1.00                    | 0.85                    | 0.98 | 0.13 | 2.83 | Black              | P45                    | 13                    | 45                 | 1 1/16                  | 10             |
| LCD2/0-12H-X  |                       | 1/2                  | 1.75                    | 0.85                    | 0.98 | 0.13 | 3.99 | Black              | P45                    | 13                    | 45                 | 1 1/16                  | 10             |
| LCD3/0-14BH-X | 3/0 AWG               | 1/4                  | 0.75                    | 0.96                    | 1.14 | 0.13 | 2.65 | Orange             | P50                    | 14                    | 50                 | 1 3/16                  | 10             |
| LCD3/0-56DH-X |                       | 5/16                 | 1.00                    | 0.96                    | 1.14 | 0.13 | 2.90 | Orange             | P50                    | 14                    | 50                 | 1 3/16                  | 10             |
| LCD3/0-38DH-X |                       | 3/8                  | 1.00                    | 0.96                    | 1.14 | 0.13 | 2.96 | Orange             | P50                    | 14                    | 50                 | 1 3/16                  | 10             |
| LCD3/0-12H-X  | 4/0 AWG               | 1/2                  | 1.75                    | 0.96                    | 1.14 | 0.13 | 4.12 | Orange             | P50                    | 14                    | 50                 | 1 3/16                  | 10             |
| LCD4/0-14BH-X |                       | 1/4                  | 0.75                    | 1.06                    | 1.19 | 0.14 | 2.72 | Purple             | P54                    | 15                    | 54                 | 1 1/4                   | 10             |
| LCD4/0-38DH-X |                       | 3/8                  | 1.00                    | 1.06                    | 1.19 | 0.14 | 3.05 | Purple             | P54                    | 15                    | 54                 | 1 1/4                   | 10             |
| LCD4/0-12H-X  |                       | 1/2                  | 1.75                    | 1.06                    | 1.19 | 0.14 | 4.19 | Purple             | P54                    | 15                    | 54                 | 1 1/4                   | 10             |
| LCD250-38DH-X | 250 kcmil             | 3/8                  | 1.00                    | 1.17                    | 1.25 | 0.14 | 3.13 | Yellow             | P62                    | 16                    | 62                 | 1 5/16                  | 10             |
| LCD250-12H-X  |                       | 1/2                  | 1.75                    | 1.17                    | 1.25 | 0.14 | 4.27 | Yellow             | P62                    | 16                    | 62                 | 1 5/16                  | 10             |
| LCD300-38DH-X | 300 kcmil             | 3/8                  | 1.00                    | 1.17                    | 1.44 | 0.14 | 3.36 | White              | P66                    | 17                    | 66                 | 1 1/2                   | 10             |
| LCD300-12H-X  |                       | 1/2                  | 1.75                    | 1.17                    | 1.44 | 0.14 | 4.54 | White              | P66                    | 17                    | 66                 | 1 1/2                   | 10             |
| LCD350-14BH-X | 350 kcmil             | 1/4                  | 0.75                    | 1.28                    | 1.44 | 0.17 | 2.92 | Red                | P71                    | 18                    | 71                 | 1 1/2                   | 10             |
| LCD350-38DH-X |                       | 3/8                  | 1.00                    | 1.28                    | 1.44 | 0.17 | 3.40 | Red                | P71                    | 18                    | 71                 | 1 1/2                   | 10             |
| LCD350-12EH-X |                       | 1/2                  | 1.25                    | 1.28                    | 1.44 | 0.17 | 3.95 | Red                | P71                    | 18                    | 71                 | 1 1/2                   | 10             |
| LCD350-12H-X  |                       | 1/2                  | 1.75                    | 1.28                    | 1.44 | 0.17 | 4.58 | Red                | P71                    | 18                    | 71                 | 1 1/2                   | 10             |
| LCD400-38DH-6 | 400 kcmil             | 3/8                  | 1.00                    | 1.39                    | 1.50 | 0.18 | 3.50 | Blue               | P76                    | 19                    | 76                 | 1 9/16                  | 6              |
| LCD400-12H-6  |                       | 1/2                  | 1.75                    | 1.39                    | 1.50 | 0.18 | 4.68 | Blue               | P76                    | 19                    | 76                 | 1 9/16                  | 6              |
| LCD500-14BH-6 | 500 kcmil             | 1/4                  | 0.75                    | 1.54                    | 1.75 | 0.22 | 3.27 | Brown              | P87                    | 20                    | 87                 | 1 13/16                 | 6              |
| LCD500-38DH-6 |                       | 3/8                  | 1.00                    | 1.54                    | 1.75 | 0.22 | 3.75 | Brown              | P87                    | 20                    | 87                 | 1 13/16                 | 6              |
| LCD500-12EH-6 |                       | 1/2                  | 1.25                    | 1.54                    | 1.75 | 0.22 | 4.30 | Brown              | P87                    | 20                    | 87                 | 1 13/16                 | 6              |
| LCD500-12H-6  |                       | 1/2                  | 1.75                    | 1.54                    | 1.75 | 0.22 | 4.93 | Brown              | P87                    | 20                    | 87                 | 1 13/16                 | 6              |
| LCD600-38DH-6 | 600 kcmil             | 3/8                  | 1.00                    | 1.70                    | 1.75 | 0.26 | 3.81 | Green              | P94                    | 22                    | 94                 | 1 13/16                 | 6              |
| LCD600-12H-6  |                       | 1/2                  | 1.75                    | 1.70                    | 1.75 | 0.26 | 4.99 | Green              | P94                    | 22                    | 94                 | 1 13/16                 | 6              |

‡See pages D3.58 – D3.61 for tool and die information.

\*Not tested to NEBS Level 3 requirements.

\*\*Consult cable manufacturer for voltage stress relief instructions with applications greater than 2000 V.

◆NEMA hole sizes and spacing.



## Code Conductor, Two-Hole, Standard Barrel with Window Lug, 90° Angle

For Use with Stranded Copper Conductors

### Type LCD-F

- Color-coded barrels marked with Panduit and specified competitor die index numbers for proper crimp die selection
- Inspection window to visually assure full conductor insertion
- Tin-plated to inhibit corrosion
- UL Listed and CSA Certified to 35 KV\*\* and temperature rated to 90°C when crimped with Panduit and specified competitor crimping tools and dies

- UL Listed and CSA Certified for wide wire range-taking capability when crimped with Panduit® Uni-Die™ Dieless Crimping Tools‡
- **Tested by Telcordia – meets NEBS Level 3**
- American Bureau of Shipping approved
- Available with NEMA hole sizes and spacing

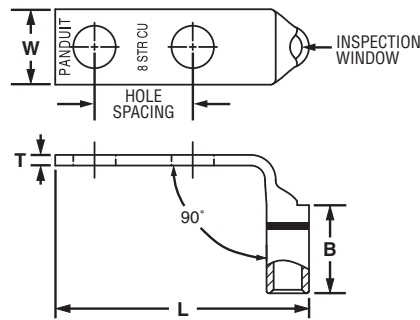

| Part Number   | Copper Conductor Size       | Stud Hole Size (In.) | Stud Hole Spacing (In.) | Figure Dimensions (In.) |      |      |      | Panduit Color Code | Panduit Die Index No.‡ | Burndy Die Index No.‡ | T&B Die Index No.‡ | Wire Strip Length (In.) | Std. Pkg. Qty. |
|---------------|-----------------------------|----------------------|-------------------------|-------------------------|------|------|------|--------------------|------------------------|-----------------------|--------------------|-------------------------|----------------|
|               |                             |                      |                         | W                       | B    | T    | L    |                    |                        |                       |                    |                         |                |
| LCD10-10AF-L* | #14 – #10 AWG STR,          | #10                  | 0.63                    | 0.38                    | 0.38 | 0.06 | 1.47 | —                  | —                      | —                     | —                  | 7/16                    | 50             |
| LCD10-14AF-L* | #12 – #10 AWG SOL           | 1/4                  | 0.63                    | 0.42                    | 0.38 | 0.05 | 1.56 | —                  | —                      | —                     | —                  | 7/16                    | 50             |
| LCD10-38DF-L* |                             | 3/8                  | 1.00                    | 0.56                    | 0.38 | 0.04 | 2.16 | —                  | —                      | —                     | —                  | 7/16                    | 50             |
| LCD8-10AF-L   | #8 AWG                      | #10                  | 0.63                    | 0.41                    | 0.56 | 0.08 | 1.53 | Red                | P21                    | 49                    | 21                 | 5/8                     | 50             |
| LCD8-14AF-L   |                             | 1/4                  | 0.63                    | 0.48                    | 0.56 | 0.07 | 1.62 | Red                | P21                    | 49                    | 21                 | 5/8                     | 50             |
| LCD8-14BF-L   |                             | 1/4                  | 0.75                    | 0.48                    | 0.56 | 0.07 | 1.74 | Red                | P21                    | 49                    | 21                 | 5/8                     | 50             |
| LCD8-14DF-L   |                             | 1/4                  | 1.00                    | 0.48                    | 0.56 | 0.07 | 1.99 | Red                | P21                    | 49                    | 21                 | 5/8                     | 50             |
| LCD8-38DF-L   |                             | 3/8                  | 1.00                    | 0.63                    | 0.56 | 0.05 | 2.21 | Red                | P21                    | 49                    | 21                 | 5/8                     | 50             |
| LCD6-10AF-L   | #6 AWG                      | #10                  | 0.63                    | 0.46                    | 0.81 | 0.08 | 1.57 | Blue               | P24                    | 7                     | 24                 | 7/8                     | 50             |
| LCD6-10BF-L   |                             | #10                  | 0.75                    | 0.46                    | 0.81 | 0.08 | 1.69 | Blue               | P24                    | 7                     | 24                 | 7/8                     | 50             |
| LCD6-10DF-L   |                             | #10                  | 1.00                    | 0.46                    | 0.81 | 0.08 | 1.94 | Blue               | P24                    | 7                     | 24                 | 7/8                     | 50             |
| LCD6-14AF-L   |                             | 1/4                  | 0.63                    | 0.48                    | 0.81 | 0.08 | 1.66 | Blue               | P24                    | 7                     | 24                 | 7/8                     | 50             |
| LCD6-14BF-L   |                             | 1/4                  | 0.75                    | 0.48                    | 0.81 | 0.08 | 1.78 | Blue               | P24                    | 7                     | 24                 | 7/8                     | 50             |
| LCD6-14DF-L   |                             | 1/4                  | 1.00                    | 0.48                    | 0.81 | 0.08 | 2.03 | Blue               | P24                    | 7                     | 24                 | 7/8                     | 50             |
| LCD6-56DF-L   |                             | 5/16                 | 1.00                    | 0.56                    | 0.81 | 0.07 | 2.15 | Blue               | P24                    | 7                     | 24                 | 7/8                     | 50             |
| LCD6-38DF-L   |                             | 3/8                  | 1.00                    | 0.62                    | 0.81 | 0.06 | 2.25 | Blue               | P24                    | 7                     | 24                 | 7/8                     | 50             |
| LCD4-10AF-L   | #4 – #3 AWG STR, #2 AWG SOL | #10                  | 0.63                    | 0.55                    | 0.81 | 0.09 | 1.65 | Gray               | P29                    | 8                     | 29                 | 7/8                     | 50             |
| LCD4-10BF-L   |                             | #10                  | 0.75                    | 0.55                    | 0.81 | 0.09 | 1.78 | Gray               | P29                    | 8                     | 29                 | 7/8                     | 50             |
| LCD4-14AF-L   |                             | 1/4                  | 0.63                    | 0.55                    | 0.81 | 0.09 | 1.74 | Gray               | P29                    | 8                     | 29                 | 7/8                     | 50             |
| LCD4-14BF-L   |                             | 1/4                  | 0.75                    | 0.55                    | 0.81 | 0.09 | 1.87 | Gray               | P29                    | 8                     | 29                 | 7/8                     | 50             |
| LCD4-14DF-L   |                             | 1/4                  | 1.00                    | 0.55                    | 0.81 | 0.09 | 2.12 | Gray               | P29                    | 8                     | 29                 | 7/8                     | 50             |
| LCD4-38DF-L   |                             |                      | 3/8                     | 1.00                    | 0.62 | 0.81 | 0.08 | 2.34               | Gray                   | P29                   | 8                  | 29                      | 7/8            |

‡See pages D3.58 – D3.61 for tool and die information.

\*Not tested to NEBS Level 3 requirements.

\*\*Consult cable manufacturer for voltage stress relief instructions with applications greater than 2000 V.

Table continues on page D2.36

A. System Overview

B1. Cable Ties

B2. Cable Accessories

B3. Stainless Steel Ties

C1. Wiring Duct

C2. Surface Raceway

C3. Abrasion Protection

C4. Cable Management

D1. Terminals

D2. Power Connectors

D3. Grounding Connectors

E1. Labeling Systems

E2. Labels

E3. Pre-Printed & Write-On Markers

E4. Permanent Identification

E5. Lockout/Tagout & Safety Solutions

F. Index



## Code Conductor, Two-Hole, Standard Barrel with Window Lug, 90° Angle (continued)

| Part Number          | Copper Conductor Size | Stud Hole Size (In.) | Stud Hole Spacing (In.) | Figure Dimensions (In.) |      |      |      | Panduit Color Code | Panduit Die Index No.‡ | Burndy Die Index No.‡ | T&B Die Index No.‡ | Wire Strip Length (In.) | Std. Pkg. Qty. |    |
|----------------------|-----------------------|----------------------|-------------------------|-------------------------|------|------|------|--------------------|------------------------|-----------------------|--------------------|-------------------------|----------------|----|
|                      |                       |                      |                         | W                       | B    | T    | L    |                    |                        |                       |                    |                         |                |    |
| <b>LCD2-14AF-Q</b>   | #2 AWG                | 1/4                  | 0.63                    | 0.60                    | 0.88 | 0.10 | 1.86 | Brown              | P33                    | 10                    | 33                 | 15/16                   | 25             |    |
| LCD2-14BF-Q          |                       | 1/4                  | 0.75                    | 0.60                    | 0.88 | 0.10 | 1.99 | Brown              | P33                    | 10                    | 33                 | 15/16                   | 25             |    |
| LCD2-14DF-Q          |                       | 1/4                  | 1.00                    | 0.60                    | 0.88 | 0.10 | 2.24 | Brown              | P33                    | 10                    | 33                 | 15/16                   | 25             |    |
| LCD2-56BF-Q          |                       | 5/16                 | 0.75                    | 0.66                    | 0.88 | 0.10 | 2.11 | Brown              | P33                    | 10                    | 33                 | 15/16                   | 25             |    |
| LCD2-38DF-Q          |                       | 3/8                  | 1.00                    | 0.66                    | 0.88 | 0.10 | 2.47 | Brown              | P33                    | 10                    | 33                 | 15/16                   | 25             |    |
| LCD2-12F-Q           |                       | 1/2                  | 1.75                    | 0.75                    | 0.88 | 0.08 | 3.61 | Brown              | P33                    | 10                    | 33                 | 15/16                   | 25             |    |
| LCD1-14AF-E          |                       | #1 AWG               | 1/4                     | 0.63                    | 0.70 | 0.88 | 0.11 | 1.94               | Green                  | P37                   | 11                 | 37                      | 15/16          | 20 |
| LCD1-14BF-E          | 1/4                   |                      | 0.75                    | 0.70                    | 0.88 | 0.11 | 2.06 | Green              | P37                    | 11                    | 37                 | 15/16                   | 20             |    |
| LCD1-56CF-E          | 5/16                  |                      | 0.88                    | 0.70                    | 0.88 | 0.11 | 2.31 | Green              | P37                    | 11                    | 37                 | 15/16                   | 20             |    |
| <b>LCD1-38DF-E</b>   | 3/8                   |                      | 1.00                    | 0.70                    | 0.88 | 0.11 | 2.51 | Green              | P37                    | 11                    | 37                 | 15/16                   | 20             |    |
| LCD1-12F-E           | 1/2                   |                      | 1.75                    | 0.75                    | 0.88 | 0.09 | 3.68 | Green              | P37                    | 11                    | 37                 | 15/16                   | 20             |    |
| LCD1/0-14AF-X        | 1/0 AWG               |                      | 1/4                     | 0.63                    | 0.76 | 0.94 | 0.12 | 2.08               | Pink                   | P42                   | 12                 | 42                      | 1              | 10 |
| LCD1/0-14BF-X        |                       |                      | 1/4                     | 0.75                    | 0.76 | 0.94 | 0.12 | 2.20               | Pink                   | P42                   | 12                 | 42                      | 1              | 10 |
| LCD1/0-56CF-X        |                       | 5/16                 | 0.88                    | 0.76                    | 0.94 | 0.12 | 2.38 | Pink               | P42                    | 12                    | 42                 | 1                       | 10             |    |
| LCD1/0-38DF-X        |                       | 3/8                  | 1.00                    | 0.76                    | 0.94 | 0.12 | 2.58 | Pink               | P42                    | 12                    | 42                 | 1                       | 10             |    |
| LCD1/0-12F-X         |                       | 1/2                  | 1.75                    | 0.80                    | 0.94 | 0.12 | 3.75 | Pink               | P42                    | 12                    | 42                 | 1                       | 10             |    |
| <b>LCD2/0-14AF-X</b> |                       | 2/0 AWG              | 1/4                     | 0.63                    | 0.85 | 0.98 | 0.13 | 2.22               | Black                  | P45                   | 13                 | 45                      | 1 1/16         | 10 |
| LCD2/0-14BF-X        |                       |                      | 1/4                     | 0.75                    | 0.85 | 0.98 | 0.13 | 2.34               | Black                  | P45                   | 13                 | 45                      | 1 1/16         | 10 |
| LCD2/0-56CF-X        | 5/16                  |                      | 0.88                    | 0.85                    | 0.98 | 0.13 | 2.47 | Black              | P45                    | 13                    | 45                 | 1 1/16                  | 10             |    |
| LCD2/0-38DF-X        | 3/8                   |                      | 1.00                    | 0.85                    | 0.98 | 0.13 | 2.66 | Black              | P45                    | 13                    | 45                 | 1 1/16                  | 10             |    |
| LCD2/0-12F-X         | 1/2                   |                      | 1.75                    | 0.85                    | 0.98 | 0.13 | 3.82 | Black              | P45                    | 13                    | 45                 | 1 1/16                  | 10             |    |
| LCD3/0-14BF-X        | 3/0 AWG               |                      | 1/4                     | 0.75                    | 0.96 | 1.14 | 0.13 | 2.42               | Orange                 | P50                   | 14                 | 50                      | 1 3/16         | 10 |
| LCD3/0-56DF-X        |                       |                      | 5/16                    | 1.00                    | 0.96 | 1.14 | 0.13 | 2.67               | Orange                 | P50                   | 14                 | 50                      | 1 3/16         | 10 |
| LCD3/0-38DF-X        |                       | 3/8                  | 1.00                    | 0.96                    | 1.14 | 0.13 | 2.73 | Orange             | P50                    | 14                    | 50                 | 1 3/16                  | 10             |    |
| LCD3/0-12F-X         |                       | 1/2                  | 1.75                    | 0.96                    | 1.14 | 0.13 | 3.89 | Orange             | P50                    | 14                    | 50                 | 1 3/16                  | 10             |    |
| LCD4/0-14BF-X        |                       | 4/0 AWG              | 1/4                     | 0.75                    | 1.06 | 1.19 | 0.14 | 2.50               | Purple                 | P54                   | 15                 | 54                      | 1 1/4          | 10 |
| LCD4/0-38DF-X        |                       |                      | 3/8                     | 1.00                    | 1.06 | 1.19 | 0.14 | 2.84               | Purple                 | P54                   | 15                 | 54                      | 1 1/4          | 10 |
| LCD4/0-12F-X         |                       |                      | 1/2                     | 1.75                    | 1.06 | 1.19 | 0.14 | 3.98               | Purple                 | P54                   | 15                 | 54                      | 1 1/4          | 10 |
| LCD250-38DF-X        | 250 kcmil             |                      | 3/8                     | 1.00                    | 1.17 | 1.25 | 0.14 | 2.90               | Yellow                 | P62                   | 16                 | 62                      | 1 5/16         | 10 |
| LCD250-12F-X         |                       |                      | 1/2                     | 1.75                    | 1.17 | 1.25 | 0.14 | 4.04               | Yellow                 | P62                   | 16                 | 62                      | 1 5/16         | 10 |
| LCD300-38DF-X        | 300 kcmil             |                      | 3/8                     | 1.00                    | 1.19 | 1.44 | 0.16 | 2.88               | White                  | P66                   | 17                 | 66                      | 1 1/2          | 10 |
| LCD300-12F-X         |                       |                      | 1/2                     | 1.75                    | 1.19 | 1.44 | 0.16 | 4.06               | White                  | P66                   | 17                 | 66                      | 1 1/2          | 10 |
| LCD350-14BF-X        | 350 kcmil             | 1/4                  | 0.75                    | 1.28                    | 1.44 | 0.17 | 2.46 | Red                | P71                    | 18                    | 71                 | 1 1/2                   | 10             |    |
| LCD350-38DF-X        |                       | 3/8                  | 1.00                    | 1.28                    | 1.44 | 0.17 | 2.94 | Red                | P71                    | 18                    | 71                 | 1 1/2                   | 10             |    |
| LCD350-12EF-X        |                       | 1/2                  | 1.25                    | 1.28                    | 1.44 | 0.17 | 3.49 | Red                | P71                    | 18                    | 71                 | 1 1/2                   | 10             |    |
| LCD350-12F-X         |                       | 1/2                  | 1.75                    | 1.28                    | 1.44 | 0.17 | 4.12 | Red                | P71                    | 18                    | 71                 | 1 1/2                   | 10             |    |
| LCD400-38DF-6        |                       | 400 kcmil            | 3/8                     | 1.00                    | 1.39 | 1.50 | 0.18 | 3.02               | Blue                   | P76                   | 19                 | 76                      | 1 9/16         | 6  |
| LCD400-12F-6         |                       |                      | 1/2                     | 1.75                    | 1.39 | 1.50 | 0.18 | 4.20               | Blue                   | P76                   | 19                 | 76                      | 1 9/16         | 6  |
| LCD500-14BF-6        |                       | 500 kcmil            | 1/4                     | 0.75                    | 1.54 | 1.75 | 0.22 | 2.65               | Brown                  | P87                   | 20                 | 87                      | 1 13/16        | 6  |
| LCD500-38DF-6        | 3/8                   |                      | 1.00                    | 1.54                    | 1.75 | 0.22 | 3.13 | Brown              | P87                    | 20                    | 87                 | 1 13/16                 | 6              |    |
| LCD500-12EF-6        | 1/2                   |                      | 1.25                    | 1.54                    | 1.75 | 0.22 | 3.68 | Brown              | P87                    | 20                    | 87                 | 1 13/16                 | 6              |    |
| LCD500-12F-6         | 1/2                   |                      | 1.75                    | 1.54                    | 1.75 | 0.22 | 4.31 | Brown              | P87                    | 20                    | 87                 | 1 13/16                 | 6              |    |
| LCD600-38DF-6        | 600 kcmil             |                      | 3/8                     | 1.00                    | 1.70 | 1.75 | 0.26 | 3.26               | Green                  | P94                   | 22                 | 94                      | 1 13/16        | 6  |
| LCD600-12F-6         |                       |                      | 1/2                     | 1.75                    | 1.70 | 1.75 | 0.26 | 4.44               | Green                  | P94                   | 22                 | 94                      | 1 13/16        | 6  |

‡See pages D3.58 – D3.61 for tool and die information.

\*\*Consult cable manufacturer for voltage stress relief instructions with applications greater than 2000 V.

◆NEMA hole sizes and spacing.





## Code Conductor, Two-Hole, Standard Barrel with Window, Narrow Tongue Lug

**For Use with Stranded Copper Conductors**

### Type LCDN

- Narrow tongue width for limited space applications
- Color-coded barrels marked with Panduit and specified competitor die index numbers for proper crimp die selection
- Inspection window to visually assure full conductor insertion
- Tin-plated to inhibit corrosion
- UL Listed and CSA Certified to 35 KV\*\* and temperature rated to 90°C when crimped with Panduit and specified competitor crimping tools and dies
- UL Listed and CSA Certified for wide wire range-taking capability when crimped with Panduit® Uni-Die™ Dieless Crimping Tools‡

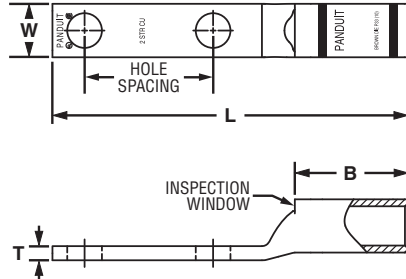

| Part Number   | Copper Conductor Size | Stud Hole Size (In.) | Stud Hole Spacing (In.) | Figure Dimensions (In.) |      |      |      | Panduit Color Code | Panduit Die Index No.‡ | Burdny Die Index No.‡ | T&B Die Index No.‡ | Wire Strip Length (In.) | Std. Pkg. Qty. |
|---------------|-----------------------|----------------------|-------------------------|-------------------------|------|------|------|--------------------|------------------------|-----------------------|--------------------|-------------------------|----------------|
|               |                       |                      |                         | W                       | B    | T    | L    |                    |                        |                       |                    |                         |                |
| LCDN2-10B-Q   | #2 AWG                | #10                  | 0.75                    | 0.42                    | 0.88 | 0.11 | 2.43 | Brown              | P33                    | 10                    | 33                 | 15/16                   | 25             |
| LCDN2-14A-Q   |                       | 1/4                  | 0.63                    | 0.42                    | 0.88 | 0.12 | 2.40 | Brown              | P33                    | 10                    | 33                 | 15/16                   | 25             |
| LCDN2-14B-Q   |                       | 1/4                  | 0.75                    | 0.42                    | 0.88 | 0.11 | 2.52 | Brown              | P33                    | 10                    | 33                 | 15/16                   | 25             |
| LCDN2-14D-Q   |                       | 1/4                  | 1.00                    | 0.42                    | 0.88 | 0.11 | 2.77 | Brown              | P33                    | 10                    | 33                 | 15/16                   | 25             |
| LCDN1-14B-E   | #1 AWG                | 1/4                  | 0.75                    | 0.47                    | 0.88 | 0.11 | 2.54 | Green              | P37                    | 11                    | 37                 | 15/16                   | 20             |
| LCDN1/0-14D-X | 1/0 AWG               | 1/4                  | 1.00                    | 0.52                    | 0.94 | 0.13 | 2.95 | Pink               | P42                    | 12                    | 42                 | 1                       | 10             |
| LCDN1/0-56D-X |                       | 5/16                 | 1.00                    | 0.52                    | 0.94 | 0.13 | 3.00 | Pink               | P42                    | 12                    | 42                 | 1                       | 10             |
| LCDN2/0-14A-X | 2/0 AWG               | 1/4                  | 0.63                    | 0.58                    | 0.98 | 0.14 | 2.71 | Black              | P45                    | 13                    | 45                 | 1 1/16                  | 10             |
| LCDN2/0-14D-X |                       | 1/4                  | 1.00                    | 0.58                    | 0.98 | 0.13 | 3.09 | Black              | P45                    | 13                    | 45                 | 1 1/16                  | 10             |
| LCDN2/0-56A-X |                       | 5/16                 | 0.63                    | 0.58                    | 0.98 | 0.13 | 2.71 | Black              | P45                    | 13                    | 45                 | 1 1/16                  | 10             |
| LCDN2/0-56D-X |                       | 5/16                 | 1.00                    | 0.58                    | 0.98 | 0.13 | 3.09 | Black              | P45                    | 13                    | 45                 | 1 1/16                  | 10             |
| LCDN350-38D-X | 350 kcmil             | 3/8                  | 1.00                    | 0.88                    | 1.44 | 0.17 | 3.79 | Red                | P71                    | 18                    | 71                 | 1 1/2                   | 10             |
| LCDN500-38D-6 | 500 kcmil             | 3/8                  | 1.00                    | 1.06                    | 1.75 | 0.22 | 4.20 | Brown              | P87                    | 20                    | 87                 | 1 13/16                 | 6              |
| LCDN500-12D-6 |                       | 1/2                  | 1.00                    | 1.06                    | 1.75 | 0.22 | 4.63 | Brown              | P87                    | 20                    | 87                 | 1 13/16                 | 6              |
| LCDN750-38D-6 | 750 kcmil             | 3/8                  | 1.00                    | 1.30                    | 1.88 | 0.26 | 4.72 | Black              | P106                   | 24                    | 106                | 1 15/16                 | 6              |

‡See pages D3.58 – D3.61 for tool and die information.

\*\*Consult cable manufacturer for voltage stress relief instructions with applications greater than 2000 V.

- A. System Overview
- B1. Cable Ties
- B2. Cable Accessories
- B3. Stainless Steel Ties
- C1. Wiring Duct
- C2. Surface Raceway
- C3. Abrasion Protection
- C4. Cable Management
- D1. Terminals
- D2. Power Connectors
- D3. Grounding Connectors
- E1. Labeling Systems
- E2. Labels
- E3. Pre-Printed & Write-On Markers
- E4. Permanent Identification
- E5. Lockout/Tagout & Safety Solutions
- F. Index

A. System Overview

**UL LISTED** Code Conductor, Two-Hole, Standard Barrel with Window, Narrow Tongue Lug, 45°

B1. Cable Ties

**For Use with Stranded Copper Conductors**

**Type LCDN-H**

- Narrow tongue width for limited space applications
- Color-coded barrels marked with Panduit and specified competitor die index numbers for proper crimp die selection
- Inspection window to visually assure full conductor insertion
- Tin-plated to inhibit corrosion

- UL Listed and CSA Certified to 35 KV\*\* and temperature rated to 90°C when crimped with Panduit and specified competitor crimping tools and dies
- UL Listed and CSA Certified for wide wire range-taking capability when crimped with Panduit® Uni-Die™ Dieless Crimping Tools‡

B2. Cable Accessories

B3. Stainless Steel Ties

C1. Wiring Duct

C2. Surface Raceway

C3. Abrasion Protection

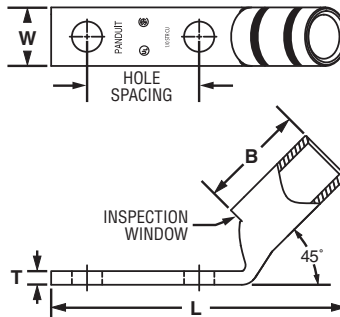

C4. Cable Management

| Part Number    | Copper Conductor Size | Stud Hole Size (In.) | Stud Hole Spacing (In.) | Figure Dimensions (In.) |      |      |      | Panduit Color Code | Panduit Die Index No.‡ | Burdny Die Index No.‡ | T&B Die Index No.‡ | Wire Strip Length (In.) | Std. Pkg. Qty. |
|----------------|-----------------------|----------------------|-------------------------|-------------------------|------|------|------|--------------------|------------------------|-----------------------|--------------------|-------------------------|----------------|
|                |                       |                      |                         | W                       | B    | T    | L    |                    |                        |                       |                    |                         |                |
| LCDN2-14AH-Q   | #2 AWG                | 1/4                  | 0.63                    | 0.42                    | 0.88 | 0.11 | 2.12 | Brown              | P33                    | 10                    | 33                 | 15/16                   | 25             |
| LCDN2-14DH-Q   | #2 AWG                | 1/4                  | 1.00                    | 0.42                    | 0.88 | 0.11 | 2.49 | Brown              | P33                    | 10                    | 33                 | 15/16                   | 25             |
| LCDN1/0-14DH-X | 1/0 AWG               | 1/4                  | 1.00                    | 0.52                    | 0.94 | 0.13 | 2.63 | Pink               | P42                    | 12                    | 42                 | 1                       | 10             |
| LCDN1/0-56DH-X | 1/0 AWG               | 5/16                 | 1.00                    | 0.52                    | 0.94 | 0.13 | 2.70 | Pink               | P42                    | 12                    | 42                 | 1                       | 10             |

‡See pages D3.58 – D3.61 for tool and die information.

\*\*Consult cable manufacturer for voltage stress relief instructions with applications greater than 2000 V.

D2. Power Connectors

D3. Grounding Connectors

E1. Labeling Systems

E2. Labels

E3. Pre-Printed & Write-On Markers

E4. Permanent Identification

E5. Lockout/Tagout & Safety Solutions

F. Index



## Code Conductor, Two-Hole, Standard Barrel with Window, Narrow Tongue Lug, 90°

**For Use with Stranded Copper Conductors**

### Type LCDN-F

- Narrow tongue width for limited space applications
- Color-coded barrels marked with Panduit and specified competitor die index numbers for proper crimp die selection
- Inspection window to visually assure full conductor insertion
- Tin-plated to inhibit corrosion

- UL Listed and CSA Certified to 35 KV\*\* and temperature rated to 90°C when crimped with Panduit and specified competitor crimping tools and dies
- UL Listed and CSA Certified for wide wire range-taking capability when crimped with Panduit® Uni-Die™ Dieless Crimping Tools‡

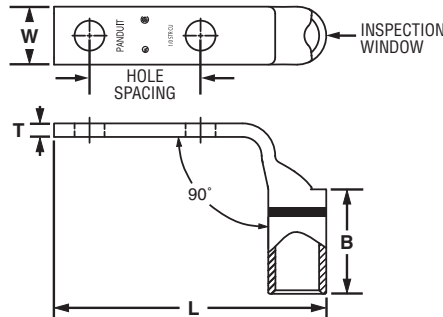

| Part Number    | Copper Conductor Size | Stud Hole Size (In.) | Stud Hole Spacing (In.) | Figure Dimensions (In.) |      |      |      | Panduit Color Code | Panduit Die Index No.‡ | Burndy Die Index No.‡ | T&B Die Index No.‡ | Wire Strip Length (In.) | Std. Pkg. Qty. |
|----------------|-----------------------|----------------------|-------------------------|-------------------------|------|------|------|--------------------|------------------------|-----------------------|--------------------|-------------------------|----------------|
|                |                       |                      |                         | W                       | B    | T    | L    |                    |                        |                       |                    |                         |                |
| LCDN2-14AF-Q   | #2 AWG                | 1/4                  | 0.63                    | 0.42                    | 0.88 | 0.11 | 1.86 | Brown              | P33                    | 10                    | 33                 | 15/16                   | 25             |
| LCDN2-14DF-Q   | #2 AWG                | 1/4                  | 1.00                    | 0.42                    | 0.88 | 0.11 | 2.24 | Brown              | P33                    | 10                    | 33                 | 15/16                   | 25             |
| LCDN1/0-14DF-X | 1/0 AWG               | 1/4                  | 1.00                    | 0.52                    | 0.94 | 0.13 | 2.45 | Pink               | P42                    | 12                    | 42                 | 1                       | 10             |
| LCDN1/0-56DF-X | 1/0 AWG               | 5/16                 | 1.00                    | 0.52                    | 0.94 | 0.13 | 2.51 | Pink               | P42                    | 12                    | 42                 | 1                       | 10             |

‡See pages D3.58 – D3.61 for tool and die information.

\*\*Consult cable manufacturer for voltage stress relief instructions with applications greater than 2000 V.

- A. System Overview
- B1. Cable Ties
- B2. Cable Accessories
- B3. Stainless Steel Ties
- C1. Wiring Duct
- C2. Surface Raceway
- C3. Abrasion Protection
- C4. Cable Management
- D1. Terminals
- D2. Power Connectors
- D3. Grounding Connectors
- E1. Labeling Systems
- E2. Labels
- E3. Pre-Printed & Write-On Markers
- E4. Permanent Identification
- E5. Lockout/Tagout & Safety Solutions
- F. Index

A. System Overview



## Code Conductor, Long Blank Tongue, Standard Barrel with Window Lug

B1. Cable Ties

### For Use with Stranded Copper Conductors

#### Type LCD-00

- Color-coded barrels marked with Panduit and specified competitor die index numbers for proper crimp die selection
- Tin-plated to inhibit corrosion
- Inspection window to visually assure full conductor insertion
- UL Recognized and CSA Certified to 35 KV\*\* and temperature rated to 90°C when crimped with Panduit and specified competitor crimping tools and dies

B2. Cable Accessories

B3. Stainless Steel Ties



C1. Wiring Duct

C2. Surface Raceway

C3. Abrasion Protection

C4. Cable Management

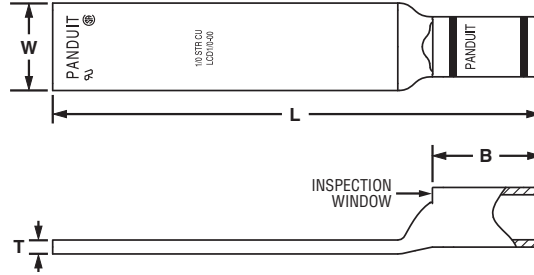

| Part Number  | Copper Conductor Size | Figure Dimensions (In.) |      |      |      | Panduit Color Code | Panduit Die Index No.‡ | Burdny Die Index No.‡ | T&B Die Index No.‡ | Wire Strip Length (In.) | Std. Pkg. Qty. |
|--------------|-----------------------|-------------------------|------|------|------|--------------------|------------------------|-----------------------|--------------------|-------------------------|----------------|
|              |                       | W                       | B    | T    | L    |                    |                        |                       |                    |                         |                |
| LCD1/0-00-X  | 1/0 AWG               | 0.76                    | 0.94 | 0.12 | 4.25 | Pink               | P42                    | 12                    | 42                 | 1                       | 10             |
| LCD2/0-00-X  | 2/0 AWG               | 0.85                    | 0.98 | 0.13 | 4.30 | Black              | P45                    | 13                    | 45                 | 1 1/16                  | 10             |
| LCD3/0-00-X  | 3/0 AWG               | 0.96                    | 1.14 | 0.13 | 4.50 | Orange             | P50                    | 14                    | 50                 | 1 3/16                  | 10             |
| LCD4/0-00-X  | 4/0 AWG               | 1.06                    | 1.19 | 0.14 | 4.58 | Purple             | P54                    | 15                    | 54                 | 1 1/4                   | 10             |
| LCD250-00-X  | 250 kcmil             | 1.17                    | 1.25 | 0.14 | 4.69 | Yellow             | P62                    | 16                    | 62                 | 1 5/16                  | 10             |
| LCD300-00-X  | 300 kcmil             | 1.19                    | 1.44 | 0.16 | 4.93 | White              | P66                    | 17                    | 66                 | 1 1/2                   | 10             |
| LCD350-00-X  | 350 kcmil             | 1.28                    | 1.44 | 0.17 | 4.97 | Red                | P71                    | 18                    | 71                 | 1 1/2                   | 10             |
| LCD400-00-6  | 400 kcmil             | 1.39                    | 1.50 | 0.18 | 5.05 | Blue               | P76                    | 19                    | 76                 | 1 9/16                  | 6              |
| LCD500-00-6  | 500 kcmil             | 1.54                    | 1.75 | 0.22 | 5.38 | Brown              | P87                    | 20                    | 87                 | 1 13/16                 | 6              |
| LCD600-00-6  | 600 kcmil             | 1.70                    | 1.75 | 0.26 | 5.43 | Green              | P94                    | 22                    | 94                 | 1 13/16                 | 6              |
| LCD750-00-6  | 750 kcmil             | 1.89                    | 1.88 | 0.26 | 5.65 | Black              | P106                   | 24                    | 106                | 1 15/16                 | 6              |
| LCD1000-00-3 | 1000 kcmil            | 2.17                    | 1.88 | 0.32 | 5.77 | White              | P125                   | 27                    | 125                | 1 15/16                 | 3              |

‡See pages D3.58 – D3.61 for tool and die information.

\*\*Consult cable manufacturer for voltage stress relief instructions with applications greater than 2000 V.

E1. Labeling Systems

E2. Labels

E3. Pre-Printed & Write-On Markers

E4. Permanent Identification

E5. Lockout/Tagout & Safety Solutions

F. Index



## Code Conductor, Two-Hole, Long Barrel Lug

For Use with Stranded Copper Conductors

### Type LCC

- Long barrel maximizes number of crimps and provides premium wire pull-out strength and electrical performance
- Color-coded barrels marked with Panduit and specified competitor die index numbers for proper crimp die selection
- Enclosed barrel prevents corrosive material from entering barrel when used in harsh environments
- Tin-plated to inhibit corrosion
- UL Listed and CSA Certified to 35 KV\*\* and temperature rated to 90°C when crimped with Panduit and specified competitor crimping tools and dies
- UL Listed and CSA Certified for wide wire range-taking capability when crimped with Panduit® Uni-Die™ Dieless Crimping Tools‡
- **Tested by Telcordia – meets NEBS Level 3**
- American Bureau of Shipping approved
- Available with NEMA hole sizes and spacing

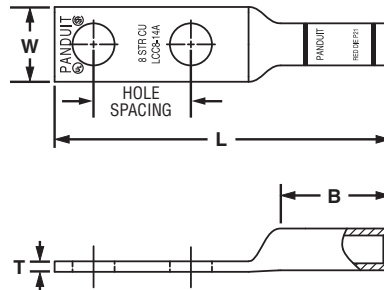

| Part Number | Copper Conductor Size       | Stud Hole Size (In.) | Stud Hole Spacing (In.) | Figure Dimensions (In.) |      |      |      | Panduit Color Code | Panduit Die Index No.‡ | Burdny Die Index No.‡ | T&B Die Index No.‡ | Wire Strip Length (In.) | Std. Pkg. Qty. |
|-------------|-----------------------------|----------------------|-------------------------|-------------------------|------|------|------|--------------------|------------------------|-----------------------|--------------------|-------------------------|----------------|
|             |                             |                      |                         | W                       | B    | T    | L    |                    |                        |                       |                    |                         |                |
| LCC8-10A-L  | #8 AWG                      | #10                  | 0.63                    | 0.41                    | 0.70 | 0.08 | 2.07 | Red                | P21                    | 49                    | 21                 | 3/4                     | 50             |
| LCC8-14A-L  |                             | 1/4                  | 0.63                    | 0.48                    | 0.70 | 0.07 | 2.16 | Red                | P21                    | 49                    | 21                 | 3/4                     | 50             |
| LCC8-14B-L  |                             | 1/4                  | 0.75                    | 0.48                    | 0.70 | 0.07 | 2.28 | Red                | P21                    | 49                    | 21                 | 3/4                     | 50             |
| LCC8-14D-L  |                             | 1/4                  | 1.00                    | 0.48                    | 0.70 | 0.07 | 2.53 | Red                | P21                    | 49                    | 21                 | 3/4                     | 50             |
| LCC8-38D-L  |                             | 3/8                  | 1.00                    | 0.60                    | 0.70 | 0.05 | 2.75 | Red                | P21                    | 49                    | 21                 | 3/4                     | 50             |
| LCC6-10A-L  | #6 AWG                      | #10                  | 0.63                    | 0.46                    | 1.07 | 0.08 | 2.47 | Blue               | P24                    | 7                     | 24                 | 1 1/8                   | 50             |
| LCC6-14A-L  |                             | 1/4                  | 0.63                    | 0.48                    | 1.07 | 0.08 | 2.56 | Blue               | P24                    | 7                     | 24                 | 1 1/8                   | 50             |
| LCC6-14B-L  |                             | 1/4                  | 0.75                    | 0.48                    | 1.07 | 0.08 | 2.68 | Blue               | P24                    | 7                     | 24                 | 1 1/8                   | 50             |
| LCC6-14D-L  |                             | 1/4                  | 1.00                    | 0.48                    | 1.07 | 0.08 | 2.93 | Blue               | P24                    | 7                     | 24                 | 1 1/8                   | 50             |
| LCC6-38D-L  |                             | 3/8                  | 1.00                    | 0.62                    | 1.07 | 0.06 | 3.15 | Blue               | P24                    | 7                     | 24                 | 1 1/8                   | 50             |
| LCC6-12-L   |                             | 1/2                  | 1.75                    | 0.75                    | 1.07 | 0.07 | 4.04 | Blue               | P24                    | 7                     | 24                 | 1 1/8                   | 50             |
| LCC4-14A-L  | #4 – #3 AWG STR, #2 AWG SOL | 1/4                  | 0.63                    | 0.55                    | 1.05 | 0.09 | 2.58 | Gray               | P29                    | 8                     | 29                 | 1 1/8                   | 50             |
| LCC4-14B-L  |                             | 1/4                  | 0.75                    | 0.55                    | 1.05 | 0.09 | 2.70 | Gray               | P29                    | 8                     | 29                 | 1 1/8                   | 50             |
| LCC4-38D-L  |                             | 3/8                  | 1.00                    | 0.62                    | 1.05 | 0.08 | 3.17 | Gray               | P29                    | 8                     | 29                 | 1 1/8                   | 50             |
| LCC4-12-L   |                             | 1/2                  | 1.75                    | 0.75                    | 1.05 | 0.07 | 4.09 | Gray               | P29                    | 8                     | 29                 | 1 1/8                   | 50             |
| LCC2-14A-Q  | #2 AWG                      | 1/4                  | 0.63                    | 0.60                    | 1.16 | 0.10 | 2.77 | Brown              | P33                    | 10                    | 33                 | 1 1/4                   | 25             |
| LCC2-14B-Q  |                             | 1/4                  | 0.75                    | 0.60                    | 1.16 | 0.10 | 2.89 | Brown              | P33                    | 10                    | 33                 | 1 1/4                   | 25             |
| LCC2-56B-Q  |                             | 5/16                 | 0.75                    | 0.66                    | 1.16 | 0.10 | 3.02 | Brown              | P33                    | 10                    | 33                 | 1 1/4                   | 25             |
| LCC2-56C-Q  |                             | 5/16                 | 0.88                    | 0.66                    | 1.16 | 0.10 | 3.14 | Brown              | P33                    | 10                    | 33                 | 1 1/4                   | 25             |
| LCC2-38D-Q  |                             | 3/8                  | 1.00                    | 0.66                    | 1.16 | 0.10 | 3.34 | Brown              | P33                    | 10                    | 33                 | 1 1/4                   | 25             |
| LCC2-38-Q   |                             | 3/8                  | 1.75                    | 0.66                    | 1.16 | 0.10 | 4.09 | Brown              | P33                    | 10                    | 33                 | 1 1/4                   | 25             |
| LCC2-12-Q   |                             | 1/2                  | 1.75                    | 0.75                    | 1.16 | 0.08 | 4.51 | Brown              | P33                    | 10                    | 33                 | 1 1/4                   | 25             |
| LCC1-14A-E  |                             | #1 AWG               | 1/4                     | 0.63                    | 0.70 | 1.36 | 0.11 | 3.00               | Green                  | P37                   | 11                 | 37                      | 1 7/16         |
| LCC1-14B-E  | 1/4                         |                      | 0.75                    | 0.70                    | 1.36 | 0.11 | 3.12 | Green              | P37                    | 11                    | 37                 | 1 7/16                  | 20             |
| LCC1-56B-E  | 5/16                        |                      | 0.75                    | 0.70                    | 1.36 | 0.11 | 3.25 | Green              | P37                    | 11                    | 37                 | 1 7/16                  | 20             |
| LCC1-56C-E  | 5/16                        |                      | 0.88                    | 0.70                    | 1.36 | 0.11 | 3.37 | Green              | P37                    | 11                    | 37                 | 1 7/16                  | 20             |
| LCC1-38D-E  | 3/8                         |                      | 1.00                    | 0.70                    | 1.36 | 0.11 | 3.57 | Green              | P37                    | 11                    | 37                 | 1 7/16                  | 20             |
| LCC1-12-E   | 1/2                         |                      | 1.75                    | 0.75                    | 1.36 | 0.09 | 4.74 | Green              | P37                    | 11                    | 37                 | 1 7/16                  | 20             |

‡See pages D3.62 – D3.65 for tool and die information.

\*\*Consult cable manufacturer for voltage stress relief instructions with applications greater than 2000 V.

◆NEMA hole sizes and spacing.

Table continues on page D2.42

A. System Overview

B1. Cable Ties

B2. Cable Accessories

B3. Stainless Steel Ties

C1. Wiring Duct

C2. Surface Raceway

C3. Abrasion Protection

C4. Cable Management

D1. Terminals

D2. Power Connectors

D3. Grounding Connectors

E1. Labeling Systems

E2. Labels

E3. Pre-Printed & Write-On Markers

E4. Permanent Identification

E5. Lockout/Tagout & Safety Solutions

F. Index

A. System Overview

B1. Cable Ties

B2. Cable Accessories

B3. Stainless Steel Ties

C1. Wiring Duct

C2. Surface Raceway

C3. Abrasion Protection

C4. Cable Management

D1. Terminals

D2. Power Connectors

D3. Grounding Connectors

E1. Labeling Systems

E2. Labels

E3. Pre-Printed & Write-On Markers

E4. Permanent Identification

E5. Lockout/Tagout & Safety Solutions

F. Index



## Code Conductor, Two-Hole, Long Barrel Lug (continued)

| Part Number         | Copper Conductor Size | Stud Hole Size (In.) | Stud Hole Spacing (In.) | Figure Dimensions (In.) |      |      |      | Panduit Color Code | Panduit Die Index No.‡ | Burndy Die Index No.‡ | T&B Die Index No.‡ | Wire Strip Length (In.) | Std. Pkg. Qty. |    |
|---------------------|-----------------------|----------------------|-------------------------|-------------------------|------|------|------|--------------------|------------------------|-----------------------|--------------------|-------------------------|----------------|----|
|                     |                       |                      |                         | W                       | B    | T    | L    |                    |                        |                       |                    |                         |                |    |
| LCC1/0-14A-X        | 1/0 AWG               | 1/4                  | 0.63                    | 0.76                    | 1.44 | 0.12 | 3.18 | Pink               | P42                    | 12                    | 42                 | 1 1/2                   | 10             |    |
| LCC1/0-14B-X        |                       | 1/4                  | 0.75                    | 0.76                    | 1.44 | 0.12 | 3.31 | Pink               | P42                    | 12                    | 42                 | 1 1/2                   | 10             |    |
| LCC1/0-56C-X        |                       | 5/16                 | 0.88                    | 0.76                    | 1.44 | 0.12 | 3.49 | Pink               | P42                    | 12                    | 42                 | 1 1/2                   | 10             |    |
| LCC1/0-56D-X        |                       | 5/16                 | 1.00                    | 0.76                    | 1.44 | 0.12 | 3.61 | Pink               | P42                    | 12                    | 42                 | 1 1/2                   | 10             |    |
| <b>LCC1/0-38D-X</b> |                       | 3/8                  | 1.00                    | 0.76                    | 1.44 | 0.12 | 3.69 | Pink               | P42                    | 12                    | 42                 | 1 1/2                   | 10             |    |
| LCC1/0-12D-X        |                       | 1/2                  | 1.00                    | 0.80                    | 1.44 | 0.12 | 3.95 | Pink               | P42                    | 12                    | 42                 | 1 1/2                   | 10             |    |
| LCC1/0-12-X         |                       | 1/2                  | 1.75                    | 0.80                    | 1.44 | 0.12 | 4.86 | Pink               | P42                    | 12                    | 42                 | 1 1/2                   | 10             |    |
| LCC2/0-14A-X        |                       | 2/0 AWG              | 1/4                     | 0.63                    | 0.85 | 1.50 | 0.13 | 3.38               | Black                  | P45                   | 13                 | 45                      | 1 9/16         | 10 |
| LCC2/0-14B-X        |                       |                      | 1/4                     | 0.75                    | 0.85 | 1.50 | 0.13 | 3.51               | Black                  | P45                   | 13                 | 45                      | 1 9/16         | 10 |
| LCC2/0-56D-X        |                       |                      | 5/16                    | 1.00                    | 0.85 | 1.50 | 0.13 | 3.76               | Black                  | P45                   | 13                 | 45                      | 1 9/16         | 10 |
| LCC2/0-38D-X        | 3/8                   |                      | 1.00                    | 0.85                    | 1.50 | 0.13 | 3.82 | Black              | P45                    | 13                    | 45                 | 1 9/16                  | 10             |    |
| LCC2/0-12D-X        | 1/2                   |                      | 1.00                    | 0.85                    | 1.50 | 0.13 | 4.07 | Black              | P45                    | 13                    | 45                 | 1 9/16                  | 10             |    |
| LCC2/0-12-X         | 1/2                   |                      | 1.75                    | 0.85                    | 1.50 | 0.13 | 4.98 | Black              | P45                    | 13                    | 45                 | 1 9/16                  | 10             |    |
| LCC3/0-14B-X        | 3/0 AWG               |                      | 1/4                     | 0.75                    | 0.96 | 1.50 | 0.13 | 3.56               | Orange                 | P50                   | 14                 | 50                      | 1 9/16         | 10 |
| LCC3/0-38D-X        |                       |                      | 3/8                     | 1.00                    | 0.96 | 1.50 | 0.13 | 3.87               | Orange                 | P50                   | 14                 | 50                      | 1 9/16         | 10 |
| LCC3/0-12D-X        |                       |                      | 1/2                     | 1.00                    | 0.96 | 1.50 | 0.13 | 4.12               | Orange                 | P50                   | 14                 | 50                      | 1 9/16         | 10 |
| LCC3/0-12-X         |                       |                      | 1/2                     | 1.75                    | 0.96 | 1.50 | 0.13 | 5.03               | Orange                 | P50                   | 14                 | 50                      | 1 9/16         | 10 |
| LCC4/0-14B-X        |                       | 4/0 AWG              | 1/4                     | 0.75                    | 1.06 | 1.56 | 0.14 | 3.66               | Purple                 | P54                   | 15                 | 54                      | 1 5/8          | 10 |
| LCC4/0-56D-X        | 5/16                  |                      | 1.00                    | 1.06                    | 1.56 | 0.14 | 3.92 | Purple             | P54                    | 15                    | 54                 | 1 5/8                   | 10             |    |
| LCC4/0-38D-X        | 3/8                   |                      | 1.00                    | 1.06                    | 1.56 | 0.14 | 3.99 | Purple             | P54                    | 15                    | 54                 | 1 5/8                   | 10             |    |
| LCC4/0-38-X         | 3/8                   |                      | 1.75                    | 1.06                    | 1.56 | 0.14 | 4.74 | Purple             | P54                    | 15                    | 54                 | 1 5/8                   | 10             |    |
| LCC4/0-12D-X        | 1/2                   |                      | 1.00                    | 1.06                    | 1.56 | 0.14 | 4.22 | Purple             | P54                    | 15                    | 54                 | 1 5/8                   | 10             |    |
| ◆ LCC4/0-12-X       | 1/2                   |                      | 1.75                    | 1.06                    | 1.56 | 0.14 | 5.13 | Purple             | P54                    | 15                    | 54                 | 1 5/8                   | 10             |    |
| LCC250-38D-X        | 250 kcmil             |                      | 3/8                     | 1.00                    | 1.17 | 1.60 | 0.14 | 4.09               | Yellow                 | P62                   | 16                 | 62                      | 1 11/16        | 10 |
| LCC250-12D-X        |                       |                      | 1/2                     | 1.00                    | 1.17 | 1.60 | 0.14 | 4.32               | Yellow                 | P62                   | 16                 | 62                      | 1 11/16        | 10 |
| ◆ LCC250-12-X       |                       |                      | 1/2                     | 1.75                    | 1.17 | 1.60 | 0.14 | 5.23               | Yellow                 | P62                   | 16                 | 62                      | 1 11/16        | 10 |
| LCC300-38D-X        | 300 kcmil             |                      | 3/8                     | 1.00                    | 1.19 | 2.24 | 0.16 | 4.76               | White                  | P66                   | 17                 | 66                      | 2 5/16         | 10 |
| ◆ LCC300-12-X       |                       | 1/2                  | 1.75                    | 1.19                    | 2.24 | 0.16 | 5.94 | White              | P66                    | 17                    | 66                 | 2 5/16                  | 10             |    |
| LCC350-14B-X        | 350 kcmil             | 1/4                  | 0.75                    | 1.28                    | 2.24 | 0.17 | 4.33 | Red                | P71                    | 18                    | 71                 | 2 5/16                  | 10             |    |
| LCC350-38D-X        |                       | 3/8                  | 1.00                    | 1.28                    | 2.24 | 0.17 | 4.81 | Red                | P71                    | 18                    | 71                 | 2 5/16                  | 10             |    |
| ◆ LCC350-12-X       |                       | 1/2                  | 1.75                    | 1.28                    | 2.24 | 0.17 | 5.99 | Red                | P71                    | 18                    | 71                 | 2 5/16                  | 10             |    |
| LCC400-14B-6        |                       | 400 kcmil            | 1/4                     | 0.75                    | 1.39 | 2.30 | 0.18 | 4.44               | Blue                   | P76                   | 19                 | 76                      | 2 3/8          | 6  |
| LCC400-38D-6        | 3/8                   |                      | 1.00                    | 1.39                    | 2.30 | 0.18 | 4.92 | Blue               | P76                    | 19                    | 76                 | 2 3/8                   | 6              |    |
| ◆ LCC400-12-6       | 1/2                   |                      | 1.75                    | 1.39                    | 2.30 | 0.18 | 6.10 | Blue               | P76                    | 19                    | 76                 | 2 3/8                   | 6              |    |
| LCC500-14B-6        | 500 kcmil             |                      | 1/4                     | 0.75                    | 1.54 | 2.50 | 0.22 | 4.70               | Brown                  | P87                   | 20                 | 87                      | 2 9/16         | 6  |
| LCC500-38D-6        |                       | 3/8                  | 1.00                    | 1.54                    | 2.50 | 0.22 | 5.18 | Brown              | P87                    | 20                    | 87                 | 2 9/16                  | 6              |    |
| ◆ LCC500-12-6       |                       | 1/2                  | 1.75                    | 1.54                    | 2.50 | 0.22 | 6.36 | Brown              | P87                    | 20                    | 87                 | 2 9/16                  | 6              |    |
| LCC600-38D-6        | 600 kcmil             | 3/8                  | 1.00                    | 1.70                    | 2.69 | 0.26 | 5.45 | Green              | P94                    | 22                    | 94                 | 2 3/4                   | 6              |    |
| ◆ LCC600-12-6       |                       | 1/2                  | 1.75                    | 1.70                    | 2.69 | 0.26 | 6.63 | Green              | P94                    | 22                    | 94                 | 2 3/4                   | 6              |    |
| LCC750-38D-6        | 750 kcmil             | 3/8                  | 1.00                    | 1.89                    | 2.87 | 0.26 | 6.10 | Black              | P106                   | 24                    | 106                | 2 15/16                 | 6              |    |
| ◆ LCC750-12-6       |                       | 1/2                  | 1.75                    | 1.89                    | 2.87 | 0.26 | 7.04 | Black              | P106                   | 24                    | 106                | 2 15/16                 | 6              |    |
| ◆ LCC800-12-6       | 800 kcmil             | 1/2                  | 1.75                    | 1.95                    | 2.94 | 0.29 | 7.13 | Orange             | P107                   | 25                    | —                  | 3                       | 6              |    |
| LCC1000-38D-3       | 1000 kcmil            | 3/8                  | 1.00                    | 2.17                    | 3.00 | 0.32 | 6.35 | White              | P125                   | 27                    | 125                | 3 1/16                  | 3              |    |
| ◆ LCC1000-12-3      |                       | 1/2                  | 1.75                    | 2.17                    | 3.00 | 0.32 | 7.29 | White              | P125                   | 27                    | 125                | 3 1/16                  | 3              |    |

‡See pages D3.62 – D3.65 for tool and die information.

\*\*Consult cable manufacturer for voltage stress relief instructions with applications greater than 2000 V.

◆NEMA hole sizes and spacing.





## Code Conductor, Two-Hole, Long Barrel Lug, 45° Angle

For Use with Stranded Copper Conductors

### Type LCC-H

- Long barrel maximizes number of crimps and provides premium wire pull-out strength and electrical performance
- Color-coded barrels marked with Panduit and specified competitor die index numbers for proper crimp die selection
- Enclosed barrel prevents corrosive material from entering barrel when used in harsh environments
- Tin-plated to inhibit corrosion

- UL Listed and CSA Certified to 35 KV\*\* and temperature rated to 90°C when crimped with Panduit and specified competitor crimping tools and dies
- UL Listed and CSA Certified for wide wire range-taking capability when crimped with Panduit® Uni-Die™ Dieless Crimping Tools‡
- **Tested by Telcordia – meets NEBS Level 3**
- American Bureau of Shipping approved
- Available with NEMA hole sizes and spacing



| Part Number | Copper Conductor Size       | Stud Hole Size (In.) | Stud Hole Spacing (In.) | Figure Dimensions (In.) |      |      |      | Panduit Color Code | Panduit Die Index No.‡ | Burndy Die Index No.‡ | T&B Die Index No.‡ | Wire Strip Length (In.) | Std. Pkg. Qty. |
|-------------|-----------------------------|----------------------|-------------------------|-------------------------|------|------|------|--------------------|------------------------|-----------------------|--------------------|-------------------------|----------------|
|             |                             |                      |                         | W                       | B    | T    | L    |                    |                        |                       |                    |                         |                |
| LCC8-10AH-L | #8 AWG                      | #10                  | 0.63                    | 0.41                    | 0.70 | 0.08 | 1.86 | Red                | P21                    | 49                    | 21                 | 3/4                     | 50             |
| LCC8-14AH-L |                             | 1/4                  | 0.63                    | 0.48                    | 0.70 | 0.07 | 1.94 | Red                | P21                    | 49                    | 21                 | 3/4                     | 50             |
| LCC8-14BH-L |                             | 1/4                  | 0.75                    | 0.48                    | 0.70 | 0.07 | 2.06 | Red                | P21                    | 49                    | 21                 | 3/4                     | 50             |
| LCC8-14DH-L |                             | 1/4                  | 1.00                    | 0.48                    | 0.70 | 0.07 | 2.31 | Red                | P21                    | 49                    | 21                 | 3/4                     | 50             |
| LCC8-38DH-L |                             | 3/8                  | 1.00                    | 0.60                    | 0.70 | 0.05 | 2.52 | Red                | P21                    | 49                    | 21                 | 3/4                     | 50             |
| LCC6-10AH-L | #6 AWG                      | #10                  | 0.63                    | 0.46                    | 1.07 | 0.08 | 2.14 | Blue               | P24                    | 7                     | 24                 | 1 1/8                   | 50             |
| LCC6-14AH-L |                             | 1/4                  | 0.63                    | 0.48                    | 1.07 | 0.08 | 2.23 | Blue               | P24                    | 7                     | 24                 | 1 1/8                   | 50             |
| LCC6-14BH-L |                             | 1/4                  | 0.75                    | 0.48                    | 1.07 | 0.08 | 2.35 | Blue               | P24                    | 7                     | 24                 | 1 1/8                   | 50             |
| LCC6-14DH-L |                             | 1/4                  | 1.00                    | 0.48                    | 1.07 | 0.08 | 2.60 | Blue               | P24                    | 7                     | 24                 | 1 1/8                   | 50             |
| LCC6-38DH-L |                             | 3/8                  | 1.00                    | 0.62                    | 1.07 | 0.06 | 2.81 | Blue               | P24                    | 7                     | 24                 | 1 1/8                   | 50             |
| LCC4-14AH-L | #4 – #3 AWG STR, #2 AWG SOL | 1/4                  | 0.63                    | 0.55                    | 1.05 | 0.09 | 2.26 | Gray               | P29                    | 8                     | 29                 | 1 1/8                   | 50             |
| LCC4-14BH-L |                             | 1/4                  | 0.75                    | 0.55                    | 1.05 | 0.09 | 2.38 | Gray               | P29                    | 8                     | 29                 | 1 1/8                   | 50             |
| LCC4-38DH-L |                             | 3/8                  | 1.00                    | 0.62                    | 1.05 | 0.08 | 2.84 | Gray               | P29                    | 8                     | 29                 | 1 1/8                   | 50             |
| LCC2-14AH-Q | #2 AWG                      | 1/4                  | 0.63                    | 0.60                    | 1.16 | 0.10 | 2.38 | Brown              | P33                    | 10                    | 33                 | 1 1/4                   | 25             |
| LCC2-14BH-Q |                             | 1/4                  | 0.75                    | 0.60                    | 1.16 | 0.10 | 2.50 | Brown              | P33                    | 10                    | 33                 | 1 1/4                   | 25             |
| LCC2-56BH-Q |                             | 5/16                 | 0.75                    | 0.66                    | 1.16 | 0.10 | 2.62 | Brown              | P33                    | 10                    | 33                 | 1 1/4                   | 25             |
| LCC2-56CH-Q |                             | 5/16                 | 0.88                    | 0.66                    | 1.16 | 0.10 | 2.75 | Brown              | P33                    | 10                    | 33                 | 1 1/4                   | 25             |
| LCC2-38DH-Q |                             | 3/8                  | 1.00                    | 0.66                    | 1.16 | 0.10 | 2.95 | Brown              | P33                    | 10                    | 33                 | 1 1/4                   | 25             |
| LCC2-38H-Q  |                             | 3/8                  | 1.75                    | 0.66                    | 1.16 | 0.10 | 3.70 | Brown              | P33                    | 10                    | 33                 | 1 1/4                   | 25             |
| LCC2-12H-Q  |                             | 1/2                  | 1.75                    | 0.75                    | 1.16 | 0.08 | 4.10 | Brown              | P33                    | 10                    | 33                 | 1 1/4                   | 25             |

‡See pages D3.62 – D3.65 for tool and die information.

\*\*Consult cable manufacturer for voltage stress relief instructions with applications greater than 2000 V.

◆NEMA hole sizes and spacing.

Table continues on page D2.44

A. System Overview

B1. Cable Ties

B2. Cable Accessories

B3. Stainless Steel Ties

C1. Wiring Duct

C2. Surface Raceway

C3. Abrasion Protection

C4. Cable Management

D1. Terminals

D2. Power Connectors

D3. Grounding Connectors

E1. Labeling Systems

E2. Labels

E3. Pre-Printed & Write-On Markers

E4. Permanent Identification

E5. Lockout/Tagout & Safety Solutions

F. Index

A. System Overview

B1. Cable Ties

B2. Cable Accessories

B3. Stainless Steel Ties

C1. Wiring Duct

C2. Surface Raceway

C3. Abrasion Protection

C4. Cable Management

D1. Terminals

D2. Power Connectors

D3. Grounding Connectors

E1. Labeling Systems

E2. Labels

E3. Pre-Printed & Write-On Markers

E4. Permanent Identification

E5. Lockout/Tagout & Safety Solutions

F. Index



## Code Conductor, Two-Hole, Long Barrel Lug, 45° Angle (continued)

| Part Number   | Copper Conductor Size | Stud Hole Size (In.) | Stud Hole Spacing (In.) | Figure Dimensions (In.) |      |      |      | Panduit Color Code | Panduit Die Index No.‡ | Burndy Die Index No.‡ | T&B Die Index No.‡ | Wire Strip Length (In.) | Std. Pkg. Qty. |
|---------------|-----------------------|----------------------|-------------------------|-------------------------|------|------|------|--------------------|------------------------|-----------------------|--------------------|-------------------------|----------------|
|               |                       |                      |                         | W                       | B    | T    | L    |                    |                        |                       |                    |                         |                |
| LCC1-14AH-E   | #1 AWG                | 1/4                  | 0.63                    | 0.70                    | 1.36 | 0.11 | 2.53 | Green              | P37                    | 11                    | 37                 | 1 7/16                  | 20             |
| LCC1-14BH-E   |                       | 1/4                  | 0.75                    | 0.70                    | 1.36 | 0.11 | 2.66 | Green              | P37                    | 11                    | 37                 | 1 7/16                  | 20             |
| LCC1-56BH-E   |                       | 5/16                 | 0.75                    | 0.70                    | 1.36 | 0.11 | 2.78 | Green              | P37                    | 11                    | 37                 | 1 7/16                  | 20             |
| LCC1-56CH-E   |                       | 5/16                 | 0.88                    | 0.70                    | 1.36 | 0.11 | 2.91 | Green              | P37                    | 11                    | 37                 | 1 7/16                  | 20             |
| LCC1-38DH-E   |                       | 3/8                  | 1.00                    | 0.70                    | 1.36 | 0.11 | 3.11 | Green              | P37                    | 11                    | 37                 | 1 7/16                  | 20             |
| LCC1-12H-E    |                       | 1/2                  | 1.75                    | 0.75                    | 1.36 | 0.09 | 4.27 | Green              | P37                    | 11                    | 37                 | 1 7/16                  | 20             |
| LCC1/0-14AH-X |                       | 1/0 AWG              | 1/4                     | 0.63                    | 0.76 | 1.44 | 0.12 | 2.69               | Pink                   | P42                   | 12                 | 42                      | 1 1/2          |
| LCC1/0-14BH-X | 1/4                   |                      | 0.75                    | 0.76                    | 1.44 | 0.12 | 2.81 | Pink               | P42                    | 12                    | 42                 | 1 1/2                   | 10             |
| LCC1/0-56CH-X | 5/16                  |                      | 0.88                    | 0.76                    | 1.44 | 0.12 | 2.99 | Pink               | P42                    | 12                    | 42                 | 1 1/2                   | 10             |
| LCC1/0-56DH-X | 5/16                  |                      | 1.00                    | 0.76                    | 1.44 | 0.12 | 3.12 | Pink               | P42                    | 12                    | 42                 | 1 1/2                   | 10             |
| LCC1/0-38DH-X | 3/8                   |                      | 1.00                    | 0.76                    | 1.44 | 0.12 | 3.19 | Pink               | P42                    | 12                    | 42                 | 1 1/2                   | 10             |
| LCC1/0-12DH-X | 1/2                   |                      | 1.00                    | 0.80                    | 1.44 | 0.12 | 3.46 | Pink               | P42                    | 12                    | 42                 | 1 1/2                   | 10             |
| LCC1/0-12H-X  | 1/2                   |                      | 1.75                    | 0.80                    | 1.44 | 0.12 | 4.36 | Pink               | P42                    | 12                    | 42                 | 1 1/2                   | 10             |
| LCC2/0-14AH-X | 2/0 AWG               | 1/4                  | 0.63                    | 0.85                    | 1.50 | 0.13 | 2.87 | Black              | P45                    | 13                    | 45                 | 1 9/16                  | 10             |
| LCC2/0-14BH-X |                       | 1/4                  | 0.75                    | 0.85                    | 1.50 | 0.13 | 2.99 | Black              | P45                    | 13                    | 45                 | 1 9/16                  | 10             |
| LCC2/0-56DH-X |                       | 5/16                 | 1.00                    | 0.85                    | 1.50 | 0.13 | 3.24 | Black              | P45                    | 13                    | 45                 | 1 9/16                  | 10             |
| LCC2/0-38DH-X |                       | 3/8                  | 1.00                    | 0.85                    | 1.50 | 0.13 | 3.31 | Black              | P45                    | 13                    | 45                 | 1 9/16                  | 10             |
| LCC2/0-12DH-X |                       | 1/2                  | 1.00                    | 0.85                    | 1.50 | 0.13 | 3.56 | Black              | P45                    | 13                    | 45                 | 1 9/16                  | 10             |
| LCC2/0-12H-X  |                       | 1/2                  | 1.75                    | 0.85                    | 1.50 | 0.13 | 4.47 | Black              | P45                    | 13                    | 45                 | 1 9/16                  | 10             |
| LCC3/0-14BH-X |                       | 3/0 AWG              | 1/4                     | 0.75                    | 0.96 | 1.50 | 0.13 | 3.02               | Orange                 | P50                   | 14                 | 50                      | 1 9/16         |
| LCC3/0-38DH-X | 3/8                   |                      | 1.00                    | 0.96                    | 1.50 | 0.13 | 3.33 | Orange             | P50                    | 14                    | 50                 | 1 9/16                  | 10             |
| LCC3/0-12DH-X | 1/2                   |                      | 1.00                    | 0.96                    | 1.50 | 0.13 | 3.58 | Orange             | P50                    | 14                    | 50                 | 1 9/16                  | 10             |
| LCC3/0-12H-X  | 1/2                   |                      | 1.75                    | 0.96                    | 1.50 | 0.13 | 4.50 | Orange             | P50                    | 14                    | 50                 | 1 9/16                  | 10             |
| LCC4/0-14BH-X | 4/0 AWG               | 1/4                  | 0.75                    | 1.06                    | 1.56 | 0.14 | 3.11 | Purple             | P54                    | 15                    | 54                 | 1 5/8                   | 10             |
| LCC4/0-56DH-X |                       | 5/16                 | 1.00                    | 1.06                    | 1.56 | 0.14 | 3.37 | Purple             | P54                    | 15                    | 54                 | 1 5/8                   | 10             |
| LCC4/0-38DH-X |                       | 3/8                  | 1.00                    | 1.06                    | 1.56 | 0.14 | 3.44 | Purple             | P54                    | 15                    | 54                 | 1 5/8                   | 10             |
| LCC4/0-38H-X  |                       | 3/8                  | 1.75                    | 1.06                    | 1.56 | 0.14 | 4.19 | Purple             | P54                    | 15                    | 54                 | 1 5/8                   | 10             |
| LCC4/0-12DH-X |                       | 1/2                  | 1.00                    | 1.06                    | 1.56 | 0.14 | 3.67 | Purple             | P54                    | 15                    | 54                 | 1 5/8                   | 10             |
| LCC4/0-12H-X  |                       | 1/2                  | 1.75                    | 1.06                    | 1.56 | 0.14 | 4.58 | Purple             | P54                    | 15                    | 54                 | 1 5/8                   | 10             |
| LCC250-38DH-X |                       | 250 kcmil            | 3/8                     | 1.00                    | 1.17 | 1.61 | 0.14 | 3.51               | Yellow                 | P62                   | 16                 | 62                      | 1 11/16        |
| LCC250-12DH-X | 1/2                   |                      | 1.00                    | 1.17                    | 1.61 | 0.14 | 3.74 | Yellow             | P62                    | 16                    | 62                 | 1 11/16                 | 10             |
| LCC250-12H-X  | 1/2                   |                      | 1.75                    | 1.17                    | 1.61 | 0.14 | 4.65 | Yellow             | P62                    | 16                    | 62                 | 1 11/16                 | 10             |
| LCC300-38DH-X | 300 kcmil             | 3/8                  | 1.00                    | 1.19                    | 2.24 | 0.16 | 4.05 | White              | P66                    | 17                    | 66                 | 2 5/16                  | 10             |
| LCC300-12H-X  |                       | 1/2                  | 1.75                    | 1.19                    | 2.24 | 0.16 | 5.23 | White              | P66                    | 17                    | 66                 | 2 5/16                  | 10             |
| LCC350-14BH-X | 350 kcmil             | 1/4                  | 0.75                    | 1.28                    | 2.24 | 0.17 | 3.61 | Red                | P71                    | 18                    | 71                 | 2 5/16                  | 10             |
| LCC350-38DH-X |                       | 3/8                  | 1.00                    | 1.28                    | 2.24 | 0.17 | 4.09 | Red                | P71                    | 18                    | 71                 | 2 5/16                  | 10             |
| LCC350-12H-X  |                       | 1/2                  | 1.75                    | 1.28                    | 2.24 | 0.17 | 5.27 | Red                | P71                    | 18                    | 71                 | 2 5/16                  | 10             |
| LCC400-14BH-6 | 400 kcmil             | 1/4                  | 0.75                    | 1.39                    | 2.30 | 0.18 | 3.70 | Blue               | P76                    | 19                    | 76                 | 2 3/8                   | 6              |
| LCC400-38DH-6 |                       | 3/8                  | 1.00                    | 1.39                    | 2.30 | 0.18 | 4.18 | Blue               | P76                    | 19                    | 76                 | 2 3/8                   | 6              |
| LCC400-12H-6  |                       | 1/2                  | 1.75                    | 1.39                    | 2.30 | 0.18 | 5.36 | Blue               | P76                    | 19                    | 76                 | 2 3/8                   | 6              |
| LCC500-14BH-6 | 500 kcmil             | 1/4                  | 0.75                    | 1.54                    | 2.50 | 0.22 | 3.91 | Brown              | P87                    | 20                    | 87                 | 2 9/16                  | 6              |
| LCC500-38DH-6 |                       | 3/8                  | 1.00                    | 1.54                    | 2.50 | 0.22 | 4.39 | Brown              | P87                    | 20                    | 87                 | 2 9/16                  | 6              |
| LCC500-12H-6  |                       | 1/2                  | 1.75                    | 1.54                    | 2.50 | 0.22 | 5.57 | Brown              | P87                    | 20                    | 87                 | 2 9/16                  | 6              |
| LCC600-38DH-6 | 600 kcmil             | 3/8                  | 1.00                    | 1.70                    | 2.69 | 0.26 | 4.61 | Green              | P94                    | 22                    | 94                 | 2 3/4                   | 6              |
| LCC600-12H-6  |                       | 1/2                  | 1.75                    | 1.70                    | 2.69 | 0.26 | 5.79 | Green              | P94                    | 22                    | 94                 | 2 3/4                   | 6              |

‡See pages D3.62 – D3.65 for tool and die information.

\*\*Consult cable manufacturer for voltage stress relief instructions with applications greater than 2000 V.

◆NEMA hole sizes and spacing.



## Code Conductor, Two-Hole, Long Barrel Lug, 90° Angle

For Use with Stranded Copper Conductors

### Type LCC-F

- Long barrel maximizes number of crimps and provides premium wire pull-out strength and electrical performance
- Color-coded barrels marked with Panduit and specified competitor die index numbers for proper crimp die selection
- Enclosed barrel prevents corrosive material from entering barrel when used in harsh environments
- Tin-plated to inhibit corrosion

- UL Listed and CSA Certified to 35 KV\*\* and temperature rated to 90°C when crimped with Panduit and specified competitor crimping tools and dies
- UL Listed and CSA Certified for wide wire range-taking capability when crimped with Panduit® Uni-Die™ Dieless Crimping Tools‡
- **Tested by Telcordia – meets NEBS Level 3**
- American Bureau of Shipping approved
- Available with NEMA hole sizes and spacing



| Part Number | Copper Conductor Size       | Stud Hole Size (In.) | Stud Hole Spacing (In.) | Figure Dimensions (In.) |      |      |      | Panduit Color Code | Panduit Die Index No.‡ | Burdly Die Index No.‡ | T&B Die Index No.‡ | Wire Strip Length (In.) | Std. Pkg. Qty. |
|-------------|-----------------------------|----------------------|-------------------------|-------------------------|------|------|------|--------------------|------------------------|-----------------------|--------------------|-------------------------|----------------|
|             |                             |                      |                         | W                       | B    | T    | L    |                    |                        |                       |                    |                         |                |
| LCC8-10AF-L | #8 AWG                      | #10                  | 0.63                    | 0.41                    | 0.70 | 0.08 | 1.53 | Red                | P21                    | 49                    | 21                 | 3/4                     | 50             |
| LCC8-14AF-L |                             | 1/4                  | 0.63                    | 0.48                    | 0.70 | 0.07 | 1.62 | Red                | P21                    | 49                    | 21                 | 3/4                     | 50             |
| LCC8-14BF-L |                             | 1/4                  | 0.75                    | 0.48                    | 0.70 | 0.07 | 1.74 | Red                | P21                    | 49                    | 21                 | 3/4                     | 50             |
| LCC8-14DF-L |                             | 1/4                  | 1.00                    | 0.48                    | 0.70 | 0.07 | 1.99 | Red                | P21                    | 49                    | 21                 | 3/4                     | 50             |
| LCC8-38DF-L |                             | 3/8                  | 1.00                    | 0.60                    | 0.70 | 0.05 | 2.21 | Red                | P21                    | 49                    | 21                 | 3/4                     | 50             |
| LCC6-10AF-L | #6 AWG                      | #10                  | 0.63                    | 0.46                    | 1.07 | 0.08 | 1.57 | Blue               | P24                    | 7                     | 24                 | 1 1/8                   | 50             |
| LCC6-14AF-L |                             | 1/4                  | 0.63                    | 0.48                    | 1.07 | 0.08 | 1.66 | Blue               | P24                    | 7                     | 24                 | 1 1/8                   | 50             |
| LCC6-14BF-L |                             | 1/4                  | 0.75                    | 0.48                    | 1.07 | 0.08 | 1.78 | Blue               | P24                    | 7                     | 24                 | 1 1/8                   | 50             |
| LCC6-14DF-L |                             | 1/4                  | 1.00                    | 0.48                    | 1.07 | 0.08 | 2.03 | Blue               | P24                    | 7                     | 24                 | 1 1/8                   | 50             |
| LCC6-38DF-L |                             | 3/8                  | 1.00                    | 0.62                    | 1.07 | 0.05 | 2.25 | Blue               | P24                    | 7                     | 24                 | 1 1/8                   | 50             |
| LCC4-14AF-L | #4 – #3 AWG STR, #2 AWG SOL | 1/4                  | 0.63                    | 0.55                    | 1.05 | 0.09 | 1.74 | Gray               | P29                    | 8                     | 29                 | 1 1/8                   | 50             |
| LCC4-14BF-L |                             | 1/4                  | 0.75                    | 0.55                    | 1.05 | 0.09 | 1.87 | Gray               | P29                    | 8                     | 29                 | 1 1/8                   | 50             |
| LCC4-38DF-L |                             | 3/8                  | 1.00                    | 0.62                    | 1.05 | 0.08 | 2.34 | Gray               | P29                    | 8                     | 29                 | 1 1/8                   | 50             |
| LCC2-14AF-Q | #2 AWG                      | 1/4                  | 0.63                    | 0.60                    | 1.16 | 0.10 | 1.86 | Brown              | P33                    | 10                    | 33                 | 1 1/4                   | 25             |
| LCC2-14BF-Q |                             | 1/4                  | 0.75                    | 0.60                    | 1.16 | 0.10 | 1.99 | Brown              | P33                    | 10                    | 33                 | 1 1/4                   | 25             |
| LCC2-56BF-Q |                             | 5/16                 | 0.75                    | 0.66                    | 1.16 | 0.10 | 2.11 | Brown              | P33                    | 10                    | 33                 | 1 1/4                   | 25             |
| LCC2-56CF-Q |                             | 5/16                 | 0.88                    | 0.66                    | 1.16 | 0.10 | 2.24 | Brown              | P33                    | 10                    | 33                 | 1 1/4                   | 25             |
| LCC2-38DF-Q |                             | 3/8                  | 1.00                    | 0.66                    | 1.16 | 0.10 | 2.44 | Brown              | P33                    | 10                    | 33                 | 1 1/4                   | 25             |
| LCC2-38F-Q  |                             | 3/8                  | 1.75                    | 0.66                    | 1.16 | 0.10 | 3.19 | Brown              | P33                    | 10                    | 33                 | 1 1/4                   | 25             |
| LCC2-12F-Q  |                             | 1/2                  | 1.75                    | 0.75                    | 1.16 | 0.08 | 3.61 | Brown              | P33                    | 10                    | 33                 | 1 1/4                   | 25             |

‡See pages D3.62 – D3.65 for tool and die information.

\*\*Consult cable manufacturer for voltage stress relief instructions with applications greater than 2000 V.

◆NEMA hole sizes and spacing.

Table continues on page D2.46



## Code Conductor, Two-Hole, Long Barrel Lug, 90° Angle (continued)

- A. System Overview
- B1. Cable Ties
- B2. Cable Accessories
- B3. Stainless Steel Ties
- C1. Wiring Duct
- C2. Surface Raceway
- C3. Abrasion Protection
- C4. Cable Management
- D1. Terminals
- D2. Power Connectors
- D3. Grounding Connectors
- E1. Labeling Systems
- E2. Labels
- E3. Pre-Printed & Write-On Markers
- E4. Permanent Identification
- E5. Lockout/Tagout & Safety Solutions
- F. Index

| Part Number   | Copper Conductor Size | Stud Hole Size (In.) | Stud Hole Spacing (In.) | Figure Dimensions (In.) |      |      |      | Panduit Color Code | Panduit Die Index No.‡ | Burndy Die Index No.‡ | T&B Die Index No.‡ | Wire Strip Length (In.) | Std. Pkg. Qty. |
|---------------|-----------------------|----------------------|-------------------------|-------------------------|------|------|------|--------------------|------------------------|-----------------------|--------------------|-------------------------|----------------|
|               |                       |                      |                         | W                       | B    | T    | L    |                    |                        |                       |                    |                         |                |
| LCC1-14AF-E   | #1 AWG                | 1/4                  | 0.63                    | 0.70                    | 1.36 | 0.11 | 1.94 | Green              | P37                    | 11                    | 37                 | 1 7/16                  | 20             |
| LCC1-14BF-E   |                       | 1/4                  | 0.75                    | 0.70                    | 1.36 | 0.11 | 2.06 | Green              | P37                    | 11                    | 37                 | 1 7/16                  | 20             |
| LCC1-56BF-E   |                       | 5/16                 | 0.75                    | 0.70                    | 1.36 | 0.11 | 2.19 | Green              | P37                    | 11                    | 37                 | 1 7/16                  | 20             |
| LCC1-56CF-E   |                       | 5/16                 | 0.88                    | 0.70                    | 1.36 | 0.11 | 2.31 | Green              | P37                    | 11                    | 37                 | 1 7/16                  | 20             |
| LCC1-38DF-E   |                       | 3/8                  | 1.00                    | 0.70                    | 1.36 | 0.11 | 2.51 | Green              | P37                    | 11                    | 37                 | 1 7/16                  | 20             |
| LCC1-12F-E    |                       | 1/2                  | 1.75                    | 0.75                    | 1.36 | 0.09 | 3.68 | Green              | P37                    | 11                    | 37                 | 1 7/16                  | 20             |
| LCC1/0-14AF-X |                       | 1/4                  | 0.63                    | 0.76                    | 1.44 | 0.12 | 2.08 | Pink               | P42                    | 12                    | 42                 | 1 1/2                   | 10             |
| LCC1/0-14BF-X |                       | 1/4                  | 0.75                    | 0.76                    | 1.44 | 0.12 | 2.20 | Pink               | P42                    | 12                    | 42                 | 1 1/2                   | 10             |
| LCC1/0-56CF-X |                       | 5/16                 | 0.88                    | 0.76                    | 1.44 | 0.12 | 2.38 | Pink               | P42                    | 12                    | 42                 | 1 1/2                   | 10             |
| LCC1/0-56DF-X |                       | 5/16                 | 1.00                    | 0.76                    | 1.44 | 0.12 | 2.51 | Pink               | P42                    | 12                    | 42                 | 1 1/2                   | 10             |
| LCC1/0-38DF-X | 1/0 AWG               | 3/8                  | 1.00                    | 0.76                    | 1.44 | 0.12 | 2.58 | Pink               | P42                    | 12                    | 42                 | 1 1/2                   | 10             |
| LCC1/0-12DF-X |                       | 1/2                  | 1.00                    | 0.80                    | 1.44 | 0.12 | 2.85 | Pink               | P42                    | 12                    | 42                 | 1 1/2                   | 10             |
| LCC1/0-12F-X  |                       | 1/2                  | 1.75                    | 0.80                    | 1.44 | 0.12 | 3.75 | Pink               | P42                    | 12                    | 42                 | 1 1/2                   | 10             |
| LCC2/0-14AF-X |                       | 1/4                  | 0.63                    | 0.85                    | 1.50 | 0.13 | 2.22 | Black              | P45                    | 13                    | 45                 | 1 9/16                  | 10             |
| LCC2/0-14BF-X | 2/0 AWG               | 1/4                  | 0.75                    | 0.85                    | 1.50 | 0.13 | 2.34 | Black              | P45                    | 13                    | 45                 | 1 9/16                  | 10             |
| LCC2/0-56DF-X |                       | 5/16                 | 1.00                    | 0.85                    | 1.50 | 0.13 | 2.59 | Black              | P45                    | 13                    | 45                 | 1 9/16                  | 10             |
| LCC2/0-38DF-X |                       | 3/8                  | 1.00                    | 0.85                    | 1.50 | 0.13 | 2.66 | Black              | P45                    | 13                    | 45                 | 1 9/16                  | 10             |
| LCC2/0-12DF-X |                       | 1/2                  | 1.00                    | 0.85                    | 1.50 | 0.13 | 2.85 | Black              | P45                    | 13                    | 45                 | 1 9/16                  | 10             |
| LCC2/0-12F-X  |                       | 1/2                  | 1.75                    | 0.85                    | 1.50 | 0.13 | 3.82 | Black              | P45                    | 13                    | 45                 | 1 9/16                  | 10             |
| LCC3/0-14BF-X |                       | 3/0 AWG              | 1/4                     | 0.75                    | 0.96 | 1.50 | 0.13 | 2.42               | Orange                 | P50                   | 14                 | 50                      | 1 9/16         |
| LCC3/0-38DF-X | 3/8                   |                      | 1.00                    | 0.96                    | 1.50 | 0.13 | 2.73 | Orange             | P50                    | 14                    | 50                 | 1 9/16                  | 10             |
| LCC3/0-12DF-X | 1/2                   |                      | 1.00                    | 0.96                    | 1.50 | 0.13 | 2.98 | Orange             | P50                    | 14                    | 50                 | 1 9/16                  | 10             |
| LCC3/0-12F-X  | 1/2                   |                      | 1.75                    | 0.96                    | 1.50 | 0.13 | 3.89 | Orange             | P50                    | 14                    | 50                 | 1 9/16                  | 10             |
| LCC4/0-14BF-X | 4/0 AWG               | 1/4                  | 0.75                    | 1.06                    | 1.56 | 0.14 | 2.50 | Purple             | P54                    | 15                    | 54                 | 1 5/8                   | 10             |
| LCC4/0-56DF-X |                       | 5/16                 | 1.00                    | 1.06                    | 1.56 | 0.14 | 2.77 | Purple             | P54                    | 15                    | 54                 | 1 5/8                   | 10             |
| LCC4/0-38DF-X |                       | 3/8                  | 1.00                    | 1.06                    | 1.56 | 0.14 | 2.84 | Purple             | P54                    | 15                    | 54                 | 1 5/8                   | 10             |
| LCC4/0-38F-X  |                       | 3/8                  | 1.75                    | 1.06                    | 1.56 | 0.14 | 3.59 | Purple             | P54                    | 15                    | 54                 | 1 5/8                   | 10             |
| LCC4/0-12DF-X |                       | 1/2                  | 1.00                    | 1.06                    | 1.56 | 0.14 | 3.07 | Purple             | P54                    | 15                    | 54                 | 1 5/8                   | 10             |
| LCC4/0-12F-X  |                       | 1/2                  | 1.75                    | 1.06                    | 1.56 | 0.14 | 3.98 | Purple             | P54                    | 15                    | 54                 | 1 5/8                   | 10             |
| LCC250-38DF-X | 250 kcmil             | 3/8                  | 1.00                    | 1.17                    | 1.61 | 0.14 | 2.90 | Yellow             | P62                    | 16                    | 62                 | 1 11/16                 | 10             |
| LCC250-12DF-X |                       | 1/2                  | 1.00                    | 1.17                    | 1.61 | 0.14 | 3.13 | Yellow             | P62                    | 16                    | 62                 | 1 11/16                 | 10             |
| LCC250-12F-X  | 300 kcmil             | 1/2                  | 1.75                    | 1.17                    | 1.61 | 0.14 | 4.04 | Yellow             | P62                    | 16                    | 62                 | 1 11/16                 | 10             |
| LCC300-38DF-X |                       | 3/8                  | 1.00                    | 1.19                    | 2.24 | 0.16 | 2.88 | White              | P66                    | 17                    | 66                 | 2 5/16                  | 10             |
| LCC300-12F-X  | 350 kcmil             | 1/2                  | 1.75                    | 1.19                    | 2.24 | 0.16 | 4.06 | White              | P66                    | 17                    | 66                 | 2 5/16                  | 10             |
| LCC350-14BF-X |                       | 1/4                  | 0.75                    | 1.28                    | 2.24 | 0.17 | 2.46 | Red                | P71                    | 18                    | 71                 | 2 5/16                  | 10             |
| LCC350-38DF-X | 400 kcmil             | 3/8                  | 1.00                    | 1.28                    | 2.24 | 0.17 | 2.94 | Red                | P71                    | 18                    | 71                 | 2 5/16                  | 10             |
| LCC350-12F-X  |                       | 1/2                  | 1.75                    | 1.28                    | 2.24 | 0.17 | 4.12 | Red                | P71                    | 18                    | 71                 | 2 5/16                  | 10             |
| LCC400-14BF-6 | 500 kcmil             | 1/4                  | 0.75                    | 1.39                    | 2.30 | 0.18 | 2.54 | Blue               | P76                    | 19                    | 76                 | 2 3/8                   | 6              |
| LCC400-38DF-6 |                       | 3/8                  | 1.00                    | 1.39                    | 2.30 | 0.18 | 3.02 | Blue               | P76                    | 19                    | 76                 | 2 3/8                   | 6              |
| LCC400-12F-6  | 600 kcmil             | 1/2                  | 1.75                    | 1.39                    | 2.30 | 0.18 | 4.20 | Blue               | P76                    | 19                    | 76                 | 2 3/8                   | 6              |
| LCC500-14BF-6 |                       | 1/4                  | 0.75                    | 1.54                    | 2.50 | 0.22 | 2.65 | Brown              | P87                    | 20                    | 87                 | 2 9/16                  | 6              |
| LCC500-38DF-6 | 600 kcmil             | 3/8                  | 1.00                    | 1.54                    | 2.50 | 0.22 | 3.13 | Brown              | P87                    | 20                    | 87                 | 2 9/16                  | 6              |
| LCC500-12F-6  |                       | 1/2                  | 1.75                    | 1.54                    | 2.50 | 0.22 | 4.31 | Brown              | P87                    | 20                    | 87                 | 2 9/16                  | 6              |
| LCC600-38DF-6 | 600 kcmil             | 3/8                  | 1.00                    | 1.70                    | 2.69 | 0.26 | 3.26 | Green              | P94                    | 22                    | 94                 | 2 3/4                   | 6              |
| LCC600-12F-6  |                       | 1/2                  | 1.75                    | 1.70                    | 2.69 | 0.26 | 4.44 | Green              | P94                    | 22                    | 94                 | 2 3/4                   | 6              |

‡See pages D3.62 – D3.65 for tool and die information.

\*\*Consult cable manufacturer for voltage stress relief instructions with applications greater than 2000 V.

◆NEMA hole sizes and spacing.



## Code Conductor, Two-Hole, Long Barrel with Window Lug

For Use with Stranded Copper Conductors

### Type LCC-W

- Long barrel maximizes number of crimps and provides premium wire pull-out strength and electrical performance
- Inspection window to visually assure full conductor insertion
- Color-coded barrels marked with Panduit and specified competitor die index numbers for proper crimp die selection
- Tin-plated to inhibit corrosion
- UL Listed and CSA Certified to 35 KV\*\* and temperature rated to 90°C when crimped with Panduit and specified competitor crimping tools and dies
- UL Listed and CSA Certified for wide wire range-taking capability when crimped with Panduit® Uni-Die™ Dieless Crimping Tools‡
- **Tested by Telcordia – meets NEBS Level 3**
- Meets J-STD-607-A and TIA-942 requirements for network systems grounding applications
- Available with NEMA hole sizes and spacing



Figure 1



Figure 2: Slotted

| Part Number    | Figure No. | Copper Conductor Size              | Stud Hole Size (In.) | Stud Hole Spacing (In.) | Figure Dimensions (In.) |      |      |      | Panduit Color Code | Panduit Die Index No.‡ | Burdny Die Index No.‡ | T&B Die Index No.‡ | Wire Strip Length (In.) | Std. Pkg. Qty. |
|----------------|------------|------------------------------------|----------------------|-------------------------|-------------------------|------|------|------|--------------------|------------------------|-----------------------|--------------------|-------------------------|----------------|
|                |            |                                    |                      |                         | W                       | B    | T    | L    |                    |                        |                       |                    |                         |                |
| LCC10-14JAW-L* | 2          | #14 – 10 AWG STR, #12 – 10 AWG SOL | 1/4                  | .50 – .63               | .42                     | .53  | .05  | 1.93 | —                  | —                      | —                     | —                  | 9/16                    | 50             |
| LCC10-14AW-L*  | 1          |                                    | 1/4                  | .63                     | .42                     | .53  | .05  | 1.93 | —                  | —                      | —                     | —                  | 9/16                    | 50             |
| LCC10-14BW-L*  | 1          |                                    | 1/4                  | .75                     | .42                     | .53  | .05  | 2.06 | —                  | —                      | —                     | —                  | 9/16                    | 50             |
| LCC8-10AW-L    | 1          | #8 AWG                             | #10                  | .63                     | .41                     | .70  | .08  | 2.01 | Red                | P21                    | 49                    | 21                 | 3/4                     | 50             |
| LCC8-10BW-L    | 1          |                                    | #10                  | .75                     | .41                     | .70  | .08  | 2.14 | Red                | P21                    | 49                    | 21                 | 3/4                     | 50             |
| LCC8-10ABW-L   | 2          |                                    | #10                  | .63 – .75               | .41                     | .70  | .08  | 2.14 | Red                | P21                    | 49                    | 21                 | 3/4                     | 50             |
| LCC8-14AW-L    | 1          |                                    | 1/4                  | .63                     | .48                     | .70  | .07  | 2.10 | Red                | P21                    | 49                    | 21                 | 3/4                     | 50             |
| LCC8-14BW-L    | 1          |                                    | 1/4                  | .75                     | .48                     | .70  | .07  | 2.23 | Red                | P21                    | 49                    | 21                 | 3/4                     | 50             |
| LCC8-14ABW-L   | 2          |                                    | 1/4                  | .63 – .75               | .48                     | .70  | .07  | 2.23 | Red                | P21                    | 49                    | 21                 | 3/4                     | 50             |
| LCC8-14DW-L    | 1          |                                    | 1/4                  | 1.00                    | .48                     | .70  | .07  | 2.48 | Red                | P21                    | 49                    | 21                 | 3/4                     | 50             |
| LCC8-38DW-L    | 1          |                                    | 3/8                  | 1.00                    | .60                     | .70  | .05  | 2.70 | Red                | P21                    | 49                    | 21                 | 3/4                     | 50             |
| LCC6-10AW-L    | 1          |                                    | #6 AWG               | #10                     | .63                     | .46  | 1.07 | .08  | 2.40               | Blue                   | P24                   | 7                  | 24                      | 1 1/8          |
| LCC6-10BW-L    | 1          | #10                                |                      | .75                     | .46                     | 1.07 | .08  | 2.52 | Blue               | P24                    | 7                     | 24                 | 1 1/8                   | 50             |
| LCC6-10ABW-L   | 2          | #10                                |                      | .63 – .75               | .46                     | 1.07 | .08  | 2.52 | Blue               | P24                    | 7                     | 24                 | 1 1/8                   | 50             |
| LCC6-14JW-L    | 1          | 1/4                                |                      | .50                     | .48                     | 1.07 | .08  | 2.36 | Blue               | P24                    | 7                     | 24                 | 1 1/8                   | 50             |
| LCC6-14AW-L    | 1          | 1/4                                |                      | .63                     | .48                     | 1.07 | .08  | 2.49 | Blue               | P24                    | 7                     | 24                 | 1 1/8                   | 50             |
| LCC6-14JAW-L   | 2          | 1/4                                |                      | .50 – .63               | .48                     | 1.07 | .08  | 2.49 | Blue               | P24                    | 7                     | 24                 | 1 1/8                   | 50             |
| LCC6-14BW-L    | 1          | 1/4                                |                      | .75                     | .48                     | 1.07 | .08  | 2.61 | Blue               | P24                    | 7                     | 24                 | 1 1/8                   | 50             |
| LCC6-14DW-L    | 1          | 1/4                                |                      | 1.00                    | .48                     | 1.07 | .08  | 2.86 | Blue               | P24                    | 7                     | 24                 | 1 1/8                   | 50             |
| LCC6-14BDW-L   | 2          | 1/4                                |                      | .75 – 1.00              | .48                     | 1.07 | .08  | 2.86 | Blue               | P24                    | 7                     | 24                 | 1 1/8                   | 50             |
| LCC6-14EW-L    | 1          | 1/4                                |                      | 1.25                    | .48                     | 1.07 | .08  | 3.11 | Blue               | P24                    | 7                     | 24                 | 1 1/8                   | 50             |
| LCC6-14W-L     | 1          | 1/4                                |                      | 1.75                    | .48                     | 1.07 | .08  | 3.61 | Blue               | P24                    | 7                     | 24                 | 1 1/8                   | 50             |
| LCC6-56BW-L    | 1          | 5/16                               |                      | .75                     | .56                     | 1.07 | .07  | 2.73 | Blue               | P24                    | 7                     | 24                 | 1 1/8                   | 50             |
| LCC6-38BW-L    | 1          | 3/8                                |                      | .75                     | .62                     | 1.07 | .06  | 2.83 | Blue               | P24                    | 7                     | 24                 | 1 1/8                   | 50             |
| LCC6-38CW-L    | 1          | 3/8                                |                      | .88                     | .62                     | 1.07 | .06  | 2.96 | Blue               | P24                    | 7                     | 24                 | 1 1/8                   | 50             |
| LCC6-38DW-L    | 1          | 3/8                                |                      | 1.00                    | .62                     | 1.07 | .06  | 3.08 | Blue               | P24                    | 7                     | 24                 | 1 1/8                   | 50             |
| LCC6-38BDW-L   | 2          | 3/8                                |                      | .75 – 1.00              | .62                     | 1.07 | .06  | 3.08 | Blue               | P24                    | 7                     | 24                 | 1 1/8                   | 50             |
| LCC6-12W-L     | 1          | 1/2                                |                      | 1.75                    | .75                     | 1.07 | 0.07 | 3.97 | Blue               | P24                    | 7                     | 24                 | 1 1/8                   | 50             |

‡See pages D3.62 – D3.65 for tool and die information.

\*Not tested to NEBS Level 3 requirements.

\*\*Consult cable manufacturer for voltage stress relief instructions with applications greater than 2000 V.

◆NEMA hole sizes and spacing.

Table continues on pages D2.48 – D2.49

A. System Overview

B1. Cable Ties

B2. Cable Accessories

B3. Stainless Steel Ties

C1. Wiring Duct

C2. Surface Raceway

C3. Abrasion Protection

C4. Cable Management

D1. Terminals

D2. Power Connectors

D3. Grounding Connectors

E1. Labeling Systems

E2. Labels

E3. Pre-Printed & Write-On Markers

E4. Permanent Identification

E5. Lockout/Tagout & Safety Solutions

F. Index



## Code Conductor, Two-Hole, Long Barrel with Window Lug (continued)

|     |                                   |
|-----|-----------------------------------|
| A.  | System Overview                   |
| B1. | Cable Ties                        |
| B2. | Cable Accessories                 |
| B3. | Stainless Steel Ties              |
| C1. | Wiring Duct                       |
| C2. | Surface Raceway                   |
| C3. | Abrasion Protection               |
| C4. | Cable Management                  |
| D1. | Terminals                         |
| D2. | Power Connectors                  |
| D3. | Grounding Connectors              |
| E1. | Labeling Systems                  |
| E2. | Labels                            |
| E3. | Pre-Printed & Write-On Markers    |
| E4. | Permanent Identification          |
| E5. | Lockout/Tagout & Safety Solutions |
| F.  | Index                             |

| Part Number   | Figure No. | Copper Conductor Size      | Stud Hole Size (In.) | Stud Hole Spacing (In.) | Figure Dimensions (In.) |      |      |       | Panduit Color Code | Panduit Die Index No.‡ | Burdndy Die Index No.‡ | T&B Die Index No.‡ | Wire Strip Length (In.) | Std. Pkg. Qty. |    |
|---------------|------------|----------------------------|----------------------|-------------------------|-------------------------|------|------|-------|--------------------|------------------------|------------------------|--------------------|-------------------------|----------------|----|
|               |            |                            |                      |                         | W                       | B    | T    | L     |                    |                        |                        |                    |                         |                |    |
| LCC4-10AW-L   | 1          | #4 – 3 AWG STR, #2 AWG SOL | #10                  | .63                     | .55                     | 1.05 | .09  | 2.40  | Gray               | P29                    | 8                      | 29                 | 1 1/8                   | 50             |    |
| LCC4-10BW-L   | 1          |                            | #10                  | .75                     | .55                     | 1.05 | .09  | 2.53  | Gray               | P29                    | 8                      | 29                 | 1 1/8                   | 50             |    |
| LCC4-14AW-L   | 1          |                            | 1/4                  | .63                     | .55                     | 1.05 | .09  | 2.50  | Gray               | P29                    | 8                      | 29                 | 1 1/8                   | 50             |    |
| LCC4-14BW-L   | 1          |                            | 1/4                  | .75                     | .55                     | 1.05 | .09  | 2.63  | Gray               | P29                    | 8                      | 29                 | 1 1/8                   | 50             |    |
| LCC4-14DW-L   | 1          |                            | 1/4                  | 1.00                    | .55                     | 1.05 | .09  | 2.63  | Gray               | P29                    | 8                      | 29                 | 1 1/8                   | 50             |    |
| LCC4-14ADW-L  | 2          |                            | 1/4                  | .63 – 1.00              | .55                     | 1.05 | .09  | 2.87  | Gray               | P29                    | 8                      | 29                 | 1 1/8                   | 50             |    |
| LCC4-38DW-L   | 1          |                            | 3/8                  | 1.00                    | .62                     | 1.05 | .08  | 3.09  | Gray               | P29                    | 8                      | 29                 | 1 1/8                   | 50             |    |
| LCC4-12W-L    | 1          |                            | 1/2                  | 1.75                    | .75                     | 1.05 | 0.07 | 4.01  | Gray               | P29                    | 8                      | 29                 | 1 1/8                   | 50             |    |
| LCC2-10AW-Q   | 1          |                            | #2 AWG               | #10                     | .63                     | .60  | 1.16 | .10   | 2.57               | Brown                  | P33                    | 10                 | 33                      | 1 1/4          | 25 |
| LCC2-10BW-Q   | 1          |                            |                      | #10                     | .75                     | .60  | 1.16 | .10   | 2.69               | Brown                  | P33                    | 10                 | 33                      | 1 1/4          | 25 |
| LCC2-14AW-Q   | 1          | 1/4                        |                      | .63                     | .60                     | 1.16 | .10  | 2.67  | Brown              | P33                    | 10                     | 33                 | 1 1/4                   | 25             |    |
| LCC2-14BW-Q   | 1          | 1/4                        |                      | .75                     | .60                     | 1.16 | .10  | 2.79  | Brown              | P33                    | 10                     | 33                 | 1 1/4                   | 25             |    |
| LCC2-14DW-Q   | 1          | 1/4                        |                      | 1.00                    | .60                     | 1.16 | .10  | 3.04  | Brown              | P33                    | 10                     | 33                 | 1 1/4                   | 25             |    |
| LCC2-56BW-Q   | 1          | 5/16                       |                      | .75                     | .66                     | 1.16 | .10  | 2.92  | Brown              | P33                    | 10                     | 33                 | 1 1/4                   | 25             |    |
| LCC2-56CW-Q   | 1          | 5/16                       |                      | .88                     | .66                     | 1.16 | .10  | 3.04  | Brown              | P33                    | 10                     | 33                 | 1 1/4                   | 25             |    |
| LCC2-38BW-Q   | 1          | 3/8                        |                      | .75                     | .66                     | 1.16 | .10  | 2.99  | Brown              | P33                    | 10                     | 33                 | 1 1/4                   | 25             |    |
| LCC2-38CW-Q   | 1          | 3/8                        |                      | .88                     | .66                     | 1.16 | .10  | 3.12  | Brown              | P33                    | 10                     | 33                 | 1 1/4                   | 25             |    |
| LCC2-38DW-Q   | 1          | 3/8                        |                      | 1.00                    | .66                     | 1.16 | .10  | 3.24  | Brown              | P33                    | 10                     | 33                 | 1 1/4                   | 25             |    |
| LCC2-38W-Q    | 1          | 3/8                        | 1.75                 | .66                     | 1.16                    | .10  | 3.99 | Brown | P33                | 10                     | 33                     | 1 1/4              | 25                      |                |    |
| LCC2-12W-Q    | 1          | 1/2                        | 1.75                 | .75                     | 1.16                    | .08  | 4.41 | Brown | P33                | 10                     | 33                     | 1 1/4              | 25                      |                |    |
| LCC1-14AW-E   | 1          | #1 AWG                     | 1/4                  | .63                     | .70                     | 1.36 | .11  | 2.89  | Green              | P37                    | 11                     | 37                 | 1 7/16                  | 20             |    |
| LCC1-14BW-E   | 1          |                            | 1/4                  | .75                     | .70                     | 1.36 | .11  | 3.01  | Green              | P37                    | 11                     | 37                 | 1 7/16                  | 20             |    |
| LCC1-56BW-E   | 1          |                            | 5/16                 | .75                     | .70                     | 1.36 | .11  | 3.14  | Green              | P37                    | 11                     | 37                 | 1 7/16                  | 20             |    |
| LCC1-56CW-E   | 1          |                            | 5/16                 | .88                     | .70                     | 1.36 | .11  | 3.26  | Green              | P37                    | 11                     | 37                 | 1 7/16                  | 20             |    |
| LCC1-38DW-E   | 1          |                            | 3/8                  | 1.00                    | .70                     | 1.36 | .11  | 3.46  | Green              | P37                    | 11                     | 37                 | 1 7/16                  | 20             |    |
| LCC1-12W-E    | 1          |                            | 1/2                  | 1.75                    | .75                     | 1.36 | .09  | 4.63  | Green              | P37                    | 11                     | 37                 | 1 7/16                  | 20             |    |
| LCC1/0-14AW-X | 1          | 1/0 AWG                    | 1/4                  | .63                     | .76                     | 1.44 | .12  | 3.07  | Pink               | P42                    | 12                     | 42                 | 1 1/2                   | 10             |    |
| LCC1/0-14BW-X | 1          |                            | 1/4                  | .75                     | .76                     | 1.44 | .12  | 3.19  | Pink               | P42                    | 12                     | 42                 | 1 1/2                   | 10             |    |
| LCC1/0-14DW-X | 1          |                            | 1/4                  | 1.00                    | .76                     | 1.44 | .12  | 3.44  | Pink               | P42                    | 12                     | 42                 | 1 1/2                   | 10             |    |
| LCC1/0-38DW-X | 1          |                            | 3/8                  | 1.00                    | .76                     | 1.44 | .12  | 3.57  | Pink               | P42                    | 12                     | 42                 | 1 1/2                   | 10             |    |
| LCC1/0-38W-X  | 1          |                            | 3/8                  | 1.75                    | .76                     | 1.44 | .12  | 4.32  | Pink               | P42                    | 12                     | 42                 | 1 1/2                   | 10             |    |
| LCC1/0-12DW-X | 1          |                            | 1/2                  | 1.00                    | .80                     | 1.44 | .12  | 3.84  | Pink               | P42                    | 12                     | 42                 | 1 1/2                   | 10             |    |
| LCC1/0-12W-X  | 1          | 1/2                        | 1.75                 | .80                     | 1.44                    | .12  | 4.74 | Pink  | P42                | 12                     | 42                     | 1 1/2              | 10                      |                |    |
| LCC2/0-14AW-X | 1          | 2/0 AWG                    | 1/4                  | .63                     | .85                     | 1.50 | .13  | 3.23  | Black              | P45                    | 13                     | 45                 | 1 9/16                  | 10             |    |
| LCC2/0-14BW-X | 1          |                            | 1/4                  | .75                     | .85                     | 1.50 | .13  | 3.36  | Black              | P45                    | 13                     | 45                 | 1 9/16                  | 10             |    |
| LCC2/0-56DW-X | 1          |                            | 5/16                 | 1.00                    | .85                     | 1.50 | .13  | 3.61  | Black              | P45                    | 13                     | 45                 | 1 9/16                  | 10             |    |
| LCC2/0-38DW-X | 1          |                            | 3/8                  | 1.00                    | .85                     | 1.50 | .13  | 3.67  | Black              | P45                    | 13                     | 45                 | 1 9/16                  | 10             |    |
| LCC2/0-12DW-X | 1          |                            | 1/2                  | 1.00                    | .85                     | 1.50 | .13  | 3.92  | Black              | P45                    | 13                     | 45                 | 1 9/16                  | 10             |    |
| LCC2/0-12W-X  | 1          |                            | 1/2                  | 1.75                    | .85                     | 1.50 | .13  | 4.83  | Black              | P45                    | 13                     | 45                 | 1 9/16                  | 10             |    |

‡See pages D3.62 – D3.65 for tool and die information.

\*Not tested to NEBS Level 3 requirements.

\*\*Consult cable manufacturer for voltage stress relief instructions with applications greater than 2000 V.

◆NEMA hole sizes and spacing.





## Code Conductor, Two-Hole, Long Barrel with Window Lug (continued)

| Part Number     | Figure No. | Copper Conductor Size | Stud Hole Size (In.) | Stud Hole Spacing (In.) | Figure Dimensions (In.) |      |      |        | Panduit Color Code | Panduit Die Index No.‡ | Burdndy Die Index No.‡ | T&B Die Index No.‡ | Wire Strip Length (In.) | Std. Pkg. Qty. |
|-----------------|------------|-----------------------|----------------------|-------------------------|-------------------------|------|------|--------|--------------------|------------------------|------------------------|--------------------|-------------------------|----------------|
|                 |            |                       |                      |                         | W                       | B    | T    | L      |                    |                        |                        |                    |                         |                |
| LCC3/0-14BW-X   | 1          | 3/0 AWG               | 1/4                  | .75                     | .96                     | 1.50 | .13  | 3.39   | Orange             | P50                    | 14                     | 50                 | 1 9/16                  | 10             |
| LCC3/0-56DW-X   | 1          |                       | 5/16                 | 1.00                    | .96                     | 1.50 | .13  | 3.64   | Orange             | P50                    | 14                     | 50                 | 1 9/16                  | 10             |
| LCC3/0-38DW-X   | 1          |                       | 3/8                  | 1.00                    | .96                     | 1.50 | .13  | 3.70   | Orange             | P50                    | 14                     | 50                 | 1 9/16                  | 10             |
| LCC3/0-12DW-X   | 1          |                       | 1/2                  | 1.00                    | .96                     | 1.50 | .13  | 3.95   | Orange             | P50                    | 14                     | 50                 | 1 9/16                  | 10             |
| LCC3/0-12W-X    | 1          |                       | 1/2                  | 1.75                    | .96                     | 1.50 | .13  | 4.87   | Orange             | P50                    | 14                     | 50                 | 1 9/16                  | 10             |
| LCC4/0-14AW-X   | 1          | 4/0 AWG               | 1/4                  | .63                     | 1.06                    | 1.56 | .14  | 3.35   | Purple             | P54                    | 15                     | 54                 | 1 5/8                   | 10             |
| LCC4/0-14BW-X   | 1          |                       | 1/4                  | .75                     | 1.06                    | 1.56 | .14  | 3.48   | Purple             | P54                    | 15                     | 54                 | 1 5/8                   | 10             |
| LCC4/0-56DW-X   | 1          |                       | 5/16                 | 1.00                    | 1.06                    | 1.56 | .14  | 3.74   | Purple             | P54                    | 15                     | 54                 | 1 5/8                   | 10             |
| LCC4/0-38DW-X   | 1          |                       | 3/8                  | 1.00                    | 1.06                    | 1.56 | .14  | 3.81   | Purple             | P54                    | 15                     | 54                 | 1 5/8                   | 10             |
| LCC4/0-38W-X    | 1          |                       | 3/8                  | 1.75                    | 1.06                    | 1.56 | .14  | 4.56   | Purple             | P54                    | 15                     | 54                 | 1 5/8                   | 10             |
| LCC4/0-12DW-X   | 1          |                       | 1/2                  | 1.00                    | 1.06                    | 1.56 | .14  | 4.04   | Purple             | P54                    | 15                     | 54                 | 1 5/8                   | 10             |
| ◆ LCC4/0-12W-X  | 1          | 1/2                   | 1.75                 | 1.06                    | 1.56                    | .14  | 4.95 | Purple | P54                | 15                     | 54                     | 1 5/8              | 10                      |                |
| LCC250-56DW-X   | 1          | 250 kcmil             | 5/16                 | 1.00                    | 1.17                    | 1.61 | .14  | 3.82   | Yellow             | P62                    | 16                     | 62                 | 1 11/16                 | 10             |
| LCC250-38DW-X   | 1          |                       | 3/8                  | 1.00                    | 1.17                    | 1.61 | .14  | 3.89   | Yellow             | P62                    | 16                     | 62                 | 1 11/16                 | 10             |
| LCC250-12DW-X   | 1          |                       | 1/2                  | 1.00                    | 1.17                    | 1.61 | .14  | 4.12   | Yellow             | P62                    | 16                     | 62                 | 1 11/16                 | 10             |
| ◆ LCC250-12W-X  | 1          | 1/2                   | 1.75                 | 1.17                    | 1.61                    | .14  | 5.03 | Yellow | P62                | 16                     | 62                     | 1 11/16            | 10                      |                |
| LCC300-38DW-X   | 1          | 300 kcmil             | 3/8                  | 1.00                    | 1.19                    | 2.24 | .16  | 4.54   | White              | P66                    | 17                     | 66                 | 2 5/16                  | 10             |
| ◆ LCC300-12W-X  | 1          |                       | 1/2                  | 1.75                    | 1.19                    | 2.24 | .16  | 5.72   | White              | P66                    | 17                     | 66                 | 2 5/16                  | 10             |
| LCC350-14BW-X   | 1          | 350 kcmil             | 1/4                  | .75                     | 1.28                    | 2.24 | .17  | 4.10   | Red                | P71                    | 18                     | 71                 | 2 5/16                  | 10             |
| LCC350-38DW-X   | 1          |                       | 3/8                  | 1.00                    | 1.28                    | 2.24 | .17  | 4.58   | Red                | P71                    | 18                     | 71                 | 2 5/16                  | 10             |
| ◆ LCC350-12W-X  | 1          |                       | 1/2                  | 1.75                    | 1.28                    | 2.24 | .17  | 5.76   | Red                | P71                    | 18                     | 71                 | 2 5/16                  | 10             |
| LCC400-14BW-6   | 1          | 400 kcmil             | 1/4                  | .75                     | 1.39                    | 2.30 | .18  | 4.18   | Blue               | P76                    | 19                     | 76                 | 2 3/8                   | 6              |
| LCC400-38DW-6   | 1          |                       | 3/8                  | 1.00                    | 1.39                    | 2.30 | .18  | 4.66   | Blue               | P76                    | 19                     | 76                 | 2 3/8                   | 6              |
| ◆ LCC400-12W-6  | 1          |                       | 1/2                  | 1.75                    | 1.28                    | 2.30 | .17  | 5.84   | Blue               | P76                    | 19                     | 76                 | 2 3/8                   | 6              |
| LCC500-14BW-6   | 1          | 500 kcmil             | 1/4                  | .75                     | 1.54                    | 2.50 | .22  | 4.46   | Brown              | P87                    | 20                     | 87                 | 2 9/16                  | 6              |
| LCC500-38DW-6   | 1          |                       | 3/8                  | 1.00                    | 1.54                    | 2.50 | .22  | 4.94   | Brown              | P87                    | 20                     | 87                 | 2 9/16                  | 6              |
| ◆ LCC500-12W-6  | 1          |                       | 1/2                  | 1.75                    | 1.54                    | 2.50 | .22  | 6.12   | Brown              | P87                    | 20                     | 87                 | 2 9/16                  | 6              |
| LCC600-38DW-6   | 1          | 600 kcmil             | 3/8                  | 1.00                    | 1.70                    | 2.69 | .26  | 5.18   | Green              | P94                    | 22                     | 94                 | 2 3/4                   | 6              |
| ◆ LCC600-12W-6  | 1          |                       | 1/2                  | 1.75                    | 1.70                    | 2.69 | .26  | 6.36   | Green              | P94                    | 22                     | 94                 | 2 3/4                   | 6              |
| LCC750-38DW-6   | 1          | 750 kcmil             | 3/8                  | 1.00                    | 1.89                    | 2.88 | .26  | 5.71   | Black              | P106                   | 24                     | 106                | 2 15/16                 | 6              |
| ◆ LCC750-12W-6  | 1          |                       | 1/2                  | 1.75                    | 1.89                    | 2.88 | .26  | 6.65   | Black              | P106                   | 24                     | 106                | 2 15/16                 | 6              |
| ◆ LCC800-12W-6  | 1          | 800 kcmil             | 1/2                  | 1.75                    | 1.95                    | 2.94 | .30  | 6.74   | Orange             | P107                   | 25                     | 107                | 3                       | 6              |
| LCC1000-38DW-3  | 1          | 1000 kcmil            | 3/8                  | 1.00                    | 2.17                    | 3.00 | .32  | 5.95   | White              | P125                   | 27                     | 125                | 3 1/16                  | 3              |
| ◆ LCC1000-12W-3 | 1          |                       | 1/2                  | 1.75                    | 2.17                    | 3.00 | .32  | 6.89   | White              | P125                   | 27                     | 125                | 3 1/16                  | 3              |

‡See pages D3.62 – D3.65 for tool and die information.

\*Not tested to NEBS Level 3 requirements.

\*\*Consult cable manufacturer for voltage stress relief instructions with applications greater than 2000 V.

◆NEMA hole sizes and spacing.

A.  
System  
Overview

B1.  
Cable Ties

B2.  
Cable  
Accessories

B3.  
Stainless  
Steel Ties

C1.  
Wiring  
Duct

C2.  
Surface  
Raceway

C3.  
Abrasion  
Protection

C4.  
Cable  
Management

D1.  
Terminals

D2.  
Power  
Connectors

D3.  
Grounding  
Connectors

E1.  
Labeling  
Systems

E2.  
Labels

E3.  
Pre-Printed  
& Write-On  
Markers

E4.  
Permanent  
Identification

E5.  
Lockout/  
Tagout  
& Safety  
Solutions

F.  
Index

A. System Overview



## Code Conductor, Two-Hole, Long Barrel with Window Lug, 45° Angle

B1. Cable Ties

### For Use with Stranded Copper Conductors

#### Type LCC-WH

- Long barrel maximizes number of crimps and provides premium wire pull-out strength and electrical performance
- Inspection window to visually assure full conductor insertion
- Color-coded barrels marked with Panduit and specified competitor die index numbers for proper crimp die selection
- Tin-plated to inhibit corrosion
- UL Listed and CSA Certified to 35 KV\*\* and temperature rated to 90°C when crimped with Panduit and specified competitor crimping tools and dies
- UL Listed and CSA Certified for wide wire range-taking capability when crimped with Panduit® Uni-Die™ Dieless Crimping Tools‡
- **Tested by Telcordia – meets NEBS Level 3**
- Meets J-STD-607-A and TIA-942 requirements for network systems grounding applications
- Available with NEMA hole sizes and spacing

B2. Cable Accessories

B3. Stainless Steel Ties

C1. Wiring Duct

C2. Surface Raceway

C3. Abrasion Protection

C4. Cable Management

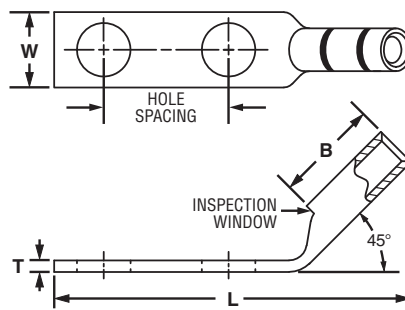

Figure 1

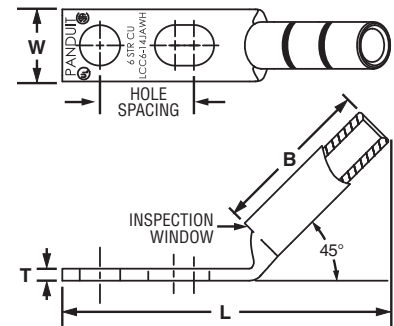

Figure 2: Slotted

D1. Terminals

D2. Power Connectors

D3. Grounding Connectors

E1. Labeling Systems

E2. Labels

E3. Pre-Printed & Write-On Markers

E4. Permanent Identification

E5. Lockout/Tagout & Safety Solutions

F. Index

| Part Number            | Figure No. | Copper Conductor Size                | Stud Hole Size (In.) | Stud Hole Spacing (In.) | Figure Dimensions (In.) |      |      |      | Panduit Color Code | Panduit Die Index No.‡ | Burdny Die Index No.‡ | T&B Die Index No.‡ | Wire Strip Length (In.) | Std. Pkg. Qty. |
|------------------------|------------|--------------------------------------|----------------------|-------------------------|-------------------------|------|------|------|--------------------|------------------------|-----------------------|--------------------|-------------------------|----------------|
|                        |            |                                      |                      |                         | W                       | B    | T    | L    |                    |                        |                       |                    |                         |                |
| <b>LCC10-14JAWH-L*</b> | 2          | #14 – #10 AWG STR, #12 – #10 AWG SOL | 1/4                  | 0.50–0.63               | 0.42                    | 0.53 | 0.05 | 1.78 | —                  | —                      | —                     | —                  | 9/16                    | 50             |
| <b>LCC10-14AWH-L*</b>  | 1          |                                      | 1/4                  | 0.63                    | 0.42                    | 0.53 | 0.05 | 1.78 | —                  | —                      | —                     | —                  | 9/16                    | 50             |
| <b>LCC10-14BWH-L*</b>  | 1          |                                      | 1/4                  | 0.75                    | 0.42                    | 0.53 | 0.05 | 1.90 | —                  | —                      | —                     | —                  | 9/16                    | 50             |
| <b>LCC8-10AWH-L</b>    | 1          | #8 AWG                               | #10                  | 0.63                    | 0.41                    | 0.70 | 0.08 | 1.82 | Red                | P21                    | 49                    | 21                 | 3/4                     | 50             |
| <b>LCC8-10BWH-L</b>    | 1          |                                      | #10                  | 0.75                    | 0.41                    | 0.70 | 0.08 | 1.95 | Red                | P21                    | 49                    | 21                 | 3/4                     | 50             |
| <b>LCC8-14AWH-L</b>    | 2          |                                      | 1/4                  | 0.63                    | 0.48                    | 0.70 | 0.07 | 1.91 | Red                | P21                    | 49                    | 21                 | 3/4                     | 50             |
| <b>LCC8-14BWH-L</b>    | 1          |                                      | 1/4                  | 0.75                    | 0.48                    | 0.70 | 0.07 | 2.03 | Red                | P21                    | 49                    | 21                 | 3/4                     | 50             |
| <b>LCC8-14DWH-L</b>    | 1          |                                      | 1/4                  | 1.00                    | 0.48                    | 0.70 | 0.07 | 2.28 | Red                | P21                    | 49                    | 21                 | 3/4                     | 50             |
| <b>LCC8-38DWH-L</b>    | 1          |                                      | 3/8                  | 1.00                    | 0.60                    | 0.70 | 0.05 | 2.49 | Red                | P21                    | 49                    | 21                 | 3/4                     | 50             |
| <b>LCC6-10AWH-L</b>    | 1          |                                      | #10                  | 0.63                    | 0.46                    | 1.07 | 0.08 | 2.09 | Blue               | P24                    | 7                     | 24                 | 1 1/8                   | 50             |
| <b>LCC6-10BWH-L</b>    | 1          | #10                                  | 0.75                 | 0.46                    | 1.07                    | 0.08 | 2.22 | Blue | P24                | 7                      | 24                    | 1 1/8              | 50                      |                |
| <b>LCC6-14JWH-L</b>    | 1          | #6 AWG                               | 1/4                  | 0.50                    | 0.48                    | 1.07 | 0.08 | 2.06 | Blue               | P24                    | 7                     | 24                 | 1 1/8                   | 50             |
| <b>LCC6-14AWH-L</b>    | 1          |                                      | 1/4                  | 0.63                    | 0.48                    | 1.07 | 0.08 | 2.18 | Blue               | P24                    | 7                     | 24                 | 1 1/8                   | 50             |
| <b>LCC6-14JAWH-L</b>   | 2          |                                      | 1/4                  | 0.50–0.63               | 0.48                    | 1.07 | 0.08 | 2.08 | Blue               | P24                    | 7                     | 24                 | 1 1/8                   | 50             |
| <b>LCC6-14BWH-L</b>    | 1          |                                      | 1/4                  | 0.75                    | 0.48                    | 1.07 | 0.08 | 2.31 | Blue               | P24                    | 7                     | 24                 | 1 1/8                   | 50             |
| <b>LCC6-14DWH-L</b>    | 1          |                                      | 1/4                  | 1.00                    | 0.48                    | 1.07 | 0.08 | 2.56 | Blue               | P24                    | 7                     | 24                 | 1 1/8                   | 50             |
| <b>LCC6-14EWH-L</b>    | 1          |                                      | 1/4                  | 1.25                    | 0.48                    | 1.07 | 0.08 | 2.81 | Blue               | P24                    | 7                     | 24                 | 1 1/8                   | 50             |
| <b>LCC6-56BWH-L</b>    | 1          |                                      | 5/16                 | 0.75                    | 0.56                    | 1.07 | 0.07 | 2.42 | Blue               | P24                    | 7                     | 24                 | 1 1/8                   | 50             |
| <b>LCC6-38BWH-L</b>    | 1          |                                      | 3/8                  | 0.75                    | 0.62                    | 1.07 | 0.06 | 2.52 | Blue               | P24                    | 7                     | 24                 | 1 1/8                   | 50             |
| <b>LCC6-38CWH-L</b>    | 1          |                                      | 3/8                  | 0.88                    | 0.62                    | 1.07 | 0.06 | 2.64 | Blue               | P24                    | 7                     | 24                 | 1 1/8                   | 50             |
| <b>LCC6-38DWH-L</b>    | 1          |                                      | 3/8                  | 1.00                    | 0.62                    | 1.07 | 0.06 | 2.77 | Blue               | P24                    | 7                     | 24                 | 1 1/8                   | 50             |

‡See pages D3.62 – D3.65 for tool and die information.

\*Not tested to NEBS Level 3 requirements.

\*\*Consult cable manufacturer for voltage stress relief instructions with applications greater than 2000 V.



## Code Conductor, Two-Hole, Long Barrel with Window Lug, 45° Angle (continued)

A.  
System  
Overview

B1.  
Cable Ties

B2.  
Cable  
Accessories

B3.  
Stainless  
Steel Ties

C1.  
Wiring  
Duct

C2.  
Surface  
Raceway

C3.  
Abrasion  
Protection

C4.  
Cable  
Management

D1.  
Terminals

D2.  
Power  
Connectors

D3.  
Grounding  
Connectors

E1.  
Labeling  
Systems

E2.  
Labels

E3.  
Pre-Printed  
& Write-On  
Markers

E4.  
Permanent  
Identification

E5.  
Lockout/  
Tagout  
& Safety  
Solutions

F.  
Index

| Part Number    | Figure No. | Copper Conductor Size       | Stud Hole Size (In.) | Stud Hole Spacing (In.) | Figure Dimensions (In.) |      |      |        | Panduit Color Code | Panduit Die Index No.‡ | Burndy Die Index No.‡ | T&B Die Index No.‡ | Wire Strip Length (In.) | Std. Pkg. Qty. |
|----------------|------------|-----------------------------|----------------------|-------------------------|-------------------------|------|------|--------|--------------------|------------------------|-----------------------|--------------------|-------------------------|----------------|
|                |            |                             |                      |                         | W                       | B    | T    | L      |                    |                        |                       |                    |                         |                |
| LCC4-10AWH-L   | 1          | #4 – #3 AWG STR, #2 AWG SOL | #10                  | 0.63                    | 0.55                    | 1.05 | 0.09 | 2.11   | Gray               | P29                    | 8                     | 29                 | 1 1/8                   | 50             |
| LCC4-10BWH-L   | 1          |                             | #10                  | 0.75                    | 0.55                    | 1.05 | 0.09 | 2.23   | Gray               | P29                    | 8                     | 29                 | 1 1/8                   | 50             |
| LCC4-14AWH-L   | 1          |                             | 1/4                  | 0.63                    | 0.55                    | 1.05 | 0.09 | 2.20   | Gray               | P29                    | 8                     | 29                 | 1 1/8                   | 50             |
| LCC4-14BWH-L   | 1          |                             | 1/4                  | 0.75                    | 0.55                    | 1.05 | 0.09 | 2.32   | Gray               | P29                    | 8                     | 29                 | 1 1/8                   | 50             |
| LCC4-38DWH-L   | 1          | #2 AWG                      | 3/8                  | 1.00                    | 0.62                    | 1.05 | 0.08 | 2.79   | Gray               | P29                    | 8                     | 29                 | 1 1/8                   | 50             |
| LCC2-10AWH-Q   | 1          |                             | #10                  | 0.63                    | 0.60                    | 1.16 | 0.10 | 2.21   | Brown              | P33                    | 10                    | 33                 | 1 1/4                   | 25             |
| LCC2-10BWH-Q   | 1          |                             | #10                  | 0.75                    | 0.60                    | 1.16 | 0.10 | 2.33   | Brown              | P33                    | 10                    | 33                 | 1 1/4                   | 25             |
| LCC2-14AWH-Q   | 1          |                             | 1/4                  | 0.63                    | 0.60                    | 1.16 | 0.10 | 2.31   | Brown              | P33                    | 10                    | 33                 | 1 1/4                   | 25             |
| LCC2-14BWH-Q   | 1          |                             | 1/4                  | 0.75                    | 0.60                    | 1.16 | 0.10 | 2.43   | Brown              | P33                    | 10                    | 33                 | 1 1/4                   | 25             |
| LCC2-14DWH-Q   | 1          |                             | 1/4                  | 1.00                    | 0.60                    | 1.16 | 0.10 | 2.68   | Brown              | P33                    | 10                    | 33                 | 1 1/4                   | 25             |
| LCC2-56BWH-Q   | 1          |                             | 5/16                 | 0.75                    | 0.66                    | 1.16 | 0.10 | 2.55   | Brown              | P33                    | 10                    | 33                 | 1 1/4                   | 25             |
| LCC2-56CWH-Q   | 1          |                             | 5/16                 | 0.88                    | 0.66                    | 1.16 | 0.10 | 2.68   | Brown              | P33                    | 10                    | 33                 | 1 1/4                   | 25             |
| LCC2-38BWH-Q   | 1          |                             | 3/8                  | 0.75                    | 0.66                    | 1.16 | 0.10 | 2.63   | Brown              | P33                    | 10                    | 33                 | 1 1/4                   | 25             |
| LCC2-38CWH-Q   | 1          |                             | 3/8                  | 0.88                    | 0.66                    | 1.16 | 0.10 | 2.75   | Brown              | P33                    | 10                    | 33                 | 1 1/4                   | 25             |
| LCC2-38DWH-Q   | 1          |                             | 3/8                  | 1.00                    | 0.66                    | 1.16 | 0.10 | 2.88   | Brown              | P33                    | 10                    | 33                 | 1 1/4                   | 25             |
| LCC2-38WH-Q    | 1          |                             | 3/8                  | 1.75                    | 0.66                    | 1.16 | 0.10 | 3.63   | Brown              | P33                    | 10                    | 33                 | 1 1/4                   | 25             |
| LCC2-12WH-Q    | 1          |                             | 1/2                  | 1.75                    | 0.75                    | 1.16 | 0.08 | 4.03   | Brown              | P33                    | 10                    | 33                 | 1 1/4                   | 25             |
| LCC1-14AWH-E   | 1          |                             | #1 AWG               | 1/4                     | 0.63                    | 0.70 | 1.36 | 0.11   | 2.46               | Green                  | P37                   | 11                 | 37                      | 1 7/16         |
| LCC1-14BWH-E   | 1          | 1/4                         |                      | 0.75                    | 0.70                    | 1.36 | 0.11 | 2.58   | Green              | P37                    | 11                    | 37                 | 1 7/16                  | 20             |
| LCC1-56BWH-E   | 1          | 5/16                        |                      | 0.75                    | 0.70                    | 1.36 | 0.11 | 2.71   | Green              | P37                    | 11                    | 37                 | 1 7/16                  | 20             |
| LCC1-56CWH-E   | 1          | 5/16                        |                      | 0.88                    | 0.70                    | 1.36 | 0.11 | 2.83   | Green              | P37                    | 11                    | 37                 | 1 7/16                  | 20             |
| LCC1-38DWH-E   | 1          | 3/8                         |                      | 1.00                    | 0.70                    | 1.36 | 0.11 | 3.04   | Green              | P37                    | 11                    | 37                 | 1 7/16                  | 20             |
| LCC1-12WH-E    | 1          | 1/2                         |                      | 1.75                    | 0.75                    | 1.36 | 0.09 | 4.20   | Green              | P37                    | 11                    | 37                 | 1 7/16                  | 20             |
| LCC1/0-14AWH-X | 1          | 1/0 AWG                     | 1/4                  | 0.63                    | 0.76                    | 1.44 | 0.12 | 2.61   | Pink               | P42                    | 12                    | 42                 | 1 1/2                   | 10             |
| LCC1/0-14BWH-X | 1          |                             | 1/4                  | 0.75                    | 0.76                    | 1.44 | 0.12 | 2.73   | Pink               | P42                    | 12                    | 42                 | 1 1/2                   | 10             |
| LCC1/0-14DWH-X | 1          |                             | 1/4                  | 1.00                    | 0.76                    | 1.44 | 0.12 | 2.98   | Pink               | P42                    | 12                    | 42                 | 1 1/2                   | 10             |
| LCC1/0-38DWH-X | 1          |                             | 3/8                  | 1.00                    | 0.76                    | 1.44 | 0.12 | 3.11   | Pink               | P42                    | 12                    | 42                 | 1 1/2                   | 10             |
| LCC1/0-38WH-X  | 1          |                             | 3/8                  | 1.75                    | 0.76                    | 1.44 | 0.12 | 3.86   | Pink               | P42                    | 12                    | 42                 | 1 1/2                   | 10             |
| LCC1/0-12DWH-X | 1          |                             | 1/2                  | 1.00                    | 0.80                    | 1.44 | 0.12 | 3.37   | Pink               | P42                    | 12                    | 42                 | 1 1/2                   | 10             |
| LCC1/0-12WH-X  | 1          | 1/2                         | 1.75                 | 0.80                    | 1.44                    | 0.12 | 4.28 | Pink   | P42                | 12                     | 42                    | 1 1/2              | 10                      |                |
| LCC2/0-14AWH-X | 1          | 2/0 AWG                     | 1/4                  | 0.63                    | 0.85                    | 1.50 | 0.13 | 2.76   | Black              | P45                    | 13                    | 45                 | 1 9/16                  | 10             |
| LCC2/0-14BWH-X | 1          |                             | 1/4                  | 0.75                    | 0.85                    | 1.50 | 0.13 | 2.88   | Black              | P45                    | 13                    | 45                 | 1 9/16                  | 10             |
| LCC2/0-56DWH-X | 1          |                             | 5/16                 | 1.00                    | 0.85                    | 1.50 | 0.13 | 3.13   | Black              | P45                    | 13                    | 45                 | 1 9/16                  | 10             |
| LCC2/0-38DWH-X | 1          |                             | 3/8                  | 1.00                    | 0.85                    | 1.50 | 0.13 | 3.20   | Black              | P45                    | 13                    | 45                 | 1 9/16                  | 10             |
| LCC2/0-12DWH-X | 1          |                             | 1/2                  | 1.00                    | 0.85                    | 1.50 | 0.13 | 3.45   | Black              | P45                    | 13                    | 45                 | 1 9/16                  | 10             |
| LCC2/0-12WH-X  | 1          |                             | 1/2                  | 1.75                    | 0.85                    | 1.50 | 0.13 | 4.36   | Black              | P45                    | 13                    | 45                 | 1 9/16                  | 10             |
| LCC3/0-14BWH-X | 1          | 3/0 AWG                     | 1/4                  | 0.75                    | 0.96                    | 1.50 | 0.13 | 2.91   | Orange             | P50                    | 14                    | 50                 | 1 9/16                  | 10             |
| LCC3/0-56DWH-X | 1          |                             | 5/16                 | 1.00                    | 0.96                    | 1.50 | 0.13 | 3.16   | Orange             | P50                    | 14                    | 50                 | 1 9/16                  | 10             |
| LCC3/0-38DWH-X | 1          |                             | 3/8                  | 1.00                    | 0.96                    | 1.50 | 0.13 | 3.22   | Orange             | P50                    | 14                    | 50                 | 1 9/16                  | 10             |
| LCC3/0-12DWH-X | 1          |                             | 1/2                  | 1.00                    | 0.96                    | 1.50 | 0.13 | 3.47   | Orange             | P50                    | 14                    | 50                 | 1 9/16                  | 10             |
| LCC3/0-12WH-X  | 1          | 1/2                         | 1.75                 | 0.96                    | 1.50                    | 0.13 | 4.38 | Orange | P50                | 14                     | 50                    | 1 9/16             | 10                      |                |
| LCC4/0-14AWH-X | 1          | 4/0 AWG                     | 1/4                  | 0.63                    | 1.06                    | 1.56 | 0.14 | 2.85   | Purple             | P54                    | 15                    | 54                 | 1 5/8                   | 10             |
| LCC4/0-14BWH-X | 1          |                             | 1/4                  | 0.75                    | 1.06                    | 1.56 | 0.14 | 2.98   | Purple             | P54                    | 15                    | 54                 | 1 5/8                   | 10             |
| LCC4/0-56DWH-X | 1          |                             | 5/16                 | 1.00                    | 1.06                    | 1.56 | 0.14 | 3.24   | Purple             | P54                    | 15                    | 54                 | 1 5/8                   | 10             |
| LCC4/0-38DWH-X | 1          |                             | 3/8                  | 1.00                    | 1.06                    | 1.56 | 0.14 | 3.31   | Purple             | P54                    | 15                    | 54                 | 1 5/8                   | 10             |
| LCC4/0-38WH-X  | 1          |                             | 3/8                  | 1.75                    | 1.06                    | 1.56 | 0.14 | 4.06   | Purple             | P54                    | 15                    | 54                 | 1 5/8                   | 10             |
| LCC4/0-12DWH-X | 1          |                             | 1/2                  | 1.00                    | 1.06                    | 1.56 | 0.14 | 3.54   | Purple             | P54                    | 15                    | 54                 | 1 5/8                   | 10             |
| LCC4/0-12WH-X  | 1          | 1/2                         | 1.75                 | 1.06                    | 1.56                    | 0.14 | 4.45 | Purple | P54                | 15                     | 54                    | 1 5/8              | 10                      |                |

‡See pages D3.62 – D3.65 for tool and die information.

\*\*Consult cable manufacturer for voltage stress relief instructions with applications greater than 2000 V.

◆NEMA hole sizes and spacing.

Table continues on page D2.52

A.  
System  
Overview



## Code Conductor, Two-Hole, Long Barrel with Window Lug, 45° Angle (continued)

B1.  
Cable Ties

B2.  
Cable  
Accessories

B3.  
Stainless  
Steel Ties

C1.  
Wiring  
Duct

C2.  
Surface  
Raceway

C3.  
Abrasion  
Protection

C4.  
Cable  
Management

D1.  
Terminals

D2.  
Power  
Connectors

D3.  
Grounding  
Connectors

E1.  
Labeling  
Systems

E2.  
Labels

E3.  
Pre-Printed  
& Write-On  
Markers

E4.  
Permanent  
Identification

E5.  
Lockout/  
Tagout  
& Safety  
Solutions

F.  
Index

| Part Number     | Figure No. | Copper Conductor Size | Stud Hole Size (In.) | Stud Hole Spacing (In.) | Figure Dimensions (In.) |      |      |      | Panduit Color Code | Panduit Die Index No.‡ | Burndy Die Index No.‡ | T&B Die Index No.‡ | Wire Strip Length (In.) | Std. Pkg. Qty. |
|-----------------|------------|-----------------------|----------------------|-------------------------|-------------------------|------|------|------|--------------------|------------------------|-----------------------|--------------------|-------------------------|----------------|
|                 |            |                       |                      |                         | W                       | B    | T    | L    |                    |                        |                       |                    |                         |                |
| LCC250-56DWH-X  | 1          | 250 kcmil             | 5/16                 | 1.00                    | 1.17                    | 1.61 | 0.14 | 3.31 | Yellow             | P62                    | 16                    | 62                 | 1 11/16                 | 10             |
| LCC250-38DWH-X  | 1          |                       | 3/8                  | 1.00                    | 1.17                    | 1.61 | 0.14 | 3.38 | Yellow             | P62                    | 16                    | 62                 | 1 11/16                 | 10             |
| LCC250-12DWH-X  | 1          |                       | 1/2                  | 1.00                    | 1.17                    | 1.61 | 0.14 | 3.61 | Yellow             | P62                    | 16                    | 62                 | 1 11/16                 | 10             |
| ◆ LCC250-12WH-X | 1          | 300 kcmil             | 1/2                  | 1.75                    | 1.17                    | 1.61 | 0.14 | 4.52 | Yellow             | P62                    | 16                    | 62                 | 1 11/16                 | 10             |
| LCC300-38DWH-X  | 1          |                       | 3/8                  | 1.00                    | 1.19                    | 2.24 | 0.16 | 3.93 | White              | P66                    | 17                    | 66                 | 2 5/16                  | 10             |
| ◆ LCC300-12WH-X | 1          |                       | 1/2                  | 1.75                    | 1.19                    | 2.24 | 0.16 | 5.11 | White              | P66                    | 17                    | 66                 | 2 5/16                  | 10             |
| LCC350-14BWH-X  | 1          | 350 kcmil             | 1/4                  | 0.75                    | 1.28                    | 2.24 | 0.17 | 3.48 | Red                | P71                    | 18                    | 71                 | 2 5/16                  | 10             |
| LCC350-38DWH-X  | 1          |                       | 3/8                  | 1.00                    | 1.28                    | 2.24 | 0.17 | 3.96 | Red                | P71                    | 18                    | 71                 | 2 5/16                  | 10             |
| ◆ LCC350-12WH-X | 1          |                       | 1/2                  | 1.75                    | 1.28                    | 2.24 | 0.17 | 5.14 | Red                | P71                    | 18                    | 71                 | 2 5/16                  | 10             |
| LCC400-14BWH-6  | 1          | 400 kcmil             | 1/4                  | 0.75                    | 1.39                    | 2.30 | 0.18 | 3.59 | Blue               | P76                    | 19                    | 76                 | 2 3/8                   | 6              |
| LCC400-38DWH-6  | 1          |                       | 3/8                  | 1.00                    | 1.39                    | 2.30 | 0.18 | 4.07 | Blue               | P76                    | 19                    | 76                 | 2 3/8                   | 6              |
| ◆ LCC400-12WH-6 | 1          |                       | 1/2                  | 1.75                    | 1.28                    | 2.30 | 0.17 | 5.24 | Blue               | P76                    | 19                    | 76                 | 2 3/8                   | 6              |
| LCC500-14BWH-6  | 1          | 500 kcmil             | 1/4                  | 0.75                    | 1.54                    | 2.50 | 0.22 | 3.80 | Brown              | P87                    | 20                    | 87                 | 2 9/16                  | 6              |
| LCC500-38DWH-6  | 1          |                       | 3/8                  | 1.00                    | 1.54                    | 2.50 | 0.22 | 4.29 | Brown              | P87                    | 20                    | 87                 | 2 9/16                  | 6              |
| ◆ LCC500-12WH-6 | 1          |                       | 1/2                  | 1.75                    | 1.54                    | 2.50 | 0.22 | 5.46 | Brown              | P87                    | 20                    | 87                 | 2 9/16                  | 6              |
| LCC600-38DWH-6  | 1          | 600 kcmil             | 3/8                  | 1.00                    | 1.70                    | 2.69 | 0.26 | 4.47 | Green              | P94                    | 22                    | 94                 | 2 3/4                   | 6              |
| ◆ LCC600-12WH-6 | 1          |                       | 1/2                  | 1.75                    | 1.70                    | 2.69 | 0.26 | 5.65 | Green              | P94                    | 22                    | 94                 | 2 3/4                   | 6              |

‡See pages D3.62 – D3.65 for tool and die information.

\*\*Consult cable manufacturer for voltage stress relief instructions with applications greater than 2000 V.

◆NEMA hole sizes and spacing.



## Code Conductor, Two-Hole, Long Barrel with Window Lug, 90° Angle

For Use with Stranded Copper Conductors

### Type LCC-WF

- Long barrel maximizes number of crimps and provides premium wire pull-out strength and electrical performance
- Inspection window to visually assure full conductor insertion
- Color-coded barrels marked with Panduit and specified competitor die index numbers for proper crimp die selection
- Tin-plated to inhibit corrosion
- UL Listed and CSA Certified to 35 KV\*\* and temperature rated to 90°C when crimped with Panduit and specified competitor crimping tools and dies
- UL Listed and CSA Certified for wide wire range-taking capability when crimped with Panduit® Uni-Die™ Dieless Crimping Tools‡
- **Tested by Telcordia – meets NEBS Level 3**
- Meets J-STD-607-A and TIA-942 requirements for network systems grounding applications
- Available with NEMA hole sizes and spacing

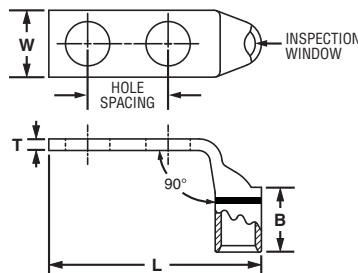

Figure 1

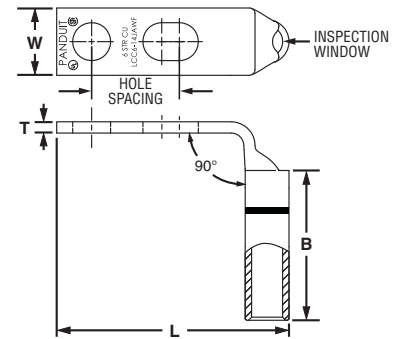

Figure 2: Slotted

| Part Number     | Figure No. | Copper Conductor Size  | Stud Hole Size (in.) | Stud Hole Spacing (in.) | Figure Dimensions (in.) |      |      |      | Panduit Color Code | Panduit Die Index No.‡ | Burdndy Die Index No.‡ | T&B Die Index No.‡ | Wire Strip Length (in.) | Std. Pkg. Qty. |
|-----------------|------------|------------------------|----------------------|-------------------------|-------------------------|------|------|------|--------------------|------------------------|------------------------|--------------------|-------------------------|----------------|
|                 |            |                        |                      |                         | W                       | B    | T    | L    |                    |                        |                        |                    |                         |                |
| LCC10-14JAWF-L* | 2          | #14 – #10 AWG          | 1/4                  | 0.50 – 0.63             | 0.42                    | 0.53 | 0.05 | 1.56 | —                  | —                      | —                      | —                  | 9/16                    | 50             |
| LCC10-14AWF-L*  | 1          | STR, #12 – #10 AWG SOL | 1/4                  | 0.63                    | 0.42                    | 0.53 | 0.05 | 1.56 | —                  | —                      | —                      | —                  | 9/16                    | 50             |
| LCC10-14BWF-L*  | 1          |                        | 1/4                  | 0.75                    | 0.42                    | 0.53 | 0.05 | 1.69 | —                  | —                      | —                      | —                  | 9/16                    | 50             |
| LCC8-10AWF-L    | 1          | #8 AWG                 | #10                  | 0.63                    | 0.41                    | 0.70 | 0.08 | 1.53 | Red                | P21                    | 49                     | 21                 | 3/4                     | 50             |
| LCC8-10BWF-L    | 1          |                        | #10                  | 0.75                    | 0.41                    | 0.70 | 0.08 | 1.65 | Red                | P21                    | 49                     | 21                 | 3/4                     | 50             |
| LCC8-14AWF-L    | 1          |                        | 1/4                  | 0.63                    | 0.48                    | 0.70 | 0.07 | 1.61 | Red                | P21                    | 49                     | 21                 | 3/4                     | 50             |
| LCC8-14BWF-L    | 1          |                        | 1/4                  | 0.75                    | 0.48                    | 0.70 | 0.07 | 1.74 | Red                | P21                    | 49                     | 21                 | 3/4                     | 50             |
| LCC8-14DWF-L    | 1          |                        | 1/4                  | 1.00                    | 0.48                    | 0.70 | 0.07 | 1.99 | Red                | P21                    | 49                     | 21                 | 3/4                     | 50             |
| LCC8-38DWF-L    | 1          |                        | 3/8                  | 1.00                    | 0.60                    | 0.70 | 0.05 | 2.21 | Red                | P21                    | 49                     | 21                 | 3/4                     | 50             |
| LCC6-10AWF-L    | 1          | #6 AWG                 | #10                  | 0.63                    | 0.46                    | 1.07 | 0.08 | 1.57 | Blue               | P24                    | 7                      | 24                 | 1 1/8                   | 50             |
| LCC6-10BWF-L    | 1          |                        | #10                  | 0.75                    | 0.46                    | 1.07 | 0.08 | 1.69 | Blue               | P24                    | 7                      | 24                 | 1 1/8                   | 50             |
| LCC6-14JWF-L    | 1          |                        | 1/4                  | 0.50                    | 0.48                    | 1.07 | 0.08 | 1.53 | Blue               | P24                    | 7                      | 24                 | 1 1/8                   | 50             |
| LCC6-14AWF-L    | 1          |                        | 1/4                  | 0.63                    | 0.48                    | 1.07 | 0.08 | 1.66 | Blue               | P24                    | 7                      | 24                 | 1 1/8                   | 50             |
| LCC6-14JAWF-L   | 2          |                        | 1/4                  | 0.50 – 0.63             | 0.48                    | 1.07 | 0.08 | 1.66 | Blue               | P24                    | 7                      | 24                 | 1 1/8                   | 50             |
| LCC6-14BWF-L    | 1          |                        | 1/4                  | 0.75                    | 0.48                    | 1.07 | 0.08 | 1.78 | Blue               | P24                    | 7                      | 24                 | 1 1/8                   | 50             |
| LCC6-14DWF-L    | 1          |                        | 1/4                  | 1.00                    | 0.48                    | 1.07 | 0.08 | 2.03 | Blue               | P24                    | 7                      | 24                 | 1 1/8                   | 50             |
| LCC6-14EWF-L    | 1          |                        | 1/4                  | 1.25                    | 0.48                    | 1.07 | 0.08 | 2.28 | Blue               | P24                    | 7                      | 24                 | 1 1/8                   | 50             |
| LCC6-56BWF-L    | 1          |                        | 5/16                 | 0.75                    | 0.56                    | 1.07 | 0.07 | 1.90 | Blue               | P24                    | 7                      | 24                 | 1 1/8                   | 50             |
| LCC6-38BWF-L    | 1          |                        | 3/8                  | 0.75                    | 0.62                    | 1.07 | 0.06 | 2.00 | Blue               | P24                    | 7                      | 24                 | 1 1/8                   | 50             |
| LCC6-38CWF-L    | 1          |                        | 3/8                  | 0.88                    | 0.62                    | 1.07 | 0.06 | 2.13 | Blue               | P24                    | 7                      | 24                 | 1 1/8                   | 50             |
| LCC6-38DWF-L    | 1          |                        | 3/8                  | 1.00                    | 0.62                    | 1.07 | 0.06 | 2.25 | Blue               | P24                    | 7                      | 24                 | 1 1/8                   | 50             |

‡See pages D3.62 – D3.65 for tool and die information.

\*Not tested to NEBS Level 3 requirements.

\*\*Consult cable manufacturer for voltage stress relief instructions with applications greater than 2000 V.

Table continues on pages D2.54 — D2.55

A. System Overview

B1. Cable Ties

B2. Cable Accessories

B3. Stainless Steel Ties

C1. Wiring Duct

C2. Surface Raceway

C3. Abrasion Protection

C4. Cable Management

D1. Terminals

D2. Power Connectors

D3. Grounding Connectors

E1. Labeling Systems

E2. Labels

E3. Pre-Printed & Write-On Markers

E4. Permanent Identification

E5. Lockout/Tagout & Safety Solutions

F. Index



## Code Conductor, Two-Hole, Long Barrel with Window Lug, 90° Angle (continued)

|                                       |
|---------------------------------------|
| A. System Overview                    |
| B1. Cable Ties                        |
| B2. Cable Accessories                 |
| B3. Stainless Steel Ties              |
| C1. Wiring Duct                       |
| C2. Surface Raceway                   |
| C3. Abrasion Protection               |
| C4. Cable Management                  |
| D1. Terminals                         |
| D2. Power Connectors                  |
| D3. Grounding Connectors              |
| E1. Labeling Systems                  |
| E2. Labels                            |
| E3. Pre-Printed & Write-On Markers    |
| E4. Permanent Identification          |
| E5. Lockout/Tagout & Safety Solutions |
| F. Index                              |

| Part Number    | Figure No. | Copper Conductor Size       | Stud Hole Size (In.) | Stud Hole Spacing (In.) | Figure Dimensions (In.) |      |      |        | Panduit Color Code | Panduit Die Index No.‡ | Burndy Die Index No.‡ | T&B Die Index No.‡ | Wire Strip Length (In.) | Std. Pkg. Qty. |
|----------------|------------|-----------------------------|----------------------|-------------------------|-------------------------|------|------|--------|--------------------|------------------------|-----------------------|--------------------|-------------------------|----------------|
|                |            |                             |                      |                         | W                       | B    | T    | L      |                    |                        |                       |                    |                         |                |
| LCC4-10AWF-L   | 1          | #4 – #3 AWG STR, #2 AWG SOL | #10                  | 0.63                    | 0.55                    | 1.05 | 0.09 | 1.65   | Gray               | P29                    | 8                     | 29                 | 1 1/8                   | 50             |
| LCC4-10BWF-L   | 1          |                             | #10                  | 0.75                    | 0.55                    | 1.05 | 0.09 | 1.78   | Gray               | P29                    | 8                     | 29                 | 1 1/8                   | 50             |
| LCC4-14AWF-L   | 1          |                             | 1/4                  | 0.63                    | 0.55                    | 1.05 | 0.09 | 1.74   | Gray               | P29                    | 8                     | 29                 | 1 1/8                   | 50             |
| LCC4-14BWF-L   | 1          |                             | 1/4                  | 0.75                    | 0.55                    | 1.05 | 0.09 | 1.87   | Gray               | P29                    | 8                     | 29                 | 1 1/8                   | 50             |
| LCC4-38DWF-L   | 1          | #2 AWG                      | 3/8                  | 1.00                    | 0.62                    | 1.05 | 0.08 | 2.34   | Gray               | P29                    | 8                     | 29                 | 1 1/8                   | 50             |
| LCC2-10AWF-Q   | 1          |                             | #10                  | 0.63                    | 0.60                    | 1.16 | 0.10 | 1.76   | Brown              | P33                    | 10                    | 33                 | 1 1/4                   | 25             |
| LCC2-10BWF-Q   | 1          |                             | #10                  | 0.75                    | 0.60                    | 1.16 | 0.10 | 1.89   | Brown              | P33                    | 10                    | 33                 | 1 1/4                   | 25             |
| LCC2-14AWF-Q   | 1          |                             | 1/4                  | 0.63                    | 0.60                    | 1.16 | 0.10 | 1.86   | Brown              | P33                    | 10                    | 33                 | 1 1/4                   | 25             |
| LCC2-14BWF-Q   | 1          |                             | 1/4                  | 0.75                    | 0.60                    | 1.16 | 0.10 | 1.99   | Brown              | P33                    | 10                    | 33                 | 1 1/4                   | 25             |
| LCC2-14DWF-Q   | 1          |                             | 1/4                  | 1.00                    | 0.60                    | 1.16 | 0.10 | 2.24   | Brown              | P33                    | 10                    | 33                 | 1 1/4                   | 25             |
| LCC2-56BWF-Q   | 1          |                             | 5/16                 | 0.75                    | 0.66                    | 1.16 | 0.10 | 2.11   | Brown              | P33                    | 10                    | 33                 | 1 1/4                   | 25             |
| LCC2-56CWF-Q   | 1          |                             | 5/16                 | 0.88                    | 0.66                    | 1.16 | 0.10 | 2.24   | Brown              | P33                    | 10                    | 33                 | 1 1/4                   | 25             |
| LCC2-38BWF-Q   | 1          |                             | 3/8                  | 0.75                    | 0.66                    | 1.16 | 0.10 | 2.19   | Brown              | P33                    | 10                    | 33                 | 1 1/4                   | 25             |
| LCC2-38CWF-Q   | 1          |                             | 3/8                  | 0.88                    | 0.66                    | 1.16 | 0.10 | 2.31   | Brown              | P33                    | 10                    | 33                 | 1 1/4                   | 25             |
| LCC2-38DWF-Q   | 1          |                             | 3/8                  | 1.00                    | 0.66                    | 1.16 | 0.10 | 2.44   | Brown              | P33                    | 10                    | 33                 | 1 1/4                   | 25             |
| LCC2-38WF-Q    | 1          |                             | 3/8                  | 1.75                    | 0.66                    | 1.16 | 0.10 | 3.19   | Brown              | P33                    | 10                    | 33                 | 1 1/4                   | 25             |
| LCC2-12WF-Q    | 1          | 1/2                         | 1.75                 | 0.75                    | 1.16                    | 0.08 | 3.61 | Brown  | P33                | 10                     | 33                    | 1 1/4              | 25                      |                |
| LCC1-14AWF-E   | 1          | #1 AWG                      | 1/4                  | 0.63                    | 0.70                    | 1.36 | 0.11 | 1.94   | Green              | P37                    | 11                    | 37                 | 1 7/16                  | 20             |
| LCC1-14BWF-E   | 1          |                             | 1/4                  | 0.75                    | 0.70                    | 1.36 | 0.11 | 2.06   | Green              | P37                    | 11                    | 37                 | 1 7/16                  | 20             |
| LCC1-56BWF-E   | 1          |                             | 5/16                 | 0.75                    | 0.70                    | 1.36 | 0.11 | 2.19   | Green              | P37                    | 11                    | 37                 | 1 7/16                  | 20             |
| LCC1-56CWF-E   | 1          |                             | 5/16                 | 0.88                    | 0.70                    | 1.36 | 0.11 | 2.31   | Green              | P37                    | 11                    | 37                 | 1 7/16                  | 20             |
| LCC1-38DWF-E   | 1          |                             | 3/8                  | 1.00                    | 0.70                    | 1.36 | 0.11 | 2.51   | Green              | P37                    | 11                    | 37                 | 1 7/16                  | 20             |
| LCC1-12WF-E    | 1          |                             | 1/2                  | 1.75                    | 0.75                    | 1.36 | 0.09 | 3.68   | Green              | P37                    | 11                    | 37                 | 1 7/16                  | 20             |
| LCC1/0-14AWF-X | 1          | 1/0 AWG                     | 1/4                  | 0.63                    | 0.76                    | 1.44 | 0.12 | 2.08   | Pink               | P42                    | 12                    | 42                 | 1 1/2                   | 10             |
| LCC1/0-14BWF-X | 1          |                             | 1/4                  | 0.75                    | 0.76                    | 1.44 | 0.12 | 2.20   | Pink               | P42                    | 12                    | 42                 | 1 1/2                   | 10             |
| LCC1/0-14DWF-X | 1          |                             | 1/4                  | 1.00                    | 0.76                    | 1.44 | 0.12 | 2.45   | Pink               | P42                    | 12                    | 42                 | 1 1/2                   | 10             |
| LCC1/0-38DWF-X | 1          |                             | 3/8                  | 1.00                    | 0.76                    | 1.44 | 0.12 | 2.58   | Pink               | P42                    | 12                    | 42                 | 1 1/2                   | 10             |
| LCC1/0-38WF-X  | 1          |                             | 3/8                  | 1.75                    | 0.76                    | 1.44 | 0.12 | 3.33   | Pink               | P42                    | 12                    | 42                 | 1 1/2                   | 10             |
| LCC1/0-12DWF-X | 1          |                             | 1/2                  | 1.00                    | 0.80                    | 1.44 | 0.12 | 2.85   | Pink               | P42                    | 12                    | 42                 | 1 1/2                   | 10             |
| LCC1/0-12WF-X  | 1          | 1/2                         | 1.75                 | 0.80                    | 1.44                    | 0.12 | 3.75 | Pink   | P42                | 12                     | 42                    | 1 1/2              | 10                      |                |
| LCC2/0-14AWF-X | 1          | 2/0 AWG                     | 1/4                  | 0.63                    | 0.85                    | 1.50 | 0.13 | 2.22   | Black              | P45                    | 13                    | 45                 | 1 9/16                  | 10             |
| LCC2/0-14BWF-X | 1          |                             | 1/4                  | 0.75                    | 0.85                    | 1.50 | 0.13 | 2.34   | Black              | P45                    | 13                    | 45                 | 1 9/16                  | 10             |
| LCC2/0-56DWF-X | 1          |                             | 5/16                 | 1.00                    | 0.85                    | 1.50 | 0.13 | 2.59   | Black              | P45                    | 13                    | 45                 | 1 9/16                  | 10             |
| LCC2/0-38DWF-X | 1          |                             | 3/8                  | 1.00                    | 0.85                    | 1.50 | 0.13 | 2.66   | Black              | P45                    | 13                    | 45                 | 1 9/16                  | 10             |
| LCC2/0-12DWF-X | 1          |                             | 1/2                  | 1.00                    | 0.85                    | 1.50 | 0.13 | 2.91   | Black              | P45                    | 13                    | 45                 | 1 9/16                  | 10             |
| LCC2/0-12WF-X  | 1          |                             | 1/2                  | 1.75                    | 0.85                    | 1.50 | 0.13 | 3.82   | Black              | P45                    | 13                    | 45                 | 1 9/16                  | 10             |
| LCC3/0-14BWF-X | 1          | 3/0 AWG                     | 1/4                  | 0.75                    | 0.96                    | 1.50 | 0.13 | 2.42   | Orange             | P50                    | 14                    | 50                 | 1 9/16                  | 10             |
| LCC3/0-56DWF-X | 1          |                             | 5/16                 | 1.00                    | 0.96                    | 1.50 | 0.13 | 2.67   | Orange             | P50                    | 14                    | 50                 | 1 9/16                  | 10             |
| LCC3/0-38DWF-X | 1          |                             | 3/8                  | 1.00                    | 0.96                    | 1.50 | 0.13 | 2.73   | Orange             | P50                    | 14                    | 50                 | 1 9/16                  | 10             |
| LCC3/0-12DWF-X | 1          |                             | 1/2                  | 1.00                    | 0.96                    | 1.50 | 0.13 | 2.98   | Orange             | P50                    | 14                    | 50                 | 1 9/16                  | 10             |
| LCC3/0-12WF-X  | 1          |                             | 1/2                  | 1.75                    | 0.96                    | 1.50 | 0.13 | 3.89   | Orange             | P50                    | 14                    | 50                 | 1 9/16                  | 10             |
| LCC4/0-14AWF-X | 1          |                             | 4/0 AWG              | 1/4                     | 0.63                    | 1.06 | 1.56 | 0.14   | 2.38               | Purple                 | P54                   | 15                 | 54                      | 1 5/8          |
| LCC4/0-14BWF-X | 1          | 1/4                         |                      | 0.75                    | 1.06                    | 1.56 | 0.14 | 2.50   | Purple             | P54                    | 15                    | 54                 | 1 5/8                   | 10             |
| LCC4/0-56DWF-X | 1          | 5/16                        |                      | 1.00                    | 1.06                    | 1.56 | 0.14 | 2.77   | Purple             | P54                    | 15                    | 54                 | 1 5/8                   | 10             |
| LCC4/0-38DWF-X | 1          | 3/8                         |                      | 1.00                    | 1.06                    | 1.56 | 0.14 | 2.84   | Purple             | P54                    | 15                    | 54                 | 1 5/8                   | 10             |
| LCC4/0-38WF-X  | 1          | 3/8                         |                      | 1.75                    | 1.06                    | 1.56 | 0.14 | 3.59   | Purple             | P54                    | 15                    | 54                 | 1 5/8                   | 10             |
| LCC4/0-12DWF-X | 1          | 1/2                         |                      | 1.00                    | 1.06                    | 1.56 | 0.14 | 3.07   | Purple             | P54                    | 15                    | 54                 | 1 5/8                   | 10             |
| LCC4/0-12WF-X  | 1          | 1/2                         | 1.75                 | 1.06                    | 1.56                    | 0.14 | 3.98 | Purple | P54                | 15                     | 54                    | 1 5/8              | 10                      |                |

‡See pages D3.62 – D3.65 for tool and die information.

\*\*Consult cable manufacturer for voltage stress relief instructions with applications greater than 2000 V.

◆NEMA hole sizes and spacing.





## Code Conductor, Two-Hole, Long Barrel with Window Lug, 90° Angle (continued)

| Part Number      | Figure No. | Copper Conductor Size | Stud Hole Size (In.) | Stud Hole Spacing (In.) | Figure Dimensions (In.) |      |      |      | Panduit Color Code | Panduit Die Index No.‡ | Burdny Die Index No.‡ | T&B Die Index No.‡ | Wire Strip Length (In.) | Std. Pkg. Qty. |
|------------------|------------|-----------------------|----------------------|-------------------------|-------------------------|------|------|------|--------------------|------------------------|-----------------------|--------------------|-------------------------|----------------|
|                  |            |                       |                      |                         | W                       | B    | T    | L    |                    |                        |                       |                    |                         |                |
| LCC250-56DWF-X   | 1          | 250 kcmil             | 5/16                 | 1.00                    | 1.17                    | 1.61 | 0.14 | 2.83 | Yellow             | P62                    | 16                    | 62                 | 1 11/16                 | 10             |
| LCC250-38DWF-X   | 1          |                       | 3/8                  | 1.00                    | 1.17                    | 1.61 | 0.14 | 2.90 | Yellow             | P62                    | 16                    | 62                 | 1 11/16                 | 10             |
| LCC250-12DWF-X   | 1          |                       | 1/2                  | 1.00                    | 1.17                    | 1.61 | 0.14 | 3.13 | Yellow             | P62                    | 16                    | 62                 | 1 11/16                 | 10             |
| ◆ LCC250-12WF-X  | 1          |                       | 1/2                  | 1.75                    | 1.17                    | 1.61 | 0.14 | 4.04 | Yellow             | P62                    | 16                    | 62                 | 1 11/16                 | 10             |
| ◆ LCC300-38DWF-X | 1          | 300 kcmil             | 3/8                  | 1.00                    | 1.19                    | 2.24 | 0.16 | 2.88 | White              | P66                    | 17                    | 66                 | 2 5/16                  | 10             |
| ◆ LCC300-12WF-X  | 1          |                       | 1/2                  | 1.75                    | 1.19                    | 2.24 | 0.16 | 4.06 | White              | P66                    | 17                    | 66                 | 2 5/16                  | 10             |
| LCC350-14BWF-X   | 1          | 350 kcmil             | 1/4                  | 0.75                    | 1.28                    | 2.24 | 0.17 | 2.46 | Red                | P71                    | 18                    | 71                 | 2 5/16                  | 10             |
| LCC350-38DWF-X   | 1          |                       | 3/8                  | 1.00                    | 1.28                    | 2.24 | 0.17 | 2.94 | Red                | P71                    | 18                    | 71                 | 2 5/16                  | 10             |
| ◆ LCC350-12WF-X  | 1          |                       | 1/2                  | 1.75                    | 1.28                    | 2.24 | 0.17 | 4.12 | Red                | P71                    | 18                    | 71                 | 2 5/16                  | 10             |
| LCC400-14BWF-6   | 1          | 400 kcmil             | 1/4                  | 0.75                    | 1.39                    | 2.30 | 0.18 | 2.54 | Blue               | P76                    | 19                    | 76                 | 2 3/8                   | 6              |
| LCC400-38DWF-6   | 1          |                       | 3/8                  | 1.00                    | 1.39                    | 2.30 | 0.18 | 3.02 | Blue               | P76                    | 19                    | 76                 | 2 3/8                   | 6              |
| ◆ LCC400-12WF-6  | 1          |                       | 1/2                  | 1.75                    | 1.39                    | 2.30 | 0.18 | 4.20 | Blue               | P76                    | 19                    | 76                 | 2 3/8                   | 6              |
| LCC500-14BWF-6   | 1          |                       | 500 kcmil            | 1/4                     | 0.75                    | 1.54 | 2.50 | 0.22 | 2.65               | Brown                  | P87                   | 20                 | 87                      | 2 9/16         |
| LCC500-38DWF-6   | 1          | 3/8                   |                      | 1.00                    | 1.54                    | 2.50 | 0.22 | 3.13 | Brown              | P87                    | 20                    | 87                 | 2 9/16                  | 6              |
| ◆ LCC500-12WF-6  | 1          | 1/2                   |                      | 1.75                    | 1.54                    | 2.50 | 0.22 | 4.31 | Brown              | P87                    | 20                    | 87                 | 2 9/16                  | 6              |
| ◆ LCC600-38DWF-6 | 1          | 600 kcmil             |                      | 3/8                     | 1.00                    | 1.70 | 2.69 | 0.26 | 3.26               | Green                  | P94                   | 22                 | 94                      | 2 3/4          |
| ◆ LCC600-12WF-6  | 1          |                       | 1/2                  | 1.75                    | 1.70                    | 2.69 | 0.26 | 4.44 | Green              | P94                    | 22                    | 94                 | 2 3/4                   | 6              |

‡See pages D3.62 – D3.65 for tool and die information.

\*\*Consult cable manufacturer for voltage stress relief instructions with applications greater than 2000 V.

◆NEMA hole sizes and spacing.



## Code Conductor, Two-Hole, Long Barrel with Window, Narrow Tongue Lug

For Use with Stranded Copper Conductors

### Type LCCN-W

- Narrow tongue width for limited space applications
- Long barrel maximizes number of crimps and provides premium wire pull-out strength and electrical performance
- Inspection window to visually assure full conductor insertion
- Color-coded barrels marked with Panduit and specified competitor die index numbers for proper crimp die selection
- Tin-plated to inhibit corrosion

- UL Listed and CSA Certified to 35 KV\*\* and temperature rated to 90°C when crimped with Panduit and specified competitor crimping tools and dies
- UL Listed and CSA Certified for wide wire range-taking capability when crimped with Panduit® Uni-Die™ Dieless Crimping Tools‡
- **Tested by Telcordia – meets NEBS Level 3**
- Meets J-STD-607-A and TIA-942 requirements for network systems grounding applications
- Available with NEMA hole sizes and spacing

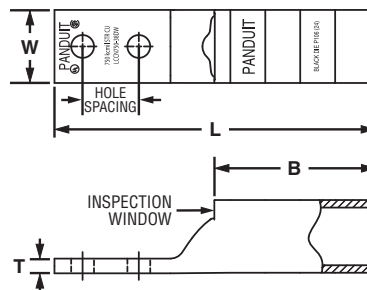

| Part Number     | Copper Conductor Size | Stud Hole Size (In.) | Stud Hole Spacing (In.) | Figure Dimensions (In.) |      |      |      | Panduit Color Code | Panduit Die Index No.‡ | Burdny Die Index No.‡ | T&B Die Index No.‡ | Wire Strip Length (In.) | Std. Pkg. Qty. |
|-----------------|-----------------------|----------------------|-------------------------|-------------------------|------|------|------|--------------------|------------------------|-----------------------|--------------------|-------------------------|----------------|
|                 |                       |                      |                         | W                       | B    | T    | L    |                    |                        |                       |                    |                         |                |
| LCCN750-38DW-6  | 750 kcmil             | 3/8                  | 1.00                    | 1.30                    | 2.88 | 0.28 | 5.72 | Black              | P106                   | 24                    | 106                | 2 15/16                 | 6              |
| ◆ LCCN750-12W-6 | 750 kcmil             | 1/2                  | 1.75                    | 1.30                    | 2.88 | 0.28 | 6.66 | Black              | P106                   | 24                    | 106                | 2 15/16                 | 6              |

‡See pages D3.62 – D3.65 for tool and die information.

\*\*Consult cable manufacturer for voltage stress relief instructions with applications greater than 2000 V.

◆NEMA hole sizes and spacing.

A. System Overview



## Code Conductor, Two-Hole, Long Barrel with Corona Relief Taper Lug

B1. Cable Ties

**To Facilitate Use with Stranded Copper Conductors in Applications of 5000 V or More**

### Type LCCH

B2. Cable Accessories

- Externally chamfered barrel end inhibits Corona effect when used in high voltage applications
- Long barrel maximizes number of crimps and provides premium wire pull-out strength and electrical performance
- Color-coded barrels marked with Panduit and specified competitor die index numbers for proper crimp die selection
- Enclosed barrel prevents corrosive material from entering barrel when used in harsh environments
- Tin-plated to inhibit corrosion
- UL Listed and CSA Certified to 35 KV\*\* and temperature rated to 90°C when crimped with Panduit and specified competitor crimping tools and dies
- Available with NEMA hole sizes and spacing

B3. Stainless Steel Ties

C1. Wiring Duct



C2. Surface Raceway



Corona Relief Taper

C3. Abrasion Protection

C4. Cable Management

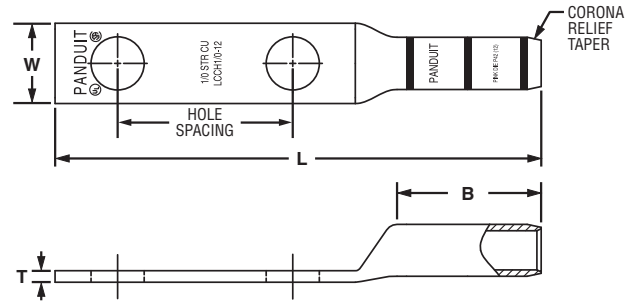

D1. Terminals

D2. Power Connectors

D3. Grounding Connectors

| Part Number     | Copper Conductor Size | Stud Hole Size (In.) | Stud Hole Spacing (In.) | Figure Dimensions (In.) |      |      |      | Panduit Color Code | Panduit Die Index No.‡ | Burdny Die Index No.‡ | T&B Die Index No.‡ | Wire Strip Length (In.) | Std. Pkg. Qty. |
|-----------------|-----------------------|----------------------|-------------------------|-------------------------|------|------|------|--------------------|------------------------|-----------------------|--------------------|-------------------------|----------------|
|                 |                       |                      |                         | W                       | B    | T    | L    |                    |                        |                       |                    |                         |                |
| LCCH1/0-12-X    | 1/0 AWG               | 1/2                  | 1.75                    | 0.80                    | 1.44 | 0.12 | 4.86 | Pink               | P42                    | 12                    | 42                 | 1 1/2                   | 10             |
| LCCH2/0-12-X    | 2/0 AWG               | 1/2                  | 1.75                    | 0.85                    | 1.50 | 0.13 | 4.98 | Black              | P45                    | 13                    | 45                 | 1 9/16                  | 10             |
| LCCH3/0-12-X    | 3/0 AWG               | 1/2                  | 1.75                    | 0.96                    | 1.50 | 0.13 | 5.03 | Orange             | P50                    | 14                    | 50                 | 1 9/16                  | 10             |
| ◆ LCCH4/0-12-X  | 4/0 AWG               | 1/2                  | 1.75                    | 1.06                    | 1.56 | 0.14 | 5.13 | Purple             | P54                    | 15                    | 54                 | 1 5/8                   | 10             |
| ◆ LCCH250-12-X  | 250 kcmil             | 1/2                  | 1.75                    | 1.17                    | 1.61 | 0.14 | 5.23 | Yellow             | P62                    | 16                    | 62                 | 1 1/16                  | 10             |
| ◆ LCCH300-12-X  | 300 kcmil             | 1/2                  | 1.75                    | 1.19                    | 2.24 | 0.16 | 5.94 | White              | P66                    | 17                    | 66                 | 2 5/16                  | 10             |
| ◆ LCCH350-12-X  | 350 kcmil             | 1/2                  | 1.75                    | 1.28                    | 2.24 | 0.17 | 5.99 | Red                | P71                    | 18                    | 71                 | 2 5/16                  | 10             |
| ◆ LCCH400-12-6  | 400 kcmil             | 1/2                  | 1.75                    | 1.39                    | 2.30 | 0.18 | 6.10 | Blue               | P76                    | 19                    | 76                 | 2 3/8                   | 6              |
| ◆ LCCH500-12-6  | 500 kcmil             | 1/2                  | 1.75                    | 1.54                    | 2.50 | 0.22 | 6.36 | Brown              | P87                    | 20                    | 87                 | 2 9/16                  | 6              |
| ◆ LCCH600-12-6  | 600 kcmil             | 1/2                  | 1.75                    | 1.70                    | 2.69 | 0.26 | 6.63 | Green              | P94                    | 22                    | 94                 | 2 3/4                   | 6              |
| ◆ LCCH750-12-6  | 750 kcmil             | 1/2                  | 1.75                    | 1.89                    | 2.88 | 0.26 | 7.04 | Black              | P106                   | 24                    | 106                | 2 15/16                 | 6              |
| ◆ LCCH1000-12-3 | 1000 kcmil            | 1/2                  | 1.75                    | 2.17                    | 3.00 | 0.32 | 7.29 | White              | P125                   | 27                    | 125                | 3 1/16                  | 3              |

‡See pages D3.66, D3.67 for tool and die information.

\*\*Consult cable manufacturer for voltage stress relief instructions with applications greater than 2000 V.

◆NEMA hole sizes and spacing.

E1. Labeling Systems

E2. Labels

E3. Pre-Printed & Write-On Markers

E4. Permanent Identification

E5. Lockout/Tagout & Safety Solutions

F. Index



## Code Conductor, Blank Tongue, Long Barrel Lug

For Use with Stranded Copper Conductors

### Type LCC-00

- Long barrel maximizes number of crimps and provides premium wire pull-out strength and electrical performance
- Color-coded barrels marked with Panduit and specified competitor die index numbers for proper crimp die selection
- Enclosed barrel prevents corrosive material from entering barrel when used in harsh environments
- Tin-plated to inhibit corrosion
- UL Recognized and CSA Certified to 35 KV\*\* and temperature rated to 90°C when crimped with Panduit and specified competitor crimping tools and dies

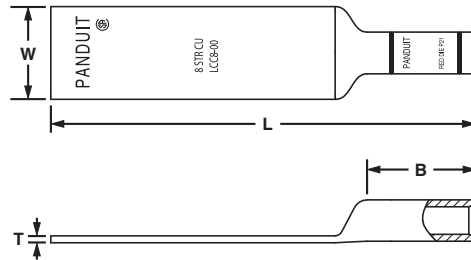

Figure 1

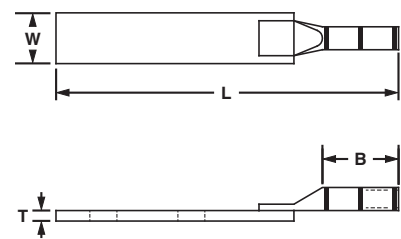

Figure 2: Two-Piece Brazed Tongue Construction

| Part Number  | Figure No. | Copper Conductor Size       | Figure Dimensions (In.) |      |      |      | Panduit Color Code | Panduit Die Index No. | Burdny Die Index No.‡ | T&B Die Index No.‡ | Wire Strip Length (In.) | Std. Pkg. Qty. |
|--------------|------------|-----------------------------|-------------------------|------|------|------|--------------------|-----------------------|-----------------------|--------------------|-------------------------|----------------|
|              |            |                             | W                       | B    | T    | L    |                    |                       |                       |                    |                         |                |
| LCC8-00-L    | 1          | #8 AWG                      | 0.60                    | 0.70 | 0.05 | 2.75 | Red                | P21                   | 49                    | 21                 | 3/4                     | 50             |
| LCC6-00-L    | 2          | #6 AWG                      | 0.75                    | 1.13 | 0.16 | 5.00 | Blue               | P24                   | 7                     | 24                 | 1 1/8                   | 50             |
| LCC4-00-L    | 2          | #4 – #3 AWG STR, #2 AWG SOL | 0.75                    | 1.13 | 0.16 | 5.06 | Gray               | P29                   | 8                     | 29                 | 1 1/8                   | 50             |
| LCC2-00-Q    | 1          | #2 AWG                      | 0.75                    | 1.16 | 0.08 | 4.51 | Brown              | P33                   | 10                    | 33                 | 1 1/4                   | 25             |
| LCC1-00-E    | 1          | #1 AWG                      | 0.75                    | 1.36 | 0.09 | 4.74 | Green              | P37                   | 11                    | 37                 | 1 7/16                  | 20             |
| LCC1/0-00-X  | 1          | 1/0 AWG                     | 0.80                    | 1.44 | 0.12 | 4.86 | Pink               | P42                   | 12                    | 42                 | 1 1/2                   | 10             |
| LCC2/0-00-X  | 1          | 2/0 AWG                     | 0.85                    | 1.50 | 0.13 | 4.98 | Black              | P45                   | 13                    | 45                 | 1 9/16                  | 10             |
| LCC3/0-00-X  | 1          | 3/0 AWG                     | 0.96                    | 1.50 | 0.13 | 5.03 | Orange             | P50                   | 14                    | 50                 | 1 9/16                  | 10             |
| LCC4/0-00-X  | 1          | 4/0 AWG                     | 1.06                    | 1.56 | 0.14 | 5.13 | Purple             | P54                   | 15                    | 54                 | 1 5/8                   | 10             |
| LCC250-00-X  | 1          | 250 kcmil                   | 1.17                    | 1.60 | 0.14 | 5.23 | Yellow             | P62                   | 16                    | 62                 | 1 11/16                 | 10             |
| LCC300-00-X  | 1          | 300 kcmil                   | 1.19                    | 2.23 | 0.16 | 5.94 | White              | P66                   | 17                    | 66                 | 2 5/16                  | 10             |
| LCC350-00-X  | 1          | 350 kcmil                   | 1.28                    | 2.23 | 0.17 | 5.99 | Red                | P71                   | 18                    | 71                 | 2 5/16                  | 10             |
| LCC400-00-6  | 1          | 400 kcmil                   | 1.39                    | 2.29 | 0.18 | 6.10 | Blue               | P76                   | 19                    | 76                 | 2 3/8                   | 6              |
| LCC500-00-6  | 1          | 500 kcmil                   | 1.54                    | 2.49 | 0.22 | 6.36 | Brown              | P87                   | 20                    | 87                 | 2 9/16                  | 6              |
| LCC600-00-6  | 1          | 600 kcmil                   | 1.70                    | 2.68 | 0.26 | 6.63 | Green              | P94                   | 22                    | 94                 | 2 3/4                   | 6              |
| LCC750-00-6  | 1          | 750 kcmil                   | 1.89                    | 2.87 | 0.26 | 7.04 | Black              | P106                  | 24                    | 106                | 2 15/16                 | 6              |
| LCC1000-00-3 | 1          | 1000 kcmil                  | 2.17                    | 2.99 | 0.32 | 7.29 | White              | P125                  | 27                    | 125                | 3 1/16                  | 3              |

‡See pages D3.62 – D3.65 for tool and die information.

\*\*Consult cable manufacturer for voltage stress relief instructions with applications greater than 2000 V.

A. System Overview

B1. Cable Ties

B2. Cable Accessories

B3. Stainless Steel Ties

C1. Wiring Duct

C2. Surface Raceway

C3. Abrasion Protection

C4. Cable Management

D1. Terminals

D2. Power Connectors

D3. Grounding Connectors

E1. Labeling Systems

E2. Labels

E3. Pre-Printed & Write-On Markers

E4. Permanent Identification

E5. Lockout/Tagout & Safety Solutions

F. Index

A. System Overview



## Code Conductor, Blank Tongue, Long Barrel with Window Lug

B1. Cable Ties

### For Use with Stranded Copper Conductors Type LCC-00W

B2. Cable Accessories

B3. Stainless Steel Ties

- Long barrel maximizes number of crimps and provides premium wire pull-out strength and electrical performance
- Inspection window to visually assure full conductor insertion
- Color-coded barrels marked with Panduit and specified competitor die index numbers for proper crimp die selection
- Enclosed barrel prevents corrosive material from entering barrel when used in harsh environments
- Tin-plated to inhibit corrosion
- UL Recognized and CSA Certified to 35 KV\*\* and temperature rated to 90°C when crimped with Panduit and specified competitor crimping tools and dies

C1. Wiring Duct



C2. Surface Raceway

C3. Abrasion Protection

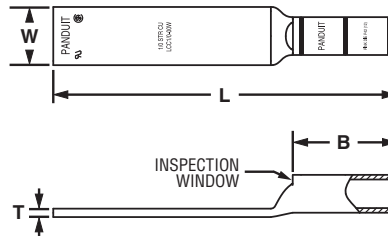

C4. Cable Management

| Part Number         | Copper Conductor Size | Figure Dimensions (In.) |      |      |      | Panduit Color Code | Panduit Die Index No.‡ | Burdny Die Index No.‡ | T&B Die Index No.‡ | Wire Strip Length (In.) | Std. Pkg. Qty. |
|---------------------|-----------------------|-------------------------|------|------|------|--------------------|------------------------|-----------------------|--------------------|-------------------------|----------------|
|                     |                       | W                       | B    | T    | L    |                    |                        |                       |                    |                         |                |
| <b>LCC8-00W-L</b>   | #8 AWG                | 0.60                    | 0.70 | 0.05 | 2.70 | Red                | P21                    | 49                    | 21                 | 3/4                     | 50             |
| <b>LCC6-00W-L</b>   | #6 AWG                | 0.62                    | 1.07 | 0.06 | 3.08 | Blue               | P24                    | 7                     | 24                 | 1 1/8                   | 50             |
| <b>LCC4-00W-L</b>   | #4 AWG                | 0.62                    | 1.05 | 0.08 | 3.09 | Gray               | P29                    | 8                     | 29                 | 1 1/8                   | 50             |
| <b>LCC2-00W-Q</b>   | #2 AWG                | 0.75                    | 1.16 | 0.08 | 4.41 | Brown              | P33                    | 10                    | 33                 | 1 1/4                   | 25             |
| <b>LCC1-00W-E</b>   | #1 AWG                | 0.75                    | 1.36 | 0.09 | 4.63 | Green              | P37                    | 11                    | 37                 | 1 7/16                  | 20             |
| <b>LCC1/0-00W-X</b> | 1/0 AWG               | 0.80                    | 1.44 | 0.12 | 4.74 | Pink               | P42                    | 12                    | 42                 | 1 1/2                   | 10             |
| <b>LCC2/0-00W-X</b> | 2/0 AWG               | 0.85                    | 1.50 | 0.13 | 4.83 | Black              | P45                    | 13                    | 45                 | 1 9/16                  | 10             |
| <b>LCC3/0-00W-X</b> | 3/0 AWG               | 0.96                    | 1.50 | 0.13 | 4.87 | Orange             | P50                    | 14                    | 50                 | 1 9/16                  | 10             |
| <b>LCC4/0-00W-X</b> | 4/0 AWG               | 1.06                    | 1.56 | 0.14 | 4.95 | Purple             | P54                    | 15                    | 54                 | 1 5/8                   | 10             |
| <b>LCC250-00W-X</b> | 250 kcmil             | 1.17                    | 1.61 | 0.14 | 5.04 | Yellow             | P62                    | 16                    | 62                 | 1 11/16                 | 10             |
| <b>LCC300-00W-X</b> | 300 kcmil             | 1.19                    | 2.24 | 0.16 | 5.73 | White              | P66                    | 17                    | 66                 | 2 5/16                  | 10             |
| <b>LCC350-00W-X</b> | 350 kcmil             | 1.28                    | 2.24 | 0.17 | 5.77 | Red                | P71                    | 18                    | 71                 | 2 5/16                  | 10             |
| <b>LCC400-00W-6</b> | 400 kcmil             | 1.28                    | 2.30 | 0.17 | 5.85 | Blue               | P76                    | 19                    | 76                 | 2 3/8                   | 6              |
| <b>LCC500-00W-6</b> | 500 kcmil             | 1.54                    | 2.50 | 0.22 | 6.13 | Brown              | P87                    | 20                    | 87                 | 2 9/16                  | 6              |
| <b>LCC600-00W-6</b> | 600 kcmil             | 1.70                    | 2.69 | 0.26 | 6.37 | Green              | P94                    | 22                    | 94                 | 2 3/4                   | 6              |

‡See pages D3.62 – D3.65 for tool and die information.

\*\*Consult cable manufacturer for voltage stress relief instructions with applications greater than 2000 V.

E2. Labels

E3. Pre-Printed & Write-On Markers

E4. Permanent Identification

E5. Lockout/Tagout & Safety Solutions

F. Index



## Code Conductor, Short Barrel, Butt Splice

**For Use with Stranded Copper Conductors**

### Type SCSS

- Short barrel for limited space applications
- Color-coded barrels marked with Panduit and specified competitor die index numbers for proper crimp die selection
- Internal wire stops to prevent over-insertion of conductor
- Tin-plated to inhibit corrosion
- UL Listed and CSA Certified to 35 KV\*\* and temperature rated to 90°C when crimped with Panduit and specified competitor crimping tools and dies
- Tested by Telcordia – meets NEBS Level 3

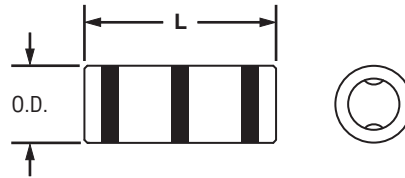

| Part Number | Copper Conductor Size | Figure Dimensions (In.) |      | Panduit Color Code | Panduit Die Index No.‡ | Burdy Die Index No.‡ | T&B Die Index No.‡ | Wire Strip Length (In.) | Std. Pkg. Qty. |
|-------------|-----------------------|-------------------------|------|--------------------|------------------------|----------------------|--------------------|-------------------------|----------------|
|             |                       | Barrel O.D.             | L    |                    |                        |                      |                    |                         |                |
| SCSS8-L     | #8 AWG                | 0.27                    | 1.00 | Red                | P21                    | 49                   | 21                 | 7/16                    | 50             |
| SCSS6-L     | #6 AWG                | 0.31                    | 1.00 | Blue               | P24                    | 7                    | 24                 | 7/16                    | 50             |
| SCSS4-L     | #4 AWG                | 0.38                    | 1.00 | Gray               | P29                    | 8                    | 29                 | 7/16                    | 50             |
| SCSS2-Q     | #2 AWG                | 0.42                    | 1.25 | Brown              | P33                    | 10                   | 33                 | 9/16                    | 25             |
| SCSS1-Q     | #1 AWG                | 0.46                    | 1.44 | Green              | P37                    | 11                   | 37                 | 11/16                   | 25             |
| SCSS1/0-X   | 1/0 AWG               | 0.52                    | 1.44 | Pink               | P42                    | 12                   | 42                 | 11/16                   | 10             |
| SCSS2/0-X   | 2/0 AWG               | 0.58                    | 1.56 | Black              | P45                    | 13                   | 45                 | 3/4                     | 10             |
| SCSS3/0-X   | 3/0 AWG               | 0.64                    | 1.69 | Orange             | P50                    | 14                   | 50                 | 3/4                     | 10             |
| SCSS4/0-X   | 4/0 AWG               | 0.71                    | 1.81 | Purple             | P54                    | 15                   | 54                 | 13/16                   | 10             |
| SCSS250-X   | 250 kcmil             | 0.77                    | 2.19 | Yellow             | P62                    | 16                   | 62                 | 1 1/16                  | 10             |

‡See pages D3.56, D3.57 for tool and die information.

\*\*Consult cable manufacturer for voltage stress relief instructions with applications greater than 2000 V.

A. System Overview

B1. Cable Ties

B2. Cable Accessories

B3. Stainless Steel Ties

C1. Wiring Duct

C2. Surface Raceway

C3. Abrasion Protection

C4. Cable Management

D1. Terminals

D2. Power Connectors

D3. Grounding Connectors

E1. Labeling Systems

E2. Labels

E3. Pre-Printed & Write-On Markers

E4. Permanent Identification

E5. Lockout/Tagout & Safety Solutions

F. Index

A. System Overview



## Code Conductor, Standard Barrel, Butt Splice

B1. Cable Ties

### For Use with Stranded Copper Conductors

B2. Cable Accessories

#### Type SCS

- Color-coded barrels marked with Panduit and specified competitor die index numbers for proper crimp die selection
- Internal wire stops to prevent over-insertion of conductor
- Tin-plated to inhibit corrosion
- UL Listed and CSA Certified to 35 KV\*\* and temperature rated to 90°C when crimped with Panduit and specified competitor crimping tools and dies
- UL Listed and CSA Certified for wide wire range-taking capability when crimped with Panduit® Uni-Die™ Dieless Crimping Tools‡
- Tested by Telcordia – meets NEBS Level 3
- American Bureau of Shipping approved

C1. Wiring Duct



C2. Surface Raceway

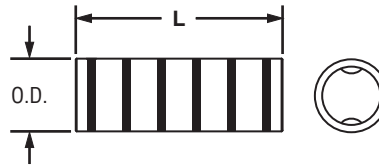

C3. Abrasion Protection

C4. Cable Management

| Part Number      | Copper Conductor Size       | Figure Dimensions (In.) |      | Panduit Color Code | Panduit Die Index No.‡ | Burndy Die Index No.‡ | T&B Die Index No.‡ | Wire Strip Length (In.) | Std. Pkg. Qty. |
|------------------|-----------------------------|-------------------------|------|--------------------|------------------------|-----------------------|--------------------|-------------------------|----------------|
|                  |                             | Barrel O.D.             | L    |                    |                        |                       |                    |                         |                |
| <b>SCS8-L</b>    | #8 AWG                      | 0.27                    | 1.50 | Red                | P21                    | 49                    | 21                 | 11/16                   | 50             |
| <b>SCS6-L</b>    | #6 AWG                      | 0.31                    | 1.75 | Blue               | P24                    | 7                     | 24                 | 13/16                   | 50             |
| <b>SCS4-L</b>    | #4 – #3 AWG STR, #2 AWG SOL | 0.38                    | 1.75 | Gray               | P29                    | 8                     | 29                 | 13/16                   | 50             |
| <b>SCS2-Q</b>    | #2 AWG                      | 0.42                    | 1.87 | Brown              | P33                    | 10                    | 33                 | 7/8                     | 25             |
| <b>SCS1-E</b>    | #1 AWG                      | 0.47                    | 1.87 | Green              | P37                    | 11                    | 37                 | 7/8                     | 20             |
| <b>SCS1/0-X</b>  | 1/0 AWG                     | 0.52                    | 1.87 | Pink               | P42                    | 12                    | 42                 | 7/8                     | 10             |
| <b>SCS2/0-X</b>  | 2/0 AWG                     | 0.58                    | 2.00 | Black              | P45                    | 13                    | 45                 | 15/16                   | 10             |
| <b>SCS3/0-X</b>  | 3/0 AWG                     | 0.64                    | 2.12 | Orange             | P50                    | 14                    | 50                 | 1                       | 10             |
| <b>SCS4/0-X</b>  | 4/0 AWG                     | 0.71                    | 2.12 | Purple             | P54                    | 15                    | 54                 | 1                       | 10             |
| <b>SCS250-X</b>  | 250 kcmil                   | 0.77                    | 2.25 | Yellow             | P62                    | 16                    | 62                 | 1 1/16                  | 10             |
| <b>SCS300-X</b>  | 300 kcmil                   | 0.81                    | 2.25 | White              | P66                    | 17                    | 66                 | 1 1/16                  | 10             |
| <b>SCS350-X</b>  | 350 kcmil                   | 0.87                    | 2.37 | Red                | P71                    | 18                    | 71                 | 1 1/8                   | 10             |
| <b>SCS400-6</b>  | 400 kcmil                   | 0.95                    | 2.50 | Blue               | P76                    | 19                    | 76                 | 1 3/16                  | 6              |
| <b>SCS500-6</b>  | 500 kcmil                   | 1.05                    | 2.87 | Brown              | P87                    | 20                    | 87                 | 1 3/8                   | 6              |
| <b>SCS600-6</b>  | 600 kcmil                   | 1.18                    | 2.87 | Green              | P94                    | 22                    | 94                 | 1 3/8                   | 6              |
| <b>SCS750-6</b>  | 750 kcmil                   | 1.29                    | 3.37 | Black              | P106                   | 24                    | 106                | 1 5/8                   | 6              |
| <b>SCS1000-3</b> | 1000 kcmil                  | 1.50                    | 3.87 | White              | P125                   | 27                    | 125                | 1 7/8                   | 3              |

D1. Terminals

D2. Power Connectors

D3. Grounding Connectors

E1. Labeling Systems

E2. Labels

E3. Pre-Printed & Write-On Markers

E4. Permanent Identification

E5. Lockout/Tagout & Safety Solutions

F. Index

‡See pages D3.58 – D3.61 for tool and die information.

\*\*Consult cable manufacturer for voltage stress relief instructions with applications greater than 2000 V.





## Code Conductor, Long Barrel, Butt Splice

For Use with Stranded Copper Conductors

### Type SCL

- Long barrel maximizes the number of crimps and provides premium wire pull-out strength and electrical performance
- Color-coded barrels marked with Panduit and specified competitor die index numbers for proper crimp die selection
- Internal wire stops to prevent over-insertion of conductor
- Tin-plated to inhibit corrosion
- UL Listed and CSA Certified to 35 KV\*\* and temperature rated to 90°C when crimped with Panduit and specified competitor crimping tools and dies
- UL Listed and CSA Certified for wide wire range-taking capability when crimped with Panduit® Uni-Die™ Dieless Crimping Tools‡
- Tested by Telcordia – meets NEBS Level 3

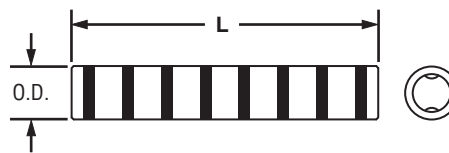

| Part Number | Copper Conductor Size          | Figure Dimensions (In.) |      | Panduit Color Code | Panduit Die Index No.‡ | Burdny Die Index No.‡ | T&B Die Index No.‡ | Wire Strip Length (In.) | Std. Pkg. Qty. |
|-------------|--------------------------------|-------------------------|------|--------------------|------------------------|-----------------------|--------------------|-------------------------|----------------|
|             |                                | Barrel O.D.             | L    |                    |                        |                       |                    |                         |                |
| SCL8-L      | #8 AWG                         | 0.27                    | 2.25 | Red                | P21                    | 49                    | 21                 | 1 1/16                  | 50             |
| SCL6-L      | #6 AWG                         | 0.31                    | 2.38 | Blue               | P24                    | 7                     | 24                 | 1 1/8                   | 50             |
| SCL4-L      | #4 – #3 AWG STR,<br>#2 AWG SOL | 0.38                    | 2.38 | Gray               | P29                    | 8                     | 29                 | 1 1/8                   | 50             |
| SCL2-Q      | #2 AWG                         | 0.42                    | 2.62 | Brown              | P33                    | 10                    | 33                 | 1 1/4                   | 25             |
| SCL1-E      | #1 AWG                         | 0.47                    | 2.87 | Green              | P37                    | 11                    | 37                 | 1 3/8                   | 20             |
| SCL1/0-X    | 1/0 AWG                        | 0.52                    | 2.87 | Pink               | P42                    | 12                    | 42                 | 1 3/8                   | 10             |
| SCL2/0-X    | 2/0 AWG                        | 0.58                    | 3.13 | Black              | P45                    | 13                    | 45                 | 1 1/2                   | 10             |
| SCL3/0-X    | 3/0 AWG                        | 0.64                    | 3.12 | Orange             | P50                    | 14                    | 54                 | 1 1/2                   | 10             |
| SCL4/0-X    | 4/0 AWG                        | 0.71                    | 3.37 | Purple             | P54                    | 15                    | 54                 | 1 5/8                   | 10             |
| SCL250-X    | 250 kcmil                      | 0.77                    | 3.38 | Yellow             | P62                    | 16                    | 62                 | 1 5/8                   | 10             |
| SCL300-X    | 300 kcmil                      | 0.81                    | 4.12 | White              | P66                    | 17                    | 66                 | 2                       | 10             |
| SCL350-X    | 350 kcmil                      | 0.88                    | 4.12 | Red                | P71                    | 18                    | 71                 | 2                       | 10             |
| SCL400-6    | 400 kcmil                      | 0.95                    | 4.37 | Blue               | P76                    | 19                    | 76                 | 2 1/8                   | 6              |
| SCL500-6    | 500 kcmil                      | 1.06                    | 4.62 | Brown              | P87                    | 20                    | 87                 | 2 1/4                   | 6              |
| SCL600-6    | 600 kcmil                      | 1.19                    | 5.50 | Green              | P94                    | 22                    | 94                 | 2 11/16                 | 6              |
| SCL750-6    | 750 kcmil                      | 1.30                    | 5.87 | Black              | P106                   | 24                    | 106                | 2 7/8                   | 6              |
| SCL1000-3   | 1000 kcmil                     | 1.50                    | 6.12 | White              | P125                   | 27                    | 125                | 3                       | 3              |

‡See pages D3.62 – D3.65 for tool and die information.

\*\*Consult cable manufacturer for voltage stress relief instructions with applications greater than 2000 V.

A. System Overview

B1. Cable Ties

B2. Cable Accessories

B3. Stainless Steel Ties

C1. Wiring Duct

C2. Surface Raceway

C3. Abrasion Protection

C4. Cable Management

D1. Terminals

D2. Power Connectors

D3. Grounding Connectors

E1. Labeling Systems

E2. Labels

E3. Pre-Printed & Write-On Markers

E4. Permanent Identification

E5. Lockout/Tagout & Safety Solutions

F. Index

A. System Overview



## Code Conductor, Long Barrel with Corona Relief Taper Splice

B1. Cable Ties

**To Facilitate Use with Stranded Copper Conductors in Applications of 5000 V or More**

### Type SCH

B2. Cable Accessories

- Externally chamfered barrel end inhibits Corona effect when used in high voltage applications
- Color-coded barrels marked with Panduit and specified competitor die index numbers for proper crimp die selection
- Internal wire stops to prevent over-insertion of conductor
- Tin-plated to inhibit corrosion
- UL Listed and CSA Certified to 35 KV\*\* and temperature rated to 90°C when crimped with Panduit and specified competitor crimping tools and dies

B3. Stainless Steel Ties

C1. Wiring Duct



C2. Surface Raceway

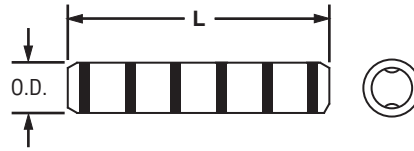

C3. Abrasion Protection

C4. Cable Management

| Part Number | Copper Conductor Size | Figure Dimensions (In.) |      | Panduit Color Code | Panduit Die Index No.‡ | Burdny Die Index No.‡ | T&B Die Index No.‡ | Wire Strip Length (In.) | Std. Pkg. Qty. |
|-------------|-----------------------|-------------------------|------|--------------------|------------------------|-----------------------|--------------------|-------------------------|----------------|
|             |                       | Barrel O.D.             | L    |                    |                        |                       |                    |                         |                |
| SCH6-L      | #6 AWG                | 0.31                    | 1.97 | Blue               | P24                    | 7                     | 24                 | 15/16                   | 50             |
| SCH4-L      | #4 AWG                | 0.38                    | 1.97 | Gray               | P29                    | 8                     | 29                 | 15/16                   | 50             |
| SCH2-Q      | #2 AWG                | 0.42                    | 2.13 | Brown              | P33                    | 10                    | 33                 | 1                       | 25             |
| SCH1-E      | #1 AWG                | 0.47                    | 2.13 | Green              | P37                    | 11                    | 37                 | 1                       | 20             |
| SCH1/0-X    | 1/0 AWG               | 0.52                    | 2.13 | Pink               | P42                    | 12                    | 42                 | 1                       | 10             |
| SCH2/0-X    | 2/0 AWG               | 0.58                    | 2.28 | Black              | P45                    | 13                    | 45                 | 1 1/16                  | 10             |
| SCH3/0-X    | 3/0 AWG               | 0.64                    | 2.47 | Orange             | P50                    | 14                    | 50                 | 1 3/16                  | 10             |
| SCH4/0-X    | 4/0 AWG               | 0.71                    | 2.54 | Purple             | P54                    | 15                    | 54                 | 1 3/16                  | 10             |
| SCH250-X    | 250 kcmil             | 0.77                    | 2.63 | Yellow             | P62                    | 16                    | 62                 | 1 1/4                   | 10             |
| SCH300-X    | 300 kcmil             | 0.82                    | 2.69 | White              | P66                    | 17                    | 66                 | 2                       | 10             |
| SCH350-X    | 350 kcmil             | 0.88                    | 2.84 | Red                | P71                    | 18                    | 71                 | 2                       | 10             |
| SCH500-6    | 500 kcmil             | 1.06                    | 3.53 | Brown              | P87                    | 20                    | 87                 | 2 1/4                   | 6              |
| SCH750-6    | 750 kcmil             | 1.30                    | 4.28 | Black              | P106                   | 24                    | 106                | 2 7/8                   | 6              |
| SCH1000-3   | 1000 kcmil            | 1.50                    | 5.06 | White              | P125                   | 27                    | 125                | 3                       | 3              |

‡See pages D3.66, D3.67 for tool and die information.

\*\*Consult cable manufacturer for voltage stress relief instructions with applications greater than 2000 V.

E2. Labels

E3. Pre-Printed & Write-On Markers

E4. Permanent Identification

E5. Lockout/Tagout & Safety Solutions

F. Index

## Code Conductor, Long Barrel, T Splice

### For Copper-to-Copper Stranded Conductors

#### Type SCT

- Provides a means of connecting the run conductor and taking off a perpendicular tap
- Long barrel maximizes number of crimps and provides premium wire pull-out strength and electrical performance

- Run conductor size and tap conductor size marked on each barrel
- 90°C temperature rated and for use up to 600 V when crimped with Panduit and specified competitor crimping tools and dies

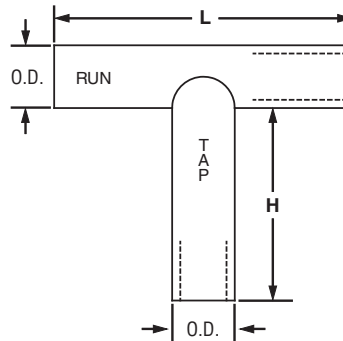

| Part Number | Copper Conductor Size |           | Run O.D. | Tap O.D. | Figure Dimensions (In.) |      | Panduit Color Code and Die Index No.‡ |            | Wire Strip Length (In.) |           | Std. Pkg. Qty. |
|-------------|-----------------------|-----------|----------|----------|-------------------------|------|---------------------------------------|------------|-------------------------|-----------|----------------|
|             | Run                   | Tap       |          |          | H                       | L    | Run                                   | Tap        | Run                     | Tap       |                |
|             | SCT2-2                | #2 AWG    |          |          | #2 AWG                  | 0.42 | 0.42                                  | 1.50       | 3.88                    | Brown P33 |                |
| SCT1/0-1/0  | 1/0 AWG               | 1/0 AWG   | 0.51     | 0.51     | 1.50                    | 4.00 | Pink P42                              | Pink P42   | 2 1/16                  | 1 9/16    | 1              |
| SCT2/0-2/0  | 2/0 AWG               | 2/0 AWG   | 0.56     | 0.56     | 1.50                    | 4.00 | Black P45                             | Black P45  | 2 1/16                  | 1 9/16    | 1              |
| SCT4/0-1/0  | 4/0 AWG               | 1/0 AWG   | 0.69     | 0.51     | 1.50                    | 4.00 | Purple P54                            | Pink P42   | 2 1/16                  | 1 9/16    | 1              |
| SCT4/0-4/0  | 4/0 AWG               | 4/0 AWG   | 0.69     | 0.69     | 1.63                    | 4.19 | Purple P54                            | Purple P54 | 2 1/8                   | 1 11/16   | 1              |
| SCT250-250  | 250 kcmil             | 250 kcmil | 0.75     | 0.75     | 1.63                    | 4.25 | Yellow P62                            | Yellow P62 | 2 3/16                  | 1 11/16   | 1              |
| SCT300-300  | 300 kcmil             | 300 kcmil | 0.81     | 0.81     | 2.00                    | 5.44 | White P66                             | White P66  | 2 13/16                 | 2 1/16    | 1              |
| SCT350-350  | 350 kcmil             | 350 kcmil | 0.88     | 0.88     | 2.00                    | 5.50 | Red P71                               | Red P71    | 2 13/16                 | 2 1/16    | 1              |
| SCT500-4/0  | 500 kcmil             | 4/0 AWG   | 1.06     | 0.69     | 2.25                    | 5.81 | Brown P87                             | Purple P54 | 2 15/16                 | 2 5/16    | 1              |
| SCT500-500  | 500 kcmil             | 500 kcmil | 1.06     | 1.06     | 2.50                    | 6.06 | Brown P87                             | Brown P87  | 3 1/8                   | 2 9/16    | 1              |

‡See pages D3.68, D3.69 for Panduit, Burndy and Thomas and Betts tool and die information.

A. System Overview

B1. Cable Ties

B2. Cable Accessories

B3. Stainless Steel Ties

C1. Wiring Duct

C2. Surface Raceway

C3. Abrasion Protection

C4. Cable Management

D1. Terminals

D2. Power Connectors

D3. Grounding Connectors

E1. Labeling Systems

E2. Labels

E3. Pre-Printed & Write-On Markers

E4. Permanent Identification

E5. Lockout/Tagout & Safety Solutions

F. Index

A. System Overview



## Code Conductor, Color-Coded Parallel Splice

B1. Cable Ties

### For Use with Stranded Copper Conductors

#### Type PSC

- Industry recognized color-coding allows proper part selection and quick identification of crimping dies to speed installation
- Large easy-to-read part numbering for verification in demanding low light conditions
- Tin-plated to inhibit corrosion
- UL Listed and CSA Certified to 35 KV\*\* and temperature rated to 90°C when crimped with Panduit dieless and die type crimping tools
- Single crimp design speeds installation and reduces labor costs
- Chamfered on both ends to facilitate fast and easy conductor insertion to speed installation

B2. Cable Accessories

B3. Stainless Steel Ties

C1. Wiring Duct

C2. Surface Raceway

C3. Abrasion Protection

C4. Cable Management

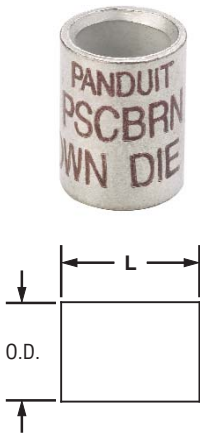

| Part Number | Figure Dimensions (In.) |      | Panduit Color Code | Panduit Die Index No.‡ | Wire Strip Length (In.) | Std. Pkg. Qty. |
|-------------|-------------------------|------|--------------------|------------------------|-------------------------|----------------|
|             | Barrel O.D.             | L    |                    |                        |                         |                |
| PSCRED-L    | 0.27                    | 0.50 | Red                | P21                    | 7/16                    | 50             |
| PSCBLU-L    | 0.31                    | 0.50 | Blue               | P24                    | 7/16                    | 50             |
| PSCGRY-L    | 0.38                    | 0.50 | Gray               | P29                    | 7/16                    | 50             |
| PSCBRN-L    | 0.47                    | 0.62 | Brown              | P33                    | 11/16                   | 50             |
| PSCGRN-L    | 0.52                    | 0.62 | Green              | P37                    | 11/16                   | 50             |
| PSCPNK-L    | 0.58                    | 0.62 | Pink               | P42                    | 11/16                   | 50             |
| PSCBLK-Q    | 0.64                    | 0.81 | Black              | P45                    | 7/8                     | 25             |
| PSCORG-Q    | 0.71                    | 0.81 | Orange             | P50                    | 7/8                     | 25             |
| PSCPUR-Q    | 0.77                    | 0.88 | Purple             | P54                    | 1                       | 25             |
| PSCYEL-Q    | 0.81                    | 1.05 | Yellow             | P62                    | 1 1/16                  | 25             |

‡See page D3.82 for tool and die information. For smaller wires sizes, see pages D1.65 – D1.69.

For heat shrink end caps and tubing see pages C3.35 – C3.42.

For thermal transfer labeling solutions see pages E1.1 – E2.22.

\*\*Consult cable manufacturer for voltage stress relief instructions with applications greater than 2000 V.

D1. Terminals

D2. Power Connectors

D3. Grounding Connectors

E1. Labeling Systems

E2. Labels

E3. Pre-Printed & Write-On Markers

E4. Permanent Identification

E5. Lockout/Tagout & Safety Solutions

F. Index



A. System Overview



## Flex Conductor, One-Hole, Standard Barrel with Window Lug

B1. Cable Ties

**For Use with Flexible, Extra-Flexible, and Code Stranded Copper Conductors**

### Type LCAX

- Can be used with code conductor and flex conductor class: G, H, I, K, M and Diesel Locomotive
- Generously beveled wire entry prevents bent back strands when inserting conductor into barrel
- Color-coded barrels marked with Panduit and specified competitor die index numbers for proper crimp die selection
- Inspection window to visually assure full conductor insertion
- Tin-plated to inhibit corrosion
- UL Listed and CSA Certified to 35 KV\*\* and temperature rated to 90°C when crimped with Panduit and specified competitor crimping tools and dies
- American Bureau of Shipping approved

B2. Cable Accessories

B3. Stainless Steel Ties

C1. Wiring Duct



C2. Surface Raceway

C3. Abrasion Protection

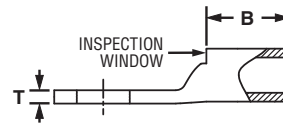
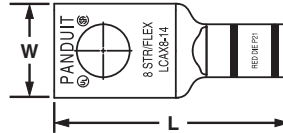

C4. Cable Management

| Part Number | Flex Conductor Size |                   | Code Conductor Size | Stud Hole Size (In.) | Figure Dimensions (In.) |       |      |      | Panduit Color Code | Panduit Die Index No.‡ | Burndy Die Index No.‡ | T&B Die Index No.‡ | Wire Strip Length (In.) | Std. Pkg. Qty. |
|-------------|---------------------|-------------------|---------------------|----------------------|-------------------------|-------|------|------|--------------------|------------------------|-----------------------|--------------------|-------------------------|----------------|
|             | Class G, H, I, K, M | Diesel Locomotive |                     |                      | W                       | B     | T    | L    |                    |                        |                       |                    |                         |                |
| LCAX8-10-L  | #8 AWG              | #8 AWG            | #8 AWG              | #10                  | 0.41                    | 0.42  | 0.08 | 1.11 | Red                | P21                    | 49                    | 21                 | 1/2                     | 50             |
| LCAX8-14-L  |                     |                   |                     | 1/4                  | 0.48                    | 0.42  | 0.07 | 1.20 | Red                | P21                    | 49                    | 21                 | 1/2                     | 50             |
| LCAX8-56-L  |                     |                   |                     | 5/16                 | 0.56                    | 0.42  | 0.05 | 1.32 | Red                | P21                    | 49                    | 21                 | 1/2                     | 50             |
| LCAX8-38-L  |                     |                   |                     | 3/8                  | 0.60                    | 0.42  | 0.05 | 1.42 | Red                | P21                    | 49                    | 21                 | 1/2                     | 50             |
| LCAX6-10-L  | #6 AWG              | #6 AWG            | #6 AWG              | #10                  | 0.45                    | 0.48  | 0.09 | 1.19 | Blue               | P24                    | 7                     | 24                 | 9/16                    | 50             |
| LCAX6-14-L  |                     |                   |                     | 1/4                  | 0.48                    | 0.48  | 0.08 | 1.28 | Blue               | P24                    | 7                     | 24                 | 9/16                    | 50             |
| LCAX6-56-L  |                     |                   |                     | 5/16                 | 0.56                    | 0.48  | 0.07 | 1.40 | Blue               | P24                    | 7                     | 24                 | 9/16                    | 50             |
| LCAX6-38-L  | 3/8                 | 0.62              | 0.48                | 0.06                 | 1.50                    | Blue  | P24  | 7    | 24                 | 9/16                   | 50                    |                    |                         |                |
| LCAX4-10-L  | #4 AWG              | #5, #4, #3 AWG    | #4 AWG              | #10                  | 0.55                    | 0.53  | 0.09 | 1.26 | Gray               | P29                    | 8                     | 29                 | 5/8                     | 50             |
| LCAX4-14-L  |                     |                   |                     | 1/4                  | 0.55                    | 0.53  | 0.09 | 1.35 | Gray               | P29                    | 8                     | 29                 | 5/8                     | 50             |
| LCAX4-56-L  |                     |                   |                     | 5/16                 | 0.55                    | 0.53  | 0.09 | 1.47 | Gray               | P29                    | 8                     | 29                 | 5/8                     | 50             |
| LCAX4-38-L  |                     |                   |                     | 3/8                  | 0.62                    | 0.53  | 0.07 | 1.57 | Gray               | P29                    | 8                     | 29                 | 5/8                     | 50             |
| LCAX2-10-E* | #2 AWG              | #2 AWG            | #2 AWG              | #10                  | 0.70                    | 0.59  | 0.11 | 1.40 | Brown              | P33                    | 10                    | 33                 | 11/16                   | 20             |
| LCAX2-14-E* |                     |                   |                     | 1/4                  | 0.70                    | 0.59  | 0.11 | 1.50 | Brown              | P33                    | 10                    | 33                 | 11/16                   | 20             |
| LCAX2-56-E* |                     |                   |                     | 5/16                 | 0.70                    | 0.59  | 0.11 | 1.63 | Brown              | P33                    | 10                    | 33                 | 11/16                   | 20             |
| LCAX2-38-E* |                     |                   |                     | 3/8                  | 0.70                    | 0.59  | 0.11 | 1.70 | Brown              | P33                    | 10                    | 33                 | 11/16                   | 20             |
| LCAX2-12-E* | 1/2                 | 0.75              | 0.59                | 0.09                 | 1.94                    | Brown | P33  | 10   | 33                 | 11/16                  | 20                    |                    |                         |                |
| LCAX1-10-X  | #1 AWG              | #1 AWG            | #1 AWG              | #10                  | 0.76                    | 0.66  | 0.12 | 1.50 | Green              | P37                    | 11                    | 37                 | 3/4                     | 10             |
| LCAX1-14-X  |                     |                   |                     | 1/4                  | 0.76                    | 0.66  | 0.12 | 1.67 | Green              | P37                    | 11                    | 37                 | 3/4                     | 10             |
| LCAX1-56-X  |                     |                   |                     | 5/16                 | 0.76                    | 0.66  | 0.12 | 1.72 | Green              | P37                    | 11                    | 37                 | 3/4                     | 10             |
| LCAX1-38-X  |                     |                   |                     | 3/8                  | 0.76                    | 0.66  | 0.12 | 1.80 | Green              | P37                    | 11                    | 37                 | 3/4                     | 10             |
| LCAX1-12-X  | 1/2                 | 0.80              | 0.66                | 0.12                 | 2.03                    | Green | P37  | 11   | 37                 | 3/4                    | 10                    |                    |                         |                |

‡See pages D3.70 – D3.73 for tool and die information.

\*Not UL Listed or CSA Certified with Class K flex conductor when crimped with Burndy tools.

\*\*Consult cable manufacturer for voltage stress relief instructions with applications greater than 2000 V.

E4. Permanent Identification

E5. Lockout/Tagout & Safety Solutions

F. Index





## Flex Conductor, One-Hole, Standard Barrel with Window Lug (continued)

| Part Number  | Flex Conductor Size |                   | Code Conductor Size | Stud Hole Size (In.) | Figure Dimensions (In.) |        |      |      | Panduit Color Code | Panduit Die Index No.‡ | Burndy Die Index No.‡ | T&B Die Index No.‡ | Wire Strip Length (In.) | Std. Pkg. Qty. |
|--------------|---------------------|-------------------|---------------------|----------------------|-------------------------|--------|------|------|--------------------|------------------------|-----------------------|--------------------|-------------------------|----------------|
|              | Class G, H, I, K, M | Diesel Locomotive |                     |                      | W                       | B      | T    | L    |                    |                        |                       |                    |                         |                |
| LCAX1/0-14-X | 1/0 AWG             | 1/0 AWG           | 1/0 AWG             | 1/4                  | 0.85                    | 0.72   | 0.13 | 1.82 | Pink               | P42                    | 12                    | 42                 | 3/4                     | 10             |
| LCAX1/0-56-X |                     |                   |                     | 5/16                 | 0.85                    | 0.72   | 0.13 | 1.82 | Pink               | P42                    | 12                    | 42                 | 3/4                     | 10             |
| LCAX1/0-38-X |                     |                   |                     | 3/8                  | 0.85                    | 0.72   | 0.13 | 1.89 | Pink               | P42                    | 12                    | 42                 | 3/4                     | 10             |
| LCAX1/0-12-X |                     |                   |                     | 1/2                  | 0.85                    | 0.72   | 0.13 | 2.14 | Pink               | P42                    | 12                    | 42                 | 3/4                     | 10             |
| LCAX1/0-58-X |                     |                   |                     | 5/8                  | 0.96                    | 0.72   | 0.11 | 2.38 | Pink               | P42                    | 12                    | 42                 | 3/4                     | 10             |
| LCAX2/0-10-X | 2/0 AWG             | 2/0 AWG           | 2/0 AWG             | #10                  | 0.96                    | 0.83   | 0.13 | 1.72 | Black              | P45                    | 13                    | 45                 | 7/8                     | 10             |
| LCAX2/0-14-X |                     |                   |                     | 1/4                  | 0.96                    | 0.83   | 0.13 | 1.97 | Black              | P45                    | 13                    | 45                 | 7/8                     | 10             |
| LCAX2/0-56-X |                     |                   |                     | 5/16                 | 0.96                    | 0.83   | 0.13 | 1.97 | Black              | P45                    | 13                    | 45                 | 7/8                     | 10             |
| LCAX2/0-38-X |                     |                   |                     | 3/8                  | 0.96                    | 0.83   | 0.13 | 2.03 | Black              | P45                    | 13                    | 45                 | 7/8                     | 10             |
| LCAX2/0-12-X |                     |                   |                     | 1/2                  | 0.96                    | 0.83   | 0.13 | 2.28 | Black              | P45                    | 13                    | 45                 | 7/8                     | 10             |
| LCAX2/0-58-X | 5/8                 | 0.96              | 0.83                | 0.13                 | 2.52                    | Black  | P45  | 13   | 45                 | 7/8                    | 10                    |                    |                         |                |
| LCAX3/0-10-X | 3/0 AWG             | 3/0 AWG           | 3/0 AWG             | #10                  | 1.06                    | 0.91   | 0.14 | 1.84 | Orange             | P50                    | 14                    | 50                 | 1                       | 10             |
| LCAX3/0-14-X |                     |                   |                     | 1/4                  | 1.06                    | 0.91   | 0.14 | 2.08 | Orange             | P50                    | 14                    | 50                 | 1                       | 10             |
| LCAX3/0-56-X |                     |                   |                     | 5/16                 | 1.06                    | 0.91   | 0.14 | 2.10 | Orange             | P50                    | 14                    | 50                 | 1                       | 10             |
| LCAX3/0-38-X |                     |                   |                     | 3/8                  | 1.06                    | 0.91   | 0.14 | 2.17 | Orange             | P50                    | 14                    | 50                 | 1                       | 10             |
| LCAX3/0-12-X |                     |                   |                     | 1/2                  | 1.06                    | 0.91   | 0.14 | 2.40 | Orange             | P50                    | 14                    | 50                 | 1                       | 10             |
| LCAX3/0-58-X | 5/8                 | 1.06              | 0.91                | 0.14                 | 2.64                    | Orange | P50  | 14   | 50                 | 1                      | 10                    |                    |                         |                |
| LCAX4/0-14-X | 4/0 AWG             | 4/0 AWG           | 4/0 AWG             | 1/4                  | 1.19                    | 1.03   | 0.16 | 2.30 | Purple             | P54                    | 15                    | 54                 | 1 1/16                  | 10             |
| LCAX4/0-56-X |                     |                   |                     | 5/16                 | 1.19                    | 1.03   | 0.16 | 2.53 | Purple             | P54                    | 15                    | 54                 | 1 1/16                  | 10             |
| LCAX4/0-38-X |                     |                   |                     | 3/8                  | 1.19                    | 1.03   | 0.16 | 2.53 | Purple             | P54                    | 15                    | 54                 | 1 1/16                  | 10             |
| LCAX4/0-12-X |                     |                   |                     | 1/2                  | 1.19                    | 1.03   | 0.16 | 2.64 | Purple             | P54                    | 15                    | 54                 | 1 1/16                  | 10             |
| LCAX4/0-58-X |                     |                   |                     | 5/8                  | 1.19                    | 1.03   | 0.16 | 2.85 | Purple             | P54                    | 15                    | 54                 | 1 1/16                  | 10             |
| LCAX4/0-34-X | 3/4                 | 1.19              | 1.03                | 0.16                 | 3.04                    | Purple | P54  | 15   | 54                 | 1 1/16                 | 10                    |                    |                         |                |
| LCAX250-14-X | 250 kcmil           | 262.6 kcmil       | —                   | 1/4                  | 1.28                    | 1.03   | 0.17 | 2.34 | Yellow             | P62                    | 16                    | 62                 | 1 1/16                  | 10             |
| LCAX250-56-X |                     |                   |                     | 5/16                 | 1.28                    | 1.03   | 0.17 | 2.57 | Yellow             | P62                    | 16                    | 62                 | 1 1/16                  | 10             |
| LCAX250-38-X |                     |                   |                     | 3/8                  | 1.28                    | 1.03   | 0.17 | 2.57 | Yellow             | P62                    | 16                    | 62                 | 1 1/16                  | 10             |
| LCAX250-12-X |                     |                   |                     | 1/2                  | 1.28                    | 1.03   | 0.17 | 2.68 | Yellow             | P62                    | 16                    | 62                 | 1 1/16                  | 10             |
| LCAX250-58-X |                     |                   |                     | 5/8                  | 1.28                    | 1.03   | 0.17 | 2.89 | Yellow             | P62                    | 16                    | 62                 | 1 1/16                  | 10             |
| LCAX250-34-X | 3/4                 | 1.28              | 1.03                | 0.17                 | 3.08                    | Yellow | P62  | 16   | 62                 | 1 1/16                 | 10                    |                    |                         |                |
| LCAX300-38-6 | 300 kcmil           | 313.1 kcmil       | —                   | 3/8                  | 1.39                    | 1.19   | 0.18 | 2.91 | Red                | P71                    | 18                    | 71H                | 1 1/4                   | 6              |
| LCAX300-12-6 |                     |                   |                     | 1/2                  | 1.39                    | 1.19   | 0.18 | 2.91 | Red                | P71                    | 18                    | 71H                | 1 1/4                   | 6              |
| LCAX300-58-6 |                     |                   |                     | 5/8                  | 1.39                    | 1.19   | 0.18 | 3.12 | Red                | P71                    | 18                    | 71H                | 1 1/4                   | 6              |
| LCAX350-56-6 | 350 kcmil           | 373.7 kcmil       | —                   | 5/16                 | 1.54                    | 1.29   | 0.22 | 2.93 | Blue               | P76                    | 19                    | 76H                | 1 3/8                   | 6              |
| LCAX350-38-6 |                     |                   |                     | 3/8                  | 1.54                    | 1.29   | 0.22 | 2.93 | Blue               | P76                    | 19                    | 76H                | 1 3/8                   | 6              |
| LCAX350-12-6 |                     |                   |                     | 1/2                  | 1.54                    | 1.29   | 0.22 | 3.09 | Blue               | P76                    | 19                    | 76H                | 1 3/8                   | 6              |
| LCAX350-58-6 | 5/8                 | 1.54              | 1.29                | 0.22                 | 3.30                    | Blue   | P76  | 19   | 76H                | 1 3/8                  | 6                     |                    |                         |                |
| LCAX450-12-6 | 450 kcmil           | 444.4 kcmil       | —                   | 1/2                  | 1.70                    | 1.40   | 0.26 | 3.60 | Brown              | P87                    | 20                    | 87H                | 1 7/16                  | 6              |
| LCAX450-58-6 |                     |                   |                     | 5/8                  | 1.70                    | 1.40   | 0.26 | 3.73 | Brown              | P87                    | 20                    | 87H                | 1 7/16                  | 6              |
| LCAX500-56-6 | 500 kcmil           | 535.3 kcmil       | —                   | 5/16                 | 1.89                    | 1.48   | 0.26 | 3.27 | Pink               | P99                    | L99                   | 99H                | 1 9/16                  | 6              |
| LCAX500-38-6 |                     |                   |                     | 3/8                  | 1.89                    | 1.48   | 0.26 | 3.27 | Pink               | P99                    | L99                   | 99H                | 1 9/16                  | 6              |
| LCAX500-12-6 |                     |                   |                     | 1/2                  | 1.89                    | 1.48   | 0.26 | 3.64 | Pink               | P99                    | L99                   | 99H                | 1 9/16                  | 6              |
| LCAX500-58-6 |                     |                   |                     | 5/8                  | 1.89                    | 1.48   | 0.26 | 4.20 | Pink               | P99                    | L99                   | 99H                | 1 9/16                  | 6              |
| LCAX650-56-6 | —                   | 646.4 kcmil       | —                   | 5/16                 | 1.95                    | 1.45   | 0.30 | 3.27 | Black              | P106                   | 24                    | 106H               | 1 1/2                   | 6              |
| LCAX650-38-6 |                     |                   |                     | 3/8                  | 1.95                    | 1.45   | 0.30 | 3.27 | Black              | P106                   | 24                    | 106H               | 1 1/2                   | 6              |
| LCAX650-12-6 |                     |                   |                     | 1/2                  | 1.95                    | 1.45   | 0.30 | 3.64 | Black              | P106                   | 24                    | 106H               | 1 1/2                   | 6              |
| LCAX650-58-6 |                     |                   |                     | 5/8                  | 1.95                    | 1.45   | 0.30 | 4.20 | Black              | P106                   | 24                    | 106H               | 1 1/2                   | 6              |
| LCAX750-12-3 | —                   | 777.7 kcmil       | —                   | 1/2                  | 2.17                    | 1.66   | 0.32 | 3.94 | Yellow             | P115                   | L115                  | 115H               | 1 3/4                   | 3              |
| LCAX750-58-3 |                     |                   |                     | 5/8                  | 2.17                    | 1.66   | 0.32 | 4.59 | Yellow             | P115                   | L115                  | 115H               | 1 3/4                   | 3              |

‡See pages D3.70 – D3.73 for tool and die information.

\*Not UL Listed or CSA Certified with Class K flex conductor when crimped with Burndy tools.

\*\*Consult cable manufacturer for voltage stress relief instructions with applications greater than 2000 V.

A.  
System  
Overview

B1.  
Cable Ties

B2.  
Cable  
Accessories

B3.  
Stainless  
Steel Ties

C1.  
Wiring  
Duct

C2.  
Surface  
Raceway

C3.  
Abrasion  
Protection

C4.  
Cable  
Management

D1.  
Terminals

D2.  
Power  
Connectors

D3.  
Grounding  
Connectors

E1.  
Labeling  
Systems

E2.  
Labels

E3.  
Pre-Printed  
& Write-On  
Markers

E4.  
Permanent  
Identification

E5.  
Lockout/  
Tagout  
& Safety  
Solutions

F.  
Index

A. System Overview



## Flex Conductor, One-Hole, Standard Barrel with Window Lug, 45° Angle

B1. Cable Ties

**For Use with Flexible, Extra-Flexible, and Code Stranded Copper Conductors**

### Type LCAX-H

- Can be used with code conductor and flex conductor class: G, H, I, K, M and Diesel Locomotive
- Generously beveled wire entry prevents bent back strands when inserting conductor into barrel
- Color-coded barrels marked with Panduit and specified competitor die index numbers for proper crimp die selection
- Inspection window to visually assure full conductor insertion
- Tin-plated to inhibit corrosion
- UL Listed and CSA Certified to 35 KV\*\* and temperature rated to 90°C when crimped with Panduit and specified competitor crimping tools and dies
- American Bureau of Shipping Approved

B2. Cable Accessories

B3. Stainless Steel Ties

C1. Wiring Duct

C2. Surface Raceway

C3. Abrasion Protection



C4. Cable Management

D1. Terminals

D2. Power Connectors

D3. Grounding Connectors

E1. Labeling Systems

E2. Labels

E3. Pre-Printed & Write-On Markers

E4. Permanent Identification

E5. Lockout/Tagout & Safety Solutions

F. Index

| Part Number   | Flex Conductor Size |                   | Code Conductor Size | Stud Hole Size (In.) | Figure Dimensions (In.) |      |      |      | Panduit Color Code | Panduit Die Index No.‡ | Burndy Die Index No.‡ | T&B Die Index No.‡ | Wire Strip Length (In.) | Std. Pkg. Qty. |
|---------------|---------------------|-------------------|---------------------|----------------------|-------------------------|------|------|------|--------------------|------------------------|-----------------------|--------------------|-------------------------|----------------|
|               | Class G, H, I, K, M | Diesel Locomotive |                     |                      | W                       | B    | T    | L    |                    |                        |                       |                    |                         |                |
| LCAX8-10H-L   | #8 AWG              | #8 AWG            | #8 AWG              | #10                  | 0.41                    | 0.42 | 0.08 | 1.00 | Red                | P21                    | 49                    | 21                 | 1/2                     | 50             |
| LCAX8-14H-L   |                     |                   |                     | 1/4                  | 0.48                    | 0.42 | 0.07 | 1.09 | Red                | P21                    | 49                    | 21                 | 1/2                     | 50             |
| LCAX8-56H-L   |                     |                   |                     | 5/16                 | 0.56                    | 0.42 | 0.05 | 1.20 | Red                | P21                    | 49                    | 21                 | 1/2                     | 50             |
| LCAX8-38H-L   |                     |                   |                     | 3/8                  | 0.60                    | 0.42 | 0.05 | 1.30 | Red                | P21                    | 49                    | 21                 | 1/2                     | 50             |
| LCAX6-10H-L   | #6 AWG              | #6 AWG            | #6 AWG              | #10                  | 0.45                    | 0.48 | 0.09 | 1.06 | Blue               | P24                    | 7                     | 24                 | 9/16                    | 50             |
| LCAX6-14H-L   |                     |                   |                     | 1/4                  | 0.48                    | 0.48 | 0.08 | 1.14 | Blue               | P24                    | 7                     | 24                 | 9/16                    | 50             |
| LCAX6-56H-L   |                     |                   |                     | 5/16                 | 0.56                    | 0.48 | 0.07 | 1.26 | Blue               | P24                    | 7                     | 24                 | 9/16                    | 50             |
| LCAX6-38H-L   |                     |                   |                     | 3/8                  | 0.62                    | 0.48 | 0.06 | 1.35 | Blue               | P24                    | 7                     | 24                 | 9/16                    | 50             |
| LCAX4-10H-L   | #4 AWG              | #5, #4, #3 AWG    | #4 AWG              | #10                  | 0.55                    | 0.53 | 0.09 | 1.12 | Gray               | P29                    | 8                     | 29                 | 5/8                     | 50             |
| LCAX4-14H-L   |                     |                   |                     | 1/4                  | 0.55                    | 0.53 | 0.09 | 1.21 | Gray               | P29                    | 8                     | 29                 | 5/8                     | 50             |
| LCAX4-56H-L   |                     |                   |                     | 5/16                 | 0.55                    | 0.53 | 0.09 | 1.33 | Gray               | P29                    | 8                     | 29                 | 5/8                     | 50             |
| LCAX4-38H-L   |                     |                   |                     | 3/8                  | 0.62                    | 0.53 | 0.07 | 1.42 | Gray               | P29                    | 8                     | 29                 | 5/8                     | 50             |
| LCAX2-10H-E   | #2 AWG              | #2 AWG            | #2 AWG              | #10                  | 0.70                    | 0.59 | 0.11 | 1.22 | Brown              | P33                    | 10                    | 33                 | 11/16                   | 20             |
| LCAX2-14H-E   |                     |                   |                     | 1/4                  | 0.70                    | 0.59 | 0.11 | 1.29 | Brown              | P33                    | 10                    | 33                 | 11/16                   | 20             |
| LCAX2-56H-E   |                     |                   |                     | 5/16                 | 0.70                    | 0.59 | 0.11 | 1.42 | Brown              | P33                    | 10                    | 33                 | 11/16                   | 20             |
| LCAX2-38H-E   |                     |                   |                     | 3/8                  | 0.70                    | 0.59 | 0.11 | 1.49 | Brown              | P33                    | 10                    | 33                 | 11/16                   | 20             |
| LCAX2-12H-E   |                     |                   |                     | 1/2                  | 0.75                    | 0.59 | 0.09 | 1.73 | Brown              | P33                    | 10                    | 33                 | 11/16                   | 20             |
| LCAX1-10H-X   | #1 AWG              | #1 AWG            | #1 AWG              | #10                  | 0.76                    | 0.66 | 0.12 | 1.43 | Green              | P37                    | 11                    | 37                 | 3/4                     | 10             |
| LCAX1-14H-X   |                     |                   |                     | 1/4                  | 0.76                    | 0.66 | 0.12 | 1.43 | Green              | P37                    | 11                    | 37                 | 3/4                     | 10             |
| LCAX1-56H-X   |                     |                   |                     | 5/16                 | 0.76                    | 0.66 | 0.12 | 1.49 | Green              | P37                    | 11                    | 37                 | 3/4                     | 10             |
| LCAX1-38H-X   |                     |                   |                     | 3/8                  | 0.76                    | 0.66 | 0.12 | 1.56 | Green              | P37                    | 11                    | 37                 | 3/4                     | 10             |
| LCAX1-12H-X   |                     |                   |                     | 1/2                  | 0.80                    | 0.66 | 0.12 | 1.80 | Green              | P37                    | 11                    | 37                 | 3/4                     | 10             |
| LCAX1/0-14H-X | 1/0 AWG             | 1/0 AWG           | 1/0 AWG             | 1/4                  | 0.85                    | 0.72 | 0.13 | 1.58 | Pink               | P42                    | 12                    | 42                 | 3/4                     | 10             |
| LCAX1/0-56H-X |                     |                   |                     | 5/16                 | 0.85                    | 0.72 | 0.13 | 1.58 | Pink               | P42                    | 12                    | 42                 | 3/4                     | 10             |
| LCAX1/0-38H-X |                     |                   |                     | 3/8                  | 0.85                    | 0.72 | 0.13 | 1.64 | Pink               | P42                    | 12                    | 42                 | 3/4                     | 10             |
| LCAX1/0-12H-X |                     |                   |                     | 1/2                  | 0.85                    | 0.72 | 0.13 | 1.89 | Pink               | P42                    | 12                    | 42                 | 3/4                     | 10             |

‡See pages D3.70 – D3.73 for tool and die information.

\*Not UL Listed or CSA Certified with Class K flex conductor when crimped with Burndy tools.

\*\*Consult cable manufacturer for voltage stress relief instructions with applications greater than 2000 V.



## Flex Conductor, One-Hole, Standard Barrel with Window Lug, 45° Angle (continued)

| Part Number   | Flex Conductor Size |                   | Code Conductor Size | Stud Hole Size (In.) | Figure Dimensions (In.) |         |      |      | Panduit Color Code | Panduit Die Index No.‡ | Burndy Die Index No.‡ | T&B Die Index No.‡ | Wire Strip Length (In.) | Std. Pkg. Qty. |     |        |    |
|---------------|---------------------|-------------------|---------------------|----------------------|-------------------------|---------|------|------|--------------------|------------------------|-----------------------|--------------------|-------------------------|----------------|-----|--------|----|
|               | Class G, H, I, K, M | Diesel Locomotive |                     |                      | W                       | B       | T    | L    |                    |                        |                       |                    |                         |                |     |        |    |
| LCAX2/0-10H-X | 2/0 AWG             | 2/0 AWG           | 2/0 AWG             | #10                  | 0.96                    | 0.83    | 0.13 | 1.56 | Black              | P45                    | 13                    | 45                 | 7/8                     | 10             |     |        |    |
| LCAX2/0-14H-X |                     |                   |                     | 1/4                  | 0.96                    | 0.83    | 0.13 | 1.68 | Black              | P45                    | 13                    | 45                 | 7/8                     | 10             |     |        |    |
| LCAX2/0-56H-X |                     |                   |                     | 5/16                 | 0.96                    | 0.83    | 0.13 | 1.68 | Black              | P45                    | 13                    | 45                 | 7/8                     | 10             |     |        |    |
| LCAX2/0-38H-X |                     |                   |                     | 3/8                  | 0.96                    | 0.83    | 0.13 | 1.74 | Black              | P45                    | 13                    | 45                 | 7/8                     | 10             |     |        |    |
| LCAX2/0-12H-X |                     |                   |                     | 1/2                  | 0.96                    | 0.83    | 0.13 | 1.99 | Black              | P45                    | 13                    | 45                 | 7/8                     | 10             |     |        |    |
| LCAX2/0-58H-X |                     |                   |                     | 5/8                  | 0.96                    | 0.83    | 0.13 | 2.28 | Black              | P45                    | 13                    | 45                 | 7/8                     | 10             |     |        |    |
| LCAX3/0-10H-X |                     |                   |                     | 3/0 AWG              | 3/0 AWG                 | 3/0 AWG | #10  | 1.06 | 0.91               | 0.14                   | 1.77                  | Orange             | P50                     | 14             | 50  | 1      | 10 |
| LCAX3/0-14H-X | 1/4                 | 1.06              | 0.91                |                      |                         |         | 0.14 | 1.77 | Orange             | P50                    | 14                    | 50                 | 1                       | 10             |     |        |    |
| LCAX3/0-56H-X | 5/16                | 1.06              | 0.91                |                      |                         |         | 0.14 | 1.78 | Orange             | P50                    | 14                    | 50                 | 1                       | 10             |     |        |    |
| LCAX3/0-38H-X | 3/8                 | 1.06              | 0.91                |                      |                         |         | 0.14 | 1.85 | Orange             | P50                    | 14                    | 50                 | 1                       | 10             |     |        |    |
| LCAX3/0-12H-X | 1/2                 | 1.06              | 0.91                |                      |                         |         | 0.14 | 2.08 | Orange             | P50                    | 14                    | 50                 | 1                       | 10             |     |        |    |
| LCAX4/0-14H-X | 4/0 AWG             | 4/0 AWG           | 4/0 AWG             |                      |                         |         | 1/4  | 1.19 | 1.03               | 0.16                   | 2.03                  | Purple             | P54                     | 15             | 54  | 1 1/16 | 10 |
| LCAX4/0-56H-X |                     |                   |                     |                      |                         |         | 5/16 | 1.19 | 1.03               | 0.16                   | 2.26                  | Purple             | P54                     | 15             | 54  | 1 1/16 | 10 |
| LCAX4/0-38H-X |                     |                   |                     | 3/8                  | 1.19                    | 1.03    | 0.16 | 2.26 | Purple             | P54                    | 15                    | 54                 | 1 1/16                  | 10             |     |        |    |
| LCAX4/0-12H-X |                     |                   |                     | 1/2                  | 1.19                    | 1.03    | 0.16 | 2.37 | Purple             | P54                    | 15                    | 54                 | 1 1/16                  | 10             |     |        |    |
| LCAX4/0-58H-X |                     |                   |                     | 5/8                  | 1.19                    | 1.03    | 0.16 | 2.58 | Purple             | P54                    | 15                    | 54                 | 1 1/16                  | 10             |     |        |    |
| LCAX4/0-34H-X |                     |                   |                     | 3/4                  | 1.19                    | 1.03    | 0.16 | 2.58 | Purple             | P54                    | 15                    | 54                 | 1 1/16                  | 10             |     |        |    |
| LCAX250-14H-X |                     |                   |                     | 250 kcmil            | 262.6 kcmil             | —       | 1/4  | 1.28 | 1.03               | 0.17                   | 2.30                  | Yellow             | P62                     | 16             | 62  | 1 1/16 | 10 |
| LCAX250-56H-X | 5/16                | 1.28              | 1.03                |                      |                         |         | 0.17 | 2.30 | Yellow             | P62                    | 16                    | 62                 | 1 1/16                  | 10             |     |        |    |
| LCAX250-38H-X | 3/8                 | 1.28              | 1.03                |                      |                         |         | 0.17 | 2.30 | Yellow             | P62                    | 16                    | 62                 | 1 1/16                  | 10             |     |        |    |
| LCAX250-12H-X | 1/2                 | 1.28              | 1.03                |                      |                         |         | 0.17 | 2.41 | Yellow             | P62                    | 16                    | 62                 | 1 1/16                  | 10             |     |        |    |
| LCAX250-58H-X | 5/8                 | 1.28              | 1.03                |                      |                         |         | 0.17 | 2.62 | Yellow             | P62                    | 16                    | 62                 | 1 1/16                  | 10             |     |        |    |
| LCAX250-34H-X | 3/4                 | 1.28              | 1.03                |                      |                         |         | 0.17 | 2.62 | Yellow             | P62                    | 16                    | 62                 | 1 1/16                  | 10             |     |        |    |
| LCAX300-38H-6 | 300 kcmil           | 313.1 kcmil       | —                   |                      |                         |         | 3/8  | 1.39 | 1.19               | 0.18                   | 2.64                  | Red                | P71                     | 18             | 71H | 1 1/4  | 6  |
| LCAX300-12H-6 |                     |                   |                     | 1/2                  | 1.39                    | 1.19    | 0.18 | 2.64 | Red                | P71                    | 18                    | 71H                | 1 1/4                   | 6              |     |        |    |
| LCAX300-58H-6 |                     |                   |                     | 5/8                  | 1.39                    | 1.19    | 0.18 | 2.85 | Red                | P71                    | 18                    | 71H                | 1 1/4                   | 6              |     |        |    |
| LCAX350-56H-6 | 350 kcmil           | 373.7 kcmil       | —                   | 5/16                 | 1.54                    | 1.29    | 0.22 | 2.62 | Blue               | P76                    | 19                    | 76H                | 1 3/8                   | 6              |     |        |    |
| LCAX350-38H-6 |                     |                   |                     | 3/8                  | 1.54                    | 1.29    | 0.22 | 2.62 | Blue               | P76                    | 19                    | 76H                | 1 3/8                   | 6              |     |        |    |
| LCAX350-12H-6 |                     |                   |                     | 1/2                  | 1.54                    | 1.29    | 0.22 | 2.78 | Blue               | P76                    | 19                    | 76H                | 1 3/8                   | 6              |     |        |    |
| LCAX350-58H-6 |                     |                   |                     | 5/8                  | 1.54                    | 1.29    | 0.22 | 2.99 | Blue               | P76                    | 19                    | 76H                | 1 3/8                   | 6              |     |        |    |
| LCAX450-12H-6 | 450 kcmil           | 444.4 kcmil       | —                   | 1/2                  | 1.70                    | 1.40    | 0.26 | 3.26 | Brown              | P87                    | 20                    | 87H                | 1 7/16                  | 6              |     |        |    |
| LCAX450-58H-6 |                     |                   |                     | 5/8                  | 1.70                    | 1.40    | 0.26 | 3.39 | Brown              | P87                    | 20                    | 87H                | 1 7/16                  | 6              |     |        |    |
| LCAX500-56H-6 | 500 kcmil           | 535.3 kcmil       | —                   | 5/16                 | 1.89                    | 1.48    | 0.26 | 2.87 | Pink               | P99                    | L99                   | 99H                | 1 9/16                  | 6              |     |        |    |
| LCAX500-38H-6 |                     |                   |                     | 3/8                  | 1.89                    | 1.48    | 0.26 | 2.87 | Pink               | P99                    | L99                   | 99H                | 1 9/16                  | 6              |     |        |    |
| LCAX500-12H-6 |                     |                   |                     | 1/2                  | 1.89                    | 1.48    | 0.26 | 3.24 | Pink               | P99                    | L99                   | 99H                | 1 9/16                  | 6              |     |        |    |
| LCAX500-58H-6 |                     |                   |                     | 5/8                  | 1.89                    | 1.48    | 0.26 | 3.80 | Pink               | P99                    | L99                   | 99H                | 1 9/16                  | 6              |     |        |    |
| LCAX650-56H-6 | —                   | 646.4 kcmil       | —                   | 5/16                 | 1.95                    | 1.45    | 0.30 | 2.89 | Black              | P106                   | 24                    | 106H               | 1 1/2                   | 6              |     |        |    |
| LCAX650-38H-6 |                     |                   |                     | 3/8                  | 1.95                    | 1.45    | 0.30 | 2.89 | Black              | P106                   | 24                    | 106H               | 1 1/2                   | 6              |     |        |    |
| LCAX650-12H-6 |                     |                   |                     | 1/2                  | 1.95                    | 1.45    | 0.30 | 3.26 | Black              | P106                   | 24                    | 106H               | 1 1/2                   | 6              |     |        |    |
| LCAX650-58H-6 |                     |                   |                     | 5/8                  | 1.95                    | 1.45    | 0.30 | 3.82 | Black              | P106                   | 24                    | 106H               | 1 1/2                   | 6              |     |        |    |
| LCAX750-12H-3 | —                   | 777.7 kcmil       | —                   | 1/2                  | 2.17                    | 1.66    | 0.32 | 3.52 | Yellow             | P115                   | L115                  | 115H               | 1 3/4                   | 3              |     |        |    |
| LCAX750-58H-3 |                     |                   |                     | 5/8                  | 2.17                    | 1.66    | 0.32 | 4.18 | Yellow             | P115                   | L115                  | 115H               | 1 3/4                   | 3              |     |        |    |

‡See pages D3.70 – D3.73 for tool and die information.

\*Not UL Listed or CSA Certified with Class K flex conductor when crimped with Burndy tools.

\*\*Consult cable manufacturer for voltage stress relief instructions with applications greater than 2000 V.

A. System Overview

B1. Cable Ties

B2. Cable Accessories

B3. Stainless Steel Ties

C1. Wiring Duct

C2. Surface Raceway

C3. Abrasion Protection

C4. Cable Management

D1. Terminals

D2. Power Connectors

D3. Grounding Connectors

E1. Labeling Systems

E2. Labels

E3. Pre-Printed & Write-On Markers

E4. Permanent Identification

E5. Lockout/Tagout & Safety Solutions

F. Index

A. System Overview



## Flex Conductor, One-Hole, Standard Barrel with Window Lug, 90° Angle

B1. Cable Ties

**For Use with Flexible, Extra-Flexible, and Code Stranded Copper Conductors**

### Type LCAX-F

- Can be used with code conductor and flex conductor class: G, H, I, K, M and Diesel Locomotive
- Generously beveled wire entry prevents bent back strands when inserting conductor into barrel
- Color-coded barrels marked with Panduit and specified competitor die index numbers for proper crimp die selection
- Inspection window to visually assure full conductor insertion
- Tin-plated to inhibit corrosion
- UL Listed and CSA Certified to 35 KV\*\* and temperature rated to 90°C when crimped with Panduit and specified competitor crimping tools and dies
- American Bureau of Shipping approved

B2. Cable Accessories

B3. Stainless Steel Ties

C1. Wiring Duct

C2. Surface Raceway

C3. Abrasion Protection

C4. Cable Management

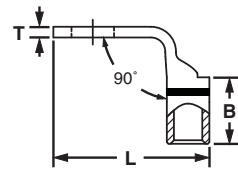

| Part Number   | Flex Conductor Size |                   | Code Conductor Size | Stud Hole Size (In.) | Figure Dimensions (In.) |      |      |      | Panduit Color Code | Panduit Die Index No.‡ | Burndy Die Index No.‡ | T&B Die Index No.‡ | Wire Strip Length (In.) | Std. Pkg. Qty. |
|---------------|---------------------|-------------------|---------------------|----------------------|-------------------------|------|------|------|--------------------|------------------------|-----------------------|--------------------|-------------------------|----------------|
|               | Class G, H, I, K, M | Diesel Locomotive |                     |                      | W                       | B    | T    | L    |                    |                        |                       |                    |                         |                |
| LCAX8-10F-L   | #8 AWG              | #8 AWG            | #8 AWG              | #10                  | 0.41                    | 0.42 | 0.08 | 0.90 | Red                | P21                    | 49                    | 21                 | 1/2                     | 50             |
| LCAX8-14F-L   |                     |                   |                     | 1/4                  | 0.48                    | 0.42 | 0.07 | 0.99 | Red                | P21                    | 49                    | 21                 | 1/2                     | 50             |
| LCAX8-56F-L   |                     |                   |                     | 5/16                 | 0.56                    | 0.42 | 0.05 | 1.11 | Red                | P21                    | 49                    | 21                 | 1/2                     | 50             |
| LCAX8-38F-L   |                     |                   |                     | 3/8                  | 0.60                    | 0.42 | 0.05 | 1.21 | Red                | P21                    | 49                    | 21                 | 1/2                     | 50             |
| LCAX6-10F-L   | #6 AWG              | #6 AWG            | #6 AWG              | #10                  | 0.45                    | 0.48 | 0.09 | 0.99 | Blue               | P24                    | 7                     | 24                 | 9/16                    | 50             |
| LCAX6-14F-L   |                     |                   |                     | 1/4                  | 0.48                    | 0.48 | 0.08 | 1.03 | Blue               | P24                    | 7                     | 24                 | 9/16                    | 50             |
| LCAX6-56F-L   |                     |                   |                     | 5/16                 | 0.56                    | 0.48 | 0.07 | 1.15 | Blue               | P24                    | 7                     | 24                 | 9/16                    | 50             |
| LCAX6-38F-L   |                     |                   |                     | 3/8                  | 0.62                    | 0.48 | 0.06 | 1.25 | Blue               | P24                    | 7                     | 24                 | 9/16                    | 50             |
| LCAX4-10F-L   | #4 AWG              | #5, #4, #3 AWG    | #4 AWG              | #10                  | 0.55                    | 0.53 | 0.09 | 1.03 | Gray               | P29                    | 8                     | 29                 | 5/8                     | 50             |
| LCAX4-14F-L   |                     |                   |                     | 1/4                  | 0.55                    | 0.53 | 0.09 | 1.12 | Gray               | P29                    | 8                     | 29                 | 5/8                     | 50             |
| LCAX4-56F-L   |                     |                   |                     | 5/16                 | 0.55                    | 0.53 | 0.09 | 1.24 | Gray               | P29                    | 8                     | 29                 | 5/8                     | 50             |
| LCAX4-38F-L   |                     |                   |                     | 3/8                  | 0.62                    | 0.53 | 0.07 | 1.34 | Gray               | P29                    | 8                     | 29                 | 5/8                     | 50             |
| LCAX2-10F-E*  | #2 AWG              | #2 AWG            | #2 AWG              | #10                  | 0.70                    | 0.59 | 0.11 | 1.21 | Brown              | P33                    | 10                    | 33                 | 11/16                   | 20             |
| LCAX2-14F-E*  |                     |                   |                     | 1/4                  | 0.70                    | 0.59 | 0.11 | 1.31 | Brown              | P33                    | 10                    | 33                 | 11/16                   | 20             |
| LCAX2-56F-E*  |                     |                   |                     | 5/16                 | 0.70                    | 0.59 | 0.11 | 1.44 | Brown              | P33                    | 10                    | 33                 | 11/16                   | 20             |
| LCAX2-38F-E*  |                     |                   |                     | 3/8                  | 0.70                    | 0.59 | 0.11 | 1.51 | Brown              | P33                    | 10                    | 33                 | 11/16                   | 20             |
| LCAX2-12F-E*  | #1 AWG              | #1 AWG            | #1 AWG              | 1/2                  | 0.75                    | 0.59 | 0.09 | 1.75 | Brown              | P33                    | 10                    | 33                 | 11/16                   | 20             |
| LCAX1-10F-X   |                     |                   |                     | #10                  | 0.76                    | 0.66 | 0.12 | 1.28 | Green              | P37                    | 11                    | 37                 | 3/4                     | 10             |
| LCAX1-14F-X   |                     |                   |                     | 1/4                  | 0.76                    | 0.66 | 0.12 | 1.45 | Green              | P37                    | 11                    | 37                 | 3/4                     | 10             |
| LCAX1-56F-X   |                     |                   |                     | 5/16                 | 0.76                    | 0.66 | 0.12 | 1.51 | Green              | P37                    | 11                    | 37                 | 3/4                     | 10             |
| LCAX1-38F-X   | 1/0 AWG             | 1/0 AWG           | 1/0 AWG             | 3/8                  | 0.76                    | 0.66 | 0.12 | 1.58 | Green              | P37                    | 11                    | 37                 | 3/4                     | 10             |
| LCAX1-12F-X   |                     |                   |                     | 1/2                  | 0.80                    | 0.66 | 0.12 | 1.82 | Green              | P37                    | 11                    | 37                 | 3/4                     | 10             |
| LCAX1/0-14F-X |                     |                   |                     | 1/4                  | 0.85                    | 0.72 | 0.13 | 1.59 | Pink               | P42                    | 12                    | 42                 | 3/4                     | 10             |
| LCAX1/0-56F-X |                     |                   |                     | 5/16                 | 0.85                    | 0.72 | 0.13 | 1.59 | Pink               | P42                    | 12                    | 42                 | 3/4                     | 10             |
| LCAX1/0-38F-X | 1/2                 | 1/2               | 1/2                 | 3/8                  | 0.85                    | 0.72 | 0.13 | 1.66 | Pink               | P42                    | 12                    | 42                 | 3/4                     | 10             |
| LCAX1/0-12F-X |                     |                   |                     | 1/2                  | 0.85                    | 0.72 | 0.13 | 1.91 | Pink               | P42                    | 12                    | 42                 | 3/4                     | 10             |

‡See pages D3.70 – D3.73 for tool and die information.

\*Not UL Listed or CSA Certified with Class K flex conductor when crimped with Burndy tools.

\*\*Consult cable manufacturer for voltage stress relief instructions with applications greater than 2000 V.

E4. Permanent Identification

E5. Lockout/Tagout & Safety Solutions

F. Index



## Flex Conductor, One-Hole, Standard Barrel with Window Lug, 90° Angle (continued)

| Part Number   | Flex Conductor Size |                   | Code Conductor Size | Stud Hole Size (In.) | Figure Dimensions (In.) |        |      |      | Panduit Color Code | Panduit Die Index No.‡ | Burndy Die Index No.‡ | T&B Die Index No.‡ | Wire Strip Length (In.) | Std. Pkg. Qty. |
|---------------|---------------------|-------------------|---------------------|----------------------|-------------------------|--------|------|------|--------------------|------------------------|-----------------------|--------------------|-------------------------|----------------|
|               | Class G, H, I, K, M | Diesel Locomotive |                     |                      | W                       | B      | T    | L    |                    |                        |                       |                    |                         |                |
| LCAX2/0-10F-X | 2/0 AWG             | 2/0 AWG           | 2/0 AWG             | #10                  | 0.96                    | 0.83   | 0.13 | 1.42 | Black              | P45                    | 13                    | 45                 | 7/8                     | 10             |
| LCAX2/0-14F-X |                     |                   |                     | 1/4                  | 0.96                    | 0.83   | 0.13 | 1.67 | Black              | P45                    | 13                    | 45                 | 7/8                     | 10             |
| LCAX2/0-56F-X |                     |                   |                     | 5/16                 | 0.96                    | 0.83   | 0.13 | 1.67 | Black              | P45                    | 13                    | 45                 | 7/8                     | 10             |
| LCAX2/0-38F-X |                     |                   |                     | 3/8                  | 0.96                    | 0.83   | 0.13 | 1.73 | Black              | P45                    | 13                    | 45                 | 7/8                     | 10             |
| LCAX2/0-12F-X |                     |                   |                     | 1/2                  | 0.96                    | 0.83   | 0.13 | 1.98 | Black              | P45                    | 13                    | 45                 | 7/8                     | 10             |
| LCAX2/0-58F-X |                     |                   |                     | 5/8                  | 0.96                    | 0.83   | 0.13 | 2.27 | Black              | P45                    | 13                    | 45                 | 7/8                     | 10             |
| LCAX3/0-10F-X | 3/0 AWG             | 3/0 AWG           | 3/0 AWG             | #10                  | 1.06                    | 0.91   | 0.14 | 1.51 | Orange             | P50                    | 14                    | 50                 | 1                       | 10             |
| LCAX3/0-14F-X |                     |                   |                     | 1/4                  | 1.06                    | 0.91   | 0.14 | 1.75 | Orange             | P50                    | 14                    | 50                 | 1                       | 10             |
| LCAX3/0-56F-X |                     |                   |                     | 5/16                 | 1.06                    | 0.91   | 0.14 | 1.77 | Orange             | P50                    | 14                    | 50                 | 1                       | 10             |
| LCAX3/0-38F-X |                     |                   |                     | 3/8                  | 1.06                    | 0.91   | 0.14 | 1.84 | Orange             | P50                    | 14                    | 50                 | 1                       | 10             |
| LCAX3/0-12F-X | 1/2                 | 1.06              | 0.91                | 0.14                 | 2.07                    | Orange | P50  | 14   | 50                 | 1                      | 10                    |                    |                         |                |
| LCAX4/0-14F-X | 4/0 AWG             | 4/0 AWG           | 4/0 AWG             | 1/4                  | 1.19                    | 1.03   | 0.16 | 1.84 | Purple             | P54                    | 15                    | 54                 | 1 1/16                  | 10             |
| LCAX4/0-56F-X |                     |                   |                     | 5/16                 | 1.19                    | 1.03   | 0.16 | 2.07 | Purple             | P54                    | 15                    | 54                 | 1 1/16                  | 10             |
| LCAX4/0-38F-X |                     |                   |                     | 3/8                  | 1.19                    | 1.03   | 0.16 | 2.07 | Purple             | P54                    | 15                    | 54                 | 1 1/16                  | 10             |
| LCAX4/0-12F-X |                     |                   |                     | 1/2                  | 1.19                    | 1.03   | 0.16 | 2.18 | Purple             | P54                    | 15                    | 54                 | 1 1/16                  | 10             |
| LCAX4/0-58F-X |                     |                   |                     | 5/8                  | 1.19                    | 1.03   | 0.16 | 2.39 | Purple             | P54                    | 15                    | 54                 | 1 1/16                  | 10             |
| LCAX4/0-34F-X |                     |                   |                     | 3/4                  | 1.19                    | 1.03   | 0.16 | 2.58 | Purple             | P54                    | 15                    | 54                 | 1 1/16                  | 10             |
| LCAX250-14F-X | 250 kcmil           | 262.6 kcmil       | —                   | 1/4                  | 1.28                    | 1.03   | 0.17 | 1.90 | Yellow             | P62                    | 16                    | 62                 | 1 1/16                  | 10             |
| LCAX250-56F-X |                     |                   |                     | 5/16                 | 1.28                    | 1.03   | 0.17 | 2.13 | Yellow             | P62                    | 16                    | 62                 | 1 1/16                  | 10             |
| LCAX250-38F-X |                     |                   |                     | 3/8                  | 1.28                    | 1.03   | 0.17 | 2.13 | Yellow             | P62                    | 16                    | 62                 | 1 1/16                  | 10             |
| LCAX250-12F-X |                     |                   |                     | 1/2                  | 1.28                    | 1.03   | 0.17 | 2.24 | Yellow             | P62                    | 16                    | 62                 | 1 1/16                  | 10             |
| LCAX250-58F-X |                     |                   |                     | 5/8                  | 1.28                    | 1.03   | 0.17 | 2.45 | Yellow             | P62                    | 16                    | 62                 | 1 1/16                  | 10             |
| LCAX250-34F-X |                     |                   |                     | 3/4                  | 1.28                    | 1.03   | 0.17 | 2.64 | Yellow             | P62                    | 16                    | 62                 | 1 1/16                  | 10             |
| LCAX300-38F-6 | 300 kcmil           | 313.1 kcmil       | —                   | 3/8                  | 1.39                    | 1.19   | 0.18 | 2.37 | Red                | P71                    | 18                    | 71H                | 1 1/4                   | 6              |
| LCAX300-12F-6 |                     |                   |                     | 1/2                  | 1.39                    | 1.19   | 0.18 | 2.37 | Red                | P71                    | 18                    | 71H                | 1 1/4                   | 6              |
| LCAX300-58F-6 |                     |                   |                     | 5/8                  | 1.39                    | 1.19   | 0.18 | 2.58 | Red                | P71                    | 18                    | 71H                | 1 1/4                   | 6              |
| LCAX350-56F-6 | 350 kcmil           | 373.7 kcmil       | —                   | 5/16                 | 1.54                    | 1.29   | 0.22 | 2.32 | Blue               | P76                    | 19                    | 76H                | 1 3/8                   | 6              |
| LCAX350-38F-6 |                     |                   |                     | 3/8                  | 1.54                    | 1.29   | 0.22 | 2.32 | Blue               | P76                    | 19                    | 76H                | 1 3/8                   | 6              |
| LCAX350-12F-6 |                     |                   |                     | 1/2                  | 1.54                    | 1.29   | 0.22 | 2.48 | Blue               | P76                    | 19                    | 76H                | 1 3/8                   | 6              |
| LCAX350-58F-6 |                     |                   |                     | 5/8                  | 1.54                    | 1.29   | 0.22 | 2.69 | Blue               | P76                    | 19                    | 76H                | 1 3/8                   | 6              |
| LCAX450-12F-6 | 450 kcmil           | 444.4 kcmil       | —                   | 1/2                  | 1.70                    | 1.40   | 0.26 | 2.95 | Brown              | P87                    | 20                    | 87H                | 1 7/16                  | 6              |
| LCAX450-58F-6 |                     |                   |                     | 5/8                  | 1.70                    | 1.40   | 0.26 | 3.08 | Brown              | P87                    | 20                    | 87H                | 1 7/16                  | 6              |
| LCAX500-56F-6 | 500 kcmil           | 535.3 kcmil       | —                   | 5/16                 | 1.89                    | 1.48   | 0.26 | 2.44 | Pink               | P99                    | L99                   | 99H                | 1 9/16                  | 6              |
| LCAX500-38F-6 |                     |                   |                     | 3/8                  | 1.89                    | 1.48   | 0.26 | 2.69 | Pink               | P99                    | L99                   | 99H                | 1 9/16                  | 6              |
| LCAX500-12F-6 |                     |                   |                     | 1/2                  | 1.89                    | 1.48   | 0.26 | 2.81 | Pink               | P99                    | L99                   | 99H                | 1 9/16                  | 6              |
| LCAX500-58F-6 |                     |                   |                     | 5/8                  | 1.89                    | 1.48   | 0.26 | 3.37 | Pink               | P99                    | L99                   | 99H                | 1 9/16                  | 6              |
| LCAX650-56F-6 | —                   | 646.4 kcmil       | —                   | 5/16                 | 1.95                    | 1.45   | 0.30 | 2.50 | Black              | P106                   | 24                    | 106H               | 1 1/2                   | 6              |
| LCAX650-38F-6 |                     |                   |                     | 3/8                  | 1.95                    | 1.45   | 0.30 | 2.50 | Black              | P106                   | 24                    | 106H               | 1 1/2                   | 6              |
| LCAX650-12F-6 |                     |                   |                     | 1/2                  | 1.95                    | 1.45   | 0.30 | 2.86 | Black              | P106                   | 24                    | 106H               | 1 1/2                   | 6              |
| LCAX650-58F-6 |                     |                   |                     | 5/8                  | 1.95                    | 1.45   | 0.30 | 3.42 | Black              | P106                   | 24                    | 106H               | 1 1/2                   | 6              |
| LCAX750-12F-3 | —                   | 777.7 kcmil       | —                   | 1/2                  | 2.17                    | 1.66   | 0.32 | 2.86 | Yellow             | P115                   | L115                  | 115H               | 1 3/4                   | 3              |
| LCAX750-58F-3 |                     |                   |                     | 5/8                  | 2.17                    | 1.66   | 0.32 | 3.67 | Yellow             | P115                   | L115                  | 115H               | 1 3/4                   | 3              |

‡See pages D3.70 – D3.73 for tool and die information.

\*Not UL Listed or CSA Certified with Class K flex conductor when crimped with Burndy tools.

\*\*Consult cable manufacturer for voltage stress relief instructions with applications greater than 2000 V.

A.  
System  
Overview

B1.  
Cable Ties

B2.  
Cable  
Accessories

B3.  
Stainless  
Steel Ties

C1.  
Wiring  
Duct

C2.  
Surface  
Raceway

C3.  
Abrasion  
Protection

C4.  
Cable  
Management

D1.  
Terminals

D2.  
Power  
Connectors

D3.  
Grounding  
Connectors

E1.  
Labeling  
Systems

E2.  
Labels

E3.  
Pre-Printed  
& Write-On  
Markers

E4.  
Permanent  
Identification

E5.  
Lockout/  
Tagout  
& Safety  
Solutions

F.  
Index

A. System Overview



## Flex Conductor, One-Hole, Standard Barrel with Window, Narrow Tongue Lug

B1. Cable Ties

### For Use with Flexible Copper Conductors

#### Type LCAXN

- Narrow tongue width for limited space applications
- Can be used with flex conductor class: Diesel Locomotive
- Generously beveled wire entry prevents bent back strands when inserting conductor into barrel
- Color-coded barrels marked with Panduit and specified competitor die index numbers for proper crimp die selection
- Inspection window to visually assure full conductor insertion
- Tin-plated to inhibit corrosion
- UL Listed and CSA Certified to 35 KV\*\* and temperature rated to 90°C when crimped with Panduit and specified competitor crimping tools and dies

B2. Cable Accessories

B3. Stainless Steel Ties

C1. Wiring Duct

C2. Surface Raceway

C3. Abrasion Protection

C4. Cable Management



| Part Number   | Flex Conductor Size | Stud Hole Size (in.) | Figure Dimensions (in.) |      |      |      | Panduit Color Code | Panduit Die Index No.‡ | Burndy Die Index No.‡ | T&B Die Index No.‡ | Wire Strip Length (in.) | Std. Pkg. Qty. |
|---------------|---------------------|----------------------|-------------------------|------|------|------|--------------------|------------------------|-----------------------|--------------------|-------------------------|----------------|
|               | Diesel Locomotive   |                      | W                       | B    | T    | L    |                    |                        |                       |                    |                         |                |
| LCAXN750-12-3 | 777.7 kcmil         | 1/2                  | 1.50                    | 1.66 | 0.33 | 3.94 | Yellow             | P115                   | L115                  | 115H               | 1 3/4                   | 3              |

‡See pages D3.70 – D3.73 for tool and die information.

\*\*Consult cable manufacturer for voltage stress relief instructions with applications greater than 2000 V.

D1. Terminals

D2. Power Connectors

D3. Grounding Connectors

E1. Labeling Systems

E2. Labels

E3. Pre-Printed & Write-On Markers

E4. Permanent Identification

E5. Lockout/Tagout & Safety Solutions

F. Index





## Flex Conductor, One-Hole, Standard Barrel with Window, Flared NEBS Lug

For Use with Flexible and Extra-Flexible Copper Conductors

### Type LCAF

- Can be used with flex conductor class: K, M, and Diesel Locomotive
- Flared entry prevents bent back strands when inserting fine strand conductor into barrel
- Color-coded barrels marked with Panduit die index numbers for proper crimp die selection
- Inspection window to visually assure full conductor insertion
- Tin-plated to inhibit corrosion
- UL Listed and CSA Certified to 35 KV\*\* and temperature rated to 90°C when crimped with Panduit crimping tools and dies
- **Tested by Telcordia – meets NEBS Level 3**
- American Bureau of Shipping approved

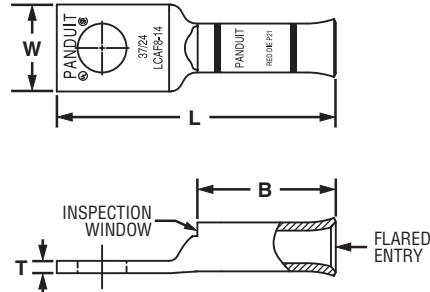

| Part Number  | Flex Conductor Size |                   | Stud Hole Size (In.) | Figure Dimensions (In.) |      |      |      | Panduit Color Code | Panduit Die Index No.‡ | Wire Strip Length (In.) | Std. Pkg. Qty. |
|--------------|---------------------|-------------------|----------------------|-------------------------|------|------|------|--------------------|------------------------|-------------------------|----------------|
|              | Class K and M       | Diesel Locomotive |                      | W                       | B    | T    | L    |                    |                        |                         |                |
| LCAF8-10-L   | —                   | #8 AWG            | #10                  | 0.41                    | 0.76 | 0.08 | 1.45 | Red                | P21                    | 13/16                   | 50             |
| LCAF8-14-L   |                     |                   | 1/4                  | 0.48                    | 0.76 | 0.07 | 1.54 | Red                | P21                    | 13/16                   | 50             |
| LCAF8-56-L   |                     |                   | 5/16                 | 0.56                    | 0.76 | 0.05 | 1.66 | Red                | P21                    | 13/16                   | 50             |
| LCAF8-38-L   |                     |                   | 3/8                  | 0.60                    | 0.76 | 0.05 | 1.76 | Red                | P21                    | 13/16                   | 50             |
| LCAF6-10-L   | #6 AWG              | #6 AWG            | #10                  | 0.45                    | 0.81 | 0.09 | 1.52 | Blue               | P24                    | 7/8                     | 50             |
| LCAF6-14-L   |                     |                   | 1/4                  | 0.48                    | 0.81 | 0.08 | 1.61 | Blue               | P24                    | 7/8                     | 50             |
| LCAF6-56-L   |                     |                   | 5/16                 | 0.56                    | 0.81 | 0.07 | 1.73 | Blue               | P24                    | 7/8                     | 50             |
| LCAF6-38-L   |                     |                   | 3/8                  | 0.62                    | 0.81 | 0.06 | 1.83 | Blue               | P24                    | 7/8                     | 50             |
| LCAF4-10-L   | #4 AWG              | #4 AWG            | #10                  | 0.55                    | 0.81 | 0.09 | 1.54 | Gray               | P29                    | 7/8                     | 50             |
| LCAF4-14-L   |                     |                   | 1/4                  | 0.55                    | 0.81 | 0.09 | 1.63 | Gray               | P29                    | 7/8                     | 50             |
| LCAF4-56-L   |                     |                   | 5/16                 | 0.55                    | 0.81 | 0.09 | 1.75 | Gray               | P29                    | 7/8                     | 50             |
| LCAF4-38-L   |                     |                   | 3/8                  | 0.62                    | 0.81 | 0.07 | 1.85 | Gray               | P29                    | 7/8                     | 50             |
| LCAF2-14-E   | #2 AWG              | #2 AWG            | 1/4                  | 0.70                    | 0.88 | 0.11 | 1.79 | Brown              | P33                    | 15/16                   | 20             |
| LCAF2-56-E   |                     |                   | 5/16                 | 0.70                    | 0.88 | 0.11 | 1.92 | Brown              | P33                    | 15/16                   | 20             |
| LCAF2-38-E   |                     |                   | 3/8                  | 0.70                    | 0.88 | 0.11 | 1.99 | Brown              | P33                    | 15/16                   | 20             |
| LCAF2-12-E   |                     |                   | 1/2                  | 0.79                    | 0.88 | 0.09 | 2.23 | Brown              | P33                    | 15/16                   | 20             |
| LCAF1-14-X   | #1 AWG              | #1 AWG            | 1/4                  | 0.76                    | 0.94 | 0.12 | 1.95 | Pink               | P42                    | 1                       | 10             |
| LCAF1-56-X   |                     |                   | 5/16                 | 0.76                    | 0.94 | 0.12 | 2.00 | Pink               | P42                    | 1                       | 10             |
| LCAF1-38-X   |                     |                   | 3/8                  | 0.76                    | 0.94 | 0.12 | 2.08 | Pink               | P42                    | 1                       | 10             |
| LCAF1-12-X   |                     |                   | 1/2                  | 0.80                    | 0.94 | 0.12 | 2.31 | Pink               | P42                    | 1                       | 10             |
| LCAF1/0-14-X | 1/0 AWG             | 1/0 AWG           | 1/4                  | 0.85                    | 1.35 | 0.13 | 2.46 | Black              | P45                    | 1 7/16                  | 10             |
| LCAF1/0-56-X |                     |                   | 5/16                 | 0.85                    | 1.35 | 0.13 | 2.46 | Black              | P45                    | 1 7/16                  | 10             |
| LCAF1/0-38-X |                     |                   | 3/8                  | 0.85                    | 1.35 | 0.13 | 2.52 | Black              | P45                    | 1 7/16                  | 10             |
| LCAF1/0-12-X |                     |                   | 1/2                  | 0.85                    | 1.35 | 0.13 | 2.77 | Black              | P45                    | 1 7/16                  | 10             |

‡See pages D3.74, D3.75 for tool and die information.

\*\*Consult cable manufacturer for voltage stress relief instructions with applications greater than 2000 V.

Table continues on page D2.74

A. System Overview

B1. Cable Ties

B2. Cable Accessories

B3. Stainless Steel Ties

C1. Wiring Duct

C2. Surface Raceway

C3. Abrasion Protection

C4. Cable Management

D1. Terminals

D2. Power Connectors

D3. Grounding Connectors

E1. Labeling Systems

E2. Labels

E3. Pre-Printed & Write-On Markers

E4. Permanent Identification

E5. Lockout/Tagout & Safety Solutions

F. Index

A. System Overview



## Flex Conductor, One-Hole, Standard Barrel with Window, Flared NEBS Lug (continued)

B1. Cable Ties

B2. Cable Accessories

B3. Stainless Steel Ties

C1. Wiring Duct

C2. Surface Raceway

C3. Abrasion Protection

C4. Cable Management

D1. Terminals

D2. Power Connectors

D3. Grounding Connectors

E1. Labeling Systems

E2. Labels

E3. Pre-Printed & Write-On Markers

E4. Permanent Identification

E5. Lockout/Tagout & Safety Solutions

F. Index

| Part Number         | Flex Conductor Size |                   | Stud Hole Size (In.) | Figure Dimensions (In.) |      |      |      | Panduit Color Code | Panduit Die Index No.‡ | Wire Strip Length (In.) | Std. Pkg. Qty. |
|---------------------|---------------------|-------------------|----------------------|-------------------------|------|------|------|--------------------|------------------------|-------------------------|----------------|
|                     | Class K and M       | Diesel Locomotive |                      | W                       | B    | T    | L    |                    |                        |                         |                |
| LCAF2/0-14-X        | 2/0 AWG             | 2/0 AWG           | 1/4                  | 0.96                    | 1.35 | 0.13 | 2.49 | Orange             | P50                    | 1 7/16                  | 10             |
| LCAF2/0-56-X        |                     |                   | 5/16                 | 0.96                    | 1.35 | 0.13 | 2.49 | Orange             | P50                    | 1 7/16                  | 10             |
| <b>LCAF2/0-38-X</b> |                     |                   | 3/8                  | 0.96                    | 1.35 | 0.13 | 2.55 | Orange             | P50                    | 1 7/16                  | 10             |
| LCAF2/0-12-X        |                     |                   | 1/2                  | 0.96                    | 1.35 | 0.13 | 2.80 | Orange             | P50                    | 1 7/16                  | 10             |
| LCAF3/0-14-X        | 3/0 AWG             | 3/0 AWG           | 1/4                  | 1.06                    | 1.35 | 0.14 | 2.52 | Purple             | P54                    | 1 7/16                  | 10             |
| LCAF3/0-56-X        |                     |                   | 5/16                 | 1.06                    | 1.35 | 0.14 | 2.53 | Purple             | P54                    | 1 7/16                  | 10             |
| LCAF3/0-38-X        |                     |                   | 3/8                  | 1.06                    | 1.35 | 0.14 | 2.60 | Purple             | P54                    | 1 7/16                  | 10             |
| LCAF3/0-12-X        |                     |                   | 1/2                  | 1.06                    | 1.35 | 0.14 | 2.83 | Purple             | P54                    | 1 7/16                  | 10             |
| LCAF4/0-14-X        | 4/0 AWG             | 4/0 AWG           | 1/4                  | 1.17                    | 1.35 | 0.14 | 2.56 | Yellow             | P62                    | 1 7/16                  | 10             |
| LCAF4/0-56-X        |                     |                   | 5/16                 | 1.17                    | 1.35 | 0.14 | 2.58 | Yellow             | P62                    | 1 7/16                  | 10             |
| LCAF4/0-38-X        |                     |                   | 3/8                  | 1.17                    | 1.35 | 0.14 | 2.65 | Yellow             | P62                    | 1 7/16                  | 10             |
| <b>LCAF4/0-12-X</b> |                     |                   | 1/2                  | 1.17                    | 1.35 | 0.14 | 2.88 | Yellow             | P62                    | 1 7/16                  | 10             |
| LCAF250-38-X        | 250 kcmil           | 262.6 kcmil       | 3/8                  | 1.28                    | 1.65 | 0.17 | 3.19 | White              | P66                    | 1 3/4                   | 10             |
| LCAF250-12-X        |                     |                   | 1/2                  | 1.28                    | 1.65 | 0.17 | 3.30 | White              | P66                    | 1 3/4                   | 10             |
| LCAF250-58-X        |                     |                   | 5/8                  | 1.28                    | 1.65 | 0.17 | 3.51 | White              | P66                    | 1 3/4                   | 10             |
| LCAF250-78-X        |                     |                   | 7/8                  | 1.28                    | 1.65 | 0.17 | 3.95 | White              | P66                    | 1 3/4                   | 10             |
| LCAF300-38-6        | 300 kcmil           | 313.1 kcmil       | 3/8                  | 1.39                    | 1.65 | 0.18 | 3.37 | Red                | P71                    | 1 3/4                   | 6              |
| LCAF300-12-6        |                     |                   | 1/2                  | 1.39                    | 1.65 | 0.18 | 3.37 | Red                | P71                    | 1 3/4                   | 6              |
| LCAF300-58-6        |                     |                   | 5/8                  | 1.39                    | 1.65 | 0.18 | 3.58 | Red                | P71                    | 1 3/4                   | 6              |
| LCAF300-78-6        |                     |                   | 7/8                  | 1.39                    | 1.65 | 0.18 | 3.97 | Red                | P71                    | 1 3/4                   | 6              |
| LCAF350-38-6        | 350 kcmil           | 373.7 kcmil       | 3/8                  | 1.54                    | 1.85 | 0.22 | 3.49 | Blue               | P76                    | 1 15/16                 | 6              |
| <b>LCAF350-12-6</b> |                     |                   | 1/2                  | 1.54                    | 1.85 | 0.22 | 3.65 | Blue               | P76                    | 1 15/16                 | 6              |
| LCAF350-58-6        |                     |                   | 5/8                  | 1.54                    | 1.85 | 0.22 | 3.86 | Blue               | P76                    | 1 15/16                 | 6              |
| LCAF350-34-6        |                     |                   | 3/4                  | 1.54                    | 1.85 | 0.22 | 4.00 | Blue               | P76                    | 1 15/16                 | 6              |
| LCAF350-78-6        | 400 kcmil           | 444.4 kcmil       | 7/8                  | 1.54                    | 1.85 | 0.22 | 4.25 | Blue               | P76                    | 1 15/16                 | 6              |
| LCAF350-1-6         |                     |                   | 1                    | 1.54                    | 1.85 | 0.22 | 4.37 | Blue               | P76                    | 1 15/16                 | 6              |
| LCAF400-12-6        |                     |                   | 1/2                  | 1.70                    | 2.20 | 0.26 | 4.65 | Brown              | P87                    | 2 1/4                   | 6              |
| LCAF400-58-6        |                     |                   | 5/8                  | 1.70                    | 2.20 | 0.26 | 4.65 | Brown              | P87                    | 2 1/4                   | 6              |
| LCAF400-78-6        | 500 kcmil           | 535.3 kcmil       | 7/8                  | 1.70                    | 2.20 | 0.26 | 4.65 | Brown              | P87                    | 2 1/4                   | 6              |
| LCAF500-12-6        |                     |                   | 1/2                  | 1.89                    | 2.28 | 0.26 | 4.99 | Pink               | P99                    | 2 5/16                  | 6              |
| LCAF500-58-6        |                     |                   | 5/8                  | 1.89                    | 2.28 | 0.26 | 5.18 | Pink               | P99                    | 2 5/16                  | 6              |
| LCAF600-12-6        |                     |                   | —                    | 646.4 kcmil             | 1/2  | 1.95 | 2.33 | 0.30               | 5.07                   | Black                   | P106           |
| LCAF600-58-6        | 5/8                 | 1.95              |                      |                         | 2.33 | 0.30 | 5.26 | Black              | P106                   | 2 3/8                   | 6              |
| LCAF750-12-3        | —                   | 777.7 kcmil       | 1/2                  | 2.17                    | 2.38 | 0.32 | 5.21 | Orange             | P107                   | 2 7/16                  | 3              |
| LCAF750-58-3        |                     |                   | 5/8                  | 2.17                    | 2.38 | 0.32 | 5.40 | Orange             | P107                   | 2 7/16                  | 3              |

‡See pages D3.74, D3.75 for tool and die information.

\*\*Consult cable manufacturer for voltage stress relief instructions with applications greater than 2000 V.



## Flex Conductor, One-Hole, Standard Barrel with Window, Flared NEBS Lug, 45° Angle

For Use with Flexible and Extra-Flexible Copper Conductors

### Type LCAF-H

- Can be used with flex conductor class: K, M, and Diesel Locomotive
- Flared entry prevents bent back strands when inserting fine strand conductor into barrel
- Color-coded barrels marked with Panduit die index numbers for proper crimp die selection
- Inspection window to visually assure full conductor insertion
- Tin-plated to inhibit corrosion
- UL Listed and CSA Certified to 35 KV\*\* and temperature rated to 90°C when crimped with Panduit crimping tools and dies
- Tested by Telcordia – meets NEBS Level 3
- American Bureau of Shipping approved

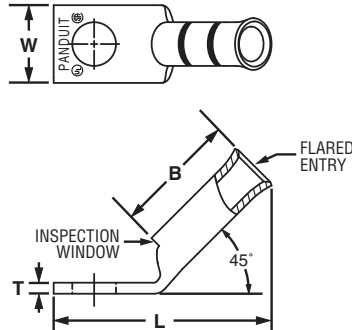

| Part Number   | Flex Conductor Size |                   | Stud Hole Size (In.) | Figure Dimensions (In.) |      |      |      | Panduit Color Code | Panduit Die Index No.‡ | Wire Strip Length (In.) | Std. Pkg. Qty. |
|---------------|---------------------|-------------------|----------------------|-------------------------|------|------|------|--------------------|------------------------|-------------------------|----------------|
|               | Class K and M       | Diesel Locomotive |                      | W                       | B    | T    | L    |                    |                        |                         |                |
| LCAF8-10H-L   | —                   | #8 AWG            | #10                  | 0.41                    | 0.76 | 0.08 | 1.26 | Red                | P21                    | 13/16                   | 50             |
| LCAF8-14H-L   |                     |                   | 1/4                  | 0.48                    | 0.76 | 0.07 | 1.35 | Red                | P21                    | 13/16                   | 50             |
| LCAF8-56H-L   |                     |                   | 5/16                 | 0.56                    | 0.76 | 0.05 | 1.46 | Red                | P21                    | 13/16                   | 50             |
| LCAF8-38H-L   |                     |                   | 3/8                  | 0.60                    | 0.76 | 0.05 | 1.55 | Red                | P21                    | 13/16                   | 50             |
| LCAF6-10H-L   | #6 AWG              | #6 AWG            | #10                  | 0.45                    | 0.81 | 0.09 | 1.31 | Blue               | P24                    | 7/8                     | 50             |
| LCAF6-14H-L   |                     |                   | 1/4                  | 0.48                    | 0.81 | 0.08 | 1.40 | Blue               | P24                    | 7/8                     | 50             |
| LCAF6-56H-L   |                     |                   | 5/16                 | 0.56                    | 0.81 | 0.07 | 1.51 | Blue               | P24                    | 7/8                     | 50             |
| LCAF6-38H-L   |                     |                   | 3/8                  | 0.62                    | 0.81 | 0.06 | 1.61 | Blue               | P24                    | 7/8                     | 50             |
| LCAF4-10H-L   | #4 AWG              | #4 AWG            | #10                  | 0.55                    | 0.81 | 0.09 | 1.34 | Gray               | P29                    | 7/8                     | 50             |
| LCAF4-14H-L   |                     |                   | 1/4                  | 0.55                    | 0.81 | 0.09 | 1.43 | Gray               | P29                    | 7/8                     | 50             |
| LCAF4-56H-L   |                     |                   | 5/16                 | 0.55                    | 0.81 | 0.09 | 1.55 | Gray               | P29                    | 7/8                     | 50             |
| LCAF4-38H-L   |                     |                   | 3/8                  | 0.62                    | 0.81 | 0.07 | 1.64 | Gray               | P29                    | 7/8                     | 50             |
| LCAF2-14H-E   | #2 AWG              | #2 AWG            | 1/4                  | 0.70                    | 0.88 | 0.11 | 1.52 | Brown              | P33                    | 15/16                   | 20             |
| LCAF2-56H-E   |                     |                   | 5/16                 | 0.70                    | 0.88 | 0.11 | 1.65 | Brown              | P33                    | 15/16                   | 20             |
| LCAF2-38H-E   |                     |                   | 3/8                  | 0.70                    | 0.88 | 0.11 | 1.72 | Brown              | P33                    | 15/16                   | 20             |
| LCAF2-12H-E   |                     |                   | 1/2                  | 0.79                    | 0.88 | 0.09 | 1.95 | Brown              | P33                    | 15/16                   | 20             |
| LCAF1-14H-X   | #1 AWG              | #1 AWG            | 1/4                  | 0.76                    | 0.94 | 0.12 | 1.65 | Pink               | P42                    | 1                       | 10             |
| LCAF1-56H-X   |                     |                   | 5/16                 | 0.76                    | 0.94 | 0.12 | 1.71 | Pink               | P42                    | 1                       | 10             |
| LCAF1-38H-X   |                     |                   | 3/8                  | 0.76                    | 0.94 | 0.12 | 1.78 | Pink               | P42                    | 1                       | 10             |
| LCAF1-12H-X   |                     |                   | 1/2                  | 0.80                    | 0.94 | 0.12 | 2.01 | Pink               | P42                    | 1                       | 10             |
| LCAF1/0-14H-X | 1/0 AWG             | 1/0 AWG           | 1/4                  | 0.85                    | 1.35 | 0.13 | 2.06 | Black              | P45                    | 1 7/16                  | 10             |
| LCAF1/0-56H-X |                     |                   | 5/16                 | 0.85                    | 1.35 | 0.13 | 2.06 | Black              | P45                    | 1 7/16                  | 10             |
| LCAF1/0-38H-X |                     |                   | 3/8                  | 0.85                    | 1.35 | 0.13 | 2.12 | Black              | P45                    | 1 7/16                  | 10             |
| LCAF1/0-12H-X |                     |                   | 1/2                  | 0.85                    | 1.35 | 0.13 | 2.37 | Black              | P45                    | 1 7/16                  | 10             |
| LCAF2/0-14H-X | 2/0 AWG             | 2/0 AWG           | 1/4                  | 0.96                    | 1.35 | 0.13 | 2.08 | Orange             | P50                    | 1 7/16                  | 10             |
| LCAF2/0-56H-X |                     |                   | 5/16                 | 0.96                    | 1.35 | 0.13 | 2.08 | Orange             | P50                    | 1 7/16                  | 10             |
| LCAF2/0-38H-X |                     |                   | 3/8                  | 0.96                    | 1.35 | 0.13 | 2.14 | Orange             | P50                    | 1 7/16                  | 10             |
| LCAF2/0-12H-X |                     |                   | 1/2                  | 0.96                    | 1.35 | 0.13 | 2.39 | Orange             | P50                    | 1 7/16                  | 10             |

‡See pages D3.74, D3.75 for tool and die information.

\*\*Consult cable manufacturer for voltage stress relief instructions with applications greater than 2000 V.

Table continues on page D2.76

A. System Overview

B1. Cable Ties

B2. Cable Accessories

B3. Stainless Steel Ties

C1. Wiring Duct

C2. Surface Raceway

C3. Abrasion Protection

C4. Cable Management

D1. Terminals

D2. Power Connectors

D3. Grounding Connectors

E1. Labeling Systems

E2. Labels

E3. Pre-Printed & Write-On Markers

E4. Permanent Identification

E5. Lockout/Tagout & Safety Solutions

F. Index

A. System Overview



## Flex Conductor, One-Hole, Standard Barrel with Window, Flared NEBS Lug, 45° Angle (continued)

B1. Cable Ties

B2. Cable Accessories

B3. Stainless Steel Ties

C1. Wiring Duct

C2. Surface Raceway

C3. Abrasion Protection

C4. Cable Management

D1. Terminals

D2. Power Connectors

D3. Grounding Connectors

E1. Labeling Systems

E2. Labels

E3. Pre-Printed & Write-On Markers

E4. Permanent Identification

E5. Lockout/Tagout & Safety Solutions

F. Index

| Part Number   | Flex Conductor Size |                   | Stud Hole Size (In.) | Figure Dimensions (In.) |      |       |      | Panduit Color Code | Panduit Die Index No.‡ | Wire Strip Length (In.) | Std. Pkg. Qty. |
|---------------|---------------------|-------------------|----------------------|-------------------------|------|-------|------|--------------------|------------------------|-------------------------|----------------|
|               | Class K and M       | Diesel Locomotive |                      | W                       | B    | T     | L    |                    |                        |                         |                |
| LCAF3/0-14H-X | 3/0 AWG             | 3/0 AWG           | 1/4                  | 1.06                    | 1.35 | 0.14  | 2.11 | Purple             | P54                    | 1 7/16                  | 10             |
| LCAF3/0-56H-X |                     |                   | 5/16                 | 1.06                    | 1.35 | 0.14  | 2.13 | Purple             | P54                    | 1 7/16                  | 10             |
| LCAF3/0-38H-X |                     |                   | 3/8                  | 1.06                    | 1.35 | 0.14  | 2.20 | Purple             | P54                    | 1 7/16                  | 10             |
| LCAF3/0-12H-X |                     |                   | 1/2                  | 1.06                    | 1.35 | 0.14  | 2.43 | Purple             | P54                    | 1 7/16                  | 10             |
| LCAF4/0-14H-X | 4/0 AWG             | 4/0 AWG           | 1/4                  | 1.17                    | 1.35 | 0.14  | 2.16 | Yellow             | P62                    | 1 7/16                  | 10             |
| LCAF4/0-56H-X |                     |                   | 5/16                 | 1.17                    | 1.35 | 0.14  | 2.17 | Yellow             | P62                    | 1 7/16                  | 10             |
| LCAF4/0-38H-X |                     |                   | 3/8                  | 1.17                    | 1.35 | 0.14  | 2.24 | Yellow             | P62                    | 1 7/16                  | 10             |
| LCAF4/0-12H-X |                     |                   | 1/2                  | 1.17                    | 1.35 | 0.14  | 2.47 | Yellow             | P62                    | 1 7/16                  | 10             |
| LCAF250-38H-X | 250 kcmil           | 262.6 kcmil       | 3/8                  | 1.28                    | 1.65 | 0.17  | 3.19 | White              | P66                    | 1 3/4                   | 10             |
| LCAF250-12H-X |                     |                   | 1/2                  | 1.28                    | 1.65 | 0.17  | 2.89 | White              | P66                    | 1 3/4                   | 10             |
| LCAF250-58H-X |                     |                   | 5/8                  | 1.28                    | 1.65 | 0.17  | 3.10 | White              | P66                    | 1 3/4                   | 10             |
| LCAF250-78H-X |                     |                   | 7/8                  | 1.28                    | 1.65 | 0.17  | 3.54 | White              | P66                    | 1 3/4                   | 10             |
| LCAF300-38H-6 | 300 kcmil           | 313.1 kcmil       | 3/8                  | 1.39                    | 1.64 | 0.18  | 3.00 | Red                | P71                    | 1 3/4                   | 6              |
| LCAF300-12H-6 |                     |                   | 1/2                  | 1.39                    | 1.64 | 0.18  | 3.00 | Red                | P71                    | 1 3/4                   | 6              |
| LCAF300-58H-6 |                     |                   | 5/8                  | 1.39                    | 1.64 | 0.18  | 3.21 | Red                | P71                    | 1 3/4                   | 6              |
| LCAF300-78H-6 |                     |                   | 7/8                  | 1.39                    | 1.64 | 0.18  | 3.60 | Red                | P71                    | 1 3/4                   | 6              |
| LCAF350-38H-6 | 350 kcmil           | 373.7 kcmil       | 3/8                  | 1.54                    | 1.84 | 0.22  | 3.06 | Blue               | P76                    | 1 15/16                 | 6              |
| LCAF350-12H-6 |                     |                   | 1/2                  | 1.54                    | 1.84 | 0.22  | 3.22 | Blue               | P76                    | 1 15/16                 | 6              |
| LCAF350-58H-6 |                     |                   | 5/8                  | 1.54                    | 1.84 | 0.22  | 3.43 | Blue               | P76                    | 1 15/16                 | 6              |
| LCAF350-34H-6 |                     |                   | 3/4                  | 1.54                    | 1.84 | 0.22  | 3.57 | Blue               | P76                    | 1 15/16                 | 6              |
| LCAF350-78H-6 |                     |                   | 7/8                  | 1.54                    | 1.84 | 0.22  | 3.82 | Blue               | P76                    | 1 15/16                 | 6              |
| LCAF350-1H-6  | 400 kcmil           | 444.4 kcmil       | 1                    | 1.54                    | 1.84 | 0.22  | 3.94 | Blue               | P76                    | 1 15/16                 | 6              |
| LCAF400-12H-6 |                     |                   | 1/2                  | 1.70                    | 2.19 | 0.26  | 4.12 | Brown              | P87                    | 2 1/4                   | 6              |
| LCAF400-58H-6 |                     |                   | 5/8                  | 1.70                    | 2.19 | 0.26  | 4.12 | Brown              | P87                    | 2 1/4                   | 6              |
| LCAF400-78H-6 | 7/8                 | 1.70              | 2.19                 | 0.26                    | 4.12 | Brown | P87  | 2 1/4              | 6                      |                         |                |

‡See pages D3.74, D3.75 for tool and die information.

\*\*Consult cable manufacturer for voltage stress relief instructions with applications greater than 2000 V.



## Flex Conductor, One-Hole, Standard Barrel with Window, Flared NEBS Lug, 90° Angle

For Use with Flexible and Extra-Flexible Copper Conductors

### Type LCAF-F

- Can be used with flex conductor class: K, M, and Diesel Locomotive
- Flared entry prevents bent back strands when inserting fine strand conductor into barrel
- Color-coded barrels marked with Panduit die index numbers for proper crimp die selection
- Inspection window to visually assure full conductor insertion
- Tin-plated to inhibit corrosion
- UL Listed and CSA Certified to 35 KV\*\* and temperature rated to 90°C when crimped with Panduit crimping tools and dies
- **Tested by Telcordia – meets NEBS Level 3**
- American Bureau of Shipping Approved

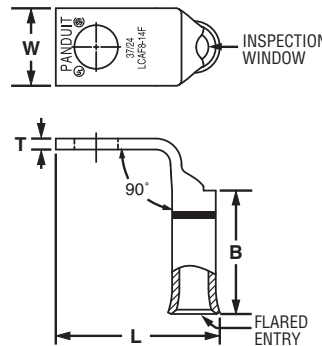

| Part Number   | Flex Conductor Size |                   | Stud Hole Size (In.) | Figure Dimensions (In.) |      |      |      | Panduit Color Code | Panduit Die Index No.‡ | Wire Strip Length (In.) | Std. Pkg. Qty. |
|---------------|---------------------|-------------------|----------------------|-------------------------|------|------|------|--------------------|------------------------|-------------------------|----------------|
|               | Class K and M       | Diesel Locomotive |                      | W                       | B    | T    | L    |                    |                        |                         |                |
| LCAF8-10F-L   | —                   | #8 AWG            | #10                  | 0.41                    | 0.76 | 0.08 | 0.93 | Red                | P21                    | 13/16                   | 50             |
| LCAF8-14F-L   |                     |                   | 1/4                  | 0.48                    | 0.76 | 0.07 | 1.02 | Red                | P21                    | 13/16                   | 50             |
| LCAF8-56F-L   |                     |                   | 5/16                 | 0.56                    | 0.76 | 0.05 | 1.14 | Red                | P21                    | 13/16                   | 50             |
| LCAF8-38F-L   |                     |                   | 3/8                  | 0.60                    | 0.76 | 0.05 | 1.24 | Red                | P21                    | 13/16                   | 50             |
| LCAF6-10F-L   | #6 AWG              | #6 AWG            | #10                  | 0.45                    | 0.81 | 0.09 | 1.52 | Blue               | P24                    | 7/8                     | 50             |
| LCAF6-14F-L   |                     |                   | 1/4                  | 0.48                    | 0.81 | 0.08 | 1.06 | Blue               | P24                    | 7/8                     | 50             |
| LCAF6-56F-L   |                     |                   | 5/16                 | 0.56                    | 0.81 | 0.07 | 1.18 | Blue               | P24                    | 7/8                     | 50             |
| LCAF6-38F-L   |                     |                   | 3/8                  | 0.62                    | 0.81 | 0.06 | 1.28 | Blue               | P24                    | 7/8                     | 50             |
| LCAF4-10F-L   | #4 AWG              | #4 AWG            | #10                  | 0.55                    | 0.81 | 0.09 | 1.07 | Gray               | P29                    | 7/8                     | 50             |
| LCAF4-14F-L   |                     |                   | 1/4                  | 0.55                    | 0.81 | 0.09 | 1.16 | Gray               | P29                    | 7/8                     | 50             |
| LCAF4-56F-L   |                     |                   | 5/16                 | 0.55                    | 0.81 | 0.09 | 1.28 | Gray               | P29                    | 7/8                     | 50             |
| LCAF4-38F-L   |                     |                   | 3/8                  | 0.62                    | 0.81 | 0.07 | 1.38 | Gray               | P29                    | 7/8                     | 50             |
| LCAF2-14F-E   | #2 AWG              | #2 AWG            | 1/4                  | 0.70                    | 0.88 | 0.11 | 1.35 | Brown              | P33                    | 15/16                   | 20             |
| LCAF2-56F-E   |                     |                   | 5/16                 | 0.70                    | 0.88 | 0.11 | 1.48 | Brown              | P33                    | 15/16                   | 20             |
| LCAF2-38F-E   |                     |                   | 3/8                  | 0.70                    | 0.88 | 0.11 | 1.55 | Brown              | P33                    | 15/16                   | 20             |
| LCAF2-12F-E   |                     |                   | 1/2                  | 0.79                    | 0.88 | 0.09 | 1.79 | Brown              | P33                    | 15/16                   | 20             |
| LCAF1-14F-X   | #1 AWG              | #1 AWG            | 1/4                  | 0.76                    | 0.94 | 0.12 | 1.49 | Pink               | P42                    | 1                       | 10             |
| LCAF1-56F-X   |                     |                   | 5/16                 | 0.76                    | 0.94 | 0.12 | 1.54 | Pink               | P42                    | 1                       | 10             |
| LCAF1-38F-X   |                     |                   | 3/8                  | 0.76                    | 0.94 | 0.12 | 1.62 | Pink               | P42                    | 1                       | 10             |
| LCAF1-12F-X   |                     |                   | 1/2                  | 0.80                    | 0.94 | 0.12 | 1.85 | Pink               | P42                    | 1                       | 10             |
| LCAF1/0-14F-X | 1/0 AWG             | 1/0 AWG           | 1/4                  | 0.85                    | 1.35 | 0.13 | 1.64 | Black              | P45                    | 1 7/16                  | 10             |
| LCAF1/0-56F-X |                     |                   | 5/16                 | 0.85                    | 1.35 | 0.13 | 1.70 | Black              | P45                    | 1 7/16                  | 10             |
| LCAF1/0-38F-X |                     |                   | 3/8                  | 0.85                    | 1.35 | 0.13 | 1.70 | Black              | P45                    | 1 7/16                  | 10             |
| LCAF1/0-12F-X |                     |                   | 1/2                  | 0.85                    | 1.35 | 0.13 | 1.95 | Black              | P45                    | 1 7/16                  | 10             |

‡See pages D3.74, D3.75 for tool and die information.

\*\*Consult cable manufacturer for voltage stress relief instructions with applications greater than 2000 V.

Table continues on page D2.78

A. System Overview

B1. Cable Ties

B2. Cable Accessories

B3. Stainless Steel Ties

C1. Wiring Duct

C2. Surface Raceway

C3. Abrasion Protection

C4. Cable Management

D1. Terminals

D2. Power Connectors

D3. Grounding Connectors

E1. Labeling Systems

E2. Labels

E3. Pre-Printed & Write-On Markers

E4. Permanent Identification

E5. Lockout/Tagout & Safety Solutions

F. Index

A. System Overview



## Flex Conductor, One-Hole, Standard Barrel with Window, Flared NEBS Lug, 90° Angle (continued)

B1. Cable Ties

B2. Cable Accessories

B3. Stainless Steel Ties

C1. Wiring Duct

C2. Surface Raceway

C3. Abrasion Protection

C4. Cable Management

D1. Terminals

D2. Power Connectors

D3. Grounding Connectors

E1. Labeling Systems

E2. Labels

E3. Pre-Printed & Write-On Markers

E4. Permanent Identification

E5. Lockout/Tagout & Safety Solutions

F. Index

| Part Number   | Flex Conductor Size |                   | Stud Hole Size (In.) | Figure Dimensions (In.) |      |      |      | Panduit Color Code | Panduit Die Index No.‡ | Wire Strip Length (In.) | Std. Pkg. Qty. |
|---------------|---------------------|-------------------|----------------------|-------------------------|------|------|------|--------------------|------------------------|-------------------------|----------------|
|               | Class K and M       | Diesel Locomotive |                      | W                       | B    | T    | L    |                    |                        |                         |                |
| LCAF2/0-14F-X | 2/0 AWG             | 2/0 AWG           | 1/4                  | 0.96                    | 1.35 | 0.13 | 1.71 | Orange             | P50                    | 1 7/16                  | 10             |
| LCAF2/0-56F-X |                     |                   | 5/16                 | 0.96                    | 1.35 | 0.13 | 1.71 | Orange             | P50                    | 1 7/16                  | 10             |
| LCAF2/0-38F-X |                     |                   | 3/8                  | 0.96                    | 1.35 | 0.13 | 1.77 | Orange             | P50                    | 1 7/16                  | 10             |
| LCAF2/0-12F-X | 3/0 AWG             | 3/0 AWG           | 1/2                  | 0.96                    | 1.35 | 0.13 | 2.02 | Orange             | P50                    | 1 7/16                  | 10             |
| LCAF3/0-14F-X |                     |                   | 1/4                  | 1.06                    | 1.35 | 0.14 | 1.81 | Purple             | P54                    | 1 7/16                  | 10             |
| LCAF3/0-56F-X |                     |                   | 5/16                 | 1.06                    | 1.35 | 0.14 | 1.82 | Purple             | P54                    | 1 7/16                  | 10             |
| LCAF3/0-38F-X | 4/0 AWG             | 4/0 AWG           | 3/8                  | 1.06                    | 1.35 | 0.14 | 1.89 | Purple             | P54                    | 1 7/16                  | 10             |
| LCAF3/0-12F-X |                     |                   | 1/2                  | 1.06                    | 1.35 | 0.14 | 2.12 | Purple             | P54                    | 1 7/16                  | 10             |
| LCAF4/0-14F-X |                     |                   | 1/4                  | 1.17                    | 1.35 | 0.14 | 1.88 | Yellow             | P62                    | 1 7/16                  | 10             |
| LCAF4/0-56F-X | 4/0 AWG             | 4/0 AWG           | 5/16                 | 1.17                    | 1.35 | 0.14 | 1.90 | Yellow             | P62                    | 1 7/16                  | 10             |
| LCAF4/0-38F-X |                     |                   | 3/8                  | 1.17                    | 1.35 | 0.14 | 1.97 | Yellow             | P62                    | 1 7/16                  | 10             |
| LCAF4/0-12F-X |                     |                   | 1/2                  | 1.17                    | 1.35 | 0.14 | 2.20 | Yellow             | P62                    | 1 7/16                  | 10             |
| LCAF250-38F-X | 250 kcmil           | 262.6 kcmil       | 3/8                  | 1.28                    | 1.65 | 0.17 | 2.21 | White              | P66                    | 1 3/4                   | 10             |
| LCAF250-12F-X |                     |                   | 1/2                  | 1.28                    | 1.65 | 0.17 | 2.32 | White              | P66                    | 1 3/4                   | 10             |
| LCAF250-58F-X |                     |                   | 5/8                  | 1.28                    | 1.65 | 0.17 | 2.53 | White              | P66                    | 1 3/4                   | 10             |
| LCAF250-78F-X | 300 kcmil           | 313.1 kcmil       | 7/8                  | 1.28                    | 1.65 | 0.17 | 2.97 | White              | P66                    | 1 3/4                   | 10             |
| LCAF300-38F-6 |                     |                   | 3/8                  | 1.39                    | 1.65 | 0.18 | 2.44 | Red                | P71                    | 1 3/4                   | 6              |
| LCAF300-12F-6 |                     |                   | 1/2                  | 1.39                    | 1.65 | 0.18 | 2.44 | Red                | P71                    | 1 3/4                   | 6              |
| LCAF300-58F-6 | 350 kcmil           | 373.7 kcmil       | 5/8                  | 1.39                    | 1.65 | 0.18 | 2.65 | Red                | P71                    | 1 3/4                   | 6              |
| LCAF300-78F-6 |                     |                   | 7/8                  | 1.39                    | 1.65 | 0.18 | 3.04 | Red                | P71                    | 1 3/4                   | 6              |
| LCAF350-38F-6 |                     |                   | 3/8                  | 1.54                    | 1.85 | 0.22 | 2.40 | Blue               | P76                    | 1 15/16                 | 6              |
| LCAF350-12F-6 | 400 kcmil           | 444.4 kcmil       | 1/2                  | 1.54                    | 1.85 | 0.22 | 2.40 | Blue               | P76                    | 1 15/16                 | 6              |
| LCAF350-58F-6 |                     |                   | 5/8                  | 1.54                    | 1.85 | 0.22 | 2.77 | Blue               | P76                    | 1 15/16                 | 6              |
| LCAF350-34F-6 |                     |                   | 3/4                  | 1.54                    | 1.85 | 0.22 | 2.91 | Blue               | P76                    | 1 15/16                 | 6              |
| LCAF350-78F-6 | 400 kcmil           | 444.4 kcmil       | 7/8                  | 1.54                    | 1.85 | 0.22 | 3.16 | Blue               | P76                    | 1 15/16                 | 6              |
| LCAF350-1F-6  |                     |                   | 1                    | 1.54                    | 1.85 | 0.22 | 3.28 | Blue               | P76                    | 1 15/16                 | 6              |
| LCAF400-12F-6 |                     |                   | 1/2                  | 1.70                    | 2.20 | 0.26 | 3.28 | Brown              | P87                    | 2 1/4                   | 6              |
| LCAF400-58F-6 | 400 kcmil           | 444.4 kcmil       | 5/8                  | 1.70                    | 2.20 | 0.26 | 3.28 | Brown              | P87                    | 2 1/4                   | 6              |
| LCAF400-78F-6 |                     |                   | 7/8                  | 1.70                    | 2.20 | 0.26 | 3.28 | Brown              | P87                    | 2 1/4                   | 6              |

‡See pages D3.74, D3.75 for tool and die information.

\*\*Consult cable manufacturer for voltage stress relief instructions with applications greater than 2000 V.





## Flex Conductor, One-Hole, Long Barrel with Window Lug

For Use with Flexible, Extra-Flexible, and Code Stranded Copper Conductors

### Type LCBX

- Can be used with code conductor and flex conductor class: G, H, I, K, M and Diesel Locomotive
- Long barrel maximizes number of crimps and provides premium wire pull-out strength and electrical performance
- Generously beveled wire entry prevents bent back strands when inserting conductor into barrel
- Color-coded barrels marked with Panduit and specified competitor die index numbers for proper crimp die selection
- Inspection window to visually assure full conductor insertion
- Tin-plated to inhibit corrosion
- UL Listed and CSA Certified to 35 KV\*\* and temperature rated to 90°C when crimped with Panduit and specified competitor crimping tools and dies
- Meets J-STD-607-A and TIA-942 requirements for network systems grounding applications

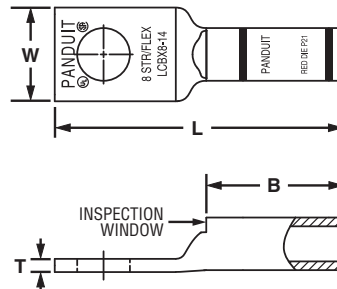

| Part Number  | Flex Conductor Size |                   | Code Conductor Size | Stud Hole Size (In.) | Figure Dimensions (In.) |      |      |      | Panduit Color Code | Panduit Die Index No.‡ | Burdny Die Index No.‡ | T&B Die Index No.‡ | Wire Strip Length (In.) | Std. Pkg. Qty. |
|--------------|---------------------|-------------------|---------------------|----------------------|-------------------------|------|------|------|--------------------|------------------------|-----------------------|--------------------|-------------------------|----------------|
|              | Class G, H, I, K, M | Diesel Locomotive |                     |                      | W                       | B    | T    | L    |                    |                        |                       |                    |                         |                |
| LCBX8-10-L   |                     |                   |                     | #10                  | 0.41                    | 0.70 | 0.08 | 1.39 | Red                | P21                    | 49                    | 21                 | 3/4                     | 50             |
| LCBX8-14-L   | #8 AWG              | #8 AWG            | #8 AWG              | 1/4                  | 0.48                    | 0.70 | 0.07 | 1.48 | Red                | P21                    | 49                    | 21                 | 3/4                     | 50             |
| LCBX8-38-L   |                     |                   |                     | 3/8                  | 0.60                    | 0.70 | 0.05 | 1.70 | Red                | P21                    | 49                    | 21                 | 3/4                     | 50             |
| LCBX6-14-L   | #6 AWG              | #6 AWG            | #6 AWG              | 1/4                  | 0.48                    | 1.07 | 0.08 | 1.86 | Blue               | P24                    | 7                     | 24                 | 1 1/8                   | 50             |
| LCBX6-38-L   |                     |                   |                     | 3/8                  | 0.62                    | 1.07 | 0.06 | 2.08 | Blue               | P24                    | 7                     | 24                 | 1 1/8                   | 50             |
| LCBX4-14-L   | #4 AWG              | #5, #4, #3 AWG    | #4 AWG              | 1/4                  | 0.55                    | 1.05 | 0.09 | 1.87 | Gray               | P29                    | 8                     | 29                 | 1 1/8                   | 50             |
| LCBX4-38-L   |                     |                   |                     | 3/8                  | 0.62                    | 1.05 | 0.07 | 2.09 | Gray               | P29                    | 8                     | 29                 | 1 1/8                   | 50             |
| LCBX2-14-E*  | #2 AWG              | #2 AWG            | #2 AWG              | 1/4                  | 0.70                    | 1.36 | 0.11 | 2.26 | Brown              | P33                    | 10                    | 33                 | 1 7/16                  | 20             |
| LCBX2-38-E*  |                     |                   |                     | 3/8                  | 0.70                    | 1.36 | 0.11 | 2.46 | Brown              | P33                    | 10                    | 33                 | 1 7/16                  | 20             |
| LCBX2-12-E*  |                     |                   |                     | 1/2                  | 0.75                    | 1.36 | 0.09 | 2.70 | Brown              | P33                    | 10                    | 33                 | 1 7/16                  | 20             |
| LCBX1-14-X   | #1 AWG              | #1 AWG            | #1 AWG              | 1/4                  | 0.76                    | 1.44 | 0.12 | 2.44 | Green              | P37                    | 11                    | 37                 | 1 1/2                   | 10             |
| LCBX1-56-X   |                     |                   |                     | 5/16                 | 0.76                    | 1.44 | 0.12 | 2.50 | Green              | P37                    | 11                    | 37                 | 1 1/2                   | 10             |
| LCBX1-38-X   |                     |                   |                     | 3/8                  | 0.76                    | 1.44 | 0.12 | 2.57 | Green              | P37                    | 11                    | 37                 | 1 1/2                   | 10             |
| LCBX1/0-14-X | 1/0 AWG             | 1/0 AWG           | 1/0 AWG             | 1/4                  | 0.85                    | 1.50 | 0.13 | 2.61 | Pink               | P42                    | 12                    | 42                 | 1 9/16                  | 10             |
| LCBX1/0-38-X |                     |                   |                     | 3/8                  | 0.85                    | 1.50 | 0.13 | 2.67 | Pink               | P42                    | 12                    | 42                 | 1 9/16                  | 10             |
| LCBX1/0-12-X |                     |                   |                     | 1/2                  | 0.85                    | 1.50 | 0.13 | 2.92 | Pink               | P42                    | 12                    | 42                 | 1 9/16                  | 10             |
| LCBX2/0-14-X | 2/0 AWG             | 2/0 AWG           | 2/0 AWG             | 1/4                  | 0.96                    | 1.50 | 0.13 | 2.64 | Black              | P45                    | 13                    | 45                 | 1 9/16                  | 10             |
| LCBX2/0-38-X |                     |                   |                     | 3/8                  | 0.96                    | 1.50 | 0.13 | 2.70 | Black              | P45                    | 13                    | 45                 | 1 9/16                  | 10             |
| LCBX2/0-12-X |                     |                   |                     | 1/2                  | 0.96                    | 1.50 | 0.13 | 2.96 | Black              | P45                    | 13                    | 45                 | 1 9/16                  | 10             |
| LCBX3/0-38-X | 3/0 AWG             | 3/0 AWG           | 3/0 AWG             | 3/8                  | 1.06                    | 1.56 | 0.14 | 2.81 | Orange             | P50                    | 14                    | 50                 | 1 5/8                   | 10             |
| LCBX4/0-38-X | 4/0 AWG             | 4/0 AWG           | 4/0 AWG             | 3/8                  | 1.19                    | 2.24 | 0.16 | 3.74 | Purple             | P54                    | 15                    | 54                 | 2 5/16                  | 10             |
| LCBX4/0-12-X |                     |                   |                     | 1/2                  | 1.19                    | 2.24 | 0.16 | 3.85 | Purple             | P54                    | 15                    | 54                 | 2 5/16                  | 10             |
| LCBX250-38-X | 250 kcmil           | 262.6 kcmil       | —                   | 3/8                  | 1.28                    | 2.24 | 0.17 | 3.78 | Yellow             | P62                    | 16                    | 62                 | 2 5/16                  | 10             |
| LCBX250-12-X |                     |                   | —                   | 1/2                  | 1.28                    | 2.24 | 0.17 | 3.89 | Yellow             | P62                    | 16                    | 62                 | 2 5/16                  | 10             |
| LCBX250-58-X |                     |                   | —                   | 5/8                  | 1.28                    | 2.24 | 0.17 | 4.10 | Yellow             | P62                    | 16                    | 62                 | 2 5/16                  | 10             |
| LCBX300-38-6 | 300 kcmil           | 313.1 kcmil       | —                   | 3/8                  | 1.39                    | 2.30 | 0.18 | 4.02 | Red                | P71                    | 18                    | 71H                | 2 3/8                   | 6              |
| LCBX350-38-6 | 350 kcmil           | 373.7 kcmil       | —                   | 3/8                  | 1.54                    | 2.50 | 0.22 | 4.14 | Blue               | P76                    | 19                    | 76H                | 2 9/16                  | 6              |
| LCBX350-12-6 |                     |                   | —                   | 1/2                  | 1.54                    | 2.50 | 0.22 | 4.30 | Blue               | P76                    | 19                    | 76H                | 2 9/16                  | 6              |
| LCBX450-38-6 | 450 kcmil           | 444.4 kcmil       | —                   | 3/8                  | 1.70                    | 2.69 | 0.26 | 5.14 | Brown              | P87                    | 20                    | 87H                | 2 3/4                   | 6              |
| LCBX500-38-6 | 500 kcmil           | 535.3 kcmil       | —                   | 3/8                  | 1.89                    | 2.88 | 0.26 | 4.84 | Pink               | P99                    | L99                   | 99H                | 2 15/16                 | 6              |
| LCBX500-12-6 |                     |                   | —                   | 1/2                  | 1.89                    | 2.88 | 0.26 | 5.03 | Pink               | P99                    | L99                   | 99H                | 2 15/16                 | 6              |

‡See pages D3.70 – D3.73 for tool and die information.

\*Not UL Listed or CSA Certified with Class K flex conductor when crimped with Burdny tools.

\*\*Consult cable manufacturer for voltage stress relief instructions with applications greater than 2000 V.

A. System Overview

B1. Cable Ties

B2. Cable Accessories

B3. Stainless Steel Ties

C1. Wiring Duct

C2. Surface Raceway

C3. Abrasion Protection

C4. Cable Management

D1. Terminals

D2. Power Connectors

D3. Grounding Connectors

E1. Labeling Systems

E2. Labels

E3. Pre-Printed & Write-On Markers

E4. Permanent Identification

E5. Lockout/Tagout & Safety Solutions

F. Index

A. System Overview



## Flex Conductor, One-Hole, Long Barrel with Window Lug, 45° Angle

B1. Cable Ties

**For Use with Flexible, Extra-Flexible, and Code Stranded Copper Conductors**

### Type LCBX-H

B2. Cable Accessories

- Can be used with code conductor and flex conductor class: G, H, I, K, M and Diesel Locomotive
- Long barrel maximizes number of crimps and provides premium wire pull-out strength and electrical performance
- Generously beveled wire entry prevents bent back strands when inserting conductor into barrel
- Color-coded barrels marked with Panduit and specified competitor die index numbers for proper crimp die selection
- Inspection window to visually assure full conductor insertion
- Tin-plated to inhibit corrosion
- UL Listed and CSA Certified to 35 KV\*\* and temperature rated to 90°C when crimped with Panduit and specified competitor crimping tools and dies
- Meets J-STD-607-A and TIA-942 requirements for network systems grounding applications

C1. Wiring Duct

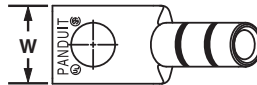

C2. Surface Raceway

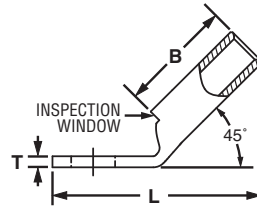

C3. Abrasion Protection

C4. Cable Management

D1. Terminals

D2. Power Connectors

D3. Grounding Connectors

E1. Labeling Systems

E2. Labels

E3. Pre-Printed & Write-On Markers

E4. Permanent Identification

E5. Lockout/Tagout & Safety Solutions

F. Index

| Part Number          | Flex Conductor Size |                   | Code Conductor Size | Stud Hole Size (In.) | Figure Dimensions (In.) |      |      |      | Panduit Color Code | Panduit Die Index No.† | Burdny Die Index No.‡ | T&B Die Index No.‡ | Wire Strip Length (In.) | Std. Pkg. Qty. |
|----------------------|---------------------|-------------------|---------------------|----------------------|-------------------------|------|------|------|--------------------|------------------------|-----------------------|--------------------|-------------------------|----------------|
|                      | Class G, H, I, K, M | Diesel Locomotive |                     |                      | W                       | B    | T    | L    |                    |                        |                       |                    |                         |                |
| <b>LCBX8-10H-L</b>   |                     |                   |                     | #10                  | 0.41                    | 0.70 | 0.08 | 1.20 | Red                | P21                    | 49                    | 21                 | 3/4                     | 50             |
| <b>LCBX8-14H-L</b>   | #8 AWG              | #8 AWG            | #8 AWG              | 1/4                  | 0.48                    | 0.70 | 0.07 | 1.28 | Red                | P21                    | 49                    | 21                 | 3/4                     | 50             |
| <b>LCBX8-38H-L</b>   |                     |                   |                     | 3/8                  | 0.60                    | 0.70 | 0.05 | 1.49 | Red                | P21                    | 49                    | 21                 | 3/4                     | 50             |
| <b>LCBX6-14H-L</b>   | #6 AWG              | #6 AWG            | #6 AWG              | 1/4                  | 0.48                    | 1.07 | 0.08 | 1.56 | Blue               | P24                    | 7                     | 24                 | 1 1/8                   | 50             |
| <b>LCBX6-38H-L</b>   |                     |                   |                     | 3/8                  | 0.62                    | 1.07 | 0.06 | 1.77 | Blue               | P24                    | 7                     | 24                 | 1 1/8                   | 50             |
| <b>LCBX4-14H-L</b>   | #4 AWG              | #5, #4, #3 AWG    | #4 AWG              | 1/4                  | 0.55                    | 1.05 | 0.09 | 1.57 | Gray               | P29                    | 8                     | 29                 | 1 1/8                   | 50             |
| <b>LCBX4-38H-L</b>   |                     |                   |                     | 3/8                  | 0.62                    | 1.05 | 0.07 | 1.78 | Gray               | P29                    | 8                     | 29                 | 1 1/8                   | 50             |
| <b>LCBX2-14H-E*</b>  |                     |                   |                     | 1/4                  | 0.70                    | 1.36 | 0.11 | 1.83 | Brown              | P33                    | 10                    | 33                 | 1 7/16                  | 20             |
| <b>LCBX2-38H-E*</b>  | #2 AWG              | #2 AWG            | #2 AWG              | 3/8                  | 0.70                    | 1.36 | 0.11 | 2.03 | Brown              | P33                    | 10                    | 33                 | 1 7/16                  | 20             |
| <b>LCBX2-12H-E*</b>  |                     |                   |                     | 1/2                  | 0.75                    | 1.36 | 0.09 | 2.26 | Brown              | P33                    | 10                    | 33                 | 1 7/16                  | 20             |
| <b>LCBX1-14H-X</b>   |                     |                   |                     | 1/4                  | 0.76                    | 1.44 | 0.12 | 1.98 | Green              | P37                    | 11                    | 37                 | 1 1/2                   | 10             |
| <b>LCBX1-56H-X</b>   | #1 AWG              | #1 AWG            | #1 AWG              | 5/16                 | 0.76                    | 1.44 | 0.12 | 2.04 | Green              | P37                    | 11                    | 37                 | 1 1/2                   | 10             |
| <b>LCBX1-38H-X</b>   |                     |                   |                     | 3/8                  | 0.76                    | 1.44 | 0.12 | 2.11 | Green              | P37                    | 11                    | 37                 | 1 1/2                   | 10             |
| <b>LCBX1/0-14H-X</b> |                     |                   |                     | 1/4                  | 0.85                    | 1.50 | 0.13 | 2.13 | Pink               | P42                    | 12                    | 42                 | 1 9/16                  | 10             |
| <b>LCBX1/0-38H-X</b> | 1/0 AWG             | 1/0 AWG           | 1/0 AWG             | 3/8                  | 0.85                    | 1.50 | 0.13 | 2.20 | Pink               | P42                    | 12                    | 42                 | 1 9/16                  | 10             |
| <b>LCBX1/0-12H-X</b> |                     |                   |                     | 1/2                  | 0.85                    | 1.50 | 0.13 | 2.45 | Pink               | P42                    | 12                    | 42                 | 1 9/16                  | 10             |
| <b>LCBX2/0-14H-X</b> |                     |                   |                     | 1/4                  | 0.96                    | 1.50 | 0.13 | 2.16 | Black              | P45                    | 13                    | 45                 | 1 9/16                  | 10             |
| <b>LCBX2/0-38H-X</b> | 2/0 AWG             | 2/0 AWG           | 2/0 AWG             | 3/8                  | 0.96                    | 1.50 | 0.13 | 2.22 | Black              | P45                    | 13                    | 45                 | 1 9/16                  | 10             |
| <b>LCBX2/0-12H-X</b> |                     |                   |                     | 1/2                  | 0.96                    | 1.50 | 0.13 | 2.47 | Black              | P45                    | 13                    | 45                 | 1 9/16                  | 10             |
| <b>LCBX3/0-38H-X</b> | 3/0 AWG             | 3/0 AWG           | 3/0 AWG             | 3/8                  | 1.06                    | 1.56 | 0.14 | 2.31 | Orange             | P50                    | 14                    | 50                 | 1 5/8                   | 10             |
| <b>LCBX4/0-38H-X</b> |                     |                   |                     | 3/8                  | 1.19                    | 2.24 | 0.16 | 3.12 | Purple             | P54                    | 15                    | 54                 | 2 5/16                  | 10             |
| <b>LCBX4/0-12H-X</b> | 4/0 AWG             | 4/0 AWG           | 4/0 AWG             | 1/2                  | 1.19                    | 2.24 | 0.16 | 3.23 | Purple             | P54                    | 15                    | 54                 | 2 5/16                  | 10             |
| <b>LCBX250-38H-X</b> | 250 kcmil           | 262.6 kcmil       | —                   | 3/8                  | 1.28                    | 2.24 | 0.17 | 3.15 | Yellow             | P62                    | 16                    | 62                 | 2 5/16                  | 10             |
| <b>LCBX300-38H-6</b> | 300 kcmil           | 313.1 kcmil       | —                   | 3/8                  | 1.39                    | 2.30 | 0.18 | 3.42 | Red                | P71                    | 18                    | 71H                | 2 3/8                   | 6              |
| <b>LCBX300-12H-6</b> |                     |                   |                     | 1/2                  | 1.39                    | 2.30 | 0.18 | 3.69 | Red                | P71                    | 18                    | 71H                | 2 3/8                   | 6              |
| <b>LCBX350-38H-6</b> | 350 kcmil           | 373.7 kcmil       | —                   | 3/8                  | 1.54                    | 2.50 | 0.22 | 3.48 | Blue               | P76                    | 19                    | 76H                | 2 9/16                  | 6              |
| <b>LCBX350-12H-6</b> |                     |                   |                     | 1/2                  | 1.54                    | 2.50 | 0.22 | 3.64 | Blue               | P76                    | 19                    | 76H                | 2 9/16                  | 6              |
| <b>LCBX450-38H-6</b> | 450 kcmil           | 444.4 kcmil       | —                   | 3/8                  | 1.70                    | 2.69 | 0.26 | 4.42 | Brown              | P87                    | 20                    | 87H                | 2 3/4                   | 6              |
| <b>LCBX500-38H-6</b> | 500 kcmil           | 535.3 kcmil       | —                   | 3/8                  | 1.89                    | 2.88 | 0.26 | 4.08 | Pink               | P99                    | L99                   | 99H                | 2 15/16                 | 6              |
| <b>LCBX500-12H-6</b> |                     |                   |                     | 1/2                  | 1.89                    | 2.88 | 0.26 | 4.27 | Pink               | P99                    | L99                   | 99H                | 2 15/16                 | 6              |

†See pages D3.70 – D3.73 for tool and die information.

\*Not UL Listed or CSA Certified with Class K flex conductor when crimped with Burndy tools.

\*\*Consult cable manufacturer for voltage stress relief instructions with applications greater than 2000 V.



## Flex Conductor, One-Hole, Long Barrel with Window Lug, 90° Angle

For Use with Flexible, Extra-Flexible, and Code Stranded Copper Conductors

### Type LCBX-F

- Can be used with code conductor and flex conductor class: G, H, I, K, M and Diesel Locomotive
- Long barrel maximizes number of crimps and provides premium wire pull-out strength and electrical performance
- Generously beveled wire entry prevents bent back strands when inserting conductor into barrel
- Color-coded barrels marked with Panduit and specified competitor die index numbers for proper crimp die selection
- Inspection window to visually assure full conductor insertion
- Tin-plated to inhibit corrosion
- UL Listed and CSA Certified to 35 KV\*\* and temperature rated to 90°C when crimped with Panduit and specified competitor crimping tools and dies
- Meets J-STD-607-A and TIA-942 requirements for network systems grounding applications

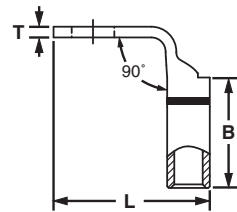
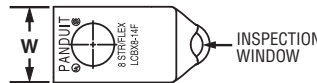

| Part Number   | Flex Conductor Size |                   | Code Conductor Size | Stud Hole Size (In.) | Figure Dimensions (In.) |      |      |      | Panduit Color Code | Panduit Die Index No.‡ | Burndy Die Index No.‡ | T&B Die Index No.‡ | Wire Strip Length (In.) | Std. Pkg. Qty. |
|---------------|---------------------|-------------------|---------------------|----------------------|-------------------------|------|------|------|--------------------|------------------------|-----------------------|--------------------|-------------------------|----------------|
|               | Class G, H, I, K, M | Diesel Locomotive |                     |                      | W                       | B    | T    | L    |                    |                        |                       |                    |                         |                |
| LCBX8-10F-L   |                     |                   |                     | #10                  | 0.41                    | 0.70 | 0.08 | 0.90 | Red                | P21                    | 49                    | 21                 | 3/4                     | 50             |
| LCBX8-14F-L   | #8 AWG              | #8 AWG            | #8 AWG              | 1/4                  | 0.48                    | 0.70 | 0.07 | 0.99 | Red                | P21                    | 49                    | 21                 | 3/4                     | 50             |
| LCBX8-38F-L   |                     |                   |                     | 3/8                  | 0.60                    | 0.70 | 0.05 | 1.21 | Red                | P21                    | 49                    | 21                 | 3/4                     | 50             |
| LCBX6-14F-L   | #6 AWG              | #6 AWG            | #6 AWG              | 1/4                  | 0.48                    | 1.07 | 0.08 | 1.03 | Blue               | P24                    | 7                     | 24                 | 1 1/8                   | 50             |
| LCBX6-38F-L   |                     |                   |                     | 3/8                  | 0.62                    | 1.07 | 0.06 | 1.25 | Blue               | P24                    | 7                     | 24                 | 1 1/8                   | 50             |
| LCBX4-14F-L   | #4 AWG              | #5, #4, #3 AWG    | #4 AWG              | 1/4                  | 0.55                    | 1.05 | 0.09 | 1.12 | Gray               | P29                    | 8                     | 29                 | 1 1/8                   | 50             |
| LCBX4-38F-L   |                     |                   |                     | 3/8                  | 0.62                    | 1.05 | 0.07 | 1.34 | Gray               | P29                    | 8                     | 29                 | 1 1/8                   | 50             |
| LCBX2-14F-E*  | #2 AWG              | #2 AWG            | #2 AWG              | 1/4                  | 0.70                    | 1.36 | 0.11 | 1.31 | Brown              | P33                    | 10                    | 33                 | 1 7/16                  | 20             |
| LCBX2-38F-E*  |                     |                   |                     | 3/8                  | 0.70                    | 1.36 | 0.11 | 1.51 | Brown              | P33                    | 10                    | 33                 | 1 7/16                  | 20             |
| LCBX2-12F-E*  |                     |                   |                     | 1/2                  | 0.75                    | 1.36 | 0.09 | 1.75 | Brown              | P33                    | 10                    | 33                 | 1 7/16                  | 20             |
| LCBX1-14F-X   | #1 AWG              | #1 AWG            | #1 AWG              | 1/4                  | 0.76                    | 1.44 | 0.12 | 1.45 | Green              | P37                    | 11                    | 37                 | 1 1/2                   | 10             |
| LCBX1-56F-X   |                     |                   |                     | 5/16                 | 0.76                    | 1.44 | 0.12 | 1.51 | Green              | P37                    | 11                    | 37                 | 1 1/2                   | 10             |
| LCBX1-38F-X   |                     |                   |                     | 3/8                  | 0.76                    | 1.44 | 0.12 | 1.58 | Green              | P37                    | 11                    | 37                 | 1 1/2                   | 10             |
| LCBX1/0-14F-X | 1/0 AWG             | 1/0 AWG           | 1/0 AWG             | 1/4                  | 0.85                    | 1.50 | 0.13 | 1.61 | Pink               | P42                    | 12                    | 42                 | 1 9/16                  | 10             |
| LCBX1/0-38F-X |                     |                   |                     | 3/8                  | 0.85                    | 1.50 | 0.13 | 1.66 | Pink               | P42                    | 12                    | 42                 | 1 9/16                  | 10             |
| LCBX1/0-12F-X |                     |                   |                     | 1/2                  | 0.85                    | 1.50 | 0.13 | 1.91 | Pink               | P42                    | 12                    | 42                 | 1 9/16                  | 10             |
| LCBX2/0-14F-X | 2/0 AWG             | 2/0 AWG           | 2/0 AWG             | 1/4                  | 0.96                    | 1.50 | 0.13 | 1.67 | Black              | P45                    | 13                    | 45                 | 1 9/16                  | 10             |
| LCBX2/0-38F-X |                     |                   |                     | 3/8                  | 0.96                    | 1.50 | 0.13 | 1.73 | Black              | P45                    | 13                    | 45                 | 1 9/16                  | 10             |
| LCBX2/0-12F-X |                     |                   |                     | 1/2                  | 0.96                    | 1.50 | 0.13 | 1.98 | Black              | P45                    | 13                    | 45                 | 1 9/16                  | 10             |
| LCBX3/0-38F-X | 3/0 AWG             | 3/0 AWG           | 3/0 AWG             | 3/8                  | 1.06                    | 1.56 | 0.14 | 1.84 | Orange             | P50                    | 14                    | 50                 | 1 5/8                   | 10             |
| LCBX4/0-38F-X | 4/0 AWG             | 4/0 AWG           | 4/0 AWG             | 3/8                  | 1.19                    | 2.24 | 0.16 | 2.07 | Purple             | P54                    | 15                    | 54                 | 2 5/16                  | 10             |
| LCBX4/0-12F-X |                     |                   |                     | 1/2                  | 1.19                    | 2.24 | 0.16 | 2.18 | Purple             | P54                    | 15                    | 54                 | 2 5/16                  | 10             |
| LCBX250-38F-X | 250 kcmil           | 262.6 kcmil       | —                   | 3/8                  | 1.28                    | 2.24 | 0.17 | 2.13 | Yellow             | P62                    | 16                    | 62                 | 2 5/16                  | 10             |
| LCBX300-38F-6 | 300 kcmil           | 313.1 kcmil       | —                   | 3/8                  | 1.39                    | 2.30 | 0.18 | 2.37 | Red                | P71                    | 18                    | 71H                | 2 3/8                   | 6              |
| LCBX300-12F-6 |                     |                   |                     | 1/2                  | 1.39                    | 2.30 | 0.18 | 2.37 | Red                | P71                    | 18                    | 71H                | 2 3/8                   | 6              |
| LCBX350-38F-6 | 350 kcmil           | 373.7 kcmil       | —                   | 3/8                  | 1.54                    | 2.50 | 0.22 | 2.32 | Blue               | P76                    | 19                    | 76H                | 2 9/16                  | 6              |
| LCBX350-12F-6 |                     |                   |                     | 1/2                  | 1.54                    | 2.50 | 0.22 | 2.48 | Blue               | P76                    | 19                    | 76H                | 2 9/16                  | 6              |
| LCBX450-38F-6 | 450 kcmil           | 444.4 kcmil       | —                   | 3/8                  | 1.70                    | 2.69 | 0.26 | 3.14 | Brown              | P87                    | 20                    | 87H                | 2 3/4                   | 6              |
| LCBX500-38F-6 | 500 kcmil           | 535.3 kcmil       | —                   | 3/8                  | 1.89                    | 2.88 | 0.26 | 2.62 | Pink               | P99                    | L99                   | 99H                | 2 15/16                 | 6              |
| LCBX500-12F-6 |                     |                   |                     | 1/2                  | 1.89                    | 2.88 | 0.26 | 2.81 | Pink               | P99                    | L99                   | 99H                | 2 15/16                 | 6              |

‡See pages D3.70 – D3.73 for tool and die information.

\*Not UL Listed or CSA Certified with Class K flex conductor when crimped with Burndy tools.

\*\*Consult cable manufacturer for voltage stress relief instructions with applications greater than 2000 V.

A. System Overview

B1. Cable Ties

B2. Cable Accessories

B3. Stainless Steel Ties

C1. Wiring Duct

C2. Surface Raceway

C3. Abrasion Protection

C4. Cable Management

D1. Terminals

D2. Power Connectors

D3. Grounding Connectors

E1. Labeling Systems

E2. Labels

E3. Pre-Printed & Write-On Markers

E4. Permanent Identification

E5. Lockout/Tagout & Safety Solutions

F. Index

A. System Overview



## Flex Conductor, Two-Hole, Standard Barrel with Window Lug

B1. Cable Ties

**For Use with Flexible, Extra-Flexible, and Code Stranded Copper Conductors**

### Type LCDX

B2. Cable Accessories

- Can be used with code conductor and flex conductor class: G, H, I, K, M and Diesel Locomotive
- Generously beveled wire entry prevents bent back strands when inserting conductor into barrel
- Color-coded barrels marked with Panduit and specified competitor die index numbers for proper crimp die selection
- Inspection window to visually assure full conductor insertion
- Tin-plated to inhibit corrosion
- UL Listed and CSA Certified to 35 KV\*\* and temperature rated to 90°C when crimped with Panduit and specified competitor crimping tools and dies
- American Bureau of Shipping approved
- Available with NEMA hole sizes and spacing

B3. Stainless Steel Ties

C1. Wiring Duct



C2. Surface Raceway

C3. Abrasion Protection

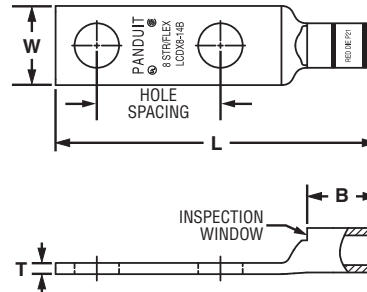

C4. Cable Management

| Part Number  | Flex Conductor Size |                   | Code Conductor Size | Stud Hole Size (In.) | Stud Hole Spacing (In.) | Figure Dimensions (In.) |       |     |      | Panduit Color Code | Panduit Die Index No.‡ | Burndy Die Index No.‡ | T&B Die Index No.‡ | Wire Strip Length (In.) | Std. Pkg. Qty. |
|--------------|---------------------|-------------------|---------------------|----------------------|-------------------------|-------------------------|-------|-----|------|--------------------|------------------------|-----------------------|--------------------|-------------------------|----------------|
|              | Class G, H, I, K, M | Diesel Locomotive |                     |                      |                         | W                       | B     | T   | L    |                    |                        |                       |                    |                         |                |
| LCDX8-10A-L  | #8 AWG              | #8 AWG            | #8 AWG              | #10                  | .63                     | .41                     | .42   | .08 | 1.74 | Red                | P21                    | 49                    | 21                 | 1/2                     | 50             |
| LCDX8-14A-L  |                     |                   |                     | 1/4                  | .63                     | .48                     | .42   | .07 | 1.83 | Red                | P21                    | 49                    | 21                 | 1/2                     | 50             |
| LCDX8-14B-L  |                     |                   |                     | 1/4                  | .75                     | .48                     | .42   | .07 | 1.95 | Red                | P21                    | 49                    | 21                 | 1/2                     | 50             |
| LCDX8-14D-L  |                     |                   |                     | 1/4                  | 1.00                    | .48                     | .42   | .07 | 2.20 | Red                | P21                    | 49                    | 21                 | 1/2                     | 50             |
| LCDX8-38D-L  |                     |                   |                     | 3/8                  | 1.00                    | .60                     | .42   | .05 | 2.42 | Red                | P21                    | 49                    | 21                 | 1/2                     | 50             |
| LCDX6-10A-L  | #6 AWG              | #6 AWG            | #6 AWG              | #10                  | .63                     | .46                     | .48   | .08 | 1.82 | Blue               | P24                    | 7                     | 24                 | 9/16                    | 50             |
| LCDX6-10B-L  |                     |                   |                     | #10                  | .75                     | .46                     | .48   | .08 | 1.94 | Blue               | P24                    | 7                     | 24                 | 9/16                    | 50             |
| LCDX6-10G-L  |                     |                   |                     | #10                  | 1.50                    | .46                     | .48   | .08 | 2.69 | Blue               | P24                    | 7                     | 24                 | 9/16                    | 50             |
| LCDX6-10P-L  |                     |                   |                     | #10                  | .69                     | .46                     | .48   | .08 | 1.88 | Blue               | P24                    | 7                     | 24                 | 9/16                    | 50             |
| LCDX6-14A-L  |                     |                   |                     | 1/4                  | .63                     | .48                     | .48   | .08 | 1.91 | Blue               | P24                    | 7                     | 24                 | 9/16                    | 50             |
| LCDX6-14B-L  | 1/4                 | .75               | .48                 | .48                  | .08                     | 2.03                    | Blue  | P24 | 7    | 24                 | 9/16                   | 50                    |                    |                         |                |
| LCDX6-14D-L  | 1/4                 | 1.00              | .48                 | .48                  | .08                     | 2.28                    | Blue  | P24 | 7    | 24                 | 9/16                   | 50                    |                    |                         |                |
| LCDX6-56D-L  | 5/16                | 1.00              | .56                 | .48                  | .07                     | 2.40                    | Blue  | P24 | 7    | 24                 | 9/16                   | 50                    |                    |                         |                |
| LCDX6-38D-L  | 3/8                 | 1.00              | .62                 | .48                  | .06                     | 2.50                    | Blue  | P24 | 7    | 24                 | 9/16                   | 50                    |                    |                         |                |
| LCDX4-14A-L  | #4 AWG              | #5, #4, #3 AWG    | #4 AWG              | 1/4                  | .63                     | .55                     | .53   | .09 | 1.98 | Gray               | P29                    | 8                     | 29                 | 5/8                     | 50             |
| LCDX4-14B-L  |                     |                   |                     | 1/4                  | .75                     | .55                     | .53   | .09 | 2.10 | Gray               | P29                    | 8                     | 29                 | 5/8                     | 50             |
| LCDX4-14D-L  |                     |                   |                     | 1/4                  | 1.00                    | .55                     | .53   | .09 | 2.35 | Gray               | P29                    | 8                     | 29                 | 5/8                     | 50             |
| LCDX4-56D-L  |                     |                   |                     | 5/16                 | 1.00                    | .55                     | .53   | .09 | 2.47 | Gray               | P29                    | 8                     | 29                 | 5/8                     | 50             |
| LCDX4-38D-L  |                     |                   |                     | 3/8                  | 1.00                    | .62                     | .53   | .08 | 2.57 | Gray               | P29                    | 8                     | 29                 | 5/8                     | 50             |
| LCDX2-14A-E* | #2 AWG              | #2 AWG            | #2 AWG              | 1/4                  | .63                     | .70                     | .59   | .11 | 2.13 | Brown              | P33                    | 10                    | 33                 | 11/16                   | 20             |
| LCDX2-14B-E* |                     |                   |                     | 1/4                  | .75                     | .70                     | .59   | .11 | 2.25 | Brown              | P33                    | 10                    | 33                 | 11/16                   | 20             |
| LCDX2-14D-E* |                     |                   |                     | 1/4                  | 1.00                    | .70                     | .59   | .11 | 2.50 | Brown              | P33                    | 10                    | 33                 | 11/16                   | 20             |
| LCDX2-56D-E* |                     |                   |                     | 5/16                 | 1.00                    | .70                     | .59   | .11 | 2.63 | Brown              | P33                    | 10                    | 33                 | 11/16                   | 20             |
| LCDX2-38D-E* |                     |                   |                     | 3/8                  | 1.00                    | .70                     | .59   | .11 | 2.70 | Brown              | P33                    | 10                    | 33                 | 11/16                   | 20             |
| LCDX2-12-E*  | 1/2                 | 1.75              | .75                 | .59                  | .09                     | 3.87                    | Brown | P33 | 10   | 33                 | 11/16                  | 20                    |                    |                         |                |
| LCDX1-14A-X  | #1 AWG              | #1 AWG            | #1 AWG              | 1/4                  | .63                     | .76                     | .66   | .12 | 2.29 | Green              | P37                    | 11                    | 37                 | 3/4                     | 10             |
| LCDX1-14B-X  |                     |                   |                     | 1/4                  | .75                     | .76                     | .66   | .12 | 2.42 | Green              | P37                    | 11                    | 37                 | 3/4                     | 10             |
| LCDX1-14D-X  |                     |                   |                     | 1/4                  | 1.00                    | .76                     | .66   | .12 | 2.67 | Green              | P37                    | 11                    | 37                 | 3/4                     | 10             |
| LCDX1-56D-X  |                     |                   |                     | 5/16                 | 1.00                    | .76                     | .66   | .12 | 2.72 | Green              | P37                    | 11                    | 37                 | 3/4                     | 10             |
| LCDX1-38D-X  |                     |                   |                     | 3/8                  | 1.00                    | .76                     | .66   | .12 | 2.80 | Green              | P37                    | 11                    | 37                 | 3/4                     | 10             |
| LCDX1-12-X   | 1/2                 | 1.75              | .80                 | .66                  | .12                     | 3.97                    | Green | P37 | 11   | 37                 | 3/4                    | 10                    |                    |                         |                |

‡See pages D3.70 – D3.73 for tool and die information.

\*Not UL Listed or CSA Certified with Class K flex conductor when crimped with Burndy tools.

\*\*Consult cable manufacturer for voltage stress relief instructions with applications greater than 2000 V.

◆NEMA hole sizes and spacing.



## Flex Conductor, Two-Hole, Standard Barrel with Window Lug (continued)

| Part Number   | Flex Conductor Size |                   | Code Conductor Size | Stud Hole Size (In.) | Stud Hole Spacing (In.) | Figure Dimensions (In.) |        |      |      | Panduit Color Code | Panduit Die Index No.‡ | Burndy Die Index No.‡ | T&B Die Index No.‡ | Wire Strip Length (In.) | Std. Pkg. Qty. |
|---------------|---------------------|-------------------|---------------------|----------------------|-------------------------|-------------------------|--------|------|------|--------------------|------------------------|-----------------------|--------------------|-------------------------|----------------|
|               | Class G, H, I, K, M | Diesel Locomotive |                     |                      |                         | W                       | B      | T    | L    |                    |                        |                       |                    |                         |                |
| LCDX1/0-14A-X | 1/0 AWG             | 1/0 AWG           | 1/0 AWG             | 1/4                  | .63                     | .85                     | .72    | .13  | 2.45 | Pink               | P42                    | 12                    | 42                 | 3/4                     | 10             |
| LCDX1/0-14B-X |                     |                   |                     | 1/4                  | .75                     | .85                     | .72    | .13  | 2.57 | Pink               | P42                    | 12                    | 42                 | 3/4                     | 10             |
| LCDX1/0-56B-X |                     |                   |                     | 5/16                 | .75                     | .85                     | .72    | .13  | 2.57 | Pink               | P42                    | 12                    | 42                 | 3/4                     | 10             |
| LCDX1/0-56D-X |                     |                   |                     | 5/16                 | 1.00                    | .85                     | .72    | .13  | 2.82 | Pink               | P42                    | 12                    | 42                 | 3/4                     | 10             |
| LCDX1/0-38D-X |                     |                   |                     | 3/8                  | 1.00                    | .85                     | .72    | .13  | 2.89 | Pink               | P42                    | 12                    | 42                 | 3/4                     | 10             |
| LCDX1/0-12D-X |                     |                   |                     | 1/2                  | 1.00                    | .85                     | .72    | .13  | 3.14 | Pink               | P42                    | 12                    | 42                 | 3/4                     | 10             |
| LCDX1/0-12-X  |                     |                   |                     | 1/2                  | 1.75                    | .85                     | .72    | .13  | 4.05 | Pink               | P42                    | 12                    | 42                 | 3/4                     | 10             |
| LCDX2/0-14A-X | 2/0 AWG             | 2/0 AWG           | 2/0 AWG             | 1/4                  | .63                     | .96                     | .83    | .13  | 2.59 | Black              | P45                    | 13                    | 45                 | 7/8                     | 10             |
| LCDX2/0-14B-X |                     |                   |                     | 1/4                  | .75                     | .96                     | .83    | .13  | 2.72 | Black              | P45                    | 13                    | 45                 | 7/8                     | 10             |
| LCDX2/0-56D-X |                     |                   |                     | 5/16                 | 1.00                    | .96                     | .83    | .13  | 2.97 | Black              | P45                    | 13                    | 45                 | 7/8                     | 10             |
| LCDX2/0-38D-X |                     |                   |                     | 3/8                  | 1.00                    | .96                     | .83    | .13  | 3.03 | Black              | P45                    | 13                    | 45                 | 7/8                     | 10             |
| LCDX2/0-12D-X |                     |                   |                     | 1/2                  | 1.00                    | .96                     | .83    | .13  | 3.28 | Black              | P45                    | 13                    | 45                 | 7/8                     | 10             |
| LCDX2/0-12-X  | 1/2                 | 1.75              | .96                 | .83                  | .13                     | 4.19                    | Black  | P45  | 13   | 45                 | 7/8                    | 10                    |                    |                         |                |
| LCDX3/0-14A-X | 3/0 AWG             | 3/0 AWG           | 3/0 AWG             | 1/4                  | .63                     | 1.06                    | .91    | .14  | 2.71 | Orange             | P50                    | 14                    | 50                 | 1                       | 10             |
| LCDX3/0-56D-X |                     |                   |                     | 5/16                 | 1.00                    | 1.06                    | .91    | .14  | 3.10 | Orange             | P50                    | 14                    | 50                 | 1                       | 10             |
| LCDX3/0-38D-X |                     |                   |                     | 3/8                  | 1.00                    | 1.06                    | .91    | .14  | 3.17 | Orange             | P50                    | 14                    | 50                 | 1                       | 10             |
| LCDX3/0-12-X  |                     |                   |                     | 1/2                  | 1.75                    | 1.06                    | .91    | .14  | 4.31 | Orange             | P50                    | 14                    | 50                 | 1                       | 10             |
| LCDX4/0-14A-X | 4/0 AWG             | 4/0 AWG           | 4/0 AWG             | 1/4                  | .63                     | 1.19                    | 1.03   | .16  | 2.74 | Purple             | P54                    | 15                    | 54                 | 1 1/16                  | 10             |
| LCDX4/0-14B-X |                     |                   |                     | 1/4                  | .75                     | 1.19                    | 1.03   | .16  | 2.96 | Purple             | P54                    | 15                    | 54                 | 1 1/16                  | 10             |
| LCDX4/0-56D-X |                     |                   |                     | 5/16                 | 1.00                    | 1.19                    | 1.03   | .16  | 3.31 | Purple             | P54                    | 15                    | 54                 | 1 1/16                  | 10             |
| LCDX4/0-38D-X |                     |                   |                     | 3/8                  | 1.00                    | 1.19                    | 1.03   | .16  | 3.34 | Purple             | P54                    | 15                    | 54                 | 1 1/16                  | 10             |
| LCDX4/0-12D-X |                     |                   |                     | 1/2                  | 1.00                    | 1.19                    | 1.03   | .16  | 3.61 | Purple             | P54                    | 15                    | 54                 | 1 1/16                  | 10             |
| LCDX4/0-12E-X |                     |                   |                     | 1/2                  | 1.25                    | 1.19                    | 1.03   | .16  | 3.89 | Purple             | P54                    | 15                    | 54                 | 1 1/16                  | 10             |
| LCDX4/0-12-X  |                     |                   |                     | 1/2                  | 1.75                    | 1.19                    | 1.03   | .16  | 4.52 | Purple             | P54                    | 15                    | 54                 | 1 1/16                  | 10             |
| LCDX250-38D-X | 250 kcmil           | 262.6 kcmil       | —                   | 3/8                  | 1.00                    | 1.28                    | 1.03   | .17  | 3.38 | Yellow             | P62                    | 16                    | 62                 | 1 1/16                  | 10             |
| LCDX250-38-X  |                     |                   |                     | 3/8                  | 1.75                    | 1.28                    | 1.03   | .17  | 4.13 | Yellow             | P62                    | 16                    | 62                 | 1 1/16                  | 10             |
| LCDX250-12E-X |                     |                   |                     | 1/2                  | 1.25                    | 1.28                    | 1.03   | .17  | 3.93 | Yellow             | P62                    | 16                    | 62                 | 1 1/16                  | 10             |
| LCDX250-12-X  | 1/2                 | 1.75              | 1.28                | 1.03                 | .17                     | 4.56                    | Yellow | P62  | 16   | 62                 | 1 1/16                 | 10                    |                    |                         |                |
| LCDX300-38D-6 | 300 kcmil           | 313.1 kcmil       | —                   | 3/8                  | 1.00                    | 1.39                    | 1.19   | .18  | 3.56 | Red                | P71                    | 18                    | 71H                | 1 1/4                   | 6              |
| LCDX300-12-6  |                     |                   |                     | 1/2                  | 1.75                    | 1.39                    | 1.19   | .18  | 4.74 | Red                | P71                    | 18                    | 71H                | 1 1/4                   | 6              |
| LCDX350-56D-6 | 350 kcmil           | 373.7 kcmil       | —                   | 5/16                 | 1.00                    | 1.54                    | 1.29   | .22  | 3.71 | Blue               | P76                    | 19                    | 76H                | 1 3/8                   | 6              |
| LCDX350-38D-6 |                     |                   |                     | 3/8                  | 1.00                    | 1.54                    | 1.29   | .22  | 3.74 | Blue               | P76                    | 19                    | 76H                | 1 3/8                   | 6              |
| LCDX350-38-6  |                     |                   |                     | 3/8                  | 1.75                    | 1.54                    | 1.29   | .22  | 4.49 | Blue               | P76                    | 19                    | 76H                | 1 3/8                   | 6              |
| LCDX350-12E-6 |                     |                   |                     | 1/2                  | 1.25                    | 1.54                    | 1.29   | .22  | 4.29 | Blue               | P76                    | 19                    | 76H                | 1 3/8                   | 6              |
| LCDX350-12-6  |                     |                   |                     | 1/2                  | 1.75                    | 1.54                    | 1.29   | .22  | 4.92 | Blue               | P76                    | 19                    | 76H                | 1 3/8                   | 6              |
| LCDX450-38D-6 | 450 kcmil           | 444.4 kcmil       | —                   | 3/8                  | 1.00                    | 1.70                    | 1.40   | .26  | 3.90 | Brown              | P87                    | 20                    | 87H                | 1 7/16                  | 6              |
| LCDX450-12-6  |                     |                   |                     | 1/2                  | 1.75                    | 1.70                    | 1.40   | .26  | 5.08 | Brown              | P87                    | 20                    | 87H                | 1 7/16                  | 6              |
| LCDX500-56D-6 | 500 kcmil           | 535.3 kcmil       | —                   | 5/16                 | 1.00                    | 1.89                    | 1.48   | .26  | 4.05 | Pink               | P99                    | L99                   | 99H                | 1 9/16                  | 6              |
| LCDX500-38D-6 |                     |                   |                     | 3/8                  | 1.00                    | 1.89                    | 1.48   | .26  | 4.08 | Pink               | P99                    | L99                   | 99H                | 1 9/16                  | 6              |
| LCDX500-12E-6 |                     |                   |                     | 1/2                  | 1.25                    | 1.89                    | 1.48   | .26  | 4.76 | Pink               | P99                    | L99                   | 99H                | 1 9/16                  | 6              |
| LCDX500-12-6  | 1/2                 | 1.75              | 1.89                | 1.48                 | .26                     | 5.26                    | Pink   | P99  | L99  | 99H                | 1 9/16                 | 6                     |                    |                         |                |
| LCDX600-12-6  | 600 kcmil           | —                 | —                   | 1/2                  | 1.75                    | 1.89                    | 1.48   | .26  | 5.26 | Pink               | P99                    | 400                   | 99H                | 1 9/16                  | 6              |
| LCDX650-38D-6 | —                   | 646.4 kcmil       | —                   | 3/8                  | 1.00                    | 1.95                    | 1.45   | .30  | 4.08 | Black              | P106                   | 24                    | 106H               | 1 1/2                   | 6              |
| LCDX650-12-6  |                     |                   |                     | 1/2                  | 1.75                    | 1.95                    | 1.45   | .30  | 5.26 | Black              | P106                   | 24                    | 106H               | 1 1/2                   | 6              |
| LCDX750-38D-3 | —                   | 777.7 kcmil       | —                   | 3/8                  | 1.00                    | 2.17                    | 1.66   | .32  | 4.62 | Yellow             | P115                   | L115                  | 115H               | 1 3/4                   | 3              |
| LCDX750-12E-3 |                     |                   |                     | 1/2                  | 1.25                    | 2.17                    | 1.66   | .32  | 5.06 | Yellow             | P115                   | L115                  | 115H               | 1 3/4                   | 3              |
| LCDX750-12G-3 |                     |                   |                     | 1/2                  | 1.50                    | 2.17                    | 1.66   | .32  | 5.31 | Yellow             | P115                   | L115                  | 115H               | 1 3/4                   | 3              |
| LCDX750-12-3  |                     |                   |                     | 1/2                  | 1.75                    | 2.17                    | 1.66   | .32  | 5.56 | Yellow             | P115                   | L115                  | 115H               | 1 3/4                   | 3              |
| LCDX750-58G-3 | 5/8                 | 1.50              | 2.17                | 1.66                 | .32                     | 5.37                    | Yellow | P115 | L115 | 115H               | 1 3/4                  | 3                     |                    |                         |                |

‡See pages D3.70 – D3.73 for tool and die information.

\*Not UL Listed or CSA Certified with Class K flex conductor when crimped with Burndy tools.

\*\*Consult cable manufacturer for voltage stress relief instructions with applications greater than 2000 V.

◆NEMA hole sizes and spacing.

A. System Overview

B1. Cable Ties

B2. Cable Accessories

B3. Stainless Steel Ties

C1. Wiring Duct

C2. Surface Raceway

C3. Abrasion Protection

C4. Cable Management

D1. Terminals

D2. Power Connectors

D3. Grounding Connectors

E1. Labeling Systems

E2. Labels

E3. Pre-Printed & Write-On Markers

E4. Permanent Identification

E5. Lockout/Tagout & Safety Solutions

F. Index



A. System Overview



## Flex Conductor, Two-Hole, Standard Barrel with Window Lug, 45° Angle

B1. Cable Ties

**For Use with Flexible, Extra-Flexible, and Code Stranded Copper Conductors**

B2. Cable Accessories

### Type LCDX-H

- Can be used with code conductor and flex conductor class: G, H, I, K, M and Diesel Locomotive
- Generously beveled wire entry prevents bent back strands when inserting conductor into barrel
- Color-coded barrels marked with Panduit and specified competitor die index numbers for proper crimp die selection
- Inspection window to visually assure full conductor insertion
- Tin-plated to inhibit corrosion
- UL Listed and CSA Certified to 35 KV\*\* and temperature rated to 90°C when crimped with Panduit and specified competitor crimping tools and dies
- American Bureau of Shipping approved
- Available with NEMA hole sizes and spacing

B3. Stainless Steel Ties

C1. Wiring Duct



C2. Surface Raceway

C3. Abrasion Protection

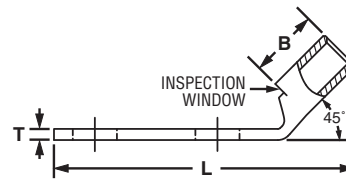
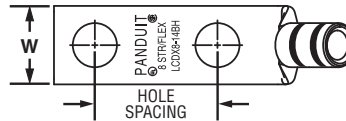

C4. Cable Management

| Part Number   | Flex Conductor Size |                   | Code Conductor Size | Stud Hole Size (In.) | Stud Hole Spacing (In.) | Figure Dimensions (In.) |     |     |      | Panduit Color Code | Panduit Die Index No.‡ | Burndy Die Index No.‡ | T&B Die Index No.‡ | Wire Strip Length (In.) | Std. Pkg. Qty. |
|---------------|---------------------|-------------------|---------------------|----------------------|-------------------------|-------------------------|-----|-----|------|--------------------|------------------------|-----------------------|--------------------|-------------------------|----------------|
|               | Class G, H, I, K, M | Diesel Locomotive |                     |                      |                         | W                       | B   | T   | L    |                    |                        |                       |                    |                         |                |
| LCDX8-10AH-L  | #8 AWG              | #8 AWG            | #8 AWG              | #10                  | .63                     | .41                     | .42 | .08 | 1.63 | Red                | P21                    | 49                    | 21                 | 1/2                     | 50             |
| LCDX8-14AH-L  |                     |                   |                     | 1/4                  | .63                     | .48                     | .42 | .07 | 1.71 | Red                | P21                    | 49                    | 21                 | 1/2                     | 50             |
| LCDX8-14BH-L  |                     |                   |                     | 1/4                  | .75                     | .48                     | .42 | .07 | 1.84 | Red                | P21                    | 49                    | 21                 | 1/2                     | 50             |
| LCDX8-14DH-L  |                     |                   |                     | 1/4                  | 1.00                    | .48                     | .42 | .07 | 2.09 | Red                | P21                    | 49                    | 21                 | 1/2                     | 50             |
| LCDX8-38DH-L  |                     |                   |                     | 3/8                  | 1.00                    | .60                     | .42 | .05 | 2.30 | Red                | P21                    | 49                    | 21                 | 1/2                     | 50             |
| LCDX6-10AH-L  | #6 AWG              | #6 AWG            | #6 AWG              | #10                  | .63                     | .46                     | .48 | .08 | 1.68 | Blue               | P24                    | 7                     | 24                 | 9/16                    | 50             |
| LCDX6-10BH-L  |                     |                   |                     | #10                  | .75                     | .46                     | .48 | .08 | 1.81 | Blue               | P24                    | 7                     | 24                 | 9/16                    | 50             |
| LCDX6-10GH-L  |                     |                   |                     | #10                  | 1.50                    | .46                     | .48 | .08 | 2.56 | Blue               | P24                    | 7                     | 24                 | 9/16                    | 50             |
| LCDX6-10PH-L  |                     |                   |                     | #10                  | .69                     | .46                     | .48 | .08 | 1.74 | Blue               | P24                    | 7                     | 24                 | 9/16                    | 50             |
| LCDX6-14AH-L  | #6 AWG              | #6 AWG            | #6 AWG              | 1/4                  | .63                     | .48                     | .48 | .08 | 1.77 | Blue               | P24                    | 7                     | 24                 | 9/16                    | 50             |
| LCDX6-14BH-L  |                     |                   |                     | 1/4                  | .75                     | .48                     | .48 | .08 | 1.89 | Blue               | P24                    | 7                     | 24                 | 9/16                    | 50             |
| LCDX6-14DH-L  |                     |                   |                     | 1/4                  | 1.00                    | .48                     | .48 | .08 | 2.14 | Blue               | P24                    | 7                     | 24                 | 9/16                    | 50             |
| LCDX6-56DH-L  |                     |                   |                     | 5/16                 | 1.00                    | .56                     | .48 | .07 | 2.26 | Blue               | P24                    | 7                     | 24                 | 9/16                    | 50             |
| LCDX6-38DH-L  |                     |                   |                     | 3/8                  | 1.00                    | .62                     | .48 | .06 | 2.35 | Blue               | P24                    | 7                     | 24                 | 9/16                    | 50             |
| LCDX4-14AH-L  | #4 AWG              | #5, #4, #3 AWG    | #4 AWG              | 1/4                  | .63                     | .55                     | .53 | .09 | 1.83 | Gray               | P29                    | 8                     | 29                 | 5/8                     | 50             |
| LCDX4-14BH-L  |                     |                   |                     | 1/4                  | .75                     | .55                     | .53 | .09 | 1.96 | Gray               | P29                    | 8                     | 29                 | 5/8                     | 50             |
| LCDX4-14DH-L  |                     |                   |                     | 1/4                  | 1.00                    | .55                     | .53 | .09 | 2.21 | Gray               | P29                    | 8                     | 29                 | 5/8                     | 50             |
| LCDX4-56DH-L  |                     |                   |                     | 5/16                 | 1.00                    | .55                     | .53 | .09 | 2.33 | Gray               | P29                    | 8                     | 29                 | 5/8                     | 50             |
| LCDX4-38DH-L  |                     |                   |                     | 3/8                  | 1.00                    | .62                     | .53 | .08 | 2.42 | Gray               | P29                    | 8                     | 29                 | 5/8                     | 50             |
| LCDX2-14AH-E* | #2 AWG              | #2 AWG            | #2 AWG              | 1/4                  | .63                     | .70                     | .59 | .11 | 1.92 | Brown              | P33                    | 10                    | 33                 | 11/16                   | 20             |
| LCDX2-14BH-E* |                     |                   |                     | 1/4                  | .75                     | .70                     | .59 | .11 | 2.04 | Brown              | P33                    | 10                    | 33                 | 11/16                   | 20             |
| LCDX2-14DH-E* |                     |                   |                     | 1/4                  | 1.00                    | .70                     | .59 | .11 | 2.29 | Brown              | P33                    | 10                    | 33                 | 11/16                   | 20             |
| LCDX2-56DH-E* |                     |                   |                     | 5/16                 | 1.00                    | .70                     | .59 | .11 | 2.42 | Brown              | P33                    | 10                    | 33                 | 11/16                   | 20             |
| LCDX2-38DH-E* |                     |                   |                     | 3/8                  | 1.00                    | .70                     | .59 | .11 | 2.49 | Brown              | P33                    | 10                    | 33                 | 11/16                   | 20             |
| LCDX2-12H-E*  |                     |                   |                     | 1/2                  | 1.75                    | .75                     | .59 | .09 | 3.66 | Brown              | P33                    | 10                    | 33                 | 11/16                   | 20             |
| LCDX1-14AH-X  | #1 AWG              | #1 AWG            | #1 AWG              | 1/4                  | .63                     | .76                     | .66 | .12 | 2.06 | Green              | P37                    | 11                    | 37                 | 3/4                     | 10             |
| LCDX1-14BH-X  |                     |                   |                     | 1/4                  | .75                     | .76                     | .66 | .12 | 2.18 | Green              | P37                    | 11                    | 37                 | 3/4                     | 10             |
| LCDX1-14DH-X  |                     |                   |                     | 1/4                  | 1.00                    | .76                     | .66 | .12 | 2.43 | Green              | P37                    | 11                    | 37                 | 3/4                     | 10             |
| LCDX1-56DH-X  |                     |                   |                     | 5/16                 | 1.00                    | .76                     | .66 | .12 | 2.49 | Green              | P37                    | 11                    | 37                 | 3/4                     | 10             |
| LCDX1-38DH-X  |                     |                   |                     | 3/8                  | 1.00                    | .76                     | .66 | .12 | 2.56 | Green              | P37                    | 11                    | 37                 | 3/4                     | 10             |
| LCDX1-12H-X   |                     |                   |                     | 1/2                  | 1.75                    | .80                     | .66 | .12 | 3.73 | Green              | P37                    | 11                    | 37                 | 3/4                     | 10             |

‡See pages D3.70 – D3.73 for tool and die information.

\*Not UL Listed or CSA Certified with Class K flex conductor when crimped with Burndy tools.

\*\*Consult cable manufacturer for voltage stress relief instructions with applications greater than 2000 V.

◆NEMA hole sizes and spacing.





## Flex Conductor, Two-Hole, Standard Barrel with Window Lug, 45° Angle (continued)

| Part Number    | Flex Conductor Size |                   | Code Conductor Size | Stud Hole Size (In.) | Stud Hole Spacing (In.) | Figure Dimensions (In.) |      |     |      | Panduit Color Code | Panduit Die Index No.‡ | Burndy Die Index No.‡ | T&B Die Index No.‡ | Wire Strip Length (In.) | Std. Pkg. Qty. |
|----------------|---------------------|-------------------|---------------------|----------------------|-------------------------|-------------------------|------|-----|------|--------------------|------------------------|-----------------------|--------------------|-------------------------|----------------|
|                | Class G, H, I, K, M | Diesel Locomotive |                     |                      |                         | W                       | B    | T   | L    |                    |                        |                       |                    |                         |                |
| LCDX1/0-14AH-X |                     |                   |                     | 1/4                  | .63                     | .85                     | .72  | .13 | 2.21 | Pink               | P42                    | 12                    | 42                 | 3/4                     | 10             |
| LCDX1/0-14BH-X |                     |                   |                     | 1/4                  | .75                     | .85                     | .72  | .13 | 2.33 | Pink               | P42                    | 12                    | 42                 | 3/4                     | 10             |
| LCDX1/0-56BH-X |                     |                   |                     | 5/16                 | .75                     | .85                     | .72  | .13 | 2.33 | Pink               | P42                    | 12                    | 42                 | 3/4                     | 10             |
| LCDX1/0-56DH-X | 1/0 AWG             | 1/0 AWG           | 1/0 AWG             | 5/16                 | 1.00                    | .85                     | .72  | .13 | 2.58 | Pink               | P42                    | 12                    | 42                 | 3/4                     | 10             |
| LCDX1/0-38DH-X |                     |                   |                     | 3/8                  | 1.00                    | .85                     | .72  | .13 | 2.64 | Pink               | P42                    | 12                    | 42                 | 3/4                     | 10             |
| LCDX1/0-12DH-X |                     |                   |                     | 1/2                  | 1.00                    | .85                     | .72  | .13 | 2.89 | Pink               | P42                    | 12                    | 42                 | 3/4                     | 10             |
| LCDX1/0-12H-X  |                     |                   |                     | 1/2                  | 1.75                    | .85                     | .72  | .13 | 3.81 | Pink               | P42                    | 12                    | 42                 | 3/4                     | 10             |
| LCDX2/0-14AH-X |                     |                   |                     | 1/4                  | .63                     | .96                     | .83  | .13 | 2.30 | Black              | P45                    | 13                    | 45                 | 7/8                     | 10             |
| LCDX2/0-14BH-X |                     |                   |                     | 1/4                  | .75                     | .96                     | .83  | .13 | 2.43 | Black              | P45                    | 13                    | 45                 | 7/8                     | 10             |
| LCDX2/0-56DH-X | 2/0 AWG             | 2/0 AWG           | 2/0 AWG             | 5/16                 | 1.00                    | .96                     | .83  | .13 | 2.68 | Black              | P45                    | 13                    | 45                 | 7/8                     | 10             |
| LCDX2/0-38DH-X |                     |                   |                     | 3/8                  | 1.00                    | .96                     | .83  | .13 | 2.74 | Black              | P45                    | 13                    | 45                 | 7/8                     | 10             |
| LCDX2/0-12DH-X |                     |                   |                     | 1/2                  | 1.00                    | .96                     | .83  | .13 | 3.03 | Black              | P45                    | 13                    | 45                 | 7/8                     | 10             |
| LCDX2/0-12H-X  |                     |                   |                     | 1/2                  | 1.75                    | .96                     | .83  | .13 | 3.90 | Black              | P45                    | 13                    | 45                 | 7/8                     | 10             |
| LCDX3/0-14AH-X |                     |                   |                     | 1/4                  | .63                     | 1.06                    | .91  | .14 | 2.39 | Orange             | P50                    | 14                    | 50                 | 1                       | 10             |
| LCDX3/0-56DH-X | 3/0 AWG             | 3/0 AWG           | 3/0 AWG             | 5/16                 | 1.00                    | 1.06                    | .91  | .14 | 2.78 | Orange             | P50                    | 14                    | 50                 | 1                       | 10             |
| LCDX3/0-38DH-X |                     |                   |                     | 3/8                  | 1.00                    | 1.06                    | .91  | .14 | 2.85 | Orange             | P50                    | 14                    | 50                 | 1                       | 10             |
| LCDX3/0-12H-X  |                     |                   |                     | 1/2                  | 1.75                    | 1.06                    | .91  | .14 | 3.99 | Orange             | P50                    | 14                    | 50                 | 1                       | 10             |
| LCDX4/0-14AH-X |                     |                   |                     | 1/4                  | .63                     | 1.19                    | 1.03 | .16 | 2.67 | Purple             | P54                    | 15                    | 54                 | 1 1/16                  | 10             |
| LCDX4/0-14BH-X |                     |                   |                     | 1/4                  | .75                     | 1.19                    | 1.03 | .16 | 2.79 | Purple             | P54                    | 15                    | 54                 | 1 1/16                  | 10             |
| LCDX4/0-56DH-X | 4/0 AWG             | 4/0 AWG           | 4/0 AWG             | 5/16                 | 1.00                    | 1.19                    | 1.03 | .16 | 3.04 | Purple             | P54                    | 15                    | 54                 | 1 1/16                  | 10             |
| LCDX4/0-38DH-X |                     |                   |                     | 3/8                  | 1.00                    | 1.19                    | 1.03 | .16 | 3.07 | Purple             | P54                    | 15                    | 54                 | 1 1/16                  | 10             |
| LCDX4/0-12DH-X |                     |                   |                     | 1/2                  | 1.00                    | 1.19                    | 1.03 | .16 | 3.36 | Purple             | P54                    | 15                    | 54                 | 1 1/16                  | 10             |
| LCDX4/0-12EH-X |                     |                   |                     | 1/2                  | 1.25                    | 1.19                    | 1.03 | .16 | 3.62 | Purple             | P54                    | 15                    | 54                 | 1 1/16                  | 10             |
| LCDX4/0-12H-X  |                     |                   |                     | 1/2                  | 1.75                    | 1.19                    | 1.03 | .16 | 4.25 | Purple             | P54                    | 15                    | 54                 | 1 1/16                  | 10             |
| LCDX250-38DH-X | 250 kcmil           | 262.6 kcmil       | —                   | 3/8                  | 1.00                    | 1.28                    | 1.03 | .17 | 3.11 | Yellow             | P62                    | 16                    | 62                 | 1 1/16                  | 10             |
| LCDX250-38H-X  |                     |                   |                     | 3/8                  | 1.75                    | 1.28                    | 1.03 | .17 | 3.86 | Yellow             | P62                    | 16                    | 62                 | 1 1/16                  | 10             |
| LCDX250-12EH-X |                     |                   |                     | 1/2                  | 1.25                    | 1.28                    | 1.03 | .17 | 3.66 | Yellow             | P62                    | 16                    | 62                 | 1 1/16                  | 10             |
| LCDX250-12H-X  |                     |                   |                     | 1/2                  | 1.75                    | 1.28                    | 1.03 | .17 | 4.29 | Yellow             | P62                    | 16                    | 62                 | 1 1/16                  | 10             |
| LCDX300-38DH-6 | 300 kcmil           | 313.1 kcmil       | —                   | 3/8                  | 1.00                    | 1.39                    | 1.19 | .18 | 3.29 | Red                | P71                    | 18                    | 71H                | 1 1/4                   | 6              |
| LCDX300-12H-6  |                     |                   |                     | 1/2                  | 1.75                    | 1.39                    | 1.19 | .18 | 4.47 | Red                | P71                    | 18                    | 71H                | 1 1/4                   | 6              |
| LCDX350-56DH-6 | 350 kcmil           | 373.7 kcmil       | —                   | 5/16                 | 1.00                    | 1.54                    | 1.29 | .22 | 3.40 | Blue               | P76                    | 19                    | 76H                | 1 3/8                   | 6              |
| LCDX350-38DH-6 |                     |                   |                     | 3/8                  | 1.00                    | 1.54                    | 1.29 | .22 | 3.43 | Blue               | P76                    | 19                    | 76H                | 1 3/8                   | 6              |
| LCDX350-38H-6  |                     |                   |                     | 3/8                  | 1.75                    | 1.54                    | 1.29 | .22 | 4.18 | Blue               | P76                    | 19                    | 76H                | 1 3/8                   | 6              |
| LCDX350-12EH-6 |                     |                   |                     | 1/2                  | 1.25                    | 1.54                    | 1.29 | .22 | 3.98 | Blue               | P76                    | 19                    | 76H                | 1 3/8                   | 6              |
| LCDX350-12H-6  |                     |                   |                     | 1/2                  | 1.75                    | 1.54                    | 1.29 | .22 | 4.61 | Blue               | P76                    | 19                    | 76H                | 1 3/8                   | 6              |
| LCDX450-38DH-6 | 450 kcmil           | 444.4 kcmil       | —                   | 3/8                  | 1.00                    | 1.70                    | 1.40 | .26 | 3.75 | Brown              | P87                    | 20                    | 87H                | 1 7/16                  | 6              |
| LCDX450-12H-6  |                     |                   |                     | 1/2                  | 1.75                    | 1.70                    | 1.40 | .26 | 4.74 | Brown              | P87                    | 20                    | 87H                | 1 7/16                  | 6              |
| LCDX500-56DH-6 | 500 kcmil           | 535.3 kcmil       | —                   | 5/16                 | 1.00                    | 1.89                    | 1.48 | .26 | 3.70 | Pink               | P99                    | L99                   | 99H                | 1 9/16                  | 6              |
| LCDX500-38DH-6 |                     |                   |                     | 3/8                  | 1.00                    | 1.89                    | 1.48 | .26 | 3.73 | Pink               | P99                    | L99                   | 99H                | 1 9/16                  | 6              |
| LCDX500-12EH-6 |                     |                   |                     | 1/2                  | 1.25                    | 1.89                    | 1.48 | .26 | 4.41 | Pink               | P99                    | L99                   | 99H                | 1 9/16                  | 6              |
| LCDX500-12H-6  |                     |                   |                     | 1/2                  | 1.75                    | 1.89                    | 1.48 | .26 | 4.91 | Pink               | P99                    | L99                   | 99H                | 1 9/16                  | 6              |
| LCDX600-12H-6  | 600 kcmil           | —                 | —                   | 1/2                  | 1.75                    | 1.89                    | 1.48 | .26 | 4.91 | Pink               | P99                    | 400                   | 99H                | 1 9/16                  | 6              |
| LCDX650-38DH-6 | —                   | 646.4 kcmil       | —                   | 3/8                  | 1.00                    | 1.95                    | 1.45 | .30 | 3.74 | Black              | P106                   | 24                    | 106H               | 1 1/2                   | 6              |
| LCDX650-12H-6  |                     |                   |                     | 1/2                  | 1.75                    | 1.95                    | 1.45 | .30 | 4.92 | Black              | P106                   | 24                    | 106H               | 1 1/2                   | 6              |
| LCDX750-38DH-3 | —                   | 777.7 kcmil       | —                   | 3/8                  | 1.00                    | 2.17                    | 1.66 | .32 | 4.21 | Yellow             | P115                   | L115                  | 115H               | 1 3/4                   | 3              |
| LCDX750-12EH-3 |                     |                   |                     | 1/2                  | 1.25                    | 2.17                    | 1.66 | .32 | 4.65 | Yellow             | P115                   | L115                  | 115H               | 1 3/4                   | 3              |
| LCDX750-12GH-3 |                     |                   |                     | 1/2                  | 1.50                    | 2.17                    | 1.66 | .32 | 4.90 | Yellow             | P115                   | L115                  | 115H               | 1 3/4                   | 3              |
| LCDX750-12H-3  |                     |                   |                     | 1/2                  | 1.75                    | 2.17                    | 1.66 | .32 | 5.15 | Yellow             | P115                   | L115                  | 115H               | 1 3/4                   | 3              |
| LCDX750-58GH-3 |                     |                   |                     | 5/8                  | 1.50                    | 2.17                    | 1.66 | .32 | 4.90 | Yellow             | P115                   | L115                  | 115H               | 1 3/4                   | 3              |

‡See pages D3.70 – D3.73 for tool and die information.

\*Not UL Listed or CSA Certified with Class K flex conductor when crimped with Burndy tools.

\*\*Consult cable manufacturer for voltage stress relief instructions with applications greater than 2000 V.

◆NEMA hole sizes and spacing.

A. System Overview

B1. Cable Ties

B2. Cable Accessories

B3. Stainless Steel Ties

C1. Wiring Duct

C2. Surface Raceway

C3. Abrasion Protection

C4. Cable Management

D1. Terminals

D2. Power Connectors

D3. Grounding Connectors

E1. Labeling Systems

E2. Labels

E3. Pre-Printed & Write-On Markers

E4. Permanent Identification

E5. Lockout/Tagout & Safety Solutions

F. Index

A. System Overview



## Flex Conductor, Two-Hole, Standard Barrel with Window Lug, 90° Angle

B1. Cable Ties

**For Use with Flexible, Extra-Flexible, and Code Stranded Copper Conductors**

### Type LCDX-F

B2. Cable Accessories

- Can be used with code conductor and flex conductor class: G, H, I, K, M and Diesel Locomotive
- Tin-plated to inhibit corrosion
- Generously beveled wire entry prevents bent back strands when inserting conductor into barrel
- UL Listed and CSA Certified to 35 KV\*\* and temperature rated to 90°C when crimped with Panduit and specified competitor crimping tools and dies
- Color-coded barrels marked with Panduit and specified competitor die index numbers for proper crimp die selection
- American Bureau of Shipping approved
- Inspection window to visually assure full conductor insertion
- Available with NEMA hole sizes and spacing

B3. Stainless Steel Ties

C1. Wiring Duct



C2. Surface Raceway

C3. Abrasion Protection

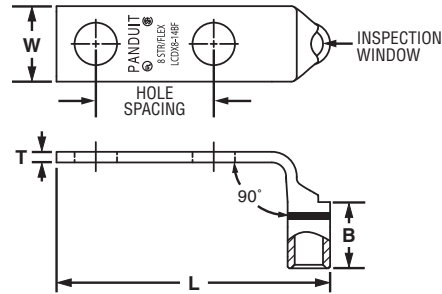

C4. Cable Management

D1. Terminals

D2. Power Connectors

D3. Grounding Connectors

E1. Labeling Systems

E2. Labels

E3. Pre-Printed & Write-On Markers

E4. Permanent Identification

E5. Lockout/Tagout & Safety Solutions

F. Index

| Part Number   | Flex Conductor Size |                   | Code Conductor Size | Stud Hole Size (In.) | Stud Hole Spacing (In.) | Figure Dimensions (In.) |     |     |      | Panduit Color Code | Panduit Die Index No.‡ | Burndy Die Index No.‡ | T&B Die Index No.‡ | Wire Strip Length (In.) | Std. Pkg. Qty. |
|---------------|---------------------|-------------------|---------------------|----------------------|-------------------------|-------------------------|-----|-----|------|--------------------|------------------------|-----------------------|--------------------|-------------------------|----------------|
|               | Class G, H, I, K, M | Diesel Locomotive |                     |                      |                         | W                       | B   | T   | L    |                    |                        |                       |                    |                         |                |
| LCDX8-10AF-L  |                     |                   |                     | #10                  | .63                     | .41                     | .42 | .08 | 1.53 | Red                | P21                    | 49                    | 21                 | 1/2                     | 50             |
| LCDX8-14AF-L  |                     |                   |                     | 1/4                  | .63                     | .48                     | .42 | .07 | 1.62 | Red                | P21                    | 49                    | 21                 | 1/2                     | 50             |
| LCDX8-14BF-L  | #8 AWG              | #8 AWG            | #8 AWG              | 1/4                  | .75                     | .48                     | .42 | .07 | 1.74 | Red                | P21                    | 49                    | 21                 | 1/2                     | 50             |
| LCDX8-14DF-L  |                     |                   |                     | 1/4                  | 1.00                    | .48                     | .42 | .07 | 1.99 | Red                | P21                    | 49                    | 21                 | 1/2                     | 50             |
| LCDX8-38DF-L  |                     |                   |                     | 3/8                  | 1.00                    | .63                     | .42 | .05 | 2.21 | Red                | P21                    | 49                    | 21                 | 1/2                     | 50             |
| LCDX6-10AF-L  |                     |                   |                     | #10                  | .63                     | .46                     | .48 | .08 | 1.57 | Blue               | P24                    | 7                     | 24                 | 9/16                    | 50             |
| LCDX6-10BF-L  |                     |                   |                     | #10                  | .75                     | .46                     | .48 | .08 | 1.69 | Blue               | P24                    | 7                     | 24                 | 9/16                    | 50             |
| LCDX6-10GF-L  |                     |                   |                     | #10                  | 1.50                    | .46                     | .48 | .08 | 2.44 | Blue               | P24                    | 7                     | 24                 | 9/16                    | 50             |
| LCDX6-10PF-L  |                     |                   |                     | #10                  | .69                     | .46                     | .48 | .08 | 1.63 | Blue               | P24                    | 7                     | 24                 | 9/16                    | 50             |
| LCDX6-14AF-L  | #6 AWG              | #6 AWG            | #6 AWG              | 1/4                  | .63                     | .48                     | .48 | .08 | 1.66 | Blue               | P24                    | 7                     | 24                 | 9/16                    | 50             |
| LCDX6-14BF-L  |                     |                   |                     | 1/4                  | .75                     | .48                     | .48 | .08 | 1.78 | Blue               | P24                    | 7                     | 24                 | 9/16                    | 50             |
| LCDX6-14DF-L  |                     |                   |                     | 1/4                  | 1.00                    | .48                     | .48 | .08 | 2.03 | Blue               | P24                    | 7                     | 24                 | 9/16                    | 50             |
| LCDX6-56DF-L  |                     |                   |                     | 5/16                 | 1.00                    | .56                     | .48 | .07 | 2.15 | Blue               | P24                    | 7                     | 24                 | 9/16                    | 50             |
| LCDX6-38DF-L  |                     |                   |                     | 3/8                  | 1.00                    | .62                     | .48 | .06 | 2.25 | Blue               | P24                    | 7                     | 24                 | 9/16                    | 50             |
| LCDX4-14AF-L  |                     |                   |                     | 1/4                  | .63                     | .55                     | .53 | .09 | 1.74 | Gray               | P29                    | 8                     | 29                 | 5/8                     | 50             |
| LCDX4-14BF-L  |                     |                   |                     | 1/4                  | .75                     | .55                     | .53 | .09 | 1.87 | Gray               | P29                    | 8                     | 29                 | 5/8                     | 50             |
| LCDX4-14DF-L  | #4 AWG              | #5, #4, #3 AWG    | #4 AWG              | 1/4                  | 1.00                    | .55                     | .53 | .09 | 2.12 | Gray               | P29                    | 8                     | 29                 | 5/8                     | 50             |
| LCDX4-56DF-L  |                     |                   |                     | 5/16                 | 1.00                    | .55                     | .53 | .09 | 2.24 | Gray               | P29                    | 8                     | 29                 | 5/8                     | 50             |
| LCDX4-38DF-L  |                     |                   |                     | 3/8                  | 1.00                    | .62                     | .53 | .08 | 2.34 | Gray               | P29                    | 8                     | 29                 | 5/8                     | 50             |
| LCDX2-14AF-E* |                     |                   |                     | 1/4                  | .63                     | .70                     | .59 | .11 | 1.94 | Brown              | P33                    | 10                    | 33                 | 11/16                   | 20             |
| LCDX2-14BF-E* |                     |                   |                     | 1/4                  | .75                     | .70                     | .59 | .11 | 2.06 | Brown              | P33                    | 10                    | 33                 | 11/16                   | 20             |
| LCDX2-14DF-E* |                     |                   |                     | 1/4                  | 1.00                    | .70                     | .59 | .11 | 2.31 | Brown              | P33                    | 10                    | 33                 | 11/16                   | 20             |
| LCDX2-56DF-E* | #2 AWG              | #2 AWG            | #2 AWG              | 5/16                 | 1.00                    | .70                     | .59 | .11 | 2.44 | Brown              | P33                    | 10                    | 33                 | 11/16                   | 20             |
| LCDX2-38DF-E* |                     |                   |                     | 3/8                  | 1.00                    | .70                     | .59 | .11 | 2.51 | Brown              | P33                    | 10                    | 33                 | 11/16                   | 20             |
| LCDX2-12F-E*  |                     |                   |                     | 1/2                  | 1.75                    | .75                     | .59 | .09 | 3.68 | Brown              | P33                    | 10                    | 33                 | 11/16                   | 20             |
| LCDX1-14AF-X  |                     |                   |                     | 1/4                  | .63                     | .76                     | .66 | .12 | 2.08 | Green              | P37                    | 11                    | 37                 | 3/4                     | 10             |
| LCDX1-14BF-X  |                     |                   |                     | 1/4                  | .75                     | .76                     | .66 | .12 | 2.20 | Green              | P37                    | 11                    | 37                 | 3/4                     | 10             |
| LCDX1-14DF-X  |                     |                   |                     | 1/4                  | 1.00                    | .76                     | .66 | .12 | 2.45 | Green              | P37                    | 11                    | 37                 | 3/4                     | 10             |
| LCDX1-56DF-X  | #1 AWG              | #1 AWG            | #1 AWG              | 5/16                 | 1.00                    | .76                     | .66 | .12 | 2.51 | Green              | P37                    | 11                    | 37                 | 3/4                     | 10             |
| LCDX1-38DF-X  |                     |                   |                     | 3/8                  | 1.00                    | .76                     | .66 | .12 | 2.58 | Green              | P37                    | 11                    | 37                 | 3/4                     | 10             |
| LCDX1-12F-X   |                     |                   |                     | 1/2                  | 1.75                    | .80                     | .66 | .12 | 3.75 | Green              | P37                    | 11                    | 37                 | 3/4                     | 10             |

‡See pages D3.70 – D3.73 for tool and die information.

\*Not UL Listed or CSA Certified with Class K flex conductor when crimped with Burndy tools.

\*\*Consult cable manufacturer for voltage stress relief instructions with applications greater than 2000 V.

◆NEMA hole sizes and spacing.



## Flex Conductor, Two-Hole, Standard Barrel with Window Lug, 90° Angle (continued)

A.  
System  
Overview

B1.  
Cable Ties

B2.  
Cable  
Accessories

B3.  
Stainless  
Steel Ties

C1.  
Wiring  
Duct

C2.  
Surface  
Raceway

C3.  
Abrasion  
Protection

C4.  
Cable  
Management

D1.  
Terminals

D2.  
Power  
Connectors

D3.  
Grounding  
Connectors

E1.  
Labeling  
Systems

E2.  
Labels

E3.  
Pre-Printed  
& Write-On  
Markers

E4.  
Permanent  
Identification

E5.  
Lockout/  
Tagout  
& Safety  
Solutions

F.  
Index

| Part Number    | Flex Conductor Size |                   | Code Conductor Size | Stud Hole Size (In.) | Stud Hole Spacing (In.) | Figure Dimensions (In.) |      |     |      | Panduit Color Code | Panduit Die Index No.‡ | Burdny Die Index No.‡ | T&B Die Index No.‡ | Wire Strip Length (In.) | Std. Pkg. Qty. |
|----------------|---------------------|-------------------|---------------------|----------------------|-------------------------|-------------------------|------|-----|------|--------------------|------------------------|-----------------------|--------------------|-------------------------|----------------|
|                | Class G, H, I, K, M | Diesel Locomotive |                     |                      |                         | W                       | B    | T   | L    |                    |                        |                       |                    |                         |                |
| LCDX1/0-14AF-X |                     |                   |                     | 1/4                  | .63                     | .85                     | .72  | .13 | 2.22 | Pink               | P42                    | 12                    | 42                 | 3/4                     | 10             |
| LCDX1/0-14BF-X |                     |                   |                     | 1/4                  | .75                     | .85                     | .72  | .13 | 2.34 | Pink               | P42                    | 12                    | 42                 | 3/4                     | 10             |
| LCDX1/0-56BF-X |                     |                   |                     | 5/16                 | .75                     | .85                     | .72  | .13 | 2.34 | Pink               | P42                    | 12                    | 42                 | 3/4                     | 10             |
| LCDX1/0-56DF-X | 1/0 AWG             | 1/0 AWG           | 1/0 AWG             | 5/16                 | 1.00                    | .85                     | .72  | .13 | 2.59 | Pink               | P42                    | 12                    | 42                 | 3/4                     | 10             |
| LCDX1/0-38DF-X |                     |                   |                     | 3/8                  | 1.00                    | .85                     | .72  | .13 | 2.66 | Pink               | P42                    | 12                    | 42                 | 3/4                     | 10             |
| LCDX1/0-12DF-X |                     |                   |                     | 1/2                  | 1.00                    | .85                     | .72  | .13 | 2.91 | Pink               | P42                    | 12                    | 42                 | 3/4                     | 10             |
| LCDX1/0-12F-X  |                     |                   |                     | 1/2                  | 1.75                    | .85                     | .72  | .13 | 3.82 | Pink               | P42                    | 12                    | 42                 | 3/4                     | 10             |
| LCDX2/0-14AF-X |                     |                   |                     | 1/4                  | .63                     | .96                     | .83  | .13 | 2.29 | Black              | P45                    | 13                    | 45                 | 7/8                     | 10             |
| LCDX2/0-14BF-X |                     |                   |                     | 1/4                  | .75                     | .96                     | .83  | .13 | 2.42 | Black              | P45                    | 13                    | 45                 | 7/8                     | 10             |
| LCDX2/0-56DF-X | 2/0 AWG             | 2/0 AWG           | 2/0 AWG             | 5/16                 | 1.00                    | .96                     | .83  | .13 | 2.67 | Black              | P45                    | 13                    | 45                 | 7/8                     | 10             |
| LCDX2/0-38DF-X |                     |                   |                     | 3/8                  | 1.00                    | .96                     | .83  | .13 | 2.73 | Black              | P45                    | 13                    | 45                 | 7/8                     | 10             |
| LCDX2/0-12DF-X |                     |                   |                     | 1/2                  | 1.00                    | .96                     | .83  | .13 | 2.98 | Black              | P45                    | 13                    | 45                 | 7/8                     | 10             |
| LCDX2/0-12F-X  |                     |                   |                     | 1/2                  | 1.75                    | .96                     | .83  | .13 | 3.89 | Black              | P45                    | 13                    | 45                 | 7/8                     | 10             |
| LCDX3/0-14AF-X |                     |                   |                     | 1/4                  | .63                     | 1.06                    | .91  | .14 | 2.38 | Orange             | P50                    | 14                    | 50                 | 1                       | 10             |
| LCDX3/0-56DF-X | 3/0 AWG             | 3/0 AWG           | 3/0 AWG             | 5/16                 | 1.00                    | 1.06                    | .91  | .14 | 2.77 | Orange             | P50                    | 14                    | 50                 | 1                       | 10             |
| LCDX3/0-38DF-X |                     |                   |                     | 3/8                  | 1.00                    | 1.06                    | .91  | .14 | 2.84 | Orange             | P50                    | 14                    | 50                 | 1                       | 10             |
| LCDX3/0-12F-X  |                     |                   |                     | 1/2                  | 1.75                    | 1.06                    | .91  | .14 | 3.98 | Orange             | P50                    | 14                    | 50                 | 1                       | 10             |
| LCDX4/0-14AF-X |                     |                   |                     | 1/4                  | .63                     | 1.19                    | 1.03 | .16 | 2.28 | Purple             | P54                    | 15                    | 54                 | 1 1/16                  | 10             |
| LCDX4/0-14BF-X |                     |                   |                     | 1/4                  | .75                     | 1.19                    | 1.03 | .16 | 2.40 | Purple             | P54                    | 15                    | 54                 | 1 1/16                  | 10             |
| LCDX4/0-56DF-X | 4/0 AWG             | 4/0 AWG           | 4/0 AWG             | 5/16                 | 1.00                    | 1.19                    | 1.03 | .16 | 2.85 | Purple             | P54                    | 15                    | 54                 | 1 1/16                  | 10             |
| LCDX4/0-38DF-X |                     |                   |                     | 3/8                  | 1.00                    | 1.19                    | 1.03 | .16 | 2.88 | Purple             | P54                    | 15                    | 54                 | 1 1/16                  | 10             |
| LCDX4/0-12DF-X |                     |                   |                     | 1/2                  | 1.00                    | 1.19                    | 1.03 | .16 | 3.15 | Purple             | P54                    | 15                    | 54                 | 1 1/16                  | 10             |
| LCDX4/0-12EF-X |                     |                   |                     | 1/2                  | 1.25                    | 1.19                    | 1.03 | .16 | 3.43 | Purple             | P54                    | 15                    | 54                 | 1 1/16                  | 10             |
| LCDX4/0-12F-X  |                     |                   |                     | 1/2                  | 1.75                    | 1.19                    | 1.03 | .16 | 4.06 | Purple             | P54                    | 15                    | 54                 | 1 1/16                  | 10             |
| LCDX250-38DF-X | 250 kcmil           | 262.6 kcmil       | —                   | 3/8                  | 1.00                    | 1.28                    | 1.03 | .17 | 2.94 | Yellow             | P62                    | 16                    | 62                 | 1 1/16                  | 10             |
| LCDX250-38F-X  |                     |                   |                     | 3/8                  | 1.75                    | 1.28                    | 1.03 | .17 | 3.69 | Yellow             | P62                    | 16                    | 62                 | 1 1/16                  | 10             |
| LCDX250-12EF-X |                     |                   |                     | 1/2                  | 1.25                    | 1.28                    | 1.03 | .17 | 3.49 | Yellow             | P62                    | 16                    | 62                 | 1 1/16                  | 10             |
| LCDX250-12F-X  |                     |                   |                     | 1/2                  | 1.75                    | 1.28                    | 1.03 | .17 | 4.12 | Yellow             | P62                    | 16                    | 62                 | 1 1/16                  | 10             |
| LCDX300-38DF-6 | 300 kcmil           | 313.1 kcmil       | —                   | 3/8                  | 1.00                    | 1.39                    | 1.19 | .18 | 3.02 | Red                | P71                    | 18                    | 71H                | 1 1/4                   | 6              |
| LCDX300-12F-6  |                     |                   |                     | 1/2                  | 1.75                    | 1.39                    | 1.19 | .18 | 4.20 | Red                | P71                    | 18                    | 71H                | 1 1/4                   | 6              |
| LCDX350-56DF-6 | 350 kcmil           | 373.7 kcmil       | —                   | 5/16                 | 1.00                    | 1.54                    | 1.29 | .22 | 3.10 | Blue               | P76                    | 19                    | 76H                | 1 3/8                   | 6              |
| LCDX350-38DF-6 |                     |                   |                     | 3/8                  | 1.00                    | 1.54                    | 1.29 | .22 | 3.13 | Blue               | P76                    | 19                    | 76H                | 1 3/8                   | 6              |
| LCDX350-38F-6  |                     |                   |                     | 3/8                  | 1.75                    | 1.54                    | 1.29 | .22 | 3.88 | Blue               | P76                    | 19                    | 76H                | 1 3/8                   | 6              |
| LCDX350-12EF-6 |                     |                   |                     | 1/2                  | 1.25                    | 1.54                    | 1.29 | .22 | 3.68 | Blue               | P76                    | 19                    | 76H                | 1 3/8                   | 6              |
| LCDX350-12F-6  |                     |                   |                     | 1/2                  | 1.75                    | 1.54                    | 1.29 | .22 | 4.31 | Blue               | P76                    | 19                    | 76H                | 1 3/8                   | 6              |
| LCDX450-38DF-6 | 450 kcmil           | 444.4 kcmil       | —                   | 3/8                  | 1.00                    | 1.70                    | 1.40 | .26 | 3.26 | Brown              | P87                    | 20                    | 87H                | 1 7/16                  | 6              |
| LCDX450-12F-6  |                     |                   |                     | 1/2                  | 1.75                    | 1.70                    | 1.40 | .26 | 4.44 | Brown              | P87                    | 20                    | 87H                | 1 7/16                  | 6              |
| LCDX500-56DF-6 | 500 kcmil           | 535.3 kcmil       | —                   | 5/16                 | 1.00                    | 1.89                    | 1.48 | .26 | 3.29 | Pink               | P99                    | L99                   | 99H                | 1 9/16                  | 6              |
| LCDX500-38DF-6 |                     |                   |                     | 3/8                  | 1.00                    | 1.89                    | 1.48 | .26 | 3.32 | Pink               | P99                    | L99                   | 99H                | 1 9/16                  | 6              |
| LCDX500-12EF-6 |                     |                   |                     | 1/2                  | 1.25                    | 1.89                    | 1.48 | .26 | 4.00 | Pink               | P99                    | L99                   | 99H                | 1 9/16                  | 6              |
| LCDX500-12F-6  |                     |                   |                     | 1/2                  | 1.75                    | 1.89                    | 1.48 | .26 | 4.50 | Pink               | P99                    | L99                   | 99H                | 1 9/16                  | 6              |
| LCDX600-12F-6  | 600 kcmil           | —                 | —                   | 1/2                  | 1.75                    | 1.89                    | 1.48 | .26 | 4.50 | Pink               | P99                    | 400                   | 99H                | 1 9/16                  | 6              |
| LCDX650-38DF-6 | —                   | 646.4 kcmil       | —                   | 3/8                  | 1.00                    | 1.95                    | 1.45 | .30 | 3.37 | Black              | P106                   | 24                    | 106H               | 1 1/2                   | 6              |
| LCDX650-12F-6  |                     |                   |                     | 1/2                  | 1.75                    | 1.95                    | 1.45 | .30 | 4.55 | Black              | P106                   | 24                    | 106H               | 1 1/2                   | 6              |
| LCDX750-38DF-3 | —                   | 777.7 kcmil       | —                   | 3/8                  | 1.00                    | 2.17                    | 1.66 | .32 | 3.76 | Yellow             | P115                   | L115                  | 115H               | 1 3/4                   | 3              |
| LCDX750-12EF-3 |                     |                   |                     | 1/2                  | 1.25                    | 2.17                    | 1.66 | .32 | 4.20 | Yellow             | P115                   | L115                  | 115H               | 1 3/4                   | 3              |
| LCDX750-12GF-3 |                     |                   |                     | 1/2                  | 1.50                    | 2.17                    | 1.66 | .32 | 4.45 | Yellow             | P115                   | L115                  | 115H               | 1 3/4                   | 3              |
| LCDX750-12F-3  |                     |                   |                     | 1/2                  | 1.75                    | 2.17                    | 1.66 | .32 | 4.70 | Yellow             | P115                   | L115                  | 115H               | 1 3/4                   | 3              |
| LCDX750-58GF-3 |                     |                   |                     | 5/8                  | 1.50                    | 2.17                    | 1.66 | .32 | 4.45 | Yellow             | P115                   | L115                  | 115H               | 1 3/4                   | 3              |

‡See pages D3.70 – D3.73 for tool and die information.

\*Not UL Listed or CSA Certified with Class K flex conductor when crimped with Burdny tools.

\*\*Consult cable manufacturer for voltage stress relief instructions with applications greater than 2000 V.

◆NEMA hole sizes and spacing.

A. System Overview



## Flex Conductor, Two-Hole, Standard Barrel with Window, Narrow Tongue Lug

B1. Cable Ties

**For Use with Flexible, Extra-Flexible, and Code Stranded Copper Conductors**

### Type LCDXN

- Narrow tongue width for limited space applications
- Can be used with code conductor and flex conductor class: G, H, I, K, M and Diesel Locomotive
- Generously beveled wire entry prevents bent back strands when inserting conductor into barrel
- Color-coded barrels marked with Panduit and specified competitor die index numbers for proper crimp die selection
- Inspection window to visually assure full conductor insertion
- Tin-plated to inhibit corrosion
- UL Listed and CSA Certified to 35 KV\*\* and temperature rated to 90°C when crimped with Panduit and specified competitor crimping tools and dies
- Available with NEMA hole sizes and spacing

C1. Wiring Duct



C2. Surface Raceway

C3. Abrasion Protection

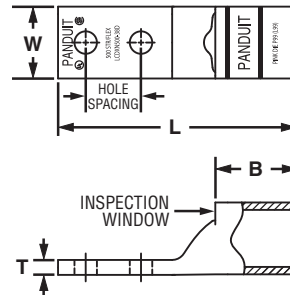

C4. Cable Management

| Part Number            | Flex Conductor Size |                   | Code Conductor Size | Stud Hole Size (In.) | Stud Hole Spacing (In.) | Figure Dimensions (In.) |      |     |      | Panduit Color Code | Panduit Die Index No.‡ | Burndy Die Index No.‡ | T&B Die Index No.‡ | Wire Strip Length (In.) | Std. Pkg. Qty. |
|------------------------|---------------------|-------------------|---------------------|----------------------|-------------------------|-------------------------|------|-----|------|--------------------|------------------------|-----------------------|--------------------|-------------------------|----------------|
|                        | Class G, H, I, K, M | Diesel Locomotive |                     |                      |                         | W                       | B    | T   | L    |                    |                        |                       |                    |                         |                |
| <b>LCDXN2-14A-E*</b>   | #2 AWG              | #2 AWG            | #2 AWG              | 1/4                  | .63                     | .47                     | .59  | .11 | 2.13 | Brown              | P33                    | 10                    | 33                 | 11/16                   | 20             |
| <b>LCDXN4/0-38D-X</b>  | 4/0 AWG             | 4/0 AWG           | 4/0 AWG             | 3/8                  | 1.00                    | .81                     | 1.03 | .16 | 3.34 | Purple             | P54                    | 15                    | 54                 | 1 1/16                  | 10             |
| <b>LCDXN350-38D-6</b>  | 350 kcmil           | 373.7 kcmil       | —                   | 3/8                  | 1.00                    | 1.06                    | 1.29 | .22 | 3.74 | Blue               | P76                    | 19                    | 76H                | 1 3/8                   | 6              |
| <b>LCDXN500-38D-6</b>  | 500 kcmil           | 535.3 kcmil       | —                   | 3/8                  | 1.00                    | 1.30                    | 1.48 | .28 | 4.32 | Pink               | P99                    | L99                   | 99H                | 1 9/16                  | 6              |
| <b>LCDXN750-38D-3</b>  | —                   | 777.7 kcmil       | —                   | 3/8                  | 1.00                    | 1.50                    | 1.66 | .34 | 4.62 | Yellow             | P115                   | L115                  | 115H               | 1 3/4                   | 3              |
| ◆ <b>LCDXN750-12-3</b> | —                   | 777.7 kcmil       | —                   | 1/2                  | 1.75                    | 1.50                    | 1.66 | .35 | 5.55 | Yellow             | P115                   | L115                  | 115H               | 1 3/4                   | 3              |

‡See pages D3.70 – D3.73 for tool and die information.

\*Not UL Listed or CSA Certified with Class K flex conductor when crimped with Burndy tools.

\*\*Consult cable manufacturer for voltage stress relief instructions with applications greater than 2000 V.

◆NEMA hole sizes and spacing.

E1. Labeling Systems

E2. Labels

E3. Pre-Printed & Write-On Markers

E4. Permanent Identification

E5. Lockout/Tagout & Safety Solutions

F. Index



## Flex Conductor, Two-Hole, Standard Barrel with Window, Narrow Tongue Lug, 45°

For Use with Flexible Copper Conductors

### Type LCDXN-H

- Narrow tongue width for limited space applications
- Can be used with code conductor and flex conductor class: G, H, I, K, M and Diesel Locomotive
- Generously beveled wire entry prevents bent back strands when inserting conductor into barrel
- Color-coded barrels marked with Panduit and specified competitor die index numbers for proper crimp die selection

- Inspection window to visually assure full conductor insertion
- Tin-plated to inhibit corrosion
- UL Listed and CSA Certified to 35 KV\*\* and temperature rated to 90°C when crimped with Panduit and specified competitor crimping tools and dies

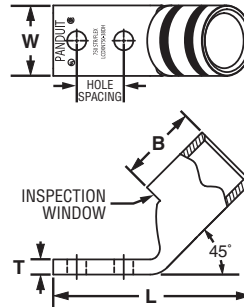

| Part Number     | Flex Conductor Size |                   | Code Conductor Size | Stud Hole Size (In.) | Stud Hole Spacing (In.) | Figure Dimensions (In.) |      |      |      | Panduit Color Code | Panduit Die Index No.‡ | Burndy Die Index No.‡ | T&B Die Index No.‡ | Wire Strip Length (In.) | Std. Pkg. Qty. |
|-----------------|---------------------|-------------------|---------------------|----------------------|-------------------------|-------------------------|------|------|------|--------------------|------------------------|-----------------------|--------------------|-------------------------|----------------|
|                 | Class G, H, I, K, M | Diesel Locomotive |                     |                      |                         | W                       | B    | T    | L    |                    |                        |                       |                    |                         |                |
| LCDXN2-14AH-E*  | #2 AWG              | #2 AWG            | #2 AWG              | 1/4                  | 0.63                    | 0.47                    | 0.59 | 0.11 | 1.92 | Brown              | P33                    | 10                    | 33                 | 11/16                   | 20             |
| LCDXN750-38DH-3 | —                   | 777.7 kcmil       | —                   | 3/8                  | 1.00                    | 1.50                    | 1.66 | 0.35 | 4.22 | Yellow             | P115                   | L115                  | 115H               | 1 3/4                   | 3              |

‡See pages D3.70 – D3.73 for tool and die information.

\*Not UL Listed or CSA Certified with Class K flex conductor when crimped with Burndy tools.

\*\*Consult cable manufacturer for voltage stress relief instructions with applications greater than 2000 V.



## Flex Conductor, Two-Hole, Standard Barrel with Window, Narrow Tongue Lug, 90°

For Use with Flexible Copper Conductors

### Type LCDXN-F

- Narrow tongue width for limited space applications
- Can be used with code conductor and flex conductor class: G, H, I, K, M and Diesel Locomotive
- Generously beveled wire entry prevents bent back strands when inserting conductor into barrel
- Color-coded barrels marked with Panduit and specified competitor die index numbers for proper crimp die selection

- Inspection window to visually assure full conductor insertion
- Tin-plated to inhibit corrosion
- UL Listed and CSA Certified to 35 KV\*\* and temperature rated to 90°C when crimped with Panduit and specified competitor crimping tools and dies

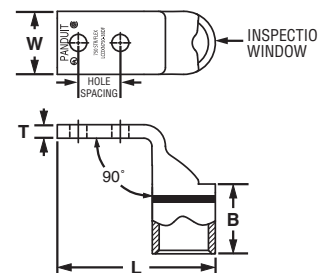

| Part Number     | Flex Conductor Size |                   | Code Conductor Size | Stud Hole Size (In.) | Stud Hole Spacing (In.) | Figure Dimensions (In.) |      |      |      | Panduit Color Code | Panduit Die Index No.‡ | Burndy Die Index No.‡ | T&B Die Index No.‡ | Wire Strip Length (In.) | Std. Pkg. Qty. |
|-----------------|---------------------|-------------------|---------------------|----------------------|-------------------------|-------------------------|------|------|------|--------------------|------------------------|-----------------------|--------------------|-------------------------|----------------|
|                 | Class G, H, I, K, M | Diesel Locomotive |                     |                      |                         | W                       | B    | T    | L    |                    |                        |                       |                    |                         |                |
| LCDXN2-14AF-E*  | #2 AWG              | #2 AWG            | #2 AWG              | 1/4                  | 0.63                    | 0.47                    | 0.59 | 0.11 | 1.94 | Brown              | P33                    | 10                    | 33                 | 11/16                   | 20             |
| LCDXN750-38DF-3 | —                   | 777.7 kcmil       | —                   | 3/8                  | 1.00                    | 1.50                    | 1.66 | 0.35 | 3.76 | Yellow             | P115                   | L115                  | 115H               | 1 3/4                   | 3              |

‡See pages D3.70 – D3.73 for tool and die information.

\*Not UL Listed or CSA Certified with class K flex conductor when crimped with Burndy tools.

\*\*Consult cable manufacturer for voltage stress relief instructions with applications greater than 2000 V.

A. System Overview

B1. Cable Ties

B2. Cable Accessories

B3. Stainless Steel Ties

C1. Wiring Duct

C2. Surface Raceway

C3. Abrasion Protection

C4. Cable Management

D1. Terminals

D2. Power Connectors

D3. Grounding Connectors

E1. Labeling Systems

E2. Labels

E3. Pre-Printed & Write-On Markers

E4. Permanent Identification

E5. Lockout/Tagout & Safety Solutions

F. Index



A. System Overview



## Flex Conductor, Two-Hole, Long Barrel with Window Lug

B1. Cable Ties

**For Use with Flexible, Extra-Flexible, and Code Stranded Copper Conductors**

### Type LCCX

B2. Cable Accessories

B3. Stainless Steel Ties

- Can be used with code conductor and flex conductor class: G, H, I, K, M and Diesel Locomotive
- Long barrel maximizes number of crimps and provides premium wire pull-out strength and electrical performance
- Generously beveled wire entry prevents bent back strands when inserting conductor into barrel
- Color-coded barrels marked with Panduit and specified competitor die index numbers for proper crimp die selection
- Inspection window to visually assure full conductor insertion
- Tin-plated to inhibit corrosion
- UL Listed and CSA Certified to 35 KV\*\* and temperature rated to 90°C when crimped with Panduit and specified competitor crimping tools and dies
- Meets J-STD-607-A and TIA-942 requirements for network systems grounding applications
- Available with NEMA hole sizes and spacing

C1. Wiring Duct

C2. Surface Raceway

C3. Abrasion Protection

C4. Cable Management

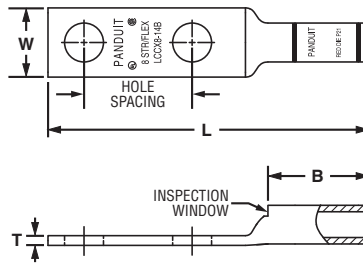

Figure 1

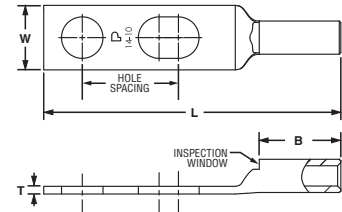

Figure 2: Slotted

D1. Terminals

D2. Power Connectors

D3. Grounding Connectors

E1. Labeling Systems

E2. Labels

E3. Pre-Printed & Write-On Markers

E4. Permanent Identification

E5. Lockout/Tagout & Safety Solutions

F. Index

| Part Number   | Flex Conductor Size |                   | Code Conductor Size | Stud Hole Size (In.) | Stud Hole Spacing (In.) | Figure Dimensions (In.) |      |             |      | Panduit Color Code | Panduit Die Index No.‡ | Burndy Die Index No.‡ | T&B Die Index No.‡ | Wire Strip Length (In.) | Std. Pkg. Qty. |    |       |    |
|---------------|---------------------|-------------------|---------------------|----------------------|-------------------------|-------------------------|------|-------------|------|--------------------|------------------------|-----------------------|--------------------|-------------------------|----------------|----|-------|----|
|               | Class G, H, I, K, M | Diesel Locomotive |                     |                      |                         | W                       | B    | T           | L    |                    |                        |                       |                    |                         |                |    |       |    |
| LCCX8-10A-L   | #8 AWG              | #8 AWG            | #8 AWG              | #10                  | 0.63                    | 0.41                    | 0.70 | 0.08        | 2.01 | Red                | P21                    | 49                    | 21                 | 3/4                     | 50             |    |       |    |
| LCCX8-10B-L   |                     |                   |                     | #10                  | 0.75                    | 0.41                    | 0.70 | 0.08        | 2.14 | Red                | P21                    | 49                    | 21                 | 3/4                     | 50             |    |       |    |
| LCCX8-10AB-L^ |                     |                   |                     | #10                  | 0.63 – 0.75             | 0.41                    | 0.70 | 0.08        | 2.14 | Red                | P21                    | 49                    | 21                 | 3/4                     | 50             |    |       |    |
| LCCX8-14A-L   |                     |                   |                     | 1/4                  | 0.63                    | 0.48                    | 0.70 | 0.07        | 2.10 | Red                | P21                    | 49                    | 21                 | 3/4                     | 50             |    |       |    |
| LCCX8-14B-L   |                     |                   |                     | 1/4                  | 0.75                    | 0.48                    | 0.70 | 0.07        | 2.23 | Red                | P21                    | 49                    | 21                 | 3/4                     | 50             |    |       |    |
| LCCX8-14AB-L^ |                     |                   |                     | 1/4                  | 0.63 – 0.75             | 0.48                    | 0.70 | 0.07        | 2.23 | Red                | P21                    | 49                    | 21                 | 3/4                     | 50             |    |       |    |
| LCCX8-14D-L   |                     |                   |                     | 1/4                  | 1.00                    | 0.48                    | 0.70 | 0.07        | 2.48 | Red                | P21                    | 49                    | 21                 | 3/4                     | 50             |    |       |    |
| LCCX8-38D-L   |                     |                   |                     | 3/8                  | 1.00                    | 0.60                    | 0.70 | 0.05        | 2.70 | Red                | P21                    | 49                    | 21                 | 3/4                     | 50             |    |       |    |
| LCCX6-10B-L   |                     |                   |                     | #6 AWG               | #6 AWG                  | #6 AWG                  | #10  | 0.75        | 0.46 | 1.07               | 0.08                   | 2.52                  | Blue               | P24                     | 7              | 24 | 1 1/8 | 50 |
| LCCX6-14A-L   |                     |                   |                     |                      |                         |                         | 1/4  | 0.63        | 0.48 | 1.07               | 0.08                   | 2.49                  | Blue               | P24                     | 7              | 24 | 1 1/8 | 50 |
| LCCX6-14B-L   |                     |                   |                     |                      |                         |                         | 1/4  | 0.75        | 0.48 | 1.07               | 0.08                   | 2.61                  | Blue               | P24                     | 7              | 24 | 1 1/8 | 50 |
| LCCX6-14AB-L^ |                     |                   |                     |                      |                         |                         | 1/4  | 0.63 – 0.75 | 0.48 | 1.07               | 0.08                   | 2.61                  | Blue               | P24                     | 7              | 24 | 1 1/8 | 50 |
| LCCX6-14D-L   | 1/4                 | 1.00              | 0.48                |                      |                         |                         | 1.07 | 0.08        | 2.86 | Blue               | P24                    | 7                     | 24                 | 1 1/8                   | 50             |    |       |    |
| LCCX6-38A-L   | 3/8                 | 0.63              | 0.62                |                      |                         |                         | 1.07 | 0.06        | 2.71 | Blue               | P24                    | 7                     | 24                 | 1 1/8                   | 50             |    |       |    |
| LCCX6-38C-L   | 3/8                 | 0.88              | 0.62                |                      |                         |                         | 1.07 | 0.06        | 2.96 | Blue               | P24                    | 7                     | 24                 | 1 1/8                   | 50             |    |       |    |
| LCCX6-38AC-L^ | 3/8                 | 0.63 – 0.88       | 0.62                |                      |                         |                         | 1.07 | 0.06        | 2.96 | Blue               | P24                    | 7                     | 24                 | 1 1/8                   | 50             |    |       |    |
| LCCX6-38D-L   | 3/8                 | 1.00              | 0.62                |                      |                         |                         | 1.07 | 0.06        | 3.08 | Blue               | P24                    | 7                     | 24                 | 1 1/8                   | 50             |    |       |    |
| LCCX4-14A-L   | #4 AWG              | #5, #4, #3 AWG    | #4 AWG              |                      |                         |                         | 1/4  | 0.63        | 0.55 | 1.05               | 0.09                   | 2.49                  | Gray               | P29                     | 8              | 29 | 1 1/8 | 50 |
| LCCX4-14B-L   |                     |                   |                     |                      |                         |                         | 1/4  | 0.75        | 0.55 | 1.05               | 0.09                   | 2.63                  | Gray               | P29                     | 8              | 29 | 1 1/8 | 50 |
| LCCX4-14AB-L^ |                     |                   |                     |                      |                         |                         | 1/4  | 0.63 – 0.75 | 0.55 | 1.05               | 0.09                   | 2.63                  | Gray               | P29                     | 8              | 29 | 1 1/8 | 50 |
| LCCX4-14CE-L^ |                     |                   |                     | 1/4                  | 0.88 – 1.25             | 0.55                    | 1.05 | 0.09        | 3.12 | Gray               | P29                    | 8                     | 29                 | 1 1/8                   | 50             |    |       |    |
| LCCX4-38B-L   |                     |                   |                     | 3/8                  | 0.75                    | 0.62                    | 1.05 | 0.08        | 2.84 | Gray               | P29                    | 8                     | 29                 | 1 1/8                   | 50             |    |       |    |
| LCCX4-38D-L   |                     |                   |                     | 3/8                  | 1.00                    | 0.62                    | 1.05 | 0.08        | 3.09 | Gray               | P29                    | 8                     | 29                 | 1 1/8                   | 50             |    |       |    |
| LCCX4-38BD-L^ |                     |                   |                     | 3/8                  | 0.75 – 1.00             | 0.62                    | 1.05 | 0.08        | 3.09 | Gray               | P29                    | 8                     | 29                 | 1 1/8                   | 50             |    |       |    |

‡See pages D3.70 – D3.73 for tool and die information.

\*Not UL Listed or CSA Certified with Class K flex conductor when crimped with Burndy tools.

\*\*Consult cable manufacturer for voltage stress relief instructions with applications greater than 2000 V.

^Slotted lug, refer to Figure 2.

◆NEMA hole sizes and spacing.





## Flex Conductor, Two-Hole, Long Barrel with Window Lug (continued)

| Part Number   | Flex Conductor Size |                   | Code Conductor Size | Stud Hole Size (In.) | Stud Hole Spacing (In.) | Figure Dimensions (In.) |      |      |      | Panduit Color Code | Panduit Die Index No.‡ | Burndy Die Index No.‡ | T&B Die Index No.‡ | Wire Strip Length (In.) | Std. Pkg. Qty. |
|---------------|---------------------|-------------------|---------------------|----------------------|-------------------------|-------------------------|------|------|------|--------------------|------------------------|-----------------------|--------------------|-------------------------|----------------|
|               | Class G, H, I, K, M | Diesel Locomotive |                     |                      |                         | W                       | B    | T    | L    |                    |                        |                       |                    |                         |                |
|               |                     |                   |                     |                      |                         |                         |      |      |      |                    |                        |                       |                    |                         |                |
| LCCX2-14A-E*  | #2 AWG              | #2 AWG            | #2 AWG              | 1/4                  | 0.63                    | 0.70                    | 1.36 | 0.11 | 2.89 | Brown              | P33                    | 10                    | 33                 | 1 7/16                  | 20             |
| LCCX2-14B-E*  |                     |                   |                     | 1/4                  | 0.75                    | 0.70                    | 1.36 | 0.11 | 3.01 | Brown              | P33                    | 10                    | 33                 | 1 7/16                  | 20             |
| LCCX2-38D-E*  |                     |                   |                     | 3/8                  | 1.00                    | 0.70                    | 1.36 | 0.11 | 3.46 | Brown              | P33                    | 10                    | 33                 | 1 7/16                  | 20             |
| LCCX2-12-E*   |                     |                   |                     | 1/2                  | 1.75                    | 0.75                    | 1.36 | 0.09 | 4.63 | Brown              | P33                    | 10                    | 33                 | 1 7/16                  | 20             |
| LCCX1-14A-X   | #1 AWG              | #1 AWG            | #1 AWG              | 1/4                  | 0.63                    | 0.76                    | 1.44 | 0.12 | 3.07 | Green              | P37                    | 11                    | 37                 | 1 1/2                   | 10             |
| LCCX1-14B-X   |                     |                   |                     | 1/4                  | 0.75                    | 0.76                    | 1.44 | 0.12 | 3.19 | Green              | P37                    | 11                    | 37                 | 1 1/2                   | 10             |
| LCCX1-14D-X   |                     |                   |                     | 1/4                  | 1.00                    | 0.76                    | 1.44 | 0.12 | 3.44 | Green              | P37                    | 11                    | 37                 | 1 1/2                   | 10             |
| LCCX1-56C-X   |                     |                   |                     | 5/16                 | 0.88                    | 0.76                    | 1.44 | 0.12 | 3.37 | Green              | P37                    | 11                    | 37                 | 1 1/2                   | 10             |
| LCCX1-56D-X   |                     |                   |                     | 5/16                 | 1.00                    | 0.76                    | 1.44 | 0.12 | 3.50 | Green              | P37                    | 11                    | 37                 | 1 1/2                   | 10             |
| LCCX1-38D-X   |                     |                   |                     | 3/8                  | 1.00                    | 0.76                    | 1.44 | 0.12 | 3.57 | Green              | P37                    | 11                    | 37                 | 1 1/2                   | 10             |
| LCCX1/0-14A-X | 1/0 AWG             | 1/0 AWG           | 1/0 AWG             | 1/4                  | 0.63                    | 0.85                    | 1.50 | 0.13 | 3.23 | Pink               | P42                    | 12                    | 42                 | 1 9/16                  | 10             |
| LCCX1/0-14B-X |                     |                   |                     | 1/4                  | 0.75                    | 0.85                    | 1.50 | 0.13 | 3.36 | Pink               | P42                    | 12                    | 42                 | 1 9/16                  | 10             |
| LCCX1/0-38D-X |                     |                   |                     | 3/8                  | 1.00                    | 0.85                    | 1.50 | 0.13 | 3.67 | Pink               | P42                    | 12                    | 42                 | 1 9/16                  | 10             |
| LCCX1/0-12-X  |                     |                   |                     | 1/2                  | 1.75                    | 0.85                    | 1.50 | 0.13 | 4.83 | Pink               | P42                    | 12                    | 42                 | 1 9/16                  | 10             |
| LCCX2/0-14A-X | 2/0 AWG             | 2/0 AWG           | 2/0 AWG             | 1/4                  | 0.63                    | 0.96                    | 1.50 | 0.13 | 3.27 | Black              | P45                    | 13                    | 45                 | 1 9/16                  | 10             |
| LCCX2/0-14B-X |                     |                   |                     | 1/4                  | 0.75                    | 0.96                    | 1.50 | 0.13 | 3.39 | Black              | P45                    | 13                    | 45                 | 1 9/16                  | 10             |
| LCCX2/0-38D-X |                     |                   |                     | 3/8                  | 1.00                    | 0.96                    | 1.50 | 0.13 | 3.70 | Black              | P45                    | 13                    | 45                 | 1 9/16                  | 10             |
| LCCX2/0-12-X  |                     |                   |                     | 1/2                  | 1.75                    | 0.96                    | 1.50 | 0.13 | 4.87 | Black              | P45                    | 13                    | 45                 | 1 9/16                  | 10             |
| LCCX3/0-14B-X | 3/0 AWG             | 3/0 AWG           | 3/0 AWG             | 1/4                  | 0.75                    | 1.06                    | 1.56 | 0.14 | 3.48 | Orange             | P50                    | 14                    | 50                 | 1 5/8                   | 10             |
| LCCX3/0-38D-X |                     |                   |                     | 3/8                  | 1.00                    | 1.06                    | 1.56 | 0.14 | 3.81 | Orange             | P50                    | 14                    | 50                 | 1 5/8                   | 10             |
| LCCX4/0-14B-X | 4/0 AWG             | 4/0 AWG           | 4/0 AWG             | 1/4                  | 0.75                    | 1.19                    | 2.24 | 0.16 | 4.07 | Purple             | P54                    | 15                    | 54                 | 2 5/16                  | 10             |
| LCCX4/0-38D-X |                     |                   |                     | 3/8                  | 1.00                    | 1.19                    | 2.24 | 0.16 | 4.55 | Purple             | P54                    | 15                    | 54                 | 2 5/16                  | 10             |
| LCCX4/0-12-X  |                     |                   |                     | 1/2                  | 1.75                    | 1.19                    | 2.24 | 0.16 | 5.73 | Purple             | P54                    | 15                    | 54                 | 2 5/16                  | 10             |
| LCCX250-14B-X | 250 kcmil           | 262.6 kcmil       | —                   | 1/4                  | 0.75                    | 1.28                    | 2.24 | 0.17 | 4.11 | Yellow             | P62                    | 16                    | 62                 | 2 5/16                  | 10             |
| LCCX250-38D-X |                     |                   |                     | 3/8                  | 1.00                    | 1.28                    | 2.24 | 0.17 | 4.59 | Yellow             | P62                    | 16                    | 62                 | 2 5/16                  | 10             |
| LCCX250-12-X  |                     |                   |                     | 1/2                  | 1.75                    | 1.28                    | 2.24 | 0.17 | 5.77 | Yellow             | P62                    | 16                    | 62                 | 2 5/16                  | 10             |
| LCCX300-38D-6 | 300 kcmil           | 313.1 kcmil       | —                   | 3/8                  | 1.00                    | 1.39                    | 2.30 | 0.18 | 4.67 | Red                | P71                    | 18                    | 71H                | 2 3/8                   | 6              |
| LCCX350-14B-6 | 350 kcmil           | 373.7 kcmil       | —                   | 1/4                  | 0.75                    | 1.54                    | 2.50 | 0.22 | 4.47 | Blue               | P76                    | 19                    | 76H                | 2 9/16                  | 6              |
| LCCX350-38D-6 |                     |                   |                     | 3/8                  | 1.00                    | 1.54                    | 2.50 | 0.22 | 4.95 | Blue               | P76                    | 19                    | 76H                | 2 9/16                  | 6              |
| LCCX350-12-6  |                     |                   |                     | 1/2                  | 1.75                    | 1.54                    | 2.50 | 0.22 | 6.13 | Blue               | P76                    | 19                    | 76H                | 2 9/16                  | 6              |
| LCCX450-12-6  | 450 kcmil           | 444.4 kcmil       | —                   | 1/2                  | 1.75                    | 1.70                    | 2.69 | 0.26 | 6.37 | Brown              | P87                    | 20                    | 87                 | 2 3/4                   | 6              |
| LCCX500-38D-6 | 500 kcmil           | 535.3 kcmil       | —                   | 3/8                  | 1.00                    | 1.89                    | 2.88 | 0.26 | 5.72 | Pink               | P99                    | L99                   | 99H                | 2 15/16                 | 6              |
| LCCX500-12-6  |                     |                   |                     | 1/2                  | 1.75                    | 1.89                    | 2.88 | 0.26 | 6.66 | Pink               | P99                    | L99                   | 99H                | 2 15/16                 | 6              |
| LCCX650-12-6  |                     |                   |                     | —                    | 646.4 kcmil             | —                       | 1/2  | 1.75 | 1.95 | 2.94               | 0.30                   | 6.75                  | Black              | P106                    | 24             |

‡See pages D3.70 – D3.73 for tool and die information.

\*Not UL Listed or CSA Certified with Class K flex conductor when crimped with Burndy tools.

\*\*Consult cable manufacturer for voltage stress relief instructions with applications greater than 2000 V.

^Slotted lug, refer to Figure 2.

◆NEMA hole sizes and spacing.

A. System Overview

B1. Cable Ties

B2. Cable Accessories

B3. Stainless Steel Ties

C1. Wiring Duct

C2. Surface Raceway

C3. Abrasion Protection

C4. Cable Management

D1. Terminals

D2. Power Connectors

D3. Grounding Connectors

E1. Labeling Systems

E2. Labels

E3. Pre-Printed & Write-On Markers

E4. Permanent Identification

E5. Lockout/Tagout & Safety Solutions

F. Index

A. System Overview



## Flex Conductor, Two-Hole, Long Barrel with Window Lug, 45° Angle

B1. Cable Ties

**For Use with Flexible, Extra-Flexible, and Code Stranded Copper Conductors**

### Type LCCX-H

B2. Cable Accessories

- Can be used with code conductor and flex conductor class: G, H, I, K, M and Diesel Locomotive
- Long barrel maximizes number of crimps and provides premium wire pull-out strength and electrical performance
- Generously beveled wire entry prevents bent back strands when inserting conductor into barrel
- Color-coded barrels marked with Panduit and specified competitor die index numbers for proper crimp die selection

- Inspection window to visually assure full conductor insertion
- Tin-plated to inhibit corrosion
- UL Listed and CSA Certified to 35 KV\*\* and temperature rated to 90°C when crimped with Panduit and specified competitor crimping tools and dies
- Meets J-STD-607-A and TIA-942 requirements for network systems grounding applications
- Available with NEMA hole sizes and spacing

C1. Wiring Duct



C2. Surface Raceway

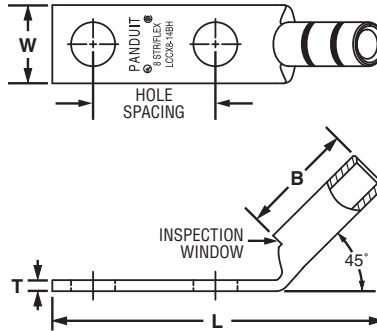

C3. Abrasion Protection

C4. Cable Management

D1. Terminals

D2. Power Connectors

D3. Grounding Connectors

E1. Labeling Systems

E2. Labels

E3. Pre-Printed & Write-On Markers

E4. Permanent Identification

E5. Lockout/Tagout & Safety Solutions

F. Index

| Part Number   | Flex Conductor Size |                   | Code Conductor Size | Stud Hole Size (In.) | Stud Hole Spacing (In.) | Figure Dimensions (In.) |      |     |      | Panduit Color Code | Panduit Die Index No.‡ | Burdny Die Index No.‡ | T&B Die Index No.‡ | Wire Strip Length (In.) | Std. Pkg. Qty. |
|---------------|---------------------|-------------------|---------------------|----------------------|-------------------------|-------------------------|------|-----|------|--------------------|------------------------|-----------------------|--------------------|-------------------------|----------------|
|               | Class G, H, I, K, M | Diesel Locomotive |                     |                      |                         | W                       | B    | T   | L    |                    |                        |                       |                    |                         |                |
| LCCX8-10AH-L  | #8 AWG              | #8 AWG            | #8 AWG              | #10                  | .63                     | .41                     | .70  | .08 | 1.82 | Red                | P21                    | 49                    | 21                 | 3/4                     | 50             |
| LCCX8-10BH-L  |                     |                   |                     | #10                  | .75                     | .41                     | .70  | .08 | 1.95 | Red                | P21                    | 49                    | 21                 | 3/4                     | 50             |
| LCCX8-14AH-L  |                     |                   |                     | 1/4                  | .63                     | .48                     | .70  | .07 | 1.91 | Red                | P21                    | 49                    | 21                 | 3/4                     | 50             |
| LCCX8-14BH-L  |                     |                   |                     | 1/4                  | .75                     | .48                     | .70  | .07 | 2.03 | Red                | P21                    | 49                    | 21                 | 3/4                     | 50             |
| LCCX8-14DH-L  |                     |                   |                     | 1/4                  | 1.00                    | .48                     | .70  | .07 | 2.28 | Red                | P21                    | 49                    | 21                 | 3/4                     | 50             |
| LCCX8-38DH-L  |                     |                   |                     | 3/8                  | 1.00                    | .60                     | .70  | .05 | 2.49 | Red                | P21                    | 49                    | 21                 | 3/4                     | 50             |
| LCCX6-10BH-L  | #6 AWG              | #6 AWG            | #6 AWG              | #10                  | .75                     | .46                     | 1.07 | .08 | 2.22 | Blue               | P24                    | 7                     | 24                 | 1 1/8                   | 50             |
| LCCX6-14AH-L  |                     |                   |                     | 1/4                  | .63                     | .48                     | 1.07 | .08 | 2.18 | Blue               | P24                    | 7                     | 24                 | 1 1/8                   | 50             |
| LCCX6-14BH-L  |                     |                   |                     | 1/4                  | .75                     | .48                     | 1.07 | .08 | 2.31 | Blue               | P24                    | 7                     | 24                 | 1 1/8                   | 50             |
| LCCX6-14DH-L  |                     |                   |                     | 1/4                  | 1.00                    | .48                     | 1.07 | .08 | 2.56 | Blue               | P24                    | 7                     | 24                 | 1 1/8                   | 50             |
| LCCX6-38AH-L  |                     |                   |                     | 3/8                  | .63                     | .62                     | 1.07 | .06 | 2.39 | Blue               | P24                    | 7                     | 24                 | 1 1/8                   | 50             |
| LCCX6-38CH-L  |                     |                   |                     | 3/8                  | .88                     | .62                     | 1.07 | .06 | 2.64 | Blue               | P24                    | 7                     | 24                 | 1 1/8                   | 50             |
| LCCX6-38DH-L  | 3/8                 | 1.00              | .62                 | 1.07                 | .06                     | 2.77                    | Blue | P24 | 7    | 24                 | 1 1/8                  | 50                    |                    |                         |                |
| LCCX4-14AH-L  | #4 AWG              | #5, #4, #3 AWG    | #4 AWG              | 1/4                  | .63                     | .55                     | 1.05 | .09 | 2.20 | Gray               | P29                    | 8                     | 29                 | 1 1/8                   | 50             |
| LCCX4-14BH-L  |                     |                   |                     | 1/4                  | .75                     | .55                     | 1.05 | .09 | 2.32 | Gray               | P29                    | 8                     | 29                 | 1 1/8                   | 50             |
| LCCX4-38BH-L  |                     |                   |                     | 3/8                  | .75                     | .62                     | 1.05 | .08 | 2.54 | Gray               | P29                    | 8                     | 29                 | 1 1/8                   | 50             |
| LCCX4-38DH-L  |                     |                   |                     | 3/8                  | 1.00                    | .62                     | 1.05 | .08 | 2.79 | Gray               | P29                    | 8                     | 29                 | 1 1/8                   | 20             |
| LCCX2-14AH-E* | #2 AWG              | #2 AWG            | #2 AWG              | 1/4                  | .63                     | .70                     | 1.36 | .11 | 2.46 | Brown              | P33                    | 10                    | 33                 | 1 7/16                  | 20             |
| LCCX2-14BH-E* |                     |                   |                     | 1/4                  | .75                     | .70                     | 1.36 | .11 | 2.58 | Brown              | P33                    | 10                    | 33                 | 1 7/16                  | 20             |
| LCCX2-38DH-E* |                     |                   |                     | 3/8                  | 1.00                    | .70                     | 1.36 | .11 | 3.04 | Brown              | P33                    | 10                    | 33                 | 1 7/16                  | 20             |
| LCCX2-12H-E*  |                     |                   |                     | 1/2                  | 1.75                    | .75                     | 1.36 | .09 | 4.20 | Brown              | P33                    | 10                    | 33                 | 1 7/16                  | 10             |
| LCCX1-14AH-X  | #1 AWG              | #1 AWG            | #1 AWG              | 1/4                  | .63                     | .76                     | 1.44 | .12 | 2.61 | Green              | P37                    | 11                    | 37                 | 1 1/2                   | 10             |
| LCCX1-14BH-X  |                     |                   |                     | 1/4                  | .75                     | .76                     | 1.44 | .12 | 2.73 | Green              | P37                    | 11                    | 37                 | 1 1/2                   | 10             |
| LCCX1-14DH-X  |                     |                   |                     | 1/4                  | 1.00                    | .76                     | 1.44 | .12 | 2.98 | Green              | P37                    | 11                    | 37                 | 1 1/2                   | 10             |
| LCCX1-56CH-X  |                     |                   |                     | 5/16                 | .88                     | .76                     | 1.44 | .12 | 2.91 | Green              | P37                    | 11                    | 37                 | 1 1/2                   | 10             |
| LCCX1-56DH-X  |                     |                   |                     | 5/16                 | 1.00                    | .76                     | 1.44 | .12 | 3.04 | Green              | P37                    | 11                    | 37                 | 1 1/2                   | 10             |
| LCCX1-38DH-X  |                     |                   |                     | 3/8                  | 1.00                    | .76                     | 1.44 | .12 | 3.11 | Green              | P37                    | 11                    | 37                 | 1 1/2                   | 10             |

‡See pages D3.70 – D3.73 for tool and die information.

\*Not UL Listed or CSA Certified with Class K flex conductor when crimped with Burdny tools.

\*\*Consult cable manufacturer for voltage stress relief instructions with applications greater than 2000 V.

◆NEMA hole sizes and spacing.



## Flex Conductor, Two-Hole, Long Barrel with Window Lug, 45° Angle (continued)

| Part Number    | Flex Conductor Size |                   | Code Conductor Size | Stud Hole Size (In.) | Stud Hole Spacing (In.) | Figure Dimensions (In.) |      |     |      | Panduit Color Code | Panduit Die Index No.‡ | Burndy Die Index No.‡ | T&B Die Index No.‡ | Wire Strip Length (In.) | Std. Pkg. Qty. |
|----------------|---------------------|-------------------|---------------------|----------------------|-------------------------|-------------------------|------|-----|------|--------------------|------------------------|-----------------------|--------------------|-------------------------|----------------|
|                | Class G, H, I, K, M | Diesel Locomotive |                     |                      |                         | W                       | B    | T   | L    |                    |                        |                       |                    |                         |                |
|                |                     |                   |                     |                      |                         |                         |      |     |      |                    |                        |                       |                    |                         |                |
| LCCX1/0-14AH-X | 1/0 AWG             | 1/0 AWG           | 1/0 AWG             | 1/4                  | .63                     | .85                     | 1.50 | .13 | 2.76 | Pink               | P42                    | 12                    | 42                 | 1 9/16                  | 10             |
| LCCX1/0-14BH-X |                     |                   |                     | 1/4                  | .75                     | .85                     | 1.50 | .13 | 2.88 | Pink               | P42                    | 12                    | 42                 | 1 9/16                  | 10             |
| LCCX1/0-38DH-X |                     |                   |                     | 3/8                  | 1.00                    | .85                     | 1.50 | .13 | 3.20 | Pink               | P42                    | 12                    | 42                 | 1 9/16                  | 10             |
| LCCX1/0-12H-X  |                     |                   |                     | 1/2                  | 1.75                    | .85                     | 1.50 | .13 | 4.36 | Pink               | P42                    | 12                    | 42                 | 1 9/16                  | 10             |
| LCCX2/0-14AH-X | 2/0 AWG             | 2/0 AWG           | 2/0 AWG             | 1/4                  | .63                     | .96                     | 1.50 | .13 | 2.78 | Black              | P45                    | 13                    | 45                 | 1 9/16                  | 10             |
| LCCX2/0-14BH-X |                     |                   |                     | 1/4                  | .75                     | .96                     | 1.50 | .13 | 2.91 | Black              | P45                    | 13                    | 45                 | 1 9/16                  | 10             |
| LCCX2/0-38DH-X |                     |                   |                     | 3/8                  | 1.00                    | .96                     | 1.50 | .13 | 3.22 | Black              | P45                    | 13                    | 45                 | 1 9/16                  | 10             |
| LCCX2/0-12H-X  |                     |                   |                     | 1/2                  | 1.75                    | .96                     | 1.50 | .13 | 4.38 | Black              | P45                    | 13                    | 45                 | 1 9/16                  | 10             |
| LCCX3/0-14BH-X | 3/0 AWG             | 3/0 AWG           | 3/0 AWG             | 1/4                  | .75                     | 1.06                    | 1.56 | .14 | 2.98 | Orange             | P50                    | 14                    | 50                 | 1 5/8                   | 10             |
| LCCX3/0-38DH-X |                     |                   |                     | 3/8                  | 1.00                    | 1.06                    | 1.56 | .14 | 3.31 | Orange             | P50                    | 14                    | 50                 | 1 5/8                   | 10             |
| LCCX4/0-14BH-X | 4/0 AWG             | 4/0 AWG           | 4/0 AWG             | 1/4                  | .75                     | 1.19                    | 2.24 | .16 | 3.45 | Purple             | P54                    | 15                    | 54                 | 2 5/16                  | 10             |
| LCCX4/0-38DH-X |                     |                   |                     | 3/8                  | 1.00                    | 1.19                    | 2.24 | .16 | 3.93 | Purple             | P54                    | 15                    | 54                 | 2 5/16                  | 10             |
| LCCX4/0-12H-X  |                     |                   |                     | 1/2                  | 1.75                    | 1.19                    | 2.24 | .16 | 5.11 | Purple             | P54                    | 15                    | 54                 | 2 5/16                  | 10             |
| LCCX250-14BH-X | 250 kcmil           | 262.6 kcmil       | —                   | 1/4                  | .75                     | 1.28                    | 2.24 | .17 | 3.48 | Yellow             | P62                    | 16                    | 62                 | 2 5/16                  | 10             |
| LCCX250-38DH-X |                     |                   |                     | 3/8                  | 1.00                    | 1.28                    | 2.24 | .17 | 3.96 | Yellow             | P62                    | 16                    | 62                 | 2 5/16                  | 6              |
| LCCX300-38DH-6 | 300 kcmil           | 313.1 kcmil       | —                   | 3/8                  | 1.00                    | 1.39                    | 2.30 | .18 | 4.07 | Red                | P71                    | 18                    | 71H                | 2 3/8                   | 6              |
| LCCX350-14BH-6 | 350 kcmil           | 373.7 kcmil       | —                   | 1/4                  | .75                     | 1.54                    | 2.50 | .22 | 3.81 | Blue               | P76                    | 19                    | 76H                | 2 9/16                  | 6              |
| LCCX350-38DH-6 |                     |                   |                     | 3/8                  | 1.00                    | 1.54                    | 2.50 | .22 | 4.29 | Blue               | P76                    | 19                    | 76H                | 2 9/16                  | 6              |
| LCCX350-12H-6  |                     |                   |                     | 1/2                  | 1.75                    | 1.54                    | 2.50 | .22 | 5.47 | Blue               | P76                    | 19                    | 76H                | 2 9/16                  | 6              |

‡See pages D3.70 – D3.73 for tool and die information.

\*Not UL Listed or CSA Certified with Class K flex conductor when crimped with Burndy tools.

\*\*Consult cable manufacturer for voltage stress relief instructions with applications greater than 2000 V.

◆NEMA hole sizes and spacing.

A. System Overview

B1. Cable Ties

B2. Cable Accessories

B3. Stainless Steel Ties

C1. Wiring Duct

C2. Surface Raceway

C3. Abrasion Protection

C4. Cable Management

D1. Terminals

D2. Power Connectors

D3. Grounding Connectors

E1. Labeling Systems

E2. Labels

E3. Pre-Printed & Write-On Markers

E4. Permanent Identification

E5. Lockout/Tagout & Safety Solutions

F. Index

A. System Overview

**UL LISTED US** **CSA CERTIFIED** **Flex Conductor, Two-Hole, Long Barrel with Window Lug, 90° Angle**

B1. Cable Ties

**For Use with Flexible, Extra-Flexible, and Code Stranded Copper Conductors**

**Type LCCX-F**

- Can be used with code conductor and flex conductor class: G, H, I, K, M and Diesel Locomotive
- Long barrel maximizes number of crimps and provides premium wire pull-out strength and electrical performance
- Generously beveled wire entry prevents bent back strands when inserting conductor into barrel
- Color-coded barrels marked with Panduit and specified competitor die index numbers for proper crimp die selection
- Inspection window to visually assure full conductor insertion
- Tin-plated to inhibit corrosion
- UL Listed and CSA Certified to 35 KV\*\* and temperature rated to 90°C when crimped with Panduit and specified competitor crimping tools and dies
- Meets J-STD-607-A and TIA-942 requirements for network systems grounding applications
- Available with NEMA hole sizes and spacing

B2. Cable Accessories

B3. Stainless Steel Ties

C1. Wiring Duct

C2. Surface Raceway

C3. Abrasion Protection

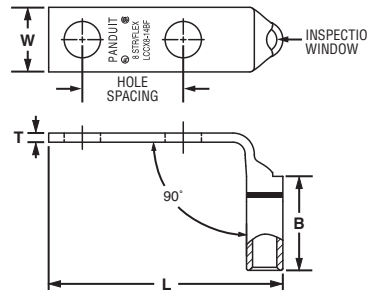

C4. Cable Management

D1. Terminals

D2. Power Connectors

D3. Grounding Connectors

E1. Labeling Systems

E2. Labels

E3. Pre-Printed & Write-On Markers

E4. Permanent Identification

E5. Lockout/Tagout & Safety Solutions

F. Index

| Part Number    | Flex Conductor Size |                   | Code Conductor Size | Stud Hole Size (In.) | Stud Hole Spacing (In.) | Figure Dimensions (In.) |      |     |      | Panduit Color Code | Panduit Die Index No.‡ | Burndy Die Index No. | T&B Die Index No. | Wire Strip Length (In.) | Std. Pkg. Qty. |
|----------------|---------------------|-------------------|---------------------|----------------------|-------------------------|-------------------------|------|-----|------|--------------------|------------------------|----------------------|-------------------|-------------------------|----------------|
|                | Class G, H, I, K, M | Diesel Locomotive |                     |                      |                         | W                       | B    | T   | L    |                    |                        |                      |                   |                         |                |
| LCCX8-10AF-L   |                     |                   |                     | #10                  | .63                     | .41                     | .70  | .08 | 1.53 | Red                | P21                    | 49                   | 21                | 3/4                     | 50             |
| LCCX8-10BF-L   |                     |                   |                     | #10                  | .75                     | .41                     | .70  | .08 | 1.65 | Red                | P21                    | 49                   | 21                | 3/4                     | 50             |
| LCCX8-14AF-L   | #8 AWG              | #8 AWG            | #8 AWG              | 1/4                  | .63                     | .48                     | .70  | .07 | 1.62 | Red                | P21                    | 49                   | 21                | 3/4                     | 50             |
| LCCX8-14BF-L   |                     |                   |                     | 1/4                  | .75                     | .48                     | .70  | .07 | 1.74 | Red                | P21                    | 49                   | 21                | 3/4                     | 50             |
| LCCX8-14DF-L   |                     |                   |                     | 1/4                  | 1.00                    | .48                     | .70  | .07 | 1.99 | Red                | P21                    | 49                   | 21                | 3/4                     | 50             |
| LCCX8-38DF-L   |                     |                   |                     | 3/8                  | 1.00                    | .60                     | .70  | .05 | 2.21 | Red                | P21                    | 49                   | 21                | 3/4                     | 50             |
| LCCX6-10BF-L   | #6 AWG              | #6 AWG            | #6 AWG              | #10                  | .75                     | .46                     | 1.07 | .08 | 1.69 | Blue               | P24                    | 7                    | 24                | 1 1/8                   | 50             |
| LCCX6-14AF-L   |                     |                   |                     | 1/4                  | .63                     | .48                     | 1.07 | .08 | 1.66 | Blue               | P24                    | 7                    | 24                | 1 1/8                   | 50             |
| LCCX6-14BF-L   |                     |                   |                     | 1/4                  | .75                     | .48                     | 1.07 | .08 | 1.78 | Blue               | P24                    | 7                    | 24                | 1 1/8                   | 50             |
| LCCX6-14DF-L   |                     |                   |                     | 1/4                  | 1.00                    | .48                     | 1.07 | .08 | 2.03 | Blue               | P24                    | 7                    | 24                | 1 1/8                   | 50             |
| LCCX6-38AF-L   | #6 AWG              | #6 AWG            | #6 AWG              | 3/8                  | .63                     | .62                     | 1.07 | .06 | 1.88 | Blue               | P24                    | 7                    | 24                | 1 1/8                   | 50             |
| LCCX6-38CF-L   |                     |                   |                     | 3/8                  | .88                     | .62                     | 1.07 | .06 | 2.13 | Blue               | P24                    | 7                    | 24                | 1 1/8                   | 50             |
| LCCX6-38DF-L   |                     |                   |                     | 3/8                  | 1.00                    | .62                     | 1.07 | .06 | 2.25 | Blue               | P24                    | 7                    | 24                | 1 1/8                   | 50             |
| LCCX4-14AF-L   |                     |                   |                     | #4 AWG               | #5, #4, #3 AWG          | #4 AWG                  | 1/4  | .63 | .55  | 1.05               | .09                    | 1.74                 | Gray              | P29                     | 8              |
| LCCX4-14BF-L   | 1/4                 | .75               | .55                 |                      |                         |                         | 1.05 | .09 | 1.87 | Gray               | P29                    | 8                    | 29                | 1 1/8                   | 50             |
| LCCX4-38BF-L   | 3/8                 | .75               | .62                 |                      |                         |                         | 1.05 | .08 | 2.09 | Gray               | P29                    | 8                    | 29                | 1 1/8                   | 50             |
| LCCX4-38DF-L   | 3/8                 | 1.00              | .62                 |                      |                         |                         | 1.05 | .08 | 2.34 | Gray               | P29                    | 8                    | 29                | 1 1/8                   | 50             |
| LCCX2-14AF-E*  | #2 AWG              | #2 AWG            | #2 AWG              | 1/4                  | .63                     | .70                     | 1.36 | .11 | 1.94 | Brown              | P33                    | 10                   | 33                | 1 7/16                  | 20             |
| LCCX2-14BF-E*  |                     |                   |                     | 1/4                  | .75                     | .70                     | 1.36 | .11 | 2.06 | Brown              | P33                    | 10                   | 33                | 1 7/16                  | 20             |
| LCCX2-38DF-E*  |                     |                   |                     | 3/8                  | 1.00                    | .70                     | 1.36 | .11 | 2.51 | Brown              | P33                    | 10                   | 33                | 1 7/16                  | 20             |
| LCCX2-12F-E*   |                     |                   |                     | 1/2                  | 1.75                    | .75                     | 1.36 | .09 | 3.68 | Brown              | P33                    | 10                   | 33                | 1 7/16                  | 20             |
| LCCX1-14AF-X   | #1 AWG              | #1 AWG            | #1 AWG              | 1/4                  | .63                     | .76                     | 1.44 | .12 | 2.08 | Green              | P37                    | 11                   | 37                | 1 1/2                   | 10             |
| LCCX1-14BF-X   |                     |                   |                     | 1/4                  | .75                     | .76                     | 1.44 | .12 | 2.20 | Green              | P37                    | 11                   | 37                | 1 1/2                   | 10             |
| LCCX1-14DF-X   |                     |                   |                     | 1/4                  | 1.00                    | .76                     | 1.44 | .12 | 2.45 | Green              | P37                    | 11                   | 37                | 1 1/2                   | 10             |
| LCCX1-56CF-X   |                     |                   |                     | 5/16                 | .88                     | .76                     | 1.44 | .12 | 2.38 | Green              | P37                    | 11                   | 37                | 1 1/2                   | 10             |
| LCCX1-56DF-X   |                     |                   |                     | 5/16                 | 1.00                    | .76                     | 1.44 | .12 | 2.51 | Green              | P37                    | 11                   | 37                | 1 1/2                   | 10             |
| LCCX1-38DF-X   |                     |                   |                     | 3/8                  | 1.00                    | .76                     | 1.44 | .12 | 2.58 | Green              | P37                    | 11                   | 37                | 1 1/2                   | 10             |
| LCCX1/0-14AF-X | 1/0 AWG             | 1/0 AWG           | 1/0 AWG             | 1/4                  | .63                     | .85                     | 1.50 | .13 | 2.22 | Pink               | P42                    | 12                   | 42                | 1 9/16                  | 10             |
| LCCX1/0-14BF-X |                     |                   |                     | 1/4                  | .75                     | .85                     | 1.50 | .13 | 2.34 | Pink               | P42                    | 12                   | 42                | 1 9/16                  | 10             |
| LCCX1/0-38DF-X |                     |                   |                     | 3/8                  | 1.00                    | .85                     | 1.50 | .13 | 2.66 | Pink               | P42                    | 12                   | 42                | 1 9/16                  | 10             |
| LCCX1/0-12F-X  |                     |                   |                     | 1/2                  | 1.75                    | .85                     | 1.50 | .13 | 3.82 | Pink               | P42                    | 12                   | 42                | 1 9/16                  | 10             |

‡See pages D3.70 – D3.73 for tool and die information.

\*Not UL Listed or CSA Certified with Class K flex conductor when crimped with Burndy tools.

\*\*Consult cable manufacturer for voltage stress relief instructions with applications greater than 2000 V.



## Flex Conductor, Two-Hole, Long Barrel with Window Lug, 90° Angle (continued)

| Part Number    | Flex Conductor Size |                   | Code Conductor Size | Stud Hole Size (In.) | Stud Hole Spacing (In.) | Figure Dimensions (In.) |      |     |      | Panduit Color Code | Panduit Die Index No.‡ | Burndy Die Index No. | T&B Die Index No. | Wire Strip Length (In.) | Std. Pkg. Qty. |
|----------------|---------------------|-------------------|---------------------|----------------------|-------------------------|-------------------------|------|-----|------|--------------------|------------------------|----------------------|-------------------|-------------------------|----------------|
|                | Class G, H, I, K, M | Diesel Locomotive |                     |                      |                         | W                       | B    | T   | L    |                    |                        |                      |                   |                         |                |
| LCCX2/0-14AF-X | 2/0 AWG             | 2/0 AWG           | 2/0 AWG             | 1/4                  | .63                     | .96                     | 1.50 | .13 | 2.29 | Black              | P45                    | 13                   | 45                | 1 9/16                  | 10             |
| LCCX2/0-14BF-X |                     |                   |                     | 1/4                  | .75                     | .96                     | 1.50 | .13 | 2.42 | Black              | P45                    | 13                   | 45                | 1 9/16                  | 10             |
| LCCX2/0-38DF-X |                     |                   |                     | 3/8                  | 1.00                    | .96                     | 1.50 | .13 | 2.73 | Black              | P45                    | 13                   | 45                | 1 9/16                  | 10             |
| LCCX2/0-12F-X  |                     |                   |                     | 1/2                  | 1.75                    | .96                     | 1.50 | .13 | 3.89 | Black              | P45                    | 13                   | 45                | 1 9/16                  | 10             |
| LCCX3/0-14BF-X | 3/0 AWG             | 3/0 AWG           | 3/0 AWG             | 1/4                  | .75                     | 1.06                    | 1.56 | .14 | 2.50 | Orange             | P50                    | 14                   | 50                | 1 5/8                   | 10             |
| LCCX3/0-38DF-X |                     |                   |                     | 3/8                  | 1.00                    | 1.06                    | 1.56 | .14 | 2.84 | Orange             | P50                    | 14                   | 50                | 1 5/8                   | 10             |
| LCCX4/0-14BF-X | 4/0 AWG             | 4/0 AWG           | 4/0 AWG             | 1/4                  | .75                     | 1.19                    | 2.24 | .16 | 2.69 | Purple             | P54                    | 15                   | 54                | 2 5/16                  | 10             |
| LCCX4/0-38DF-X |                     |                   |                     | 3/8                  | 1.00                    | 1.19                    | 2.24 | .16 | 2.88 | Purple             | P54                    | 15                   | 54                | 2 5/16                  | 10             |
| LCCX4/0-12F-X  |                     |                   |                     | 1/2                  | 1.75                    | 1.19                    | 2.24 | .16 | 4.06 | Purple             | P54                    | 15                   | 54                | 2 5/16                  | 10             |
| LCCX250-14BF-X | 250 kcmil           | 262.6 kcmil       | —                   | 1/4                  | .75                     | 1.28                    | 2.24 | .17 | 2.46 | Yellow             | P62                    | 16                   | 62                | 2 5/16                  | 10             |
| LCCX250-38DF-X |                     |                   |                     | 3/8                  | 1.00                    | 1.28                    | 2.24 | .17 | 2.94 | Yellow             | P62                    | 16                   | 62                | 2 5/16                  | 10             |
| LCCX300-38DF-6 | 300 kcmil           | 313.1 kcmil       | —                   | 3/8                  | 1.00                    | 1.39                    | 2.30 | .18 | 3.02 | Red                | P71                    | 18                   | 71H               | 2 3/8                   | 6              |
| LCCX350-14BF-6 | 350 kcmil           | 373.7 kcmil       | —                   | 1/4                  | .75                     | 1.54                    | 2.50 | .22 | 2.65 | Blue               | P76                    | 19                   | 76H               | 2 9/16                  | 6              |
| LCCX350-38DF-6 |                     |                   |                     | 3/8                  | 1.00                    | 1.54                    | 2.50 | .22 | 3.13 | Blue               | P76                    | 19                   | 76H               | 2 9/16                  | 6              |
| LCCX350-12F-6  |                     |                   |                     | 1/2                  | 1.75                    | 1.54                    | 2.50 | .22 | 4.31 | Blue               | P76                    | 19                   | 76H               | 2 9/16                  | 6              |

‡See pages D3.70 – D3.73 for tool and die information.

\*Not UL Listed or CSA Certified with Class K flex conductor when crimped with Burndy tools.

\*\*Consult cable manufacturer for voltage stress relief instructions with applications greater than 2000 V.

◆NEMA hole sizes and spacing.



## Flex Conductor, Two-Hole, Long Barrel with Window, Narrow Tongue Lug

For use with Flexible and Extra-Flexible Stranded Copper Copper Conductors

- Narrow tongue width for limited space applications
- Can be used with flex conductor class: G, H, I, K, M and Diesel Locomotive
- Long barrel maximizes number of crimps and provides premium wire pull-out strength and electrical performance
- Generously beveled wire entry prevents bent back strands when inserting conductor into barrel
- Color-coded barrels marked with Panduit and specified competitor die index numbers for proper crimp die selection
- Inspection window to visually assure full conductor insertion
- Tin-plated to inhibit corrosion
- UL Listed and CSA Certified to 35 KV\*\* and temperature rated to 90°C when crimped with Panduit and specified competitor crimping tools and dies
- Meets J-STD-607-A and TIA-942 requirements for network systems grounding applications
- Available with NEMA hole sizes and spacing



| Part Number     | Flex Conductor Size |                   | Stud Hole Size (In.) | Stud Hole Spacing (In.) | Figure Dimensions (In.) |      |      |      | Panduit Color Code | Panduit Die Index No.‡ | Burndy Die Index No.‡ | T&B Die Index No.‡ | Wire Strip Length (In.) | Std. Pkg. Qty. |
|-----------------|---------------------|-------------------|----------------------|-------------------------|-------------------------|------|------|------|--------------------|------------------------|-----------------------|--------------------|-------------------------|----------------|
|                 | Class G, H, I, K, M | Diesel Locomotive |                      |                         | W                       | B    | T    | L    |                    |                        |                       |                    |                         |                |
| ◆ LCCXN450-12-6 | 450 kcmil           | 444.4 kcmil       | 1/2                  | 1.75                    | 1.19                    | 2.69 | 0.33 | 6.41 | Brown              | P87                    | 20                    | 87H                | 2 3/4                   | 6              |
| ◆ LCCXN500-12-6 | 500 kcmil           | 535.3 kcmil       | 1/2                  | 1.75                    | 1.30                    | 2.88 | 0.32 | 6.71 | Pink               | P99                    | L99                   | 99H                | 2 15/16                 | 6              |
| ◆ LCCXN650-12-6 | —                   | 646.4 kcmil       | 1/2                  | 1.75                    | 1.35                    | 2.94 | 0.36 | 6.78 | Black              | P106                   | 24                    | 106                | 3                       | 6              |

‡See pages D3.70 – D3.73 for tool and die information.

\*\*Consult cable manufacturer for voltage stress relief instructions with applications greater than 2000 V.

◆NEMA hole sizes and spacing.

A. System Overview



## Flex Conductor, Two-Hole, Long Barrel, Flared NEBS Lug

B1. Cable Ties

**For Use with Flexible and Extra-Flexible Copper Conductors**

### Type LCCF

- Can be used with flex conductor class: K, M, and Diesel Locomotive
- Enclosed barrel prevents corrosive material from entering barrel when used in harsh environments
- Long barrel maximizes the number of crimps and provides premium wire pull-out strength and electrical performance
- Tin-plated to inhibit corrosion
- Flared entry prevents bent back strands when inserting fine strand conductor into barrel
- UL Listed and CSA Certified to 35 KV\*\* and temperature rated to 90°C when crimped with Panduit crimping tools and dies
- Color-coded barrels marked with Panduit die index numbers for proper crimp die selection
- **Tested by Telcordia – meets NEBS Level 3**
- Available with NEMA hole sizes and spacing

B3. Stainless Steel Ties

C1. Wiring Duct

C2. Surface Raceway

C3. Abrasion Protection

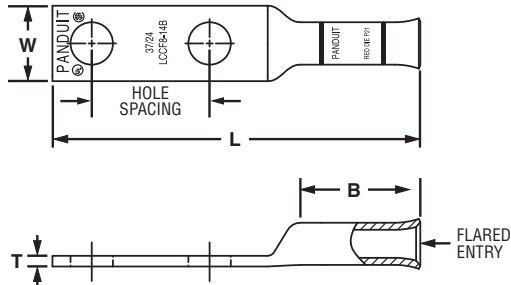

C4. Cable Management

| Part Number        | Flex Conductor Size |                   | Stud Hole Size (In.) | Stud Hole Spacing (In.) | Figure Dimensions (In.) |      |     |      | Panduit Color Code | Panduit Die Index No.‡ | Wire Strip Length (In.) | Std. Pkg. Qty. |
|--------------------|---------------------|-------------------|----------------------|-------------------------|-------------------------|------|-----|------|--------------------|------------------------|-------------------------|----------------|
|                    | Class K and M       | Diesel Locomotive |                      |                         | W                       | B    | T   | L    |                    |                        |                         |                |
| LCCF8-14A-L        | —                   | #8 AWG            | 1/4                  | .63                     | .48                     | .76  | .07 | 2.22 | Red                | P21                    | 13/16                   | 50             |
| LCCF8-14B-L        |                     |                   | 1/4                  | .75                     | .48                     | .76  | .07 | 2.34 | Red                | P21                    | 13/16                   | 50             |
| LCCF8-38D-L        |                     |                   | 3/8                  | 1.00                    | .60                     | .76  | .05 | 2.81 | Red                | P21                    | 13/16                   | 50             |
| <b>LCCF6-14A-L</b> | #6 AWG              | #6 AWG            | 1/4                  | .63                     | .48                     | 1.22 | .08 | 2.71 | Blue               | P24                    | 1 5/16                  | 50             |
| <b>LCCF6-14B-L</b> |                     |                   | 1/4                  | .75                     | .48                     | 1.22 | .08 | 2.83 | Blue               | P24                    | 1 5/16                  | 50             |
| LCCF6-38D-L        |                     |                   | 3/8                  | 1.00                    | .62                     | 1.22 | .06 | 3.30 | Blue               | P24                    | 1 5/16                  | 50             |
| <b>LCCF4-14A-L</b> | #4 AWG              | #4 AWG            | 1/4                  | .63                     | .55                     | 1.23 | .09 | 2.75 | Gray               | P29                    | 1 5/16                  | 50             |
| LCCF4-14B-L        |                     |                   | 1/4                  | .75                     | .55                     | 1.23 | .09 | 2.88 | Gray               | P29                    | 1 5/16                  | 50             |
| LCCF4-38D-L        |                     |                   | 3/8                  | 1.00                    | .62                     | 1.23 | .08 | 3.35 | Gray               | P29                    | 1 5/16                  | 50             |
| <b>LCCF2-14A-E</b> | #2 AWG              | #2 AWG            | 1/4                  | .63                     | .70                     | 1.36 | .11 | 3.00 | Brown              | P33                    | 1 7/16                  | 20             |
| LCCF2-14B-E        |                     |                   | 1/4                  | .75                     | .70                     | 1.36 | .11 | 3.12 | Brown              | P33                    | 1 7/16                  | 20             |
| LCCF2-56B-E        |                     |                   | 5/16                 | .75                     | .70                     | 1.36 | .11 | 3.25 | Brown              | P33                    | 1 7/16                  | 20             |
| <b>LCCF2-38D-E</b> |                     |                   | 3/8                  | 1.00                    | .70                     | 1.36 | .11 | 3.57 | Brown              | P33                    | 1 7/16                  | 20             |
| LCCF2-12-E         |                     |                   | 1/2                  | 1.75                    | .75                     | 1.36 | .09 | 4.74 | Brown              | P33                    | 1 7/16                  | 20             |
| LCCF1-14A-X        | #1 AWG              | #1 AWG            | 1/4                  | .63                     | .76                     | 1.44 | .12 | 3.18 | Pink               | P42                    | 1 1/2                   | 10             |
| LCCF1-14B-X        |                     |                   | 1/4                  | .75                     | .76                     | 1.44 | .12 | 3.31 | Pink               | P42                    | 1 1/2                   | 10             |
| LCCF1-56C-X        |                     |                   | 5/16                 | .88                     | .76                     | 1.44 | .12 | 3.49 | Pink               | P42                    | 1 1/2                   | 10             |
| LCCF1-38D-X        |                     |                   | 3/8                  | 1.00                    | .76                     | 1.44 | .12 | 3.69 | Pink               | P42                    | 1 1/2                   | 10             |
| LCCF1-12-X         |                     |                   | 1/2                  | 1.75                    | .80                     | 1.44 | .12 | 4.86 | Pink               | P42                    | 1 1/2                   | 10             |

‡See pages D3.74, D3.75 for tool and die information.

\*\*Consult cable manufacturer for voltage stress relief instructions with applications greater than 2000 V.

◆NEMA hole sizes and spacing.

E3. Pre-Printed & Write-On Markers

E4. Permanent Identification

E5. Lockout/Tagout & Safety Solutions

F. Index





## Flex Conductor, Two-Hole, Long Barrel, Flared NEBS Lug (continued)

| Part Number          | Flex Conductor Size |                   | Stud Hole Size (In.) | Stud Hole Spacing (In.) | Figure Dimensions (In.) |      |     |      | Panduit Color Code | Panduit Die Index No.‡ | Wire Strip Length (In.) | Std. Pkg. Qty. |
|----------------------|---------------------|-------------------|----------------------|-------------------------|-------------------------|------|-----|------|--------------------|------------------------|-------------------------|----------------|
|                      | Class K and M       | Diesel Locomotive |                      |                         | W                       | B    | T   | L    |                    |                        |                         |                |
| LCCF1/0-14A-X        | 1/0 AWG             | 1/0 AWG           | 1/4                  | .63                     | .85                     | 1.50 | .13 | 3.38 | Black              | P45                    | 1 9/16                  | 10             |
| LCCF1/0-14B-X        |                     |                   | 1/4                  | .75                     | .85                     | 1.50 | .13 | 3.51 | Black              | P45                    | 1 9/16                  | 10             |
| LCCF1/0-56C-X        |                     |                   | 5/16                 | .88                     | .85                     | 1.50 | .13 | 3.63 | Black              | P45                    | 1 9/16                  | 10             |
| LCCF1/0-38D-X        |                     |                   | 3/8                  | 1.00                    | .85                     | 1.50 | .13 | 3.82 | Black              | P45                    | 1 9/16                  | 10             |
| LCCF1/0-12-X         |                     |                   | 1/2                  | 1.75                    | .85                     | 1.50 | .13 | 4.98 | Black              | P45                    | 1 9/16                  | 10             |
| LCCF2/0-14A-X        | 2/0 AWG             | 2/0 AWG           | 1/4                  | .63                     | .96                     | 1.50 | .13 | 3.43 | Orange             | P50                    | 1 9/16                  | 10             |
| LCCF2/0-14B-X        |                     |                   | 1/4                  | .75                     | .96                     | 1.50 | .13 | 3.56 | Orange             | P50                    | 1 9/16                  | 10             |
| LCCF2/0-38D-X        |                     |                   | 3/8                  | 1.00                    | .96                     | 1.50 | .13 | 3.87 | Orange             | P50                    | 1 9/16                  | 10             |
| LCCF2/0-12-X         |                     |                   | 1/2                  | 1.75                    | .96                     | 1.50 | .13 | 5.03 | Orange             | P50                    | 1 9/16                  | 10             |
| LCCF3/0-14B-X        | 3/0 AWG             | 3/0 AWG           | 1/4                  | .75                     | 1.06                    | 1.56 | .14 | 3.66 | Purple             | P54                    | 1 5/8                   | 10             |
| <b>LCCF3/0-38D-X</b> |                     |                   | 3/8                  | 1.00                    | 1.06                    | 1.56 | .14 | 3.99 | Purple             | P54                    | 1 5/8                   | 10             |
| LCCF3/0-12-X         |                     |                   | 1/2                  | 1.75                    | 1.06                    | 1.56 | .14 | 5.13 | Purple             | P54                    | 1 5/8                   | 10             |
| LCCF4/0-14B-X        | 4/0 AWG             | 4/0 AWG           | 1/4                  | .75                     | 1.17                    | 1.61 | .14 | 3.60 | Yellow             | P62                    | 1 11/16                 | 10             |
| LCCF4/0-38D-X        |                     |                   | 3/8                  | 1.00                    | 1.17                    | 1.61 | .14 | 4.09 | Yellow             | P62                    | 1 11/16                 | 10             |
| LCCF4/0-38-X         |                     |                   | 3/8                  | 1.75                    | 1.17                    | 1.61 | .14 | 4.84 | Yellow             | P62                    | 1 11/16                 | 10             |
| <b>LCCF4/0-12-X</b>  |                     |                   | 1/2                  | 1.75                    | 1.17                    | 1.61 | .14 | 5.23 | Yellow             | P62                    | 1 11/16                 | 10             |
| LCCF250-14B-X        | 250 kcmil           | 262.6 kcmil       | 1/4                  | .75                     | 1.28                    | 2.24 | .17 | 4.33 | White              | P66                    | 2 5/16                  | 10             |
| LCCF250-38D-X        |                     |                   | 3/8                  | 1.00                    | 1.28                    | 2.24 | .17 | 4.81 | White              | P66                    | 2 5/16                  | 10             |
| LCCF250-12E-X        |                     |                   | 1/2                  | 1.25                    | 1.28                    | 2.24 | .17 | 5.49 | White              | P66                    | 2 5/16                  | 10             |
| LCCF250-12-X         |                     |                   | 1/2                  | 1.75                    | 1.28                    | 2.24 | .17 | 5.99 | White              | P66                    | 2 5/16                  | 10             |
| LCCF300-14B-6        | 300 kcmil           | 313.1 kcmil       | 1/4                  | .75                     | 1.38                    | 2.30 | .18 | 4.44 | Red                | P71                    | 2 3/8                   | 6              |
| LCCF300-38D-6        |                     |                   | 3/8                  | 1.00                    | 1.38                    | 2.30 | .18 | 4.92 | Red                | P71                    | 2 3/8                   | 6              |
| LCCF300-12-6         |                     |                   | 1/2                  | 1.75                    | 1.38                    | 2.30 | .18 | 6.10 | Red                | P71                    | 2 3/8                   | 6              |
| LCCF350-14B-6        | 350 kcmil           | 373.7 kcmil       | 1/4                  | .75                     | 1.53                    | 2.50 | .22 | 4.70 | Blue               | P76                    | 2 9/16                  | 6              |
| LCCF350-38D-6        |                     |                   | 3/8                  | 1.00                    | 1.53                    | 2.50 | .22 | 5.18 | Blue               | P76                    | 2 9/16                  | 6              |
| LCCF350-12E-6        |                     |                   | 1/2                  | 1.25                    | 1.53                    | 2.50 | .22 | 5.86 | Blue               | P76                    | 2 9/16                  | 6              |
| LCCF350-12-6         |                     |                   | 1/2                  | 1.75                    | 1.53                    | 2.50 | .22 | 6.36 | Blue               | P76                    | 2 9/16                  | 6              |
| LCCF400-38D-6        | 400 kcmil           | 444.4 kcmil       | 3/8                  | 1.00                    | 1.70                    | 2.69 | .26 | 5.45 | Brown              | P87                    | 2 3/4                   | 6              |
| LCCF400-12-6         |                     |                   | 1/2                  | 1.75                    | 1.70                    | 2.69 | .26 | 6.63 | Brown              | P87                    | 2 3/4                   | 6              |
| <b>LCCF500-12-6</b>  | 500 kcmil           | 535.3 kcmil       | 1/2                  | 1.75                    | 1.89                    | 2.88 | .26 | 7.04 | Pink               | P99                    | 2 15/16                 | 6              |
| LCCF600-12-6         | —                   | 646.4 kcmil       | 1/2                  | 1.75                    | 1.95                    | 2.94 | .29 | 7.13 | Black              | P106                   | 3                       | 6              |
| LCCF750-38D-3        | —                   | 777.7 kcmil       | 3/8                  | 1.00                    | 2.17                    | 3.00 | .32 | 6.35 | Orange             | P107                   | 3 1/16                  | 3              |
| <b>LCCF750-12-3</b>  |                     |                   | 1/2                  | 1.75                    | 2.17                    | 3.00 | .32 | 7.29 | Orange             | P107                   | 3 1/16                  | 3              |

‡See pages D3.74, D3.75 for tool and die information.

\*\*Consult cable manufacturer for voltage stress relief instructions with applications greater than 2000 V.

◆NEMA hole sizes and spacing.

A.  
System  
Overview

B1.  
Cable Ties

B2.  
Cable  
Accessories

B3.  
Stainless  
Steel Ties

C1.  
Wiring  
Duct

C2.  
Surface  
Raceway

C3.  
Abrasion  
Protection

C4.  
Cable  
Management

D1.  
Terminals

D2.  
Power  
Connectors

D3.  
Grounding  
Connectors

E1.  
Labeling  
Systems

E2.  
Labels

E3.  
Pre-Printed  
& Write-On  
Markers

E4.  
Permanent  
Identification

E5.  
Lockout/  
Tagout  
& Safety  
Solutions

F.  
Index

A. System Overview



## Flex Conductor, Two-Hole, Long Barrel, Flared NEBS Lug, 45° Angle

B1. Cable Ties

**For Use with Flexible and Extra-Flexible Copper Conductors**

### Type LCCF-H

- Can be used with flex conductor class: K, M, and Diesel Locomotive
- Long barrel maximizes the number of crimps and provides premium wire pull-out strength and electrical performance
- Flared entry prevents bent back strands when inserting fine strand conductor into barrel
- Color-coded barrels marked with Panduit die index numbers for proper crimp die selection
- Enclosed barrel prevents corrosive material from entering barrel when used in harsh environments
- Tin-plated to inhibit corrosion
- UL Listed and CSA Certified to 35 KV\*\* and temperature rated to 90°C when crimped with Panduit crimping tools and dies
- **Tested by Telcordia – meets NEBS Level 3**
- Available with NEMA hole sizes and spacing

C1. Wiring Duct



C2. Surface Raceway

C3. Abrasion Protection

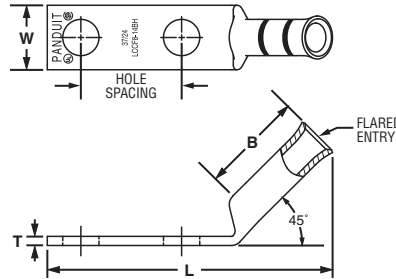

C4. Cable Management

D1. Terminals

D2. Power Connectors

D3. Grounding Connectors

E1. Labeling Systems

E2. Labels

E3. Pre-Printed & Write-On Markers

E4. Permanent Identification

E5. Lockout/Tagout & Safety Solutions

F. Index

| Part Number    | Flex Conductor Size |                   | Stud Hole Size (In.) | Stud Hole Spacing (In.) | Figure Dimensions (In.) |      |     |      | Panduit Color Code | Panduit Die Index No.‡ | Wire Strip Length (In.) | Std. Pkg. Qty. |
|----------------|---------------------|-------------------|----------------------|-------------------------|-------------------------|------|-----|------|--------------------|------------------------|-------------------------|----------------|
|                | Class K and M       | Diesel Locomotive |                      |                         | W                       | B    | T   | L    |                    |                        |                         |                |
| LCCF8-14AH-L   | —                   | #8 AWG            | 1/4                  | .63                     | .48                     | .76  | .07 | 2.00 | Red                | P21                    | 13/16                   | 50             |
| LCCF8-14BH-L   |                     |                   | 1/4                  | .75                     | .48                     | .76  | .07 | 2.12 | Red                | P21                    | 13/16                   | 50             |
| LCCF8-38DH-L   |                     |                   | 3/8                  | 1.00                    | .60                     | .76  | .05 | 2.58 | Red                | P21                    | 13/16                   | 50             |
| LCCF6-14AH-L   | #6 AWG              | #6 AWG            | 1/4                  | .63                     | .48                     | 1.22 | .08 | 2.36 | Blue               | P24                    | 1 5/16                  | 50             |
| LCCF6-14BH-L   |                     |                   | 1/4                  | .75                     | .48                     | 1.22 | .08 | 2.48 | Blue               | P24                    | 1 5/16                  | 50             |
| LCCF6-38DH-L   |                     |                   | 3/8                  | 1.00                    | .62                     | 1.22 | .06 | 2.94 | Blue               | P24                    | 1 5/16                  | 50             |
| LCCF4-14AH-L   | #4 AWG              | #4 AWG            | 1/4                  | .63                     | .55                     | 1.23 | .09 | 2.41 | Gray               | P29                    | 1 5/16                  | 50             |
| LCCF4-14BH-L   |                     |                   | 1/4                  | .75                     | .55                     | 1.23 | .09 | 2.54 | Gray               | P29                    | 1 5/16                  | 50             |
| LCCF4-38DH-L   |                     |                   | 3/8                  | 1.00                    | .62                     | 1.23 | .08 | 3.00 | Gray               | P29                    | 1 5/16                  | 50             |
| LCCF2-14AH-E   | #2 AWG              | #2 AWG            | 1/4                  | .63                     | .70                     | 1.36 | .11 | 2.56 | Brown              | P33                    | 1 7/16                  | 20             |
| LCCF2-14BH-E   |                     |                   | 1/4                  | .75                     | .70                     | 1.36 | .11 | 2.68 | Brown              | P33                    | 1 7/16                  | 20             |
| LCCF2-56BH-E   |                     |                   | 5/16                 | .75                     | .70                     | 1.36 | .11 | 2.81 | Brown              | P33                    | 1 7/16                  | 20             |
| LCCF2-38DH-E   |                     |                   | 3/8                  | 1.00                    | .70                     | 1.36 | .11 | 3.13 | Brown              | P33                    | 1 7/16                  | 20             |
| LCCF2-12H-E    |                     |                   | 1/2                  | 1.75                    | .75                     | 1.36 | .09 | 4.30 | Brown              | P33                    | 1 7/16                  | 20             |
| LCCF1-14AH-X   | #1 AWG              | #1 AWG            | 1/4                  | .63                     | .76                     | 1.44 | .12 | 2.71 | Pink               | P42                    | 1 1/2                   | 10             |
| LCCF1-14BH-X   |                     |                   | 1/4                  | .75                     | .76                     | 1.44 | .12 | 2.84 | Pink               | P42                    | 1 1/2                   | 10             |
| LCCF1-56CH-X   |                     |                   | 5/16                 | .88                     | .76                     | 1.44 | .12 | 3.02 | Pink               | P42                    | 1 1/2                   | 10             |
| LCCF1-38DH-X   |                     |                   | 3/8                  | 1.00                    | .76                     | 1.44 | .12 | 3.22 | Pink               | P42                    | 1 1/2                   | 10             |
| LCCF1-12H-X    |                     |                   | 1/2                  | 1.75                    | .80                     | 1.44 | .12 | 4.38 | Pink               | P42                    | 1 1/2                   | 10             |
| LCCF1/0-14AH-X | 1/0 AWG             | 1/0 AWG           | 1/4                  | .63                     | .85                     | 1.50 | .13 | 2.90 | Black              | P45                    | 1 9/16                  | 10             |
| LCCF1/0-14BH-X |                     |                   | 1/4                  | .75                     | .85                     | 1.50 | .13 | 3.02 | Black              | P45                    | 1 9/16                  | 10             |
| LCCF1/0-56CH-X |                     |                   | 5/16                 | .88                     | .85                     | 1.50 | .13 | 3.15 | Black              | P45                    | 1 9/16                  | 10             |
| LCCF1/0-38DH-X |                     |                   | 3/8                  | 1.00                    | .85                     | 1.50 | .13 | 3.34 | Black              | P45                    | 1 9/16                  | 10             |
| LCCF1/0-12H-X  |                     |                   | 1/2                  | 1.75                    | .85                     | 1.50 | .13 | 4.50 | Black              | P45                    | 1 9/16                  | 10             |
| LCCF2/0-14AH-X | 2/0 AWG             | 2/0 AWG           | 1/4                  | .63                     | .96                     | 1.50 | .13 | 2.92 | Orange             | P50                    | 1 9/16                  | 10             |
| LCCF2/0-14BH-X |                     |                   | 1/4                  | .75                     | .96                     | 1.50 | .13 | 3.05 | Orange             | P50                    | 1 9/16                  | 10             |
| LCCF2/0-38DH-X |                     |                   | 3/8                  | 1.00                    | .96                     | 1.50 | .13 | 3.36 | Orange             | P50                    | 1 9/16                  | 10             |
| LCCF2/0-12H-X  |                     |                   | 1/2                  | 1.75                    | .96                     | 1.50 | .13 | 4.52 | Orange             | P50                    | 1 9/16                  | 10             |
| LCCF3/0-14BH-X | 3/0 AWG             | 3/0 AWG           | 1/4                  | .75                     | 1.06                    | 1.56 | .14 | 3.14 | Purple             | P54                    | 1 5/8                   | 10             |
| LCCF3/0-38DH-X |                     |                   | 3/8                  | 1.00                    | 1.06                    | 1.56 | .14 | 3.47 | Purple             | P54                    | 1 5/8                   | 10             |
| LCCF3/0-12H-X  |                     |                   | 1/2                  | 1.75                    | 1.06                    | 1.56 | .14 | 4.61 | Purple             | P54                    | 1 5/8                   | 10             |

‡See pages D3.74, D3.75 for tool and die information.

\*\*Consult cable manufacturer for voltage stress relief instructions with applications greater than 2000 V.

◆NEMA hole sizes and spacing.



## Flex Conductor, Two-Hole, Long Barrel, Flared NEBS Lug, 45° Angle (continued)

| Part Number     | Flex Conductor Size |                   | Stud Hole Size (In.) | Stud Hole Spacing (In.) | Figure Dimensions (In.) |      |     |      | Panduit Color Code | Panduit Die Index No.‡ | Wire Strip Length (In.) | Std. Pkg. Qty. |
|-----------------|---------------------|-------------------|----------------------|-------------------------|-------------------------|------|-----|------|--------------------|------------------------|-------------------------|----------------|
|                 | Class K and M       | Diesel Locomotive |                      |                         | W                       | B    | T   | L    |                    |                        |                         |                |
| LCCF4/0-14BH-X  | 4/0 AWG             | 4/0 AWG           | 1/4                  | .75                     | 1.17                    | 1.61 | .14 | 3.06 | Yellow             | P62                    | 1 11/16                 | 10             |
| LCCF4/0-38DH-X  |                     |                   | 3/8                  | 1.00                    | 1.17                    | 1.61 | .14 | 3.55 | Yellow             | P62                    | 1 11/16                 | 10             |
| LCCF4/0-38H-X   |                     |                   | 3/8                  | 1.75                    | 1.17                    | 1.61 | .14 | 4.30 | Yellow             | P62                    | 1 11/16                 | 10             |
| ◆ LCCF4/0-12H-X | 250 kcmil           | 262.6 kcmil       | 1/2                  | 1.75                    | 1.17                    | 1.61 | .14 | 4.69 | Yellow             | P62                    | 1 11/16                 | 10             |
| LCCF250-14BH-X  |                     |                   | 1/4                  | .75                     | 1.28                    | 2.24 | .17 | 3.66 | White              | P66                    | 2 5/16                  | 10             |
| LCCF250-38DH-X  |                     |                   | 3/8                  | 1.00                    | 1.28                    | 2.24 | .17 | 4.14 | White              | P66                    | 2 5/16                  | 10             |
| LCCF250-12EH-X  | 300 kcmil           | 313.1 kcmil       | 1/2                  | 1.25                    | 1.28                    | 2.24 | .17 | 4.82 | White              | P66                    | 2 5/16                  | 10             |
| ◆ LCCF250-12H-X |                     |                   | 1/2                  | 1.75                    | 1.28                    | 2.24 | .17 | 5.32 | White              | P66                    | 2 5/16                  | 10             |
| LCCF300-14BH-6  |                     |                   | 1/4                  | .75                     | 1.38                    | 2.30 | .18 | 3.77 | Red                | P71                    | 2 3/8                   | 6              |
| LCCF300-38DH-6  | 350 kcmil           | 373.7 kcmil       | 3/8                  | 1.00                    | 1.38                    | 2.30 | .18 | 4.25 | Red                | P71                    | 2 3/8                   | 6              |
| ◆ LCCF300-12H-6 |                     |                   | 1/2                  | 1.75                    | 1.38                    | 2.30 | .18 | 5.43 | Red                | P71                    | 2 3/8                   | 6              |
| LCCF350-14BH-6  |                     |                   | 1/4                  | .75                     | 1.53                    | 2.50 | .22 | 3.98 | Blue               | P76                    | 2 9/16                  | 6              |
| LCCF350-38DH-6  | 400 kcmil           | 444.4 kcmil       | 3/8                  | 1.00                    | 1.53                    | 2.50 | .22 | 4.46 | Blue               | P76                    | 2 9/16                  | 6              |
| LCCF350-12EH-6  |                     |                   | 1/2                  | 1.25                    | 1.53                    | 2.50 | .22 | 5.14 | Blue               | P76                    | 2 9/16                  | 6              |
| ◆ LCCF350-12H-6 |                     |                   | 1/2                  | 1.75                    | 1.53                    | 2.50 | .22 | 5.64 | Blue               | P76                    | 2 9/16                  | 6              |
| LCCF400-38DH-6  | 500 kcmil           | 535.3 kcmil       | 3/8                  | 1.00                    | 1.70                    | 2.69 | .26 | 4.66 | Brown              | P87                    | 2 3/4                   | 6              |
| ◆ LCCF400-12H-6 |                     |                   | 1/2                  | 1.75                    | 1.70                    | 2.69 | .26 | 5.84 | Brown              | P87                    | 2 3/4                   | 6              |
| ◆ LCCF500-12H-6 |                     |                   | 1/2                  | 1.75                    | 1.89                    | 2.88 | .26 | 6.18 | Pink               | P99                    | 2 15/16                 | 6              |
| ◆ LCCF600-12H-6 | —                   | 646.4 kcmil       | 1/2                  | 1.75                    | 1.95                    | 2.94 | .29 | 6.25 | Black              | P106                   | 3                       | 6              |
| LCCF750-38DH-3  | —                   | 777.7 kcmil       | 3/8                  | 1.00                    | 2.17                    | 3.00 | .32 | 5.45 | Orange             | P107                   | 3 1/16                  | 3              |
| ◆ LCCF750-12H-3 |                     |                   | 1/2                  | 1.75                    | 2.17                    | 3.00 | .32 | 6.39 | Orange             | P107                   | 3 1/16                  | 3              |

‡See pages D3.74, D3.75 for tool and die information.

\*\*Consult cable manufacturer for voltage stress relief instructions with applications greater than 2000 V.

◆NEMA hole sizes and spacing.

A.  
System Overview

B1.  
Cable Ties

B2.  
Cable Accessories

B3.  
Stainless Steel Ties

C1.  
Wiring Duct

C2.  
Surface Raceway

C3.  
Abrasion Protection

C4.  
Cable Management

D1.  
Terminals

D2.  
Power Connectors

D3.  
Grounding Connectors

E1.  
Labeling Systems

E2.  
Labels

E3.  
Pre-Printed & Write-On Markers

E4.  
Permanent Identification

E5.  
Lockout/Tagout & Safety Solutions

F.  
Index

A. System Overview



## Flex Conductor, Two-Hole, Long Barrel, Flared NEBS Lug, 90° Angle

B1. Cable Ties

**For Use with Flexible and Extra-Flexible Copper Conductors**

### Type LCCF-F

- Can be used with flex conductor class: K, M, and Diesel Locomotive
- Long barrel maximizes the number of crimps and provides premium wire pull-out strength and electrical performance
- Flared entry prevents bent back strands when inserting fine strand conductor into barrel
- Color-coded barrels marked with Panduit die index numbers for proper crimp die selection
- Enclosed barrel prevents corrosive material from entering barrel when used in harsh environments
- Tin-plated to inhibit corrosion
- UL Listed and CSA Certified to 35 KV\*\* and temperature rated to 90°C when crimped with Panduit crimping tools and dies
- **Tested by Telcordia – meets NEBS Level 3**
- Available with NEMA hole sizes and spacing

B2. Cable Accessories

B3. Stainless Steel Ties

C1. Wiring Duct



C2. Surface Raceway

C3. Abrasion Protection

C4. Cable Management

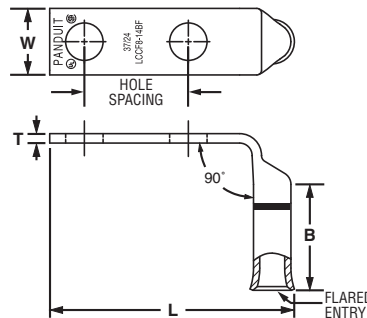

D1. Terminals

D2. Power Connectors

D3. Grounding Connectors

E1. Labeling Systems

E2. Labels

E3. Pre-Printed & Write-On Markers

E4. Permanent Identification

E5. Lockout/Tagout & Safety Solutions

F. Index

| Part Number    | Flex Conductor Size |                   | Stud Hole Size (In.) | Stud Hole Spacing (In.) | Figure Dimensions (In.) |      |      |      | Panduit Color Code | Panduit Die Index No.‡ | Wire Strip Length (In.) | Std. Pkg. Qty. |
|----------------|---------------------|-------------------|----------------------|-------------------------|-------------------------|------|------|------|--------------------|------------------------|-------------------------|----------------|
|                | Class K and M       | Diesel Locomotive |                      |                         | W                       | B    | T    | L    |                    |                        |                         |                |
| LCCF8-14AF-L   | —                   | #8 AWG            | 1/4                  | .63                     | .48                     | .76  | .07  | 1.64 | Red                | P21                    | 13/16                   | 50             |
| LCCF8-14BF-L   |                     |                   | 1/4                  | .75                     | .48                     | .76  | .07  | 1.77 | Red                | P21                    | 13/16                   | 50             |
| LCCF8-38DF-L   |                     |                   | 3/8                  | 1.00                    | .60                     | .76  | .05  | 2.24 | Red                | P21                    | 13/16                   | 50             |
| LCCF6-14AF-L   | #6 AWG              | #6 AWG            | 1/4                  | .63                     | .48                     | 1.22 | .08  | 1.69 | Blue               | P24                    | 1 5/16                  | 50             |
| LCCF6-14BF-L   |                     |                   | 1/4                  | .75                     | .48                     | 1.22 | .08  | 1.81 | Blue               | P24                    | 1 5/16                  | 50             |
| LCCF6-38DF-L   |                     |                   | 3/8                  | 1.00                    | .62                     | 1.22 | .06  | 2.28 | Blue               | P24                    | 1 5/16                  | 50             |
| LCCF4-14AF-L   | #4 AWG              | #4 AWG            | 1/4                  | .63                     | .55                     | 1.23 | .09  | 1.78 | Gray               | P29                    | 1 5/16                  | 50             |
| LCCF4-14BF-L   |                     |                   | 1/4                  | .75                     | .55                     | 1.23 | .09  | 1.91 | Gray               | P29                    | 1 5/16                  | 50             |
| LCCF2-14BF-E   |                     |                   | 1/4                  | .75                     | .70                     | 1.36 | .11  | 2.10 | Brown              | P33                    | 1 7/16                  | 20             |
| LCCF2-56BF-E   | #2 AWG              | #2 AWG            | 5/16                 | .75                     | .70                     | 1.36 | .11  | 2.23 | Brown              | P33                    | 1 7/16                  | 20             |
| LCCF2-38DF-E   |                     |                   | 3/8                  | 1.00                    | .70                     | 1.36 | .11  | 2.55 | Brown              | P33                    | 1 7/16                  | 20             |
| LCCF2-12F-E    |                     |                   | 1/2                  | 1.75                    | .79                     | 1.36 | .09  | 3.72 | Brown              | P33                    | 1 7/16                  | 20             |
| LCCF1-14AF-X   | #1 AWG              | #1 AWG            | 1/4                  | .63                     | .76                     | 1.44 | .12  | 2.11 | Pink               | P42                    | 1 1/2                   | 10             |
| LCCF1-14BF-X   |                     |                   | 1/4                  | .75                     | .76                     | 1.44 | .12  | 2.24 | Pink               | P42                    | 1 1/2                   | 10             |
| LCCF1-56CF-X   |                     |                   | 5/16                 | .88                     | .76                     | 1.44 | .12  | 2.42 | Pink               | P42                    | 1 1/2                   | 10             |
| LCCF1-38DF-X   |                     |                   | 3/8                  | 1.00                    | .76                     | 1.44 | .12  | 2.62 | Pink               | P42                    | 1 1/2                   | 10             |
| LCCF1-12F-X    |                     |                   | 1/2                  | 1.75                    | .80                     | 1.44 | .11  | 3.79 | Pink               | P42                    | 1 1/2                   | 10             |
| LCCF1/0-14AF-X |                     |                   | 1/0 AWG              | 1/0 AWG                 | 1/4                     | .63  | .85  | 1.50 | .13                | 2.27                   | Black                   | P45            |
| LCCF1/0-14BF-X | 1/4                 | .75               |                      |                         | .85                     | 1.50 | .13  | 2.39 | Black              | P45                    | 1 9/16                  | 10             |
| LCCF1/0-56CF-X | 5/16                | .88               |                      |                         | .85                     | 1.50 | .13  | 2.52 | Black              | P45                    | 1 9/16                  | 10             |
| LCCF1/0-38DF-X | 3/8                 | 1.00              |                      |                         | .85                     | 1.50 | .13  | 2.70 | Black              | P45                    | 1 9/16                  | 10             |
| LCCF1/0-12F-X  | 1/2                 | 1.75              |                      |                         | .85                     | 1.50 | .13  | 3.87 | Black              | P45                    | 1 9/16                  | 10             |
| LCCF2/0-14AF-X | 2/0 AWG             | 2/0 AWG           |                      |                         | 1/4                     | .63  | .96  | 1.50 | .13                | 2.33                   | Orange                  | P50            |
| LCCF2/0-14BF-X |                     |                   | 1/4                  | .75                     | .96                     | 1.50 | .13  | 2.46 | Orange             | P50                    | 1 9/16                  | 10             |
| LCCF2/0-38DF-X |                     |                   | 3/8                  | 1.00                    | .96                     | 1.50 | .13  | 2.77 | Orange             | P50                    | 1 9/16                  | 10             |
| LCCF2/0-12F-X  |                     |                   | 1/2                  | 1.75                    | .96                     | 1.50 | .13  | 3.93 | Orange             | P50                    | 1 9/16                  | 10             |
| LCCF3/0-14BF-X |                     |                   | 3/0 AWG              | 3/0 AWG                 | 1/4                     | .75  | 1.06 | 1.56 | .14                | 2.56                   | Purple                  | P54            |
| LCCF3/0-38DF-X | 3/8                 | 1.00              |                      |                         | 1.06                    | 1.56 | .14  | 2.89 | Purple             | P54                    | 1 5/8                   | 10             |
| LCCF3/0-12F-X  | 1/2                 | 1.75              |                      |                         | 1.06                    | 1.56 | .14  | 4.03 | Purple             | P54                    | 1 5/8                   | 10             |

‡See pages D3.74, D3.75 for tool and die information.

\*\*Consult cable manufacturer for voltage stress relief instructions with applications greater than 2000 V.



## Flex Conductor, Two-Hole, Long Barrel, Flared NEBS Lug, 90° Angle (continued)

| Part Number      | Flex Conductor Size |                   | Stud Hole Size (In.) | Stud Hole Spacing (In.) | Figure Dimensions (In.) |      |     |      | Panduit Color Code | Panduit Die Index No.‡ | Wire Strip Length (In.) | Std. Pkg. Qty. |
|------------------|---------------------|-------------------|----------------------|-------------------------|-------------------------|------|-----|------|--------------------|------------------------|-------------------------|----------------|
|                  | Class K and M       | Diesel Locomotive |                      |                         | W                       | B    | T   | L    |                    |                        |                         |                |
| LCCF4/0-14BF-X   | 4/0 AWG             | 4/0 AWG           | 1/4                  | .75                     | 1.17                    | 1.61 | .14 | 2.48 | Yellow             | P62                    | 1 11/16                 | 10             |
| LCCF4/0-38DF-X   |                     |                   | 3/8                  | 1.00                    | 1.17                    | 1.61 | .14 | 2.97 | Yellow             | P62                    | 1 11/16                 | 10             |
| LCCF4/0-38F-X    |                     |                   | 3/8                  | 1.75                    | 1.17                    | 1.61 | .14 | 3.72 | Yellow             | P62                    | 1 11/16                 | 10             |
| ◆ LCCF4/0-12F-X  | 250 kcmil           | 262.6 kcmil       | 1/2                  | 1.75                    | 1.17                    | 1.61 | .14 | 4.11 | Yellow             | P62                    | 1 11/16                 | 10             |
| LCCF250-14BF-X   |                     |                   | 1/4                  | .75                     | 1.28                    | 2.24 | .17 | 2.54 | White              | P66                    | 2 5/16                  | 10             |
| LCCF250-38DF-X   |                     |                   | 3/8                  | 1.00                    | 1.28                    | 2.24 | .17 | 3.02 | White              | P66                    | 2 5/16                  | 10             |
| ◆ LCCF250-12EF-X | 300 kcmil           | 313.1 kcmil       | 1/2                  | 1.25                    | 1.28                    | 2.24 | .17 | 3.70 | White              | P66                    | 2 5/16                  | 10             |
| LCCF250-12F-X    |                     |                   | 1/2                  | 1.75                    | 1.28                    | 2.24 | .17 | 4.20 | White              | P66                    | 2 5/16                  | 10             |
| ◆ LCCF300-14BF-6 | 350 kcmil           | 373.7 kcmil       | 1/4                  | .75                     | 1.38                    | 2.30 | .18 | 2.61 | Red                | P71                    | 2 3/8                   | 6              |
| LCCF300-38DF-6   |                     |                   | 3/8                  | 1.00                    | 1.38                    | 2.30 | .18 | 3.09 | Red                | P71                    | 2 3/8                   | 6              |
| ◆ LCCF300-12F-6  |                     |                   | 1/2                  | 1.75                    | 1.38                    | 2.30 | .18 | 4.27 | Red                | P71                    | 2 3/8                   | 6              |
| LCCF350-14BF-6   | 400 kcmil           | 444.4 kcmil       | 1/4                  | .75                     | 1.53                    | 2.50 | .22 | 2.73 | Blue               | P76                    | 2 9/16                  | 6              |
| LCCF350-38DF-6   |                     |                   | 3/8                  | 1.00                    | 1.53                    | 2.50 | .22 | 3.21 | Blue               | P76                    | 2 9/16                  | 6              |
| LCCF350-12EF-6   |                     |                   | 1/2                  | 1.25                    | 1.53                    | 2.50 | .22 | 3.89 | Blue               | P76                    | 2 9/16                  | 6              |
| ◆ LCCF350-12F-6  | 500 kcmil           | 535.3 kcmil       | 1/2                  | 1.75                    | 1.53                    | 2.50 | .22 | 4.39 | Blue               | P76                    | 2 9/16                  | 6              |
| ◆ LCCF400-38DF-6 |                     |                   | 3/8                  | 1.00                    | 1.70                    | 2.69 | .26 | 3.33 | Brown              | P87                    | 2 3/4                   | 6              |
| ◆ LCCF400-12F-6  | 500 kcmil           | 535.3 kcmil       | 1/2                  | 1.75                    | 1.70                    | 2.69 | .26 | 4.51 | Brown              | P87                    | 2 3/4                   | 6              |
| ◆ LCCF500-12F-6  |                     |                   | 1/2                  | 1.75                    | 1.89                    | 2.88 | .26 | 4.67 | Pink               | P99                    | 2 15/16                 | 6              |
| ◆ LCCF600-12F-6  | —                   | 646.4 kcmil       | 1/2                  | 1.75                    | 1.95                    | 2.88 | .29 | 4.73 | Black              | P106                   | 3                       | 6              |
| ◆ LCCF750-38DF-3 | —                   | 777.7 kcmil       | 3/8                  | 1.00                    | 2.17                    | 3.00 | .32 | 3.96 | Orange             | P107                   | 3 1/16                  | 3              |
| ◆ LCCF750-12F-3  |                     |                   | 1/2                  | 1.75                    | 2.17                    | 3.00 | .32 | 4.90 | Orange             | P107                   | 3 1/16                  | 3              |

‡See pages D3.74, D3.75 for tool and die information.

\*\*Consult cable manufacturer for voltage stress relief instructions with applications greater than 2000 V.

◆NEMA hole sizes and spacing.

A.  
System Overview

B1.  
Cable Ties

B2.  
Cable Accessories

B3.  
Stainless Steel Ties

C1.  
Wiring Duct

C2.  
Surface Raceway

C3.  
Abrasion Protection

C4.  
Cable Management

D1.  
Terminals

D2.  
Power Connectors

D3.  
Grounding Connectors

E1.  
Labeling Systems

E2.  
Labels

E3.  
Pre-Printed & Write-On Markers

E4.  
Permanent Identification

E5.  
Lockout/Tagout & Safety Solutions

F.  
Index

A. System Overview



## Flex Conductor, Standard Barrel, Flared, NEBS Butt Splice

B1. Cable Ties

**For Use with Flexible and Extra-Flexible Copper Conductors**

### Type SCSF

- Can be used with flex conductor class: K, M, and Diesel Locomotive
- Flared entry prevents bent back strands when inserting fine strand conductor into barrel
- Color-coded barrels marked with Panduit die index numbers for proper crimp die selection
- Internal wire stops to prevent over-insertion of conductor
- Tin-plated to inhibit corrosion
- UL Listed and CSA Certified to 35 KV\*\* and temperature rated to 90°C when crimped with Panduit crimping tools and dies
- **Tested by Telcordia – meets NEBS Level 3**
- American Bureau of Shipping approved

B2. Cable Accessories

B3. Stainless Steel Ties

C1. Wiring Duct

C2. Surface Raceway

C3. Abrasion Protection

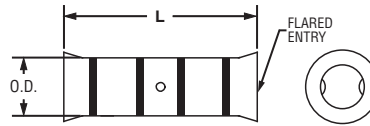

C4. Cable Management

D1. Terminals

D2. Power Connectors

D3. Grounding Connectors

| Part Number | Flex Conductor Size |                   | Figure Dimensions (In.) |      | Panduit Color Code | Panduit Die Index No.‡ | Wire Strip Length (In.) | Std. Pkg. Qty. |
|-------------|---------------------|-------------------|-------------------------|------|--------------------|------------------------|-------------------------|----------------|
|             | Class K and M       | Diesel Locomotive | Barrel O.D.             | L    |                    |                        |                         |                |
| SCSF8-L     | —                   | #8 AWG            | 0.27                    | 1.50 | Red                | P21                    | 11/16                   | 50             |
| SCSF6-L     | #6 AWG              | #6 AWG            | 0.31                    | 1.75 | Blue               | P24                    | 13/16                   | 50             |
| SCSF4-L     | #4 AWG              | #4 AWG            | 0.38                    | 1.75 | Gray               | P29                    | 13/16                   | 50             |
| SCSF2-E     | #2 AWG              | #2 AWG            | 0.47                    | 1.87 | Brown              | P33                    | 7/8                     | 20             |
| SCSF1-X     | #1 AWG              | #1 AWG            | 0.52                    | 1.87 | Pink               | P42                    | 7/8                     | 10             |
| SCSF1/0-X   | 1/0 AWG             | 1/0 AWG           | 0.58                    | 2.50 | Black              | P45                    | 1 3/16                  | 10             |
| SCSF2/0-X   | 2/0 AWG             | 2/0 AWG           | 0.64                    | 2.50 | Orange             | P50                    | 1 3/16                  | 10             |
| SCSF3/0-X   | 3/0 AWG             | 3/0 AWG           | 0.71                    | 2.50 | Purple             | P54                    | 1 3/16                  | 10             |
| SCSF4/0-X   | 4/0 AWG             | 4/0 AWG           | 0.77                    | 2.50 | Yellow             | P62                    | 1 3/16                  | 10             |
| SCSF250-X   | 250 kcmil           | 262.6 kcmil       | 0.88                    | 2.50 | White              | P66                    | 1 3/16                  | 10             |
| SCSF300-6   | 300 kcmil           | 313.1 kcmil       | 0.95                    | 2.56 | Red                | P71                    | 1 1/4                   | 6              |
| SCSF350-6   | 350 kcmil           | 373.7 kcmil       | 1.06                    | 2.94 | Blue               | P76                    | 1 1/2                   | 6              |

‡See pages D3.74, D3.75 for tool and die information.

\*\*Consult cable manufacturer for voltage stress relief instructions with applications greater than 2000 V.

E1. Labeling Systems

E2. Labels

E3. Pre-Printed & Write-On Markers

E4. Permanent Identification

E5. Lockout/Tagout & Safety Solutions

F. Index



## Code/Flex Conductor, with Window, In-Line Reducing Splice Kit

### Type RSCK

- Includes all components in one package for making a complete electrical connection: Panduit copper compression RSC in-line reducing splice (see pages D2.105 – D2.106) and crystal clear PVC heat shrink sleeves pre-cut to length to insulate reducing splice
- Panduit RSC in-line reducing splice is UL Listed and temperature rated to 90°C when crimped with Panduit crimping tools and dies
- Panduit crystal clear PVC heat shrink has a UL 224 VW-1 flammability rating and passes Telcordia GR-347-CORE Compression and Cut-Through Penetration Test and Abrasion Resistance Test
- Panduit crystal clear PVC heat shrink is UL Recognized with a temperature rating of 150°C, high temperature insulating property
- Rated for 600 V applications when Panduit crystal clear PVC heat shrink is applied



| Part Number | Part Description  | Std. Pkg. Qty. |
|-------------|---|----------------|
| RSCK4-6-1   | Kit contains:<br>1 pc. RSC4-6-L copper compression in-line reducing splice.<br>1 pc. HSTTPN50-713-Q crystal clear PVC heat shrink 1/2" dia. x 7.125" long.  | 1              |
| RSCK2-6-1   | Kit contains:<br>1 pc. RSC2-6-Q copper compression in-line reducing splice.<br>1 pc. HSTTPN62-750-Q crystal clear PVC heat shrink 5/8" dia. x 7.500" long.  | 1              |
| RSCK2-4-1   | Kit contains:<br>1 pc. RSC2-4-Q copper compression in-line reducing splice.<br>1 pc. HSTTPN62-750-Q crystal clear PVC heat shrink 5/8" dia. x 7.500" long.  | 1              |
| RSCK1/0-6-1 | Kit contains:<br>1 pc. RSC1/0-6-X copper compression in-line reducing splice.<br>1 pc. HSTTPN75-775-Q crystal clear PVC heat shrink 3/4" dia. x 7.750" long.<br>1 pc. HSTTPN50-438-L crystal clear PVC heat shrink 1/2" dia. x 4.375" long. | 1              |
| RSCK1/0-4-1 | Kit contains:<br>1 pc. RSC1/0-4-X copper compression in-line reducing splice.<br>1 pc. HSTTPN75-775-Q crystal clear PVC heat shrink 3/4" dia. x 7.750" long.<br>1 pc. HSTTPN50-438-L crystal clear PVC heat shrink 1/2" dia. x 4.375" long. | 1              |
| RSCK2/0-6-1 | Kit contains:<br>1 pc. RSC2/0-6-X copper compression in-line reducing splice.<br>1 pc. HSTTPN75-775-Q crystal clear PVC heat shrink 3/4" dia. x 7.750" long.<br>1 pc. HSTTPN50-438-L crystal clear PVC heat shrink 1/2" dia. x 4.375" long. | 1              |
| RSCK2/0-4-1 | Kit contains:<br>1 pc. RSC2/0-4-X copper compression in-line reducing splice.<br>1 pc. HSTTPN75-775-Q crystal clear PVC heat shrink 3/4" dia. x 7.750" long.<br>1 pc. HSTTPN50-438-L crystal clear PVC heat shrink 1/2" dia. x 4.375" long. | 1              |
| RSCK4/0-6-1 | Kit contains:<br>1 pc. RSC4/0-6-X copper compression in-line reducing splice.<br>1 pc. HSTTPN100-775-Q crystal clear PVC heat shrink 1" dia. x 7.750" long.<br>1 pc. HSTTPN50-438-L crystal clear PVC heat shrink 1/2" dia. x 4.375" long.  | 1              |
| RSCK4/0-4-1 | Kit contains:<br>1 pc. RSC4/0-4-X copper compression in-line reducing splice.<br>1 pc. HSTTPN100-775-Q crystal clear PVC heat shrink 1" dia. x 7.750" long.<br>1 pc. HSTTPN50-438-L crystal clear PVC heat shrink 1/2" dia. x 4.375" long.  | 1              |

Table continues on page D2.104

A.  
System  
Overview

## Code/Flex Conductor, with Window, In-Line Reducing Splice Kit (continued)

B1.  
Cable Ties

B2.  
Cable  
Accessories



B3.  
Stainless  
Steel Ties

| Part Number          | Part Description  | Std. Pkg. Qty. |
|----------------------|---|----------------|
| <b>RSC4/0-1/0-1</b>  | Kit contains:<br>1 pc. RSC4/0-1/0-X copper compression in-line reducing splice.<br>1 pc. HSTTPN100-775-Q crystal clear PVC heat shrink 1" dia. x 7.750" long.<br>1 pc. HSTTPN75-775-Q crystal clear PVC heat shrink 3/4" dia. x 7.750" long.    | 1              |
| <b>RSC4/0-2/0-1</b>  | Kit contains:<br>1 pc. RSC4/0-2/0-X copper compression in-line reducing splice.<br>1 pc. HSTTPN100-775-Q crystal clear PVC heat shrink 1" dia. x 7.750" long.<br>1 pc. HSTTPN75-775-Q crystal clear PVC heat shrink 3/4" dia. x 7.750" long.    | 1              |
| <b>RSC500-X4/0-1</b> | Kit contains:<br>1 pc. RSC500-X4/0-6 copper compression in-line reducing splice.<br>1 pc. HSTTPN150-925-X crystal clear PVC heat shrink 1 1/2" dia. x 9.250" long.  | 1              |
| <b>RSC500-X350-1</b> | Kit contains:<br>1 pc. RSC500-X350-6 copper compression in-line reducing splice.<br>1 pc. HSTTPN150-925-X crystal clear PVC heat shrink 1 1/2" dia. x 9.250" long.  | 1              |
| <b>RSC750-4/0-1</b>  | Kit contains:<br>1 pc. RSC750-4/0-6 copper compression in-line reducing splice.<br>1 pc. HSTTPN150-925-X crystal clear PVC heat shrink 1 1/2" dia. x 9.250" long.<br>1 pc. HSTTPN100-775-Q crystal clear PVC heat shrink 1" dia. x 7.750" long. | 1              |
| <b>RSC750-X4/0-1</b> | Kit contains:<br>1 pc. RSC750-X4/0-6 copper compression in-line reducing splice.<br>1 pc. HSTTPN150-925-X crystal clear PVC heat shrink 1 1/2" dia. x 9.250" long.  | 1              |
| <b>RSC750-X350-1</b> | Kit contains:<br>1 pc. RSC750-X350-6 copper compression in-line reducing splice.<br>1 pc. HSTTPN150-925-X crystal clear PVC heat shrink 1 1/2" dia. x 9.250" long.  | 1              |
| <b>RSC750-500-1</b>  | Kit contains:<br>1 pc. RSC750-500-6 copper compression in-line reducing splice.<br>1 pc. HSTTPN150-925-X crystal clear PVC heat shrink 1 1/2" dia. x 9.250" long.   | 1              |
| <b>RSC750-X500-1</b> | Kit contains:<br>1 pc. RSC750-X500-6 copper compression in-line reducing splice.<br>1 pc. HSTTPN150-925-X crystal clear PVC heat shrink 1 1/2" dia. x 9.250" long.  | 1              |
| <b>RSC750-750-1</b>  | Kit contains:<br>1 pc. RSC750-750-6 copper compression in-line reducing splice.<br>1 pc. HSTTPN150-925-X crystal clear PVC heat shrink 1 1/2" dia. x 9.250" long.   | 1              |
| <b>RSCX750-4/0-1</b> | Kit contains:<br>1 pc. RSCX750-4/0-3 copper compression in-line reducing splice.<br>1 pc. HSTTPN200-950-X crystal clear PVC heat shrink 2" dia. x 9.500" long.<br>1 pc. HSTTPN100-775-Q crystal clear PVC heat shrink 1" dia. x 7.750" long.    | 1              |
| <b>RSCX750-750-1</b> | Kit contains:<br>1 pc. RSCX750-750-3 copper compression in-line reducing splice.<br>1 pc. HSTTPN200-950-X crystal clear PVC heat shrink 2" dia. x 9.500" long.  | 1              |

C1.  
Wiring  
Duct

C2.  
Surface  
Raceway

C3.  
Abrasion  
Protection

C4.  
Cable  
Management

D1.  
Terminals

D2.  
Power  
Connectors

D3.  
Grounding  
Connectors

E1.  
Labeling  
Systems

E2.  
Labels

E3.  
Pre-Printed  
& Write-On  
Markers

E4.  
Permanent  
Identification

E5.  
Lockout/  
Tagout  
& Safety  
Solutions

F.  
Index



## Code/Flex Conductor, with Window, In-Line Reducing Splice

For Use with Stranded Copper Code and Class I Flex Conductors

### Type RSC

- Low profile design provides minimum space requirements
- Manufactured from seamless, high conductivity copper tubing
- Color-coded barrels marked with Panduit and specified competitor die index numbers for proper crimp die selection
- Inspection windows in each barrel to visually assure full conductor insertion
- Generous internally beveled wire entry for easy conductor insertion
- Tin-plated to inhibit corrosion
- UL Listed and CSA Certified to 35 KV\*\* and temperature rated to 90°C when crimped with Panduit and specified competitor crimping tools and dies
- Also sold as a kit with crystal clear PVC heat shrink (see pages D2.103, D2.104)

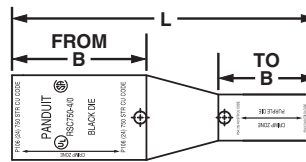

| Part Number   |              | Copper Conductor Size     | Figure Dimensions (In.) |      | Panduit Color Code | Panduit Die Index No.‡ | Burdny Die Index No.‡ | T&B Die Index No.‡ | Wire Strip Length (In.) | Std. Pkg. Qty. |
|---------------|--------------|---------------------------|-------------------------|------|--------------------|------------------------|-----------------------|--------------------|-------------------------|----------------|
|               |              |                           | B                       | L    |                    |                        |                       |                    |                         |                |
| RSC4-6-L      | Reduces From | #4 – 3 AWG STR,#2 AWG SOL | 1.05                    | 2.54 | Gray               | P29                    | 8                     | 29                 | 1                       | 1              |
|               | Reduces To   | #6 AWG                    | 1.38                    |      | Blue               | P24                    | 7                     | 24                 | 1 5/16                  |                |
| RSC2-6-Q      | Reduces From | #2 AWG                    | 1.05                    | 2.62 | Brown              | P33                    | 10                    | 33                 | 1                       | 1              |
|               | Reduces To   | #6 AWG                    | 1.38                    |      | Blue               | P24                    | 7                     | 34                 | 1 5/16                  |                |
| RSC2-4-Q      | Reduces From | #2 AWG                    | 1.05                    | 2.50 | Brown              | P33                    | 10                    | 33                 | 1                       | 1              |
|               | Reduces To   | #4 – 3 AWG STR,#2 AWG SOL | 1.38                    |      | Gray               | P29                    | 8                     | 29                 | 1 5/16                  |                |
| RSC1/0-6-X    | Reduces From | 1/0 AWG                   | 1.05                    | 2.81 | Pink               | P42                    | 12                    | 42                 | 1                       | 1              |
|               | Reduces To   | #6 AWG                    | 1.38                    |      | Blue               | P24                    | 7                     | 24                 | 1 5/16                  |                |
| RSC1/0-4-X    | Reduces From | 1/0 AWG                   | 1.05                    | 2.70 | Pink               | P42                    | 12                    | 42                 | 1                       | 1              |
|               | Reduces To   | #4 – 3 AWG STR,#2 AWG SOL | 1.38                    |      | Gray               | P29                    | 8                     | 29                 | 1 5/16                  |                |
| RSC2/0-6-X    | Reduces From | 2/0 AWG                   | 1.13                    | 2.99 | Black              | P45                    | 13                    | 45                 | 1 1/16                  | 1              |
|               | Reduces To   | #6 AWG                    | 1.38                    |      | Blue               | P24                    | 7                     | 24                 | 1 5/16                  |                |
| RSC2/0-4-X    | Reduces From | 2/0 AWG                   | 1.13                    | 2.88 | Black              | P45                    | 13                    | 45                 | 1 1/16                  | 1              |
|               | Reduces To   | #4 – 3 AWG STR,#2 AWG SOL | 1.38                    |      | Gray               | P29                    | 8                     | 29                 | 1 5/16                  |                |
| RSC4/0-6-X    | Reduces From | 4/0 AWG                   | 1.13                    | 3.24 | Purple             | P54                    | 15                    | 54                 | 1 1/16                  | 1              |
|               | Reduces To   | #6 AWG                    | 1.38                    |      | Blue               | P24                    | 7                     | 24                 | 1 5/16                  |                |
| RSC4/0-4-X    | Reduces From | 4/0 AWG                   | 1.13                    | 3.12 | Purple             | P54                    | 15                    | 54                 | 1 1/16                  | 1              |
|               | Reduces To   | #4 – 3 AWG STR,#2 AWG SOL | 1.38                    |      | Gray               | P29                    | 8                     | 29                 | 1 5/16                  |                |
| RSC4/0-1/0-X  | Reduces From | 4/0 AWG                   | 1.16                    | 3.13 | Purple             | P54                    | 15                    | 54                 | 1 1/16                  | 1              |
|               | Reduces To   | 1/0 AWG                   | 1.63                    |      | Pink               | P42                    | 12                    | 42                 | 1 9/16                  |                |
| RSC4/0-2/0-X  | Reduces From | 4/0 AWG                   | 1.16                    | 2.90 | Purple             | P54                    | 15                    | 54                 | 1 1/16                  | 1              |
|               | Reduces To   | 2/0 AWG                   | 1.50                    |      | Black              | P45                    | 13                    | 45                 | 1 7/16                  |                |
| RSC500-X4/0-6 | Reduces From | 500 kcmil                 | 1.94                    | 3.97 | Brown              | P87                    | 20                    | 87                 | 1 7/8                   | 1              |
|               | Reduces To   | 4/0 Flex                  | 1.50                    |      | Yellow             | P62                    | 16                    | 62                 | 1 7/16                  |                |
| RSC500-X350-6 | Reduces From | 500 kcmil                 | 1.94                    | 4.38 | Brown              | P87                    | 20                    | 87                 | 1 7/8                   | 1              |
|               | Reduces To   | 350 Flex                  | 1.94                    |      | Blue               | P76                    | 19                    | 76                 | 1 7/8                   |                |

‡See pages D3.76 – D3.81 for tool and die information.

\*\*Consult cable manufacturer for voltage stress relief instructions with applications greater than 2000 V.

Table continues on page D2.106

A. System Overview

B1. Cable Ties

B2. Cable Accessories

B3. Stainless Steel Ties

C1. Wiring Duct

C2. Surface Raceway

C3. Abrasion Protection

C4. Cable Management

D1. Terminals

D2. Power Connectors

D3. Grounding Connectors

E1. Labeling Systems

E2. Labels

E3. Pre-Printed & Write-On Markers

E4. Permanent Identification

E5. Lockout/Tagout & Safety Solutions

F. Index

A. System Overview



## Code/Flex Conductor, with Window, In-Line Reducing Splice (continued)

B1. Cable Ties

B2. Cable Accessories

B3. Stainless Steel Ties

C1. Wiring Duct

C2. Surface Raceway

C3. Abrasion Protection

C4. Cable Management

D1. Terminals

D2. Power Connectors

D3. Grounding Connectors

E1. Labeling Systems

E2. Labels

E3. Pre-Printed & Write-On Markers

E4. Permanent Identification

E5. Lockout/Tagout & Safety Solutions

F. Index

| Part Number          |              | Copper Conductor Size | Figure Dimensions (In.) |      | Panduit Color Code | Panduit Die Index No.‡ | Burdny Die Index No.‡ | T&B Die Index No.‡ | Wire Strip Length (In.) | Std. Pkg. Qty. |
|----------------------|--------------|-----------------------|-------------------------|------|--------------------|------------------------|-----------------------|--------------------|-------------------------|----------------|
|                      |              |                       | B                       | L    |                    |                        |                       |                    |                         |                |
| <b>RSC750-4/0-6</b>  | Reduces From | 750 kcmil             | 2.06                    | 4.66 | Black              | P106                   | 24                    | 106                | 2                       | 1              |
|                      | Reduces To   | 4/0 AWG               | 1.50                    |      | Purple             | P54                    | 15                    | 54                 | 1 5/8                   |                |
| <b>RSC750-X4/0-6</b> | Reduces From | 750 kcmil             | 2.06                    | 4.54 | Black              | P106                   | 24                    | 106                | 2                       | 1              |
|                      | Reduces To   | 4/0 Flex              | 1.50                    |      | Yellow             | P62                    | 16                    | 62                 | 1 7/16                  |                |
| <b>RSC750-X350-6</b> | Reduces From | 750 kcmil             | 2.06                    | 4.45 | Black              | P106                   | 24                    | 106                | 2                       | 1              |
|                      | Reduces To   | 350 Flex              | 1.94                    |      | Blue               | P76                    | 19                    | 76                 | 1 7/8                   |                |
| <b>RSC750-500-6</b>  | Reduces From | 750 kcmil             | 2.06                    | 4.45 | Black              | P106                   | 24                    | 106                | 2                       | 1              |
|                      | Reduces To   | 500 kcmil             | 1.94                    |      | Brown              | P87                    | 20                    | 87                 | 1 7/8                   |                |
| <b>RSC750-X500-6</b> | Reduces From | 750 kcmil             | 2.06                    | 4.63 | Black              | P106                   | 24                    | 106                | 2                       | 1              |
|                      | Reduces To   | 500 Flex              | 2.06                    |      | Pink               | P99                    | 400                   | 99                 | 2                       |                |
| <b>RSC750-750-6</b>  | Reduces From | 750 kcmil             | 2.06                    | 4.63 | Black              | P106                   | 24                    | 106                | 2                       | 1              |
|                      | Reduces To   | 750 kcmil             | 2.06                    |      | Black              | P106                   | 24                    | 106                | 2                       |                |
| <b>RSCX750-4/0-3</b> | Reduces From | 750 Flex              | 2.06                    | 5.04 | Yellow             | P115                   | 115                   | 115                | 2                       | 1              |
|                      | Reduces To   | 4/0 AWG               | 1.50                    |      | Purple             | P54                    | 15                    | 54                 | 1 5/8                   |                |
| <b>RSCX750-750-3</b> | Reduces From | 750 Flex              | 2.06                    | 4.50 | Yellow             | P115                   | 115                   | 115                | 2                       | 1              |
|                      | Reduces To   | 750 kcmil             | 2.06                    |      | Black              | P106                   | 24                    | 106                | 2                       |                |

‡See pages D3.76 – D3.81 for tool and die information.

\*\*Consult cable manufacturer for voltage stress relief instructions with applications greater than 2000 V.

## Part Number System for Metric Lugs

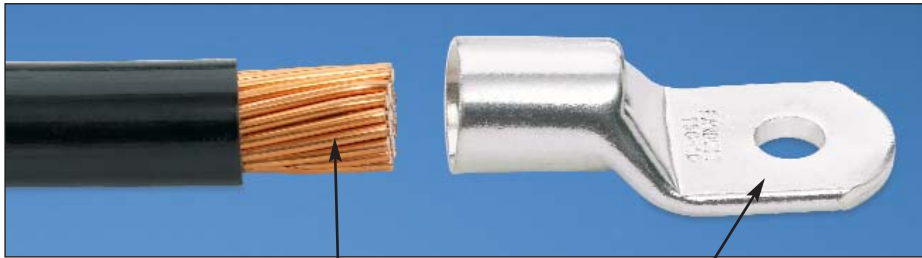

**LCMA**                      **150**                      —                      **10**                      —

150 = 150mm<sup>2</sup>                      10 = 10mm



**X**

1 = 1                      X = 10                      C = 100  
5 = 5                      L = 50

## Part Number System for Pan-Lug™ Compression Metric Lugs

|             |                |   |                    |   |                       |
|-------------|----------------|---|--------------------|---|-----------------------|
| <b>LCMA</b> | <b>150</b>     | — | <b>10</b>          | — | <b>X</b>              |
| Type        | Conductor Size |   | Stud Hole Size     |   | Standard Package Size |
|             |                |   | 5 = #5             |   | 1 = 1                 |
|             |                |   | 6 = 6mm            |   | 5 = 5                 |
|             |                |   | 8 = 8mm            |   | 6 = 6                 |
|             |                |   | 10 = 10mm          |   | X = 10                |
|             |                |   | 12 = 12mm          |   | Q = 25                |
|             |                |   | 14 = 14mm          |   | L = 50                |
|             |                |   | 16 = 16mm          |   | C = 100               |
|             |                |   | 20 = 20mm          |   |                       |
|             |                |   | 00 = Blank Tongue* |   |                       |

## Metric Conductor, One-Hole, Standard Barrel with Window Lug

### For Use with Class 2 Stranded Copper Conductors

#### Type LCMA

- Inspection window to visually assure full conductor insertion
- Tin-plated to inhibit corrosion
- UL Listed, UL Recognized, and CSA Certified to 35 KV\*\* and temperature rated to 90°C when crimped with Panduit tools and dies

- Product information marked on connector for selection and installation
- Rounded tongue convenient for use in tight spaces
- Internally beveled wire entry for fast and easy installation

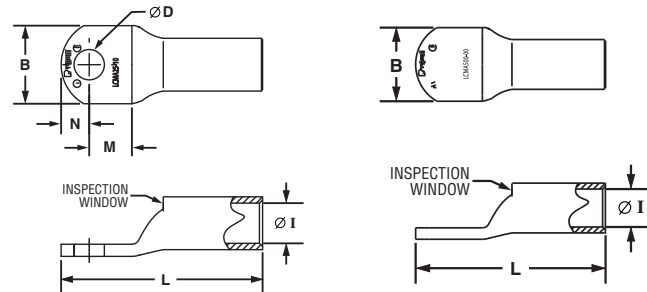

| Part Number | Copper Conductor Size Class 2R (mm <sup>2</sup> ) | Current Rating (Amps) | Stud Hole Size (mm) | Figure Dimensions (mm) |      |     |     |      |     | Panduit Die Index No.‡ | Std. Pkg. Qty. |
|-------------|---|-----------------------|---------------------|------------------------|------|-----|-----|------|-----|------------------------|----------------|
|             |   |                       |                     | ØI                     | B    | M   | N   | L    | ØD  |                        |                |
| LCMA6-5-C*  | 4 – 6   | 30                    | M5                  | 3.8                    | 10.0 | 7.8 | 6.2 | 27.5 | 5.5 | P10                    | 100            |
| LCMA6-6-C*  | 4 – 6   | 30                    | M6                  | 3.8                    | 10.8 | 7.8 | 6.2 | 27.5 | 6.6 | P10                    | 100            |
| LCMA6-8-C*  | 4 – 6   | 30                    | M8                  | 3.8                    | 13.0 | 8.0 | 8.0 | 30.5 | 9.0 | P10                    | 100            |

‡See page D3.83 for tool and die information.

\*UL Recognized only.

\*\*Consult cable manufacturer for voltage stress relief instructions with applications greater than 2000 V.

Table continues on page D2.108

A. System Overview

B1. Cable Ties

B2. Cable Accessories

B3. Stainless Steel Ties

C1. Wiring Duct

C2. Surface Raceway

C3. Abrasion Protection

C4. Cable Management

D1. Terminals

D2. Power Connectors

D3. Grounding Connectors

E1. Labeling Systems

E2. Labels

E3. Pre-Printed & Write-On Markers

E4. Permanent Identification

E5. Lockout/Tagout & Safety Solutions

F. Index



## Metric Conductor, One-Hole, Standard Barrel with Window Lug (continued)

| Part Number   | Copper Conductor Size Class 2R (mm <sup>2</sup> ) | Current Rating (Amps) | Stud Hole Size (mm) | Figure Dimensions (mm) |      |      |      |       |      | Panduit Die Index No.‡ | Std. Pkg. Qty. |
|---------------|---|-----------------------|---------------------|------------------------|------|------|------|-------|------|------------------------|----------------|
|               |   |                       |                     | ØI                     | B    | M    | N    | L     | ØD   |                        |                |
| LCMA10-5-C    | 10  | —                     | M5                  | 4.5                    | 11.0 | 9.8  | 6.0  | 30.8  | 5.5  | P21                    | 100            |
| LCMA10-6-C    | 10  | —                     | M6                  | 4.5                    | 11.0 | 9.8  | 6.0  | 30.8  | 6.6  | P21                    | 100            |
| LCMA10-8-C    | 10  | —                     | M8                  | 4.5                    | 13.0 | 8.5  | 8.0  | 30.8  | 9.0  | P21                    | 100            |
| LCMA10-10-C   | 10  | —                     | M10                 | 4.4                    | 14.5 | 8.5  | 8.0  | 30.8  | 11.0 | P21                    | 100            |
| LCMA16-5-C*   | 16  | 65                    | M5                  | 5.5                    | 13.0 | 10.3 | 6.5  | 34.5  | 5.5  | P24                    | 100            |
| LCMA16-6-C*   | 16  | 65                    | M6                  | 5.5                    | 13.0 | 10.3 | 6.5  | 34.5  | 6.6  | P24                    | 100            |
| LCMA16-8-C*   | 16  | 65                    | M8                  | 5.5                    | 13.0 | 10.3 | 6.5  | 34.5  | 9.0  | P24                    | 100            |
| LCMA16-10-C*  | 16  | 65                    | M10                 | 5.5                    | 15.0 | 10.2 | 8.0  | 36.7  | 11.0 | P24                    | 100            |
| LCMA25-6-C    | 25  | —                     | M6                  | 6.9                    | 14.0 | 10.0 | 8.0  | 37.0  | 6.6  | P29                    | 100            |
| LCMA25-8-C    | 25  | —                     | M8                  | 6.9                    | 15.5 | 10.0 | 8.0  | 37.0  | 9.0  | P29                    | 100            |
| LCMA25-10-C   | 25  | —                     | M10                 | 6.9                    | 15.5 | 10.0 | 8.0  | 37.0  | 11.0 | P29                    | 100            |
| LCMA35-6-C    | 35  | —                     | M6                  | 8.2                    | 15.5 | 12.3 | 8.5  | 42.0  | 6.6  | P29                    | 100            |
| LCMA35-8-C    | 35  | —                     | M8                  | 8.2                    | 15.5 | 12.3 | 8.5  | 42.0  | 9.0  | P29                    | 100            |
| LCMA35-10-C   | 35  | —                     | M10                 | 8.2                    | 15.5 | 12.3 | 8.5  | 42.0  | 11.0 | P29                    | 100            |
| LCMA35-12-C   | 35  | —                     | M12                 | 8.2                    | 21.5 | 14.5 | 11.5 | 48.0  | 14.0 | P29                    | 100            |
| LCMA50-6-L    | 50  | —                     | M6                  | 9.8                    | 18.0 | 11.5 | 10.0 | 46.5  | 6.6  | P37                    | 50             |
| LCMA50-8-L    | 50  | —                     | M8                  | 9.8                    | 18.0 | 11.5 | 10.0 | 46.5  | 9.0  | P37                    | 50             |
| LCMA50-10-L   | 50  | —                     | M10                 | 9.8                    | 18.0 | 11.5 | 10.0 | 46.5  | 11.0 | P37                    | 50             |
| LCMA50-12-L   | 50  | —                     | M12                 | 9.8                    | 23.0 | 14.0 | 11.0 | 50.0  | 14.0 | P37                    | 50             |
| LCMA70-6-L    | 70  | —                     | M6                  | 11.5                   | 20.8 | 14.5 | 11.5 | 53.5  | 6.6  | P45                    | 50             |
| LCMA70-8-L    | 70  | —                     | M8                  | 11.5                   | 20.8 | 14.5 | 11.5 | 53.5  | 9.0  | P45                    | 50             |
| LCMA70-10-L   | 70  | —                     | M10                 | 11.5                   | 20.8 | 14.5 | 11.5 | 53.5  | 11.0 | P45                    | 50             |
| LCMA70-12-L   | 70  | —                     | M12                 | 11.5                   | 20.8 | 14.5 | 11.5 | 53.5  | 14.0 | P45                    | 50             |
| LCMA95-8-L    | 95  | —                     | M8                  | 13.5                   | 24.5 | 15.0 | 13.5 | 60.5  | 9.0  | P54                    | 50             |
| LCMA95-10-L   | 95  | —                     | M10                 | 13.5                   | 24.5 | 15.0 | 13.5 | 60.5  | 11.0 | P54                    | 50             |
| LCMA95-12-L   | 95  | —                     | M12                 | 13.5                   | 24.5 | 15.0 | 13.5 | 60.5  | 14.0 | P54                    | 50             |
| LCMA95-16-L   | 95  | —                     | M16                 | 13.5                   | 24.5 | 15.0 | 13.5 | 60.5  | 18.0 | P54                    | 50             |
| LCMA120-8-L   | 120   | —                     | M8                  | 15.2                   | 27.5 | 15.5 | 14.5 | 65.0  | 9.0  | P62                    | 50             |
| LCMA120-10-L  | 120   | —                     | M10                 | 15.2                   | 27.5 | 15.5 | 14.5 | 65.0  | 11.0 | P62                    | 50             |
| LCMA120-12-L  | 120   | —                     | M12                 | 15.2                   | 27.5 | 15.5 | 14.5 | 65.0  | 14.0 | P62                    | 50             |
| LCMA120-16-L  | 120   | —                     | M16                 | 15.2                   | 27.5 | 15.5 | 14.5 | 65.0  | 18.0 | P62                    | 50             |
| LCMA150-8-X   | 150   | —                     | M8                  | 16.5                   | 30.5 | 18.0 | 16.5 | 70.5  | 9.0  | P66                    | 10             |
| LCMA150-10-X  | 150   | —                     | M10                 | 16.5                   | 30.5 | 18.0 | 16.5 | 70.5  | 11.0 | P66                    | 10             |
| LCMA150-12-X  | 150   | —                     | M12                 | 16.5                   | 30.5 | 18.0 | 16.5 | 70.5  | 14.0 | P66                    | 10             |
| LCMA150-16-X  | 150   | —                     | M16                 | 16.5                   | 30.5 | 18.0 | 16.5 | 70.5  | 18.0 | P66                    | 10             |
| LCMA150-20-X  | 150   | —                     | M20                 | 16.5                   | 30.5 | 22.0 | 16.5 | 74.0  | 22.0 | P66                    | 10             |
| LCMA185-10-X  | 185   | —                     | M10                 | 18.6                   | 33.5 | 16.5 | 17.5 | 72.5  | 11.0 | P76                    | 10             |
| LCMA185-12-X  | 185   | —                     | M12                 | 18.6                   | 33.5 | 16.5 | 17.5 | 72.5  | 14.0 | P76                    | 10             |
| LCMA185-16-X  | 185   | —                     | M16                 | 18.6                   | 33.5 | 16.5 | 17.5 | 72.5  | 18.0 | P76                    | 10             |
| LCMA185-20-X  | 185   | —                     | M20                 | 18.6                   | 33.5 | 21.0 | 17.5 | 77.0  | 22.0 | P76                    | 10             |
| LCMA240-10-X  | 240   | —                     | M10                 | 20.8                   | 37.5 | 21.0 | 19.5 | 86.5  | 11.0 | P87                    | 10             |
| LCMA240-12-X  | 240   | —                     | M12                 | 20.8                   | 37.5 | 21.0 | 19.5 | 86.5  | 14.0 | P87                    | 10             |
| LCMA240-16-X  | 240   | —                     | M16                 | 20.8                   | 37.5 | 21.0 | 19.5 | 86.5  | 18.0 | P87                    | 10             |
| LCMA240-20-X  | 240   | —                     | M20                 | 20.8                   | 37.5 | 21.0 | 19.5 | 86.5  | 22.0 | P87                    | 10             |
| LCMA300-10-5  | 300   | —                     | M10                 | 23.5                   | 42.5 | 22.0 | 20.0 | 94.5  | 11.0 | P94                    | 5              |
| LCMA300-12-5  | 300   | —                     | M12                 | 23.5                   | 42.5 | 22.0 | 20.0 | 94.5  | 14.0 | P94                    | 5              |
| LCMA300-16-5  | 300   | —                     | M16                 | 23.5                   | 42.5 | 22.0 | 20.0 | 94.5  | 18.0 | P94                    | 5              |
| LCMA300-20-5  | 300   | —                     | M20                 | 23.5                   | 42.5 | 22.0 | 20.0 | 94.5  | 22.0 | P94                    | 5              |
| LCMA400-12-5  | 400   | —                     | M12                 | 27.0                   | 49.5 | 26.5 | 23.5 | 107.0 | 14.0 | P106                   | 5              |
| LCMA400-16-5  | 400   | —                     | M16                 | 27.0                   | 49.5 | 26.5 | 23.5 | 107.0 | 18.0 | P106                   | 5              |
| LCMA400-20-5  | 400   | —                     | M20                 | 27.0                   | 49.5 | 26.5 | 23.5 | 107.0 | 22.0 | P106                   | 5              |
| LCMA500-12-1  | 500   | —                     | M12                 | 31.0                   | 57.5 | 28.5 | 25.5 | 120.0 | 14.0 | P125                   | 1              |
| LCMA500-16-1  | 500   | —                     | M16                 | 31.0                   | 57.5 | 28.5 | 25.5 | 120.0 | 18.0 | P125                   | 1              |
| LCMA500-20-1  | 500   | —                     | M20                 | 31.0                   | 57.5 | 28.5 | 25.5 | 120.0 | 22.0 | P125                   | 1              |
| LCMA500-00-1* | 500   | —                     | Blank               | 31.0                   | 57.5 | —    | —    | 120.0 | —    | P125                   | 1              |
| LCMA630-16-1  | 630   | —                     | M16                 | 34.5                   | 63.0 | 28.5 | 27.5 | 131.0 | 18.0 | P125                   | 1              |
| LCMA630-20-1  | 630   | —                     | M20                 | 34.5                   | 63.0 | 28.5 | 27.5 | 131.0 | 22.0 | P125                   | 1              |
| LCMA630-00-1* | 630   | —                     | Blank               | 34.5                   | 63.0 | —    | —    | 131.0 | —    | P125                   | 1              |

‡See page D3.83 for tool and die information.

\*UL Recognized only.

\*\*Consult cable manufacturer for voltage stress relief instructions with applications greater than 2000 V.





## Metric Conductor, Two-Hole, Standard Barrel with Window Lug

For Use with Class 2 Stranded Copper Conductors

### Type LCMD

- Inspection window to visually assure full conductor insertion
- Tin-plated to inhibit corrosion
- UL Listed, UL Recognized, and CSA Certified to 35 KV\*\* and temperature rated to 90°C when crimped with Panduit tools and dies
- Product information marked on connector for selection and installation
- Internally beveled wire entry for fast and easy installation

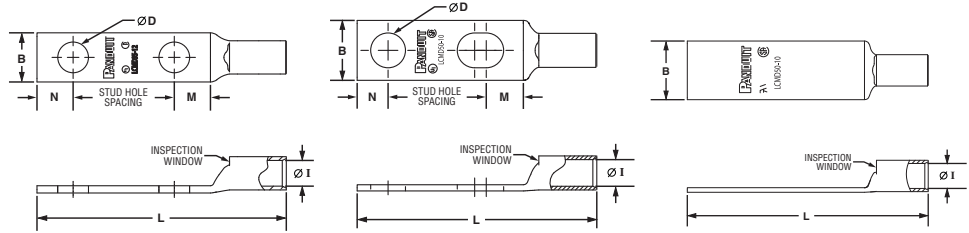

| Part Number   | Copper Conductor Size Class 2R (mm <sup>2</sup> ) | Current Rating (Amps) | Stud Hole Size (mm) | Stud Hole Spacing (mm) | Figure Dimensions (mm) |      |      |      |       |      | Panduit Die Index No.‡ | Std. Pkg. Qty. |
|---------------|---|-----------------------|---------------------|------------------------|------------------------|------|------|------|-------|------|------------------------|----------------|
|               |   |                       |                     |                        | ØI                     | B    | M    | N    | L     | ØD   |                        |                |
| LCMD6-5CD-Q*  | 4 – 6   | 30                    | M5                  | 22.0 – 25.0            | 3.8                    | 10.0 | 7.8  | 6.2  | 52.5  | 5.5  | P10                    | 25             |
| LCMD10-6CD-Q  | 10  | —                     | M6                  | 22.0 – 25.0            | 4.5                    | 11.0 | 9.8  | 6.0  | 55.8  | 6.6  | P21                    | 25             |
| LCMD10-8-Q    | 10  | —                     | M8                  | 44.5                   | 4.5                    | 13.0 | 8.5  | 8.0  | 75.3  | 9.0  | P21                    | 25             |
| LCMD10-00-Q*  | 10  | —                     | Blank               | —                      | 4.4                    | 14.5 | —    | —    | 75.3  | —    | P21                    | 25             |
| LCMD16-6CD-Q* | 16  | 65                    | M6                  | 22.0 – 25.0            | 5.5                    | 13.0 | 10.3 | 6.5  | 59.5  | 6.6  | P24                    | 25             |
| LCMD16-8-Q*   | 16  | 65                    | M8                  | 44.5                   | 5.5                    | 13.0 | 10.3 | 6.5  | 79.0  | 9.0  | P24                    | 25             |
| LCMD16-00-Q*  | 16  | 65                    | Blank               | —                      | 5.5                    | 15.0 | —    | —    | 81.2  | —    | P24                    | 25             |
| LCMD25-8CD-Q* | 25  | —                     | M8                  | 22.0 – 25.0            | 6.9                    | 15.5 | 10.0 | 8.0  | 62.0  | 9.0  | P29                    | 25             |
| LCMD25-8-Q    | 25  | —                     | M8                  | 44.5                   | 6.9                    | 15.5 | 10.0 | 8.0  | 81.5  | 9.0  | P29                    | 25             |
| LCMD25-10-Q   | 25  | —                     | M10                 | 44.5                   | 6.9                    | 15.5 | 10.0 | 8.0  | 81.5  | 11.0 | P29                    | 25             |
| LCMD25-12-Q   | 25  | —                     | M12                 | 44.5                   | 7.1                    | 20.0 | 14.5 | 11.5 | 89.5  | 14.0 | P29                    | 25             |
| LCMD25-00-Q*  | 25  | —                     | Blank               | —                      | 7.1                    | 20.0 | —    | —    | 89.5  | —    | P29                    | 25             |
| LCMD35-8CD-Q  | 35  | —                     | M8                  | 22.0 – 25.0            | 8.2                    | 15.5 | 12.3 | 8.5  | 67.0  | 9.0  | P29                    | 25             |
| LCMD35-10-Q   | 35  | —                     | M10                 | 44.5                   | 8.2                    | 15.5 | 12.3 | 8.5  | 86.5  | 11.0 | P29                    | 25             |
| LCMD35-12-Q   | 35  | —                     | M12                 | 44.5                   | 8.2                    | 21.5 | 14.5 | 11.5 | 92.5  | 14.0 | P29                    | 25             |
| LCMD35-00-Q*  | 35  | —                     | Blank               | —                      | 8.2                    | 21.5 | —    | —    | 92.5  | —    | P29                    | 25             |
| LCMD50-10CD-X | 50  | —                     | M10                 | 22.0 – 25.0            | 9.8                    | 18.0 | 11.5 | 10.0 | 71.5  | 11.0 | P37                    | 10             |
| LCMD50-10-X   | 50  | —                     | M10                 | 44.5                   | 9.8                    | 18.0 | 11.5 | 10.0 | 91.0  | 11.0 | P37                    | 10             |
| LCMD50-12-X   | 50  | —                     | M12                 | 44.5                   | 9.8                    | 23.0 | 14.0 | 11.0 | 94.5  | 14.0 | P37                    | 10             |
| LCMD50-00-X*  | 50  | —                     | Blank               | —                      | 9.8                    | 23.0 | —    | —    | 94.5  | —    | P37                    | 10             |
| LCMD70-10CD-X | 70  | —                     | M10                 | 22.0 – 25.0            | 11.5                   | 20.5 | 14.5 | 11.0 | 78.5  | 11.0 | P45                    | 10             |
| LCMD70-10-X   | 70  | —                     | M10                 | 44.5                   | 11.5                   | 20.8 | 14.5 | 11.5 | 98.0  | 11.0 | P45                    | 10             |
| LCMD70-12-X   | 70  | —                     | M12                 | 44.5                   | 11.5                   | 20.8 | 14.5 | 11.5 | 98.0  | 14.0 | P45                    | 10             |
| LCMD70-00-X*  | 70  | —                     | Blank               | —                      | 11.5                   | 20.8 | —    | —    | 98.0  | —    | P45                    | 10             |
| LCMD95-10CD-X | 95  | —                     | M10                 | 22.0 – 25.0            | 13.5                   | 24.5 | 15.0 | 13.0 | 85.5  | 11.0 | P54                    | 10             |
| LCMD95-12-X   | 95  | —                     | M12                 | 44.5                   | 13.5                   | 24.5 | 15.0 | 13.5 | 105.0 | 14.0 | P54                    | 10             |
| LCMD95-14-X   | 95  | —                     | M14                 | 44.5                   | 13.5                   | 24.5 | 15.0 | 13.5 | 105.0 | 16.0 | P54                    | 10             |
| LCMD95-00-X*  | 95  | —                     | Blank               | —                      | 13.5                   | 24.5 | —    | —    | 105.0 | —    | P54                    | 10             |

‡See page D3.83 for tool and die information.

\*UL Recognized only.

\*\*Consult cable manufacturer for voltage stress relief instructions with applications greater than 2000 V.

Table continues on page D2.110

A. System Overview

B1. Cable Ties

B2. Cable Accessories

B3. Stainless Steel Ties

C1. Wiring Duct

C2. Surface Raceway

C3. Abrasion Protection

C4. Cable Management

D1. Terminals

D2. Power Connectors

D3. Grounding Connectors

E1. Labeling Systems

E2. Labels

E3. Pre-Printed & Write-On Markers

E4. Permanent Identification

E5. Lockout/Tagout & Safety Solutions

F. Index

# PANDUIT® ELECTRICAL SOLUTIONS

A.  
System  
Overview



## Metric Conductor, Two-Hole, Standard Barrel with Window Lug (continued)

B1.  
Cable Ties

B2.  
Cable  
Accessories

B3.  
Stainless  
Steel Ties

C1.  
Wiring  
Duct

C2.  
Surface  
Raceway

C3.  
Abrasion  
Protection

C4.  
Cable  
Management

D1.  
Terminals

D2.  
Power  
Connectors

D3.  
Grounding  
Connectors

E1.  
Labeling  
Systems

E2.  
Labels

E3.  
Pre-Printed  
& Write-On  
Markers

E4.  
Permanent  
Identification

E5.  
Lockout/  
Tagout  
& Safety  
Solutions

F.  
Index

| Part Number           | Copper Conductor Size Class 2R (mm <sup>2</sup> ) | Current Rating (Amps) | Stud Hole Size (mm) | Stud Hole Spacing (mm) | Figure Dimensions (mm) |      |      |      |       |      | Panduit Die Index No.‡ | Std. Pkg. Qty. |
|-----------------------|---|-----------------------|---------------------|------------------------|------------------------|------|------|------|-------|------|------------------------|----------------|
|                       |   |                       |                     |                        | ØI                     | B    | M    | N    | L     | ØD   |                        |                |
| <b>LCMD120-10CD-X</b> | 120   | —                     | M10                 | 22.0 – 25.0            | 15.2                   | 27.5 | 15.5 | 14.0 | 90.0  | 11.0 | P62                    | 10             |
| <b>LCMD120-12-X</b>   | 120   | —                     | M12                 | 44.5                   | 15.2                   | 27.5 | 15.5 | 14.5 | 109.5 | 14.0 | P62                    | 10             |
| <b>LCMD120-14-X</b>   | 120   | —                     | M14                 | 44.5                   | 15.2                   | 27.5 | 15.5 | 14.5 | 109.5 | 16.0 | P62                    | 10             |
| <b>LCMD120-00-X*</b>  | 120   | —                     | Blank               | —                      | 15.2                   | 27.5 | —    | —    | 109.5 | —    | P62                    | 10             |
| <b>LCMD150-10CD-X</b> | 150   | —                     | M10                 | 22.0 – 25.0            | 16.5                   | 30.5 | 18.0 | 16.0 | 95.5  | 11.0 | P66                    | 10             |
| <b>LCMD150-12-X</b>   | 150   | —                     | M12                 | 44.5                   | 16.5                   | 30.5 | 18.0 | 16.5 | 115.0 | 14.0 | P66                    | 10             |
| <b>LCMD150-14-X</b>   | 150   | —                     | M14                 | 44.5                   | 16.5                   | 30.5 | 22.0 | 16.5 | 118.5 | 16.0 | P66                    | 10             |
| <b>LCMD150-00-X*</b>  | 150   | —                     | Blank               | —                      | 16.5                   | 30.5 | —    | —    | 118.5 | —    | P66                    | 10             |
| <b>LCMD185-10CD-X</b> | 185   | —                     | M10                 | 22.0 – 25.0            | 18.6                   | 33.5 | 16.5 | 17.0 | 97.5  | 11.0 | P76                    | 10             |
| <b>LCMD185-12-X</b>   | 185   | —                     | M12                 | 44.5                   | 18.6                   | 33.5 | 16.5 | 17.5 | 117.0 | 14.0 | P76                    | 10             |
| <b>LCMD185-14-X</b>   | 185   | —                     | M14                 | 44.5                   | 18.6                   | 33.5 | 21.0 | 17.5 | 121.5 | 16.0 | P76                    | 10             |
| <b>LCMD185-00-X*</b>  | 185   | —                     | Blank               | —                      | 18.6                   | 33.5 | —    | —    | 121.5 | —    | P76                    | 10             |
| <b>LCMD240-10CD-5</b> | 240   | —                     | M10                 | 22.0 – 25.0            | 20.8                   | 37.5 | 21.0 | 19.0 | 111.5 | 11.0 | P87                    | 5              |
| <b>LCMD240-12-5</b>   | 240   | —                     | M12                 | 44.5                   | 20.8                   | 37.5 | 21.0 | 19.5 | 131.0 | 14.0 | P87                    | 5              |
| <b>LCMD240-14-5</b>   | 240   | —                     | M14                 | 44.5                   | 20.8                   | 37.5 | 21.0 | 19.5 | 131.0 | 16.0 | P87                    | 5              |
| <b>LCMD240-00-5*</b>  | 240   | —                     | Blank               | —                      | 20.8                   | 37.5 | —    | —    | 131.0 | —    | P87                    | 5              |
| <b>LCMD300-12-5</b>   | 300   | —                     | M12                 | 44.5                   | 23.5                   | 42.5 | 22.0 | 20.0 | 139.0 | 14.0 | P94                    | 5              |
| <b>LCMD300-14-5</b>   | 300   | —                     | M14                 | 44.5                   | 23.5                   | 42.5 | 22.0 | 20.0 | 139.0 | 16.0 | P94                    | 5              |
| <b>LCMD300-00-5*</b>  | 300   | —                     | Blank               | —                      | 23.5                   | 42.5 | —    | —    | 139.0 | —    | P94                    | 5              |
| <b>LCMD400-12-5</b>   | 400   | —                     | M12                 | 44.5                   | 27.0                   | 49.5 | 26.5 | 23.5 | 151.5 | 14.0 | P106                   | 5              |
| <b>LCMD400-14-5</b>   | 400   | —                     | M14                 | 44.5                   | 27.0                   | 49.5 | 26.5 | 23.5 | 151.5 | 16.0 | P106                   | 5              |
| <b>LCMD400-16-5</b>   | 400   | —                     | M16                 | 44.5                   | 27.0                   | 49.5 | 26.5 | 23.5 | 151.5 | 18.0 | P106                   | 5              |
| <b>LCMD400-00-5*</b>  | 400   | —                     | Blank               | —                      | 27.0                   | 49.5 | —    | —    | 151.5 | —    | P106                   | 5              |
| <b>LCMD500-12-1</b>   | 500   | —                     | M12                 | 44.5                   | 31.0                   | 57.5 | 28.5 | 25.5 | 164.5 | 14.0 | P125                   | 1              |
| <b>LCMD500-14-1</b>   | 500   | —                     | M14                 | 44.5                   | 31.0                   | 57.5 | 28.5 | 25.5 | 164.5 | 16.0 | P125                   | 1              |
| <b>LCMD500-16-1</b>   | 500   | —                     | M16                 | 44.5                   | 31.0                   | 57.5 | 28.5 | 25.5 | 164.5 | 18.0 | P125                   | 1              |
| <b>LCMD500-00-1*</b>  | 500   | —                     | Blank               | —                      | 31.0                   | 57.5 | —    | —    | 164.5 | —    | P125                   | 1              |
| <b>LCMD630-12-1</b>   | 630   | —                     | M12                 | 44.5                   | 34.5                   | 63.0 | 28.5 | 27.5 | 175.5 | 14.0 | P125                   | 1              |
| <b>LCMD630-14-1</b>   | 630   | —                     | M14                 | 44.5                   | 34.5                   | 63.0 | 28.5 | 27.5 | 175.5 | 16.0 | P125                   | 1              |
| <b>LCMD630-16-1</b>   | 630   | —                     | M16                 | 44.5                   | 34.5                   | 63.0 | 28.5 | 27.5 | 175.5 | 18.0 | P125                   | 1              |
| <b>LCMD630-00-1*</b>  | 630   | —                     | Blank               | —                      | 34.5                   | 63.0 | —    | —    | 175.5 | —    | P125                   | 1              |

‡See page D3.83 for tool and die information.

\*UL Recognized only.

\*\*Consult cable manufacturer for voltage stress relief instructions with applications greater than 2000 V.



## Metric Conductor, Standard Barrel, Butt Splice

For Use with Class 2 Stranded Copper Conductors

### Type SCMS

- Tin-plated to inhibit corrosion
- UL Listed, UL Recognized, and CSA Certified to 35 KV\*\* and temperature rated to 90°C when crimped with Panduit tools and dies
- Product information marked on connector for selection and installation
- Internally beveled wire entry for fast and easy installation

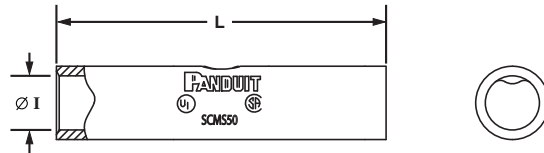

| Part Number | Copper Conductor Size Class 2R (mm <sup>2</sup> ) | Current Rating (Amps) | Figure Dimensions (mm) |       | Panduit Die Index No. ‡ | Std. Pkg. Qty. |
|-------------|---|-----------------------|------------------------|-------|-------------------------|----------------|
|             |   |                       | ØI                     | L     |                         |                |
| SCMS10-C*   | 10  | 50                    | 4.5                    | 30.0  | P21                     | 100            |
| SCMS16-C*   | 16  | 65                    | 5.5                    | 35.0  | P24                     | 100            |
| SCMS25-L    | 25  | —                     | 6.9                    | 36.0  | P29                     | 50             |
| SCMS35-L    | 35  | —                     | 8.2                    | 36.0  | P29                     | 50             |
| SCMS50-L    | 50  | —                     | 9.8                    | 49.0  | P37                     | 50             |
| SCMS70-L    | 70  | —                     | 11.5                   | 52.0  | P45                     | 50             |
| SCMS95-Q    | 95  | —                     | 13.5                   | 54.0  | P54                     | 25             |
| SCMS120-Q   | 120   | —                     | 15.2                   | 57.0  | P62                     | 25             |
| SCMS150-X   | 150   | —                     | 16.5                   | 57.0  | P66                     | 10             |
| SCMS185-X   | 185   | —                     | 18.6                   | 61.0  | P76                     | 10             |
| SCMS240-X   | 240   | —                     | 20.8                   | 72.0  | P87                     | 10             |
| SCMS300-5   | 300   | —                     | 23.5                   | 75.0  | P94                     | 5              |
| SCMS400-5   | 400   | —                     | 27.0                   | 95.0  | P106                    | 5              |
| SCMS500-6   | 500   | —                     | 31.0                   | 96.0  | P125                    | 6              |
| SCMS630-6   | 630   | —                     | 34.5                   | 131.0 | P125                    | 6              |

‡See page D3.83 for tool and die information.

\*UL Recognized only.

\*\*Consult cable manufacturer for voltage stress relief instructions with applications greater than 2000 V.

A. System Overview

B1. Cable Ties

B2. Cable Accessories

B3. Stainless Steel Ties

C1. Wiring Duct

C2. Surface Raceway

C3. Abrasion Protection

C4. Cable Management

D1. Terminals

D2. Power Connectors

D3. Grounding Connectors

E1. Labeling Systems

E2. Labels

E3. Pre-Printed & Write-On Markers

E4. Permanent Identification

E5. Lockout/Tagout & Safety Solutions

F. Index

A. System Overview



## Code Conductor, One-Hole, Aluminum Lug

B1. Cable Ties

**For Use with Stranded Aluminum or Copper Code Conductors**

B2. Cable Accessories

### Type LAA

- Manufactured from high conductivity thick wall wrought aluminum
- Enclosed barrel prevents corrosive material from entering barrel when used in harsh environments
- Factory pre-filled with joint compound and sealed with easy pull-out end plug to inhibit corrosion
- Tin-plated to inhibit corrosion
- Color-coded end plug and Panduit and specified competitor die index numbers marked on barrel for proper crimp die selection
- UL Listed and CSA Certified to 35 KV\*\* and temperature rated to 90°C when crimped with Panduit and specified competitor crimping tools and dies

B3. Stainless Steel Ties

C1. Wiring Duct



C2. Surface Raceway

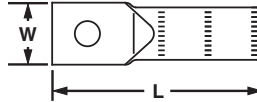

C3. Abrasion Protection

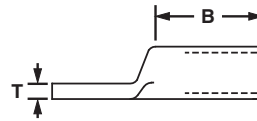

C4. Cable Management

| Part Number  | Aluminum or Copper Conductor Size | Stud Hole Size (In.) | Figure Dimensions (In.) |      |      |      | Panduit Color Code | Panduit Die Index No.‡ | Burdny Die Index No.‡ | T&B Die Index No.‡ | Wire Strip Length (In.) | Std. Pkg. Qty. |
|--------------|-----------------------------------|----------------------|-------------------------|------|------|------|--------------------|------------------------|-----------------------|--------------------|-------------------------|----------------|
|              |                                   |                      | W                       | B    | T    | L    |                    |                        |                       |                    |                         |                |
| LAA6-14-X    | #6 AWG                            | 1/4                  | 0.55                    | 0.86 | 0.11 | 2.20 | Gray               | P29                    | 346                   | 29                 | 1                       | 10             |
| LAA6-56-X    |                                   | 5/16                 | 0.55                    | 1.00 | 0.11 | 2.20 | Gray               | P29                    | 346                   | 29                 | 1                       | 10             |
| LAA4-14-X    | #4 AWG                            | 1/4                  | 0.66                    | 1.05 | 0.19 | 2.05 | Green              | P37                    | 375                   | 37                 | 1 1/16                  | 10             |
| LAA4-56-X    |                                   | 5/16                 | 0.69                    | 1.08 | 0.16 | 2.23 | Green              | P37                    | 375                   | 37                 | 1 1/16                  | 10             |
| LAA4-38-X    | #2 AWG                            | 3/8                  | 0.69                    | 0.92 | 0.16 | 2.33 | Green              | P37                    | 375                   | 37                 | 1 1/16                  | 10             |
| LAA2-14-X    |                                   | 1/4                  | 0.75                    | 0.98 | 0.17 | 2.63 | Pink               | P42                    | 348                   | 42                 | 1                       | 10             |
| LAA2-56-X    | #2 AWG                            | 5/16                 | 0.75                    | 0.98 | 0.17 | 2.63 | Pink               | P42                    | 348                   | 42                 | 1                       | 10             |
| LAA2-38-X    |                                   | 3/8                  | 0.75                    | 0.98 | 0.17 | 2.63 | Pink               | P42                    | 348                   | 42                 | 1                       | 10             |
| LAA1-14-X    | #1 AWG                            | 1/4                  | 0.75                    | 0.98 | 0.17 | 2.63 | Gold               | P45                    | 471                   | 45                 | 1                       | 10             |
| LAA1-56-X    |                                   | 5/16                 | 0.75                    | 0.98 | 0.17 | 2.63 | Gold               | P45                    | 471                   | 45                 | 1                       | 10             |
| LAA1-38-X    | 1/0 AWG                           | 3/8                  | 0.75                    | 0.98 | 0.17 | 2.63 | Gold               | P45                    | 471                   | 45                 | 1                       | 10             |
| LAA1/0-56-X  |                                   | 5/16                 | 0.88                    | 1.30 | 0.25 | 3.23 | Tan                | P50                    | 296                   | 50                 | 1 9/16                  | 10             |
| LAA1/0-38-X  | 1/0 AWG                           | 3/8                  | 0.88                    | 1.30 | 0.25 | 3.23 | Tan                | P50                    | 296                   | 50                 | 1 9/16                  | 10             |
| LAA1/0-12-X  |                                   | 1/2                  | 0.88                    | 1.30 | 0.25 | 3.23 | Tan                | P50                    | 296                   | 50                 | 1 9/16                  | 10             |
| LAA2/0-38-5  | 2/0 AWG                           | 3/8                  | 0.95                    | 1.31 | 0.23 | 3.19 | Olive              | P54                    | 297                   | 54                 | 1 9/16                  | 5              |
| LAA2/0-12-5  |                                   | 1/2                  | 0.95                    | 1.30 | 0.23 | 3.19 | Olive              | P54                    | 297                   | 54                 | 1 9/16                  | 5              |
| LAA3/0-38-5  | 3/0 AWG                           | 3/8                  | 1.07                    | 1.50 | 0.25 | 3.44 | Ruby               | P60                    | 467                   | 60                 | 1 9/16                  | 5              |
| LAA3/0-12-5  |                                   | 1/2                  | 1.07                    | 1.50 | 0.25 | 3.44 | Ruby               | P60                    | 467                   | 60                 | 1 9/16                  | 5              |
| LAA4/0-38-5  | 4/0 AWG                           | 3/8                  | 1.19                    | 1.44 | 0.32 | 3.56 | White              | P66                    | 298                   | 66                 | 1 3/4                   | 5              |
| LAA4/0-12-5  |                                   | 1/2                  | 1.19                    | 1.44 | 0.32 | 3.56 | White              | P66                    | 298                   | 66                 | 1 3/4                   | 5              |
| LAA250-38-5  | 250 kcmil                         | 3/8                  | 1.24                    | 1.56 | 0.30 | 3.63 | Red                | P71                    | 324                   | 71                 | 1 9/16                  | 5              |
| LAA250-12-5  |                                   | 1/2                  | 1.24                    | 1.56 | 0.30 | 3.63 | Red                | P71                    | 324                   | 71                 | 1 9/16                  | 5              |
| LAA300-38-2  | 300 kcmil                         | 3/8                  | 1.38                    | 2.25 | 0.34 | 4.05 | Blue               | P76                    | 470                   | 76                 | 2 5/16                  | 2              |
| LAA300-12-2  |                                   | 1/2                  | 1.38                    | 2.25 | 0.34 | 4.05 | Blue               | P76                    | 470                   | 76                 | 2 5/16                  | 2              |
| LAA350-12-2  | 350 kcmil                         | 1/2                  | 1.50                    | 2.25 | 0.38 | 4.30 | Brown              | P87                    | 299                   | 87                 | 2 5/16                  | 2              |
| LAA400-58-2  | 400 kcmil                         | 5/8                  | 1.61                    | 2.50 | 0.41 | 4.92 | Green              | P94                    | 472                   | 94                 | 2 9/16                  | 2              |
| LAA500-12-2  | 500 kcmil                         | 1/2                  | 1.75                    | 3.00 | 0.44 | 5.56 | Pink               | P99                    | 300                   | 99                 | 3 1/16                  | 2              |
| LAA500-58-2  |                                   | 5/8                  | 1.75                    | 3.00 | 0.44 | 5.56 | Pink               | P99                    | 300                   | 99                 | 3 1/16                  | 2              |
| LAA750-58-1  | 750 kcmil                         | 5/8                  | 1.75                    | 3.38 | 0.53 | 6.55 | Red                | P125                   | 301                   | 115                | 3 7/16                  | 1              |
| LAA1000-58-1 | 1000 kcmil                        | 5/8                  | 2.56                    | 4.50 | 0.61 | 7.38 | Brown              | P161                   | 302                   | 161                | 4 3/4                   | 1              |

‡See pages D3.84, D3.85 for tool and die information.

\*\*Consult cable manufacturer for voltage stress relief instructions with applications greater than 2000 V.

See page D2.118 for Panduit joint compounds recommended for pad to pad and conductor connections.



## Code Conductor, Two-Hole, Aluminum Lug

For Use with Stranded Aluminum or Copper Code Conductors

### Type LAB

- Manufactured from high conductivity thick wall wrought aluminum
- Factory pre-filled with joint compound and sealed with easy pull-out end plug to inhibit corrosion
- Color-coded end plug and Panduit and specified competitor die index numbers marked on barrel for proper crimp die selection
- Enclosed barrel prevents corrosive material from entering barrel when used in harsh environments
- Tin-plated to inhibit corrosion
- UL Listed and CSA Certified to 35 KV\*\* and temperature rated to 90°C when crimped with Panduit and specified competitor crimping tools and dies
- Available with NEMA hole sizes and spacing

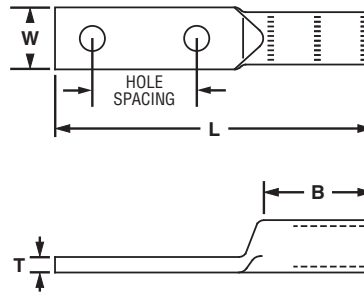

| Part Number    | Aluminum or Copper Conductor Size | Stud Hole Size (In.) | Stud Hole Spacing (In.) | Figure Dimensions (In.) |      |      |      | Panduit Color Code | Panduit Die Index No.‡ | Burdny Die Index No.‡ | T&B Die Index No.‡ | Wire Strip Length (In.) | Std. Pkg. Qty. |
|----------------|-----------------------------------|----------------------|-------------------------|-------------------------|------|------|------|--------------------|------------------------|-----------------------|--------------------|-------------------------|----------------|
|                |                                   |                      |                         | W                       | B    | T    | L    |                    |                        |                       |                    |                         |                |
| ◆ LAB1/0-38-X  | 1/0 AWG                           | 3/8                  | 1.75                    | 0.88                    | 1.55 | 0.25 | 5.33 | Tan                | P50                    | 296                   | 50                 | 1 9/16                  | 10             |
| ◆ LAB2/0-12-5  | 2/0 AWG                           | 1/2                  | 1.75                    | 0.94                    | 1.55 | 0.25 | 5.55 | Olive              | P54                    | 297                   | 54                 | 1 9/16                  | 5              |
| ◆ LAB3/0-12-5  | 3/0 AWG                           | 1/2                  | 1.75                    | 1.03                    | 1.55 | 0.27 | 5.55 | Ruby               | P60                    | 467                   | 60                 | 1 9/16                  | 5              |
| ◆ LAB4/0-12-5  | 4/0 AWG                           | 1/2                  | 1.75                    | 1.19                    | 1.80 | 0.31 | 5.98 | White              | P66                    | 298                   | 66                 | 1 3/4                   | 5              |
| ◆ LAB250-12-5  | 250 kcmil                         | 1/2                  | 1.75                    | 1.25                    | 1.80 | 0.31 | 6.05 | Red                | P71                    | 324                   | 71                 | 1 3/4                   | 5              |
| ◆ LAB300-12-2  | 300 kcmil                         | 1/2                  | 1.75                    | 1.36                    | 2.30 | 0.34 | 6.61 | Blue               | P76                    | 470                   | 76                 | 2 5/16                  | 2              |
| ◆ LAB350-12-2  | 350 kcmil                         | 1/2                  | 1.75                    | 1.50                    | 2.30 | 0.38 | 6.61 | Brown              | P87                    | 299                   | 87                 | 2 5/16                  | 2              |
| ◆ LAB400-12-2  | 400 kcmil                         | 1/2                  | 1.75                    | 1.66                    | 2.55 | 0.38 | 6.92 | Green              | P94                    | 472                   | 94                 | 2 9/16                  | 2              |
| ◆ LAB500-12-2  | 500 kcmil                         | 1/2                  | 1.75                    | 1.72                    | 3.05 | 0.44 | 7.36 | Pink               | P99                    | 300                   | 99                 | 3 1/16                  | 2              |
| ◆ LAB600-12-2  | 600 kcmil                         | 1/2                  | 1.75                    | 1.72                    | 3.05 | 0.50 | 7.55 | Black              | P106                   | 473                   | 106                | 3 1/16                  | 2              |
| ◆ LAB750-12-1  | 750 kcmil                         | 1/2                  | 1.75                    | 1.72                    | 3.42 | 0.56 | 7.31 | Red                | P125                   | 301                   | 115                | 3 7/16                  | 1              |
| ◆ LAB800-12-1  | 800 kcmil                         | 1/2                  | 1.75                    | 1.72                    | 3.42 | 0.59 | 8.30 | Gray               | P140                   | 474                   | 125                | 3 7/16                  | 1              |
| ◆ LAB1000-12-1 | 1000 kcmil                        | 1/2                  | 1.75                    | 2.56                    | 4.67 | 0.63 | 9.67 | Brown              | P161                   | 302                   | 161                | 4 3/4                   | 1              |

‡See pages D3.84, D3.85 for tool and die information.

\*\*Consult cable manufacturer for voltage stress relief instructions with applications greater than 2000 V.

See page D2.118 for Panduit joint compounds recommended for pad to pad and conductor connections.

◆NEMA hole sizes and spacing.

A. System Overview

B1. Cable Ties

B2. Cable Accessories

B3. Stainless Steel Ties

C1. Wiring Duct

C2. Surface Raceway

C3. Abrasion Protection

C4. Cable Management

D1. Terminals

D2. Power Connectors

D3. Grounding Connectors

E1. Labeling Systems

E2. Labels

E3. Pre-Printed & Write-On Markers

E4. Permanent Identification

E5. Lockout/Tagout & Safety Solutions

F. Index

A.  
System  
Overview

## Belleville Compression Washers

B1.  
Cable Ties

### Type CW

- Conical spring washer for use when assembling aluminum connectors to copper and/or steel pads, compensates for differing rates of thermal expansion to keep hardware assembly from loosening

- For assembly information, see page D2.158
- Made from hardened steel to provide high strength
- Cadmium-plated to inhibit corrosion

B2.  
Cable  
Accessories

B3.  
Stainless  
Steel Ties



C1.  
Wiring  
Duct

C2.  
Surface  
Raceway

C3.  
Abrasion  
Protection

C4.  
Cable  
Management

| Part Number | Stud Hole Size (In.) | Figure Dimensions (In.) |     |     | Std. Pkg. Qty. |
|-------------|----------------------|-------------------------|-----|-----|----------------|
|             |                      | D                       | H   | T   |                |
| CW-14-L     | 1/4                  | .68                     | .09 | .05 | 50             |
| CW-56-L     | 5/16                 | .81                     | .08 | .06 | 50             |
| CW-38-L     | 3/8                  | .93                     | .10 | .07 | 50             |
| CW-12-Q     | 1/2                  | 1.18                    | .12 | .09 | 25             |
| CW-58-Q     | 5/8                  | 1.49                    | .15 | .12 | 25             |

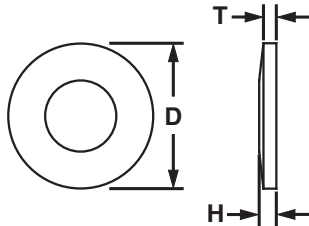

D1.  
Terminals

D2.  
Power  
Connectors

D3.  
Grounding  
Connectors

E1.  
Labeling  
Systems

E2.  
Labels

E3.  
Pre-Printed  
& Write-On  
Markers

E4.  
Permanent  
Identification

E5.  
Lockout/  
Tagout  
& Safety  
Solutions

F.  
Index





## Code Conductor, Aluminum Splice

For Use with Stranded Aluminum-to-Aluminum or Copper-to-Copper Conductors

### Type SA

- Manufactured from high conductivity thick wall wrought aluminum
- Factory pre-filled with joint compound and sealed with easy pull-out end plug to inhibit corrosion
- Color-coded end plugs and Panduit and specified competitor die index numbers marked on barrel for proper crimp die selection
- Tin-plated to inhibit corrosion
- Internal solid center prevents over-insertion of conductor
- UL Listed and CSA Certified to 35 KV\*\* and temperature rated to 90°C when crimped with Panduit and specified competitor crimping tools and dies

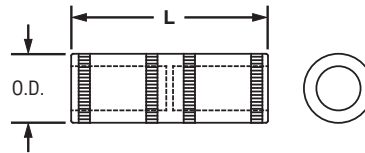

| Part Number | Aluminum or Copper Conductor Size | Figure Dimensions (In.) |      | Panduit Color Code | Panduit Die Index No.‡ | Burdny Die Index No.‡ | T&B Die Index No.‡ | Wire Strip Length (In.) | Std. Pkg. Qty. |
|-------------|-----------------------------------|-------------------------|------|--------------------|------------------------|-----------------------|--------------------|-------------------------|----------------|
|             |                                   | Barrel O.D.             | L    |                    |                        |                       |                    |                         |                |
| SA6-X       | #6 AWG                            | 0.34                    | 1.62 | Gray               | P29                    | 346                   | 29                 | 3/4                     | 10             |
| SA4-X       | #4 AWG                            | 0.48                    | 2.13 | Green              | P37                    | 375                   | 37                 | 7/8                     | 10             |
| SA2-X       | #2 AWG                            | 0.53                    | 2.00 | Pink               | P42                    | 348                   | 45                 | 7/16                    | 10             |
| SA1-X       | #1 AWG                            | 0.53                    | 2.00 | Gold               | P45                    | 471                   | 45                 | 7/16                    | 10             |
| SA1/0-X     | 1/0 AWG                           | 0.64                    | 2.12 | Tan                | P50                    | 296                   | 50                 | 1                       | 10             |
| SA2/0-5     | 2/0 AWG                           | 0.69                    | 2.31 | Olive              | P54                    | 297                   | 54                 | 1 1/8                   | 5              |
| SA3/0-5     | 3/0 AWG                           | 0.76                    | 2.62 | Ruby               | P60                    | 467                   | 60                 | 1 1/4                   | 5              |
| SA4/0-5     | 4/0 AWG                           | 0.88                    | 2.75 | White              | P66                    | 298                   | 66                 | 1 5/16                  | 5              |
| SA250-5     | 250 kcmil                         | 0.91                    | 2.94 | Red                | P71                    | 324                   | 71                 | 1 7/16                  | 5              |
| SA300-2     | 300 kcmil                         | 1.01                    | 3.12 | Blue               | P76                    | 470                   | 76                 | 1 1/2                   | 2              |
| SA350-2     | 350 kcmil                         | 1.12                    | 3.37 | Brown              | P87                    | 299                   | 87                 | 1 5/8                   | 2              |
| SA400-2     | 400 kcmil                         | 1.19                    | 3.75 | Green              | P94                    | 472                   | 94                 | 1 13/16                 | 2              |
| SA500-2     | 500 kcmil                         | 1.32                    | 3.87 | Pink               | P99                    | 300                   | 99                 | 1 7/8                   | 2              |
| SA600-2     | 600 kcmil                         | 1.44                    | 4.12 | Black              | P106                   | 473                   | 106                | 2                       | 2              |
| SA750-1     | 750 kcmil                         | 1.60                    | 4.62 | Red                | P125                   | 301                   | 115                | 2 1/4                   | 1              |
| SA800-1     | 800 kcmil                         | 1.66                    | 4.75 | Gray               | P140                   | 474                   | 125                | 2 5/16                  | 1              |
| SA1000-1    | 1000 kcmil                        | 1.84                    | 5.25 | Brown              | P161                   | 302                   | 161                | 2 9/16                  | 1              |

‡See pages D3.84, D3.85 for tool and die information.

\*\*Consult cable manufacturer for voltage stress relief instructions with applications greater than 2000 V.

See page D2.118 for Panduit joint compounds recommended for pad to pad and conductor connections.

A. System Overview

B1. Cable Ties

B2. Cable Accessories

B3. Stainless Steel Ties

C1. Wiring Duct

C2. Surface Raceway

C3. Abrasion Protection

C4. Cable Management

D1. Terminals

D2. Power Connectors

D3. Grounding Connectors

E1. Labeling Systems

E2. Labels

E3. Pre-Printed & Write-On Markers

E4. Permanent Identification

E5. Lockout/Tagout & Safety Solutions

F. Index

A. System Overview

## Code Conductor, Aluminum, Reducing Splice

B1. Cable Ties

### For Reducing Stranded Aluminum-to-Aluminum or Aluminum-to-Copper Conductors

B2. Cable Accessories

#### Type SAR

- Dual rated for use with aluminum or copper conductors
- Tin-plated to inhibit corrosion
- Factory pre-filled with joint compound and sealed with easy pull-out end plug to inhibit corrosion
- For use up to 35 KV\*\* and temperature rated 90°C when crimped with Panduit and specified competitor crimping tools and dies
- Color-coded end plug and Panduit and specified competitor die index numbers marked on barrel for proper crimp die selection

B3. Stainless Steel Ties



C1. Wiring Duct



C2. Surface Raceway

C3. Abrasion Protection

| Part Number         | Aluminum Conductor Size From | Aluminum or Copper Conductor Size To | Figure Dimensions (In.) |      | Panduit Color Code | Panduit Die Index No.‡ | Burdny Die Index No.‡ | T&B Die Index No.‡ | Wire Strip Length (In.) | Std. Pkg. Qty. |
|---------------------|------------------------------|--------------------------------------|-------------------------|------|--------------------|------------------------|-----------------------|--------------------|-------------------------|----------------|
|                     |                              |                                      | Barrel O.D.             | L    |                    |                        |                       |                    |                         |                |
| <b>SAR2-4-X</b>     | #2 AWG                       | #4 AWG                               | 0.64                    | 4.25 | Tan                | P50                    | 296                   | 50                 | 2 1/16                  | 10             |
| <b>SAR1/0-2-X</b>   | 1/0 AWG                      | #2 AWG                               | 0.64                    | 4.25 | Tan                | P50                    | 296                   | 50                 | 2 1/16                  | 10             |
| <b>SAR3/0-1/0-5</b> | 3/0 AWG                      | 1/0 AWG                              | 0.91                    | 4.98 | Red                | P71                    | 324                   | 71                 | 2 5/16                  | 5              |
| <b>SAR4/0-2/0-5</b> | 4/0 AWG                      | 2/0 AWG                              | 0.91                    | 5.24 | Red                | P71                    | 324                   | 71                 | 2 3/16                  | 5              |
| <b>SAR350-4/0-2</b> | 350 kcmil                    | 4/0 AWG                              | 1.12                    | 6.63 | Brown              | P87                    | 299                   | 87                 | 3 3/16                  | 2              |
| <b>SAR500-350-2</b> | 500 kcmil                    | 350 kcmil                            | 1.32                    | 8.60 | Pink               | P99                    | 300                   | 99                 | 4 1/4                   | 2              |
| <b>SAR600-500-2</b> | 600 kcmil                    | 500 kcmil                            | 1.49                    | 9.25 | Black              | P106                   | 473                   | 106                | 4                       | 2              |
| <b>SAR750-600-2</b> | 750 kcmil                    | 600 kcmil                            | 1.60                    | 9.88 | Red                | P125                   | 301                   | 115                | 4 7/16                  | 2              |

C4. Cable Management

D1. Terminals

‡See pages D3.86 – D3.87 for tool and die information.

D2. Power Connectors

\*\*Consult cable manufacturer for voltage stress relief instructions with applications greater than 2000 V.

See pages D2.118 for Panduit joint compounds recommended for pad to pad and conductor connections.

D3. Grounding Connectors

E1. Labeling Systems

E2. Labels

E3. Pre-Printed & Write-On Markers

E4. Permanent Identification

E5. Lockout/Tagout & Safety Solutions

F. Index

## Code Conductor, Aluminum, Bi-Metallic Pin Connector

**Provides Copper Pigtail for Connecting Aluminum Conductors to a Copper or Aluminum/Copper Rated Mechanical Lug**

### Type BPC

- Factory pre-filled with joint compound and sealed with easy pull-out end plug to inhibit corrosion
- Color-coded end plug and Panduit die index number marked on barrel for proper crimp die selection
- Insulating rubber sleeve included to insulate aluminum barrel from contact with copper connector when attached to pin
- Tin-plated to inhibit corrosion
- UL Listed per UL 486B; temperature rated 90°C and for use up to 600 V when crimped with Panduit and specified competitor crimping tools and dies

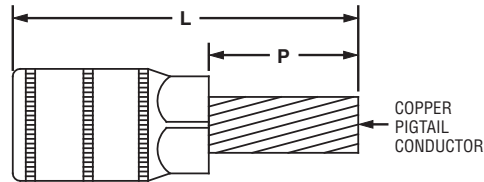

| Part Number | Aluminum Conductor Size | Copper Pigtail Size | Figure Dimensions (In.) |      | Panduit Color Code | Panduit Die Index No.‡ | Burdndy Die Index No.‡ | T&B Die Index No.‡ | Wire Strip Length (In.) | Std. Pkg. Qty. |
|-------------|-------------------------|---------------------|-------------------------|------|--------------------|------------------------|------------------------|--------------------|-------------------------|----------------|
|             |                         |                     | L                       | P    |                    |                        |                        |                    |                         |                |
| BPC6-L      | #6 AWG                  | #8 AWG              | 2.45                    | 0.88 | Tan                | P50                    | 296                    | 50                 | 1 1/16                  | 50             |
| BPC4-L      | #4 AWG                  | #6 AWG              | 2.45                    | 0.88 | Tan                | P50                    | 296                    | 50                 | 1 1/16                  | 50             |
| BPC2-L      | #2 AWG                  | #4 AWG              | 2.45                    | 0.88 | Tan                | P50                    | 296                    | 50                 | 1 1/16                  | 50             |
| BPC1-X      | #1 AWG                  | #3 AWG              | 2.58                    | 1.00 | Tan                | P50                    | 296                    | 50                 | 1 1/16                  | 10             |
| BPC1/0-X    | 1/0 AWG                 | #2 AWG              | 3.33                    | 1.25 | Red                | P71                    | 298                    | 76                 | 1 5/16                  | 10             |
| BPC2/0-X    | 2/0 AWG                 | #1 AWG              | 3.33                    | 1.25 | Red                | P71                    | 298                    | 76                 | 1 5/16                  | 10             |
| BPC3/0-X    | 3/0 AWG                 | 1/0 AWG             | 3.46                    | 1.38 | Red                | P71                    | 298                    | 76                 | 1 5/16                  | 10             |
| BPC4/0-X    | 4/0 AWG                 | 2/0 AWG             | 3.46                    | 1.38 | Red                | P71                    | 298                    | 76                 | 1 5/16                  | 10             |
| BPC250-X    | 250 kcmil               | 3/0 AWG             | 3.71                    | 1.50 | Green              | P94                    | 299                    | 99, 87             | 1 7/16                  | 10             |
| BPC300-X    | 300 kcmil               | 4/0 AWG             | 4.10                    | 1.63 | Green              | P94                    | 299                    | 99, 87             | 1 7/16                  | 10             |
| BPC350-X    | 350 kcmil               | 4/0 AWG             | 4.10                    | 1.63 | Green              | P94                    | 299                    | 99, 87             | 1 7/16                  | 10             |
| BPC400-X    | 400 kcmil               | 250 kcmil           | 4.35                    | 1.88 | Black              | P106                   | 300                    | 106                | 1 7/16                  | 10             |
| BPC500-X    | 500 kcmil               | 350 kcmil           | 4.35                    | 1.88 | Black              | P106                   | 300                    | 106                | 1 7/16                  | 10             |
| BPC600-6    | 600 kcmil               | 350 kcmil           | 4.77                    | 1.88 | Red                | P125                   | 936                    | 115                | 1 15/16                 | 6              |
| BPC750-6    | 750 kcmil               | 500 kcmil           | 4.90                    | 2.00 | Red                | P125                   | 936                    | 115                | 1 15/16                 | 6              |

‡See pages D3.88 – D3.89 for tool and die information.

See pages D2.118 for Panduit joint compounds recommended for pad to pad and conductor connections.

A. System Overview

B1. Cable Ties

B2. Cable Accessories

B3. Stainless Steel Ties

C1. Wiring Duct

C2. Surface Raceway

C3. Abrasion Protection

C4. Cable Management

D1. Terminals

D2. Power Connectors

D3. Grounding Connectors

E1. Labeling Systems

E2. Labels

E3. Pre-Printed & Write-On Markers

E4. Permanent Identification

E5. Lockout/Tagout & Safety Solutions

F. Index

A.  
System  
Overview

## Joint Compounds

B1.  
Cable Ties

### For Use with Aluminum Connectors

B2.  
Cable  
Accessories

#### Type CMP

- Oxide inhibitor for compression conductor connections lowers electrical resistance of compression joint while sealing out air and moisture to prevent the formation of surface oxides

- Wide operating temperature range; can be used in a wide range of electrical and environmental conditions
- Packaged in convenient dispenser bottles

B3.  
Stainless  
Steel Ties



C1.  
Wiring  
Duct

C2.  
Surface  
Raceway

C3.  
Abrasion  
Protection

C4.  
Cable  
Management

D1.  
Terminals

D2.  
Power  
Connectors

D3.  
Grounding  
Connectors

E1.  
Labeling  
Systems

E2.  
Labels

E3.  
Pre-Printed  
& Write-On  
Markers

E4.  
Permanent  
Identification

E5.  
Lockout/  
Tagout  
& Safety  
Solutions

F.  
Index

| Part Number      | Part Description   | Std. Pkg. Qty. |
|------------------|--|----------------|
| <b>CMP-100-1</b> | Contact aid for pad-to-pad or thread-to-thread aluminum connections, 8 oz. Operating temperature range -60°F (-51°C) to 400°F (204°C).   | 1              |
| <b>CMP-200-1</b> | Contact aid for cable connections with compression connections made on aluminum conductor, 8 oz. Operating temperature range -40°F (-40°C) to 400°F (204°C). Compatible with all insulating materials. | 1              |

## PAN-LUG™ MECHANICAL CONNECTORS

Panduit offers a broad variety of mechanical lugs, splices, and split bolt connectors suitable for a wide range of electrical terminations using code conductor. Designed to be reusable and installed without special tooling, Pan-Lug™ Mechanical Connectors provide quality performance, ease of installation, and lowest installed cost.



- Functional product information is marked directly on the connector, facilitating the identification, ordering, and usage of the mechanical connector
- Incorporate wide wire range-taking capability to minimize inventory requirements
- Made from high strength, high conductivity electrolytic copper and aluminum alloy materials to provide optimum connectivity for power and grounding applications
- UL Listed and CSA Certified, as noted

Pan-Lug™ Mechanical Connectors include split bolt connectors, copper mechanical lugs, aluminum mechanical lugs and aluminum multi-tap connectors with clear PVC insulation. Products are available in stamped and formed, extruded and cast varieties of multiple barrel and tongue configurations to provide solutions for diverse power and grounding needs. Panduit offers a wide assortment of Pan-Lug™ Power and Grounding Connectors to meet customer needs and today's application requirements.

A.  
System  
Overview

B1.  
Cable Ties

B2.  
Cable  
Accessories

B3.  
Stainless  
Steel Ties

C1.  
Wiring  
Duct

C2.  
Surface  
Raceway

C3.  
Abrasion  
Protection

C4.  
Cable  
Management

D1.  
Terminals

D2.  
Power  
Connectors

D3.  
Grounding  
Connectors

E1.  
Labeling  
Systems

E2.  
Labels

E3.  
Pre-Printed  
& Write-On  
Markers

E4.  
Permanent  
Identification

E5.  
Lockout/  
Tagout  
& Safety  
Solutions

F.  
Index

A. System Overview

## Features and Benefits – Pan-Lug™ Mechanical Connectors

B1. Cable Ties

### Copper Split Bolt Connectors

Part number and conductor range marked on part for easy identification

Waxed body to prohibit binding of contact pad or nut

Extra-long body available to connect two taps with one run



Hex head with large wrench flats for easy assembly

250 kcmil and larger sizes have contact serrations for higher pull-out strength

Made from high strength copper alloy

### Cast Copper Connectors

Made from high strength copper alloy

Serrated barrel available for high pull-out strength

Flat bottom allows full contact surface mounting



Inspection windows to assure complete conductor insertion

Part number and conductor range marked on part for easy identification

C3. Abrasion Protection

### Stamped and Formed Copper Connectors

Made from high strength, electrolytic copper alloy

Part number and conductor range marked on part for easy identification

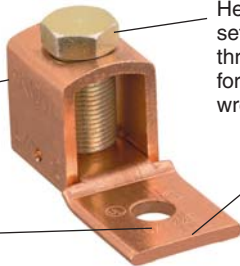

Hex head bolt (slotted set screw used up through 1/0 AWG sizes) for assembly with a wrench or screwdriver

Two styles of tongues available: fixed and floating

### Aluminum Connectors

Dual rated for aluminum or copper conductors

Made from high strength, extruded aluminum alloy

Part number and conductor range marked on part for easy identification

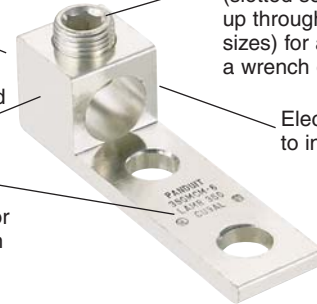

Hex socket set screw (slotted set screw used up through 2/0 AWG sizes) for assembly with a wrench or screwdriver

Electro tin-plated to inhibit corrosion

D1. Terminals

D2. Power Connectors

D3. Grounding Connectors

### Multi-Tap Connectors

Hex socket set screws (slotted set screw for smallest size) for assembly with a wrench or screwdriver

Pre-insulated aluminum body to eliminate the need for taping

Dual-sided conductor entry

Made from high strength, extruded aluminum alloy

Clear PVC insulation for visual inspection of the complete conductor insertion

Factory pre-filled with oxide inhibitor to prevent oxidation

Available with two isolated mounting holes at either end of connector to facilitate direct mounting using 1/4" bolts.



E5. Lockout/Tagout & Safety Solutions

F. Index



Panduit designs and manufactures a full line of labeling products, software, and printers to assist you with your labeling requirements. See pages E1.1 – E2.22.



Pan-Steel® Stainless Cable Ties provide a strong, durable method of bundling and fastening, in all indoor, outdoor, and underground applications. See pages B3.2 – B3.19.



Panduit provides a complete selection of nylon cable ties to bundle, mount, and identify in countless indoor, outdoor, and harsh environment applications. See pages B1.1 – B1.84.



## Selection Guide – Pan-Lug™ Mechanical Connectors, Cast Copper

| 1. Select Connector Type and Stud Hole Size Desired                                 |                                  |                      | 2. Determine Conductor Size and then Select Panduit Part Number |         |         |              |        |        |              |        |         |              |         |         |             |           |           |             |           |           |           |            |  |  |  |  |  |  |  |  |  |
|---|----------------------------------|----------------------|---|---------|---------|--------------|--------|--------|--------------|--------|---------|--------------|---------|---------|-------------|-----------|-----------|-------------|-----------|-----------|-----------|------------|--|--|--|--|--|--|--|--|--|
| UL LISTED ‡   | Mechanical Connector Type        | Stud Hole Size (In.) | Copper Code Conductor Size                                      |         |         |              |        |        |              |        |         |              |         |         |             |           |           |             |           |           |           |            |  |  |  |  |  |  |  |  |  |
|   |                                  |                      | #14 AWG   | #12 AWG | #10 AWG | #8 AWG       | #6 AWG | #4 AWG | #2 AWG       | #1 AWG | 1/0 AWG | 2/0 AWG      | 3/0 AWG | 4/0 AWG | 250 kcmil   | 300 kcmil | 350 kcmil | 500 kcmil   | 600 kcmil | 750 kcmil | 800 kcmil | 1000 kcmil |  |  |  |  |  |  |  |  |  |
|   |                                  |                      | Panduit Part Number   |         |         |              |        |        |              |        |         |              |         |         |             |           |           |             |           |           |           |            |  |  |  |  |  |  |  |  |  |
|    | One-Hole, Straight Tongue HL     | 1/4                  | HL1-25-X■*  |         |         | HL4-1-X■*    |        |        | HL8-1-X*     |        |         | HL13-1-5     |         |         | HL21-1-5    |           |           | HL30-1-2    |           |           | HL50-1-2  |            |  |  |  |  |  |  |  |  |  |
|   |                                  | 3/8                  |   |         |         |              |        |        |              |        |         |              |         |         |             |           |           |             |           |           |           |            |  |  |  |  |  |  |  |  |  |
|   |                                  | 1/2                  |   |         |         |              |        |        |              |        |         |              |         |         |             |           |           |             |           |           |           |            |  |  |  |  |  |  |  |  |  |
|    | One-Hole, Straight Tongue HLB    | 1/4                  | HLB4-1-X■*  |         |         |              |        |        |              |        |         |              |         |         |             |           |           |             |           |           |           |            |  |  |  |  |  |  |  |  |  |
|    | One-Hole, Straight Tongue HLA-90 | 1/4                  | HLA4-1-90-X■*   |         |         | HLA8-1-90-X* |        |        | HLA13-1-90-5 |        |         | HLA21-1-90-5 |         |         |             |           |           |             |           |           |           |            |  |  |  |  |  |  |  |  |  |
|   |                                  | 3/8                  |   |         |         |              |        |        |              |        |         |              |         |         |             |           |           |             |           |           |           |            |  |  |  |  |  |  |  |  |  |
|    | Two-Hole, Straight Tongue HL-2   | 1/4                  | HL1-2-25-X■*  |         |         | HL4-2-X■*    |        |        | HL8-2-X*     |        |         | HL13-2-5     |         |         | HL21-2-5    |           |           | HL30-2-2    |           |           | HL50-2-2  |            |  |  |  |  |  |  |  |  |  |
|   |                                  | 5/16                 |   |         |         |              |        |        |              |        |         |              |         |         |             |           |           |             |           |           |           |            |  |  |  |  |  |  |  |  |  |
|   |                                  | 3/8                  |   |         |         |              |        |        |              |        |         |              |         |         |             |           |           |             |           |           |           |            |  |  |  |  |  |  |  |  |  |
|   | Two-Hole, Straight Tongue HL-2N  | 1/2                  |   |         |         | HL8-2N-X◆*   |        |        | HL13-2N-5◆   |        |         | HL21-2N-5◆   |         |         | HL30-2N-2◆  |           |           |             |           |           |           |            |  |  |  |  |  |  |  |  |  |
|   |                                  | 1/2                  |   |         |         |              |        |        |              |        |         |              |         |         |             |           |           |             |           |           |           |            |  |  |  |  |  |  |  |  |  |
|  | Two-Hole, Straight Tongue H2L-2N | 1/2                  |   |         |         | H2L4-2N-X◆■* |        |        | H2L8-2N-2◆*  |        |         | H2L13-2N-2◆  |         |         | H2L21-2N-2◆ |           |           | H2L30-2N-1◆ |           |           |           |            |  |  |  |  |  |  |  |  |  |
|   |                                  | 1/2                  |   |         |         |              |        |        |              |        |         |              |         |         |             |           |           |             |           |           |           |            |  |  |  |  |  |  |  |  |  |
|  | Two-Way Connector HC             | —                    |   |         |         | HC4-3■*      |        |        | HC8-3*       |        |         | HC13-3       |         |         | HC21-1      |           |           | HC30-1      |           |           | HC50-1    |            |  |  |  |  |  |  |  |  |  |
|   |                                  | —                    |   |         |         |              |        |        |              |        |         |              |         |         |             |           |           |             |           |           |           |            |  |  |  |  |  |  |  |  |  |
|  | Two-Hole, Straight Tongue HHL-2N | 1/2                  |   |         |         | HHL8-2N-X◆*  |        |        | HHL13-2N-5◆  |        |         | HHL21-2N-5◆  |         |         | HHL30-2N-1◆ |           |           |             |           |           |           |            |  |  |  |  |  |  |  |  |  |
|   |                                  | 1/2                  |   |         |         |              |        |        |              |        |         |              |         |         |             |           |           |             |           |           |           |            |  |  |  |  |  |  |  |  |  |
|  | One-Hole, Straight Tongue PNL    | 1/4                  | PNL-4-C■*   |         |         |              |        |        |              |        |         |              |         |         |             |           |           |             |           |           |           |            |  |  |  |  |  |  |  |  |  |
|   |                                  | 5/16                 |   |         |         | PNL-1/0-L*   |        |        |              |        |         |              |         |         |             |           |           |             |           |           |           |            |  |  |  |  |  |  |  |  |  |
|   |                                  | 3/8                  |   |         |         |              |        |        | PNL-250-Q*   |        |         |              |         |         |             |           |           |             |           |           |           |            |  |  |  |  |  |  |  |  |  |
|   |                                  | 1/2                  |   |         |         |              |        |        |              |        |         | PNL-500-3*   |         |         |             |           |           |             |           |           |           |            |  |  |  |  |  |  |  |  |  |
|  | One-Hole, Straight Tongue ML     | 3/16                 | ML8-CY■^*   |         |         |              |        |        |              |        |         |              |         |         |             |           |           |             |           |           |           |            |  |  |  |  |  |  |  |  |  |
|   |                                  | 1/4                  | ML4-CY■^*   |         |         |              |        |        |              |        |         |              |         |         |             |           |           |             |           |           |           |            |  |  |  |  |  |  |  |  |  |
|   |                                  | 5/16                 |   |         |         | ML1/0-LY^*   |        |        |              |        |         |              |         |         |             |           |           |             |           |           |           |            |  |  |  |  |  |  |  |  |  |
|  | Two-Hole, Straight Tongue PNL-2  | 5/16                 |   |         |         | PNL-1/0-2-L* |        |        | ML250-QY^*   |        |         |              |         |         |             |           |           |             |           |           |           |            |  |  |  |  |  |  |  |  |  |
|   |                                  | 3/8                  |   |         |         |              |        |        |              |        |         |              |         |         |             |           |           |             |           |           |           |            |  |  |  |  |  |  |  |  |  |
|   |                                  | 1/2                  |   |         |         |              |        |        |              |        |         |              |         |         |             |           |           |             |           |           |           |            |  |  |  |  |  |  |  |  |  |
|  | Two-Way Connector PNLC           | —                    |   |         |         | PNLC-1/0-3*  |        |        | PNLC-250-1*  |        |         | PNLC-500-1*  |         |         |             |           |           |             |           |           |           |            |  |  |  |  |  |  |  |  |  |
|   |                                  | —                    |   |         |         |              |        |        |              |        |         |              |         |         |             |           |           |             |           |           |           |            |  |  |  |  |  |  |  |  |  |

‡Type PNL is also CSA Certified, Type PNLC is not UL Listed or CSA Certified. Type ML is cULus Listed.

◆NEMA hole sizes and spacing.

■Uses slotted set screw.

\*Denotes minimum conductor size is solid conductor.

^Also available tin-plated.





## Selection Guide – Pan-Lug™ Mechanical Connectors, Split Bolts and Multi-Taps

1. Select Split Bolt Style Desired      2. Determine Conductor Range and then Select Panduit Part Number

### Copper Split Bolt Connectors – SBC

For Use with Copper Code Conductors



| Panduit Part Number | Conductor Size Range** |        | Panduit Part Number | Copper Conductor Range** |            |
|---------------------|------------------------|--------|---------------------|--------------------------|------------|
|                     | Min.                   | Max.   |                     | Min.                     | Max.       |
| SBC8-C              | #10 STR                | #8 STR | SBC1/0-L            | #4 STR                   | 1/0 STR    |
| SBC8L-C^            | #16 STR                | #8 STR | SBC2/0-Q            | #2 STR                   | 2/0 STR    |
| SBC6S-C             | #8 STR                 | #6 STR | SBC3/0-Q            | #1 STR                   | 3/0 STR    |
| SBC6SL-C^           | #8 STR                 | #6 STR | SBC250-Q            | #1 STR                   | 250 kcmil  |
| SBC4S-C             | #8 STR                 | #6 STR | SBC350-1            | 2/0 STR                  | 350 kcmil  |
| SBC4SL-C^           | #8 STR                 | #6 STR | SBC500-1            | 300 kcmil                | 500 kcmil  |
| SBC3-C              | #8 STR                 | #4 STR | SBC750-1            | #8 SOL                   | 750 kcmil  |
| SBC2-C              | #6 STR                 | #2 STR | SBC1000-1           | #8 SOL                   | 1000 kcmil |
| SBC2L-C^            | #14 STR                | #2 STR |                     |                          |            |

^Long body accommodates two tap conductors with single run; not CSA Certified.  
\*\*The conductor sizes shown are for equal run and tap combinations

### Tin Plated Copper Split Bolt Connectors – SBCT

For Use with Combinations of Copper and Aluminum Conductors



| Panduit Part Number    | Copper and Aluminum Conductor Range |            |                            |
|------------------------|-------------------------------------|------------|----------------------------|
|                        | Range of Equal Run and Tap          |            | Min. Tap with One Max. Run |
|                        | Min.                                | Max.       |                            |
| SBCT8-C                | #8 STR                              | #6 SOL     | #14 STR                    |
| SBCT6-C                | #6 STR                              | #10 STR    | #10 STR                    |
| SBCT3-C                | #8 STR                              | #4 STR     | #10 STR                    |
| SBCT2-C                | #6 STR                              | #2 STR     | #14 STR                    |
| SBCT1/0-L              | #4 STR                              | 1/0 STR    | #10 STR                    |
| SBCT2/0-Q              | #2 STR                              | 2/0 STR    | #8 STR                     |
| Copper Conductor Range |                                     |            |                            |
| SBCT10-C               | #16 STR                             | #10 STR    | #16 STR                    |
| SBCT3/0-Q              | #1 STR                              | 3/0 STR    | #8 STR                     |
| SBCT250-Q              | #1 STR                              | 250 kcmil  | #8 STR                     |
| SBCT350-1              | 2/0 STR                             | 350 kcmil  | 1/0 STR                    |
| SBCT500-1              | 300 kcmil                           | 500 kcmil  | 2/0 STR                    |
| SBCT750-1              | 2/0 STR                             | 750 kcmil  | 2/0 STR                    |
| SBCT1000-1             | 4/0 STR                             | 1000 kcmil | 4/0 STR                    |

### Dual Rated Aluminum Split Bolt Connectors – SBA

For Use with Aluminum and Copper Conductor Combinations



| Panduit Part Number | Aluminum to Aluminum, Aluminum to Copper, Copper to Copper Conductors |  |                              |
|---------------------|---|--|------------------------------|
|                     | Max. Run to Max. Tap  | Min. Run to Min. Tap                   | Max. Run to Min. Tap         |
| SBA6-C              | #6 STR – #6 STR   | #10 SOL – #10 SOL                      | #6 STR – #10 SOL             |
| SBA4-C              | #4 STR – #4 STR   | #8 SOL – #10 SOL                       | #4 STR – #10 SOL             |
| SBA2-C              | #2 STR – #2 STR   | #6 SOL – #8 STR                        | #2 STR – #8 STR              |
| SBA1/0-Q            | 1/0 STR – 1/0 STR   | #2 STR (Compact) – #8 SOL              | 1/0 STR – #8 SOL             |
| SBA2/0-Q            | 2/0 STR – 2/0 STR   | #2 STR (Compact) – #8 STR              | 2/0 STR – #8 STR             |
| SBA4/0-Q            | 4/0 STR – 4/0 STR   | #2 STR (Compact) – #6 STR              | 4/0 STR – #6 STR             |
| SBA350-1^           | 350 kcmil – 350 kcmil   | 1/0 STR (Compact) – #4 STR             | 350 kcmil – #4 STR           |
| SBA500-1^           | 500 kcmil – 500 kcmil   | 400 kcmil (Compact) – #2 STR (Compact) | 500 kcmil – #2 STR (Compact) |

^Not CSA Certified.

### Multi-Tap Connectors with Clear Insulation

For Use with Aluminum and Copper Code Conductor Combinations



D2.149 – D2.154



| Type     | Description                       | No. of Ports | Copper or Aluminum Code Conductor Range |
|----------|-----------------------------------|--------------|---|
| PCSB     | Double-sided wire entry           | 2 to 14      | 14 AWG Solid to 750 kcmil               |
| PCSB-S   | Single-sided wire entry           | 2 to 14      | 14 AWG Solid to 750 kcmil               |
| PISR     | In-Line Splice/Reducer            | 2            | 14 AWG Stranded to 500 kcmil            |
| PCSBMT   | Double-sided wire entry mountable | 4 to 12      | 14 AWG Solid to 600 kcmil               |
| PSCBMT-S | Single-sided wire entry mountable | 4 to 12      | 14 AWG Solid to 600 kcmil               |

A. System Overview

B1. Cable Ties

B2. Cable Accessories

B3. Stainless Steel Ties

C1. Wiring Duct

C2. Surface Raceway

C3. Abrasion Protection

C4. Cable Management

D1. Terminals

D2. Power Connectors

D3. Grounding Connectors

E1. Labeling Systems

E2. Labels

E3. Pre-Printed & Write-On Markers

E4. Permanent Identification

E5. Lockout/Tagout & Safety Solutions

F. Index



## Split Bolt, Copper

For Use with Copper Code Conductors

### Type SBC

- Made from high strength copper alloy to resist corrosion and provide premium electrical and mechanical performance
- Offered with extra long body to allow connection of one or two taps to a single run conductor
- Wide wire range-taking capability minimizes inventory requirements
- Nut hex provides correct fit with socket, box, or open end wrenches resulting in proper torquing of electrical connection
- Pressure bar provides secure connection on a full range of conductor combinations used with each connector assuring premium wire pull-out strength
- UL Listed and CSA Certified for use up to 600 V and temperature rated 90°C

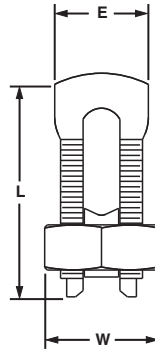

| Part Number      | Copper Conductor         |            |                               | Max. Conductor<br>Copperweld<br>STR | Figure Dimensions<br>(In.) |      |      | Std.<br>Pkg.<br>Qty. |
|------------------|--------------------------|------------|-------------------------------|-------------------------------------|----------------------------|------|------|----------------------|
|                  | Range of Equal Run & Tap |            | Min. Tap with One<br>Max. Run |                                     | E                          | W    | L    |                      |
|                  | Min.                     | Max.       |                               |                                     |                            |      |      |                      |
| <b>SBC8-C</b>    | #10 STR                  | #8 STR     | #16 STR                       | —                                   | 0.39                       | 0.55 | 0.86 | 100                  |
| <b>SBC8L-C*</b>  | #16 STR                  | #8 STR     | #16 STR                       | —                                   | 0.38                       | 0.50 | 0.84 | 100                  |
| <b>SBC6S-C</b>   | #8 STR                   | #6 STR     | #16 STR                       | —                                   | 0.41                       | 0.62 | 0.95 | 100                  |
| <b>SBC6SL-C*</b> | #8 STR                   | #6 STR     | #16 STR                       | —                                   | 0.41                       | 0.63 | 1.10 | 100                  |
| <b>SBC4S-C</b>   | #8 STR                   | #6 STR     | #14 STR                       | —                                   | 0.45                       | 0.69 | 0.98 | 100                  |
| <b>SBC4SL-C*</b> | #8 STR                   | #6 STR     | #14 STR                       | —                                   | 0.45                       | 0.69 | 1.30 | 100                  |
| <b>SBC3-C</b>    | #8 STR                   | #4 STR     | #14 STR                       | —                                   | 0.58                       | 0.81 | 1.16 | 100                  |
| <b>SBC2-C</b>    | #6 STR                   | #2 STR     | #14 STR                       | —                                   | 0.59                       | 0.86 | 1.23 | 100                  |
| <b>SBC2L-C*</b>  | #14 STR                  | #2 STR     | #14 STR                       | 3 No. 7                             | 0.63                       | 0.81 | 1.55 | 100                  |
| <b>SBC1/0-L</b>  | #4 STR                   | 1/0 STR    | #14 STR                       | —                                   | 0.75                       | 0.93 | 1.55 | 50                   |
| <b>SBC2/0-Q</b>  | #2 STR                   | 2/0 STR    | #14 STR                       | —                                   | 0.79                       | 1.05 | 1.72 | 25                   |
| <b>SBC3/0-Q</b>  | #1 STR                   | 3/0 STR    | #8 STR                        | —                                   | 0.95                       | 1.24 | 2.07 | 25                   |
| <b>SBC250-Q</b>  | #1 STR                   | 250 kcmil  | #8 STR                        | —                                   | 1.03                       | 1.36 | 2.09 | 25                   |
| <b>SBC350-1</b>  | 2/0 STR                  | 350 kcmil  | 1/0 STR                       | —                                   | 1.16                       | 1.48 | 2.42 | 1                    |
| <b>SBC500-1</b>  | 300 kcmil                | 500 kcmil  | 2/0 STR                       | —                                   | 1.33                       | 1.74 | 2.83 | 1                    |
| <b>SBC750-1</b>  | #8 SOL                   | 750 kcmil  | #8 SOL                        | 19 No. 5                            | 1.94                       | 2.13 | 3.75 | 1                    |
| <b>SBC1000-1</b> | #8 SOL                   | 1000 kcmil | #8 SOL                        | —                                   | 2.25                       | 2.50 | 4.00 | 1                    |

\*Long body accommodates two tap conductors with single run; not CSA Certified.

A.  
System  
Overview

B1.  
Cable Ties

B2.  
Cable  
Accessories

B3.  
Stainless  
Steel Ties

C1.  
Wiring  
Duct

C2.  
Surface  
Raceway

C3.  
Abrasion  
Protection

C4.  
Cable  
Management

D1.  
Terminals

D2.  
Power  
Connectors

D3.  
Grounding  
Connectors

E1.  
Labeling  
Systems

E2.  
Labels

E3.  
Pre-Printed  
& Write-On  
Markers

E4.  
Permanent  
Identification

E5.  
Lockout/  
Tagout  
& Safety  
Solutions

F.  
Index

A. System Overview

**UL LISTED** **CSA CERTIFIED** **Split Bolt, Copper, Tin-Plated**

B1. Cable Ties

**For Specified Combinations of Copper and Aluminum Code Conductors**

**Type SBCT**

B2. Cable Accessories

- Made from high strength copper alloy to provide premium electrical and mechanical performance
- Tin-plated to inhibit corrosion and oxidation
- Offered with dual rating for use with aluminum or copper conductors
- Wide wire range-taking capability minimizes inventory requirements
- Nut hex provides correct fit with socket, box, or open end wrenches resulting in proper torquing of electrical connection
- Free floating pressure bar separates conductors of dissimilar materials for secure connection on a full range of conductor combinations
- UL Listed and CSA Certified for use up to 600 V and UL temperature rated 90°C

B3. Stainless Steel Ties

C1. Wiring Duct



C2. Surface Raceway

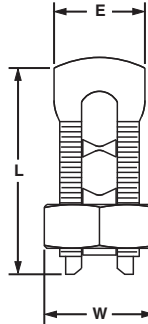

C3. Abrasion Protection

C4. Cable Management

| Part Number | Copper and Aluminum Code Conductor |      |                            | ACSR Range | Max. Conductor<br>Copperweld<br>STR | Figure Dimensions (In.) |   |   | Std. Pkg. Qty. |
|-------------|------------------------------------|------|----------------------------|------------|-------------------------------------|-------------------------|---|---|----------------|
|             | Range of Equal Run and Tap         |      | Min. Tap with One Max. Run |            |                                     | E                       | W | L |                |
|             | Min.                               | Max. |                            |            |                                     |                         |   |   |                |

**UL Listed and CSA Certified with Copper and Aluminum Conductors**

|                  |        |         |         |   |   |      |      |      |     |
|------------------|--------|---------|---------|---|---|------|------|------|-----|
| <b>SBCT8-C</b>   | #8 STR | #6 SOL  | #14 STR | — | — | 0.41 | 0.62 | 1.06 | 100 |
| <b>SBCT6-C</b>   | #6 STR | #10 STR | #10 STR | — | — | 0.49 | 0.68 | 1.10 | 100 |
| <b>SBCT3-C</b>   | #8 STR | #4 STR  | #10 STR | — | — | 0.58 | 0.81 | 1.24 | 100 |
| <b>SBCT2-C</b>   | #6 STR | #2 STR  | #14 STR | — | — | 0.60 | 0.86 | 1.45 | 100 |
| <b>SBCT1/0-L</b> | #4 STR | 1/0 STR | #10 STR | — | — | 0.75 | 0.93 | 1.73 | 50  |
| <b>SBCT2/0-Q</b> | #2 STR | 2/0 STR | #8 STR  | — | — | 0.79 | 1.05 | 1.71 | 25  |

**UL Listed and CSA Certified with Copper Code Conductors Only**

|                   |           |            |         |             |          |      |      |      |     |
|-------------------|-----------|------------|---------|-------------|----------|------|------|------|-----|
| <b>SBCT10-C</b>   | #16 STR   | #10 STR    | #16 STR | —           | —        | 0.38 | 0.49 | 0.87 | 100 |
| <b>SBCT3/0-Q</b>  | #1 STR    | 3/0 STR    | #8 STR  | —           | —        | 0.75 | 1.25 | 2.12 | 25  |
| <b>SBCT250-Q</b>  | #1 STR    | 250 kcmil  | #8 STR  | —           | —        | 1.03 | 1.36 | 2.22 | 25  |
| <b>SBCT350-1</b>  | 2/0 STR   | 350 kcmil  | 1/0 STR | —           | —        | 1.17 | 1.49 | 2.55 | 1   |
| <b>SBCT500-1</b>  | 300 kcmil | 500 kcmil  | 2/0 STR | —           | —        | 1.32 | 1.74 | 2.95 | 1   |
| <b>SBCT750-1</b>  | 2/0 STR   | 750 kcmil  | 2/0 STR | 4/0 – 666.6 | 19 No. 5 | 1.93 | 2.11 | 3.78 | 1   |
| <b>SBCT1000-1</b> | 4/0 STR   | 1000 kcmil | 4/0 STR | 300 – 900   | —        | 2.29 | 2.53 | 4.02 | 1   |

The use of Panduit oxide inhibiting joint compound (CMP-100) is recommended. See pages D2.118 and D2.155.

E2. Labels

E3. Pre-Printed & Write-On Markers

E4. Permanent Identification

E5. Lockout/Tagout & Safety Solutions

F. Index





## Split Bolt, Aluminum

For Use with Copper and Aluminum Code Conductors

### Type SBA

- Made from lightweight, durable aluminum alloy to resist corrosion and provide premium electrical and mechanical performance
- Dual rated for use with aluminum to aluminum, aluminum to copper, and copper to copper conductor combinations
- Tin-plated to inhibit corrosion and oxidation
- Wide wire range-taking capability minimizes inventory requirements

- True hex design for body and nut hex provides correct fit with socket, box, or open end wrenches resulting in proper torquing of electrical connection
- Free floating pressure bar separates conductors of dissimilar materials for secure connection on a full range of conductor combinations
- UL Listed and CSA Certified for use up to 600 V and UL temperature rated 90°C

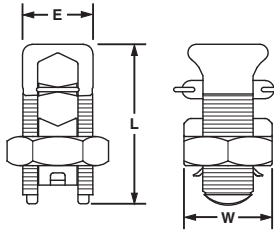

| Part Number | Max. Run to Max. Tap  | Min. Run to Min. Tap                   | Max. Run to Min. Tap         | Figure Dimensions (In.) |      |      | Std. Pkg. Qty. |
|-------------|-----------------------|--|------------------------------|-------------------------|------|------|----------------|
|             |                       |  |                              | E                       | W    | L    |                |
| SBA6-C      | #6 STR – #6 STR       | #10 SOL – #10 SOL                      | #6 STR – #10 SOL             | 0.56                    | 0.75 | 1.58 | 100            |
| SBA4-C      | #4 STR – #4 STR       | #8 SOL – #10 SOL                       | #4 STR – #10 SOL             | 0.62                    | 0.81 | 1.38 | 100            |
| SBA2-C      | #2 STR – #2 STR       | #6 SOL – #8 STR                        | #2 STR – #8 STR              | 0.69                    | 0.94 | 1.58 | 100            |
| SBA1/0-Q    | 1/0 STR – 1/0 STR     | #2 STR (Compact) – #8 SOL              | 1/0 STR – #8 SOL             | 0.75                    | 1.00 | 1.92 | 25             |
| SBA2/0-Q    | 2/0 STR – 2/0 STR     | #2 STR (Compact) – #8 STR              | 2/0 STR – #8 STR             | 0.88                    | 1.12 | 1.92 | 25             |
| SBA4/0-Q    | 4/0 STR – 4/0 STR     | #2 STR (Compact) – #6 STR              | 4/0 STR – #6 STR             | 1.13                    | 1.49 | 2.54 | 25             |
| ^ SBA350-1  | 350 kcmil – 350 kcmil | 1/0 STR (Compact) – #4 STR             | 350 kcmil – #4 STR           | 1.50                    | 1.69 | 3.24 | 1              |
| ^ SBA500-1  | 500 kcmil – 500 kcmil | 400 kcmil (Compact) – #2 STR (Compact) | 500 kcmil – #2 STR (Compact) | 1.73                    | 2.00 | 3.62 | 1              |

The use of Panduit oxide inhibiting joint compound (CMP-100) is recommended. See page D2.155.

^Not CSA Certified.



## Two-Bolt Connector, Bronze

For Use with Copper Code Conductors

### Type VT

- Made from high strength bronze for heavy duty connections and to inhibit corrosion
- Cap swivels for easy installation of conductors
- Rubber washer retains hardware to connector and eliminates loose parts

- High strength silicon-bronze hardware provides premium mechanical performance when assembled to conductor
- Wide wire range-taking capability minimizes inventory requirements
- UL Listed for use up to 600 V and 90°C temperature rated

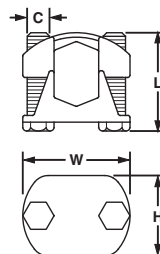

| Part Number | Copper Conductor Size  |                      | Figure Dimensions (In.) |      |      |      | Hex Size (In.) | Std. Pkg. Qty. |
|-------------|------------------------|----------------------|-------------------------|------|------|------|----------------|----------------|
|             | Run                    | Tap                  | L                       | W    | H    | C    |                |                |
| VT-0-Q      | #2 STR – 1/0 STR       | #10 STR – 1/0 STR    | 1.50                    | 1.44 | 0.94 | 0.31 | 1/2            | 25             |
| VT-1-Q      | #2 STR – 2/0 STR       | #10 STR – 2/0 STR    | 1.50                    | 1.56 | 1.13 | 0.31 | 1/2            | 25             |
| VT-2-Q      | 1/0 STR – 4/0 STR      | #10 STR – 4/0 STR    | 1.75                    | 1.84 | 1.34 | 0.38 | 9/16           | 25             |
| VT-3-12     | 250 kcmil – 350 kcmil  | #10 STR – 350 kcmil  | 2.00                    | 2.31 | 1.63 | 0.50 | 3/4            | 12             |
| VT-4-12     | 250 kcmil – 500 kcmil  | #10 STR – 500 kcmil  | 2.25                    | 2.44 | 1.69 | 0.50 | 3/4            | 12             |
| VT-5-6      | 400 kcmil – 800 kcmil  | 3/0 STR – 800 kcmil  | 2.50                    | 2.69 | 1.88 | 0.50 | 9/16           | 6              |
| VT-6-6      | 500 kcmil – 1000 kcmil | 3/0 STR – 1000 kcmil | 2.75                    | 3.06 | 2.25 | 0.63 | 15/16          | 6              |

A. System Overview

## **Two-Bolt Connector, Bronze, Tin-Plated**

B1. Cable Ties

**For Use with Copper and Aluminum Code Conductors**

### Type VTA

- Made from high strength bronze for heavy duty connections
- Tin-plated to inhibit corrosion and oxidation
- Cap swivels for easy installation of conductors
- Rubber washer retains hardware to connector and eliminates loose parts
- High strength silicon-bronze hardware provides premium mechanical performance when assembled to conductor
- Offered for use with aluminum conductors, but not UL Listed
- UL Listed for use up to 600 V and 90°C temperature rated when used with copper code conductor

B2. Cable Accessories

B3. Stainless Steel Ties



C1. Wiring Duct

C2. Surface Raceway

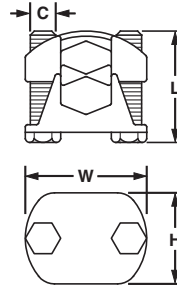

C3. Abrasion Protection

| Part Number     | Copper Conductor Size Range |                      | Copperweld Solid | Aluminum |      | Figure Dimensions (In.) |      |      |      | Hex Size (In.) | Std. Pkg. Qty. |
|-----------------|-----------------------------|----------------------|------------------|----------|------|-------------------------|------|------|------|----------------|----------------|
|                 | Run                         | Tap                  |                  | AWG      | ACSR | L                       | W    | H    | C    |                |                |
| <b>VTA-0-Q</b>  | 2 STR – 1/0 STR             | 10 STR – 1/0 STR     | 2/0              | 1/0 STR  | 1    | 1.25                    | 1.44 | 0.94 | 5/16 | 1/2            | 25             |
| <b>VTA-1-Q</b>  | 2 STR – 2/0 STR             | 10 STR – 2/0 STR     | 3/0              | —        | —    | 1.50                    | 1.56 | 1.13 | 5/16 | 1/2            | 25             |
| <b>VTA-2-Q</b>  | 1/0 STR – 4/0 STR           | 10 STR – 4/0 STR     | 4/0              | —        | —    | 1.75                    | 1.84 | 1.34 | 3/8  | 9/16           | 25             |
| <b>VTA-3-12</b> | 250 – 350 kcmil             | 10 STR – 350 kcmil   | —                | —        | —    | 2.00                    | 2.31 | 1.63 | 1/2  | 3/4            | 12             |
| <b>VTA-4-12</b> | 250 – 500 kcmil             | 10 STR – 500 kcmil   | —                | —        | —    | 2.25                    | 2.44 | 1.69 | 1/2  | 3/4            | 12             |
| <b>VTA-5-6</b>  | 400 – 800 kcmil             | 3/0 STR – 800 kcmil  | —                | —        | —    | 2.50                    | 2.69 | 1.88 | 1/2  | 3/4            | 6              |
| <b>VTA-6-6</b>  | 500 – 1000 kcmil            | 3/0 STR – 1000 kcmil | —                | —        | —    | 2.75                    | 3.06 | 2.25 | 5/8  | 15/16          | 6              |

\*Not UL Listed.

C4. Cable Management

D1. Terminals

D2. Power Connectors

D3. Grounding Connectors

## **One-Hole, Straight Tongue, Barrel Post Lug**

**For Use with Copper Code Conductors**

### Type ML

- Made from high strength electrolytic copper to provide premium electrical and mechanical performance
- Compact design saves space
- Wide wire range-taking capability minimizes inventory requirements
- Inspection window to visually assure full conductor insertion
- Plated steel set screw provides high strength, durable electrical contact between conductor and connector
- Flat bottom allows for complete contact with mounting surface
- UL Listed for use up to 600 V and temperature rated 90°C

E1. Labeling Systems

E2. Labels



E3. Pre-Printed & Write-On Markers

E4. Permanent Identification

E5. Lockout/Tagout & Safety Solutions

F. Index

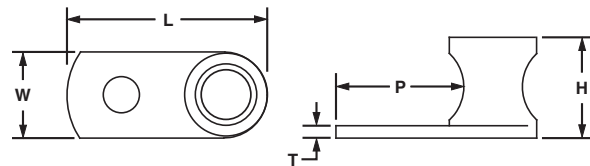

| Part Number     | Copper Conductor Size Range | Stud Hole Size (In.) | Hex Key Size (In.) | Figure Dimensions (In.) |      |      |      |      | Std. Pkg. Qty. |
|-----------------|-----------------------------|----------------------|--------------------|-------------------------|------|------|------|------|----------------|
|                 |                             |                      |                    | L                       | W    | H    | T    | P    |                |
| <b>ML8-CY</b>   | #14 SOL – #8 STR            | 3/16                 | **                 | 0.81                    | 0.38 | 0.42 | 0.08 | 0.48 | 100            |
| <b>ML4-CY</b>   | #14 SOL – #4 STR            | 1/4                  | **                 | 1.11                    | 0.54 | 0.55 | 0.09 | 0.63 | 100            |
| <b>ML1/0-LY</b> | #14 SOL – 1/0 STR           | 5/16                 | 1/4                | 1.54                    | 0.73 | 0.79 | 0.09 | 0.80 | 50             |
| <b>ML250-QY</b> | #6 STR – 250 kcmil          | 3/8                  | 1/4                | 1.94                    | 0.94 | 1.06 | 0.12 | 1.00 | 25             |

\*\*Uses slotted head set screw.

## One-Hole, Straight Tongue, Tin-Plated, Barrel Post Lug

For Use with Copper Code Conductors

### Type ML-T

- Made from high strength, electrolytic copper to provide premium electrical and mechanical performance
- Tin-plated to inhibit corrosion
- Compact design saves space
- Wide wire range-taking capability minimizes inventory requirements
- Inspection window to visually assure full conductor insertion
- Plated steel set screw provides high strength, durable electrical contact between conductor and connector
- Flat bottom allows for complete contact with mounting surface
- UL Listed for use up to 600 V and temperature rated 90°C

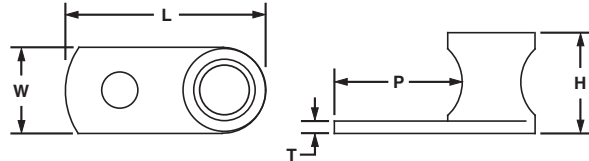

| Part Number | Copper Conductor Size Range | Stud Hole Size (In.) | Hex Key Size (In.) | Figure Dimensions (In.) |      |      |      |      | Std. Pkg. Qty. |
|-------------|-----------------------------|----------------------|--------------------|-------------------------|------|------|------|------|----------------|
|             |                             |                      |                    | L                       | W    | H    | T    | P    |                |
| ML8T-CY     | #14 SOL – #8 STR            | 3/16                 | **                 | 0.81                    | 0.38 | 0.42 | 0.08 | 0.48 | 100            |
| ML4T-CY     | #14 SOL – #4 STR            | 1/4                  | **                 | 1.11                    | 0.54 | 0.55 | 0.09 | 0.63 | 100            |
| ML1/0T-LY   | #14 SOL – 1/0 STR           | 5/16                 | 1/4                | 1.58                    | 0.73 | 0.79 | 0.09 | 0.80 | 50             |
| ML250T-QY   | #6 STR – 250 kcmil          | 3/8                  | 1/4                | 1.94                    | 0.94 | 1.06 | 0.12 | 1.00 | 25             |

\*\*Uses slotted head set screw.

## One-Hole, Straight Tongue Lug

For Use with Copper Code Conductors

### Type PNL

- Cast from high strength corrosion resistant copper alloy to provide premium electrical and mechanical performance
- Compact design saves space
- Wide wire range-taking capability minimizes inventory requirements
- Inspection window to visually assure full conductor insertion
- Plated steel set screw provides high strength, durable electrical contact between conductor and connector
- Flat bottom allows for complete contact with mounting surface
- UL Listed and CSA Certified for use up to 600 V and UL temperature rated 90°C

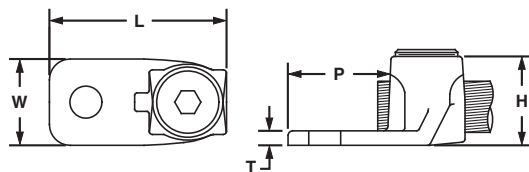

| Part Number | Copper Conductor Size Range | Stud Hole Size (In.) | Hex Key Size (In.) | Figure Dimensions (In.) |      |      |      |      | Std. Pkg. Qty. |
|-------------|-----------------------------|----------------------|--------------------|-------------------------|------|------|------|------|----------------|
|             |                             |                      |                    | L                       | W    | H    | T    | P    |                |
| PNL-4-C     | #14 SOL – #4 STR            | 1/4                  | **                 | 1.25                    | 0.53 | 0.56 | 0.14 | 0.66 | 100            |
| PNL-1/0-L   | #8 SOL – 1/0 STR            | 5/16                 | 1/4                | 1.59                    | 0.73 | 0.78 | 0.14 | 0.85 | 50             |
| PNL-250-Q   | #6 SOL – 250 kcmil          | 3/8                  | 5/16               | 1.97                    | 0.94 | 1.05 | 0.13 | 1.00 | 25             |
| PNL-500-3   | #4 SOL – 500 kcmil          | 1/2                  | 3/8                | 3.00                    | 1.38 | 1.47 | 0.25 | 1.63 | 3              |
| PNL-1000-3  | 500 kcmil – 1000 kcmil      | 1/2                  | 1/2                | 3.88                    | 1.75 | 2.00 | 0.38 | 2.13 | 3              |

\*\*Uses slotted head set screw.

A. System Overview

B1. Cable Ties

B2. Cable Accessories

B3. Stainless Steel Ties

C1. Wiring Duct

C2. Surface Raceway

C3. Abrasion Protection

C4. Cable Management

D1. Terminals

D2. Power Connectors

D3. Grounding Connectors

E1. Labeling Systems

E2. Labels

E3. Pre-Printed & Write-On Markers

E4. Permanent Identification

E5. Lockout/Tagout & Safety Solutions

F. Index

A. System Overview

## **UL LISTED** One-Hole, Straight Tongue Lug with Internal Pressure Plate

B1. Cable Ties

**For Use with Copper Code Conductors**

### Type HL

- Cast from high strength corrosion resistant copper alloy to provide premium electrical and mechanical performance
- Compact design saves space
- Wide wire range-taking capability minimizes inventory requirements
- Pressure plate\* provides uniform clamping force on conductor for premium electrical performance
- Plated steel set screw provides high strength, durable electrical contact between conductor and connector
- Flat bottom allows for complete contact with mounting surface
- Inspection window to visually assure full conductor insertion
- UL Listed for use up to 600 V and temperature rated 90°C

B2. Cable Accessories

B3. Stainless Steel Ties

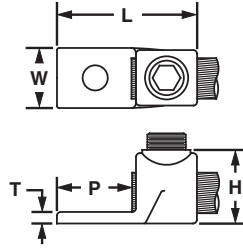

C1. Wiring Duct

C2. Surface Raceway

C3. Abrasion Protection

C4. Cable Management

| Part Number | Copper Conductor Size Range | Stud Hole Size (in.) | Hex Key Size (in.) | Figure Dimensions (in.) |      |      |      |      | Std. Pkg. Qty. |
|-------------|-----------------------------|----------------------|--------------------|-------------------------|------|------|------|------|----------------|
|             |                             |                      |                    | L                       | W    | H    | T    | P    |                |
| HL1-25-X    | #14 SOL – #8 STR            | 1/4                  | **                 | 1.38                    | 0.56 | 0.79 | 0.19 | 0.81 | 10             |
| HL4-1-X     | #8 SOL – #4 STR             | 1/4                  | **                 | 1.38                    | 0.56 | 0.79 | 0.19 | 0.81 | 10             |
| HL8-1-X     | #4 SOL – #1 STR             | 1/4                  | 7/16               | 1.56                    | 0.75 | 0.90 | 0.22 | 0.69 | 10             |
| HL13-1-5    | #1 STR – 2/0 STR            | 3/8                  | 9/16               | 1.88                    | 0.81 | 1.14 | 0.22 | 0.88 | 5              |
| HL21-1-5    | 2/0 STR – 4/0 STR           | 3/8                  | 9/16               | 2.19                    | 1.00 | 1.31 | 0.25 | 1.00 | 5              |
| HL30-1-2    | 4/0 STR – 300 kcmil         | 1/2                  | 5/8                | 2.50                    | 1.06 | 1.47 | 0.31 | 1.25 | 2              |
| HL50-1-2    | 300 kcmil – 500 kcmil       | 1/2                  | 3/4                | 3.00                    | 1.38 | 1.65 | 0.34 | 1.50 | 2              |

\*HL1-25-X and HL4-1-X do not include pressure plates.

\*\*Uses slotted head set screw.

D1. Terminals

D2. Power Connectors

D3. Grounding Connectors

## **UL LISTED** One-Hole, Straight Tongue, Flag Lug

**For Use with Copper Code Conductors**

### Type HLB

- Provides connection of conductor at right angles to terminal bar
- Cast from high strength corrosion resistant copper alloy to provide premium electrical and mechanical performance
- Compact design saves space
- Wire range-taking capability minimizes inventory requirements
- Internal pressure plate provides uniform clamping force on conductor for premium electrical performance
- Flush bottom allows for complete contact with mounting surface
- Inspection window to visually assure full conductor insertion
- UL Listed for use up to 600 V and temperature rated 90°C

E1. Labeling Systems

E2. Labels

E3. Pre-Printed & Write-On Markers

E4. Permanent Identification

E5. Lockout/Tagout & Safety Solutions

F. Index

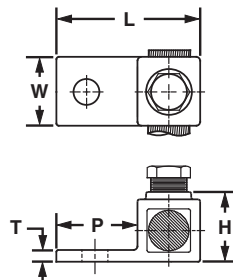

| Part Number | Copper Conductor Size Range | Stud Hole Size (in.) | Hex Key Size (in.) | Figure Dimensions (in.) |      |      |      |      | Std. Pkg. Qty. |
|-------------|-----------------------------|----------------------|--------------------|-------------------------|------|------|------|------|----------------|
|             |                             |                      |                    | L                       | W    | H    | T    | P    |                |
| HLB4-1-X    | #8 SOL – #4 STR             | 1/4                  | **                 | 1.25                    | 0.50 | 0.79 | 0.19 | 0.63 | 10             |

\*\*Uses slotted head set screw.

## One-Hole, Straight Tongue, 90° Lug

For Use with Copper Code Conductors

### Type HLA-90

- Provides connection of conductor at right angles to terminal bar
- Cast from high strength corrosion resistant copper alloy to provide premium electrical and mechanical performance
- Compact design saves space
- Wide wire range-taking capability minimizes inventory requirements
- Internal pressure plate provides uniform clamping force on conductor for premium electrical performance
- Flush bottom allows for complete contact with mounting surface
- UL Listed for use up to 600 V and temperature rated 90°C

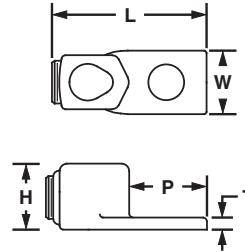

| Part Number  | Copper Conductor Size Range | Stud Hole Size (In.) | Hex Key Size (In.) | Figure Dimensions (In.) |      |      |      |      | Std. Pkg. Qty. |
|--------------|-----------------------------|----------------------|--------------------|-------------------------|------|------|------|------|----------------|
|              |                             |                      |                    | L                       | W    | H    | T    | P    |                |
| HLA4-1-90-X  | #8 SOL – #4 STR             | 1/4                  | **                 | 1.81                    | 0.56 | 0.73 | 0.19 | 0.63 | 10             |
| HLA8-1-90-X  | #4 SOL – #1 STR             | 1/4                  | 7/16               | 1.50                    | 0.75 | 0.75 | 0.22 | 0.69 | 10             |
| HLA13-1-90-5 | #1 STR – 2/0 STR            | 3/8                  | 9/16               | 2.38                    | 0.81 | 1.00 | 0.22 | 0.88 | 5              |
| HLA21-1-90-5 | 2/0 STR – 4/0 STR           | 3/8                  | 9/16               | 2.69                    | 1.00 | 1.14 | 0.25 | 1.00 | 5              |

\*\*Uses slotted head set screw.

## Two-Hole, Straight Tongue Lug

For Use with Copper Code Conductors

### Type PNL-2

- Cast from high strength corrosion resistant copper alloy to provide premium electrical and mechanical performance
- Wide wire range-taking capability minimizes inventory requirements
- Inspection window to visually assure full conductor insertion
- Plated steel set screw provides high strength, durable electrical contact between conductor and connector
- Flat bottom allows for complete contact with mounting surface
- UL Listed for use up to 600 V and temperature rated 90°C

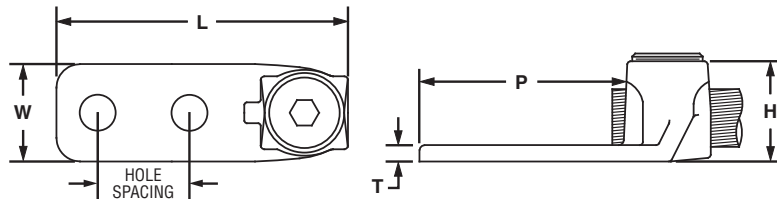

| Part Number  | Copper Conductor Size Range | Stud Hole Size (In.) | Stud Hole Spacing (In.) | Hex Key Size (In.) | Figure Dimensions (In.) |      |      |      |      | Std. Pkg. Qty. |
|--------------|-----------------------------|----------------------|-------------------------|--------------------|-------------------------|------|------|------|------|----------------|
|              |                             |                      |                         |                    | L                       | W    | H    | T    | P    |                |
| PNL-1/0-2-L  | #8 SOL – 1/0 STR            | 5/16                 | 1.00                    | 1/4                | 2.75                    | 0.75 | 0.84 | 0.19 | 2.00 | 50             |
| PNL-250-2-Q  | #6 SOL – 250 kcmil          | 3/8                  | 1.00                    | 1/4                | 2.88                    | 0.94 | 1.03 | 0.22 | 2.02 | 25             |
| PNL-500-2-3  | #4 SOL – 500 kcmil          | 3/8                  | 1.00                    | 3/8                | 3.38                    | 1.38 | 1.47 | 0.31 | 2.00 | 3              |
| PNL-1000-2-3 | 500 kcmil – 1000 kcmil      | 1/2                  | 1.50                    | 3/8                | 4.88                    | 1.75 | 2.00 | 0.38 | 3.13 | 3              |

A. System Overview

**UL LISTED Two-Hole, Straight Tongue Lug with Internal Pressure Plate**

B1. Cable Ties

**For Use with Copper Code Conductors**  
**Type HL-2**

B2. Cable Accessories

- Cast from high strength corrosion resistant copper alloy to provide premium electrical and mechanical performance
- Wide wire range-taking capability minimizes inventory requirements
- Internal pressure plate provides uniform clamping force on conductor for premium electrical performance
- Plated steel set screw provides high strength, durable electrical contact between conductor and connector
- Inspection window to visually assure full conductor insertion
- Flat bottom allows for complete contact with mounting surface
- UL Listed for use up to 600 V and temperature rated 90°C

B3. Stainless Steel Ties

C1. Wiring Duct



C2. Surface Raceway

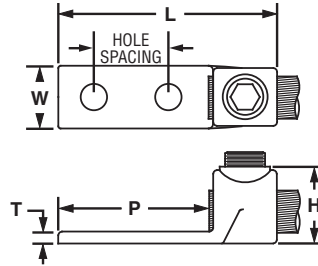

C3. Abrasion Protection

C4. Cable Management

| Part Number       | Copper Conductor Size Range | Stud Hole Size (In.) | Stud Hole Spacing (In.) | Hex Key Size (In.) | Figure Dimensions (In.) |      |      |      |      | Std. Pkg. Qty. |
|-------------------|-----------------------------|----------------------|-------------------------|--------------------|-------------------------|------|------|------|------|----------------|
|                   |                             |                      |                         |                    | L                       | W    | H    | T    | P    |                |
| <b>HL1-2-25-X</b> | #14 SOL – #8 STR            | 1/4                  | 0.63                    | **                 | 2.00                    | 0.56 | 0.70 | 0.19 | 1.25 | 10             |
| <b>HL4-2-X</b>    | #8 SOL – #4 STR             | 1/4                  | 0.63                    | **                 | 2.00                    | 0.56 | 0.69 | 0.18 | 1.25 | 10             |
| <b>HL8-2-X</b>    | #4 SOL – #1 STR             | 1/4                  | 0.75                    | 7/16               | 2.44                    | 0.75 | 0.92 | 0.22 | 1.50 | 10             |
| <b>HL13-2-5</b>   | #1 STR – 2/0 STR            | 3/8                  | 1.00                    | 9/16               | 2.88                    | 0.81 | 1.07 | 0.22 | 1.88 | 5              |
| <b>HL21-2-5</b>   | 2/0 STR – 4/0 STR           | 3/8                  | 1.00                    | 9/16               | 3.00                    | 1.00 | 1.33 | 0.25 | 1.75 | 5              |
| <b>HL30-2-2</b>   | 4/0 STR – 300 kcmil         | 3/8                  | 1.00                    | 5/8                | 3.13                    | 1.06 | 1.45 | 0.31 | 2.00 | 2              |
| <b>HL50-2-2</b>   | 300 kcmil – 500 kcmil       | 3/8                  | 1.00                    | 3/4                | 3.44                    | 1.38 | 1.66 | 0.34 | 2.00 | 2              |

\*\*Uses slotted head set screw.

D1. Terminals

D2. Power Connectors

D3. Grounding Connectors

E1. Labeling Systems

E2. Labels

E3. Pre-Printed & Write-On Markers

E4. Permanent Identification

E5. Lockout/Tagout & Safety Solutions

F. Index



## UL LISTED Two-Hole, Straight Tongue Lug with NEMA Hole Sizes and Spacing

For Use with Copper Code Conductors

### Type HL-2N

- Cast from high strength corrosion resistant copper alloy to provide premium electrical and mechanical performance
- Wide wire range-taking capability minimizes inventory requirements
- Internal pressure plate provides uniform clamping force on conductor for premium electrical performance
- Internal barrel serrations allow for premium wire pull-out strength
- Inspection window to visually assure full conductor insertion
- Flat bottom allows for complete contact with mounting surface
- UL Listed for use up to 600 V and temperature rated 90°C
- Available with NEMA hole sizes and spacing

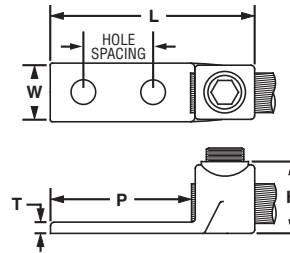

| Part Number | Copper Conductor Size Range | Stud Hole Size (In.) | Stud Hole Spacing (In.) | Hex Key Size (In.) | Figure Dimensions (In.) |      |      |      |      | Std. Pkg. Qty. |
|-------------|-----------------------------|----------------------|-------------------------|--------------------|-------------------------|------|------|------|------|----------------|
|             |                             |                      |                         |                    | L                       | W    | H    | T    | P    |                |
| ◆ HL8-2N-X  | #4 SOL – #1 STR             | 1/2                  | 1.75                    | 7/16               | 3.94                    | 1.00 | 0.90 | 0.22 | 3.00 | 10             |
| ◆ HL13-2N-5 | #1 STR – 2/0 STR            | 1/2                  | 1.75                    | 9/16               | 4.25                    | 1.00 | 1.07 | 0.22 | 3.00 | 5              |
| ◆ HL21-2N-5 | 2/0 STR – 4/0 STR           | 1/2                  | 1.75                    | 9/16               | 4.19                    | 1.25 | 1.34 | 0.25 | 3.00 | 5              |
| ◆ HL30-2N-2 | 4/0 STR – 300 kcmil         | 1/2                  | 1.75                    | 5/8                | 4.25                    | 1.25 | 1.46 | 0.31 | 3.00 | 2              |

◆NEMA hole sizes and spacing.

## UL LISTED Two-Hole, Straight Tongue, Tandem Set Screw Lug

For Use with Copper Code Conductors

### Type HHL-2N

- Cast from high strength corrosion resistant copper alloy to provide premium electrical and mechanical performance
- Double set screws provide additional wire secureness for use in heavy duty applications
- Wide wire range-taking capability minimizes inventory requirements
- Internal pressure plate provides uniform clamping force on conductor for premium electrical performance
- Internal barrel serrations allow for premium wire pull-out strength
- Inspection window to visually assure full conductor insertion
- Flat bottom allows for complete contact with mounting surface
- UL Listed for use up to 600 V and temperature rated 90°C
- Available with NEMA hole sizes and spacing

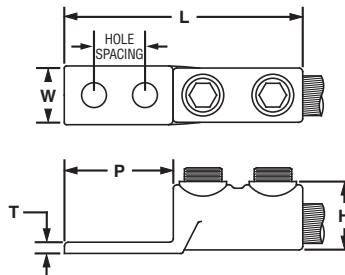

| Part Number  | Copper Conductor Size Range | Stud Hole Size (In.) | Stud Hole Spacing (In.) | Hex Key Size (In.) | Figure Dimensions (In.) |      |      |      |      | Std. Pkg. Qty. |
|--------------|-----------------------------|----------------------|-------------------------|--------------------|-------------------------|------|------|------|------|----------------|
|              |                             |                      |                         |                    | L                       | W    | H    | T    | P    |                |
| ◆ HHL8-2N-X  | #4 SOL – #1 STR             | 1/2                  | 1.75                    | 7/16               | 5.13                    | 1.00 | 0.80 | 0.22 | 3.00 | 10             |
| ◆ HHL13-2N-5 | #1 STR – 2/0 STR            | 1/2                  | 1.75                    | 9/16               | 4.88                    | 1.25 | 1.00 | 0.22 | 3.00 | 5              |
| ◆ HHL21-2N-5 | 2/0 STR – 4/0 STR           | 1/2                  | 1.75                    | 9/16               | 5.63                    | 1.50 | 1.37 | 0.25 | 3.00 | 5              |
| ◆ HHL30-2N-1 | 4/0 STR – 300 kcmil         | 1/2                  | 1.75                    | 5/8                | 5.88                    | 1.50 | 1.45 | 0.31 | 3.00 | 1              |

◆NEMA hole sizes and spacing.

A. System Overview

B1. Cable Ties

B2. Cable Accessories

B3. Stainless Steel Ties

C1. Wiring Duct

C2. Surface Raceway

C3. Abrasion Protection

C4. Cable Management

D1. Terminals

D2. Power Connectors

D3. Grounding Connectors

E1. Labeling Systems

E2. Labels

E3. Pre-Printed & Write-On Markers

E4. Permanent Identification

E5. Lockout/Tagout & Safety Solutions

F. Index

## **Two-Hole, Straight Tongue, Two-Barrel Lug**

**For Use with Copper Code Conductors**

### Type H2L-2N

- Allows for termination of two copper conductors
- Cast from high strength corrosion resistant copper alloy to provide premium electrical and mechanical performance
- Wide wire range-taking capability minimizes inventory requirements
- Internal pressure plate provides uniform clamping force on conductor for premium electrical performance
- Internal barrel serrations provide premium wire pull-out strength
- Inspection window to visually assure full conductor insertion
- Flat bottom allows for complete contact with mounting surface
- UL Listed for use up to 600 V and temperature rated 90°C
- Available with NEMA hole sizes and spacing

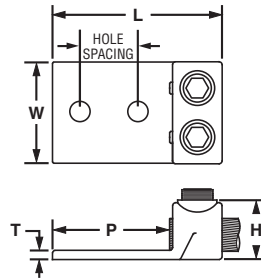

| Part Number  | Copper Conductor Size Range | Stud Hole Size (In.) | Stud Hole Spacing (In.) | Hex Key Size (In.) | Figure Dimensions (In.) |      |      |      |      | Std. Pkg. Qty. |
|--------------|-----------------------------|----------------------|-------------------------|--------------------|-------------------------|------|------|------|------|----------------|
|              |                             |                      |                         |                    | L                       | W    | H    | T    | P    |                |
| ◆ H2L4-2N-X  | #8 SOL – #4 STR             | 1/2                  | 1.75                    | **                 | 3.75                    | 1.25 | 0.76 | 0.19 | 3.00 | 10             |
| ◆ H2L8-2N-2  | #4 SOL – #1 STR             | 1/2                  | 1.75                    | 7/16               | 3.94                    | 1.38 | 0.92 | 0.22 | 3.00 | 2              |
| ◆ H2L13-2N-2 | #1 STR – 2/0 STR            | 1/2                  | 1.75                    | 9/16               | 4.00                    | 1.63 | 1.06 | 0.22 | 3.00 | 2              |
| ◆ H2L21-2N-2 | 2/0 STR – 4/0 STR           | 1/2                  | 1.75                    | 9/16               | 4.19                    | 1.88 | 1.34 | 0.31 | 3.00 | 2              |
| ◆ H2L30-2N-1 | 4/0 STR – 300 kcmil         | 1/2                  | 1.75                    | 5/8                | 4.38                    | 2.00 | 1.45 | 0.31 | 3.00 | 1              |

\*\*Uses slotted head set screw.  
◆NEMA hole sizes and spacing.

## **Two-Hole, Straight Tongue, Two-Barrel, Tin-Plated Lug**

**For Use with Copper Code Conductors**

### Type P2NLT

- Allows for termination of two copper conductors
- Cast from high strength corrosion resistant copper alloy to provide premium electrical and mechanical performance
- Tin-plated to inhibit corrosion
- Wide wire range-taking capability minimizes inventory requirements
- Internal barrel serrations provide premium wire pull-out strength
- Inspection window to visually assure full conductor insertion
- Plated steel set screw provides high strength, durable electrical contact
- Flat bottom allows for complete contact with mounting surface
- UL Listed for use up to 600 V and temperature rated 90°C
- Available with NEMA hole sizes and spacing

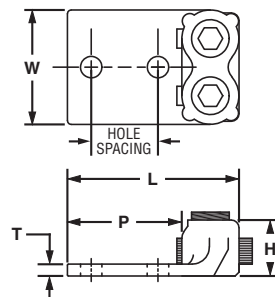

| Part Number   | Copper Conductor Size Range | Stud Hole Size (In.) | Stud Hole Spacing (In.) | Hex Key Size (In.) | Figure Dimensions (In.) |      |      |      |      | Std. Pkg. Qty. |
|---------------|-----------------------------|----------------------|-------------------------|--------------------|-------------------------|------|------|------|------|----------------|
|               |                             |                      |                         |                    | L                       | W    | H    | T    | P    |                |
| ◆ P2NLT-500-3 | #4 SOL – 500 kcmil          | 1/2                  | 1.75                    | 3/8                | 4.50                    | 2.50 | 1.47 | 0.38 | 3.00 | 3              |

◆NEMA hole sizes and spacing.

## Two-Set Screw Splice

**For Use with Copper Code Conductors**

### Type PNLC

- Cast from high strength corrosion resistant copper alloy to provide premium electrical and mechanical performance
- Wide wire range-taking capability minimizes inventory requirements
- Plated steel set screw provides high strength, durable electrical contact between conductor and connector
- Internal wire stops to prevent over-insertion of conductor
- For use up to 600 V and temperature rated 90°C

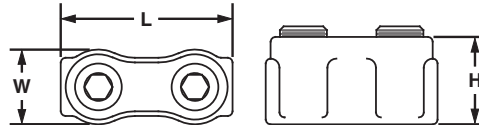

| Part Number | Copper Conductor Size Range | Hex Key Size (In.) | Figure Dimensions (In.) |      |      | Std. Pkg. Qty. |
|-------------|-----------------------------|--------------------|-------------------------|------|------|----------------|
|             |                             |                    | L                       | W    | H    |                |
| PNLC-1/0-3  | #8 SOL – 1/0 STR            | 1/4                | 1.63                    | 0.72 | 0.84 | 3              |
| PNLC-250-1  | #6 SOL – 250 kcmil          | 3/8                | 2.13                    | 0.97 | 1.06 | 1              |
| PNLC-500-1  | #4 SOL – 500 kcmil          | 3/8                | 3.00                    | 1.38 | 1.47 | 1              |

## Two-Set Screw Splice with Internal Pressure Plate

**For Use with Copper Code Conductors**

### Type HC

- Cast from high strength corrosion resistant copper alloy to provide premium electrical and mechanical performance
- Wide wire range-taking capability minimizes inventory requirements
- Internal pressure plate provides uniform clamping force on conductor for premium electrical performance
- Internal barrel serrations provide premium wire pull-out strength
- Internal wire stops to prevent over-insertion of conductor
- UL Listed for use up to 600 V and temperature rated 90°C

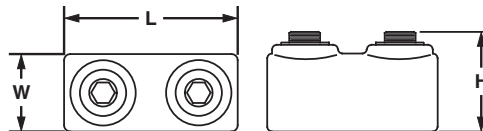

| Part Number | Copper Conductor Size Range | Hex Key Size (In.) | Figure Dimensions (In.) |      |      | Std. Pkg. Qty. |
|-------------|-----------------------------|--------------------|-------------------------|------|------|----------------|
|             |                             |                    | L                       | W    | H    |                |
| HC4-3*      | #8 SOL – #4 STR             | **                 | 1.25                    | 0.50 | 0.56 | 3              |
| HC8-3*      | #4 SOL – #1 STR             | 7/16               | 1.75                    | 0.69 | 0.81 | 3              |
| HC13-3      | #1 STR – 2/0 STR            | 9/16               | 2.00                    | 0.81 | 0.94 | 3              |
| HC21-1      | 2/0 STR – 4/0 STR           | 9/16               | 2.25                    | 1.00 | 1.19 | 1              |
| HC30-1      | 4/0 STR – 300 kcmil         | 5/8                | 2.56                    | 1.19 | 1.44 | 1              |
| HC50-1      | 300 kcmil – 500 kcmil       | 3/4                | 3.00                    | 1.38 | 1.63 | 1              |

\*Includes swivel screws, not internal pressure plate.

\*\*Uses slotted head set screw.

A. System Overview

B1. Cable Ties

B2. Cable Accessories

B3. Stainless Steel Ties

C1. Wiring Duct

C2. Surface Raceway

C3. Abrasion Protection

C4. Cable Management

D1. Terminals

D2. Power Connectors

D3. Grounding Connectors

E1. Labeling Systems

E2. Labels

E3. Pre-Printed & Write-On Markers

E4. Permanent Identification

E5. Lockout/Tagout & Safety Solutions

F. Index

A. System Overview

**UL LISTED** **CSA CERTIFIED** **One-Hole, Straight Fixed Tongue Lug**

B1. Cable Ties

**For Use with Stranded Copper Code Conductors**

**Type CX**

- Made from high strength electrolytic copper to provide premium electrical and mechanical performance
- Compact design saves space
- Wide wire range-taking capability minimizes inventory requirements
- Inspection window to visually assure full conductor insertion
- Plated steel set screw provides high strength, durable electrical contact between conductor and connector
- UL Listed and CSA Certified for use up to 600 V

B2. Cable Accessories

B3. Stainless Steel Ties



C1. Wiring Duct

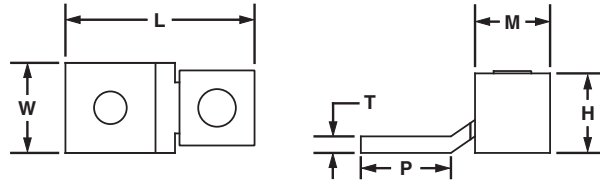

C2. Surface Raceway

| Part Number         | Copper Conductor Size Range                | Current Rating (Amps) | Stud Hole Size (In.) | Hex Size (In.) | Figure Dimensions (In.) |      |      |      |      |      | Std. Pkg. Qty. |
|---------------------|--|-----------------------|----------------------|----------------|-------------------------|------|------|------|------|------|----------------|
|                     |  |                       |                      |                | L                       | W    | H    | T    | P    | M    |                |
| <b>CX35-36-CY</b>   | #14 AWG – #6 AWG                           | 35                    | 3/16                 | **             | 1.02                    | 0.38 | 0.48 | 0.07 | 0.44 | 0.38 | 100            |
| <b>CX70-14-CY</b>   | #14 AWG – #4 AWG, (2) #14 AWG, (2) #12 AWG | 70                    | 1/4                  | **             | 1.27                    | 0.50 | 0.57 | 0.08 | 0.59 | 0.50 | 100            |
| <b>CX125-14-QY*</b> | #4 AWG – 1/0 AWG                           | 125                   | 1/4                  | **             | 1.53                    | 0.62 | 0.77 | 0.13 | 0.84 | 0.62 | 25             |
| <b>CX225-56-QY*</b> | #2 AWG – 4/0 AWG                           | 225                   | 5/16                 | 3/16           | 2.19                    | 1.00 | 1.13 | 0.13 | 1.06 | 1.00 | 25             |

\*cULus Listed for use up to 600V.  
\*\*Uses slotted head set screw.

C4. Cable Management

D1. Terminals

**UL LISTED** **CSA CERTIFIED** **One-Hole, Straight Fixed Tongue, Tin-Plated Lug**

D2. Power Connectors

**For Use with Stranded Copper Code Conductors**

**Type CX-T**

- Made from high strength electrolytic copper to provide premium electrical and mechanical performance
- Tin-plated to inhibit corrosion
- Compact design saves space
- Wide wire range-taking capability minimizes inventory requirements
- Inspection window to visually assure full conductor insertion
- Plated steel set screw provides high strength, durable electrical contact between conductor and connector
- UL Listed and CSA Certified for use up to 600 V

D3. Grounding Connectors

E1. Labeling Systems



E2. Labels

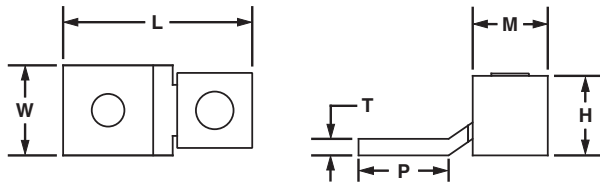

E3. Pre-Printed & Write-On Markers

| Part Number          | Copper Conductor Size Range                | Current Rating (Amps) | Stud Hole Size (In.) | Hex Size (In.) | Figure Dimensions (In.) |      |      |      |      |      | Std. Pkg. Qty. |
|----------------------|--|-----------------------|----------------------|----------------|-------------------------|------|------|------|------|------|----------------|
|                      |  |                       |                      |                | L                       | W    | H    | T    | P    | M    |                |
| <b>CX35-36T-CY</b>   | #14 AWG – #6 AWG                           | 35                    | 3/16                 | **             | 1.02                    | 0.38 | 0.48 | 0.07 | 0.44 | 0.38 | 100            |
| <b>CX70-14T-CY</b>   | #14 AWG – #4 AWG, (2) #14 AWG, (2) #12 AWG | 70                    | 1/4                  | **             | 1.27                    | 0.50 | 0.57 | 0.08 | 0.59 | 0.50 | 100            |
| <b>CX125-56T-QY*</b> | #4 AWG – 1/0 AWG                           | 125                   | 5/16                 | **             | 1.53                    | 0.62 | 0.77 | 0.13 | 0.84 | 0.62 | 25             |
| <b>CX225-38T-QY*</b> | #2 AWG – 4/0 AWG                           | 225                   | 3/8                  | 3/16           | 2.19                    | 1.00 | 1.13 | 0.13 | 1.06 | 1.00 | 25             |
| <b>CX225-56T-QY*</b> | #2 AWG – 4/0 AWG                           | 225                   | 5/16                 | 3/16           | 2.19                    | 1.00 | 1.13 | 0.13 | 1.06 | 1.00 | 25             |

\*cULus Listed for use up to 600V.  
\*\*Uses slotted head set screw.

F. Index

**cUL<sup>US</sup> LISTED One-Hole, Straight Floating Tongue Lug**

**For Use with Stranded Copper Code Conductors**

**Type CS**

- Made from high strength electrolytic copper to provide premium electrical and mechanical performance
- Wide wire range-taking capability minimizes inventory requirements
- Internal pressure bar and V-bottom collar provide uniform clamping force on conductor to assure positive contact between conductor and connector
- Inspection window to visually assure full conductor insertion
- Plated steel set screw provides high strength, durable electrical contact between conductor and connector
- cULus Listed and CSA Certified for use up to 600 V

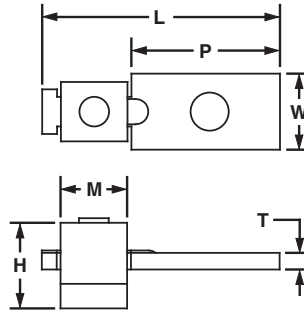

| Part Number        | Copper Conductor Size Range   | Current Rating (Amps) | Stud Hole Size (In.) | Hex Size (In.) | Figure Dimensions (In.) |      |      |      |      |      | Std. Pkg. Qty. |
|--------------------|---|-----------------------|----------------------|----------------|-------------------------|------|------|------|------|------|----------------|
|                    |   |                       |                      |                | L                       | W    | H    | T    | P    | M    |                |
| <b>CS25-18-CY</b>  | #14 AWG – #10 AWG   | 25                    | 1/8                  | **             | 1.16                    | 0.32 | 0.36 | 0.07 | 0.75 | 0.28 | 100            |
| <b>CS35-36-CY</b>  | #14 AWG – #6 AWG,<br>(2) #10 AWG, (2) #12 AWG,<br>(2) #14 AWG,<br>(1) #10 AWG with (1) #12 AWG,<br>(1) #12 AWG with (1) #14 AWG | 50                    | 3/16                 | **             | 1.14                    | 0.38 | 0.49 | 0.07 | 0.60 | 0.43 | 100            |
| <b>CSA70-14-CY</b> | #14 AWG – #4 AWG  | 70                    | 1/4                  | **             | 1.30                    | 0.50 | 0.64 | 0.08 | 0.71 | 0.50 | 100            |
| <b>CS70-14-CY</b>  | #12 AWG – #2 AWG,<br>(1) #8 AWG with (1) #4 AWG,<br>(1) #8 AWG with (1) #6 AWG  | 90                    | 1/4                  | **             | 1.50                    | 0.50 | 0.64 | 0.08 | 0.81 | 0.50 | 100            |
| <b>CS125-14-QY</b> | #2 AWG – 1/0 AWG  | 125                   | 1/4                  | **             | 1.94                    | 0.62 | 0.88 | 0.13 | 1.00 | 0.60 | 25             |
| <b>CS175-38-QY</b> | #4 AWG – 3/0 AWG  | 175                   | 3/8                  | 3/16           | 2.19                    | 0.75 | 1.01 | 0.16 | 1.25 | 0.72 | 25             |
| <b>CS225-56-QY</b> | #6 AWG – 4/0 AWG  | 225                   | 5/16                 | 3/16           | 2.38                    | 1.00 | 1.13 | 0.13 | 1.19 | 0.94 | 25             |
| <b>CS300-38-QY</b> | #1 AWG – 350 kcmil  | 300                   | 3/8                  | 5/16           | 3.19                    | 1.00 | 1.39 | 0.19 | 1.63 | 1.23 | 25             |
| <b>CS400-38-3Y</b> | 1/0 AWG – 500 kcmil   | 400                   | 3/8                  | 5/16           | 3.88                    | 1.50 | 1.61 | 0.19 | 2.19 | 1.41 | 3              |
| <b>CS650-12-3Y</b> | 600 kcmil – 1000 kcmil  | 650                   | 1/2                  | 3/8            | 5.13                    | 2.00 | 2.32 | 0.25 | 2.82 | 1.85 | 3              |

\*\*Uses slotted head set screw.

A. System Overview

B1. Cable Ties

B2. Cable Accessories

B3. Stainless Steel Ties

C1. Wiring Duct

C2. Surface Raceway

C3. Abrasion Protection

C4. Cable Management

D1. Terminals

D2. Power Connectors

D3. Grounding Connectors

E1. Labeling Systems

E2. Labels

E3. Pre-Printed & Write-On Markers

E4. Permanent Identification

E5. Lockout/Tagout & Safety Solutions

F. Index

A. System Overview

**cUL<sup>US</sup> LISTED Two-Hole, Straight Floating Tongue Lug**

B1. Cable Ties

**For Use with Stranded Copper Code Conductors**

**Type CD**

- Made from high strength electrolytic copper to provide premium electrical and mechanical performance
- Wide wire range-taking capability minimizes inventory requirements
- Internal pressure bar and V-bottom collar provide uniform clamping force on conductor to assure positive contact between conductor and connector
- Inspection window to visually assure full conductor insertion
- Plated steel set screw provides high strength, durable electrical contact between conductor and connector
- cULus Listed and CSA Certified for use up to 600 V
- Available with NEMA hole sizes and spacing

B2. Cable Accessories

B3. Stainless Steel Ties

C1. Wiring Duct



C2. Surface Raceway

C3. Abrasion Protection

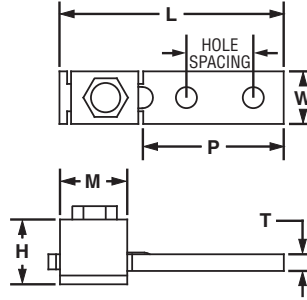

C4. Cable Management

| Part Number          | Copper Conductor Size Range   | Current Rating (Amps) | Stud Hole Size (In.) | Stud Hole Spacing (In.) | Hex Size (In.) | Figure Dimensions (In.) |      |      |      |      |      | Std. Pkg. Qty. |
|----------------------|---|-----------------------|----------------------|-------------------------|----------------|-------------------------|------|------|------|------|------|----------------|
|                      |   |                       |                      |                         |                | L                       | W    | H    | T    | P    | M    |                |
| <b>CD35-36-QY</b>    | #14 AWG – #6 AWG,<br>(2) #10 AWG, (2) #12 AWG,<br>(2) #14 AWG,<br>(1) #10 AWG with (1) #12 AWG,<br>(1) #12 AWG with (1) #14 AWG | 50                    | 3/16                 | 1.00                    | **             | 2.13                    | 0.38 | 0.49 | 0.07 | 1.60 | 0.43 | 25             |
| <b>CD70-14-QY</b>    | #12 AWG – #2 AWG<br>(1) #8 AWG with (1) #4 AWG,<br>(1) #8 AWG with (1) #6 AWG   | 90                    | 1/4                  | 1.00                    | **             | 2.26                    | 0.50 | 0.64 | 0.09 | 1.63 | 0.50 | 25             |
| <b>CD125-14-QY</b>   | #2 – 1/0 AWG  | 125                   | 1/4                  | 1.00                    | **             | 2.94                    | 0.62 | 0.88 | 0.13 | 1.88 | 0.60 | 25             |
| <b>CD225-56-QY</b>   | #6 AWG – 4/0 AWG  | 225                   | 5/16                 | 1.00                    | 3/16           | 3.38                    | 1.00 | 1.13 | 0.13 | 2.13 | .94  | 25             |
| <b>CD300-38-3Y</b>   | #1 AWG – 350 kcmil  | 300                   | 3/8                  | 1.00                    | 5/16           | 4.94                    | 1.00 | 1.39 | 0.19 | 3.32 | 1.23 | 3              |
| ◆ <b>CD400-38-3Y</b> | 1/0 AWG – 500 kcmil   | 400                   | 3/8                  | 1.75                    | 5/16           | 5.62                    | 1.50 | 1.61 | 0.19 | 3.57 | 1.41 | 3              |
| ◆ <b>CD650-12-3Y</b> | 600 kcmil – 1000 kcmil  | 650                   | 1/2                  | 1.75                    | 3/8            | 6.88                    | 2.00 | 2.32 | 0.25 | 4.69 | 1.85 | 3              |

\*\*Uses slotted head set screw.  
◆NEMA hole sizes and spacing.

E1. Labeling Systems

E2. Labels

E3. Pre-Printed & Write-On Markers

E4. Permanent Identification

E5. Lockout/Tagout & Safety Solutions

F. Index





## One-Hole, Offset Floating Tongue Lug

For Use with Stranded Copper Code Conductors

### Type CB

- Made from high strength electrolytic copper to provide premium electrical and mechanical performance
- Wide wire range-taking capability minimizes inventory requirements
- Internal pressure bar and V-bottom collar provide uniform clamping force on conductor to assure positive contact between conductor and connector
- Inspection window to visually assure full conductor insertion
- Plated steel set screw provides high strength, durable electrical contact between conductor and connector
- cULus Listed and CSA Certified for use up to 600 V

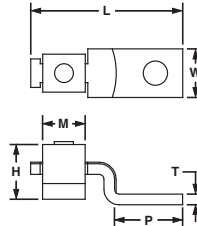

| Part Number        | Copper Conductor Size Range   | Current Rating (Amps) | Stud Hole Size (In.) | Hex Size (In.) | Figure Dimensions (In.) |      |      |      |      |      | Std. Pkg. Qty. |
|--------------------|---|-----------------------|----------------------|----------------|-------------------------|------|------|------|------|------|----------------|
|                    |   |                       |                      |                | L                       | W    | H    | T    | P    | M    |                |
| <b>CB25-18-CY</b>  | #14 AWG – #10 AWG   | 25                    | 1/8                  | **             | 1.00                    | 0.31 | 0.36 | 0.07 | 0.55 | 0.28 | 100            |
| <b>CB35-36-CY</b>  | #14 AWG – #6 AWG,<br>(2) #10 AWG, (2) #12 AWG,<br>(2) #14 AWG,<br>(1) #10 AWG with (1) #12 AWG,<br>(1) #12 AWG with (1) #14 AWG | 50                    | 3/16                 | **             | 1.24                    | 0.39 | 0.49 | 0.07 | 0.59 | 0.43 | 100            |
| <b>CBA70-14-CY</b> | #14 AWG – #4 AWG  | 70                    | 1/4                  | **             | 1.31                    | 0.47 | 0.64 | 0.08 | 0.61 | 0.50 | 100            |
| <b>CB70-14-CY</b>  | #8 AWG – #2 AWG,<br>(1) #8 AWG with (1) #4 AWG,<br>(1) #8 AWG with (1) #6 AWG   | 90                    | 1/4                  | **             | 1.55                    | 0.47 | 0.64 | 0.08 | 0.80 | 0.50 | 100            |
| <b>CB125-14-QY</b> | #6 AWG – 1/0 AWG  | 125                   | 1/4                  | **             | 1.98                    | 0.62 | 0.88 | 0.10 | 1.02 | 0.60 | 25             |
| <b>CB175-38-QY</b> | #4 AWG – 3/0 AWG  | 175                   | 3/8                  | 3/16           | 2.20                    | 0.74 | 1.01 | 0.12 | 1.18 | 0.72 | 25             |
| <b>CB225-56-QY</b> | #2 AWG – 4/0 AWG  | 225                   | 5/16                 | 3/16           | 2.55                    | 0.99 | 1.13 | 0.12 | 1.33 | 0.94 | 25             |
| <b>CB300-38-QY</b> | 1/0 AWG – 350 kcmil   | 300                   | 3/8                  | 5/16           | 2.83                    | 0.99 | 1.39 | 0.12 | 1.33 | 1.23 | 25             |
| <b>CB400-38-3Y</b> | 1/0 AWG – 500 kcmil   | 400                   | 3/8                  | 5/16           | 4.09                    | 1.49 | 1.61 | 0.17 | 2.22 | 1.61 | 3              |
| <b>CB650-12-3Y</b> | 600 kcmil – 1000 kcmil  | 650                   | 1/2                  | 3/8            | 4.84                    | 2.00 | 2.32 | 0.25 | 2.44 | 1.85 | 3              |

\*\*Uses slotted head set screw.

A. System Overview

B1. Cable Ties

B2. Cable Accessories

B3. Stainless Steel Ties

C1. Wiring Duct

C2. Surface Raceway

C3. Abrasion Protection

C4. Cable Management

D1. Terminals

D2. Power Connectors

D3. Grounding Connectors

E1. Labeling Systems

E2. Labels

E3. Pre-Printed & Write-On Markers

E4. Permanent Identification

E5. Lockout/Tagout & Safety Solutions

F. Index

A. System Overview

**cUL<sup>us</sup> LISTED Two-Hole, Offset Floating Tongue Lug**

B1. Cable Ties

**For Use with Stranded Copper Code Conductors**

**Type CO**

- Made from high strength electrolytic copper to provide premium electrical and mechanical performance
- Wide wire range-taking capability minimizes inventory requirements
- Internal pressure bar and V-bottom collar provide uniform clamping force on conductor to assure positive contact between conductor and connector
- Inspection window to visually assure full conductor insertion
- Plated steel set screw provides high strength, durable electrical contact between conductor and connector
- cULus Listed and CSA Certified for use up to 600 V
- Available with NEMA hole sizes and spacing

B2. Cable Accessories

B3. Stainless Steel Ties

C1. Wiring Duct



C2. Surface Raceway

C3. Abrasion Protection

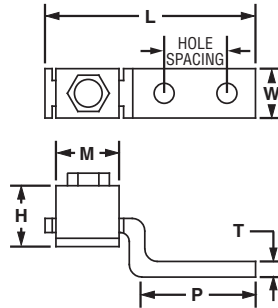

C4. Cable Management

| Part Number          | Copper Conductor Size Range   | Current Rating (Amps) | Stud Hole Size (In.) | Stud Hole Spacing (In.) | Hex Size (In.) | Figure Dimensions (In.) |      |      |      |      |      | Std. Pkg. Qty. |
|----------------------|---|-----------------------|----------------------|-------------------------|----------------|-------------------------|------|------|------|------|------|----------------|
|                      |   |                       |                      |                         |                | L                       | W    | H    | T    | P    | M    |                |
| <b>CO35-36-QY</b>    | #14 AWG – #6 AWG,<br>(2) #10 AWG, (2) #12 AWG,<br>(2) #14 AWG,<br>(1) #10 AWG with (1) #12 AWG,<br>(1) #12 AWG with (1) #14 AWG | 50                    | 3/16                 | 1.00                    | **             | 2.19                    | 0.38 | 0.49 | 0.07 | 1.46 | 0.43 | 25             |
| <b>CO70-14-QY</b>    | #12 AWG – #1 AWG,<br>(1) #8 AWG with (1) #4 AWG,<br>(1) #8 AWG with (1) #6 AWG  | 90                    | 1/4                  | 1.00                    | **             | 2.50                    | 0.50 | 0.64 | 0.09 | 1.60 | 0.50 | 25             |
| <b>CO125-14-QY</b>   | #2 AWG – 1/0 AWG  | 125                   | 1/4                  | 1.00                    | **             | 2.97                    | 0.63 | 0.88 | 0.13 | 1.87 | 0.60 | 25             |
| <b>CO225-56-QY</b>   | #6 AWG – 4/0 AWG  | 225                   | 5/16                 | 1.00                    | 3/16           | 3.62                    | 1.00 | 1.13 | 0.13 | 2.28 | 0.94 | 25             |
| <b>CO300-38-3Y</b>   | #1 AWG – 350 kcmil  | 300                   | 3/8                  | 1.87                    | 5/16           | 5.69                    | 1.00 | 1.39 | 0.19 | 3.99 | 1.23 | 3              |
| <b>CO400-38-3Y</b>   | 1/0 AWG – 500 kcmil   | 400                   | 3/8                  | 1.75                    | 5/16           | 6.00                    | 1.50 | 1.61 | 0.19 | 3.79 | 1.41 | 3              |
| ◆ <b>CO650-12-3Y</b> | 600 kcmil – 1000 kcmil  | 650                   | 1/2                  | 1.75                    | 3/8            | 6.25                    | 2.00 | 2.32 | 0.25 | 3.68 | 1.85 | 3              |

\*\*Uses slotted head set screw.  
◆NEMA hole sizes and spacing.

E1. Labeling Systems

E2. Labels

E3. Pre-Printed & Write-On Markers

E4. Permanent Identification

E5. Lockout/Tagout & Safety Solutions

F. Index



## One-Hole, Single Barrel Lug

For Use with Stranded Aluminum or Copper Code Conductors

### Type LAMA

- Made from high strength, extruded aluminum alloy to provide premium electrical and mechanical performance
- Tin-plated to inhibit corrosion
- Compact design saves space
- Wide wire range-taking capability minimizes inventory requirements
- Inspection window to visually assure full conductor insertion
- Plated steel or aluminum set screw provides high strength, durable electrical contact between conductor and connector
- UL Listed and CSA Certified for use up to 600 V and UL temperature rated 90°C



| Part Number             | Conductor Size Range                         | Stud Hole Size (In.) | Hex Key Size (In.) | Figure Dimensions (In.) |      |      |      |      | Std. Pkg. Qty. |
|-------------------------|--|----------------------|--------------------|-------------------------|------|------|------|------|----------------|
|                         |  |                      |                    | L                       | W    | H    | T    | P    |                |
| <b>LAMA6-14-QY</b>      | #14 AWG – #6 AWG                             | 1/4                  | **                 | 1.06                    | 0.50 | 0.50 | 0.09 | 0.68 | 25             |
| <b>LAMA2-14-QY</b>      | #14 AWG – #2 AWG                             | 1/4                  | **                 | 1.16                    | 0.50 | 0.55 | 0.10 | 0.69 | 25             |
| <b>LAMA1/0-14-QY</b>    | #14 AWG – 1/0 AWG                            | 1/4                  | **                 | 1.47                    | 0.62 | 0.79 | 0.19 | 0.85 | 25             |
| <b>LAMA1/0-56-Q</b>     | #14 AWG – 1/0 AWG                            | 5/16                 | **                 | 1.47                    | 0.62 | 0.79 | 0.19 | 0.85 | 25             |
| <b>LAMA2/0-14-QY</b>    | #14 AWG – 2/0 AWG                            | 1/4                  | 3/16               | 1.47                    | 0.62 | 0.79 | 0.19 | 0.85 | 25             |
| <b>LAMA250-56-QY</b>    | #6 AWG – 250 kcmil                           | 5/16                 | 5/16               | 2.01                    | 1.00 | 1.13 | 0.25 | 0.99 | 25             |
| <b>LAMA300-56-QY*</b>   | #6 AWG – 300 kcmil                           | 5/16                 | 5/16               | 2.00                    | 1.00 | 1.13 | 0.25 | 1.00 | 25             |
| <b>LAMA350-38-QY</b>    | #6 AWG – 350 kcmil                           | 3/8                  | 5/16               | 2.25                    | 1.13 | 1.25 | 0.25 | 1.12 | 25             |
| <b>LAMA500-38-6Y</b>    | #4 AWG – 500 kcmil                           | 3/8                  | 1/2                | 2.81                    | 1.50 | 1.56 | 0.31 | 1.59 | 6              |
| <b>LAMA600-38-6Y</b>    | #2 AWG – 600 kcmil                           | 3/8                  | 1/2                | 3.18                    | 1.60 | 1.57 | 0.44 | 1.81 | 6              |
| <b>LAMA600S-38-6Y*‡</b> | #4 AWG – 600 kcmil – (2) 1/0 AWG – 250 kcmil | 3/8                  | 3/8                | 2.81                    | 1.38 | 1.81 | 0.31 | 1.50 | 6              |
| <b>LAMA1000-58-6Y*</b>  | 500 kcmil – 1000 kcmil                       | 5/8                  | 3/8                | 3.50                    | 1.75 | 1.94 | 0.50 | 1.88 | 6              |

The use of Panduit oxide inhibiting joint compound (CMP-100) is recommended for pad to pad and conductor connections. See page D2.155.

\*UL Listed and CSA Certified.

\*\*Uses slotted head set screw.

‡Accommodates two conductors for conductor range 1/0 AWG – 250 kcmil.

A. System Overview

B1. Cable Ties

B2. Cable Accessories

B3. Stainless Steel Ties

C1. Wiring Duct

C2. Surface Raceway

C3. Abrasion Protection

C4. Cable Management

D1. Terminals

D2. Power Connectors

D3. Grounding Connectors

E1. Labeling Systems

E2. Labels

E3. Pre-Printed & Write-On Markers

E4. Permanent Identification

E5. Lockout/Tagout & Safety Solutions

F. Index

A. System Overview

B1. Cable Ties

B2. Cable Accessories

B3. Stainless Steel Ties

C1. Wiring Duct

C2. Surface Raceway

C3. Abrasion Protection

C4. Cable Management

D1. Terminals

D2. Power Connectors

D3. Grounding Connectors

E1. Labeling Systems

E2. Labels

E3. Pre-Printed & Write-On Markers

E4. Permanent Identification

E5. Lockout/Tagout & Safety Solutions

F. Index

**UL LISTED** **Two-Hole, Single Barrel Lug**

**For Use with Stranded Aluminum or Copper Code Conductors**

**Type LAMB**

- Made from high strength, extruded aluminum alloy to provide premium electrical and mechanical performance
- Tin-plated to inhibit corrosion
- Compact design saves space
- Wide wire range-taking capability minimizes inventory requirements
- Inspection window to visually assure full conductor insertion
- Plated steel or aluminum set screw provides high strength, durable electrical contact between conductor and connector
- LAMLB provided with dual set screws for premium clamping of conductor to connector for heavy duty applications
- UL Listed and CSA Certified for use up to 600 V and UL temperature rated 90°C
- Available with NEMA hole sizes and spacing

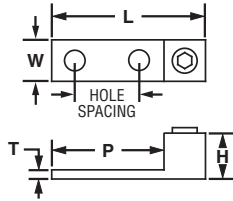

Figure 1

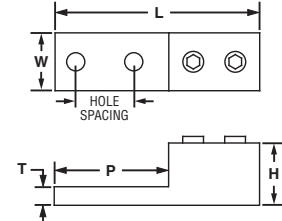

Figure 2

| Part Number       | Figure No. | Conductor Size Range | Stud Hole Size (In.) | Stud Hole Spacing (In.) | Hex Key Size (In.) | Figure Dimensions (In.) |      |      |      |      | Std. Pkg. Qty. |
|-------------------|------------|----------------------|----------------------|-------------------------|--------------------|-------------------------|------|------|------|------|----------------|
|                   |            |                      |                      |                         |                    | L                       | W    | H    | T    | P    |                |
| ◆ LAMB350-12-6Y   | 1          | #6 AWG – 350 kcmil   | 1/2                  | 1.75                    | 5/16               | 4.19                    | 1.13 | 1.28 | 0.28 | 3.05 | 6              |
| ◆ LAMB600-12-3Y   | 1          | #2 AWG – 600 kcmil   | 1/2                  | 1.75                    | 1/2                | 4.69                    | 1.60 | 1.57 | 0.44 | 3.31 | 3              |
| ◆ LAMLB1000-12-3* | 2          | 500 – 1000 kcmil     | 1/2                  | 1.75                    | 1/2                | 6.19                    | 1.63 | 1.88 | 0.56 | 3.44 | 3              |

The use of Panduit oxide inhibiting joint compound (CMP-100) is recommended for pad to pad and conductor connections. See page D2.155.

\*UL Listed and CSA Certified.  
uNEMA hole sizes and spacing.

**UL LISTED** **One-Hole, Two-Barrel Lug**

**For Use with Stranded Aluminum or Copper Code Conductors**

**Type LAM2A**

- Dual barrel provides termination of two conductors
- Made from high strength, extruded aluminum alloy to provide premium electrical and mechanical performance
- Tin-plated to inhibit corrosion
- Wide wire range-taking capability minimizes inventory requirements
- Inspection window to visually assure full conductor insertion
- Plated steel or aluminum set screw provides high strength, durable electrical contact between conductor and connector
- UL Listed and CSA Certified for use up to 600 V and UL temperature rated 90°C
- Available with NEMA hole sizes and spacing

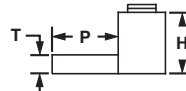
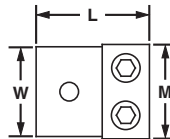

| Part Number             | Conductor Size Range   | Stud Hole Size (In.) | Hex Key Size (In.) | Figure Dimensions (In.) |      |      |      |      |      | Std. Pkg. Qty. |
|-------------------------|------------------------|----------------------|--------------------|-------------------------|------|------|------|------|------|----------------|
|                         |                        |                      |                    | L                       | W    | H    | T    | P    | M    |                |
| <b>LAM2A1/0-14-6Y</b>   | #14 AWG – 1/0 AWG      | 1/4                  | **                 | 1.47                    | 1.13 | 0.78 | 0.19 | 0.85 | 1.13 | 6              |
| <b>LAM2A2/0-14-6Y</b>   | #14 AWG – 2/0 AWG      | 1/4                  | 3/16               | 1.47                    | 1.20 | 0.78 | 0.19 | 0.85 | 1.20 | 6              |
| <b>LAM2A250-38-6Y</b>   | #6 AWG – 250 kcmil     | 3/8                  | 3/8                | 2.56                    | 1.50 | 1.19 | 0.25 | 1.56 | 1.64 | 6              |
| <b>LAM2A350-12-6Y</b>   | #6 AWG – 350 kcmil     | 1/2                  | 5/16               | 2.87                    | 1.73 | 1.25 | 0.25 | 1.74 | 1.91 | 6              |
| <b>LAM2A600-12-6Y*</b>  | #2 AWG – 600 kcmil     | 1/2                  | 3/8                | 3.19                    | 2.00 | 1.56 | 0.44 | 1.81 | 2.38 | 6              |
| <b>LAM2A1000-58-6Y*</b> | 500 kcmil – 1000 kcmil | 5/8                  | 3/8                | 3.50                    | 3.50 | 1.94 | 0.50 | 1.88 | 3.50 | 6              |

The use of Panduit oxide inhibiting joint compound (CMP-100) is recommended for pad to pad and conductor connections. See page D2.155.

\*UL Listed and CSA Certified.

\*\*Uses slotted head set screw.



## One-Hole, Vertical Two-Barrel Lug

For Use with Stranded Aluminum or Copper Code Conductors

### Type LAM2SA

- Dual barrel provides termination of two conductors
- Made from high strength, extruded aluminum alloy to provide premium electrical and mechanical performance
- Tin-plated to inhibit corrosion
- Wide wire range-taking capability minimizes inventory requirements
- Inspection window to visually assure full conductor insertion
- Plated steel or aluminum set screw provides high strength, durable electrical contact between conductor and connector
- UL Listed and CSA Certified for use up to 600 V and UL temperature rated 90°C

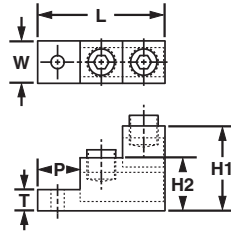

| Part Number    | Conductor Size Range | Stud Hole Size (In.) | Hex Key Size (In.) | Figure Dimensions (In.) |      |      |      |      |      | Std. Pkg. Qty. |
|----------------|----------------------|----------------------|--------------------|-------------------------|------|------|------|------|------|----------------|
|                |                      |                      |                    | L                       | W    | H1   | H2   | T    | P    |                |
| LAM2SA300-56-3 | #6 AWG – 300 kcmil   | 5/16                 | 5/16               | 3.00                    | 1.00 | 2.00 | 1.25 | 0.50 | 1.00 | 3              |

The use of Panduit oxide inhibiting joint compound (CMP-100) is recommended for pad to pad and conductor connections. See page D2.155.



## Two-Hole, Two-Barrel Lug

For Use with Stranded Aluminum or Copper Code Conductors

### Type LAM2B

- Dual barrel provides termination of two conductors
- Made from high strength, extruded aluminum alloy to provide premium electrical and mechanical performance
- Tin-plated to inhibit corrosion
- Wide wire range-taking capability minimizes inventory requirements
- Inspection window to visually assure full conductor insertion
- Plated steel or aluminum set screw provides high strength, durable electrical contact between conductor and connector
- LAM2LB connector provided with dual set screws for premium clamping of conductor to connector for heavy duty applications
- UL Listed for use up to 600 V and temperature rated 90°C
- Available with NEMA hole sizes and spacing



Figure 1

Figure 2

| Part Number        | Figure No. | Conductor Size Range | Stud Hole Size (In.) | Stud Hole Spacing (In.) | Hex Key Size (In.) | Figure Dimensions (In.) |      |      |      |      | Std. Pkg. Qty. |
|--------------------|------------|----------------------|----------------------|-------------------------|--------------------|-------------------------|------|------|------|------|----------------|
|                    |            |                      |                      |                         |                    | L                       | W    | H    | T    | P    |                |
| ◆ LAM2B350-12-3Y   | 1          | #6 AWG – 350 kcmil   | 1/2                  | 1.75                    | 5/16               | 4.19                    | 1.91 | 1.28 | 0.25 | 3.06 | 3              |
| ◆ LAM2LB600-12-3*  | 2          | #2 AWG – 600 kcmil   | 1/2                  | 1.75                    | 3/8                | 5.50                    | 2.85 | 1.50 | 0.38 | 3.25 | 3              |
| ◆ LAM2LB1000-12-3* | 2          | 500 – 1000 kcmil     | 1/2                  | 1.75                    | 1/2                | 6.19                    | 3.48 | 1.88 | 0.56 | 3.44 | 3              |

The use of Panduit oxide inhibiting joint compound (CMP-100) is recommended for pad to pad and conductor connections. See page D2.155.

\*UL Listed and CSA Certified.

◆NEMA hole sizes and spacing.

A. System Overview

B1. Cable Ties

B2. Cable Accessories

B3. Stainless Steel Ties

C1. Wiring Duct

C2. Surface Raceway

C3. Abrasion Protection

C4. Cable Management

D1. Terminals

D2. Power Connectors

D3. Grounding Connectors

E1. Labeling Systems

E2. Labels

E3. Pre-Printed & Write-On Markers

E4. Permanent Identification

E5. Lockout/Tagout & Safety Solutions

F. Index

A. System Overview



## Two-Hole, Vertical Two-Barrel Lug

B1. Cable Ties

**For Use with Stranded Aluminum or Copper Code Conductors**

### Type LAM2SB

- Dual barrel provides termination of two conductors
- Vertical configuration saves space
- Made from high strength, extruded aluminum alloy to provide premium electrical and mechanical performance
- Tin-plated to inhibit corrosion
- Wide wire range-taking capability minimizes inventory requirements

- Inspection window to visually assure full conductor insertion
- Plated steel or aluminum set screw provides high strength, durable electrical contact between conductor and connector
- UL Listed and CSA Certified for use up to 600 V and UL temperature rated 90°C

B2. Cable Accessories

B3. Stainless Steel Ties

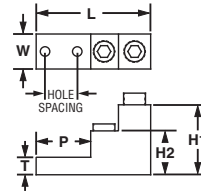

Figure 1

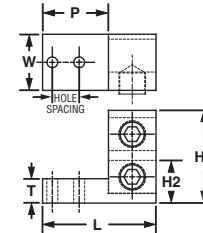

Figure 2

C1. Wiring Duct

C2. Surface Raceway

| Part Number      | Figure No. | Conductor Size Range | Stud Hole Size (In.) | Stud Hole Spacing (In.) | Hex Key Size (In.) | Figure Dimensions (In.) |      |      |      |      | Std. Pkg. Qty. |   |
|------------------|------------|----------------------|----------------------|-------------------------|--------------------|-------------------------|------|------|------|------|----------------|---|
|                  |            |                      |                      |                         |                    | L                       | W    | H1   | H2   | T    |                | P |
| LAM2SB600-38-1Y* | 1          | #2 AWG – 600 kcmil   | 3/8                  | 1.38                    | 3/8                | 4.91                    | 1.50 | 3.00 | 1.88 | 0.75 | 2.34           | 1 |
| LAM2SB750-38-1Y* | 1          | 1/0 AWG – 750 kcmil  | 3/8                  | 1.38                    | 3/8                | 4.91                    | 1.50 | 3.00 | 1.88 | 0.75 | 2.34           | 1 |
| LAM2SSB500-141Y  | 2          | 4/0 AWG – 500 kcmil  | 1/4                  | 0.69                    | 1/2                | 2.91                    | 1.44 | 2.38 | 1.77 | 0.63 | 1.69           | 1 |

The use of Panduit oxide inhibiting joint compound (CMP-100) is recommended for pad to pad and conductor connections. See page D2.155.  
\*UL Listed and CSA Certified.

C4. Cable Management



## Two-Hole, Three-Barrel Lug

D1. Terminals

**For Use with Stranded Aluminum or Copper Code Conductors**

### Type LAM3B

- Triple barrel provides termination of three conductors
- Made from high strength, extruded aluminum alloy to provide premium electrical and mechanical performance
- Tin-plated to inhibit corrosion
- Wide wire range-taking capability minimizes inventory requirements
- Inspection window to visually assure full conductor insertion
- Plated steel or aluminum set screw provides high strength, durable electrical contact between conductor and connector

- LAM3LB connector is provided with dual set screws to allow premium clamping of conductor to connector for heavy duty applications
- For use up to 600 V and temperature rated 90°C
- Available with NEMA hole sizes and spacing

D2. Power Connectors

D3. Grounding Connectors

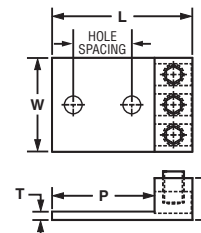

Figure 1

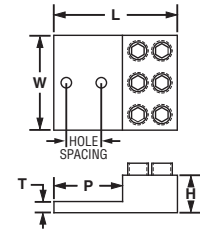

Figure 2

E1. Labeling Systems

E2. Labels

E3. Pre-Printed & Write-On Markers

| Part Number       | Figure No. | Conductor Size Range   | Stud Hole Size (In.) | Stud Hole Spacing (In.) | Hex Key Size (In.) | Figure Dimensions (In.) |      |      |      |      | Std. Pkg. Qty. |
|-------------------|------------|------------------------|----------------------|-------------------------|--------------------|-------------------------|------|------|------|------|----------------|
|                   |            |                        |                      |                         |                    | L                       | W    | H    | T    | P    |                |
| LAM3B1/0-38-6Y    | 1          | #14 AWG – 1/0 AWG      | 3/8                  | 1.00                    | **                 | 2.91                    | 2.00 | 0.88 | 0.25 | 2.16 | 6              |
| ◆ LAM3B3/0-12-3Y  | 1          | #6 AWG – 3/0 AWG       | 1/2                  | 1.75                    | 1/4                | 4.25                    | 2.81 | 1.19 | 0.31 | 3.25 | 3              |
| ◆ LAM3B250-12-1Y  | 1          | #6 AWG – 250 kcmil     | 1/2                  | 1.75                    | 5/16               | 4.00                    | 2.82 | 1.19 | 0.31 | 3.00 | 1              |
| ◆ LAM3B350-12-1Y  | 1          | #6 AWG – 350 kcmil     | 1/2                  | 1.75                    | 5/16               | 4.50                    | 3.50 | 1.38 | 0.31 | 3.25 | 1              |
| ◆ LAM3LB600-12-1  | 2          | #2 AWG – 600 kcmil     | 1/2                  | 1.75                    | 3/8                | 5.50                    | 4.32 | 1.50 | 0.38 | 3.25 | 1              |
| ◆ LAM3LB1000-121Y | 2          | 500 kcmil – 1000 kcmil | 1/2                  | 1.75                    | 1/2                | 6.19                    | 5.27 | 1.88 | 0.56 | 3.44 | 1              |

The use of Panduit oxide inhibiting joint compound (CMP-100) is recommended for pad to pad and conductor connections. See page D2.155.

\*\*Uses slotted head set screw.

◆NEMA hole sizes and spacing.

E4. Permanent Identification

E5. Lockout/Tagout & Safety Solutions

F. Index





## Four-Hole, Three-Barrel Lug

**For Use with Stranded Aluminum or Copper Code Conductors**

### Type LAM3D

- Triple barrel provides termination of three conductors
- Made from high strength, extruded aluminum alloy to provide premium electrical and mechanical performance
- Tin-plated to inhibit corrosion
- Wide wire range-taking capability minimizes inventory requirements
- Inspection window to visually assure full conductor insertion

- Plated steel or aluminum set screw provides high strength, durable electrical contact between conductor and connector
- LAM3LD connector is provided with dual set screws to allow premium clamping of conductor to connector for heavy duty applications
- For use up to 600 V and temperature rated 90°C
- Available with NEMA hole sizes and spacing

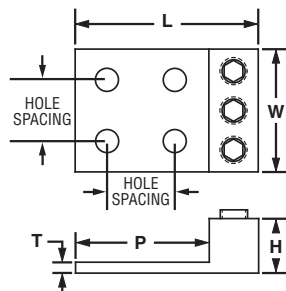

Figure 1

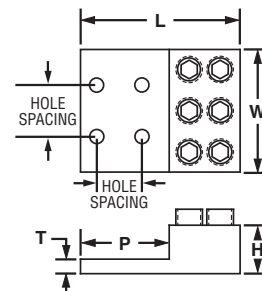

Figure 2

| Part Number       | Figure No. | Conductor Size Range   | Stud Hole Size (In.) | Stud Hole Spacing (In.) | Hex Key Size (In.) | Figure Dimensions (In.) |      |      |      |      | Std. Pkg. Qty. |
|-------------------|------------|------------------------|----------------------|-------------------------|--------------------|-------------------------|------|------|------|------|----------------|
|                   |            |                        |                      |                         |                    | L                       | W    | H    | T    | P    |                |
| ◆ LAM3D3/0-12-3Y  | 1          | #6 AWG – 3/0 AWG       | 1/2                  | 1.75                    | 1/4                | 4.25                    | 2.81 | 1.19 | 0.31 | 3.25 | 3              |
| ◆ LAM3D250-12-1Y  | 1          | #6 AWG – 250 kcmil     | 1/2                  | 1.75                    | 5/16               | 4.25                    | 3.00 | 1.19 | 0.31 | 3.25 | 1              |
| ◆ LAM3D350-12-1Y  | 1          | #6 AWG – 350 kcmil     | 1/2                  | 1.75                    | 5/16               | 4.50                    | 3.50 | 1.38 | 0.31 | 3.25 | 1              |
| ◆ LAM3LD600-12-1  | 2          | #2 AWG – 600 kcmil     | 1/2                  | 1.75                    | 3/8                | 5.50                    | 4.32 | 1.50 | 0.38 | 3.25 | 1              |
| ◆ LAM3LD1000-121Y | 2          | 500 kcmil – 1000 kcmil | 1/2                  | 1.75                    | 1/2                | 6.19                    | 5.27 | 1.88 | 0.56 | 3.44 | 1              |

The use of Panduit oxide inhibiting joint compound (CMP-100) is recommended for pad to pad and conductor connections. See page D2.155.

◆NEMA hole sizes and spacing.

A. System Overview

B1. Cable Ties

B2. Cable Accessories

B3. Stainless Steel Ties

C1. Wiring Duct

C2. Surface Raceway

C3. Abrasion Protection

C4. Cable Management

D1. Terminals

D2. Power Connectors

D3. Grounding Connectors

E1. Labeling Systems

E2. Labels

E3. Pre-Printed & Write-On Markers

E4. Permanent Identification

E5. Lockout/Tagout & Safety Solutions

F. Index

A. System Overview



## Two-Hole, Vertical Four-Barrel Lug

B1. Cable Ties

**For Use with Stranded Aluminum or Copper Code Conductors**

B2. Cable Accessories

### Type LAM4SB

- Four barrels provide termination of four conductors
- Vertical configuration saves space
- Made from high strength, extruded aluminum alloy to provide premium electrical and mechanical performance
- Tin-plated to inhibit corrosion

- Wide wire range-taking capability minimizes inventory requirements
- Inspection window to visually assure full conductor insertion
- Plated steel or aluminum set screw provides high strength, durable electrical contact between conductor and connector
- UL Listed and CSA Certified for use up to 600 V and UL temperature rated 90°C

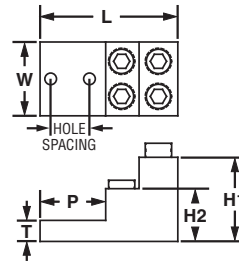

B3. Stainless Steel Ties

C1. Wiring Duct

C2. Surface Raceway

C3. Abrasion Protection

| Part Number     | Conductor Size Range | Stud Hole Size (In.) | Stud Hole Spacing (In.) | Hex Key Size (In.) | Figure Dimensions (In.) |      |      |      |      |      | Std. Pkg. Qty. |
|-----------------|----------------------|----------------------|-------------------------|--------------------|-------------------------|------|------|------|------|------|----------------|
|                 |                      |                      |                         |                    | L                       | W    | H1   | H2   | T    | P    |                |
| LAM4SB600-38-1Y | #2 AWG – 600 kcmil   | 3/8                  | 1.38                    | 3/8                | 4.91                    | 2.47 | 3.00 | 1.88 | 0.75 | 2.34 | 1              |
| LAM4SB750-38-1Y | 1/0 AWG – 750 kcmil  | 3/8                  | 1.38                    | 3/8                | 4.91                    | 2.84 | 3.00 | 1.88 | 0.75 | 2.34 | 1              |

The use of Panduit oxide inhibiting joint compound (CMP-100) is recommended for pad to pad and conductor connections. See page D2.155.

C4. Cable Management



## Four-Hole, Four-Barrel Lug

D1. Terminals

**For Use with Stranded Aluminum or Copper Code Conductors**

### Type LAM4D

- Four barrels provide termination of four conductors
- Made from high strength, extruded aluminum alloy to provide premium electrical and mechanical performance
- Tin-plated to inhibit corrosion
- Wide wire range-taking capability minimizes inventory requirements
- Inspection window to visually assure full conductor insertion

- Plated steel or aluminum set screw provides high strength, durable electrical contact between conductor and connector
- LAM4LD connector is provided with dual set screws to allow premium clamping of conductor to connector for heavy duty applications
- For use up to 600 V and temperature rated 90°C
- Available with NEMA hole sizes and spacing

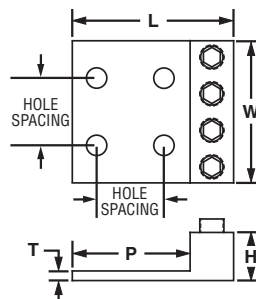

Figure 1

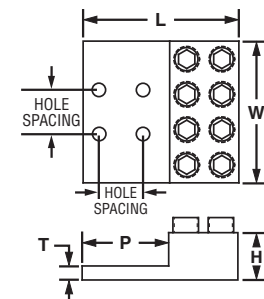

Figure 2

D2. Power Connectors

D3. Grounding Connectors

E1. Labeling Systems

E2. Labels

E3. Pre-Printed & Write-On Markers

E4. Permanent Identification

E5. Lockout/Tagout & Safety Solutions

F. Index

| Part Number       | Figure No. | Conductor Size Range | Stud Hole Size (In.) | Stud Hole Spacing (In.) | Hex Key Size (In.) | Figure Dimensions (In.) |      |      |      |      | Std. Pkg. Qty. |
|-------------------|------------|----------------------|----------------------|-------------------------|--------------------|-------------------------|------|------|------|------|----------------|
|                   |            |                      |                      |                         |                    | L                       | W    | H    | T    | P    |                |
| ◆ LAM4D250-12-1Y  | 1          | # 6 AWG – 250 kcmil  | 1/2                  | 1.75                    | 5/16               | 4.25                    | 4.04 | 1.19 | 0.31 | 3.25 | 1              |
| ◆ LAM4D350-12-1Y  | 1          | # 6 AWG – 350 kcmil  | 1/2                  | 1.75                    | 5/16               | 4.50                    | 4.72 | 1.37 | 0.31 | 3.25 | 1              |
| ◆ LAM4LD600-12-1  | 2          | #2 – 600 kcmil       | 1/2                  | 1.75                    | 3/8                | 5.50                    | 5.31 | 1.50 | 0.38 | 3.25 | 1              |
| ◆ LAM4LD1000-12-1 | 2          | 350 – 1000 kcmil     | 1/2                  | 1.75                    | 3/8                | 6.19                    | 7.11 | 1.88 | 0.56 | 3.44 | 1              |

The use of Panduit oxide inhibiting joint compound (CMP-100) is recommended for pad to pad and conductor connections. See page D2.155.

◆NEMA hole sizes and spacing.

## Transformer Lug Kit

**For Use with Stranded Aluminum or Copper Code Conductors**

### Type KLM

- Kits include all of the connectors and hardware to make a complete transformer connection in a single convenient package
- Lugs are made from high strength, extruded aluminum alloy and are tin-plated to inhibit corrosion and oxidation
- Plated steel cap screws, Belleville and flat washers, and hex nuts are provided to assure that terminal to bus connections are made using proper hardware resulting in true torque to pressure performance
- Hardware is packaged in a sealed plastic bag to prevent lost hardware prior to installation
- KLM6-800 and KLM350-800 kits include lugs that accommodate 750 kcmil conductors used with large transformers
- Lugs are UL Listed and CSA Certified for use up to 600 V and UL temperature rated 90°C



| Part Number | Transformer KVA Rating                   | Aluminum Mechanical Lug |      | Conductor Size Range                        | Hardware (Sizes in Inches) |      |             |      |             |      |
|-------------|--|-------------------------|------|---|----------------------------|------|-------------|------|-------------|------|
|             |  | Part No.                | Qty. |   | Hex Bolt Size              | Qty. | Nut Size    | Qty. | Washer Size | Qty. |
| KLM14-250Y  | 15 – 37.5 KVA 1PH<br>15 – 45 KVA 3PH     | LAMA2-14                | 8    | #14 – 2 AWG<br>#6 AWG – 250 kcmil           | 1/4 – 20 x 3/4 HH          | 8    | 1/4 – 20 HN | 8    | 1/4 FLAT    | 16   |
|             |  | LAMA250-56              | 4    |   | 1/4 – 20 x 2 HH            | 8    |             |      | 1/4 CMP     | 8    |
| KLM6-250Y   | 50 – 75 KVA 1 PH<br>75 – 112.5 KVA 3 PH  | LAMA250-56              | 12   | #6 AWG – 250 kcmil                          | 1/4 – 20 x 3/4 HH          | 8    | 1/4 – 20 HN | 16   | 1/4 FLAT    | 32   |
| KLM6-600Y   | 100 – 167 KVA 1PH<br>150 – 300 KVA 3 PH  | LAMA250-56              | 3    | #6 AWG – 250 kcmil<br>#4 AWG – 600 kcmil    | 1/4 – 20 x 3/4 HH          | 3    | 1/4 – 20 HN | 3    | 3/8 FLAT    | 6    |
|             |  | LAMA600-38              | 3    |   | 3/8 – 16 x 2 HH            | 16   |             |      | 3/8 CMP     | 16   |
| KLM6-800Y   | 100 – 167 KVA 1 PH<br>150 – 300 KVA 3 PH | LAM2A350-12             | 6    | #6 AWG – 350 kcmil<br>350 kcmil – 800 kcmil | 1/2 – 13 x 2 HH            | 5    | 1/2 – 13 HN | 11   | 1/2 FLAT    | 22   |
|             |  | LAM2A800-58             | 7    |   | 1/2 – 13 x 2 1/2 HH        | 6    |             |      | 1/2 CMP     | 11   |
| KLM350-800Y | 500 KVA 3 PH                             | LAM2A800-58             | 15   | 350 kcmil – 800 kcmil                       | 1/2 – 13 x 2 HH            | 7    | 1/2 – 13 HN | 11   | 1/2 FLAT    | 22   |
|             |  |                         |      |   | 1/2 – 13 x 2 1/2 HH        | 4    |             |      | 1/2 CMP     | 11   |

Suffix: HH = Hex Head; HN = Hex Nut; FLAT = Flat Washer; CMP = Compression Washer.

The use of Panduit oxide inhibiting joint compound (CMP-100) is recommended for pad to pad and conductor connections. See page D2.155.

A.  
System  
Overview

B1.  
Cable  
Ties

B2.  
Cable  
Accessories

B3.  
Stainless  
Steel Ties

C1.  
Wiring  
Duct

C2.  
Surface  
Raceway

C3.  
Abrasion  
Protection

C4.  
Cable  
Management

D1.  
Terminals

D2.  
Power  
Connectors

D3.  
Grounding  
Connectors

E1.  
Labeling  
Systems

E2.  
Labels

E3.  
Pre-Printed  
& Write-On  
Markers

E4.  
Permanent  
Identification

E5.  
Lockout/  
Tagout  
& Safety  
Solutions

F.  
Index

A. System Overview



## Splicer/Reducer

B1. Cable Ties

**For Use with Stranded Aluminum or Copper Code Conductors**

### Type SR

B2. Cable Accessories

- Made from high strength extruded aluminum alloy to provide premium electrical and mechanical performance
- Tin-plated to inhibit corrosion
- Rounded bottoms to facilitate taping
- Solid center barrier prevents contact of dissimilar metal conductors
- Wide wire range-taking capability minimizes inventory requirements
- UL Listed and CSA Certified for use up to 600 V and UL temperature rated 90°C

B3. Stainless Steel Ties



C1. Wiring Duct

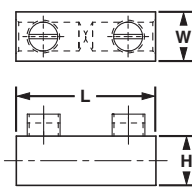

Figure 1

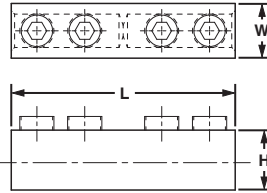

Figure 2

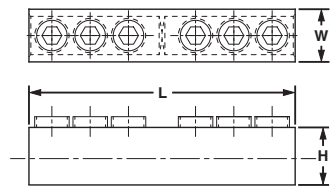

Figure 3

C2. Surface Raceway

C3. Abrasion Protection

C4. Cable Management

D1. Terminals

D2. Power Connectors

D3. Grounding Connectors

E1. Labeling Systems

E2. Labels

E3. Pre-Printed & Write-On Markers

E4. Permanent Identification

E5. Lockout/Tagout & Safety Solutions

F. Index

| Part Number | Figure No. | Conductor Size Range        |                             | Figure Dimensions (In.) |      |      | Hex Key Size (In.) | Std. Pkg. Qty. |
|-------------|------------|-----------------------------|-----------------------------|-------------------------|------|------|--------------------|----------------|
|             |            | Max.                        | Min.                        | L                       | W    | H    |                    |                |
| SR-2-XY     | 1          | #2 AWG STR,<br>#10 AWG SOL  | #14 AWG STR,<br>#14 AWG SOL | 1.38                    | 0.50 | 0.56 | **                 | 10             |
| SR-0-XY     | 1          | 1/0 AWG STR,<br>#10 AWG SOL | #14 AWG STR,<br>#14 AWG SOL | 1.91                    | 0.75 | 0.75 | **                 | 10             |
| SR-4/0-XY   | 1          | 4/0 AWG                     | #6 AWG                      | 2.31                    | 1.00 | 1.13 | 5/16               | 10             |
| SR-250-XY   | 2          | 250 kcmil                   | #6 AWG                      | 3.94                    | 1.00 | 1.13 | 5/16               | 10             |
| SR-350-XY   | 2          | 350 kcmil                   | #6 AWG                      | 4.19                    | 1.13 | 1.19 | 5/16               | 10             |
| SR-500-3Y   | 2          | 500 kcmil                   | 3/0 AWG                     | 5.00                    | 1.37 | 1.40 | 3/8                | 3              |
| SR-750-1Y   | 2          | 750 kcmil                   | 250 kcmil                   | 6.25                    | 1.63 | 1.75 | 1/2                | 1              |
| SR-1000-1Y  | 3          | 1000 kcmil                  | 500 kcmil                   | 8.69                    | 1.72 | 1.88 | 9/16               | 1              |

The use of Panduit oxide inhibiting joint compound (CMP-100) is recommended. See page D2.155.

\*\*Uses slotted screws.



## Multi-Tap Connector with Clear Insulation, Single-Sided

For Use with Aluminum or Copper Code Conductors

### Type PCSB-S

- Flexible design – can be used as a tap, splice, or dead end connector
- Body made from high strength, extruded aluminum alloy to provide premium electrical and mechanical performance
- Insulated with clear PVC to eliminate the need for taping and allow for visual inspection of the complete conductor insertion
- Each port pre-filled with oxide inhibiting joint compound seals out air and moisture to deter surface oxidation
- Wide wire range-taking capability minimizes inventory requirements
- Plated steel or aluminum set screw provides high strength, durable electrical contact between conductor and connector
- UL Listed and CSA Certified for use up to 600 V and temperature rated 90°C\*

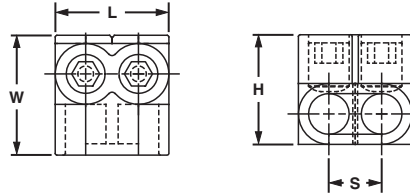

| Part Number    | Conductor Size Range                  | No. of Ports                           | Figure Dimensions (in.) |      |      |      | Hex Key Size (in.) | Std. Pkg. Qty. |   |
|----------------|---------------------------------------|--|-------------------------|------|------|------|--------------------|----------------|---|
|                |                                       |  | L                       | W    | H    | S    |                    |                |   |
| PCSB4-2S-12Y   | #4 – #14 AWG STR<br>#10 – #14 AWG SOL | 2                                      | 1.23                    | 1.25 | 1.25 | 0.53 | 1/8                | 12             |   |
| PCSB4-3S-12Y   |                                       | 3                                      | 1.76                    | 1.25 | 1.25 | 0.53 | 1/8                | 12             |   |
| PCSB4-4S-6Y    |                                       | 4                                      | 2.29                    | 1.25 | 1.25 | 0.53 | 1/8                | 6              |   |
| PCSB4-5S-6Y    |                                       | 5                                      | 2.82                    | 1.25 | 1.25 | 0.53 | 1/8                | 6              |   |
| PCSB4-6S-6Y    |                                       | 6                                      | 3.35                    | 1.25 | 1.25 | 0.53 | 1/8                | 6              |   |
| PCSB4-10S-4Y   |                                       | 10                                     | 5.47                    | 1.25 | 1.25 | 0.53 | 1/8                | 4              |   |
| PCSB4-12S-3Y   |                                       | 12                                     | 6.53                    | 1.25 | 1.25 | 0.53 | 1/8                | 3              |   |
| PCSB4-14S-2Y   |                                       | 14                                     | 7.59                    | 1.25 | 1.25 | 0.53 | 1/8                | 2              |   |
| PCSB2/0-2S-6   |                                       | 2/0 – #14 AWG STR<br>#10 – #14 AWG SOL | 2                       | 1.52 | 1.31 | 1.38 | 0.67               | 3/16           | 6 |
| PCSB2/0-3S-6Y  |                                       |  | 3                       | 2.19 | 1.31 | 1.38 | 0.67               | 3/16           | 6 |
| PCSB2/0-4S-6Y  | 4                                     |  | 2.86                    | 1.31 | 1.38 | 0.67 | 3/16               | 6              |   |
| PCSB2/0-5S-4Y  | 5                                     |  | 3.53                    | 1.31 | 1.38 | 0.67 | 3/16               | 4              |   |
| PCSB2/0-6S-4Y  | 6                                     |  | 4.20                    | 1.31 | 1.38 | 0.67 | 3/16               | 4              |   |
| PCSB2/0-8S-3Y  | 8                                     |  | 5.55                    | 1.31 | 1.38 | 0.67 | 3/16               | 3              |   |
| PCSB2/0-10S-2Y | 10                                    |  | 6.89                    | 1.31 | 1.38 | 0.67 | 3/16               | 2              |   |
| PCSB2/0-12S-1Y | 12                                    |  | 8.24                    | 1.31 | 1.38 | 0.67 | 3/16               | 1              |   |
| PCSB2/0-14S-1Y | 14                                    |  | 9.58                    | 1.31 | 1.38 | 0.67 | 3/16               | 1              |   |
| PCSB250-2S-6Y  | 250 kcmil – #10 AWG STR               |  | 2                       | 2.03 | 2.00 | 2.13 | 0.94               | 5/16           | 6 |
| PCSB250-3S-6Y  |                                       |  | 3                       | 2.97 | 2.00 | 2.13 | 0.94               | 5/16           | 6 |
| PCSB250-4S-6Y  |                                       |  | 4                       | 3.91 | 2.00 | 2.13 | 0.94               | 5/16           | 6 |
| PCSB250-5S-4Y  |                                       |  | 5                       | 4.84 | 2.00 | 2.13 | 0.94               | 5/16           | 4 |
| PCSB250-6S-4Y  |                                       |  | 6                       | 5.78 | 2.00 | 2.13 | 0.94               | 5/16           | 4 |
| PCSB250-8S-3Y  |                                       | 8                                      | 7.66                    | 2.00 | 2.13 | 0.94 | 5/16               | 3              |   |
| PCSB250-10S-2Y |                                       | 10                                     | 9.53                    | 2.00 | 2.13 | 0.94 | 5/16               | 2              |   |
| PCSB250-12S-2Y |                                       | 12                                     | 11.41                   | 2.00 | 2.13 | 0.94 | 5/16               | 2              |   |
| PCSB250-14S-1Y |                                       | 14                                     | 13.29                   | 2.00 | 2.13 | 0.94 | 5/16               | 1              |   |
| PCSB350-2S-4Y  |                                       | 350 kcmil – #10 AWG STR                | 2                       | 2.17 | 2.25 | 2.50 | 1.00               | 5/16           | 4 |
| PCSB350-3S-4Y  |                                       |  | 3                       | 3.17 | 2.25 | 2.50 | 1.00               | 5/16           | 4 |
| PCSB350-4S-3Y  |                                       |  | 4                       | 4.17 | 2.25 | 2.50 | 1.00               | 5/16           | 3 |
| PCSB350-5S-3Y  |                                       |  | 5                       | 5.17 | 2.25 | 2.50 | 1.00               | 5/16           | 3 |
| PCSB350-6S-2Y  |                                       |  | 6                       | 6.17 | 2.25 | 2.50 | 1.00               | 5/16           | 2 |
| PCSB350-8S-2Y  | 8                                     |  | 8.17                    | 2.25 | 2.50 | 1.00 | 5/16               | 2              |   |
| PCSB350-10S-2Y | 10                                    |  | 10.17                   | 2.25 | 2.50 | 1.00 | 5/16               | 2              |   |
| PCSB350-12S-1Y | 12                                    |  | 12.17                   | 2.25 | 2.50 | 1.00 | 5/16               | 1              |   |
| PCSB350-14S-1Y | 14                                    |  | 14.17                   | 2.25 | 2.50 | 1.00 | 5/16               | 1              |   |
| PCSB600-2S-4Y  | 600 kcmil – #6 AWG STR                |  | 2                       | 2.72 | 2.25 | 2.75 | 1.28               | 3/8            | 4 |
| PCSB600-3S-3Y  |                                       |  | 3                       | 4.00 | 2.25 | 2.75 | 1.28               | 3/8            | 3 |
| PCSB600-4S-2Y  |                                       |  | 4                       | 5.28 | 2.25 | 2.75 | 1.28               | 3/8            | 2 |
| PCSB600-5S-2Y  |                                       |  | 5                       | 6.56 | 2.25 | 2.75 | 1.28               | 3/8            | 2 |
| PCSB600-6S-2Y  |                                       |  | 6                       | 7.84 | 2.25 | 2.75 | 1.28               | 3/8            | 2 |
| PCSB600-8S-2Y  |                                       | 8                                      | 10.41                   | 2.25 | 2.75 | 1.28 | 3/8                | 2              |   |
| PCSB600-10S-1Y |                                       | 10                                     | 12.97                   | 2.25 | 2.75 | 1.28 | 3/8                | 1              |   |
| PCSB600-12S-1Y |                                       | 12                                     | 15.93                   | 2.25 | 2.75 | 1.28 | 3/8                | 1              |   |
| PCSB600-14S-1Y |                                       | 14                                     | 18.09                   | 2.25 | 2.75 | 1.28 | 3/8                | 1              |   |
| PCSB750-2S-1   |                                       | 750 kcmil – #2 AWG STR                 | 2                       | 2.88 | 2.63 | 3.00 | 1.38               | 3/8            | 1 |

\*PCSB750-2S-1 is not UL Listed or CSA Certified.

A. System Overview

B1. Cable Ties

B2. Cable Accessories

B3. Stainless Steel Ties

C1. Wiring Duct

C2. Surface Raceway

C3. Abrasion Protection

C4. Cable Management

D1. Terminals

D2. Power Connectors

D3. Grounding Connectors

E1. Labeling Systems

E2. Labels

E3. Pre-Printed & Write-On Markers

E4. Permanent Identification

E5. Lockout/Tagout & Safety Solutions

F. Index

A. System Overview



## Multi-Tap Connector with Clear Insulation, Double-Sided

B1. Cable Ties

**For Use with Aluminum or Copper Code Conductors**

### Type PCSB

- Flexible design – can be used as a tap, splice, or dead end connector
- Body made from high strength, extruded aluminum alloy to provide premium electrical and mechanical performance
- Insulated with clear PVC to eliminate the need for taping and allow for visual inspection of the complete conductor insertion
- Each port pre-filled with oxide inhibiting joint compound seals out air and moisture to deter surface oxidation
- Wide wire range-taking capability minimizes inventory requirements
- Dual-sided entry allows offset and opposite entry for primary and secondary conductors
- Plated steel or aluminum set screw provides high strength, durable electrical contact between conductor and connector
- UL Listed and CSA Certified for use up to 600 V and temperature rated 90°C

B2. Cable Accessories

B3. Stainless Steel Ties

C1. Wiring Duct

C2. Surface Raceway

C3. Abrasion Protection

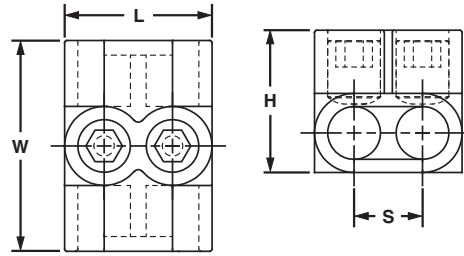

C4. Cable Management

D1. Terminals

D2. Power Connectors

D3. Grounding Connectors

E1. Labeling Systems

E2. Labels

E3. Pre-Printed & Write-On Markers

E4. Permanent Identification

E5. Lockout/Tagout & Safety Solutions

F. Index

| Part Number          | Conductor Size Range                  | No. of Ports                           | Figure Dimensions (in.) |      |      |      | Hex Key Size (in.) | Std. Pkg. Qty. |    |
|----------------------|---------------------------------------|--|-------------------------|------|------|------|--------------------|----------------|----|
|                      |                                       |  | L                       | W    | H    | S    |                    |                |    |
| <b>PCSB4-2-12Y</b>   | #4 – #14 AWG STR<br>#10 – #14 AWG SOL | 2                                      | 1.23                    | 1.50 | 1.25 | 0.53 | 1/8                | 12             |    |
| <b>PCSB4-3-12Y</b>   |                                       | 3                                      | 1.76                    | 1.50 | 1.25 | 0.53 | 1/8                | 12             |    |
| <b>PCSB4-4-6Y</b>    |                                       | 4                                      | 2.29                    | 1.50 | 1.25 | 0.53 | 1/8                | 6              |    |
| <b>PCSB4-5-6Y</b>    |                                       | 5                                      | 2.82                    | 1.50 | 1.25 | 0.53 | 1/8                | 6              |    |
| <b>PCSB4-6-6Y</b>    |                                       | 6                                      | 3.35                    | 1.50 | 1.25 | 0.53 | 1/8                | 6              |    |
| <b>PCSB4-8-4Y</b>    |                                       | 8                                      | 4.41                    | 1.50 | 1.25 | 0.53 | 1/8                | 4              |    |
| <b>PCSB4-10-4Y</b>   |                                       | 10                                     | 5.47                    | 1.50 | 1.25 | 0.53 | 1/8                | 4              |    |
| <b>PCSB4-12-3Y</b>   |                                       | 12                                     | 6.53                    | 1.50 | 1.25 | 0.53 | 1/8                | 3              |    |
| <b>PCSB4-14-2Y</b>   |                                       | 14                                     | 7.59                    | 1.50 | 1.25 | 0.53 | 1/8                | 2              |    |
| <b>PCSB2/0-2-12</b>  |                                       | 2/0 – #14 AWG STR<br>#10 – #14 AWG SOL | 2                       | 1.52 | 1.56 | 1.38 | 0.67               | 3/16           | 12 |
| <b>PCSB2/0-3-6</b>   |                                       |  | 3                       | 2.19 | 1.56 | 1.38 | 0.67               | 3/16           | 6  |
| <b>PCSB2/0-4-6</b>   |                                       |  | 4                       | 2.86 | 1.56 | 1.38 | 0.67               | 3/16           | 6  |
| <b>PCSB2/0-5-6</b>   |                                       |  | 5                       | 3.53 | 1.56 | 1.38 | 0.67               | 3/16           | 6  |
| <b>PCSB2/0-6-6</b>   |                                       |  | 6                       | 4.20 | 1.56 | 1.38 | 0.67               | 3/16           | 6  |
| <b>PCSB2/0-8-4</b>   | 8                                     |  | 5.55                    | 1.56 | 1.38 | 0.67 | 3/16               | 4              |    |
| <b>PCSB2/0-10-2Y</b> | 10                                    |  | 6.89                    | 1.56 | 1.38 | 0.67 | 3/16               | 2              |    |
| <b>PCSB2/0-12-2Y</b> | 12                                    |  | 8.24                    | 1.56 | 1.38 | 0.67 | 3/16               | 2              |    |
| <b>PCSB2/0-14-1Y</b> | 14                                    |  | 9.58                    | 1.56 | 1.38 | 0.67 | 3/16               | 1              |    |
| <b>PCSB250-2-6Y</b>  | 250 kcmil – #10 AWG STR               |  | 2                       | 2.03 | 2.63 | 2.13 | 0.94               | 5/16           | 6  |
| <b>PCSB250-3-6Y</b>  |                                       | 3                                      | 2.97                    | 2.63 | 2.13 | 0.94 | 5/16               | 6              |    |
| <b>PCSB250-4-6Y</b>  |                                       | 4                                      | 3.91                    | 2.63 | 2.13 | 0.94 | 5/16               | 6              |    |
| <b>PCSB250-5-4Y</b>  |                                       | 5                                      | 4.84                    | 2.63 | 2.13 | 0.94 | 5/16               | 4              |    |
| <b>PCSB250-6-4Y</b>  |                                       | 6                                      | 5.78                    | 2.63 | 2.13 | 0.94 | 5/16               | 4              |    |
| <b>PCSB250-8-3Y</b>  |                                       | 8                                      | 7.66                    | 2.63 | 2.13 | 0.94 | 5/16               | 3              |    |
| <b>PCSB250-10-2Y</b> |                                       | 10                                     | 9.53                    | 2.63 | 2.13 | 0.94 | 5/16               | 2              |    |
| <b>PCSB250-12-2Y</b> |                                       | 12                                     | 11.41                   | 2.63 | 2.13 | 0.94 | 5/16               | 2              |    |
| <b>PCSB250-14-1Y</b> |                                       | 14                                     | 13.29                   | 2.63 | 2.13 | 0.94 | 5/16               | 1              |    |

‡‡Not UL Listed or CSA Certified.





## Multi-Tap Connector with Clear Insulation, Double-Sided (continued)

| Part Number        | Conductor Size Range                   | No. of Ports           | Figure Dimensions (In.) |      |      |      | Hex Key Size (In.) | Std. Pkg. Qty. |
|--------------------|--|------------------------|-------------------------|------|------|------|--------------------|----------------|
|                    |  |                        | L                       | W    | H    | S    |                    |                |
| <b>PCSB350-2-4</b> | 350 kcmil – #10 AWG STR<br>#10 AWG SOL | 2                      | 2.17                    | 3.00 | 2.50 | 1.00 | 3/8                | 4              |
| PCSB350-3-4        |  | 3                      | 3.17                    | 3.00 | 2.50 | 1.00 | 3/8                | 4              |
| PCSB350-4-3        |  | 4                      | 4.17                    | 3.00 | 2.50 | 1.00 | 3/8                | 3              |
| PCSB350-5-3        |  | 5                      | 5.17                    | 3.00 | 2.50 | 1.00 | 3/8                | 3              |
| PCSB350-6-2        |  | 6                      | 6.17                    | 3.00 | 2.50 | 1.00 | 3/8                | 2              |
| PCSB350-8-2        |  | 8                      | 8.17                    | 3.00 | 2.50 | 1.00 | 3/8                | 2              |
| PCSB350-10-2Y      |  | 10                     | 10.17                   | 3.00 | 2.50 | 1.00 | 5/16               | 2              |
| PCSB350-12-1Y      |  | 12                     | 12.17                   | 3.00 | 2.50 | 1.00 | 5/16               | 1              |
| PCSB350-14-1Y      |  | 14                     | 14.17                   | 3.00 | 2.50 | 1.00 | 5/16               | 1              |
| PCSB600-2-4Y       |  | 600 kcmil – #6 AWG STR | 2                       | 2.72 | 3.00 | 2.75 | 1.28               | 3/8            |
| PCSB600-3-3Y       | 3                                      |                        | 4.00                    | 3.00 | 2.75 | 1.28 | 3/8                | 3              |
| PCSB600-4-2Y       | 4                                      |                        | 5.28                    | 3.00 | 2.75 | 1.28 | 3/8                | 2              |
| PCSB600-5-2        | 5                                      |                        | 6.56                    | 3.00 | 2.75 | 1.28 | 3/8                | 2              |
| PCSB600-6-2Y       | 6                                      |                        | 7.84                    | 3.00 | 2.75 | 1.28 | 3/8                | 2              |
| PCSB600-8-2Y       | 8                                      |                        | 10.41                   | 3.00 | 2.75 | 1.28 | 3/8                | 2              |
| PCSB600-10-1Y      | 10                                     |                        | 12.97                   | 3.00 | 2.75 | 1.28 | 3/8                | 1              |
| PCSB600-12-1Y      | 12                                     |                        | 15.53                   | 3.00 | 2.75 | 1.28 | 3/8                | 1              |
| PCSB600-14-1Y      | 14                                     |                        | 18.09                   | 3.00 | 2.75 | 1.28 | 3/8                | 1              |
| PCSB750-2-2Y‡‡     | 750 kcmil – #2 AWG STR                 |                        | 2                       | 2.88 | 3.38 | 3.00 | 1.38               | 3/8            |
| PCSB750-3-2Y‡‡     |  | 3                      | 4.25                    | 3.38 | 3.00 | 1.38 | 3/8                | 2              |
| PCSB750-4-2Y‡‡     |  | 4                      | 5.63                    | 3.38 | 3.00 | 1.38 | 3/8                | 2              |
| PCSB750-5-1Y‡‡     |  | 5                      | 7.00                    | 3.38 | 3.00 | 1.38 | 3/8                | 1              |
| PCSB750-6-1Y‡‡     |  | 6                      | 8.38                    | 3.38 | 3.00 | 1.38 | 3/8                | 1              |
| PCSB750-8-1Y‡‡     |  | 8                      | 11.13                   | 3.38 | 3.00 | 1.38 | 3/8                | 1              |
| PCSB750-10-1Y‡‡    |  | 10                     | 13.88                   | 3.38 | 3.00 | 1.38 | 3/8                | 1              |

‡‡Not UL Listed or CSA Certified.

A.  
System  
Overview

B1.  
Cable Ties

B2.  
Cable  
Accessories

B3.  
Stainless  
Steel Ties

C1.  
Wiring  
Duct

C2.  
Surface  
Raceway

C3.  
Abrasion  
Protection

C4.  
Cable  
Management

D1.  
Terminals

D2.  
Power  
Connectors

D3.  
Grounding  
Connectors

E1.  
Labeling  
Systems

E2.  
Labels

E3.  
Pre-Printed  
& Write-On  
Markers

E4.  
Permanent  
Identification

E5.  
Lockout/  
Tagout  
& Safety  
Solutions

F.  
Index

A. System Overview



## In-Line Splicer/Reducer with Clear Insulation

B1. Cable Ties

### For Use with Aluminum or Copper Code Conductors

#### Type PISR

- Flexible design – can be used as a splice or reducer
- Dual rated for use with copper or aluminum conductors
- Made from high strength, extruded aluminum alloy to provide premium electrical and mechanical performance
- Insulated with clear PVC to eliminate the need for taping and allow for visual inspection of the complete conductor insertion
- Each port pre-filled with oxide inhibiting joint compound seals out air and moisture to deter surface oxidation
- Wide wire range-taking capability minimizes inventory requirements
- Plated steel or aluminum set screw provides high strength, durable electrical contact between conductor and connector
- UL Listed and CSA Certified for use up to 600 V and UL temperature rated 90°C

B2. Cable Accessories

B3. Stainless Steel Ties

C1. Wiring Duct

C2. Surface Raceway

C3. Abrasion Protection

C4. Cable Management

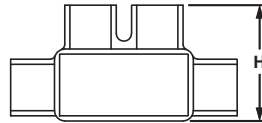
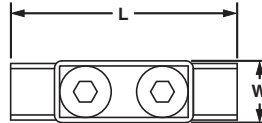

D1. Terminals

D2. Power Connectors

D3. Grounding Connectors

E1. Labeling Systems

E2. Labels

E3. Pre-Printed & Write-On Markers

E4. Permanent Identification

E5. Lockout/Tagout & Safety Solutions

F. Index

| Part Number      | Conductor Size Range                                   | Figure Dimensions (In.) |      |      | Std. Pkg. Qty. |
|------------------|--|-------------------------|------|------|----------------|
|                  |  | L                       | W    | H    |                |
| <b>PISR2-1</b>   | #2 AWG STR – #14 AWG STR,<br>#8 AWG SOL – #10 AWG SOL  | 2.38                    | 0.75 | 1.25 | 1              |
| <b>PISR1/0-1</b> | 1/0 AWG STR – #14 AWG STR,<br>#8 AWG SOL – #14 AWG SOL | 2.91                    | 0.95 | 1.41 | 1              |
| <b>PISR250-1</b> | 250 kcmil – #10 AWG STR,<br>#8 AWG SOL – #10 AWG SOL   | 4.00                    | 1.25 | 2.24 | 1              |
| <b>PISR350-1</b> | 350 kcmil – #10 AWG STR,<br>#8 AWG SOL – #10 AWG SOL   | 4.63                    | 1.40 | 2.34 | 1              |
| <b>PISR500-1</b> | 500 kcmil – #6 AWG STR                                 | 5.25                    | 1.72 | 2.63 | 1              |



## Multi-Tap Connector with Clear Insulation, Single-Sided, with Mounting Holes

For Use with Aluminum or Copper Code Conductors

### Type PCSBMT-S

- Flexible design – can be used as a tap, splice, or dead end connector
- Body made from high strength, extruded aluminum alloy to provide premium electrical and mechanical performance
- Two isolated mounting holes at either end of connector facilitate direct mounting using 1/4" bolts
- Insulated with clear PVC to eliminate the need for taping and allow for visual inspection of the complete conductor insertion
- Each port pre-filled with oxide inhibiting joint compound seals out air and moisture to deter surface oxidation
- Wide wire range-taking capability minimizes inventory requirements
- Plated steel or aluminum set screw provides high strength, durable electrical contact between conductor and connector
- UL Listed and CSA Certified for use up to 600 V and temperature rated 90°C

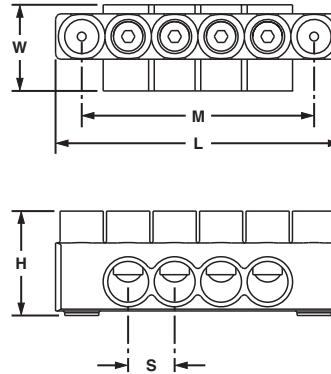

| Part Number     | Conductor Size Range                   | No. of Ports | Figure Dimensions (In.) |      |      |       | Mounting Hole Size (In.) | Hex Key Size (In.) | Std. Pkg. Qty. |   |
|-----------------|--|--------------|-------------------------|------|------|-------|--------------------------|--------------------|----------------|---|
|                 |  |              | L                       | W    | H    | S     |                          |                    |                | M |
| PCSBMT2/0-4S-3Y | 2/0 – #14 AWG STR<br>#10 – #14 AWG SOL | 4            | 4.20                    | 1.31 | 1.50 | 0.67  | 3.61                     | 1/4                | 3              |   |
| PCSBMT2/0-6S-2Y |  | 6            | 5.55                    | 1.31 | 1.50 | 0.67  | 4.96                     | 1/4                | 2              |   |
| PCSBMT2/0-8S-2Y |  | 8            | 6.89                    | 1.31 | 1.50 | 0.67  | 6.30                     | 1/4                | 2              |   |
| PCSBMT2/0-10S2Y |  | 10           | 8.24                    | 1.31 | 1.50 | 0.67  | 7.65                     | 1/4                | 2              |   |
| PCSBMT2/0-12S1Y |  | 12           | 9.58                    | 1.31 | 1.50 | 0.67  | 8.99                     | 1/4                | 1              |   |
| PCSBMT250-4S-2Y | 250 kcmil – #10 AWG STR                | 4            | 5.78                    | 2.00 | 2.25 | 0.94  | 4.94                     | 1/4                | 23/32          | 2 |
| PCSBMT250-6S-2Y |  | 6            | 7.66                    | 2.00 | 2.25 | 0.94  | 6.82                     | 1/4                | 23/32          | 2 |
| PCSBMT250-8S-2Y |  | 8            | 9.53                    | 2.00 | 2.25 | 0.94  | 8.69                     | 1/4                | 23/32          | 2 |
| PCSBMT250-10S2Y |  | 10           | 11.41                   | 2.00 | 2.25 | 0.94  | 10.57                    | 1/4                | 23/32          | 2 |
| PCSBMT250-12S1Y | 12                                     | 13.29        | 2.00                    | 2.25 | 0.94 | 12.45 | 1/4                      | 23/32              | 1              |   |
| PCSBMT350-4S-2Y | 350 kcmil – #10 AWG STR                | 4            | 6.17                    | 2.25 | 2.63 | 1.00  | 5.25                     | 1/4                | 7/8            | 2 |
| PCSBMT350-6S-2Y |  | 6            | 8.17                    | 2.25 | 2.63 | 1.00  | 7.25                     | 1/4                | 7/8            | 2 |
| PCSBMT350-8S-2Y |  | 8            | 10.17                   | 2.25 | 2.63 | 1.00  | 9.25                     | 1/4                | 7/8            | 2 |
| PCSBMT350-10S1Y |  | 10           | 12.17                   | 2.25 | 2.63 | 1.00  | 11.25                    | 1/4                | 7/8            | 1 |
| PCSBMT350-12S1Y | 12                                     | 14.17        | 2.25                    | 2.63 | 1.00 | 13.25 | 1/4                      | 7/8                | 1              |   |
| PCSBMT600-4S-2Y | 600 kcmil – #6 AWG STR                 | 4            | 7.84                    | 2.25 | 2.88 | 1.28  | 6.65                     | 1/4                | 15/16          | 2 |
| PCSBMT600-6S-2Y |  | 6            | 10.41                   | 2.25 | 2.88 | 1.28  | 9.22                     | 1/4                | 15/16          | 2 |
| PCSBMT600-8S-2Y |  | 8            | 12.97                   | 2.25 | 2.88 | 1.28  | 11.78                    | 1/4                | 15/16          | 2 |
| PCSBMT600-10S1Y |  | 10           | 15.53                   | 2.25 | 2.88 | 1.28  | 14.34                    | 1/4                | 15/16          | 1 |
| PCSBMT600-12S1Y | 12                                     | 18.09        | 2.25                    | 2.88 | 1.28 | 16.90 | 1/4                      | 15/16              | 1              |   |

A. System Overview

B1. Cable Ties

B2. Cable Accessories

B3. Stainless Steel Ties

C1. Wiring Duct

C2. Surface Raceway

C3. Abrasion Protection

C4. Cable Management

D1. Terminals

D2. Power Connectors

D3. Grounding Connectors

E1. Labeling Systems

E2. Labels

E3. Pre-Printed & Write-On Markers

E4. Permanent Identification

E5. Lockout/Tagout & Safety Solutions

F. Index

A. System Overview



## Multi-Tap Connector with Clear Insulation, Double-Sided, with Mounting Holes

B1. Cable Ties

**For Use with Aluminum or Copper Code Conductors**

### Type PCSBMT

B2. Cable Accessories

- Flexible design – can be used as a tap, splice, or dead end connector
- Body made from high strength, extruded aluminum alloy to provide premium electrical and mechanical performance
- Two isolated mounting holes at either end of connector facilitate direct mounting using 1/4" bolts
- Insulated with clear PVC to eliminate the need for taping and allow for visual inspection of the complete conductor insertion

B3. Stainless Steel Ties

- Each port pre-filled with oxide inhibiting joint compound seals out air and moisture to deter surface oxidation
- Wide wire range-taking capability minimizes inventory requirements
- Dual-sided entry allows offset and opposite entry for primary and secondary conductors
- Plated steel or aluminum set screw provides high strength, durable electrical contact between conductor and connector
- UL Listed and CSA Certified for use up to 600 V and temperature rated 90°C

C1. Wiring Duct

C2. Surface Raceway

C3. Abrasion Protection

C4. Cable Management

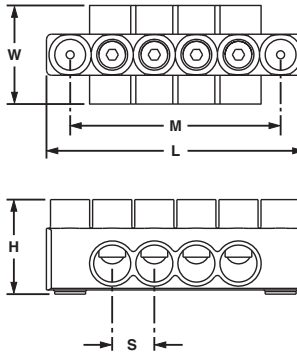

| Part Number     | Conductor Size Range                    | No. of Ports | Figure Dimensions (In.) |      |      |      |       | Mounting Hole Size (In.) | Hex Key Size (In.) | Std. Pkg. Qty. |
|-----------------|---|--------------|-------------------------|------|------|------|-------|--------------------------|--------------------|----------------|
|                 |   |              | L                       | W    | H    | S    | M     |                          |                    |                |
| PCSBMT2/0-4-3Y  | 2/0 – #14 AWG STR,<br>#10 – #14 AWG SOL | 4            | 4.20                    | 1.56 | 1.50 | 0.67 | 3.61  | 1/4                      | 1/2                | 3              |
| PCSBMT2/0-6-2Y  |   | 6            | 5.55                    | 1.56 | 1.50 | 0.67 | 4.96  | 1/4                      | 1/2                | 2              |
| PCSBMT2/0-8-2Y  |   | 8            | 6.89                    | 1.56 | 1.50 | 0.67 | 6.30  | 1/4                      | 1/2                | 2              |
| PCSBMT2/0-10-2Y |   | 10           | 8.24                    | 1.56 | 1.50 | 0.67 | 7.65  | 1/4                      | 1/2                | 2              |
| PCSBMT2/0-12-1Y |   | 12           | 9.58                    | 1.56 | 1.50 | 0.67 | 8.99  | 1/4                      | 1/2                | 1              |
| PCSBMT250-4-2Y  | 250 kcmil – #10 AWG STR                 | 4            | 5.78                    | 2.63 | 2.26 | 0.94 | 4.94  | 1/4                      | 23/32              | 2              |
| PCSBMT250-6-2Y  |   | 6            | 7.66                    | 2.63 | 2.26 | 0.94 | 6.82  | 1/4                      | 23/32              | 2              |
| PCSBMT250-8-2Y  |   | 8            | 9.53                    | 2.63 | 2.26 | 0.94 | 8.69  | 1/4                      | 23/32              | 2              |
| PCSBMT250-10-2Y |   | 10           | 11.41                   | 2.63 | 2.26 | 0.94 | 10.57 | 1/4                      | 23/32              | 2              |
| PCSBMT250-12-1Y |   | 12           | 13.29                   | 2.63 | 2.26 | 0.94 | 12.45 | 1/4                      | 23/32              | 1              |
| PCSBMT350-4-2Y  | 350 kcmil – #10 AWG STR                 | 4            | 6.17                    | 3.00 | 2.63 | 1.00 | 5.25  | 1/4                      | 7/8                | 2              |
| PCSBMT350-6-2Y  |   | 6            | 8.17                    | 3.00 | 2.63 | 1.00 | 7.25  | 1/4                      | 7/8                | 2              |
| PCSBMT350-8-2Y  |   | 8            | 10.17                   | 3.00 | 2.63 | 1.00 | 9.25  | 1/4                      | 7/8                | 2              |
| PCSBMT350-10-1Y |   | 10           | 12.17                   | 3.00 | 2.63 | 1.00 | 11.25 | 1/4                      | 7/8                | 1              |
| PCSBMT350-12-1Y |   | 12           | 14.17                   | 3.00 | 2.63 | 1.00 | 13.25 | 1/4                      | 7/8                | 1              |
| PCSBMT600-4-2Y  | 600 kcmil – #6 AWG STR                  | 4            | 7.84                    | 3.00 | 2.88 | 1.28 | 6.65  | 1/4                      | 15/16              | 2              |
| PCSBMT600-6-2Y  |   | 6            | 10.41                   | 3.00 | 2.88 | 1.28 | 9.22  | 1/4                      | 15/16              | 2              |
| PCSBMT600-8-2Y  |   | 8            | 12.97                   | 3.00 | 2.88 | 1.28 | 11.78 | 1/4                      | 15/16              | 2              |
| PCSBMT600-10-1Y |   | 10           | 15.53                   | 3.00 | 2.88 | 1.28 | 14.34 | 1/4                      | 15/16              | 1              |
| PCSBMT600-12-1Y |   | 12           | 18.09                   | 3.00 | 2.88 | 1.28 | 16.90 | 1/4                      | 15/16              | 1              |

D1. Terminals

D2. Power Connectors

D3. Grounding Connectors

E1. Labeling Systems

E2. Labels

E3. Pre-Printed & Write-On Markers

E4. Permanent Identification

E5. Lockout/Tagout & Safety Solutions

F. Index

## Belleville Compression Washers

### Type CW

- Conical spring washer for use when assembling aluminum connectors to copper and/or steel pads, compensates for differing rates of thermal expansion to keep hardware assembly from loosening

- For assembly information, see page D2.158
- Made from hardened steel to provide high strength
- Cadmium-plated to inhibit corrosion



| Part Number | Stud Hole Size (In.) | Figure Dimensions (In.) |      |      | Std. Pkg. Qty. |
|-------------|----------------------|-------------------------|------|------|----------------|
|             |                      | D                       | H    | T    |                |
| CW-14-L     | 1/4                  | 0.68                    | 0.09 | 0.05 | 50             |
| CW-56-L     | 5/16                 | 0.81                    | 0.08 | 0.06 | 50             |
| CW-38-L     | 3/8                  | 0.93                    | 0.10 | 0.07 | 50             |
| CW-12-Q     | 1/2                  | 1.18                    | 0.12 | 0.09 | 25             |
| CW-58-Q     | 5/8                  | 1.49                    | 0.15 | 0.12 | 25             |

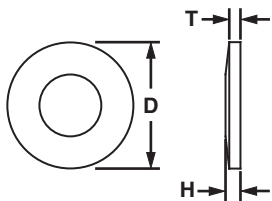

## Joint Compounds

### For Use with Aluminum Connectors

### Type CMP

- Oxide inhibitor for compression conductor connections lowers electrical resistance of compression joint while sealing out air and moisture to prevent the formation of surface oxides

- Wide operating temperature range; can be used in a wide range of electrical and environmental conditions
- Packaged in convenient dispenser bottles



| Part Number | Description  | Std. Pkg. Qty. |
|-------------|--|----------------|
| CMP-100-1   | Contact aid for pad-to-pad or thread-to-thread aluminum connections, 8 oz. Operating temperature range -60°F (-51°C) to 400°F (204°C). | 1              |

A. System Overview

B1. Cable Ties

B2. Cable Accessories

B3. Stainless Steel Ties

C1. Wiring Duct

C2. Surface Raceway

C3. Abrasion Protection

C4. Cable Management

D1. Terminals

D2. Power Connectors

D3. Grounding Connectors

E1. Labeling Systems

E2. Labels

E3. Pre-Printed & Write-On Markers

E4. Permanent Identification

E5. Lockout/Tagout & Safety Solutions

F. Index

A.  
System  
Overview

## Guidelines for Installing Aluminum Mechanical Connectors

B1.  
Cable Ties

B2.  
Cable  
Accessories

B3.  
Stainless  
Steel Ties



### 1. Select the correct connector for your application.

- Always use an aluminum conductor with an aluminum connector
- Verify that the connector is marked for the conductor size and type that you are using

C1.  
Wiring  
Duct

C2.  
Surface  
Raceway

C3.  
Abrasion  
Protection



### 2. Remove the insulation from insulated cable.

- See page D3.38 for Panduit cable stripping tools
- Use care to avoid nicking the conductor strands
- Strip the insulation to the proper length as listed in the installation instructions provided with Panduit connectors

C4.  
Cable  
Management

D1.  
Terminals

D2.  
Power  
Connectors



### 3. Clean the exposed conductor using a wire brush or an emery cloth.

- In a similar manner, clean an unplated connector pad and the surface to which the connector will be attached
- Solvent should be used to clean plated parts that are dirty, but the plating should never be disturbed with abrasives

D3.  
Grounding  
Connectors

E1.  
Labeling  
Systems

E2.  
Labels



### 4. Apply Panduit joint compound to the clean conductor for mechanical connector applications (see page D2.155).

- Joint compound will deter the formation of surface oxides after installation
- Aluminum compression connectors and insulated mechanical connectors are pre-filled with joint compound

E3.  
Pre-Printed  
& Write-On  
Markers

E4.  
Permanent  
Identification

E5.  
Lockout/  
Tagout/  
& Safety  
Solutions

F.  
Index



### 5. Insert the conductor into the connector and:

- For mechanical connectors, tighten the screws to the recommended torque values
- For compression connectors, use the recommended die and crimping tool to make the proper compression connection



## Panduit Power Connector Approvals



| Logo (Symbol) | Agency                            | Spec/Approval   | Applicable Products  |
|---------------|-----------------------------------|---|--|
|               | Underwriters Laboratories, Inc.   | UL 486A-486B<br>Wire Connectors and<br>Soldering Lugs<br>for use in US and Canada | As shown on product pages.   |
|               | Underwriters Laboratories, Inc.   | UL 486A-486B<br>Wire Connectors and<br>Soldering Lugs<br>for use in US            | As shown on product pages.   |
|               | Underwriters Laboratories, Inc.   | UL 486A-486B<br>Wire Connectors and<br>Soldering Lugs<br>for use in US            | As shown on product pages.   |
|               | Canadian Standards<br>Association | C22.2 No. 65-03<br>Wire Connectors  | As shown on product pages.   |
|               | American Bureau<br>of Shipping    | ABS Rules<br>Steel Vessel Rules<br>1-1-4/7.7, 4-8-3/9.19,<br>4-8-4/21.27          | Copper compression connectors<br>LCA, LCAF, LCAS, LCAX, LCB, LCC, LCD, S-R,<br>LCDX, SCS, SCSF |
|               | Telcordia Technologies, Inc.      | Network Equipment –<br>Building Systems   | Copper compression connectors<br>LCAS, LCA, LCD, LCB, LCC, LCAF, LCCF, SCSS,<br>SCS, SCL, SCSF |

A.  
System  
Overview

B1.  
Cable Ties

B2.  
Cable  
Accessories

B3.  
Stainless  
Steel Ties

C1.  
Wiring  
Duct

C2.  
Surface  
Raceway

C3.  
Abrasion  
Protection

C4.  
Cable  
Management

D1.  
Terminals

D2.  
Power  
Connectors

D3.  
Grounding  
Connectors

E1.  
Labeling  
Systems

E2.  
Labels

E3.  
Pre-Printed  
& Write-On  
Markers

E4.  
Permanent  
Identification

E5.  
Lockout/  
Tagout  
& Safety  
Solutions

F.  
Index

A. System Overview

B1. Cable Ties

B2. Cable Accessories

B3. Stainless Steel Ties

C1. Wiring Duct

C2. Surface Raceway

C3. Abrasion Protection

C4. Cable Management

D1. Terminals

D2. Power Connectors

D3. Grounding Connectors

E1. Labeling Systems

E2. Labels

E3. Pre-Printed & Write-On Markers

E4. Permanent Identification

E5. Lockout/Tagout & Safety Solutions

F. Index

## Recommended Termination Hardware

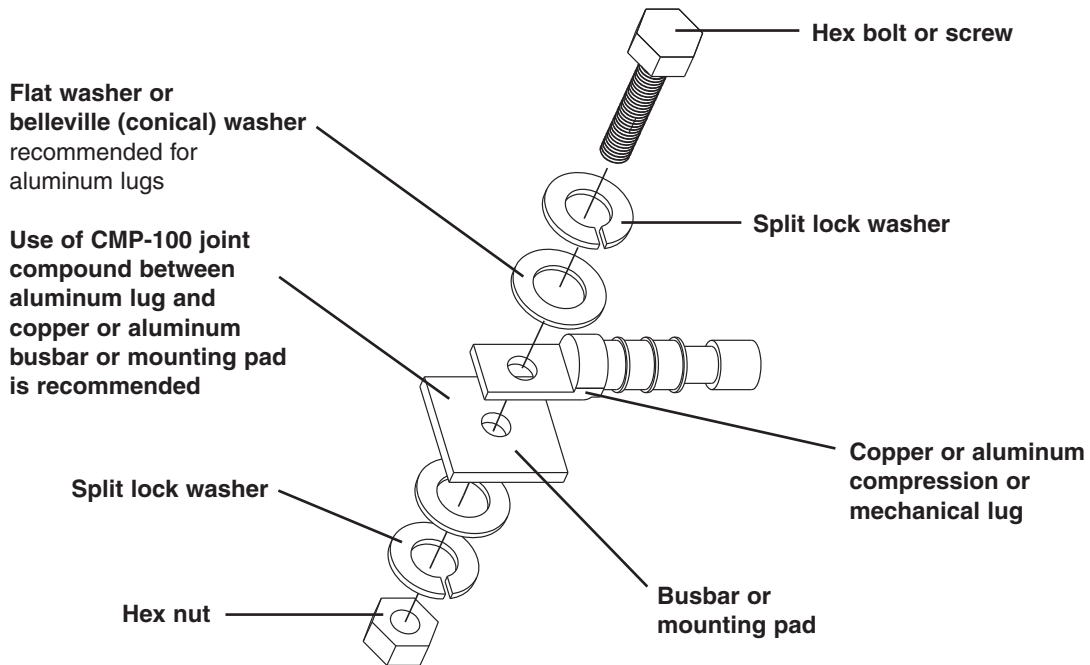
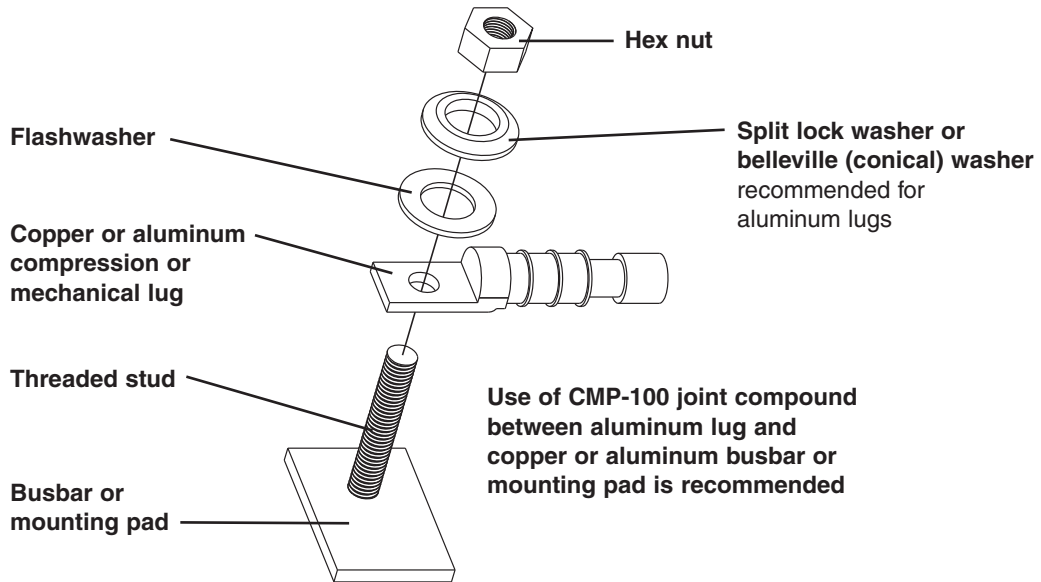

## Recommended Hardware Material

Material Configuration of Lug/Mounting Surface

| Copper to Copper                        | Aluminum to Copper                                     | Aluminum to Aluminum  | Copper to Steel                         | Aluminum to Steel                 |
|---|--|---|---|-----------------------------------|
| 1. Silicon bronze<br>2. Stainless steel | 1. Silicon bronze<br>2. Aluminum<br>3. Stainless steel | 1. Aluminum<br>2. Stainless steel<br>3. Plated silicon bronze | 1. Silicon bronze<br>2. Stainless steel | 1. Aluminum<br>2. Stainless steel |

## Conductor Sizes

### Copper Concentric Stranded Conductor Sizes

| Conductor Size<br>AWG or kcmil | Number of<br>Strands | Nominal<br>Diameter (In.) | Class |
|--------------------------------|----------------------|---------------------------|-------|
| #20                            | 7                    | .036 /3                   | B     |
| #18                            | 7                    | .045 /6                   | B     |
| #16                            | 7                    | .057 /6                   | B     |
| #14                            | 7                    | .072 /6                   | B     |
| #12                            | 7                    | .091 /5                   | B     |
| #10                            | 7                    | .116                      | B     |
| #9                             | 7                    | .130                      | B     |
| #8                             | 7                    | .146                      | B     |
| #7                             | 7                    | .164                      | B     |
| #6                             | 7                    | .184                      | B     |
| #5                             | 7                    | .206                      | B     |
| #4                             | 3                    | .254                      | AA    |
| #4                             | 7                    | .232                      | B&A   |
| #3                             | 3                    | .285                      | AA    |
| #3                             | 7                    | .260                      | B&A   |
| #2                             | 3                    | .320                      | AA    |
| #2                             | 7                    | .292                      | B&A   |
| #1                             | 3                    | .360                      | AA    |
| #1                             | 7                    | .328                      | AA    |
| #1                             | 19                   | .332                      | B     |
| 1/0                            | 7                    | .368                      | A&A   |
| 1/0                            | 12                   | .390                      | —     |
| 1/0                            | 19                   | .373                      | B     |
| 2/0                            | 7                    | .414                      | A&A   |
| 2/0                            | 12                   | .438                      | —     |
| 2/0                            | 19                   | .419                      | B     |
| 3/0                            | 7                    | .464                      | A&A   |
| 3/0                            | 12                   | .492                      | —     |
| 3/0                            | 19                   | .470                      | B     |
| 4/0                            | 7                    | .522                      | A&A   |
| 4/0                            | 12                   | .522                      | —     |
| 4/0                            | 19                   | .528                      | B     |
| 250                            | 12                   | .600                      | AA    |
| 250                            | 19                   | .574                      | A     |
| 250                            | 37                   | .575                      | B     |
| 300                            | 12                   | .657                      | AA    |
| 300                            | 19                   | .628                      | A     |
| 300                            | 37                   | .630                      | B     |
| 350                            | 12                   | .710                      | AA    |
| 350                            | 19                   | .679                      | A     |
| 350                            | 37                   | .681                      | B     |
| 400                            | 19                   | .726                      | A&AA  |
| 400                            | 37                   | .728                      | B     |
| 450                            | 19                   | .770                      | AA    |
| 450                            | 37                   | .772                      | B&A   |
| 500                            | 19                   | .811                      | AA    |
| 500                            | 37                   | .813                      | B&A   |
| 600                            | 37                   | .891                      | A&AA  |
| 600                            | 61                   | .893                      | B     |
| 700                            | 37                   | .963                      | BB    |
| 700                            | 61                   | .964                      | B&A   |
| 750                            | 37                   | .977                      | AA    |
| 750                            | 61                   | .998                      | B&A   |
| 800                            | 37                   | 1.029                     | AA    |
| 800                            | 61                   | 1.031                     | B&A   |
| 900                            | 37                   | 1.092                     | AA    |
| 900                            | 61                   | 1.094                     | B&A   |
| 1000                           | 37                   | 1.151                     | AA    |
| 1000                           | 61                   | 1.152                     | B&A   |
| 1000                           | 61                   | 1.152                     | B&A   |

### Flexible Copper Conductor Sizes

| Conductor Size<br>AWG or kcmil | Number of<br>Strands | Nominal<br>Diameter (In.) | Class            |
|--------------------------------|----------------------|---------------------------|------------------|
| #8                             | 41/.0201             | .156                      | I                |
| #8                             | 49/.0184             | .166                      | G                |
| #8                             | 133/.0111            | .167                      | H                |
| #8                             | 168/.010             | .157                      | K                |
| #8                             | 37                   | .330                      | Locomotive (DLO) |
| #8                             | 420/.0063            | .162                      | M                |
| #7                             | 49/.0206             | .185                      | G                |
| #7                             | 52/.0201             | .185                      | I                |
| #7                             | 133/.0125            | .188                      | H                |
| #7                             | 210/.010             | .179                      | K                |
| #7                             | —                    | —                         | Locomotive (DLO) |
| #7                             | 532/.0063            | .196                      | M                |
| #6                             | 49/.0231             | .208                      | G                |
| #6                             | 63/.0201             | .207                      | I                |
| #6                             | 133/.0140            | .210                      | H                |
| #6                             | 266/.010             | .210                      | K                |
| #6                             | 61                   | .410                      | Locomotive (DLO) |
| #6                             | 665/.0063            | .215                      | M                |
| #5                             | 49/.0260             | .234                      | G                |
| #5                             | 84/.0201             | .235                      | I                |
| #5                             | 133/.0158            | .237                      | H                |
| #5                             | 336/.010             | .235                      | K                |
| #5                             | —                    | —                         | Locomotive (DLO) |
| #5                             | 836/.0063            | .240                      | M                |
| #4                             | 49/.0292             | .263                      | G                |
| #4                             | 105/.0201            | .263                      | I                |
| #4                             | 133/.0177            | .266                      | H                |
| #4                             | 420/.010             | .272                      | K                |
| #4                             | 105                  | .460                      | Locomotive (DLO) |
| #4                             | 1064/.0063           | .269                      | M                |
| #3                             | 49/.0328             | .295                      | G                |
| #3                             | 133/.0199            | .299                      | H                |
| #3                             | 133/.0201            | .291                      | I                |
| #3                             | 532/.010             | .304                      | K                |
| #3                             | 125                  | .480                      | Locomotive (DLO) |
| #3                             | 1323/.0063           | .305                      | M                |
| #2                             | 49/.0368             | .331                      | G                |
| #2                             | 133/.0223            | .335                      | H                |
| #2                             | 161/.0201            | .319                      | I                |
| #2                             | 665/.010             | .338                      | K                |
| #2                             | 150                  | .510                      | Locomotive (DLO) |
| #2                             | 1666/.0063           | .337                      | M                |
| #1                             | 133/.0251            | .337                      | G                |
| #1                             | 210/.0201            | .367                      | I                |
| #1                             | 259/.018             | .378                      | H                |
| #1                             | 836/.010             | .397                      | K                |
| #1                             | 225                  | .650                      | Locomotive (DLO) |
| #1                             | 2107/.0063           | .376                      | M                |
| 1/0                            | 133/.0282            | .423                      | G                |
| 1/0                            | 259/.0202            | .424                      | H                |
| 1/0                            | 266/.0201            | .441                      | I                |
| 1/0                            | 1064/.010            | .451                      | K                |
| 1/0                            | 275                  | .680                      | Locomotive (DLO) |
| 1/0                            | 2646/.0063           | .423                      | M                |
| 2/0                            | 133/.0316            | .474                      | G                |
| 2/0                            | 259/.0227            | .477                      | H                |
| 2/0                            | 342/.0201            | .500                      | I                |
| 2/0                            | 1323/.010            | .470                      | K                |
| 2/0                            | 325                  | .720                      | Locomotive (DLO) |
| 2/0                            | 3325/.0063           | .508                      | M                |

Table continues on page D2.160

A.  
System  
Overview

B1.  
Cable  
Ties

B2.  
Cable  
Accessories

B3.  
Stainless  
Steel Ties

C1.  
Wiring  
Duct

C2.  
Surface  
Raceway

C3.  
Abrasion  
Protection

C4.  
Cable  
Management

D1.  
Terminals

D2.  
Power  
Connectors

D3.  
Grounding  
Connectors

E1.  
Labeling  
Systems

E2.  
Labels

E3.  
Pre-Printed  
& Write-On  
Markers

E4.  
Permanent  
Identification

E5.  
Lockout/  
Tagout  
& Safety  
Solutions

F.  
Index

A.  
System  
Overview

## Conductor Sizes (continued)

B1.  
Cable Ties

### Flexible Copper Conductor Sizes

| Conductor Size<br>AWG or kcmil | No. of Strands/<br>Strand Dia. | Nominal<br>Diameter (In.) | Class            |
|--------------------------------|--------------------------------|---------------------------|------------------|
| 3/0                            | 133/.0355                      | .533                      | G                |
| 3/0                            | 259/.0255                      | .536                      | H                |
| 3/0                            | 418/.0201                      | .549                      | I                |
| 3/0                            | 1666/.010                      | .533                      | K                |
| 3/0                            | 450                            | .810                      | Locomotive (DLO) |
| 3/0                            | 4256/.0063                     | .576                      | M                |
| 4/0                            | 133/.0399                      | .599                      | G                |
| 4/0                            | 259/.0286                      | .601                      | H                |
| 4/0                            | 532/.0201                      | .613                      | I                |
| 4/0                            | 2107/.010                      | .627                      | K                |
| 4/0                            | 550                            | .840                      | Locomotive (DLO) |
| 4/0                            | 5320/.0063                     | .645                      | M                |
| 250                            | 259/.0311                      | .650                      | G                |
| 250                            | 427/.0242                      | .653                      | H                |
| 250                            | 637/.0201                      | .682                      | I                |
| 250                            | 2499/.010                      | .682                      | K                |
| 262.6                          | 650                            | .960                      | Locomotive (DLO) |
| 250                            | 6384/.0063                     | .713                      | M                |
| 300                            | 259/.0340                      | .714                      | G                |
| 300                            | 427/.0265                      | .716                      | H                |
| 300                            | 735/.0201                      | .737                      | I                |
| 300                            | 2989/.010                      | .768                      | K                |
| 313.1                          | 775                            | 1.040                     | Locomotive (DLO) |
| 300                            | 7581/.0063                     | .768                      | M                |
| 350                            | 259/.0368                      | .773                      | G                |
| 350                            | 427/.0268                      | .772                      | H                |
| 350                            | 882/.0201                      | .800                      | I                |
| 350                            | 3458/.010                      | .809                      | K                |
| 373.7                          | 925                            | 1.140                     | Locomotive (DLO) |
| 350                            | 8806/.0063                     | .825                      | M                |
| 400                            | 259/.0393                      | .825                      | G                |
| 400                            | 427/.0306                      | .826                      | H                |
| 400                            | 980/.0201                      | .831                      | I                |
| 400                            | 3990/.010                      | .878                      | K                |
| 400                            | —                              | —                         | Locomotive (DLO) |
| 400                            | 10101/.0063                    | .901                      | M                |
| 450                            | 259/.0417                      | .876                      | G                |
| 450                            | 427/.325                       | .878                      | H                |
| 450                            | 1127/.0201                     | .894                      | I                |
| 450                            | 4522/.010                      | .933                      | K                |
| 444.4                          | 1100                           | 1.230                     | Locomotive (DLO) |
| 450                            | 11396/.0063                    | .940                      | M                |
| 500                            | 259/.0439                      | .922                      | G                |
| 500                            | 427/.0342                      | .923                      | H                |
| 500                            | 1125/.0201                     | .941                      | I                |
| 500                            | 5054/.010                      | .988                      | K                |
| 535.3                          | 1325                           | 1.320                     | Locomotive (DLO) |
| 500                            | 12691/.0063                    | .997                      | M                |
| 600                            | 427/.0375                      | 1.013                     | G                |
| 600                            | 703/.0292                      | 1.022                     | H                |
| 600                            | 1470/.0201                     | 1.027                     | I                |
| 600                            | 5985/.010                      | 1.125                     | K                |
| 646.4                          | 1600                           | 1.450                     | Locomotive (DLO) |
| 600                            | 14945/.0063                    | 1.084                     | M                |
| 700                            | 427/.0405                      | 1.094                     | G                |
| 700                            | 703/.0316                      | 1.106                     | H                |
| 700                            | 1729/.0201                     | 1.194                     | I                |
| 700                            | 6916/.010                      | 1.207                     | K                |
| 777.7                          | 1925                           | 1.540                     | Locomotive (DLO) |
| 700                            | 17507/.0063                    | 1.183                     | M                |

F.  
Index

### Flexible Copper Conductor Sizes

| Conductor Size<br>AWG or kcmil | No. of Strands/<br>Strand Dia. | Nominal<br>Diameter (In.) | Class            |
|--------------------------------|--------------------------------|---------------------------|------------------|
| 800                            | 427/.0433                      | 1.169                     | G                |
| 800                            | 703/.0337                      | 1.180                     | H                |
| 800                            | 1995/.0201                     | 1.290                     | I                |
| 800                            | 7980/.010                      | 1.305                     | K                |
| 800                            | —                              | —                         | Locomotive (DLO) |
| 800                            | 20069/.0063                    | 1.256                     | M                |
| 900                            | 427/.0459                      | 1.239                     | G                |
| 900                            | 703/.0358                      | 1.253                     | H                |
| 900                            | 2261/.0201                     | 1.372                     | I                |
| 900                            | 9065/.010                      | 1.323                     | K                |
| 900                            | —                              | —                         | Locomotive (DLO) |
| 900                            | 22631/.0063                    | 1.331                     | M                |
| 1000                           | 427/.0484                      | 1.307                     | G                |
| 1000                           | 703/.0377                      | 1.320                     | H                |
| 1000                           | 2527/.0201                     | 1.427                     | I                |
| 1000                           | 10101/.010                     | 1.419                     | K                |
| 1000                           | —                              | —                         | Locomotive (DLO) |
| 1000                           | 25193/.0063                    | 1.404                     | M                |

### Copper Compact Stranded Conductor Sizes

| Conductor Size<br>AWG or kcmil | Number of<br>Strands | Conductor<br>Diameter (In.) | Class   |
|--------------------------------|----------------------|-----------------------------|---------|
| #8                             | 7                    | .134                        | Compact |
| #6                             | 7                    | .169                        | Compact |
| #4                             | 7                    | .213                        | Compact |
| #2                             | 7                    | .268                        | Compact |
| #1                             | 19                   | .299                        | Compact |
| 1/0                            | 19                   | .336                        | Compact |
| 1/0                            | 19                   | .376                        | Compact |
| 3/0                            | 19                   | .423                        | Compact |
| 4/0                            | 19                   | .475                        | Compact |
| 250                            | 37                   | .520                        | Compact |
| 300                            | 37                   | .570                        | Compact |
| 350                            | 37                   | .616                        | Compact |
| 400                            | 37                   | .659                        | Compact |
| 450                            | 37                   | .700                        | Compact |
| 500                            | 37                   | .736                        | Compact |
| 550                            | 61                   | .775                        | Compact |
| 600                            | 61                   | .813                        | Compact |
| 650                            | 61                   | .845                        | Compact |
| 700                            | 61                   | .877                        | Compact |
| 750                            | 61                   | .908                        | Compact |
| 800                            | 61                   | .938                        | Compact |
| 900                            | 61                   | .999                        | Compact |
| 1000                           | 61                   | 1.060                       | Compact |

## Conductor Sizes (continued)

### Copper Solid Conductor Sizes

| Solid Copper Conductor Size AWG or kcmil | Conductor Diameter (In.) |
|--|--------------------------|
| #18                                      | .040                     |
| #17                                      | .045                     |
| #16                                      | .050                     |
| #15                                      | .057                     |
| #14                                      | .064                     |
| #13                                      | .071                     |
| #12                                      | .080                     |
| #11                                      | .090                     |
| #10                                      | .101                     |
| #9                                       | .114                     |
| #8                                       | .128                     |
| #7                                       | .128                     |
| #6                                       | .162                     |
| #5                                       | .181                     |
| #4                                       | .204                     |
| #3                                       | .229                     |
| #2                                       | .257                     |
| #1                                       | .289                     |
| 1/0                                      | .324                     |
| 2/0                                      | .364                     |
| 3/0                                      | .409                     |
| 4/0                                      | .460                     |

### Aluminum Concentric Stranded Conductor Sizes

| Class B Aluminum Concentric AWG or kcmil | Number of Strands | Diameter of each Strand (Mils) |
|--|-------------------|--------------------------------|
| #8                                       | 7                 | 48.6                           |
| #7                                       | 7                 | 54.5                           |
| #6                                       | 7                 | 61.2                           |
| #5                                       | 7                 | 68.8                           |
| #4                                       | 7                 | 77.2                           |
| #3                                       | 7                 | 86.7                           |
| #2                                       | 7                 | 97.4                           |
| #1                                       | 19                | 66.4                           |
| 1/0                                      | 19                | 74.5                           |
| 2/0                                      | 19                | 83.7                           |
| 3/0                                      | 19                | 94.0                           |
| 4/0                                      | 19                | 105.5                          |
| 250                                      | 37                | 82.2                           |
| 300                                      | 37                | 90.0                           |
| 350                                      | 37                | 97.3                           |
| 400                                      | 37                | 104.0                          |
| 450                                      | 37                | 110.3                          |
| 500                                      | 37                | 116.2                          |
| 550                                      | 61                | 95.0                           |
| 600                                      | 61                | 99.2                           |
| 650                                      | 61                | 103.2                          |
| 700                                      | 61                | 107.1                          |
| 750                                      | 61                | 110.9                          |
| 800                                      | 61                | 114.5                          |
| 900                                      | 61                | 121.5                          |
| 1000                                     | 61                | 128.0                          |

### Aluminum Compact Stranded Conductor Sizes

| Compact Aluminum AWG or kcmil | Class ASTM B400 | Number of Strands | Conductor Diameter (In.) |
|-------------------------------|-----------------|-------------------|--------------------------|
| #8                            | A, B            | 7                 | .134                     |
| #6                            | A, B            | 7                 | .169                     |
| #4                            | A, B            | 7                 | .213                     |
| #3                            | A, B            | 7                 | .238                     |
| #2                            | AA, A, B        | 7                 | .268                     |
| #1                            | AA, A           | 7                 | .299                     |
| #1                            | B               | 19                | .299                     |
| 1/0                           | AA, A           | 7                 | .336                     |
| 1/0                           | B               | 19                | .336                     |
| 2/0                           | AA, A           | 7                 | .376                     |
| 2/0                           | B               | 19                | .376                     |
| 3/0                           | AA, A           | 7                 | .423                     |
| 3/0                           | B               | 19                | .423                     |
| 4/0                           | AA, A           | 7                 | .475                     |
| 4/0                           | B               | 19                | .475                     |
| 250                           | AA              | 7                 | .520                     |
| 250                           | A               | 19                | .520                     |
| 250                           | B               | 37                | .520                     |
| 266                           | AA              | 7                 | .337                     |
| 266                           | A               | 19                | .337                     |
| 300                           | AA              | 7                 | .570                     |
| 300                           | A               | 19                | .570                     |
| 300                           | B               | 37                | .570                     |
| 336                           | AA              | 7                 | .603                     |
| 336                           | A               | 19                | .603                     |
| 350                           | A               | 19                | .616                     |
| 350                           | B               | 37                | .616                     |
| 397                           | AA, A           | 19                | .659                     |
| 400                           | B               | 37                | .659                     |
| 450                           | B               | 37                | .700                     |
| 477                           | AA              | 19                | .722                     |
| 500                           | AA              | 19                | .736                     |
| 500                           | B               | 37                | .736                     |
| 550                           | B               | 61                | .775                     |
| 556                           | AA              | 19                | .780                     |
| 600                           | B               | 61                | .813                     |
| 650                           | B               | 61                | .845                     |
| 700                           | B               | 61                | .877                     |
| 750                           | B               | 61                | .908                     |
| 800                           | B               | 61                | .938                     |
| 900                           | B               | 61                | .999                     |
| 1000                          | B               | 61                | 1.060                    |

A.  
System  
Overview

B1.  
Cable Ties

B2.  
Cable  
Accessories

B3.  
Stainless  
Steel Ties

C1.  
Wiring  
Duct

C2.  
Surface  
Raceway

C3.  
Abrasion  
Protection

C4.  
Cable  
Management

D1.  
Terminals

D2.  
Power  
Connectors

D3.  
Grounding  
Connectors

E1.  
Labeling  
Systems

E2.  
Labels

E3.  
Pre-Printed  
& Write-On  
Markers

E4.  
Permanent  
Identification

E5.  
Lockout/  
Tagout  
& Safety  
Solutions

F.  
Index

A. System Overview

## Common Conductor Sizes and Strandings Reference Chart

| Conductor                          | Individual Strands     |     |          | Overall Conductor Size |      |       | Conductor  | Individual Strands |                        |          | Overall Conductor Size |      |      |      |            |
|------------------------------------|------------------------|-----|----------|------------------------|------|-------|------------|--------------------|------------------------|----------|------------------------|------|------|------|------------|
|                                    | Diameter               |     | Diameter | Diameter               |      | Area  |            | Diameter           |                        | Diameter | Diameter               |      | Area |      |            |
| AWG                                | Metric mm <sup>2</sup> | No. | mm       | In.                    | mm   | In.   | Circ. MILS | AWG                | Metric mm <sup>2</sup> | No.      | mm                     | In.  | mm   | In.  | Circ. MILS |
|                                    | .05                    | 25  | .05      | .002                   | .25  | .010  | 97         |                    |                        | 19       | 0.25                   | .010 | 1.30 | .051 | 1841       |
|                                    | .06                    | 41  | .05      | .002                   | .36  | .014  | 159        |                    |                        | 1        | 1.13                   | .044 | 1.13 | .044 | 1979       |
| 26                                 |                        | 10  | .13      | .005                   | .53  | .021  | 250        |                    | 1.0                    | 32       | .20                    | .008 | 1.30 | .051 | 1984       |
|                                    |                        | 1   | .41      | .016                   | .41  | .016  | 256        |                    |                        | 7        | .43                    | .017 | 1.30 | .051 | 2006       |
|                                    |                        | 7   | .16      | .006                   | .48  | .019  | 278        |                    |                        | 19       | .29                    | .011 | 1.47 | .058 | 2426       |
|                                    |                        | 19  | .10      | .004                   | .51  | .020  | 304        |                    |                        | 65       | .16                    | .006 | 1.50 | .059 | 2580       |
| 24                                 |                        | 41  | .08      | .003                   | .58  | .023  | 384        | 16                 |                        | *26      | .25                    | .010 | 1.50 | .059 | 2600       |
|                                    |                        | 10  | .16      | .006                   | .58  | .023  | 397        |                    |                        | 1        | 1.30                   | .051 | 1.30 | .051 | 2601       |
|                                    |                        | 1   | .51      | .020                   | .51  | .020  | 400        |                    |                        | 105      | .13                    | .005 | 1.50 | .059 | 2625       |
|                                    |                        | 7   | .20      | .008                   | .61  | .024  | 448        |                    |                        | *7       | .51                    | .020 | 1.52 | .060 | 2828       |
| 22                                 |                        | 19  | .13      | .005                   | .61  | .024  | 475        |                    | 1.5                    | 30       | .25                    | .010 | 1.70 | .067 | 2906       |
|                                    |                        | 65  | .07      | .003                   | .65  | .026  | 484        |                    |                        | 21       | .30                    | .012 | 1.60 | .063 | 2930       |
|                                    |                        | 128 | .05      | .002                   | .65  | .026  | 496        |                    |                        | 189      | .10                    | .004 | 1.90 | .075 | 2930       |
|                                    |                        | 32  | .10      | .004                   | .65  | .026  | 496        |                    |                        | 7        | .52                    | .020 | 1.60 | .063 | 2934       |
| 20                                 |                        | 14  | .16      | .006                   | .65  | .026  | 556        |                    |                        | 1        | 1.38                   | .054 | 1.38 | .054 | 2952       |
|                                    |                        | 1   | .64      | .025                   | .64  | .025  | 625        |                    |                        | 45       | .16                    | .006 | 1.85 | .073 | 3786       |
|                                    |                        | 16  | .16      | .006                   | .76  | .030  | 635        |                    |                        | 19       | .38                    | .014 | 1.85 | .073 | 3831       |
|                                    |                        | 26  | .13      | .005                   | .76  | .030  | 650        |                    |                        | 1        | 1.63                   | .064 | 1.63 | .064 | 4096       |
| 18                                 |                        | 7   | .25      | .010                   | .76  | .030  | 700        | 14                 |                        | *41      | .25                    | .010 | 1.85 | .073 | 4100       |
|                                    |                        | 19  | .16      | .006                   | .79  | .031  | 754        |                    |                        | *7       | .64                    | .025 | 1.85 | .073 | 4481       |
|                                    |                        | 48  | .10      | .004                   | .80  | .031  | 744        |                    |                        | 50       | .25                    | .010 | 2.20 | .087 | 4844       |
|                                    |                        | 194 | .05      | .002                   | .80  | .031  | 752        |                    |                        | 7        | .67                    | .026 | 2.10 | .083 | 4871       |
| D1. Terminals                      | 0.38                   | 100 | .07      | .003                   | .80  | .031  | 760        | 2.5                |                        | 35       | .30                    | .012 | 2.20 | .087 | 4883       |
|                                    |                        | 7   | .27      | .011                   | .80  | .031  | 791        |                    |                        | 315      | .10                    | .004 | 2.20 | .087 | 4883       |
|                                    |                        | 12  | .21      | .008                   | .80  | .031  | 820        |                    |                        | 1        | 1.78                   | .070 | 1.78 | .070 | 4911       |
|                                    |                        | 21  | .16      | .006                   | .80  | .031  | 833        |                    |                        | 19       | .45                    | .018 | 2.36 | .093 | 6088       |
| D2. Power Connectors               | .5                     | 7   | .30      | .012                   | .90  | .035  | 977        | 12                 |                        | *65      | .25                    | .010 | 2.41 | .095 | 6500       |
|                                    |                        | 16  | .20      | .008                   | .90  | .035  | 992        |                    |                        | 165      | .16                    | .006 | 2.41 | .095 | 6549       |
|                                    |                        | 1   | .80      | .031                   | .80  | .031  | 992        |                    |                        | 1        | 2.06                   | .081 | 2.06 | .081 | 6561       |
|                                    |                        | *10 | .25      | .010                   | .89  | .035  | 1000       |                    |                        | *7       | .81                    | .032 | 2.44 | .096 | 7168       |
| D3. Grounding Connectors           | 20                     | 1   | .81      | .032                   | .81  | .032  | 1024       | 4.0                |                        | 56       | .30                    | .012 | 3.10 | .122 | 7812       |
|                                    |                        | 41  | .13      | .005                   | .91  | .036  | 1025       |                    |                        | 1        | 2.26                   | .089 | 2.26 | .089 | 7917       |
|                                    |                        | 26  | .16      | .006                   | .91  | .036  | 1032       |                    |                        | 511      | .10                    | .004 | 3.00 | .118 | 7921       |
|                                    |                        | *7  | .32      | .013                   | .97  | .038  | 1111       |                    |                        | 19       | .52                    | .020 | 2.70 | .106 | 7963       |
| E1. Labeling Systems               |                        | 19  | .20      | .008                   | .94  | .037  | 1216       | 10                 |                        | 37       | .40                    | .016 | 2.92 | .115 | 9354       |
|                                    |                        | 7   | .37      | .015                   | 1.10 | .043  | 1485       |                    |                        | 49       | .36                    | .014 | 2.95 | .116 | 9880       |
|                                    |                        | 24  | .20      | .008                   | 1.20 | .047  | 1488       |                    |                        | *7       | .98                    | .039 | 2.95 | .116 | 10376      |
|                                    |                        | 1   | 1.00     | .039                   | 1.00 | .039  | 1550       |                    |                        | 1        | 2.59                   | .102 | 2.59 | .102 | 10404      |
| E2. Labels                         | .75                    | *16 | .25      | .010                   | 1.19 | 0.047 | 1600       |                    |                        | *105     | .25                    | .010 | 2.95 | .116 | 10500      |
|                                    |                        | 1   | 1.02     | .040                   | 1.02 | .040  | 1600       |                    |                        | 84       | .30                    | .012 | 3.50 | .138 | 11718      |
|                                    |                        | 65  | .13      | .005                   | 1.19 | .047  | 1625       |                    |                        | 756      | .10                    | .004 | 3.70 | .146 | 11718      |
|                                    |                        | 41  | .16      | .006                   | 1.19 | .047  | 1627       |                    |                        | 1        | 2.76                   | .109 | 2.76 | .109 | 11807      |
| E3. Pre-Printed & Write-On Markers | 18                     | *7  | .40      | .016                   | 1.22 | .048  | 1770       | 6.0                |                        | 7        | 1.05                   | .041 | 3.20 | .126 | 11962      |
|                                    |                        | 19  | .25      | .010                   | 1.24 | .049  | 1900       |                    |                        | 19       | .64                    | .025 | 3.30 | .130 | 12063      |

\*Strandings required for UL and CSA Certification testing.

This chart details the different conductors commonly used in the industry. For each size, either AWG or Metric, various stranding options are listed. Typically the higher stranding is used in applications requiring greater conductor flexibility.

| AWG to Metric Wire Crosses |                           |
|----------------------------|---------------------------|
| AWG                        | Metric (mm <sup>2</sup> ) |
| 26 – 22                    | 0.1 – 0.5                 |
| 22 – 18                    | 0.5 – 1.0                 |
| 16 – 14                    | 1.5 – 2.5                 |
| 12 – 10                    | 4.0 – 6.0                 |



## Common Conductor Sizes and Strandings Reference Chart (continued)

| Conductor |                        | Individual Strands |          |        | Overall Conductor Size |       |            | Conductor  |                        | Individual Strands |          |        | Overall Conductor Size |           |              |
|-----------|------------------------|--------------------|----------|--------|------------------------|-------|------------|------------|------------------------|--------------------|----------|--------|------------------------|-----------|--------------|
|           |                        | No.                | Diameter |        | Diameter               |       | Area       |            |                        | No.                | Diameter |        | Diameter               |           | Area         |
| AWG       | Metric mm <sup>2</sup> |                    | mm       | In.    | mm                     | In.   | Circ. MILS | AWG        | Metric mm <sup>2</sup> |                    | mm       | In.    | mm                     | In.       | Circ. MILS   |
|           | 6                      | 7                  | 0.107    | 0.042  | 3.21                   | 0.126 | 11840      |            | 95                     | 19                 | 2.57     | 0.101  | 12.8                   | 0.505     | 187500       |
|           |                        | 1                  | 2.77     | 0.109  | 2.77                   | 0.109 | 11840      |            |                        | 37                 | 1.83     | 0.072  | 12.5                   | 0.504     | 187500       |
| 9         |                        | 7                  | 1.1      | 0.0432 | 3.3                    | 0.13  | 13000      | 4/0        |                        | 19                 | 2.89     | 0.1055 | 13.4                   | 0.528     | 211600       |
|           |                        | 1                  | 2.91     | 0.1144 | 2.91                   | 0.114 | 13090      |            |                        | 120                | 37       | 2.06   | 0.081                  | 14.4      | 0.567        |
| 8         |                        | 1                  | 3.26     | 0.1285 | 3.25                   | 0.128 | 16510      | 250 kcmil  | 150                    | 37                 | 2.07     | 0.0822 | 14.6                   | 0.575     | 250 kcmil    |
|           |                        | 7                  | 1.23     | 0.0486 | 3.7                    | 0.146 | 16510      | 300 kcmil  |                        | 37                 | 2.29     | 0.09   | 16                     | 0.63      | 300 kcmil    |
|           | 10                     | 7                  | 1.37     | 0.054  | 4.12                   | 0.162 | 19740      | 350 kcmil  | 185                    | 37                 | 2.47     | 0.0973 | 17.3                   | 0.681     | 350 kcmil    |
|           |                        | 1                  | 3.58     | 0.141  | 3.58                   | 0.141 | 19740      |            |                        | 37                 | 2.54     | 0.1    | 17.8                   | 0.7       | 365.1 kcmil  |
| 7         |                        | 7                  | 1.38     | 0.0545 | 4.15                   | 0.164 | 20520      | 400 kcmil  | 240                    | 37                 | 2.64     | 0.104  | 18.5                   | 0.728     | 400 kcmil    |
|           |                        | 1                  | 3.67     | 0.1443 | 3.67                   | 0.144 | 20520      |            |                        | 37                 | 2.9      | 0.114  | 20.3                   | 0.798     | 473.6 kcmil  |
| 6         |                        | 7                  | 1.55     | 0.0612 | 4.66                   | 0.184 | 26240      | 500 kcmil  |                        | 61                 | 2.26     | 0.089  | 20.3                   | 0.801     | 473.6 kcmil  |
|           |                        | 1                  | 4.11     | 0.162  | 4.11                   | 0.162 | 26240      |            |                        | 37                 | 2.95     | 0.1162 | 20.7                   | 0.813     | 500 kcmil    |
|           | 16                     | 7                  | 1.73     | 0.008  | 5.13                   | 0.204 | 31580      |            | 61                     | 2.3                | 0.0905   | 20.7   | 0.814                  | 500 kcmil |              |
| 5         |                        | 7                  | 1.75     | 0.0688 | 5.24                   | 0.206 | 33090      |            | 300 kcmil              | 61                 | 2.51     | 0.099  | 22.6                   | 0.891     | 592.1 kcmil  |
| 4         |                        | 7                  | 1.96     | 0.0772 | 5.88                   | 0.232 | 41740      | 600 kcmil  |                        | 61                 | 2.52     | 0.0992 | 22.7                   | 0.893     | 600 kcmil    |
|           | 25                     | 7                  | 2.16     | 0.085  | 6.48                   | 0.255 | 49340      | 700 kcmil  | 750 kcmil              | 61                 | 2.72     | 0.1071 | 24.5                   | 0.964     | 700 kcmil    |
|           |                        | 19                 | 1.32     | 0.052  | 6.6                    | 0.26  | 49340      |            |                        | 61                 | 2.82     | 0.1109 | 25.4                   | 0.998     | 750 kcmil    |
| 3         |                        | 7                  | 2.2      | 0.0867 | 6.61                   | 0.26  | 52620      |            |                        | 91                 | 2.31     | 0.0908 | 25.4                   | 0.998     | 750 kcmil    |
| 2         |                        | 7                  | 2.47     | 0.0974 | 7.42                   | 0.292 | 66300      |            | 400                    | 61                 | 2.9      | 0.114  | 26.1                   | 1.026     | 798.4 kcmil  |
|           | 35                     | 7                  | 2.54     | 0.1    | 7.62                   | 0.300 | 69070      | 800 kcmil  |                        | 61                 | 2.91     | 0.1145 | 26.2                   | 1.031     | 800 kcmil    |
|           |                        | 19                 | 1.55     | 0.001  | 7.75                   | 0.305 | 69070      |            |                        | 91                 | 2.38     | 0.0938 | 26.2                   | 1.032     | 800 kcmil    |
| 1         |                        | 19                 | 1.5      | 0.0064 | 8.43                   | 0.332 | 83690      | 1000 kcmil | 500                    | 61                 | 3.25     | 0.128  | 28.3                   | 1.152     | 986.8 kcmil  |
|           | 50                     | 19                 | 1.85     | 0.073  | 9.27                   | 0.365 | 98680      |            |                        | 91                 | 2.66     | 0.1048 | 29.3                   | 1.153     | 1000 kcmil   |
| 1/0       |                        | 19                 | 1.59     | 0.0745 | 9.46                   | 0.373 | 10500      |            | 625                    | 91                 | 2.97     | 0.117  | 32.7                   | 1.287     | 1233.7 kcmil |
| 2/0       |                        | 19                 | 2.13     | 0.0837 | 10.6                   | 0.419 | 133100     |            |                        |                    |          |        |                        |           |              |
| 3/0       | 70                     | 19                 | 2.18     | 0.086  | 10.9                   | 0.43  | 138100     |            |                        |                    |          |        |                        |           |              |
|           |                        | 19                 | 2.59     | 0.094  | 11.9                   | 0.47  | 167800     |            |                        |                    |          |        |                        |           |              |
|           |                        | 36                 | 1.71     | 0.0673 | 12                     | 0.471 | 167800     |            |                        |                    |          |        |                        |           |              |

A.  
System  
Overview

B1.  
Cable Ties

B2.  
Cable  
Accessories

B3.  
Stainless  
Steel Ties

C1.  
Wiring  
Duct

C2.  
Surface  
Raceway

C3.  
Abrasion  
Protection

C4.  
Cable  
Management

D1.  
Terminals

D2.  
Power  
Connectors

D3.  
Grounding  
Connectors

E1.  
Labeling  
Systems

E2.  
Labels

E3.  
Pre-Printed  
& Write-On  
Markers

E4.  
Permanent  
Identification

E5.  
Lockout/  
Tagout  
& Safety  
Solutions

F.  
Index











A. System Overview

## Stud Size Chart (Inches/Millimeters)

B1. Cable Ties

B2. Cable Accessories

B3. Stainless Steel Ties



|  |   |   |   |   |   |   |  |   |   |   |
|--|---|---|---|---|---|---|--|---|---|---|
|  |  |  |  |  |  |  |  |  |  |  |
| Standard Stud Size                           | <b>#2</b>   | <b>#4</b>   | <b>#5</b>   | <b>#6</b>   | <b>#8</b>   | <b>#10</b>  | <b>1/4"</b>  | <b>5/16"</b>  | <b>3/8"</b>   | <b>7/16"</b>  |
| Stud Size Decimal Equivalent                 | .086"   | .112"   | .127"   | .138"   | .164"   | .190"   | .250"  | .312"   | .375"   | .438"   |
| Terminal Hole Diameter                       | .090"   | .118"   | .130"   | .147"   | .173"   | .204"   | .270"  | .343"   | .392**<br>.406***   | .456"   |
| Stud Size Designation in Panduit Part Number | 2   | 4   | 5   | 6   | 8   | 10  | 14   | 56  | 38  | 76  |

C1. Wiring Duct

C2. Surface Raceway

C3. Abrasion Protection

C4. Cable Management

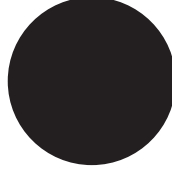
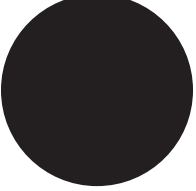
|  |   |   |   |  |   |
|--|---|---|---|--|---|
|  |  |  |  |  |  |
| Standard Stud Size                           | <b>1/2"</b>   | <b>5/8"</b>   | <b>3/4"</b>   | <b>7/8"</b>  | <b>1"</b>   |
| Stud Size Decimal Equivalent                 | .500"   | .625"   | .750"   | .875"  | 1.00"   |
| Terminal Hole Diameter                       | .531"   | .656"   | .810"   | .906"  | 1.031"  |
| Stud Size Designation in Panduit Part Number | 12  | 58  | 34  | 78   | 1   |

D1. Terminals

D2. Power Connectors

D3. Grounding Connectors

\*Terminal stud.  
\*\*Power Connector stud.

E1. Labeling Systems

E2. Labels

E3. Pre-Printed & Write-On Markers

E4. Permanent Identification

E5. Lockout/Tagout & Safety Solutions

F. Index

## Equivalent Tables Decimal/Inches/Millimeters

|   |   |       |       |   |   |       |        |   |   |       |        |   |   |       |        |
|---|---|-------|-------|---|---|-------|--------|---|---|-------|--------|---|---|-------|--------|
|  |  | .0156 | 0,396 |  |  | .2656 | 6,746  |  |  | .5156 | 13,100 |  |  | .7656 | 19,446 |
|   |  | .0468 | 1,189 |   |  | .2968 | 7,541  |   |  | .5468 | 13,891 |   |  | .7968 | 20,241 |
|  |  | .0625 | 1,588 |  |  | .3125 | 7,938  |  |  | .5625 | 14,288 |  |  | .8125 | 20,637 |
|  |  | .0937 | 2,380 |  |  | .3437 | 8,730  |  |  | .5937 | 15,080 |  |  | .8437 | 21,480 |
|  |  | .125  | 3,175 |  |  | .375  | 9,525  |  |  | .625  | 15,875 |  |  | .875  | 22,225 |
|  |  | .1562 | 3,968 |  |  | .4062 | 10,317 |  |  | .6562 | 16,667 |  |  | .9062 | 23,017 |
|  |  | .1875 | 4,763 |  |  | .4375 | 11,113 |  |  | .6875 | 17,463 |  |  | .9375 | 23,810 |
|  |  | .2187 | 5,555 |  |  | .4687 | 11,905 |  |  | .7187 | 18,255 |  |  | .9687 | 24,605 |
|  |   | .25   | 6,350 |  |   | .5    | 12,700 |  |   | .75   | 19,050 |  |   | 1.    | 25,400 |

## STRUCTUREDGROUND™ GROUNDING CONNECTORS

Panduit® StructuredGround™ Grounding Connectors provide innovative solutions for joining ground conductors to water pipe, ground rods, rebar, conduit, iron pipe and structural steel. Designed with the needs of the end user in mind, StructuredGround™ Grounding Connectors feature easy installation, lowest installed cost, and long-term reliability.



- Functional product information is marked directly on the connector, facilitating the identification, ordering, and usage of the grounding connector
- Compression connectors are color-coded to facilitate quick identification of the proper crimping die
- Mechanical connectors are designed for easy installation – no special tools required
- Incorporate wide wire range-taking capability to minimize inventory requirements
- Made from high strength, high conductivity electrolytic copper and aluminum alloy materials to provide optimum connectivity for both power and grounding applications
- Wide assortment of manual, controlled cycle, battery operated hydraulic and pneumatic crimping tools for reliable connections at the lowest installed cost

Panduit® StructuredGround™ Grounding Connectors are designed for use with many different code and flex conductor types and are available in a broad range of styles and sizes. A full line of manual, controlled cycle, and battery operated hydraulic crimping tools meet application needs and provide lowest installed cost. Panduit offers a wide variety of StructuredGround™ Grounding Connectors to meet customer needs and today's application requirements.

A.  
System  
Overview

B1.  
Cable Ties

B2.  
Cable  
Accessories

B3.  
Stainless  
Steel Ties

C1.  
Wiring  
Duct

C2.  
Surface  
Raceway

C3.  
Abrasion  
Protection

C4.  
Cable  
Management

D1.  
Terminals

D2.  
Power  
Connectors

D3.  
Grounding  
Connectors

E1.  
Labeling  
Systems

E2.  
Labels

E3.  
Pre-Printed  
& Write-On  
Markers

E4.  
Permanent  
Identification

E5.  
Lockout/  
Tagout  
& Safety  
Solutions

F.  
Index

A. System Overview

## Features and Benefits – StructuredGround™ Compression Connectors

B1. Cable Ties

**Bolded** features are unique to Panduit.

B2. Cable Accessories

### Copper HTAPs

**Easy-to-read, color-coded die index number for Panduit crimping dies, legible after crimping, for selection**

Part number and agency listings marked on part for easy identification

**Slotted design to reduce installation time when used with Panduit cable ties (included)**

Conductor sizes for each tap pocket marked on part

Made from high conductivity copper and electro tin-plated to inhibit corrosion



### Clear Covers for Copper HTAPs

Optically clear to allow 360° inspections

Made from high impact strength self-extinguishing plastic with UL94V-0 flammability rating and minimum oxygen index of 28

Built-in flanges retain HTAP in cover

Easy to assemble snap-on design

Molded in flash barriers protect against electrical flash over

Retainer clips to hold labels inside cover\*. Retainer clips have a write-on surface for manual marking

Corresponding Panduit HTAP part number, voltage rating, and temperature rating molded into cover half for easy identification

Low profile design minimizes space requirements

Flexible fingers closely conform to conductor preventing foreign objects from entering cover



\*Labels shown printed with Panduit® PanTher™ LS8E Printer. See page E1.2.

C4. Cable Management

### Thin Wall Copper CTAPs

Part number and conductor size marked on part for easy identification

Color-coded for proper crimp die selection

Ribbed design provides high strength

Made from high conductivity wrought copper



### Heavy Duty Copper CTAPs

Easy-to-read die index number for selection

Made from heavy wall, extruded, high conductivity copper; provides high strength and premium electrical properties

Part number and conductor size marked on part for easy identification



E1. Labeling Systems

### Access Floor Grounding Clamp **PATENTED**

Each part accommodates a wide range of copper conductor sizes – minimizes inventory

Made from high strength cast bronze

Quad bolt bonds perpendicular MCBN conductors

Bonds to the pedestal with a single bolt to simplify installation

Bonds to both square and round access floor pedestals



F. Index



## StructuredGround™ Direct Burial Compression Grounding System Roadmap

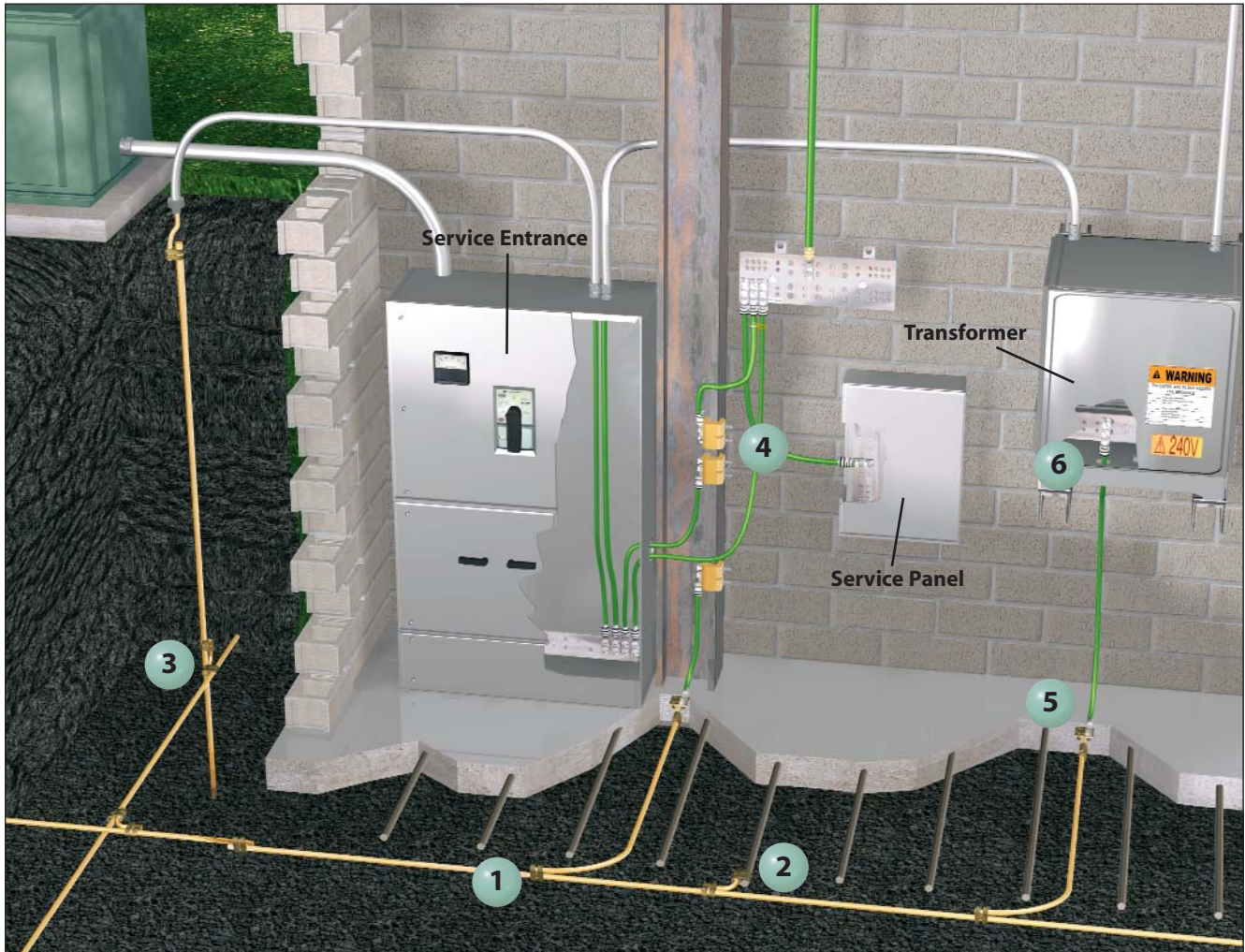

**1 Conductor to Conductor**  
E Style Grounding Connectors:  
Create bonds between parallel  
grounding conductors.  
(see page D3.8)



**2 Conductor to Rebar**  
E Style Grounding Connectors:  
Allow bonds to  
reinforcing bars.  
(see page D3.8)



**3 Conductor to Ground Rod**  
Grounding Cross Connectors:  
Create bonds between  
perpendicular grounding  
conductors.  
(see page D3.9)

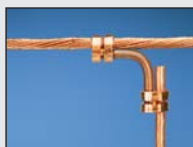

**4 Conductor to Building Steel**  
Universal Beam Grounding  
Clamp: Bonds structural  
steel to grounding  
conductor system.  
(see page D3.10)



**5 Conductor to Grounding  
Electrodes**  
Grounding Plate Connector:  
Allows bonds through  
concrete.  
(see page D3.10)



**6 Related Product LCC-W**  
Long Barrel Two-Hole Code  
Conductor Lugs:  
For use with stranded  
copper conductors.  
(see page D2.47 – D2.49)



A.  
System  
Overview

B1.  
Cable Ties

B2.  
Cable  
Accessories

B3.  
Stainless  
Steel Ties

C1.  
Wiring  
Duct

C2.  
Surface  
Raceway

C3.  
Abrasion  
Protection

C4.  
Cable  
Management

D1.  
Terminals

D2.  
Power  
Connectors

D3.  
Grounding  
Connectors

E1.  
Labeling  
Systems

E2.  
Labels

E3.  
Pre-Printed  
& Write-On  
Markers

E4.  
Permanent  
Identification

E5.  
Lockout/  
Tagout  
& Safety  
Solutions

F.  
Index

A. System Overview

## Service Entrance Grounding Roadmap

B1. Cable Ties

- Complies with J-STD-607-A and IEEE Std 1100 (IEEE Emerald Book)
- Grounding Equalizer (GE) is required when two or more Telecommunications Bonding Backbones (TBB) are used within a multi-story building; bond TBBs together with a GE at the top floor and at a minimum of every third floor in between

B2. Cable Accessories

B3. Stainless Steel Ties

C1. Wiring Duct

C2. Surface Raceway

C3. Abrasion Protection

C4. Cable Management

D1. Terminals

D2. Power Connectors

D3. Grounding Connectors

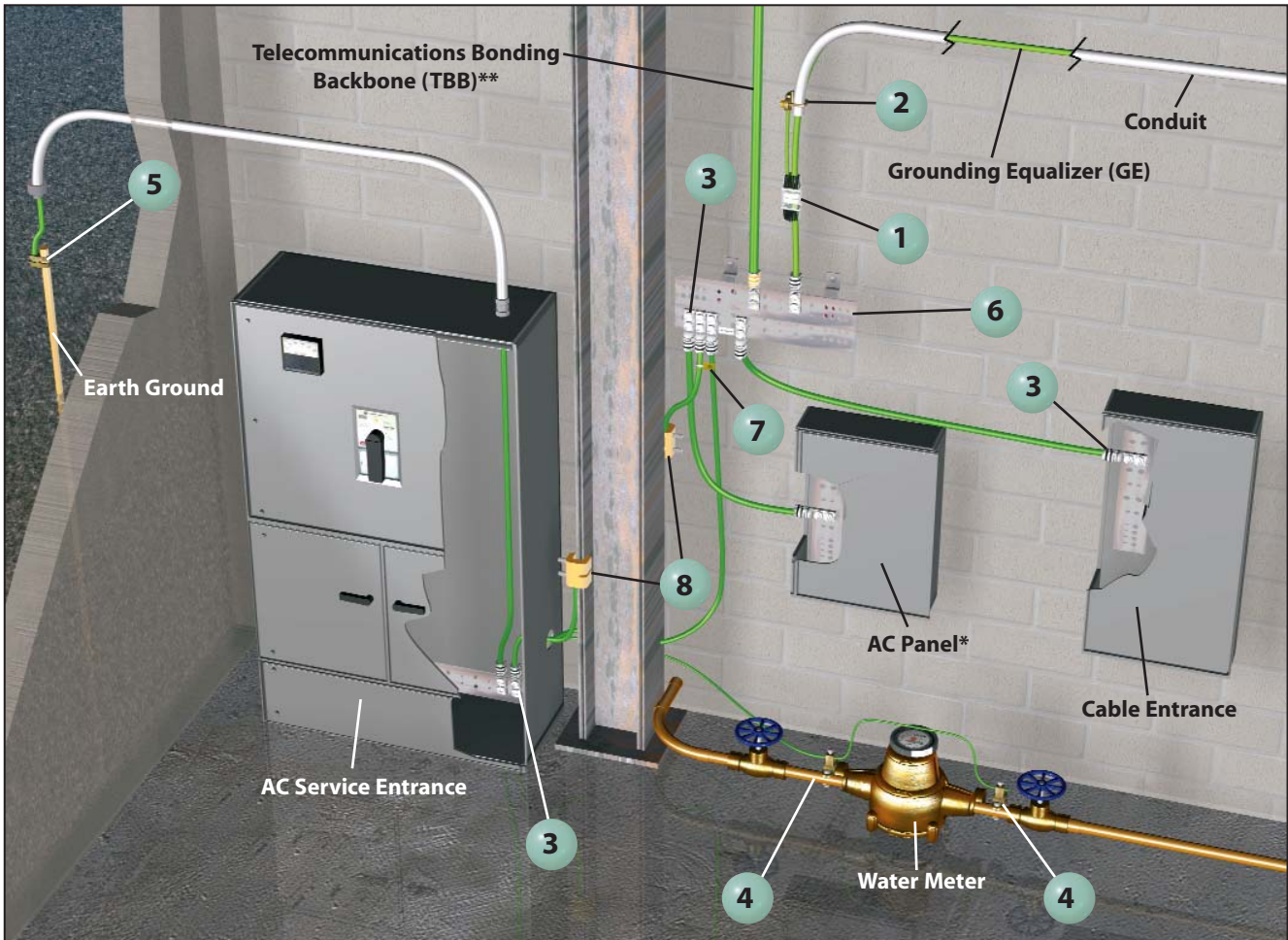

E1. Labeling Systems









E2. Labels

E3. Pre-Printed & Write-On Markers

E4. Permanent Identification

E5. Lockout/Tagout & Safety Solutions

F. Index

|  |  |
|--|--|
| <p><b>1</b> Copper Compression HTAP and Clear Cover: HTWC (see pages D3.15)</p>                               | <p><b>5</b> E Style Grounding Connector: GCE (see page D3.8)</p>                                    |
| <p><b>2</b> Bronze, U-Bolt Grounding Clamp: GPL (see page D3.25) connected by a cable to <b>1</b> (HTAP)</p>  | <p><b>6</b> Telecommunications Main Grounding Busbar (TMGB) and Busbar Label (see page D3.6)</p>    |
| <p><b>3</b> Copper Compression, Two-Hole, Long Barrel with Window Lug: LCC-W (see pages D2.47 - D2.49)</p>    | <p><b>7</b> Telecommunications Grounding and Bonding Conductor Label Kit: LTYK (see page D3.6)</p>  |
| <p><b>4</b> Bronze, Water Pipe Grounding Clamp: KP (see page D3.26)</p>                                       | <p><b>8</b> Universal Beam Grounding Clamp: GUBC (see page D3.10)</p>                               |

\*AC Panel should be grounded per NEC standards. Enclosure should be grounded per manufacturer's specifications.

\*\*Specification J-STD-607-A specifies different size conductors based on the length of the Telecommunications Bonding Backbone (TBB).





## Access Floor Grounding Clamp



### Type GPQC

- Bond mesh common bonding network (MCBN) conductors to each other and bond the access floor pedestals to the conductors
- Specifically designed to bond perpendicular MCBN conductors per TIA-942
- Bond to the pedestal with a single bolt to simplify installation
- Accommodate conductors from #6 – 1/0 AWG, minimizes inventory requirements
- Bond round and square access floor pedestals for greater flexibility

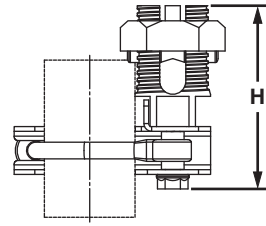
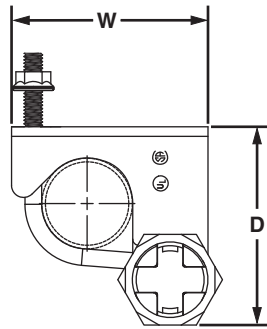

| Part Number | Round Pedestal (In.) | Square Pedestal (In.) | MCBN Conductor Size Range AWG (mm <sup>2</sup> ) | Figure Dimensions In. (mm) |              |             | Std. Pkg. Qty. | Std. Ctn. Qty. |
|-------------|----------------------|-----------------------|--|----------------------------|--------------|-------------|----------------|----------------|
|             |                      |                       |  | D                          | W            | H           |                |                |
| GPQC07-1/0  | 3/4 – 7/8            | —                     | #6 SOL – 1/0 STR (16 – 50)                       | 4.25 (108.0)               | 3.38 (85.9)  | 3.19 (81.0) | 1              | 10             |
| GPQC10-1/0  | 1 – 1 1/8            | 7/8                   | #6 SOL – 1/0 STR (16 – 50)                       | 4.19 (106.4)               | 3.38 (85.9)  | 3.19 (81.0) | 1              | 10             |
| GPQC12-1/0  | 1 1/4                | —                     | #6 SOL – 1/0 STR (16 – 50)                       | 4.53 (115.1)               | 3.44 (87.4)  | 3.19 (81.0) | 1              | 10             |
| GPQC15-1/0  | 1 1/2                | —                     | #6 SOL – 1/0 STR (16 – 50)                       | 4.47 (113.5)               | 3.44 (87.4)  | 3.19 (81.0) | 1              | 10             |
| GPQC17-1/0  | 1 3/4                | —                     | #6 SOL – 1/0 STR (16 – 50)                       | 5.19 (131.8)               | 4.00 (101.6) | 3.19 (81.0) | 1              | 10             |
| GPQC20-1/0  | 2                    | —                     | #6 SOL – 1/0 STR (16 – 50)                       | 5.06 (128.5)               | 4.00 (101.6) | 3.19 (81.0) | 1              | 10             |

A. System Overview

B1. Cable Ties

B2. Cable Accessories

B3. Stainless Steel Ties

C1. Wiring Duct

C2. Surface Raceway

C3. Abrasion Protection

C4. Cable Management

D1. Terminals

D2. Power Connectors

D3. Grounding Connectors

E1. Labeling Systems

E2. Labels

E3. Pre-Printed & Write-On Markers

E4. Permanent Identification

E5. Lockout/Tagout & Safety Solutions

F. Index

A. System Overview

## BICSI/J-STD-607-A Telecommunications Grounding Busbars

B1. Cable Ties

### Type GB

- Meets BICSI and J-STD-607-A requirements for network systems grounding applications
- Made of high conductivity copper and tin-plated to inhibit corrosion
- Comes pre-assembled with brackets and insulators attached for quick installation
- Insulators provide 600 V of insulation
- Use Panduit self-laminating laser/ink jet labels to identify busbars to meet TIA/EIA-606-A, see chart below

B2. Cable Accessories

B3. Stainless Steel Ties



TGB

C1. Wiring Duct

C2. Surface Raceway



TMGB

C3. Abrasion Protection

C4. Cable Management

| Part Number                                       | Bar Size        | No. of Mounting Positions             |                                     | Std. Pkg. Qty. |
|---|-----------------|---------------------------------------|-------------------------------------|----------------|
|   |                 | 1/4" Stud Hole with 5/8" Hole Spacing | 3/8" Stud Hole with 1" Hole Spacing |                |
| <b>Telecommunications Grounding Busbars (TGB)</b> |                 |                                       |                                     |                |
| GB2B0304TPI-1                                     | 1/4" x 2" x 10" | 4                                     | 3                                   | 1              |
| GB2B0306TPI-1                                     | 1/4" x 2" x 12" | 6                                     | 3                                   | 1              |
| GB2B0312TPI-1                                     | 1/4" x 2" x 20" | 12                                    | 3                                   | 1              |
| GB2B0514TPI-1                                     | 1/4" x 2" x 24" | 14                                    | 5                                   | 1              |

| <b>Telecommunications Main Grounding Busbars (TMGB)</b> |                 |    |    |   |
|---|-----------------|----|----|---|
| GB4B0612TPI-1   | 1/4" x 4" x 12" | 12 | 6  | 1 |
| GB4B0624TPI-1   | 1/4" x 4" x 20" | 24 | 6  | 1 |
| GB4B1028TPI-1   | 1/4" x 4" x 24" | 28 | 10 | 1 |

For additional label sizes, materials, and print technologies and to see the complete line of Panduit identification products, see pages E1.1 – E2.22.

## Component Labels for BICSI/J-STD-607-A Telecommunications Grounding Busbars

D1. Terminals



D2. Power Connectors

D3. Grounding Connectors

| Suggested Label Solutions for TIA/EIA-606-A Compliance |                                     |  |                                       |                                     |
|--|-------------------------------------|--|---------------------------------------|-------------------------------------|
| Telecommunications Grounding Busbar Part Number        | Laser/Ink Jet Desktop Printer Label | TDP43MY Thermal Transfer Desktop Printer Label | PanTher™ LS8E Hand-Held Printer Label | Cougar™ LS9 Hand-Held Printer Label |
| All GB2B and GB4B Parts                                | C200X100FJJ                         | C200X100YPT                                    | C200X100FJC                           | T100X000VPC-BK                      |

For complete labeling solutions and product information, reference charts on pages E1.1 – E2.22.

E2. Labels

## Telecommunications Grounding and Bonding Conductor Label Kit

E3. Pre-Printed & Write-On Markers

- Meets labeling requirements of J-STD-607-A; each telecommunications grounding and bonding conductor shall be labeled as close as practicable to its point of termination in a readable position
- Can be applied as a wrap-around marker (parallel to cable) or flag marker (45° or 90°) to cable
- Kit includes everything needed to properly label cables; ten flame retardant cable ties and ten rigid plastic yellow tags printed with "IF THIS CONNECTOR OR CABLE IS LOOSE OR MUST BE REMOVED, PLEASE CALL THE BUILDING TELECOMMUNICATIONS MANAGER."

E4. Permanent Identification



E5. Lockout/Tagout & Safety Solutions

| Part Number | Part Description  | Std. Pkg. Qty. |
|-------------|---|----------------|
| LTYK        | Label kit includes ten printed tags and ten flame retardant cable ties. | 1              |

F. Index



## NEMA Hole Pattern Grounding Busbars



### Type GBN

- Provided with standard NEMA hole pattern spacing
- Made of high conductivity copper and tin-plated to inhibit corrosion
- Come pre-assembled with brackets and insulators attached for quick installation
- Insulators provide 600 V of insulation



| Part Number   | Bar Size        | No. of Mounting Positions               |                |
|---------------|-----------------|---|----------------|
|               |                 | 1/2" Stud Hole with 1 3/4" Hole Spacing | Std. Pkg. Qty. |
| GB4N0007TPI-1 | 1/4" x 4" x 12" | 7                                       | 1              |
| GB4N0016TPI-1 | 1/4" x 4" x 24" | 16                                      | 1              |
| GB4N0024TPI-1 | 1/4" x 4" x 36" | 24                                      | 1              |
| GB4N0026TPI-1 | 1/4" x 4" x 48" | 26                                      | 1              |
| GB4N0034TPI-1 | 1/4" x 4" x 60" | 34                                      | 1              |



## Grounding Busbar 1" Hole Spacings



### Type GBD

- Provided with 1" hole D pattern spacing
- Made of high conductivity copper and tin-plated to inhibit corrosion
- Come pre-assembled with brackets and insulators attached for quick installation
- Insulators provide 600 V of insulation



| Part Number   | Bar Size        | No. of Mounting Positions            |                |
|---------------|-----------------|--------------------------------------|----------------|
|               |                 | 7/16" Stud Hole with 1" Hole Spacing | Std. Pkg. Qty. |
| GB2D0008TPI-1 | 1/4" x 2" x 12" | 8                                    | 1              |
| GB2D0021TPI-1 | 1/4" x 2" x 24" | 21                                   | 1              |
| GB2D0033TPI-1 | 1/4" x 2" x 36" | 33                                   | 1              |
| GB2D0044TPI-1 | 1/4" x 2" x 48" | 44                                   | 1              |
| GB2D0056TPI-1 | 1/4" x 2" x 60" | 56                                   | 1              |

## Stainless Steel Hardware for Busbars



- Bulk hardware for attaching connectors to TMGBs and TGBs



| Part Number          | Part Description   | Std. Pkg. Qty. |
|----------------------|--|----------------|
| <b>1/4" Hardware</b> |  |                |
| SSNTS1420-C          | Stainless steel mounting hardware; 1/4" stainless steel bolts.   | 100            |
| SSCW14-C             | Stainless steel mounting hardware; 1/4" stainless steel Belleville washers (locking).  | 100            |
| SSFW14-C             | Stainless steel mounting hardware; 1/4" stainless steel flat washers.  | 100            |
| SSN1420-C            | Stainless steel mounting hardware; 1/4" stainless steel nuts.  | 100            |
| <b>3/8" Hardware</b> |  |                |
| SSNTS3816-C          | Stainless steel mounting hardware; 3/8" stainless steel bolts.   | 100            |
| SSCW38-C             | Stainless steel mounting hardware; 3/8" stainless steel Belleville washers (locking).  | 100            |
| SSFW38-C             | Stainless steel mounting hardware; 3/8" stainless steel flat washers.  | 100            |
| SSN3816-C            | Stainless steel mounting hardware; 3/8" stainless steel nuts.  | 100            |
| <b>Hardware Kit</b>  |  |                |
| GLMHK                | Stainless steel hardware for use in mounting lugs for grounding plates and universal beam thread grounding clamps; includes: two hex head bolts 1/2-13 thread 1" long, two split lock washers for 1/2" diameter bolt, and two SAE flat washers for 1/2" diameter bolt. | 1              |

A. System Overview

B1. Cable Ties

B2. Cable Accessories

B3. Stainless Steel Ties

C1. Wiring Duct

C2. Surface Raceway

C3. Abrasion Protection

C4. Cable Management

D1. Terminals

D2. Power Connectors

D3. Grounding Connectors

E1. Labeling Systems

E2. Labels

E3. Pre-Printed & Write-On Markers

E4. Permanent Identification

E5. Lockout/Tagout & Safety Solutions

F. Index

A. System Overview

B1. Cable Ties

B2. Cable Accessories

B3. Stainless Steel Ties

C1. Wiring Duct

C2. Surface Raceway

C3. Abrasion Protection

C4. Cable Management

D1. Terminals

D2. Power Connectors

D3. Grounding Connectors

E1. Labeling Systems

E2. Labels

E3. Pre-Printed & Write-On Markers

E4. Permanent Identification

E5. Lockout/Tagout & Safety Solutions

F. Index



## E Style Grounding Connectors

### Type GCE

- Wide range-taking ability and multi-conductor design provide flexibility with a minimum number of parts, allowing for conductor to conductor, conductor to rebar, and conductor to ground rod applications
- Designed for the enhanced crimp process using patent pending technology meets IEEE Std 837™ – 2002
- Slotted design allows quick and easy assembly of conductor to connector using Panduit cable ties, included
- Pre-applied conductive antioxidant compound ensures a high quality mechanical and electrical bond, speeding installation
- Color-coded and marked with Panduit die index numbers for proper crimp die selection
- UL 467 Listed and CSA 22.2 Certified for grounding and bonding suitable for direct burial in earth or concrete when crimped with Panduit or industry standard crimping tools and Panduit dies
- Complies with vibration tests per MIL-STD-202G (METHOD 201A)

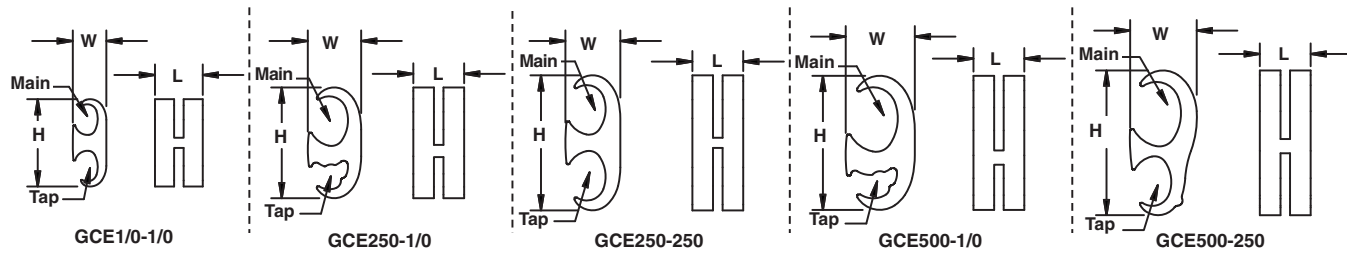
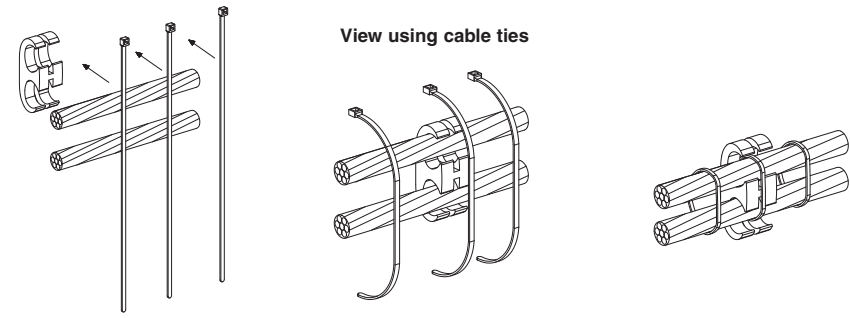

| Part Number       | Element | Copper Conductor Size Range AWG (mm <sup>2</sup> ) | Ground Rod Size In. (mm) | Rebar Size In. (mm)                           | Figure Dimensions In. (mm) |             |             | Panduit Color Code | Panduit Die Index No.‡ | Std. Pkg. Qty. |
|-------------------|---------|--|--------------------------|---|----------------------------|-------------|-------------|--------------------|------------------------|----------------|
|                   |         |  |                          |   | L                          | W           | H           |                    |                        |                |
| <b>GCE1/0-1/0</b> | Main    | #6 SOL – 1/0 STR (16 – 50)                         | —                        | —   | 0.94 (23.9)                | 0.66 (16.8) | 1.72 (43.7) | Red                | PG10                   | 1              |
|                   | Tap     |  |                          |   |                            |             |             |                    |                        |                |
| <b>GCE250-1/0</b> | Main    | 1/0 STR – 250 kcmil (70 – 120)                     | 1/2 – 5/8 (12.7 – 15.9)  | 3/8 – 1/2, #3 – #4 (9.5 – 12.7), (#10 – #13)  | 1.00 (25.4)                | 1.05 (26.7) | 2.18 (55.4) | Black              | PG25                   | 1              |
|                   | Tap     |  |                          |   |                            |             |             |                    |                        |                |
| <b>GCE250-250</b> | Main    | 1/0 STR – 250 kcmil (70 – 120)                     | 1/2 – 5/8 (12.7 – 15.9)  | 3/8 – 1/2, #3 – #4 (9.5 – 12.7), (#10 – #13)  | 1.00 (25.4)                | 1.08 (27.4) | 2.66 (67.6) | Black              | PG25                   | 1              |
|                   | Tap     |  |                          |   |                            |             |             |                    |                        |                |
| <b>GCE500-1/0</b> | Main    | 250 – 500 kcmil (150 – 240)                        | 1/2 – 3/4 (12.7 – 19.1)  | 5/8 – 3/4, #5 – #6 (15.9 – 19.1), (#16 – #19) | 1.00 (25.4)                | 1.36 (34.5) | 2.64 (67.1) | Blue               | PG50                   | 1              |
|                   | Tap     |  |                          |   |                            |             |             |                    |                        |                |
| <b>GCE500-250</b> | Main    | 250 – 500 kcmil (150 – 240)                        | 1/2 – 3/4 (12.7 – 19.1)  | 5/8 – 3/4, #5 – #6 (15.9 – 19.1), (#16 – #19) | 1.00 (25.4)                | 1.32 (33.4) | 2.85 (72.4) | Blue               | PG50                   | 1              |
|                   | Tap     |  |                          |   |                            |             |             |                    |                        |                |

‡See page D3.90 for tool and die information.



## Grounding Cross Connectors

### Type GCC

- Only a single die required to crimp each element, which speeds installation and reduces costs
- Wide range-taking ability and multi-conductor design provide flexibility with a minimum number of parts, allowing for conductor to conductor, conductor to rebar, and conductor to ground rod applications
- Designed for the enhanced crimp process using patent pending technology meets IEEE Std 837™ – 2002
- Slotted design allows quick and easy assembly of conductor to connector using Panduit cable ties, included
- Pre-applied conductive antioxidant compound ensures a high quality mechanical and electrical bond, speeding installation
- Color-coded and marked with Panduit die index numbers for proper crimp die selection
- UL 467 Listed and CSA 22.2 Certified for grounding and bonding suitable for direct burial in earth or concrete when crimped with Panduit or industry standard crimping tools and Panduit dies
- Complies with vibration tests per MIL-STD-202G (METHOD 201A)

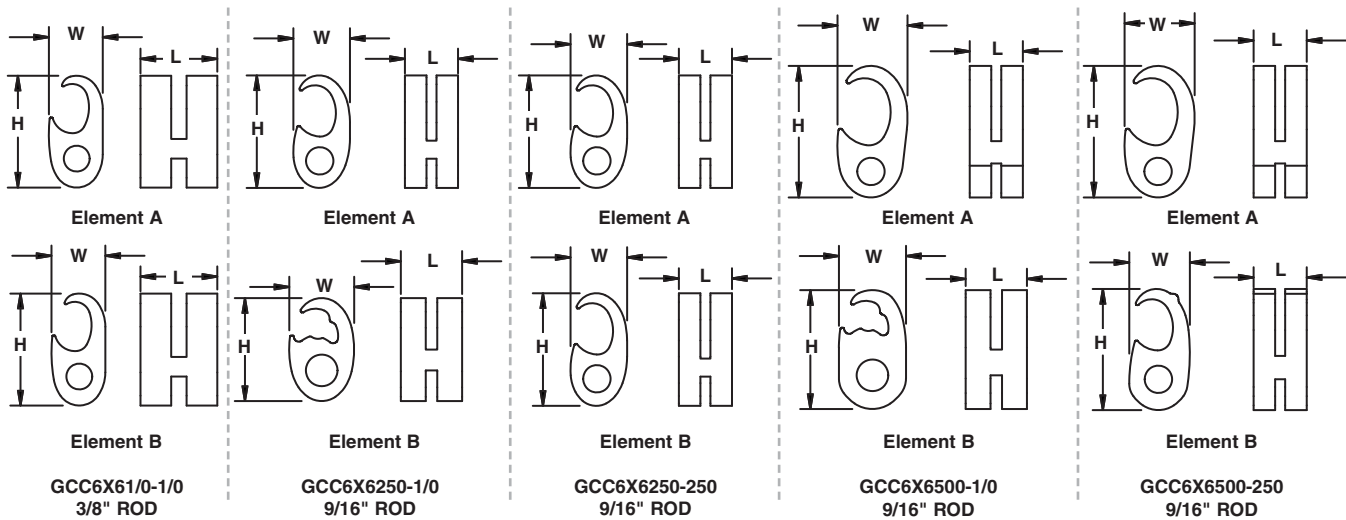

| Part Number   | Element | Copper Conductor Size Range AWG (mm²) | Ground Rod Size In. (mm) | Rebar Size In. (mm)                           | Figure Dimensions In. (mm) |             |             | Panduit Color Code | Panduit Die Index No.‡ | Std. Pkg. Qty. |
|---------------|---------|---------------------------------------|--------------------------|---|----------------------------|-------------|-------------|--------------------|------------------------|----------------|
|               |         |                                       |                          |   | L                          | W           | H           |                    |                        |                |
| GCC6X610-1/0  | A       | #6 SOL – 1/0 STR (16 – 50)            | —                        | —   | 0.94 (23.9)                | 0.66 (16.8) | 1.37 (34.8) | Red                | PG10                   | 1              |
|               | B       |                                       |                          |   |                            |             |             |                    |                        |                |
| GCC6X6250-1/0 | A       | #2 SOL – 250 kcmil (35 – 120)         | 1/2 – 5/8 (12.7 – 15.9)  | 3/8 – 1/2, #3 – #4 (9.5 – 12.7), (#10 – #13)  | 1.00 (25.4)                | 1.06 (26.9) | 2.12 (53.8) | Black              | PG25                   | 1              |
|               | B       |                                       |                          |   |                            |             | 1.68 (42.7) |                    |                        |                |
| GCC6X6250-250 | A       | #2 SOL – 250 kcmil (35 – 120)         | 1/2 – 5/8 (12.7 – 15.9)  | 3/8 – 1/2, #3 – #4 (9.5 – 12.7), (#10 – #13)  | 1.00 (25.4)                | 1.06 (26.9) | 2.12 (53.8) | Black              | PG25                   | 1              |
|               | B       |                                       |                          |   |                            |             |             |                    |                        |                |
| GCC6X6500-1/0 | A       | 250 – 500 kcmil (150 – 240)           | 1/2 – 3/4 (12.7 – 19.1)  | 5/8 – 3/4, #5 – #6 (15.9 – 19.1), (#16 – #19) | 1.00 (25.4)                | 1.32 (33.5) | 2.48 (63.0) | Blue               | PG50                   | 1              |
|               | B       |                                       |                          |   |                            | 1.09 (27.7) | 1.94 (49.3) |                    |                        |                |
| GCC6X6500-250 | A       | 250 – 500 kcmil (150 – 240)           | 1/2 – 3/4 (12.7 – 19.1)  | 5/8 – 3/4, #5 – #6 (15.9 – 19.1), (#16 – #19) | 1.00 (25.4)                | 1.32 (33.5) | 2.48 (63.0) | Blue               | PG50                   | 1              |
|               | B       |                                       |                          |   |                            | 1.16 (29.5) | 2.29 (58.2) |                    |                        |                |

‡See page D3.90 for tool and die information.

A. System Overview

B1. Cable Ties

B2. Cable Accessories

B3. Stainless Steel Ties

C1. Wiring Duct

C2. Surface Raceway

C3. Abrasion Protection

C4. Cable Management

D1. Terminals

D2. Power Connectors

D3. Grounding Connectors

E1. Labeling Systems

E2. Labels

E3. Pre-Printed & Write-On Markers

E4. Permanent Identification

E5. Lockout/Tagout & Safety Solutions

F. Index

A. System Overview

B1. Cable Ties

B2. Cable Accessories

B3. Stainless Steel Ties

C1. Wiring Duct

C2. Surface Raceway

C3. Abrasion Protection

C4. Cable Management

D1. Terminals

D2. Power Connectors

D3. Grounding Connectors

E1. Labeling Systems

E2. Labels

E3. Pre-Printed & Write-On Markers

E4. Permanent Identification

E5. Lockout/Tagout & Safety Solutions

F. Index



## Universal Beam Grounding Clamp

### Type GUBC

- Universal, fits on a wide range of standard (angled) and wide flange (parallel) structural steel beams
- Provide a mounting pad suitable for a two-hole compression lug
- Install quickly and easily with standard 1/4" key hex wrench tooling

- UL 467 Listed and CSA 22.2 Certified for grounding and bonding suitable for direct burial in earth or concrete
- Comply with vibration tests per MIL-STD-202G (METHOD 201A)

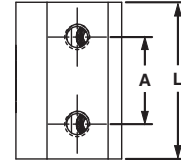
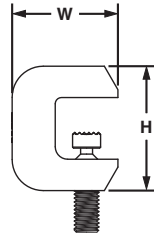
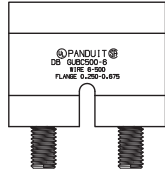

| Part Number      | Copper Conductor Size Range AWG (mm <sup>2</sup> ) | Flange Thickness In. (mm)     | Thread Size In. | Figure Dimensions In. (mm) |                |                |                | Std. Pkg. Qty. |
|------------------|--|-------------------------------|-----------------|----------------------------|----------------|----------------|----------------|----------------|
|                  |  |                               |                 | A                          | L              | W              | H              |                |
| <b>GUBC500-6</b> | #6 – 500<br>(16 – 240)                             | 0.250 – 0.675<br>(6.3 – 17.1) | 1/2 – 13        | 1.75<br>(44.4)             | 3.15<br>(80.0) | 2.13<br>(54.0) | 2.50<br>(63.5) | 1              |

For stainless steel mounting hardware kit, see part number GLMHK on page D3.7.



## Grounding Plate Connector

### Type GPC

- Slotted design allows quick and easy assembly of conductor to connector using Panduit cable ties, included
- Pre-applied conductive antioxidant compound ensures a high quality mechanical and electrical bond, speeding installation
- Complies with vibration tests per MIL-STD-202G (METHOD 201A)
- Made from high conductivity copper; provides strength and premium electrical properties

- Color-coded and marked with Panduit die index numbers for proper crimp die selection
- UL 467 Listed and CSA 22.2 Certified for grounding and bonding suitable for direct burial in earth or concrete when crimped with Panduit or industry standard crimping tools and Panduit dies

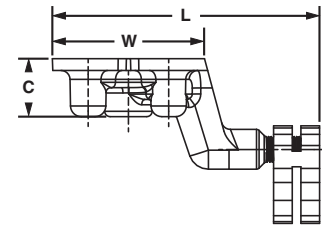
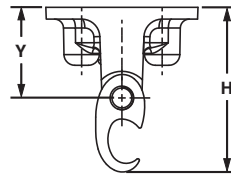
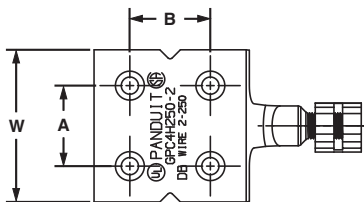

| Part Number       | Copper Conductor Size Range AWG (mm <sup>2</sup> ) | Thread Size In. | Figure Dimensions In. (mm) |                |                |                |                |                |                | Panduit Color Code | Panduit Die Index No.‡ | Std. Pkg. Qty. |
|-------------------|--|-----------------|----------------------------|----------------|----------------|----------------|----------------|----------------|----------------|--------------------|------------------------|----------------|
|                   |  |                 | L                          | W              | H              | Y              | A              | B              | C              |                    |                        |                |
| <b>GPC4H250-2</b> | #2 SOL – 250 kcmil<br>(35 – 120)                   | 1/2 – 13        | 5.81<br>(147.5)            | 3.31<br>(84.0) | 3.58<br>(90.9) | 1.97<br>(50.0) | 1.75<br>(44.4) | 1.75<br>(44.4) | 1.26<br>(32.0) | Black              | PG25                   | 1              |

‡See page D3.90 for tool and die information.

For stainless steel mounting hardware kit, see part number GLMHK on page D3.7.





## Code Conductor, Thin Wall, CTAP

### For Copper Code Stranded Connections

#### Type CTAPF

- For copper-to-copper tapping, splicing or pigtailling
- Wide wire range-taking capability minimizes inventory requirements
- Color-coded for proper crimp die selection
- Ribbed design provides high strength

- Made from high conductivity wrought copper
- UL Listed and CSA Certified to 600 V and temperature rated to 90°C when crimped with Panduit and specified competitor crimping tools and dies^

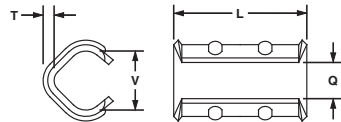

| Part Number   | Copper Conductor Size |                           | Number of Ribs | Figure Dimensions In. (mm) |            |            |             | Panduit Color Code | Wire Strip Length In. (mm) | Std. Pkg. Qty. |
|---------------|-----------------------|---------------------------|----------------|----------------------------|------------|------------|-------------|--------------------|----------------------------|----------------|
|               | AWG Run (mm²)         | AWG Tap (mm²)             |                | L                          | T          | V          | Q           |                    |                            |                |
| CTAPF10-16-C* | #14 AWG (2.5)         | #16 – #14 AWG (1.5 – 2.5) | 0              | 0.41 (10.4)                | 0.06 (1.5) | .19 (4.8)  | 0.13 (3.3)  | Red                | 1/2 (12.7)                 | 100            |
|               | #12 AWG (4.0)         | #16 – #12 AWG (1.5 – 4.0) |                |                            |            |            |             |                    |                            |                |
|               | #10 AWG (6.0)         | #14 AWG (2.5)             |                |                            |            |            |             |                    |                            |                |
| CTAPF8-12-C‡  | #10 AWG (6.0)         | #10 AWG (6.0)             | 0              | 0.67 (17.0)                | 0.07 (1.8) | .26 (6.6)  | 0.19 (4.8)  | Blue               | 11/16 (17.5)               | 100            |
|               | #8 AWG (10.0)         | #12 AWG (4.0)             |                |                            |            |            |             |                    |                            |                |
| CTAPF6-12-C‡  | #8 AWG (10.0)         | #10 – #8 AWG (6.0 – 10.0) | 0              | 0.67 (17.0)                | 0.07 (1.8) | .32 (8.1)  | 0.24 (6.1)  | Gray               | 11/16 (17.5)               | 100            |
|               | #6 AWG (16.0)         | #12 – #10 AWG (4.0 – 6.0) |                |                            |            |            |             |                    |                            |                |
| CTAPF4-12-C‡  | #6 AWG (16)           | #8 – #6 AWG (10 – 16)     | 1              | 1.25 (31.8)                | 0.07 (1.8) | .40 (10.2) | 0.28 (7.1)  | Brown              | 1 5/16 (33.3)              | 100            |
|               | #5, #4 AWG (16, 25)   | #12 – #8 AWG (4 – 10)     |                |                            |            |            |             |                    |                            |                |
| CTAPF3-12-C‡  | #5, #4 AWG (16, 25)   | #6 – #5 AWG (16)          | 1              | 1.25 (31.8)                | 0.08 (2.0) | .46 (11.7) | 0.31 (7.9)  | Green              | 1 5/16 (33.3)              | 100            |
|               | #3 AWG (25)           | #12 – #6 AWG (4 – 16)     |                |                            |            |            |             |                    |                            |                |
| CTAPF2-12-C‡  | #4 AWG (25)           | #4 AWG (25)               | 1              | 1.25 (31.8)                | 0.08 (2.0) | .51 (13.0) | 0.33 (8.4)  | Pink               | 1 5/16 (33.3)              | 100            |
|               | #3 AWG (25)           | #5 AWG (16)               |                |                            |            |            |             |                    |                            |                |
|               | #2 AWG (35)           | #12 – #6 AWG (4 – 16)     |                |                            |            |            |             |                    |                            |                |
| CTAPF1-12-C   | #3 AWG (25)           | #4 – #3 AWG (25)          | 2              | 1.82 (46.2)                | 0.08 (2.0) | .57 (14.5) | 0.40 (10.2) | Black              | 1 7/8 (47.6)               | 100            |
|               | #2 AWG (35)           | #5 – #4 AWG (16 – 25)     |                |                            |            |            |             |                    |                            |                |
|               | #1 AWG (35)           | #12 – #5 AWG (4 – 16)     |                |                            |            |            |             |                    |                            |                |
| CTAPF1/0-12-L | #2 AWG (35)           | #4 – #2 AWG (25 – 35)     | 2              | 1.82 (46.2)                | 0.09 (2.3) | .63 (16.0) | 0.42 (10.7) | Orange             | 1 7/8 (47.6)               | 50             |
|               | #1 AWG (35)           | #4 – #3 AWG (25)          |                |                            |            |            |             |                    |                            |                |
|               | 1/0 AWG (50)          | #12 – #4 AWG (4 – 25)     |                |                            |            |            |             |                    |                            |                |
| CTAPF2/0-12-Q | #1 AWG (35)           | #2 – #1 AWG (35)          | 2              | 1.82 (46.2)                | 0.09 (2.3) | .71 (18.0) | 0.48 (12.2) | Purple             | 1 7/8 (47.6)               | 25             |
|               | 1/0 AWG (50)          | #3 – #2 AWG (25 – 35)     |                |                            |            |            |             |                    |                            |                |
|               | 2/0 AWG (70)          | #12 – #3 AWG (4 – 35)     |                |                            |            |            |             |                    |                            |                |
| CTAPF3/0-12-Q | 1/0 AWG (50)          | #1 – 1/0 AWG (50)         | 2              | 1.82 (46.2)                | 0.09 (2.3) | .81 (20.6) | 0.55 (14.0) | Yellow             | 1 7/8 (47.6)               | 25             |
|               | 2/0 AWG (70)          | #2 – #1 AWG (35)          |                |                            |            |            |             |                    |                            |                |
|               | 3/0 AWG (95)          | #12 – #2 AWG (4 – 35)     |                |                            |            |            |             |                    |                            |                |

See pages D3.92 and D3.93 for tool and die information.

\*CTAPF10-16-C available with square, not flared ends.

All parts available in tin-plated; add TP before packaging code – example: CTAPF6-12TP-C.

^Note: CTAPF parts are UL Listed and CSA Certified with AWG wire only.

‡CSA Certified for grounding and bonding.

A. System Overview

B1. Cable Ties

B2. Cable Accessories

B3. Stainless Steel Ties

C1. Wiring Duct

C2. Surface Raceway

C3. Abrasion Protection

C4. Cable Management

D1. Terminals

D2. Power Connectors

D3. Grounding Connectors

E1. Labeling Systems

E2. Labels

E3. Pre-Printed & Write-On Markers

E4. Permanent Identification

E5. Lockout/Tagout & Safety Solutions

F. Index

**UL LISTED Code Conductor, Heavy Duty, CTAP**

**For Use with Solid and Stranded Copper Code Conductors**

**Type CTAP**

- For tapping into unbroken continuous main, as a wire joint or two-way splice
- Wide wire range-taking capability minimizes inventory requirements
- Made from heavy wall, extruded, high conductivity copper; provides high strength and premium electrical properties

- UL Listed per UL 486 for use up to 35 KV\*\* and temperature rated 90°C when crimped with Panduit and specified competitor crimping tools and dies
- UL Listed per UL 467 for grounding and bonding suitable for direct burial in earth or concrete when crimped with Panduit and specified competitor crimping tools and dies^

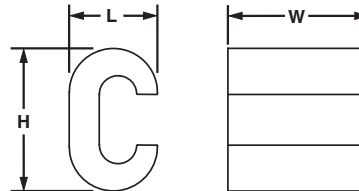

| Part Number          | Copper Conductor Size                         |   | Figure Dimensions In. (mm) |             |             | Panduit Die Index No.‡ | Burdny Die Index No.‡ | Wire Strip Length In. (mm) | Tap Cover* | Std. Pkg. Qty. |
|----------------------|---|---|----------------------------|-------------|-------------|------------------------|-----------------------|----------------------------|------------|----------------|
|                      | AWG Run (mm²)                                 | AWG Tap (mm²)                               | L                          | W           | H           |                        |                       |                            |            |                |
| <b>CTAP4-8-L</b>     | #6 – #4 AWG SOL or STR (16 SOL or STR)        | #8 AWG SOL or STR (10 SOL or STR)           | 0.46 (11.7)                | 0.63 (16.0) | 0.73 (18.5) | PBG                    | BG                    | 3/4 (19)                   | CVR6-1     | 50             |
| <b>CTAP4-6-L</b>     | #6 AWG STR, #4 AWG SOL or STR (16 SOL or STR) | #6 AWG SOL or STR (95 STR)                  | 0.48 (12.2)                | 0.63 (16.0) | 0.76 (19.3) | PBG                    | BG                    | 3/4 (19)                   | CVR6-1     | 50             |
| <b>CTAP4-4-L</b>     | #4 AWG SOL or STR (16 SOL or STR)             | #4 AWG STR (16 STR)                         | 0.46 (11.7)                | 0.63 (16.0) | 0.81 (20.6) | PBG                    | BG                    | 3/4 (19)                   | CVR6-1     | 50             |
| <b>CTAP2-4-Q</b>     | #2 AWG SOL or STR (35 SOL or STR)             | #8 – #4 AWG SOL or STR (10 – 16 SOL or STR) | 0.60 (15.2)                | 0.76 (19.3) | 0.96 (24.4) | PC                     | C                     | 7/8 (22)                   | CVR2-1     | 25             |
| <b>CTAP2-2-X</b>     | #2 AWG SOL or STR (35 SOL or STR)             | #2 AWG SOL or STR (25 SOL or STR)           | 0.60 (15.2)                | 0.75 (19.0) | 1.05 (26.7) | PC                     | C                     | 7/8 (22)                   | CVR2-1     | 10             |
| <b>CTAP2/0-2-X</b>   | 1/0 – 2/0 AWG STR (70 STR)                    | #8 – #2 AWG SOL or STR (10 – 25 SOL or STR) | 0.80 (20.3)                | 0.93 (23.6) | 1.32 (33.5) | PO                     | O                     | 1 1/16 (27)                | CVR2-1     | 10             |
| <b>CTAP2/0-2/0-X</b> | 1/0 – 2/0 AWG STR (70 STR)                    | 1/0 – 2/0 AWG STR (50 STR)                  | 0.80 (20.3)                | 0.93 (23.6) | 1.37 (34.8) | PO                     | O                     | 1 1/16 (27)                | CVR250-1   | 10             |
| <b>CTAP4/0-2-X</b>   | 3/0 – 4/0 AWG STR (95 STR)                    | #6 – #2 AWG SOL or STR (16 – 35 SOL or STR) | 0.94 (23.9)                | 1.08 (27.4) | 1.66 (42.2) | PD3                    | F                     | 1 1/4 (32)                 | CVR500-1   | 10             |
| <b>CTAP4/0-2/0-X</b> | 3/0 – 4/0 AWG STR (95 STR)                    | 1/0 – 2/0 AWG STR (50 – 70 STR)             | 1.00 (25.4)                | 1.08 (27.3) | 1.57 (39.9) | PD3                    | F                     | 1 1/4 (32)                 | CVR500-1   | 10             |
| <b>CTAP4/0-4/0-X</b> | 3/0 – 4/0 AWG STR (95 STR)                    | 3/0 – 4/0 AWG STR (95 STR)                  | 1.00 (25.4)                | 1.08 (27.4) | 1.57 (39.9) | PD3                    | F                     | 1 1/4 (32)                 | CVR500-1   | 10             |

‡See page D3.91 for tool and die information.

\*See page D3.13 for type CVR CTAP covers.

\*\*Consult cable manufacturer for voltage stress relief instructions with applications greater than 2000 V.

^Note: CTAP parts are UL Listed and CSA Certified with AWG wire only.



## Clear Covers for HTCT HTAPs

### Type CLRCVR

- Made of high impact plastic to provide high impact strength and 360° inspections of crimped connection to assure the crimp is complete and the correct die was used
- Incorporate dual self-latching spring loaded latches and supplied with two Panduit UL 94 V-0 cable ties to allow for easy snap-on assembly and ensure covers are secured
- Low profile design minimizes space requirements
- Each cover half supports installation information labels inside plastic retainer strips to allow labels to be viewed on either side of cover and to protect labels from being removed

- Incorporate molded in flash barriers which encompass the HTAP installation providing protection against electrical flash over
- UL 94 V-0 flame rating and oxygen index of 28 providing self-extinguishing, flame retardant properties
- Part number, voltage rating, temperature rating and HTCT part number molded into cover for easy identification
- See page D3.33 for detailed installation instructions

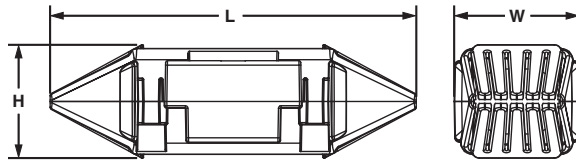

| Part Number | Use with HTAP Part Number | Figure Dimensions<br>In. (mm) |                |                | Std.<br>Pkg.<br>Qty. |
|-------------|---------------------------|-------------------------------|----------------|----------------|----------------------|
|             |                           | L                             | W              | H              |                      |
| CLRCVR1-1   | HTCT6X-6X                 | 4.48<br>(113.8)               | 1.41<br>(35.8) | 1.20<br>(30.5) | 1                    |
| CLRCVR2-1   | HTCT2-2                   | 5.10<br>(129.5)               | 1.66<br>(42.2) | 1.40<br>(35.6) | 1                    |
| CLRCVR3-1   | HTCT250-2, HTCT250-250    | 5.35<br>(135.9)               | 2.16<br>(54.9) | 1.40<br>(35.6) | 1                    |



## Black Covers for Copper HTAPs and CTAPs

- Used to insulate connectors and protect tap connections from corrosive environments
- UL Listed and CSA Certified with approved connectors for use up to 600 V and temperature rated to 90° C

- Made of durable, weather-resistant black polypropylene
- Double locking latches provide secure cover installation

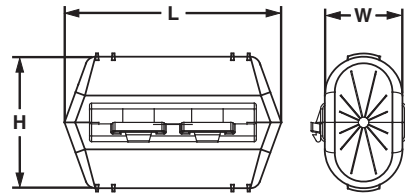

| Part Number | Use with CTAP Part Number                 | Use with HTAP Part Number  | Figure Dimensions<br>(In.) |      |      | Std.<br>Pkg.<br>Qty. |
|-------------|---|----------------------------|----------------------------|------|------|----------------------|
|             |   |                            | L                          | W    | H    |                      |
| CVR6-1      | CTAP4-8-L, CTAP4-6-L, CTAP4-4-L           | HTCT6X-6X-1                | 2.00                       | 1.20 | 1.26 | 1                    |
| CVR2-1      | CTAP2-4-Q, CTAP2-2-X, CTAP2/0-2-X         | HTCT2-2-1                  | 3.38                       | 1.40 | 2.00 | 1                    |
| CVR250-1    | CTAP2/0-2/0-X                             | HTCT250-2-1, HTCT250-250-1 | 3.38                       | 1.55 | 2.05 | 1                    |
| CVR500-1*   | CTAP4/0-2-X, CTAP4/0-2/0-X, CTAP4/0-4/0-X | —                          | 3.86                       | 1.97 | 2.66 | 1                    |
| CVR1000-1*  | —   | —                          | 5.62                       | 2.45 | 3.72 | 1                    |

For information on copper HTAPs, see page D3.14  
 For information on copper CTAPs, see page D3.12  
 \*Not CSA Certified.

A.  
System  
Overview

B1.  
Cable Ties

B2.  
Cable  
Accessories

B3.  
Stainless  
Steel Ties

C1.  
Wiring  
Duct

C2.  
Surface  
Raceway

C3.  
Abrasion  
Protection

C4.  
Cable  
Management

D1.  
Terminals

D2.  
Power  
Connectors

D3.  
Grounding  
Connectors

E1.  
Labeling  
Systems

E2.  
Labels

E3.  
Pre-Printed  
& Write-On  
Markers

E4.  
Permanent  
Identification

E5.  
Lockout/  
Tagout  
& Safety  
Solutions

F.  
Index

A. System Overview



## Code/Flex Conductor HTAP

B1. Cable Ties

### For Making Parallel and Multiple Tap Connections on Code and Flex Conductors

#### Type HTCT

B2. Cable Accessories

- Used to tap into continuous conductors as a splice or pigtailling
- Each HTAP terminates a wide range of conductor sizes and combinations of code and flex conductors Class G, H, I and Diesel Locomotive to suit a variety of applications
- Slotted design allows quick and easy assembly of conductor to HTAP using three Panduit 94V-0 cable ties included
- Tap grooves are separated from one another allowing them to function independently so HTAP can be used with a single or multiple taps providing maximum design and installation flexibility
- Color-coded and marked with Panduit die index numbers for proper crimp die selection
- UL Listed and CSA Certified for applications up to 600 V when crimped with Panduit and specified competitor crimping tools and Panduit crimping dies<sup>‡</sup>
- Tin-plated to inhibit corrosion

B3. Stainless Steel Ties

C1. Wiring Duct

C2. Surface Raceway

C3. Abrasion Protection



C4. Cable Management

D1. Terminals

D2. Power Connectors

D3. Grounding Connectors

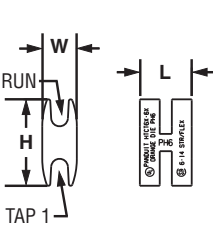

HTCT6X-6X

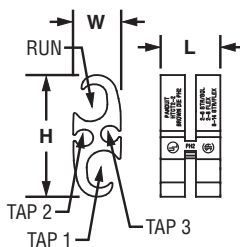

HTCT2-2

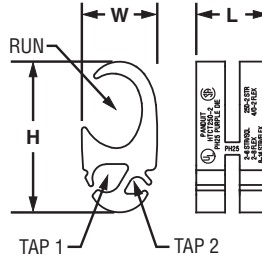

HTCT250-2

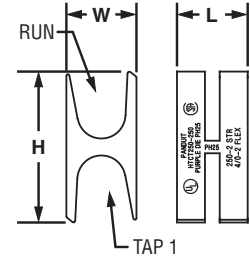

HTCT250-250

| Part Number   | Copper Conductor Size Range |                               |                               |                        |                        | Figure Dimensions<br>In. (mm) |             |             | Panduit Die Color and Die No.‡ | Wire Strip Length In. (mm) | Std. Pkg. Qty. |               |      |                               |                               |                        |                        |             |             |             |             |            |   |      |                        |                        |                        |                        |               |      |                               |                               |                        |   |             |             |             |             |        |   |      |                        |                        |                        |   |               |      |                               |                               |   |   |             |             |             |             |
|---------------|-----------------------------|-------------------------------|-------------------------------|------------------------|------------------------|-------------------------------|-------------|-------------|--------------------------------|----------------------------|----------------|---------------|------|-------------------------------|-------------------------------|------------------------|------------------------|-------------|-------------|-------------|-------------|------------|---|------|------------------------|------------------------|------------------------|------------------------|---------------|------|-------------------------------|-------------------------------|------------------------|---|-------------|-------------|-------------|-------------|--------|---|------|------------------------|------------------------|------------------------|---|---------------|------|-------------------------------|-------------------------------|---|---|-------------|-------------|-------------|-------------|
|               | Wire Strand Type            | Run                           | Tap 1                         | Tap 2                  | Tap 3                  | L                             | W           | H           |                                |                            |                |               |      |                               |                               |                        |                        |             |             |             |             |            |   |      |                        |                        |                        |                        |               |      |                               |                               |                        |   |             |             |             |             |        |   |      |                        |                        |                        |   |               |      |                               |                               |   |   |             |             |             |             |
| HTCT6X-6X-1   | Code                        | #6 – #14 AWG (10 – 2.5)       | #6 – #14 AWG (10 – 2.5)       | —                      | —                      | 0.60 (15.2)                   | 0.40 (10.2) | 1.00 (25.4) | Orange PH6                     | 11/16 (18)                 | 1              |               |      |                               |                               |                        |                        |             |             |             |             |            |   |      |                        |                        |                        |                        |               |      |                               |                               |                        |   |             |             |             |             |        |   |      |                        |                        |                        |   |               |      |                               |                               |   |   |             |             |             |             |
|               | Flex                        | #6 – #14 AWG (10 – 2.5)       | #6 – #14 AWG (10 – 2.5)       | —                      | —                      |                               |             |             |                                |                            |                | HTCT2-2-1     | Code | #2 – #6 AWG STR/SOL (25 – 16) | #2 – #6 AWG STR/SOL (25 – 16) | #8 – #14 AWG (6 – 2.5) | #8 – #14 AWG (6 – 2.5) | 0.76 (19.3) | 0.61 (15.5) | 1.55 (39.4) | Brown PH2   | 13/16 (21) | 1 | Flex | #2 – #8 AWG (25 – 10)  | #2 – #8 AWG (25 – 10)  | #8 – #14 AWG (6 – 2.5) | #8 – #14 AWG (6 – 2.5) | HTCT250-2-1   | Code | 250 kcmil – #2 AWG (120 – 35) | #2 – #6 AWG STR/SOL (25 – 16) | #8 – #14 AWG (6 – 2.5) | — | 0.92 (23.4) | 0.96 (24.4) | 1.92 (48.8) | Purple PH25 | 1 (25) | 1 | Flex | 4/0 – #2 AWG (95 – 35) | #2 – #8 AWG (25 – 10)  | #8 – #14 AWG (6 – 2.5) | — | HTCT250-250-1 | Code | 250 kcmil – #2 AWG (120 – 35) | 250 kcmil – #2 AWG (120 – 35) | — | — | 0.90 (22.9) | 0.89 (22.6) | 1.92 (48.8) | Purple PH25 |
| HTCT2-2-1     | Code                        | #2 – #6 AWG STR/SOL (25 – 16) | #2 – #6 AWG STR/SOL (25 – 16) | #8 – #14 AWG (6 – 2.5) | #8 – #14 AWG (6 – 2.5) | 0.76 (19.3)                   | 0.61 (15.5) | 1.55 (39.4) | Brown PH2                      | 13/16 (21)                 | 1              |               |      |                               |                               |                        |                        |             |             |             |             |            |   |      |                        |                        |                        |                        |               |      |                               |                               |                        |   |             |             |             |             |        |   |      |                        |                        |                        |   |               |      |                               |                               |   |   |             |             |             |             |
|               | Flex                        | #2 – #8 AWG (25 – 10)         | #2 – #8 AWG (25 – 10)         | #8 – #14 AWG (6 – 2.5) | #8 – #14 AWG (6 – 2.5) |                               |             |             |                                |                            |                | HTCT250-2-1   | Code | 250 kcmil – #2 AWG (120 – 35) | #2 – #6 AWG STR/SOL (25 – 16) | #8 – #14 AWG (6 – 2.5) | —                      | 0.92 (23.4) | 0.96 (24.4) | 1.92 (48.8) | Purple PH25 | 1 (25)     | 1 | Flex | 4/0 – #2 AWG (95 – 35) | #2 – #8 AWG (25 – 10)  | #8 – #14 AWG (6 – 2.5) | —                      | HTCT250-250-1 | Code | 250 kcmil – #2 AWG (120 – 35) | 250 kcmil – #2 AWG (120 – 35) | —                      | — | 0.90 (22.9) | 0.89 (22.6) | 1.92 (48.8) | Purple PH25 | 1 (25) | 1 | Flex | 4/0 – #2 AWG (95 – 35) | 4/0 – #2 AWG (95 – 35) | —                      | — |               |      |                               |                               |   |   |             |             |             |             |
| HTCT250-2-1   | Code                        | 250 kcmil – #2 AWG (120 – 35) | #2 – #6 AWG STR/SOL (25 – 16) | #8 – #14 AWG (6 – 2.5) | —                      | 0.92 (23.4)                   | 0.96 (24.4) | 1.92 (48.8) | Purple PH25                    | 1 (25)                     | 1              |               |      |                               |                               |                        |                        |             |             |             |             |            |   |      |                        |                        |                        |                        |               |      |                               |                               |                        |   |             |             |             |             |        |   |      |                        |                        |                        |   |               |      |                               |                               |   |   |             |             |             |             |
|               | Flex                        | 4/0 – #2 AWG (95 – 35)        | #2 – #8 AWG (25 – 10)         | #8 – #14 AWG (6 – 2.5) | —                      |                               |             |             |                                |                            |                | HTCT250-250-1 | Code | 250 kcmil – #2 AWG (120 – 35) | 250 kcmil – #2 AWG (120 – 35) | —                      | —                      | 0.90 (22.9) | 0.89 (22.6) | 1.92 (48.8) | Purple PH25 | 1 (25)     | 1 | Flex | 4/0 – #2 AWG (95 – 35) | 4/0 – #2 AWG (95 – 35) | —                      | —                      |               |      |                               |                               |                        |   |             |             |             |             |        |   |      |                        |                        |                        |   |               |      |                               |                               |   |   |             |             |             |             |
| HTCT250-250-1 | Code                        | 250 kcmil – #2 AWG (120 – 35) | 250 kcmil – #2 AWG (120 – 35) | —                      | —                      | 0.90 (22.9)                   | 0.89 (22.6) | 1.92 (48.8) | Purple PH25                    | 1 (25)                     | 1              |               |      |                               |                               |                        |                        |             |             |             |             |            |   |      |                        |                        |                        |                        |               |      |                               |                               |                        |   |             |             |             |             |        |   |      |                        |                        |                        |   |               |      |                               |                               |   |   |             |             |             |             |
|               | Flex                        | 4/0 – #2 AWG (95 – 35)        | 4/0 – #2 AWG (95 – 35)        | —                      | —                      |                               |             |             |                                |                            |                |               |      |                               |                               |                        |                        |             |             |             |             |            |   |      |                        |                        |                        |                        |               |      |                               |                               |                        |   |             |             |             |             |        |   |      |                        |                        |                        |   |               |      |                               |                               |   |   |             |             |             |             |

‡See page D3.94 for tool and die information.

^Note: HTCT parts are UL Listed and CSA Certified with AWG wire only.

E5. Lockout/Tagout & Safety Solutions

F. Index

**UL LISTED** **CSA CERTIFIED** **Code/Flex Conductor HTAP Kit**

**Type HTWC**

- Include all components to make a complete HTAP and cover installation: HTCT HTAP, matching CLRCVR clear cover, and cable ties
- Each HTCT HTAP designed to terminate a wide range of copper code and flex conductor combinations to accommodate a variety of applications
- HTAPs incorporate a unique slotted design that allows for quick and easy installation using supplied Panduit cable ties; saves time and cost
- Matching clear covers are made from high impact plastic and provide high impact strength and 360° viewing of installed HTAP
- Clear covers have a UL 94 V-0 flame rating and an oxygen index of 28 providing self-extinguishing, flame retardant properties
- UL Listed and CSA Certified for applications up to 600 V when crimped with Panduit and specified competitor crimping tools and Panduit crimping dies<sup>^</sup>
- See page D3.33 for detailed installation instructions

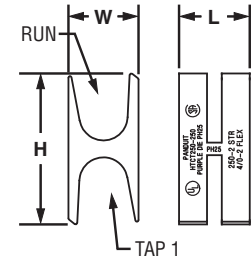
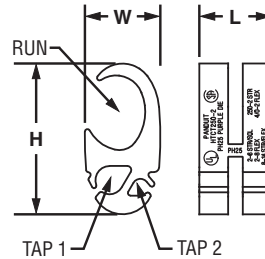
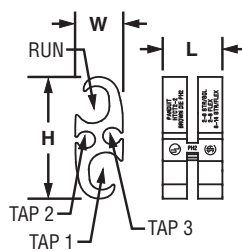
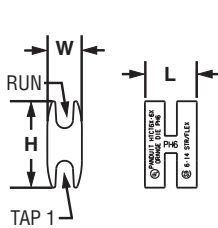
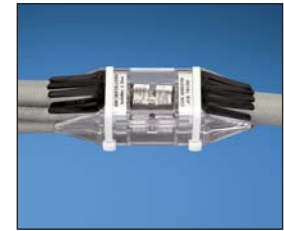

| Part Number   | Components    |                      | Wire Strand Type | Copper Conductor Size Range AWG (mm <sup>2</sup> ) |                               |                        |                        | Std. Pkg. Qty. |
|---------------|---------------|----------------------|------------------|--|-------------------------------|------------------------|------------------------|----------------|
|               | HTAP Part No. | Clear Cover Part No. |                  | Run  | Tap 1                         | Tap 2                  | Tap 3                  |                |
| HTWC6X-6X-1   | HTCT6X-6X-1   | CLRCVR1-1            | Code             | #6 – #14 AWG (10 – 2.5)                            | #6 – #14 AWG (10 – 2.5)       | —                      | —                      | 1              |
|               |               |                      | Flex             | #6 – #10 AWG (10 – 2.5)                            | #6 – #14 AWG (10 – 2.5)       | —                      | —                      |                |
| HTWC2-2-1     | HTCT2-2-1     | CLRCVR2-1            | Code             | #2 – #6 AWG STR/SOL (25 – 16)                      | #2 – #6 AWG STR/SOL (25 – 16) | #8 – #14 AWG (6 – 2.5) | #8 – #14 AWG (6 – 2.5) | 1              |
|               |               |                      | Flex             | #2 – #8 AWG (25 – 10)                              | #2 – #8 AWG (25 – 10)         | #8 – #14 AWG (6 – 2.5) | #8 – #14 AWG (6 – 2.5) |                |
| HTWC250-2-1   | HTCT250-2-1   | CLRCVR3-1            | Code             | 250 kcmil – #2 AWG (120 – 35)                      | #2 – #6 AWG STR/SOL (25 – 16) | #8 – #14 AWG (6 – 2.5) | —                      | 1              |
|               |               |                      | Flex             | 4/0 – #2 AWG (95 – 35)                             | #2 – #8 AWG (25 – 10)         | #8 – #14 AWG (6 – 2.5) | —                      |                |
| HTWC250-250-1 | HTCT250-250-1 | CLRCVR3-1            | Code             | 250 kcmil – #2 AWG (120 – 35)                      | 250 kcmil – #2 AWG (120 – 35) | —                      | —                      | 1              |
|               |               |                      | Flex             | 4/0 – #2 AWG (95 – 35)                             | 4/0 – #2 AWG (95 – 35)        | —                      | —                      |                |

See pages D3.13 – D3.14 for more information on HTAPs and clear covers, including tap sizes and locations.

<sup>^</sup>Note: HTCT parts are UL Listed and CSA Certified with AWG wire only.

A. System Overview

B1. Cable Ties

B2. Cable Accessories

B3. Stainless Steel Ties

C1. Wiring Duct

C2. Surface Raceway

C3. Abrasion Protection

C4. Cable Management

D1. Terminals

D2. Power Connectors

D3. Grounding Connectors

E1. Labeling Systems

E2. Labels

E3. Pre-Printed & Write-On Markers

E4. Permanent Identification

E5. Lockout/Tagout & Safety Solutions

F. Index



A. System Overview

B1. Cable Ties

B2. Cable Accessories

B3. Stainless Steel Ties

C1. Wiring Duct

C2. Surface Raceway

C3. Abrasion Protection

C4. Cable Management

D1. Terminals

D2. Power Connectors

D3. Grounding Connectors

E1. Labeling Systems

E2. Labels

E3. Pre-Printed & Write-On Markers

E4. Permanent Identification

E5. Lockout/Tagout & Safety Solutions

F. Index

## Features and Benefits – StructuredGround™ Mechanical Connectors

### Bronze Grounding Clamp

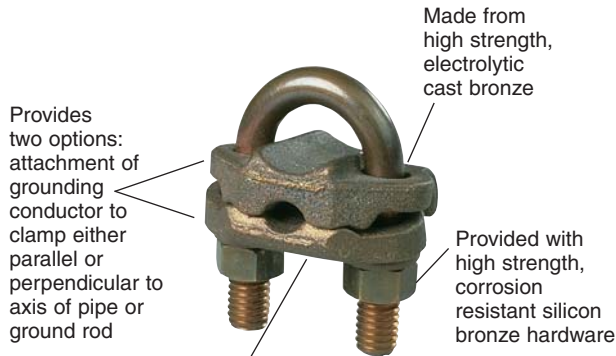

Part number, conductor range, rod and pipe size range and "DB" suitable for direct burial marked on part for easy identification



### Bronze Service Post Connector

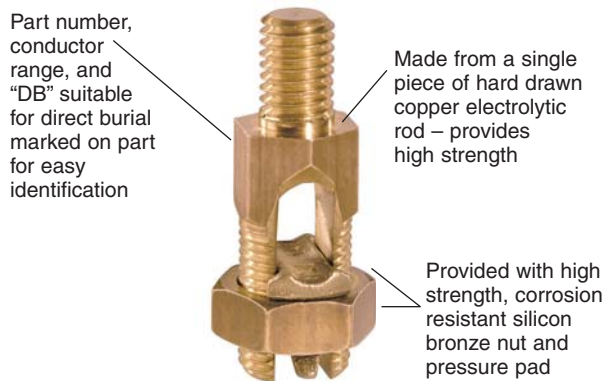

Available in configurations for use with one or two copper conductors with either a standard or long stud length



### Bronze Water Pipe Clamp

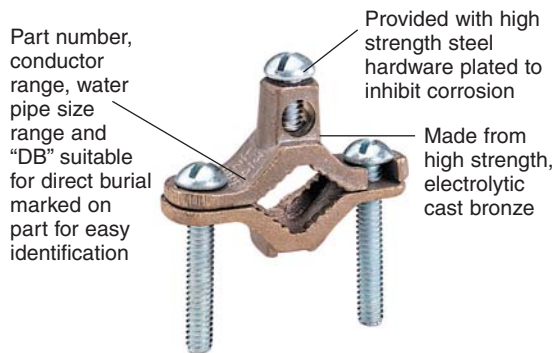

Each part accommodates a wide range of copper conductor sizes and water pipe sizes – minimizes inventory



### Bronze Grounding Clamp

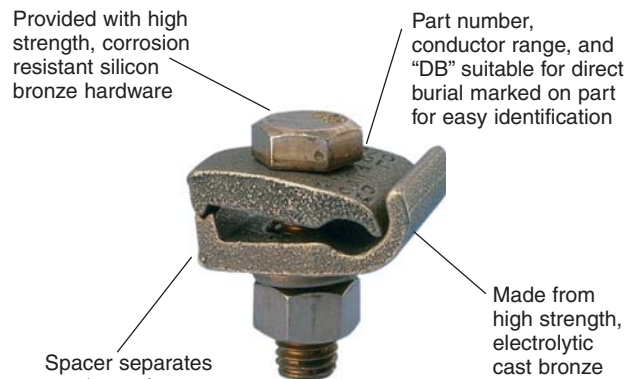



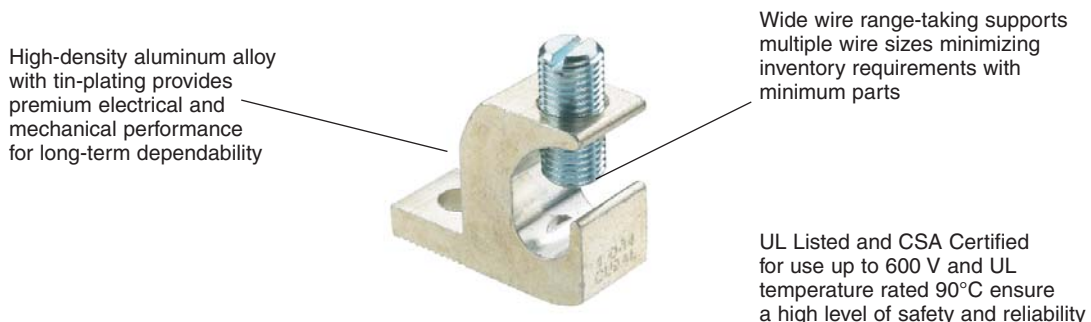

### Aluminum Lay-In Lug





## Selection Guide – StructuredGround™ Mechanical Connectors

| UL Listed Direct Burial   | Service Post Type                       | Stud Size (In.) | Thread Length (In.) | Copper Code Conductor Size |             |        |        |        |        |        |        |        |         |         |         |         |           |           |           |           |           |  |  |
|---|---|-----------------|---------------------|----------------------------|-------------|--------|--------|--------|--------|--------|--------|--------|---------|---------|---------|---------|-----------|-----------|-----------|-----------|-----------|--|--|
|   |   |                 |                     | #12 AWG                    | #10 AWG     | #8 AWG | #7 AWG | #6 AWG | #4 AWG | #3 AWG | #2 AWG | #1 AWG | 1/0 AWG | 2/0 AWG | 3/0 AWG | 4/0 AWG | 250 kcmil | 300 kcmil | 350 kcmil | 400 kcmil | 500 kcmil |  |  |
|   |   |                 |                     | Panduit Part Number        |             |        |        |        |        |        |        |        |         |         |         |         |           |           |           |           |           |  |  |
|    | Bronze Service Post One Conductor SP1   | 1/4-20          | 1/2                 | SP1-8-C*                   |             |        |        |        |        |        |        |        |         |         |         |         |           |           |           |           |           |  |  |
|   |   |                 | 1                   | SP1-8L-C*                  |             |        |        |        |        |        |        |        |         |         |         |         |           |           |           |           |           |  |  |
|   |   | 1/4-20          | 1/2                 |                            | SP1-7-C*    |        |        |        |        |        |        |        |         |         |         |         |           |           |           |           |           |  |  |
|   |   |                 | 1                   |                            | SP1-7L-C*   |        |        |        |        |        |        |        |         |         |         |         |           |           |           |           |           |  |  |
|   |   | 5/16-18         | 9/16                | SP1-4-C*                   |             |        |        |        |        |        |        |        |         |         |         |         |           |           |           |           |           |  |  |
|   |   |                 | 1                   | SP1-4L-C*                  |             |        |        |        |        |        |        |        |         |         |         |         |           |           |           |           |           |  |  |
|   |   | 3/8-16          | 5/8                 | SP1-3-C*                   |             |        |        |        |        |        |        |        |         |         |         |         |           |           |           |           |           |  |  |
|   |   |                 | 1 1/8               | SP1-3L-C*                  |             |        |        |        |        |        |        |        |         |         |         |         |           |           |           |           |           |  |  |
|   |   |                 | 5/8                 | SP1-2-C                    |             |        |        |        |        |        |        |        |         |         |         |         |           |           |           |           |           |  |  |
|   |   | 1/2-13          | 1 1/8               | SP1-2L-C                   |             |        |        |        |        |        |        |        |         |         |         |         |           |           |           |           |           |  |  |
|   |   |                 | 3/4                 | SP1-1/0-L*                 |             |        |        |        |        |        |        |        |         |         |         |         |           |           |           |           |           |  |  |
|   |   |                 | 1 1/4               | SP1-1/0L-L*                |             |        |        |        |        |        |        |        |         |         |         |         |           |           |           |           |           |  |  |
|   |   |                 | 3/4                 | SP1-2/0-Q*                 |             |        |        |        |        |        |        |        |         |         |         |         |           |           |           |           |           |  |  |
|   |   | 5/8-11          | 1 1/4               | SP1-2/0L-Q*                |             |        |        |        |        |        |        |        |         |         |         |         |           |           |           |           |           |  |  |
|   |   |                 | 1                   |                            | SP1-4/0-Q*  |        |        |        |        |        |        |        |         |         |         |         |           |           |           |           |           |  |  |
|   |   |                 | 1 1/2               |                            | SP1-4/0L-Q* |        |        |        |        |        |        |        |         |         |         |         |           |           |           |           |           |  |  |
|   |   |                 | 1                   |                            | SP1-350-12  |        |        |        |        |        |        |        |         |         |         |         |           |           |           |           |           |  |  |
|   |   | 3/4-10          | 1 1/2               | SP1-350L-12                |             |        |        |        |        |        |        |        |         |         |         |         |           |           |           |           |           |  |  |
| 1 3/8   | SP1-500-12                              |                 |                     |                            |             |        |        |        |        |        |        |        |         |         |         |         |           |           |           |           |           |  |  |
| 1 3/4   | SP1-500L-12                             |                 |                     |                            |             |        |        |        |        |        |        |        |         |         |         |         |           |           |           |           |           |  |  |
|  | Bronze Service Post Two Conductors SP2  | 1/4-20          | 1/2                 | SP2-8-C*                   |             |        |        |        |        |        |        |        |         |         |         |         |           |           |           |           |           |  |  |
|   |   |                 | 1                   | SP2-8L-C*                  |             |        |        |        |        |        |        |        |         |         |         |         |           |           |           |           |           |  |  |
|   |   | 1/4-20          | 1/2                 | SP2-7-C*                   |             |        |        |        |        |        |        |        |         |         |         |         |           |           |           |           |           |  |  |
|   |   |                 | 1                   | SP2-7L-C*                  |             |        |        |        |        |        |        |        |         |         |         |         |           |           |           |           |           |  |  |
|   |   | 5/16-18         | 9/16                | SP2-4-C*                   |             |        |        |        |        |        |        |        |         |         |         |         |           |           |           |           |           |  |  |
|   |   |                 | 1                   | SP2-4L-C*                  |             |        |        |        |        |        |        |        |         |         |         |         |           |           |           |           |           |  |  |
|   |   | 3/8-16          | 5/8                 | SP2-3-C*                   |             |        |        |        |        |        |        |        |         |         |         |         |           |           |           |           |           |  |  |
|   |   |                 | 1 1/8               | SP2-3L-C*                  |             |        |        |        |        |        |        |        |         |         |         |         |           |           |           |           |           |  |  |
|   |   |                 | 5/8                 | SP2-2-C*                   |             |        |        |        |        |        |        |        |         |         |         |         |           |           |           |           |           |  |  |
|   |   | 1/2-13          | 1 1/8               | SP2-2L-C*                  |             |        |        |        |        |        |        |        |         |         |         |         |           |           |           |           |           |  |  |
|   |   |                 | 3/4                 | SP2-1/0-L*                 |             |        |        |        |        |        |        |        |         |         |         |         |           |           |           |           |           |  |  |
|   |   |                 | 1 1/4               | SP2-1/0L-L*                |             |        |        |        |        |        |        |        |         |         |         |         |           |           |           |           |           |  |  |
|   |   |                 | 3/4                 | SP2-2/0-Q*                 |             |        |        |        |        |        |        |        |         |         |         |         |           |           |           |           |           |  |  |
|   |   | 5/8-11          | 1 1/4               | SP2-2/0L-Q*                |             |        |        |        |        |        |        |        |         |         |         |         |           |           |           |           |           |  |  |
|   |   |                 | 1                   | SP2-4/0-Q*                 |             |        |        |        |        |        |        |        |         |         |         |         |           |           |           |           |           |  |  |
|   |   |                 | 1 1/2               | SP2-4/0L-Q*                |             |        |        |        |        |        |        |        |         |         |         |         |           |           |           |           |           |  |  |
|   |   |                 | 1                   | SP2-350-12                 |             |        |        |        |        |        |        |        |         |         |         |         |           |           |           |           |           |  |  |
|   |   | 3/4-10          | 1 1/2               | SP2-350L-12                |             |        |        |        |        |        |        |        |         |         |         |         |           |           |           |           |           |  |  |
| 1 3/8   | SP2-500-12                              |                 |                     |                            |             |        |        |        |        |        |        |        |         |         |         |         |           |           |           |           |           |  |  |
| 1 3/4   | SP2-500L-12                             |                 |                     |                            |             |        |        |        |        |        |        |        |         |         |         |         |           |           |           |           |           |  |  |
|  | Bronze Service Post One Conductor SPF1  | 1/4-20          | 1/4                 | SPF1-8-C*                  |             |        |        |        |        |        |        |        |         |         |         |         |           |           |           |           |           |  |  |
|   |   | 5/16-18         | 5/16                | SPF1-7-C*                  |             |        |        |        |        |        |        |        |         |         |         |         |           |           |           |           |           |  |  |
|   |   | 3/8-16          | 3/8                 | SPF1-4-C*                  |             |        |        |        |        |        |        |        |         |         |         |         |           |           |           |           |           |  |  |
|   |   | 1/2-13          | 7/16                | SPF1-3-C                   |             |        |        |        |        |        |        |        |         |         |         |         |           |           |           |           |           |  |  |
|   |   |                 | 1/2                 | SPF1-2-C                   |             |        |        |        |        |        |        |        |         |         |         |         |           |           |           |           |           |  |  |
|   |   | 5/8-11          | 5/8                 | SPF1-1/0-L*                |             |        |        |        |        |        |        |        |         |         |         |         |           |           |           |           |           |  |  |
|   |   | 3/4-10          | 3/4                 | SPF1-2/0-Q*                |             |        |        |        |        |        |        |        |         |         |         |         |           |           |           |           |           |  |  |
| 5/8-11  | 5/8                                     | SPF1-4/0-Q      |                     |                            |             |        |        |        |        |        |        |        |         |         |         |         |           |           |           |           |           |  |  |
|   | 3/4-10                                  | 3/4             | SPF1-350-12         |                            |             |        |        |        |        |        |        |        |         |         |         |         |           |           |           |           |           |  |  |
|   | 3/4-10                                  | 3/4             | SPF1-500-12         |                            |             |        |        |        |        |        |        |        |         |         |         |         |           |           |           |           |           |  |  |
|  | Bronze Service Post Two Conductors SPF2 | 1/4-20          | 1/4                 | SPF2-8-C*                  |             |        |        |        |        |        |        |        |         |         |         |         |           |           |           |           |           |  |  |
|   |   | 5/16-18         | 5/16                | SPF2-7-C*                  |             |        |        |        |        |        |        |        |         |         |         |         |           |           |           |           |           |  |  |
|   |   | 3/8-16          | 3/8                 | SPF2-4-C*                  |             |        |        |        |        |        |        |        |         |         |         |         |           |           |           |           |           |  |  |
|   |   | 1/2-13          | 7/16                | SPF2-3-C*                  |             |        |        |        |        |        |        |        |         |         |         |         |           |           |           |           |           |  |  |
|   |   |                 | 1/2                 | SPF2-2-C*                  |             |        |        |        |        |        |        |        |         |         |         |         |           |           |           |           |           |  |  |
|   |   | 5/8-11          | 5/8                 | SPF2-1/0-L*                |             |        |        |        |        |        |        |        |         |         |         |         |           |           |           |           |           |  |  |
|   |   | 3/4-10          | 5/8                 | SPF2-2/0-Q*                |             |        |        |        |        |        |        |        |         |         |         |         |           |           |           |           |           |  |  |
|   |   |                 | 3/4                 | SPF2-4/0-Q*                |             |        |        |        |        |        |        |        |         |         |         |         |           |           |           |           |           |  |  |
| 5/8-11  | 5/8                                     | SPF2-350-12     |                     |                            |             |        |        |        |        |        |        |        |         |         |         |         |           |           |           |           |           |  |  |
| 3/4-10  | 3/4                                     | SPF2-500-12     |                     |                            |             |        |        |        |        |        |        |        |         |         |         |         |           |           |           |           |           |  |  |

\*Denotes minimum conductor size is solid conductor.

For technical assistance in the U.S., call 866-405-6654 (outside the U.S., see inside back cover for directory)

A. System Overview

B1. Cable Ties

B2. Cable Accessories

B3. Stainless Steel Ties

C1. Wiring Duct

C2. Surface Raceway

C3. Abrasion Protection

C4. Cable Management

D1. Terminals

D2. Power Connectors

D3. Grounding Connectors

E1. Labeling Systems

E2. Labels











E3. Pre-Printed & Write-On Markers

E4. Permanent Identification

E5. Lockout/Tagout & Safety Solutions

F. Index

## Selection Guide – StructuredGround™ Mechanical Connectors (continued)

| A. System Overview                    | UL Listed Direct Burial  | Ground Clamp Type                     | Ground Rod Size (In.) | Pipe Size (In.) | Copper Code Conductor Size |         |         |        |        |                          |        |        |        |        |                            |         |         |         |           |           |           |           |           |  |
|---------------------------------------|--|---------------------------------------|-----------------------|-----------------|----------------------------|---------|---------|--------|--------|--------------------------|--------|--------|--------|--------|----------------------------|---------|---------|---------|-----------|-----------|-----------|-----------|-----------|--|
|                                       |  |                                       |                       |                 | #14 AWG                    | #12 AWG | #10 AWG | #8 AWG | #7 AWG | #6 AWG                   | #4 AWG | #3 AWG | #2 AWG | #1 AWG | 1/0 AWG                    | 2/0 AWG | 3/0 AWG | 4/0 AWG | 250 kcmil | 300 kcmil | 350 kcmil | 400 kcmil | 500 kcmil |  |
|                                       |  |                                       |                       |                 | Panduit Part Number        |         |         |        |        |                          |        |        |        |        |                            |         |         |         |           |           |           |           |           |  |
| B1. Cable Ties                        | <br>D3.24   | One Barrel, One-Hole LI               | —                     | —               | LI-50S-C@ #10 stud hole    |         |         |        |        | LI-112-L@ 1/4" stud hole |        |        |        |        | LI-252S-Q@ 5/16" stud hole |         |         |         |           |           |           |           |           |  |
| B2. Cable Accessories                 | <br>D3.25   | Bronze Ground Clamp One Conductor GPL | 5/8 or 3/4            | 3/8             | GPL-4-Q*                   |         |         |        |        | GPL-5-Q*                 |        |        |        |        | GPL-6-Q*                   |         |         |         |           |           |           |           |           |  |
| B3. Stainless Steel Ties              |  |                                       | 7/8 or 1              | 1/2 or 3/4      | GPL-8-Q*                   |         |         |        |        | GPL-9-Q*                 |        |        |        |        | GPL-10-Q*                  |         |         |         |           |           |           |           |           |  |
| C1. Wiring Duct                       |  |                                       | —                     | 1               | GPL-14-X*                  |         |         |        |        | GPL-15-X*                |        |        |        |        | GPL-16-X*                  |         |         |         |           |           |           |           |           |  |
| C2. Surface Raceway                   |  |                                       | —                     | 1 1/4           | GPL-20-X*                  |         |         |        |        | GPL-21-X*                |        |        |        |        | GPL-22-X*                  |         |         |         |           |           |           |           |           |  |
| C3. Abrasion Protection               |  |                                       | —                     | 1 1/2           | GPL-26-X*                  |         |         |        |        | GPL-27-X*                |        |        |        |        | GPL-28-X*                  |         |         |         |           |           |           |           |           |  |
| C4. Cable Management                  |  |                                       | —                     | 2               | GPL-32-3*                  |         |         |        |        | GPL-33-3*                |        |        |        |        | GPL-34-3*                  |         |         |         |           |           |           |           |           |  |
|                                       |  |                                       | —                     | 2 1/2           | GPL-39-3*                  |         |         |        |        | GPL-40-3*                |        |        |        |        |                            |         |         |         |           |           |           |           |           |  |
|                                       |  |                                       | —                     | 3               | GPL-44-1*                  |         |         |        |        | GPL-45-1*                |        |        |        |        | GPL-46-1*                  |         |         |         |           |           |           |           |           |  |
|                                       |  |                                       | —                     | 3 1/2           | GPL-51-1*                  |         |         |        |        | GPL-52-1*                |        |        |        |        |                            |         |         |         |           |           |           |           |           |  |
|                                       |  |                                       | —                     | 4               | GPL-57-1*                  |         |         |        |        | GPL-58-1*                |        |        |        |        |                            |         |         |         |           |           |           |           |           |  |
| D1. Terminals                         | <br>D3.26 | Bronze Ground Clamp Two Conductors GU | —                     | 1 1/4           | GU-2-X* ‡                  |         |         |        |        | GU-4-X* ‡                |        |        |        |        | GU-13-3 ‡                  |         |         |         |           |           |           |           |           |  |
| D2. Power Connectors                  | <br>D3.26 | Bronze Ground Clamp KP                | —                     | 1/2-#1          | KP1-C* @                   |         |         |        |        | KP2-L* @                 |        |        |        |        |                            |         |         |         |           |           |           |           |           |  |
| D3. Grounding Connectors              | <br>D3.27 | Bronze Ground Clamp KLS               | —                     | 1/2-1           | KLS-0-Q* ‡ 1/2" hub size   |         |         |        |        | KLS-1-Q* ‡ 3/4" hub size |        |        |        |        | KLS-1A-X* ‡ 1" hub size    |         |         |         |           |           |           |           |           |  |
| E1. Labeling Systems                  | <br>D3.27 | Bronze Ground Clamp KH                | —                     | 1/2-1           | KH-1-L* ‡ 1/2" hub size    |         |         |        |        | KH-2-L* ‡ 1/2" hub size  |        |        |        |        |                            |         |         |         |           |           |           |           |           |  |
| E2. Labels                            | <br>D3.28 | Aluminum Ground Clamp GC              | —                     | 1/2-3/4-1       | GC-15A-Q @ DR              |         |         |        |        | GC-18A-X @ DR            |        |        |        |        | GC-22A-4 @ DR              |         |         |         |           |           |           |           |           |  |
| E3. Pre-Printed & Write-On Markers    | <br>D3.28 | Bronze Ground Rod Clamp WB            | 1/2                   | —               | WB12-L*                    |         |         |        |        | WB34-X                   |        |        |        |        |                            |         |         |         |           |           |           |           |           |  |
| E4. Permanent Identification          | <br>D3.28 | Bronze Ground Rod Clamp WB            | 5/8                   | —               | WB34-X                     |         |         |        |        | WB58-Q                   |        |        |        |        |                            |         |         |         |           |           |           |           |           |  |
| E5. Lockout/Tagout & Safety Solutions | <br>D3.29 | Bronze Ground Clamp GMS               | —                     | —               | GMS-1-X*                   |         |         |        |        | GMS-2-Q*                 |        |        |        |        | GMS-3-Q*                   |         |         |         |           |           |           |           |           |  |
| F. Index                              | <br>D3.29 | Bronze Ground Clamp GM                | —                     | —               | GM-2-Q*                    |         |         |        |        | GM-3-Q*                  |        |        |        |        |                            |         |         |         |           |           |           |           |           |  |

\*Denotes minimum conductor size is solid conductor.

@Denotes not UL Listed for Direct Burial.

DR Denotes Dual Rated for use with copper or aluminum conductors.

‡Denotes not UL Listed or CSA Certified.

## Panduit Grounding Connector Approvals



| Logo (Symbol) | Agency  | Spec/Approval   | Applicable Products        |
|---------------|---|---|----------------------------|
|               | Underwriters Laboratories, Inc.                   | UL 486A<br>Wire Connectors and Soldering Lugs<br>for use in US and Canada                               | As shown on product pages. |
|               | Underwriters Laboratories, Inc.                   | UL 486A – 486B<br>Wire Connectors and Soldering Lugs<br>for use in US                                   | As shown on product pages. |
|               | Underwriters Laboratories, Inc.                   | UL 467<br>Grounding and Bonding Equipment<br>for use in US and Canada                                   | As shown on product pages. |
|               | Underwriters Laboratories, Inc.                   | UL 467<br>Grounding and Bonding Equipment<br>for use in US  | As shown on product pages. |
|               | Canadian Standards Association                    | C22.2 No. 65-03<br>Wire Connectors  | As shown on product pages. |
|               | Canadian Standards Association                    | C22.2 No. 41-M1987<br>(R1999) Grounding and Bonding Equipment   | As shown on product pages. |
|               | Institute of Electrical and Electronics Engineers | IEEE Std. 837™ - 2002<br>IEEE Standard for Qualifying Permanent Connection used in Substation Grounding | As shown on product pages. |

A.  
System Overview

B1.  
Cable Ties

B2.  
Cable Accessories

B3.  
Stainless Steel Ties

C1.  
Wiring Duct

C2.  
Surface Raceway

C3.  
Abrasion Protection

C4.  
Cable Management

D1.  
Terminals

D2.  
Power Connectors

D3.  
Grounding Connectors

E1.  
Labeling Systems

E2.  
Labels

E3.  
Pre-Printed & Write-On Markers

E4.  
Permanent Identification

E5.  
Lockout/Tagout & Safety Solutions

F.  
Index

A. System Overview

B1. Cable Ties

B2. Cable Accessories

B3. Stainless Steel Ties

C1. Wiring Duct

C2. Surface Raceway

C3. Abrasion Protection

C4. Cable Management

D1. Terminals

D2. Power Connectors

D3. Grounding Connectors

E1. Labeling Systems

E2. Labels

E3. Pre-Printed & Write-On Markers

E4. Permanent Identification

E5. Lockout/Tagout & Safety Solutions

F. Index



## Service Post Connector, Male Stud, Single Conductor, Bronze

### Type SP1

- For grounding one copper code conductor to steel structures, busbars, or transformers or for tapping from busbar with hex nut and washer
- Made from high copper content, hard drawn copper rod provides high strength
- Offered with standard and long stud lengths to accommodate a variety of mounting applications
- Wide wire range-taking capability minimizes inventory requirements
- True hex design for body and nut hex provides correct fit with socket, box, or open end wrenches resulting in proper torquing of electrical connection
- Pressure bar provides secure connection on a full range of conductor combinations used with each connector providing premium wire pull-out strength
- UL Listed for grounding and bonding and suitable for direct burial in earth or concrete

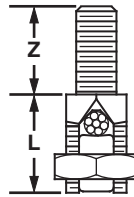

| Part Number | Conductor Size Range  | Stud Size* | Figure Dimensions In. (mm) |                | Nut Hex (In.) | Body Hex (In.) | Std. Pkg. Qty. |
|-------------|-----------------------|------------|----------------------------|----------------|---------------|----------------|----------------|
|             |                       |            | L                          | Z              |               |                |                |
| SP1-8-C     | #12 SOL – #8 STR      | 1/4 – 20   | 0.63<br>(16.0)             | 0.50<br>(12.7) | 0.50          | 0.38           | 100            |
| SP1-8L-C    |                       |            | 0.63<br>(16.0)             | 1.00<br>(25.4) |               |                |                |
| SP1-7-C     | #8 SOL – #7 STR       | 1/4 – 20   | 0.88<br>(22.4)             | 0.50<br>(12.7) | 0.69          | 0.50           | 100            |
| SP1-7L-C    |                       |            | 0.88<br>(22.4)             | 1.00<br>(25.4) |               |                |                |
| SP1-4-C     | #10 SOL – #4 STR      | 5/16 – 18  | 0.94<br>(23.9)             | 0.56<br>(14.2) | 0.75          | 0.56           | 100            |
| SP1-4L-C    |                       |            | 0.94<br>(23.9)             | 1.00<br>(25.4) |               |                |                |
| SP1-3-C     | #6 SOL – #3 STR       | 3/8 – 16   | 1.06<br>(26.9)             | 0.63<br>(16)   | 0.81          | 0.63           | 100            |
| SP1-3L-C    |                       |            | 1.06<br>(26.9)             | 1.13<br>(28.7) |               |                |                |
| SP1-2-C     | #4 STR – #2 STR       | 3/8 – 16   | 1.06<br>(26.9)             | 0.63<br>(16)   | 0.88          | 0.69           | 100            |
| SP1-2L-C    |                       |            | 1.06<br>(26.9)             | 1.13<br>(28.7) |               |                |                |
| SP1-1/0-L   | #6 SOL – 1/0 STR      | 1/2 – 13   | 1.31<br>(33.3)             | 0.75<br>(19.1) | 1.00          | 0.75           | 50             |
| SP1-1/0L-L  |                       |            | 1.31<br>(33.3)             | 1.25<br>(31.8) |               |                |                |
| SP1-2/0-Q   | #1 SOL – 2/0 STR      | 1/2 – 13   | 1.44<br>(36.6)             | 0.75<br>(19.1) | 1.13          | 0.88           | 25             |
| SP1-2/0L-Q  |                       |            | 1.44<br>(36.6)             | 1.25<br>(31.8) |               |                |                |
| SP1-4/0-Q   | 3/0 SOL – 4/0 STR     | 5/8 – 11   | 1.69<br>(42.9)             | 1.00<br>(25.4) | 1.38          | 1.13           | 25             |
| SP1-4/0L-Q  |                       |            | 1.69<br>(42.9)             | 1.50<br>(38.1) |               |                |                |
| SP1-350-12  | 4/0 STR – 350 kcmil   | 5/8 – 11   | 2.00<br>(50.8)             | 1.00<br>(25.4) | 1.50          | 1.25           | 12             |
| SP1-350L-12 |                       |            | 2.00<br>(50.8)             | 1.50<br>(38.1) |               |                |                |
| SP1-500-12  | 250 kcmil – 500 kcmil | 3/4 – 10   | 2.31<br>(58.7)             | 1.38<br>(35.1) | 1.81          | 1.50           | 12             |
| SP1-500L-12 |                       |            | 2.31<br>(58.7)             | 1.75<br>(44.5) |               |                |                |

\*UNC threads.



## Service Post Connector, Male Stud, Two Conductor, Bronze

### Type SP2

- For grounding two copper code conductors to steel structures, busbars, or transformers or for tapping from busbar with hex nut and washer
- Made from high copper content, hard drawn copper rod provides high strength
- Offered with standard and long stud lengths to accommodate a variety of mounting applications
- Wide wire range-taking capability minimizes inventory requirements
- True hex design for body and nut hex provides correct fit with socket, box, or open end wrenches resulting in proper torquing of electrical connection
- Pressure bar provides secure connection on a full range of conductor combinations used with each connector providing premium wire pull-out strength
- UL Listed for grounding and bonding and suitable for direct burial in earth or concrete

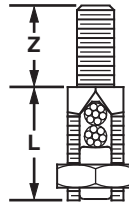

| Part Number | Conductor Size Range | Stud Size* | Figure Dimensions In. (mm) |                | Nut Hex (In.) | Body Hex (In.) | Std. Pkg. Qty. |
|-------------|----------------------|------------|----------------------------|----------------|---------------|----------------|----------------|
|             |                      |            | L                          | Z              |               |                |                |
| SP2-8-C     | #12 SOL – #8 STR     | 1/4 – 20   | 0.75<br>(19.0)             | 0.50<br>(12.7) | 0.50          | 0.38           | 100            |
| SP2-8L-C    |                      |            | 0.75<br>(19.0)             | 1.00<br>(25.4) |               |                |                |
| SP2-7-C     | #10 SOL – #7 STR     | 1/4 – 20   | 1.00<br>(25.4)             | 0.50<br>(12.7) | 0.69          | 0.50           | 100            |
| SP2-7L-C    |                      |            | 1.00<br>(25.4)             | 1.00<br>(25.4) |               |                |                |
| SP2-4-C     | #10 SOL – #4 STR     | 5/16 – 18  | 1.16<br>(29.5)             | 0.56<br>(14.2) | 0.75          | 0.56           | 100            |
| SP2-4L-C    |                      |            | 1.16<br>(29.5)             | 1.00<br>(25.4) |               |                |                |
| SP2-3-C     | #10 SOL – #3 STR     | 3/8 – 16   | 1.09<br>(27.7)             | 0.63<br>(16)   | 0.81          | 0.63           | 100            |
| SP2-3L-C    |                      |            | 1.09<br>(27.7)             | 1.13<br>(28.7) |               |                |                |
| SP2-2-C     | #10 SOL – #2 STR     | 3/8 – 16   | 1.38<br>(35.1)             | 0.63<br>(16)   | 0.88          | 0.69           | 100            |
| SP2-2L-C    |                      |            | 1.28<br>(32.5)             | 1.13<br>(28.7) |               |                |                |
| SP2-1/0-L   | #2 SOL – 1/0 STR     | 1/2 – 13   | 1.69<br>(42.9)             | 0.75<br>(19.1) | 1.00          | 0.75           | 50             |
| SP2-1/0L-L  |                      |            | 1.69<br>(42.9)             | 1.25<br>(31.8) |               |                |                |
| SP2-2/0-Q   | #2 SOL – 2/0 STR     | 1/2 – 13   | 1.88<br>(47.8)             | 0.75<br>(19.1) | 1.13          | 0.88           | 25             |
| SP2-2/0L-Q  |                      |            | 1.88<br>(47.8)             | 1.25<br>(31.8) |               |                |                |
| SP2-4/0-Q   | #1 SOL – 4/0 STR     | 5/8 – 11   | 2.25<br>(57.2)             | 1.00<br>(25.4) | 1.38          | 1.13           | 25             |
| SP2-4/0L-Q  |                      |            | 2.25<br>(57.2)             | 1.50<br>(38.1) |               |                |                |
| SP2-350-12  | #1 STR – 350 kcmil   | 5/8 – 11   | 2.69<br>(68.3)             | 1.00<br>(25.4) | 1.50          | 1.25           | 12             |
| SP2-350L-12 |                      |            | 2.69<br>(68.3)             | 1.50<br>(38.1) |               |                |                |
| SP2-500-12  | 3/0 STR – 500 kcmil  | 3/4 – 10   | 3.19<br>(81.0)             | 1.38<br>(35.1) | 1.81          | 1.50           | 12             |
| SP2-500L-12 |                      |            | 3.19<br>(81.0)             | 1.75<br>(44.5) |               |                |                |

\*UNC threads.

A. System Overview

B1. Cable Ties

B2. Cable Accessories

B3. Stainless Steel Ties

C1. Wiring Duct

C2. Surface Raceway

C3. Abrasion Protection

C4. Cable Management

D1. Terminals

D2. Power Connectors

D3. Grounding Connectors

E1. Labeling Systems

E2. Labels

E3. Pre-Printed & Write-On Markers

E4. Permanent Identification

E5. Lockout/Tagout & Safety Solutions

F. Index

A. System Overview

B1. Cable Ties

B2. Cable Accessories

B3. Stainless Steel Ties

C1. Wiring Duct

C2. Surface Raceway

C3. Abrasion Protection

C4. Cable Management

D1. Terminals

D2. Power Connectors

D3. Grounding Connectors

E1. Labeling Systems

E2. Labels

E3. Pre-Printed & Write-On Markers

E4. Permanent Identification

E5. Lockout/Tagout & Safety Solutions

F. Index

**UL LISTED** **Service Post Connector, Female Thread, Single Conductor, Bronze**

**Type SPF1**

- For grounding one copper code conductor to steel structures, busbars, or transformers or for tapping from busbar using external studs, screws, or bolts
- Made from high copper content, hard drawn copper rod provides high strength
- Wide wire range-taking capability minimizes inventory requirements
- True hex design for body and nut hex provides correct fit with socket, box, or open end wrenches resulting in proper torquing of electrical connection
- Pressure bar provides secure connection on a full range of conductor combinations used with each connector providing premium wire pull-out strength
- UL Listed for grounding and bonding and suitable for direct burial in earth or concrete

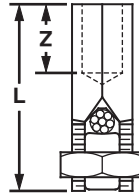

| Part Number        | Conductor Size Range  | Thread Size* | Figure Dimensions In. (mm) |                | Nut Hex (In.) | Body Hex (In.) | Std. Pkg. Qty. |
|--------------------|-----------------------|--------------|----------------------------|----------------|---------------|----------------|----------------|
|                    |                       |              | L                          | Z              |               |                |                |
| <b>SPF1-8-C</b>    | #12 SOL – #8 STR      | 1/4 – 20     | 0.91<br>(23.1)             | 0.25<br>(6.4)  | 0.50          | 0.38           | 100            |
| <b>SPF1-7-C</b>    | #10 SOL – #7 STR      | 1/4 – 20     | 1.13<br>(28.7)             | 0.25<br>(6.4)  | 0.69          | 0.50           | 100            |
| <b>SPF1-4-C</b>    | #8 SOL – #4 STR       | 5/16 – 18    | 1.44<br>(36.6)             | 0.31<br>(7.9)  | 0.75          | 0.56           | 100            |
| <b>SPF1-3-C</b>    | #6 STR – #3 STR       | 3/8 – 16     | 1.50<br>(38.1)             | 0.38<br>(9.7)  | 0.81          | 0.63           | 100            |
| <b>SPF1-2-C</b>    | #6 STR – #2 STR       | 3/8 – 16     | 1.63<br>(41.4)             | 0.38<br>(9.7)  | 0.88          | 0.69           | 100            |
| <b>SPF1-1/0-L</b>  | #2 SOL – 1/0 STR      | 1/2 – 13     | 1.88<br>(47.8)             | 0.44<br>(11.2) | 1.00          | 0.75           | 50             |
| <b>SPF1-2/0-Q</b>  | #1 SOL – 2/0 STR      | 1/2 – 13     | 2.06<br>(52.3)             | 0.50<br>(12.7) | 1.13          | 0.88           | 25             |
| <b>SPF1-4/0-Q</b>  | 1/0 STR – 4/0 STR     | 5/8 – 11     | 2.38<br>(60.5)             | 0.63<br>(16)   | 1.38          | 1.13           | 25             |
| <b>SPF1-350-12</b> | 4/0 STR – 350 kcmil   | 5/8 – 11     | 2.63<br>(66.8)             | 0.63<br>(16)   | 1.50          | 1.25           | 12             |
| <b>SPF1-500-12</b> | 300 kcmil – 500 kcmil | 3/4 – 10     | 3.13<br>(79.5)             | 0.75<br>(19.1) | 1.81          | 1.50           | 12             |

\*UNC threads.





## Service Post Connector, Female Thread, Two Conductor, Bronze

### Type SPF2

- For grounding two copper code conductors to steel structures, busbars, or transformers or for tapping from busbar using external threaded studs, screws, or bolts
- Made from high copper content, hard drawn copper rod provides high strength
- Wide wire range-taking capability minimizes inventory requirements
- True hex design for body and nut hex provides correct fit with socket, box, or open end wrenches resulting in proper torquing of electrical connection
- Pressure bar provides secure connection on a full range of conductor combinations used with each connector providing premium wire pull-out strength
- UL Listed for grounding and bonding and suitable for direct burial in earth or concrete



| Part Number | Conductor Size Range | Thread Size* | Figure Dimensions In. (mm) |                | Nut Hex (In.) | Body Hex (In.) | Std. Pkg. Qty. |
|-------------|----------------------|--------------|----------------------------|----------------|---------------|----------------|----------------|
|             |                      |              | L                          | Z              |               |                |                |
| SPF2-8-C    | #12 SOL – #8 STR     | 1/4 – 20     | 1.13<br>(28.7)             | 0.25<br>(6.4)  | 0.50          | 0.38           | 100            |
| SPF2-7-C    | #10 SOL – #7 STR     | 1/4 – 20     | 1.44<br>(36.6)             | 0.25<br>(6.4)  | 0.69          | 0.50           | 100            |
| SPF2-4-C    | #10 SOL – #4 STR     | 5/16 – 18    | 1.56<br>(39.6)             | 0.31<br>(7.9)  | 0.75          | 0.56           | 100            |
| SPF2-3-C    | #10 SOL – #3 STR     | 3/8 – 16     | 1.63<br>(41.4)             | 0.38<br>(9.7)  | 0.81          | 0.63           | 100            |
| SPF2-2-C    | #10 SOL – #2 STR     | 3/8 – 16     | 1.94<br>(49.3)             | 0.38<br>(9.7)  | 0.88          | 0.69           | 100            |
| SPF2-1/0-L  | #2 SOL – 1/0 STR     | 1/2 – 13     | 2.13<br>(54.1)             | 0.44<br>(11.2) | 1.00          | 0.75           | 50             |
| SPF2-2/0-Q  | #2 SOL – 2/0 STR     | 1/2 – 13     | 2.31<br>(58.7)             | 0.50<br>(12.7) | 1.13          | 0.88           | 25             |
| SPF2-4/0-Q  | #1 SOL – 4/0 STR     | 5/8 – 11     | 2.50<br>(63.5)             | 0.63<br>(16)   | 1.38          | 1.13           | 25             |
| SPF2-350-12 | #1 STR – 350 kcmil   | 5/8 – 11     | 2.69<br>(68.3)             | 0.63<br>(16)   | 1.50          | 1.25           | 12             |
| SPF2-500-12 | 3/0 STR – 500 kcmil  | 3/4 – 10     | 3.31<br>(84.1)             | 0.75<br>(19.1) | 1.81          | 1.50           | 12             |

\*UNC threads.

A.  
System  
Overview

B1.  
Cable Ties

B2.  
Cable  
Accessories

B3.  
Stainless  
Steel Ties

C1.  
Wiring  
Duct

C2.  
Surface  
Raceway

C3.  
Abrasion  
Protection

C4.  
Cable  
Management

D1.  
Terminals

D2.  
Power  
Connectors

D3.  
Grounding  
Connectors

E1.  
Labeling  
Systems

E2.  
Labels

E3.  
Pre-Printed  
& Write-On  
Markers

E4.  
Permanent  
Identification

E5.  
Lockout/  
Tagout  
& Safety  
Solutions

F.  
Index

A. System Overview



## One-Hole Aluminum Lay-In Lug

B1. Cable Ties

### Type LI

B2. Cable Accessories

- Used for quick installation of a continuous grounding conductor
- Made from high strength, extruded aluminum alloy to provide premium electrical and mechanical performance
- Tin-plated to inhibit corrosion
- Wide wire range-taking capability minimizes inventory requirements
- UL Listed and CSA Certified for use up to 600 V and UL temperature rated 90°C

B3. Stainless Steel Ties

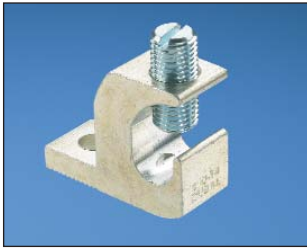

C1. Wiring Duct



C2. Surface Raceway

C3. Abrasion Protection

| Part Number | Conductor Size Range | Stud Hole Size (In.) | Hex Key Size (In.) | Figure Dimensions In. (mm) |                |                | Std. Pkg. Qty. |
|-------------|----------------------|----------------------|--------------------|----------------------------|----------------|----------------|----------------|
|             |                      |                      |                    | L                          | W              | H              |                |
| LI-50S-C    | #14 – #4 AWG         | 0.22                 | **                 | 1.07<br>(27.2)             | 0.38<br>(9.7)  | 0.78<br>(19.8) | 100            |
| LI-112S-L   | #14 – 1/0 AWG        | 0.27                 | **                 | 1.50<br>(38.1)             | 0.60<br>(15.2) | 1.17<br>(29.7) | 50             |
| LI-252S-Q   | #6 AWG – 250 kcmil   | 0.33                 | 9/16               | 2.20<br>(55.9)             | 0.80<br>(20.3) | 1.79<br>(45.5) | 25             |

C4. Cable Management

The use of Panduit oxide inhibiting joint compound (CMP) is recommended for pad to pad and conductor connections. See below.  
\*\*Uses slotted head set screw.

D1. Terminals

## Joint Compounds

D2. Power Connectors

### Type CMP

- Oxide inhibitor for compression conductor connections lowers electrical resistance of compression joint while sealing out air and moisture to prevent the formation of surface oxides
- Wide operating temperature range; can be used in a wide range of electrical and environmental conditions
- Packaged in convenient dispenser bottles

D3. Grounding Connectors



E1. Labeling Systems

E2. Labels

E3. Pre-Printed & Write-On Markers

E4. Permanent Identification

E5. Lockout/Tagout & Safety Solutions

F. Index

| Part Number        | Part Description   | Std. Pkg. Qty. |
|--------------------|--|----------------|
| <b>CMP-100-1</b>   | Contact aid for pad-to-pad or thread-to-thread aluminum connections, 8 oz. Operating temperature range -60°F (-51°C) to 400°F (204°C).   | 1              |
| <b>CMP-200-1</b>   | Contact aid for cable connections with compression connections made on aluminum conductor, 8 oz. Operating temperature range -40°F (-40°C) to 400°F (204°C). Compatible with all insulating materials.                             | 1              |
| <b>CMP-300-1</b>   | Contact aid for copper-to-copper and copper-to-steel connections, 8 oz. Operating temperature range -40°F (-40°C) to 350°F (177°C). Good for all voltages and suitable for grounding. Also used for anti-seizing thread lubricant. | 1              |
| <b>CMP-300-4-1</b> | Contact aid for copper-to-copper and copper-to-steel connections, 4 oz. Operating temperature range -40°F (-40°C) to 350°F (177°C). Good for all voltages and suitable for grounding. Also used for anti-seizing thread lubricant. | 1              |

**UL** LISTED **US** Grounding Clamp, U-Bolt, Bronze

**Type GPL**

- Used to ground copper conductor parallel or at a right angle to a rod, tube, or pipe
- Made from high strength, electrolytic cast bronze
- High strength silicon bronze hardware provides long term reliable assembly
- Accommodates a wide range of pipe, tube, rod and conductor sizes – minimizes inventory requirements
- UL Listed for grounding and bonding and suitable for direct burial in earth or concrete

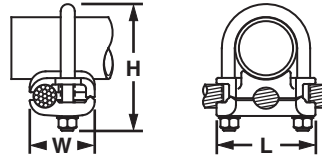

| Part Number | Ground Rod Size (In.) | Iron Pipe Size (In.) | Conductor Size Range | Figure Dimensions In. (mm) |             |              | Bolt Dia. (In.) | Hex Size (In.) | Std. Pkg. Qty. |
|-------------|-----------------------|----------------------|----------------------|----------------------------|-------------|--------------|-----------------|----------------|----------------|
|             |                       |                      |                      | L                          | W           | H            |                 |                |                |
| GPL-4-Q     | 5/8 or 3/4            | 3/8                  | #8 SOL – #4 STR      | 2.00 (50.8)                | 1.38 (35.1) | 2.75 (69.9)  | 3/8             | 9/16           | 25             |
| GPL-5-Q     | 5/8 or 3/4            | 3/8                  | #4 SOL – 2/0 STR     | 2.00 (50.8)                | 1.63 (41.4) | 2.75 (69.9)  | 3/8             | 9/16           | 25             |
| GPL-6-Q     | 5/8 or 3/4            | 3/8                  | 2/0 SOL – 250 kcmil  | 2.00 (50.8)                | 1.88 (47.8) | 2.75 (69.9)  | 3/8             | 9/16           | 25             |
| GPL-8-Q     | 7/8 or 1              | 1/2 or 3/4           | #8 SOL – #4 STR      | 2.38 (60.5)                | 1.38 (35.1) | 2.63 (66.8)  | 3/8             | 9/16           | 25             |
| GPL-9-Q     | 7/8 or 1              | 1/2 or 3/4           | #4 SOL – 2/0 STR     | 2.38 (60.5)                | 1.63 (41.4) | 2.63 (66.8)  | 3/8             | 9/16           | 25             |
| GPL-10-Q    | 7/8 or 1              | 1/2 or 3/4           | 2/0 SOL – 250 kcmil  | 2.38 (60.5)                | 1.88 (47.8) | 3.00 (76.2)  | 3/8             | 9/16           | 25             |
| GPL-14-X    | —                     | 1                    | #8 SOL – #4 STR      | 2.63 (66.8)                | 1.38 (35.1) | 2.75 (69.9)  | 3/8             | 9/16           | 10             |
| GPL-15-X    | —                     | 1                    | #4 SOL – 2/0 STR     | 2.63 (66.8)                | 1.63 (41.4) | 2.75 (69.9)  | 3/8             | 9/16           | 10             |
| GPL-16-X    | —                     | 1                    | 2/0 SOL – 250 kcmil  | 2.63 (66.8)                | 1.88 (47.8) | 3.25 (82)    | 3/8             | 9/16           | 10             |
| GPL-20-X    | —                     | 1 1/4                | #8 SOL – #4 STR      | 3.00 (76.2)                | 1.38 (35.1) | 3.50 (88.9)  | 3/8             | 9/16           | 10             |
| GPL-21-X    | —                     | 1 1/4                | #4 SOL – 2/0 STR     | 3.00 (76.2)                | 1.63 (41.4) | 3.50 (88.9)  | 3/8             | 9/16           | 10             |
| GPL-22-X    | —                     | 1 1/4                | 2/0 SOL – 250 kcmil  | 3.00 (76.2)                | 1.88 (47.8) | 3.50 (88.9)  | 3/8             | 9/16           | 10             |
| GPL-26-X    | —                     | 1 1/2                | #8 SOL – #4 STR      | 3.25 (82.6)                | 1.38 (35.1) | 4.00 (101.6) | 3/8             | 9/16           | 10             |
| GPL-27-X    | —                     | 1 1/2                | #4 SOL – 2/0 STR     | 3.25 (82.6)                | 1.63 (41.4) | 4.00 (101.6) | 3/8             | 9/16           | 10             |
| GPL-28-X    | —                     | 1 1/2                | 2/0 SOL – 250 kcmil  | 3.25 (82.6)                | 1.88 (47.8) | 4.00 (101.6) | 3/8             | 9/16           | 10             |
| GPL-32-3    | —                     | 2                    | #8 SOL – #4 STR      | 3.75 (95.3)                | 1.38 (35.1) | 4.25 (107.9) | 3/8             | 9/16           | 3              |
| GPL-33-3    | —                     | 2                    | #4 SOL – 2/0 STR     | 3.75 (95.3)                | 1.63 (41.4) | 4.25 (107.9) | 3/8             | 9/16           | 3              |
| GPL-34-3    | —                     | 2                    | 2/0 SOL – 250 kcmil  | 3.75 (95.3)                | 1.88 (47.8) | 4.25 (107.9) | 3/8             | 9/16           | 3              |
| GPL-39-3    | —                     | 2 1/2                | #4 SOL – 2/0 STR     | 4.25 (107.9)               | 1.63 (41.4) | 5.00 (127)   | 3/8             | 9/16           | 3              |
| GPL-40-3    | —                     | 2 1/2                | 2/0 SOL – 250 kcmil  | 4.25 (107.9)               | 1.88 (47.8) | 5.00 (127)   | 3/8             | 9/16           | 3              |
| GPL-44-1    | —                     | 3                    | #8 SOL – #4 STR      | 4.75 (120.6)               | 1.38 (35.1) | 5.50 (140)   | 3/8             | 9/16           | 1              |
| GPL-45-1    | —                     | 3                    | #4 SOL – 2/0 STR     | 4.75 (120.6)               | 1.63 (41.4) | 5.50 (139.7) | 3/8             | 9/16           | 1              |
| GPL-46-1    | —                     | 3                    | 2/0 SOL – 250 kcmil  | 4.75 (120.6)               | 1.88 (47.8) | 5.50 (139.7) | 3/8             | 9/16           | 1              |
| GPL-51-1    | —                     | 3 1/2                | #4 SOL – 2/0 STR     | 5.25 (133.4)               | 1.63 (41.4) | 6.25 (158.8) | 3/8             | 9/16           | 1              |
| GPL-52-1    | —                     | 3 1/2                | 2/0 SOL – 250 kcmil  | 5.25 (133.4)               | 1.88 (47.8) | 6.25 (158)   | 3/8             | 9/16           | 1              |
| GPL-57-1    | —                     | 4                    | #4 SOL – 2/0 STR     | 5.75 (146.0)               | 1.63 (41.4) | 6.38 (162.1) | 3/8             | 9/16           | 1              |
| GPL-58-1    | —                     | 4                    | 2/0 SOL – 250 kcmil  | 5.75 (146.0)               | 1.88 (47.8) | 6.38 (162.1) | 3/8             | 9/16           | 1              |
| GPL-75-X    | —                     | 6                    | #4 SOL – 2/0 STR     | 7.88 (200.2)               | 1.58 (40.1) | 7.85 (199.4) | 3/8             | 1 1/4          | 10             |

A. System Overview

B1. Cable Ties

B2. Cable Accessories

B3. Stainless Steel Ties

C1. Wiring Duct

C2. Surface Raceway

C3. Abrasion Protection

C4. Cable Management

D1. Terminals

D2. Power Connectors

D3. Grounding Connectors

E1. Labeling Systems

E2. Labels

E3. Pre-Printed & Write-On Markers

E4. Permanent Identification

E5. Lockout/Tagout & Safety Solutions

F. Index

**UL LISTED** Grounding Clamp, U-Bolt, for Two Cables, Bronze

**Type GU**

- Used to ground two copper code conductors parallel to a rod, tube, or pipe
- Made from high strength, electrolytic cast bronze
- High strength silicon bronze hardware provides long term reliable assembly
- Accommodates a wide range of pipe, tube, rod and conductor sizes – minimizes inventory requirements
- UL Listed for grounding and bonding and suitable for direct burial in earth or concrete

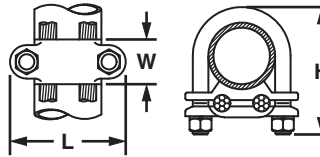

| Part Number    | Iron Pipe Size (In.) | Conductor Size Range  | Figure Dimensions In. (mm) |             |              | Bolt Dia. (In.) | Hex Size (In.) | Std. Pkg. Qty. |
|----------------|----------------------|-----------------------|----------------------------|-------------|--------------|-----------------|----------------|----------------|
|                |                      |                       | L                          | W           | H            |                 |                |                |
| <b>GU-2-X</b>  | 1                    | #4 SOL – 2/0 STR      | 2.75 (70.0)                | 1.13 (28.6) | 3.25 (82.6)  | 3/8             | 9/16           | 10             |
| <b>GU-4-X</b>  | 1 1/4                | #8 SOL – #4 STR       | 3.00 (76.2)                | 1.13 (28.6) | 3.25 (82.6)  | 3/8             | 9/16           | 10             |
| <b>GU-13-3</b> | 2                    | 300 kcmil – 500 kcmil | 4.00 (102.0)               | 1.50 (38.1) | 4.63 (118.0) | 1/2             | 3/4            | 3              |

**UL LISTED** Grounding Clamp for Water Pipes, Bronze

**Type KP**

- Used to ground copper code conductor to water pipe or copper tube
- Cast from high strength, electrolytic bronze to provide reliable grounding connections
- Plated steel screws provide high strength and inhibit corrosion
- Accommodates a wide range of pipe, tube, rod and conductor sizes – minimizes inventory requirements
- UL Listed for grounding and bonding and suitable for direct burial in earth or concrete



| Part Number  | Water Pipe Range (In.) | Conductor Size Range | Figure Dimensions In. (mm) |             | Std. Pkg. Qty. |
|--------------|------------------------|----------------------|----------------------------|-------------|----------------|
|              |                        |                      | L                          | W           |                |
| <b>KP1-C</b> | 1/2 – 1                | #10 SOL – #2 STR     | 2.28 (57.9)                | 0.66 (16.8) | 100            |
| <b>KP2-L</b> | 1 1/4 – 2              | #10 SOL – #2 STR     | 3.58 (90.9)                | 0.73 (18.5) | 50             |



## Grounding Clamp for Water Pipe with Copper Strap, Bronze

### Type KLS

- Used to ground copper code conductor to rigid conduit systems
- Cast from high strength, electrolytic bronze to provide reliable grounding connections
- Plated steel screws provide high strength and inhibit corrosion
- Pure copper contact strip included to isolate conduit system from water pipe vibrations

- High strength bronze conduit hub also included to provide durable connection of conduit to copper strap
- Accommodates a wide range of pipe, tube, and conductor sizes – minimizes inventory requirements
- UL Listed for grounding and bonding and suitable for direct burial in earth or concrete

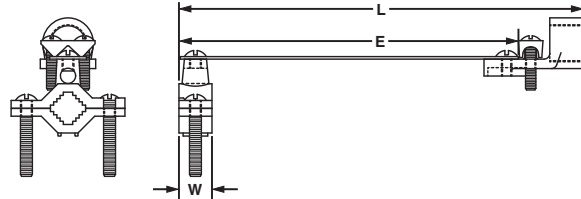

| Part Number | Conduit Hub Size | Water Pipe Range (In.) | Conductor Size Range | Figure Dimensions In. (mm) |                |                 | Std. Pkg. Qty. |
|-------------|------------------|------------------------|----------------------|----------------------------|----------------|-----------------|----------------|
|             |                  |                        |                      | L                          | W              | E               |                |
| KLS-0-Q     | 1/2              | 1/2 – 1                | #8 SOL – #4 STR      | 8.22<br>(58.7)             | 0.66<br>(16.8) | 6.88<br>(174.8) | 25             |
| KLS-1-Q     | 3/4              | 1/2 – 1                | #8 SOL – #4 STR      | 8.22<br>(58.7)             | 0.66<br>(16.8) | 6.88<br>(174.8) | 25             |
| KLS-1A-X    | 1                | 1/2 – 1                | #8 SOL – #4 STR      | 8.38<br>(58.7)             | 0.66<br>(16.8) | 6.88<br>(174.8) | 10             |



## Grounding Clamp for Conduit, Bronze

### Type KH

- Used to ground copper code conductor to rigid conduit systems
- Cast from high strength, electrolytic bronze to provide reliable grounding connections
- Plated steel screws provide high strength and inhibit corrosion
- Includes high strength bronze conduit hub to ensure a durable connection of conduit to copper strap

- Accommodates a wide range of pipe, tube, and conductor sizes – minimizes inventory requirements
- UL Listed for grounding and bonding and suitable for direct burial in earth or concrete



| Part Number | Conduit Hub Size | Water Pipe Range (In.) | Conductor Size Range | Figure Dimensions In. (mm) |                |                |              | Std. Pkg. Qty. |
|-------------|------------------|------------------------|----------------------|----------------------------|----------------|----------------|--------------|----------------|
|             |                  |                        |                      | L                          | W              | E              | D            |                |
| KH-1-L      | 1/2              | 1/2 – 1                | #10 SOL – #4 STR     | 2.31<br>(58.7)             | 0.66<br>(16.8) | 2.54<br>(64.5) | 1.85<br>(47) | 50             |
| KH-2-L      | 1/2              | 1 1/4 – 2              | #10 SOL – #4 STR     | 3.60<br>(91.4)             | 0.79<br>(20.1) | 3.02<br>(76.7) | 1.85<br>(47) | 50             |

A. System Overview

B1. Cable Ties

B2. Cable Accessories

B3. Stainless Steel Ties

C1. Wiring Duct

C2. Surface Raceway

C3. Abrasion Protection

C4. Cable Management

D1. Terminals

D2. Power Connectors

D3. Grounding Connectors

E1. Labeling Systems

E2. Labels

E3. Pre-Printed & Write-On Markers

E4. Permanent Identification

E5. Lockout/Tagout & Safety Solutions

F. Index

A. System Overview

B1. Cable Ties

B2. Cable Accessories

B3. Stainless Steel Ties

C1. Wiring Duct

C2. Surface Raceway

C3. Abrasion Protection

C4. Cable Management

D1. Terminals

D2. Power Connectors

D3. Grounding Connectors

E1. Labeling Systems

E2. Labels

E3. Pre-Printed & Write-On Markers

E4. Permanent Identification

E5. Lockout/Tagout & Safety Solutions

F. Index

## UL LISTED Grounding Clamp for Water Pipes, Aluminum

### Type GC

- Dual-rated for grounding aluminum or copper code conductors to copper water pipe, galvanized pipe, or steel conduit
- Made from high strength, extruded aluminum alloy to provide long term durability
- Tin-plated to inhibit corrosion and oxidation and for low contact resistance
- Plated steel screws provide high strength and inhibit corrosion
- Accommodates a wide range of pipe, tube, and conductor sizes – minimizes inventory requirements
- UL Listed for grounding and bonding

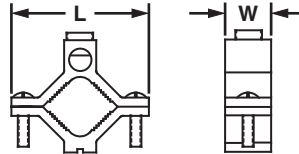

| Part Number     | Conduit Pipe or Water Tube Size | Conductor Size Range | Figure Dimensions In. (mm) |             | Std. Pkg. Qty. |
|-----------------|---------------------------------|----------------------|----------------------------|-------------|----------------|
|                 |                                 |                      | L                          | W           |                |
| <b>GC-15A-Q</b> | 1/2 – 3/4 – 1                   | #14 AWG – 1/0 AWG    | 2.25 (57.2)                | 0.69 (17.5) | 25             |
| <b>GC-18A-X</b> | 1 1/4 – 1, 1/2 – 2              | #6 AWG – 250 kcmil   | 3.75 (95.3)                | 0.81 (20.6) | 10             |
| <b>GC-22A-4</b> | 2 1/2 – 3 – 3 1/2 – 4           | #6 AWG – 250 kcmil   | 6.31 (95.3)                | 1.00 (25.4) | 4              |

## UL LISTED CSA CERTIFIED Grounding Rod Clamp, Bronze

### Type WB

- Used for grounding copper conductor parallel to ground rods
- Made from high strength, seamless electrolytic bronze to provide long term durability
- High strength silicon bronze hardware provides long term reliable assembly
- Accommodates a wide range of rod and conductor sizes – minimizes inventory requirements
- UL Listed and CSA Certified for grounding and bonding and suitable for direct burial in earth and concrete

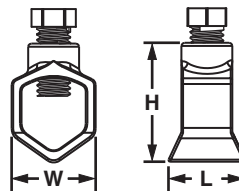

| Part Number   | Ground Rod Size | Conductor Size Range         | Figure Dimensions In. (mm) |             |             | Hex Size In. | Std. Pkg. Qty. |
|---------------|-----------------|------------------------------|----------------------------|-------------|-------------|--------------|----------------|
|               |                 |                              | L                          | W           | H           |              |                |
| <b>WB12-L</b> | 1/2             | #2 – #10 STR, #10 SOL        | 0.88 (22.4)                | 0.84 (21.3) | 1.28 (32.5) | 1/2          | 50             |
| <b>WB34-X</b> | 5/8<br>3/4      | 1/0 – #8 STR,<br>#2 – #8 STR | 1.03 (26.2)                | 1.06 (26.9) | 1.54 (39.1) | 1/2          | 10             |
| <b>WB58-Q</b> | 5/8             | 1/0 – #8 STR                 | 1.04 (26.4)                | 0.92 (23.4) | 1.40 (35.6) | 1/2          | 25             |





## Grounding Clamp with Spacer for Flat Surfaces, Bronze

### Type GM

- Used to ground copper code conductor to flat surfaces
- Cast from high strength, electrolytic bronze to provide reliable grounding connections
- High strength silicon bronze hardware for long term reliable assembly
- Accommodates a wide range of conductor sizes – minimizes inventory requirements
- Incorporates spacer plate to separate conductor from mounting surface
- UL Listed for grounding and bonding and suitable for direct burial in earth or concrete

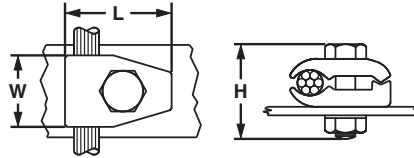

| Part Number | Conductor Size Range | Figure Dimensions<br>In. (mm) |                |                | Hex Size<br>(In.) |      | Std. Pkg. Qty. |
|-------------|----------------------|-------------------------------|----------------|----------------|-------------------|------|----------------|
|             |                      | L                             | W              | H              | Bolt              | Nut  |                |
| GM-2-Q      | #4 SOL – 2/0 STR     | 1.63<br>(41.4)                | 1.13<br>(28.7) | 1.75<br>(44.5) | 9/16              | 9/16 | 25             |
| GM-3-Q      | 2/0 SOL – 250 kcmil  | 2.13<br>(54.1)                | 1.50<br>(38.1) | 2.00<br>(50.8) | 3/4               | 3/4  | 25             |



## Grounding Clamp for Flat Surfaces, Bronze

### Type GMS

- Used to ground copper code conductor to flat surfaces
- Cast from high strength, electrolytic bronze to provide reliable grounding connections
- High strength silicon bronze hardware for long term reliable assembly
- Accommodates a wide range of conductor sizes – minimizes inventory requirements
- UL Listed for grounding and bonding and suitable for direct burial in earth or concrete

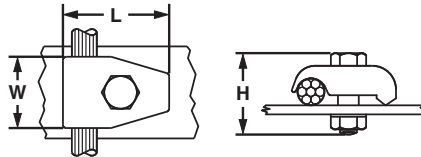

| Part Number | Conductor Size Range | Figure Dimensions<br>In. (mm) |                |                | Hex Size<br>(In.) |      | Std. Pkg. Qty. |
|-------------|----------------------|-------------------------------|----------------|----------------|-------------------|------|----------------|
|             |                      | L                             | W              | H              | Bolt              | Nut  |                |
| GMS-1-X     | #8 SOL – #4 STR      | 1.25<br>(31.8)                | 1.00<br>(25.4) | 1.63<br>(41.4) | 9/16              | 9/16 | 10             |
| GMS-2-Q     | #4 SOL – 2/0 STR     | 1.63<br>(41.4)                | 1.13<br>(28.7) | 1.75<br>(44.5) | 9/16              | 9/16 | 25             |
| GMS-3-Q     | 2/0 SOL – 250 kcmil  | 2.13<br>(54.1)                | 1.50<br>(38.1) | 2.00<br>(50.8) | 3/4               | 3/4  | 25             |

A.  
System  
Overview

B1.  
Cable Ties

B2.  
Cable  
Accessories

B3.  
Stainless  
Steel Ties

C1.  
Wiring  
Duct

C2.  
Surface  
Raceway

C3.  
Abrasion  
Protection

C4.  
Cable  
Management

D1.  
Terminals

D2.  
Power  
Connectors

D3.  
Grounding  
Connectors

E1.  
Labeling  
Systems

E2.  
Labels

E3.  
Pre-Printed  
& Write-On  
Markers

E4.  
Permanent  
Identification

E5.  
Lockout/  
Tagout  
& Safety  
Solutions

F.  
Index

A. System Overview

B1. Cable Ties

B2. Cable Accessories

B3. Stainless Steel Ties

C1. Wiring Duct

C2. Surface Raceway

C3. Abrasion Protection

C4. Cable Management

D1. Terminals

D2. Power Connectors

D3. Grounding Connectors

E1. Labeling Systems

E2. Labels

E3. Pre-Printed & Write-On Markers

E4. Permanent Identification

E5. Lockout/Tagout & Safety Solutions

F. Index



## Flat Braided Bonding Straps

### Type BS

- Used to electrically bond enclosure doors, motors, and machine frames in the construction of control panels or machine structures
- Flat ferrule end design helps to reduce the effects of EMI (Electromagnetic Interference)
- Available with internationally recognized green and yellow insulation for grounding application
- Made of high conductivity copper and tin-plated to inhibit corrosion
- Seamless ferrule ends provide mechanical strength for improved reliability
- UL 467 Listed and CSA Certified

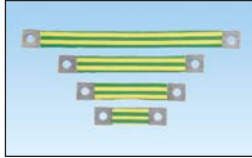

One Hole, Insulated



One-Hole, Non-Insulated

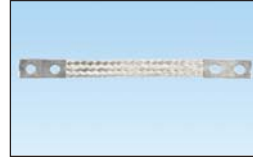

Two-Hole, Non-Insulated

| Part Number                    | Conductor Size | Length In. (mm) | Width In. (mm) | Thickness In. (mm) | Ferrule Length In. (mm) | Stud Hole Size In. (mm) | Stud Hole Spacing In. (mm) | Std. Pkg. Qty. |
|--------------------------------|----------------|-----------------|----------------|--------------------|-------------------------|-------------------------|----------------------------|----------------|
| <b>One-Hole, Insulated</b>     |                |                 |                |                    |                         |                         |                            |                |
| BS100445                       | #4 AWG         | 4.00 (101.6)    | 1.06 (27.0)    | 0.13 (3.3)         | 1.00 (25.4)             | 3/8 (M10)               | —                          | 1              |
| BS100645                       | #4 AWG         | 6.00 (152.4)    | 1.06 (27.0)    | 0.13 (3.3)         | 1.00 (25.4)             | 3/8 (M10)               | —                          | 1              |
| BS100845                       | #4 AWG         | 8.00 (203.2)    | 1.06 (27.0)    | 0.13 (3.3)         | 1.00 (25.4)             | 3/8 (M10)               | —                          | 1              |
| BS101245                       | #4 AWG         | 12.00 (304.8)   | 1.06 (27.0)    | 0.13 (3.3)         | 1.00 (25.4)             | 3/8 (M10)               | —                          | 1              |
| <b>One-Hole, Non-Insulated</b> |                |                 |                |                    |                         |                         |                            |                |
| BS100445U                      | #4 AWG         | 4.00 (101.6)    | 1.06 (27.0)    | 0.13 (3.3)         | 1.00 (25.4)             | 3/8 (M10)               | —                          | 1              |
| BS100645U                      | #4 AWG         | 6.00 (152.4)    | 1.06 (27.0)    | 0.13 (3.3)         | 1.00 (25.4)             | 3/8 (M10)               | —                          | 1              |
| BS100845U                      | #4 AWG         | 8.00 (203.2)    | 1.06 (27.0)    | 0.13 (3.3)         | 1.00 (25.4)             | 3/8 (M10)               | —                          | 1              |
| BS101245U                      | #4 AWG         | 12.00 (304.8)   | 1.06 (27.0)    | 0.13 (3.3)         | 1.00 (25.4)             | 3/8 (M10)               | —                          | 1              |
| <b>Two-Hole, Non-Insulated</b> |                |                 |                |                    |                         |                         |                            |                |
| BS201246EU                     | #4 AWG         | 12.00 (304.8)   | 1.06 (27.0)    | 0.13 (3.3)         | 2.50 (36.5)             | 3/8 (M10)               | 1.25 (31.8)                | 1              |
| BS201846EU                     | #4 AWG         | 18.00 (457.2)   | 1.06 (27.0)    | 0.13 (3.3)         | 2.50 (36.5)             | 3/8 (M10)               | 1.25 (31.8)                | 1              |
| BS202446EU                     | #4 AWG         | 24.00 (609.6)   | 1.06 (27.0)    | 0.13 (3.3)         | 2.50 (36.5)             | 3/8 (M10)               | 1.25 (31.8)                | 1              |

## COMPRESSION CONNECTOR CRIMPING TOOLS

Panduit offers a wide range of tools to provide solutions for installing compression lugs and splices. Panduit installation tools provide quality performance, ease of installation, and lowest installed cost. The long-term reliability of Panduit installation tools provides the highest level of service to meet and surpass customer requirements.



- Ergonomic design to minimize operator effort
- Controlled cycle mechanisms ensuring reliability and repeatability in every crimp made
- Crimping dies are color coded to easily match the compression connector to the proper die
- UL Listed and CSA Certified terminations with Panduit compression connectors, as noted

Panduit compression connector crimping tools are available in an assortment of styles including manually operated mechanical and hydraulic, battery operated hydraulic, and AC powered hydraulic to meet a variety of installation needs. Uni-Die™ Dieless Crimping Tools crimp a variety of sizes and eliminate the need to purchase crimping dies. Fully self-contained, lithium-ion battery powered crimping tools provide the ease of push button crimping with up to 35% more crimps per battery charge and up to a 30% faster crimp cycle time than comparable tools with NiCd or NiMH batteries.

A.  
System  
Overview

B1.  
Cable Ties

B2.  
Cable  
Accessories

B3.  
Stainless  
Steel Ties

C1.  
Wiring  
Duct

C2.  
Surface  
Raceway

C3.  
Abrasion  
Protection

C4.  
Cable  
Management

D1.  
Terminals

D2.  
Power  
Connectors

D3.  
Grounding  
Connectors

E1.  
Labeling  
Systems

E2.  
Labels

E3.  
Pre-Printed  
& Write-On  
Markers

E4.  
Permanent  
Identification

E5.  
Lockout/  
Tagout  
& Safety  
Solutions

F.  
Index

A. System Overview

B1. Cable Ties

B2. Cable Accessories

B3. Stainless Steel Ties

C1. Wiring Duct

C2. Surface Raceway

C3. Abrasion Protection

C4. Cable Management

D1. Terminals

D2. Power Connectors

D3. Grounding Connectors

E1. Labeling Systems

E2. Labels

E3. Pre-Printed & Write-On Markers

E4. Permanent Identification

E5. Lockout/Tagout & Safety Solutions

F. Index

## Crimping Guidelines for Panduit® Pan-Lug™ Compression Lugs and Splices

### 1. Select the proper Panduit compression connector for the conductor type and size being used.

- Panduit compression connectors are identified with the proper conductor size and conductor type marked on the tongue or barrel of the connector

• The proper conductor size and type to be used with each connector can also be found in the installation instructions included with Panduit product packaging and in the tool charts\* in this catalog

| PANDUIT PART NUMBER | STUD WIRE SIZE | WIRE RANGE-TANGING WITH OUR DRY TOOLS (SEE NOTE) | WIRE STRIP LENGTH (IN.) | CR-TOOL      |
|---------------------|----------------|--|-------------------------|--------------|
| LOG SPALICE         | 6 AWG          | ---  | 5/8                     | RED P24 (3)  |
| LCB, LCC SCLB       | 6 AWG          | ---  | 1-1/16                  | ---          |
| LCB, LCC SCLB       | 6 AWG          | ---  | 1-1/4                   | BLUE P24 (3) |
| LCB, LCC SCLB       | 6 AWG          | ---  | 1-1/2                   | ---          |
| LCB, LCC SCLB       | 6 AWG          | ---  | 1-5/8                   | ---          |
| LCB, LCC SCLB       | 6 AWG          | ---  | 1-3/4                   | ---          |
| LCB, LCC SCLB       | 6 AWG          | ---  | 1-7/8                   | ---          |
| LCB, LCC SCLB       | 6 AWG          | ---  | 1-5/4                   | ---          |
| LCB, LCC SCLB       | 6 AWG          | ---  | 1-3/2                   | ---          |
| LCB, LCC SCLB       | 6 AWG          | ---  | 1-1/2                   | ---          |
| LCB, LCC SCLB       | 6 AWG          | ---  | 1-1/4                   | ---          |
| LCB, LCC SCLB       | 6 AWG          | ---  | 1-1/8                   | ---          |
| LCB, LCC SCLB       | 6 AWG          | ---  | 1-1/16                  | ---          |

### 2. Strip the conductor to the proper strip length. As specified:

- On the Panduit product packaging label or
- On the installation instructions included with Panduit product packaging or
- In the tool charts\* in this catalog

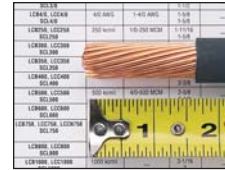

Make sure the conductor is not stripped too long, which would result in exposed wire between the barrel of the connector and the cable insulation.

Make sure the conductor is not stripped too short, which would result in a less than complete contact area with the connector when the conductor is inserted in the barrel.

Do not nick or cut strands of conductor during crimping, which would result in a less than premium conductor termination.



Make sure conductor strands are free from corrosion.

### 3. Select the proper crimping die and crimping tool to be used with the connector.

Use crimping tools and dies that provide a UL Listed and/or CSA Certified electrical termination, to assure a safe and reliable connection.

Many Panduit compression connectors are UL Listed and CSA Certified when crimped with Panduit and specified competitor crimping tools and dies. These tools and dies are listed in the tool charts\* in this catalog. Panduit crimping tools and dies to be used with each connector are also listed on the installation instructions included with Panduit product packaging.



Panduit compression connectors are color-coded and marked with Panduit and specified competitor die index numbers. Select the proper crimping die to be used by matching the color code and die index number marked on the connector to the same markings on the crimping die.

### 4. Crimp the connector.

Insert the conductor into the barrel of the connector. The conductor should stop against the end of the barrel of the lug, or wire stop in the butt splice, upon complete insertion of the conductor in the barrel. Some lugs are offered with inspection windows that provide visual inspection of the complete conductor insertion.



Review the installation instructions included with the Panduit product packaging or the tool charts\* for the proper number of crimps to be placed in the connector. Make the first crimp in the barrel nearest the tongue of the lug, or wire stop in a butt splice, and make successive crimps in the barrel working towards the conductor entry at the end of the barrel.

| MIN. PLS (3) | LC  | FIN. PLS (3)   |
|--------------|-----|----------------|
| CD-200-2/0   | STD | CD-2001-2/0    |
| ACK P45 (3)  | (2) | BLACK P45 (3)  |
| CD-200-3/0   | STD | CD-2001-3/0    |
| ANGE P50 (3) | (2) | ORANGE P50 (3) |
| CD-200-4/0   | STD | CD-2001-4/0    |
| RPLE P54 (3) | (2) | PURPLE P54 (3) |
| CD-200-250   | STD | CD-2001-250    |
| LOW P62 (3)  | (3) | YELLOW P62 (3) |
| CD-200-300   | STD | CD-2001-300    |
| HTE P66 (3)  | (3) | WHITE P66 (3)  |
| CD-200-350   | STD | CD-2001-350    |
| RED P71 (3)  | (3) | RED P71 (3)    |
| CD-200-400   | STD | CD-2001-400    |



Identify the barrel. Use the color-coded or knurled band markings on the barrel of the connector to evenly space the placement of the crimps in the barrel.

When properly crimped, the die index number engraved in the crimping die will be embossed into the barrel of the connector. The crimp should be placed in the connector so the die index number can be easily read when the connector is installed.

\* See tool charts on pages D3.56 – D3.94.

## Crimping Guidelines for Panduit® StructuredGround™ Compression Connectors

### TAP Installation

1. Locate desired position of TAP along main wire run. Allow clearance for tap wires (and cover installation if applicable). See clear cover table on page D3.13.
2. Strip insulation from wires to the length shown in the TAP table on page D3.14. Use care to avoid damaging the conductors.
3. Position wires in the appropriate tap grooves.
4. For easier installation, apply one of the flame retardant cable ties (provided) around the wires and through the slots in the TAP. **The head of the cable tie must be positioned along the side of the TAP as shown in Figure A.** Tension and cut off excess length of tie. Additional cable ties may be used adjacent to the TAP to secure the wires.
5. Install the correct dies (see page D3.94) into the crimping tool. Position the locator die into the stationary die holder. **Note: The color code and die index number shown on the HTAP and crimping dies must match.**
6. Position the TAP against the locator in the stationary die holder of the crimping tool.
7. After crimping, if desired, cut off the cable tie head or remove the entire cable tie. **Note: In some cases, the cable tie head must be cut off in order for the crimped connector to fit inside the insulating cover.**

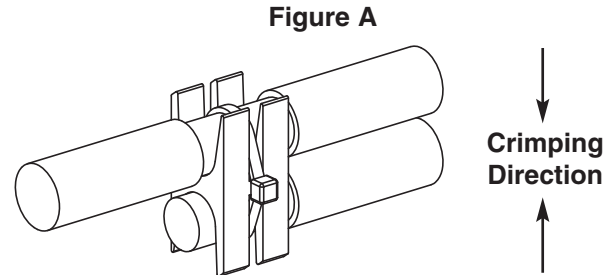

### HTAP Cover Installation

1. If labels are being utilized, cut labels to the dimensions shown below. **Note: When using a Panduit® Pan-Ther™ LS8E printer, the length dimensions can be easily programmed to provide cut-off marks.**
2. Position the label(s) in the pockets inside the cover and snap in the label retainer(s) as shown in Figure B. Information can be marked on the matte finish label retainers in lieu of using a separate label.
3. Position one cover half around the crimped connector assembly. Align the second cover half with the first and snap together.
4. Install the two flame retardant cable ties (provided) in the grooved areas on the cover. Tension and cut off excess lengths of ties.

Label Size Information

| Clear Cover Part Number | Label Height (Max.) | Label Length (Wrap-Around Style) | Label Length (Flat Style) |
|-------------------------|---------------------|----------------------------------|---------------------------|
| CLRCVR1-1               | .38                 | 1.56                             | 1.00                      |
| CLRCVR2-1               | .38                 | 1.87                             | 1.25                      |
| CLRCVR3-1               | .38                 | 2.37                             | 1.75                      |

Figure B

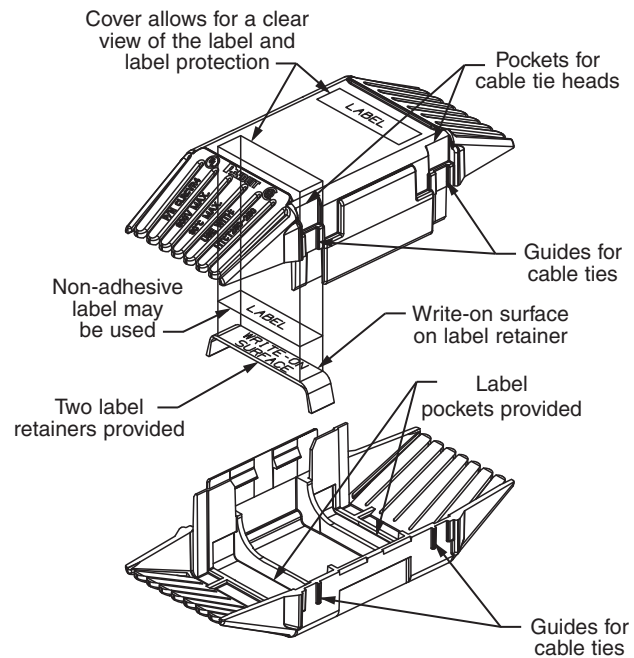

**Note: Configuration of cover may differ slightly from illustration.**

A. System Overview

B1. Cable Ties

B2. Cable Accessories

B3. Stainless Steel Ties

C1. Wiring Duct

C2. Surface Raceway

C3. Abrasion Protection

C4. Cable Management

D1. Terminals

D2. Power Connectors

D3. Grounding Connectors

E1. Labeling Systems

E2. Labels

E3. Pre-Printed & Write-On Markers

E4. Permanent Identification

E5. Lockout/Tagout & Safety Solutions

F. Index

A. System Overview

B1. Cable Ties

B2. Cable Accessories

B3. Stainless Steel Ties

C1. Wiring Duct

C2. Surface Raceway

C3. Abrasion Protection

C4. Cable Management

D1. Terminals

D2. Power Connectors

D3. Grounding Connectors

E1. Labeling Systems

E2. Labels

E3. Pre-Printed & Write-On Markers

E4. Permanent Identification

E5. Lockout/Tagout & Safety Solutions

F. Index

## Selection Guide – Compression Connector Tools

| Tool Selection Guide for Crimping Panduit Copper Compression Lugs and Splices for use with Copper Code Conductors |   |   |  |                                   |         |        |        |        |        |        |        |         |         |         |         |           |           |           |           |           |           |           |
|---|---|---|--|-----------------------------------|---------|--------|--------|--------|--------|--------|--------|---------|---------|---------|---------|-----------|-----------|-----------|-----------|-----------|-----------|-----------|
| Conductor Type  | Connector Type  | Tool Type   | Copper Conductor Range                               |                                   |         |        |        |        |        |        |        |         |         |         |         |           |           |           |           |           |           |           |
|   |   |   | #14 AWG  | #12 AWG                           | #10 AWG | #8 AWG | #6 AWG | #4 AWG | #3 AWG | #2 AWG | #1 AWG | 1/0 AWG | 2/0 AWG | 3/0 AWG | 4/0 AWG | 250 kcmil | 300 kcmil | 350 kcmil | 400 kcmil | 500 kcmil | 600 kcmil | 750 kcmil |
| Copper Code Conductor   | LCAS<br>LCA<br>LCAN<br>LCB<br>LCB-W<br>LCBH<br>LCD<br>LCDN<br>LCC<br>LCC-W<br>LCCN<br>LCCH<br>SCSS<br>SCS<br>SCL<br>SCH<br>SCT<br>PS<br>RSC | Manual Crimping Tools                             | CT-100A – Plier Type (pg. D1.83)                     |                                   |         |        |        |        |        |        |        |         |         |         |         |           |           |           |           |           |           |           |
|   |   |   | CT-200 – Plier Type (pg. D1.83)                      |                                   |         |        |        |        |        |        |        |         |         |         |         |           |           |           |           |           |           |           |
|   |   |   | CT-1570 – Controlled Cycle (pg. D1.84)               |                                   |         |        |        |        |        |        |        |         |         |         |         |           |           |           |           |           |           |           |
|   |   |   | CT-1701 – Controlled Cycle (pg. D1.84)               |                                   |         |        |        |        |        |        |        |         |         |         |         |           |           |           |           |           |           |           |
|   |   |   | CT-1700* – Controlled Cycle (pg. D1.84)              |                                   |         |        |        |        |        |        |        |         |         |         |         |           |           |           |           |           |           |           |
|   |   | Manual Hydraulic Crimping Tools                   | CT-720 – Die Type (pg. D3.37)                        |                                   |         |        |        |        |        |        |        |         |         |         |         |           |           |           |           |           |           |           |
|   |   |   | CT-930 – 14 ton (pg. D3.39)                          |                                   |         |        |        |        |        |        |        |         |         |         |         |           |           |           |           |           |           |           |
|   |   |   | CT-980 Uni-Die™ Dieless – 6.2 ton (pg. D3.52)        |                                   |         |        |        |        |        |        |        |         |         |         |         |           |           |           |           |           |           |           |
|   |   |   | CT-3001 – In-Line – 6 ton (pg. D3.40)                |                                   |         |        |        |        |        |        |        |         |         |         |         |           |           |           |           |           |           |           |
|   |   |   | CT-2002/L – Open "C-head" – 6 ton (pg. D3.41)        |                                   |         |        |        |        |        |        |        |         |         |         |         |           |           |           |           |           |           |           |
|   |   |   | CT-2930/L – 14 ton (pg. D3.43)                       |                                   |         |        |        |        |        |        |        |         |         |         |         |           |           |           |           |           |           |           |
|   |   |   | CT-2940/L – 15 ton (pg. D3.44)                       |                                   |         |        |        |        |        |        |        |         |         |         |         |           |           |           |           |           |           |           |
|   |   |   | CT-2980/L Uni-Die™ Dieless – 6.2 ton (pg. D3.53)     |                                   |         |        |        |        |        |        |        |         |         |         |         |           |           |           |           |           |           |           |
|   |   |   | Lithium-Ion Battery Powered Hydraulic Crimping Tools | CT-930CH – 14 ton (pg. D3.45)     |         |        |        |        |        |        |        |         |         |         |         |           |           |           |           |           |           |           |
|   |   |   |  | CT-930LPCH – 10.5 ton (pg. D3.48) |         |        |        |        |        |        |        |         |         |         |         |           |           |           |           |           |           |           |
|   |   | CT-940CH – 15 ton (pg. D3.46)                     |  |                                   |         |        |        |        |        |        |        |         |         |         |         |           |           |           |           |           |           |           |
|   |   | CT-980CH Uni-Die™ Dieless – 6.2 ton (pg. D3.54)   |  |                                   |         |        |        |        |        |        |        |         |         |         |         |           |           |           |           |           |           |           |
|   |   | CT-980LPCH Uni-Die™ Dieless – 4.7 ton (pg. D3.54) |  |                                   |         |        |        |        |        |        |        |         |         |         |         |           |           |           |           |           |           |           |
|   |   | Remote Crimp Heads                                |  |                                   |         |        |        |        |        |        |        |         |         |         |         |           |           |           |           |           |           |           |
|   |   |   |  |                                   |         |        |        |        |        |        |        |         |         |         |         |           |           |           |           |           |           |           |
|   |   |   |  |                                   |         |        |        |        |        |        |        |         |         |         |         |           |           |           |           |           |           |           |
|   |   |   |  |                                   |         |        |        |        |        |        |        |         |         |         |         |           |           |           |           |           |           |           |
|   |   |   |  |                                   |         |        |        |        |        |        |        |         |         |         |         |           |           |           |           |           |           |           |

See tool charts on pages D3.56 – D3.94 for selection of crimping dies and number of crimps used with specific tool and connector combinations.

\*CT-1700 is not used for PSC splices.



## Selection Guide – Compression Connector Tools (continued)

| Tool Selection Guide for Crimping Panduit Copper Compression Lugs and Splices for use with Copper Flex Conductor |  |  |   |        |        |        |        |        |         |         |         |         |           |           |           |           |           |           |           |           |           |           |           |           |           |           |  |  |  |  |  |  |  |  |
|--|--|--|---|--------|--------|--------|--------|--------|---------|---------|---------|---------|-----------|-----------|-----------|-----------|-----------|-----------|-----------|-----------|-----------|-----------|-----------|-----------|-----------|-----------|--|--|--|--|--|--|--|--|
| Conductor Type   | Connector Type   | Tool Type  | Copper Conductor Range                        |        |        |        |        |        |         |         |         |         |           |           |           |           |           |           |           |           |           |           |           |           |           |           |  |  |  |  |  |  |  |  |
|  |  |  | #8 AWG  | #6 AWG | #4 AWG | #3 AWG | #2 AWG | #1 AWG | 1/0 AWG | 2/0 AWG | 3/0 AWG | 4/0 AWG | 250 kcmil | 262 kcmil | 300 kcmil | 313 kcmil | 350 kcmil | 373 kcmil | 400 kcmil | 450 kcmil | 500 kcmil | 535 kcmil | 600 kcmil | 646 kcmil | 750 kcmil | 777 kcmil |  |  |  |  |  |  |  |  |
| Copper Code and Flex Conductor   | LCAX<br>LCAXN<br>LCBX<br>LCDXN<br>LCCX<br>LCCXN<br>Maximum Code Conductor Size 4/0 AWG | Manual Crimping Tool                                 | CT-1700 – Controlled Cycle (pg. D1.84)        |        |        |        |        |        |         |         |         |         |           |           |           |           |           |           |           |           |           |           |           |           |           |           |  |  |  |  |  |  |  |  |
|  |  | Manual Hydraulic Crimping Tool                       | CT-930 – 14 ton (pg. D3.39)                   |        |        |        |        |        |         |         |         |         |           |           |           |           |           |           |           |           |           |           |           |           |           |           |  |  |  |  |  |  |  |  |
|  |  | Lithium-Ion Battery Powered Hydraulic Crimping Tools | CT-3001 – In-Line – 6 ton (pg. D3.40)         |        |        |        |        |        |         |         |         |         |           |           |           |           |           |           |           |           |           |           |           |           |           |           |  |  |  |  |  |  |  |  |
|  |  |  | CT-2002/L – Open “C-head” – 6 ton (pg. D3.41) |        |        |        |        |        |         |         |         |         |           |           |           |           |           |           |           |           |           |           |           |           |           |           |  |  |  |  |  |  |  |  |
|  |  |  | CT-2930/L – 14 ton (pg. D3.43)                |        |        |        |        |        |         |         |         |         |           |           |           |           |           |           |           |           |           |           |           |           |           |           |  |  |  |  |  |  |  |  |
|  |  |  | CT-2940/L – 15 ton (pg. D3.44)                |        |        |        |        |        |         |         |         |         |           |           |           |           |           |           |           |           |           |           |           |           |           |           |  |  |  |  |  |  |  |  |
|  |  | Remote Crimp Heads                                   | CT-930CH – 14 ton (pg. D3.45)                 |        |        |        |        |        |         |         |         |         |           |           |           |           |           |           |           |           |           |           |           |           |           |           |  |  |  |  |  |  |  |  |
|  |  |  | CT-940CH – 15 ton (pg. D3.46)                 |        |        |        |        |        |         |         |         |         |           |           |           |           |           |           |           |           |           |           |           |           |           |           |  |  |  |  |  |  |  |  |
| Copper Flex Conductor  | LCAF<br>LCCF<br>SCSF<br>RSC  | Manual Hydraulic Crimping Tool                       | CT-930 – 14 ton (pg. D3.39)                   |        |        |        |        |        |         |         |         |         |           |           |           |           |           |           |           |           |           |           |           |           |           |           |  |  |  |  |  |  |  |  |
|  |  | Lithium-Ion Battery Powered Hydraulic Crimping Tools | CT-2930/L – 14 ton (pg. D3.43)                |        |        |        |        |        |         |         |         |         |           |           |           |           |           |           |           |           |           |           |           |           |           |           |  |  |  |  |  |  |  |  |
|  |  |  | CT-2940/L – 15 ton (pg. D3.44)                |        |        |        |        |        |         |         |         |         |           |           |           |           |           |           |           |           |           |           |           |           |           |           |  |  |  |  |  |  |  |  |
|  |  | Remote Crimp Heads                                   | CT-930CH – 14 ton (pg. D3.45)                 |        |        |        |        |        |         |         |         |         |           |           |           |           |           |           |           |           |           |           |           |           |           |           |  |  |  |  |  |  |  |  |
|  |  |  | CT-940CH – 15 ton (pg. D3.46)                 |        |        |        |        |        |         |         |         |         |           |           |           |           |           |           |           |           |           |           |           |           |           |           |  |  |  |  |  |  |  |  |

See tool charts on pages D3.56 – D3.94 for selection of crimping dies and number of crimps used with specific tool and connector combinations.

Selection guide continues on page D3.36

A. System Overview

B1. Cable Ties

B2. Cable Accessories

B3. Stainless Steel Ties

C1. Wiring Duct

C2. Surface Raceway

C3. Abrasion Protection

C4. Cable Management

D1. Terminals

D2. Power Connectors

D3. Grounding Connectors

E1. Labeling Systems

E2. Labels

E3. Pre-Printed & Write-On Markers

E4. Permanent Identification

E5. Lockout/Tagout & Safety Solutions

F. Index

A.  
System  
Overview

B1.  
Cable Ties

B2.  
Cable  
Accessories

B3.  
Stainless  
Steel Ties

C1.  
Wiring  
Duct

C2.  
Surface  
Raceway

C3.  
Abrasion  
Protection

C4.  
Cable  
Management

D1.  
Terminals

D2.  
Power  
Connectors

D3.  
Grounding  
Connectors

E1.  
Labeling  
Systems

E2.  
Labels

E3.  
Pre-Printed  
& Write-On  
Markers

E4.  
Permanent  
Identification

E5.  
Lockout/  
Tagout  
& Safety  
Solutions

F.  
Index

## Selection Guide – Compression Connector Tools (continued)

| Tool Selection Guide for Crimping Panduit Aluminum Compression Lugs and Splices for use with Copper or Aluminum Code Conductor |                |  |  |        |        |        |        |         |         |         |         |           |           |           |           |           |           |           |           |            |
|--|----------------|--|--|--------|--------|--------|--------|---------|---------|---------|---------|-----------|-----------|-----------|-----------|-----------|-----------|-----------|-----------|------------|
| Conductor Type   | Connector Type | Tool Type  | Copper or Aluminum Conductor Range     |        |        |        |        |         |         |         |         |           |           |           |           |           |           |           |           |            |
|  |                |  | #6 AWG                                 | #4 AWG | #3 AWG | #2 AWG | #1 AWG | 1/0 AWG | 2/0 AWG | 3/0 AWG | 4/0 AWG | 250 kcmil | 300 kcmil | 350 kcmil | 400 kcmil | 500 kcmil | 600 kcmil | 750 kcmil | 800 kcmil | 1000 kcmil |
| Copper or Aluminum Code Conductor  | LAA LAB SA     | Manual Crimping Tools                                | CT-1700 – Controlled Cycle (pg. D1.84) |        |        |        |        |         |         |         |         |           |           |           |           |           |           |           |           |            |
|  |                |  | CT-720 – Die Type (pg. D3.37)          |        |        |        |        |         |         |         |         |           |           |           |           |           |           |           |           |            |
|  |                | Manual Hydraulic Crimping Tool                       | CT-930 – 14 ton (pg. D3.39)            |        |        |        |        |         |         |         |         |           |           |           |           |           |           |           |           |            |
|  |                | Lithium-Ion Battery Powered Hydraulic Crimping Tools | CT-2930/L – 14 ton (pg. D3.43)         |        |        |        |        |         |         |         |         |           |           |           |           |           |           |           |           |            |
|  |                | Remote Crimp Heads                                   | CT-2940/L – 15 ton (pg. D3.44)         |        |        |        |        |         |         |         |         |           |           |           |           |           |           |           |           |            |
|  |                |  | CT-930CH – 14 ton (pg. D3.45)          |        |        |        |        |         |         |         |         |           |           |           |           |           |           |           |           |            |
|  |                |  | CT-940CH – 15 ton (pg. D3.46)          |        |        |        |        |         |         |         |         |           |           |           |           |           |           |           |           |            |

See tool charts on pages D3.56 – D3.94 for selection of crimping dies and number of crimps used with specific tool and connector combinations.

## Die Type, Manual, Crimping Tool

- High quality, durable tool construction provides long term dependability



- Develops 6 tons of crimping force, crimps copper compression lugs and splices up to 500 kcmil
- Provides UL Listed and CSA Certified connections on Panduit copper and aluminum lugs, splices, and insulated terminals

| Part Number | Part Description  | Std. Pkg. Qty. |
|-------------|---|----------------|
| CT-720      | Manual crimping tool for UL Listed or Recognized and CSA Certified terminations of Panduit® Pan-Lug™ copper compression lugs and splices for #8 AWG – 500 kcmil copper code conductor and aluminum compression lugs and splices for #6 AWG – 350 kcmil copper and aluminum code conductors. Provides UL Listed terminations of Panduit® Pan-Term® #8 – #2 AWG vinyl insulated terminals.<br><br>Color-coded CD-720 crimping dies, carrying/storage case and controlled cycle mechanism must be purchased separately.<br><br>Specifications:<br>Output: 6 tons<br>Weight: 7.7 lbs.<br>Length: 26"<br>Handle span: 58" (open), 2.5" (closed)<br>Warranty: 90 days | 1              |
| CC-720      | Optional controlled cycle mechanism only. Total weight of tool with CC-720 is 8.25 lbs.   | 1              |
| C-720       | Black steel carrying case for CT-720 crimping tool.   | 1              |

For battery powered crimping tools, see compression connector tools selection guide on pages D3.34 – D3.36.

## CD-720 Crimping Dies

- Color-coded for easy matching to color-coding marked on connectors
- Embosses die index number on connector barrels to provide post crimp inspection except CD-720PV8-2



- Part number permanently marked on crimping die for easy identification
- Provides 5-sided crimp results in terminations with premium electrical and mechanical performance

| Part Number | Used to Install Panduit Compression Lug and Splice Sizes |  |                         |  | Std. Pkg. Qty. |
|-------------|--|--|-------------------------|--|----------------|
|             | Copper Conductor Size                                    | Copper Die Color and Die No.               | Aluminum Conductor Size | Aluminum Die Color and Die No.         |                |
| CD-720-1    | #8 – #2 AWG  | Red P21, Blue P24, Gray P29, Brown P33     | #6 AWG                  | Gray P29                               | 1              |
| CD-720-2    | #1 – 3/0 AWG   | Green P37, Pink P42, Black P45, Orange P50 | #4 – 1/0 AWG            | Green P37, Pink P42, Gold P45, Tan P50 | 1              |
| CD-720-3    | 4/0 AWG – 250 kcmil                                      | Purple P54, Yellow P62                     | 2/0 – 3/0 AWG           | Olive P54, Ruby P62                    | 1              |
| CD-720-4    | 300 kcmil  | White P66                                  | 4/0 AWG                 | White P66                              | 1              |
| CD-720-5    | 350 kcmil  | Red P71                                    | 250 kcmil               | Red P71                                | 1              |
| CD-720-6    | 400 kcmil  | Blue P76                                   | 300 kcmil               | Blue P76                               | 1              |
| CD-720-7    | 500 kcmil  | Brown P87                                  | 350 kcmil               | Brown P87                              | 1              |
| CD-720PV8-2 | #8 – #2 AWG, vinyl insulated Pan-Term® Terminals         | Red, Blue, Yellow                          | —                       | —                                      | 1              |

See pages D3.34 – D3.36 for connector and tool selection information.

A.  
System  
Overview

B1.  
Cable Ties

B2.  
Cable  
Accessories

B3.  
Stainless  
Steel Ties

C1.  
Wiring  
Duct

C2.  
Surface  
Raceway

C3.  
Abrasion  
Protection

C4.  
Cable  
Management

D1.  
Terminals

D2.  
Power  
Connectors

D3.  
Grounding  
Connectors

E1.  
Labeling  
Systems

E2.  
Labels

E3.  
Pre-Printed  
& Write-On  
Markers

E4.  
Permanent  
Identification

E5.  
Lockout/  
Tagout  
& Safety  
Solutions

F.  
Index

A. System Overview

## Die Type, Manual, Crimping Tool and Die Kits

B1. Cable Ties

- Available with or without controlled cycle feature to meet specific applications

- Kits available with three or full set of seven dies for crimping partial or full range of connector sizes

B2. Cable Accessories



B3. Stainless Steel Ties

| Part Number       | Part Description   | Std. Pkg. Qty. |
|-------------------|--|----------------|
| <b>CT-720-7</b>   | Basic tool kit with seven dies.<br>Includes: <ul style="list-style-type: none"> <li>• Seven dies (CD-720-1 through CD-720-7) for installing #8 AWG – 500 kcmil copper compression connectors</li> <li>• Carrying/storage case (C-720)</li> </ul>   | 1              |
| <b>CT-720-7CC</b> | Controlled cycle tool kit with seven dies. Controlled cycle mechanism factory installed on crimping tool.<br>Includes: <ul style="list-style-type: none"> <li>• Seven dies (CD-720-1 through CD-720-7) for installing #8 AWG – 500 kcmil copper compression connectors</li> <li>• Carrying/storage case (C-720)</li> </ul> | 1              |
| <b>CT-720-3</b>   | Basic tool kit with three dies.<br>Includes: <ul style="list-style-type: none"> <li>• Three dies (CD-720-1 through CD-720-3) for installing #8 AWG – 250 kcmil copper compression connectors</li> <li>• Carrying/storage case (C-720)</li> </ul>   | 1              |
| <b>CT-720-3CC</b> | Controlled cycle tool kit with three dies. Controlled cycle mechanism factory installed on crimping tool.<br>Includes: <ul style="list-style-type: none"> <li>• Three dies (CD-720-1 through CD-720-3) for installing #8 AWG – 250 kcmil copper compression connectors</li> <li>• Carrying/storage case (C-720)</li> </ul> | 1              |

C1. Wiring Duct

C2. Surface Raceway

C3. Abrasion Protection

C4. Cable Management

D1. Terminals

## Cable Stripping Tool for Large Cable Sizes

D2. Power Connectors

- Provides safe and easy stripping of cable insulation for cables 3/16" to 1 9/16" diameter
- Cutting blade provides circular, spiral, and in-line insulation cutting
- Spiral cut mode, tough/hard insulations peel off easily
- In-line cut mode for use with softer insulation like neoprene
- Unique blade profile for long life, low friction stripping of difficult insulations like rubber and silicon

- Cutting blade easily adjusts to proper height to cut insulation without nicking conductor strands
- Ergonomic shape for safe comfortable use
- Compact design
- Easy-fit replacement blade, one spare blade included with tool

D3. Grounding Connectors



| Part Number        | Wire Range (O.D.) | Part Description   | Std. Pkg. Qty. |
|--------------------|-------------------|--|----------------|
| <b>CST114-157</b>  | 0.18" – 1.57"     | Cable stripping tool for stripping insulation from cables 3/16" to 1 9/16" diameter. Includes replacement cutting blade. Warranty: 90 days | 1              |
| <b>CST114-157B</b> | —                 | Blade replacement kit for CST114-157 cable stripping tool.   | 1              |

E1. Labeling Systems

E2. Labels

## Wire and Cable Stripping Tools

E3. Pre-Printed & Write-On Markers

- Strips and cuts #20 – #10 AWG wire
- Lightweight and durable for comfortable long use

- Rust resistant coating included to improve durability of tool

E4. Permanent Identification



**CST101**

E5. Lockout/Tagout & Safety Solutions



**CST115**

| Part Number   | Wire Range (O.D.) | Part Description          | Std. Pkg. Qty. |
|---------------|-------------------|---------------------------|----------------|
| <b>CST101</b> | #20 – #10 AWG     | V notch wire stripper.    | 1              |
| <b>CST115</b> | #20 – #10 AWG     | Plier nose wire stripper. | 1              |



## Cable Cutting Tools

- Designed with optimal force transmission ratio and stepwise cutting to allow for one-hand operation
- Ergonomically formed, soft handle grips provide easy operation without fatigue

- All parts made of high-tempered special steel; blades and stressed parts are specially tempered or hardened for long term durability
- Not for use with steel and ASCR cable



CCT-500



CCT-320

| Part Number | Part Description   | Std. Pkg. Qty. |
|-------------|--|----------------|
| CCT-500     | Ratchet cable cutting tool cuts both copper and aluminum solid code and stranded flex cables (AL & CU cable to 1000MCM) up to 2 - 1/32" (52mm) diameter. Approximate dimensions 14" (356mm) x 5-1/2" (140mm) x 1" (25.4mm). Tool weight 29.6 oz. (840 g). Warranty: 1 year.  | 1              |
| CCT-320     | Ratchet cable cutting tool cuts both copper and aluminum solid code cables (AL cable to 600MCM and CU cable to 500MCM) from 1/4" (6mm) to 1" (25mm) and stranded flex cables from 1/4" (6mm) to 1-1/4" (32mm) diameter. Approximate dimensions 10" (254mm) x 3-3/4" (95mm) x 1" (25.4mm). Tool weight 21 oz. (600 g) Warranty: 1 year. | 1              |

## Die Type, Manual Hydraulic, 14 Ton, Crimping Tool

- Develops 14 tons of crimping force, crimps copper compression lugs and splices up to 750 kcmil
- Two-stage rapid advance hydraulic system minimizes number of pumps required to complete a crimp, saves time
- High quality, durable tool construction provides long-term dependability
- Cushioned grip prevents hands from slipping on tool, reduces fatigue
- Provides UL Listed and CSA Certified connections on Panduit® Pan-Lug™ Copper and Aluminum Lugs and Splices and Copper Taps

- Open "C-Head" design allows easy loading of crimping dies and connectors, saves time
- Uses color-coded crimping dies to provide easy matching of crimping die to connector
- Embosses die index number on connector barrels to provide post crimp inspection
- Dies installed using spring loaded die retention pins, no need for tools
- Rubber boot on crimp head provides abrasion protection
- Audible "pop-off" valve indicates crimp completion
- Crimp head rotates 180 degrees, provides versatility for use in restricted spaces



| Part Number | Part Description   | Std. Pkg. Qty. |
|-------------|--|----------------|
| CT-930      | <p>Terminates Panduit® Pan-Lug™ Compression Connectors:</p> <ul style="list-style-type: none"> <li>• Copper compression lugs and splices for #8 AWG – 750 kcmil code conductor</li> <li>• Copper compression lugs and splices for #8 AWG – 600 kcmil flex conductor</li> <li>• StructuredGround™ Direct Burial Compression Grounding System Connectors for #6 AWG – 250 kcmil code conductor and select 500 kcmil conductor combinations</li> <li>• Copper compression CTAPF taps for #10 – 3/0 AWG code conductor</li> <li>• Copper compression CTAP taps for #8 – 4/0 AWG code conductor</li> <li>• Copper compression HTCT taps for #14 AWG – 250 kcmil code conductor, #14 – 4/0 AWG flex conductor</li> <li>• Aluminum compression lugs and splices for #6 AWG – 600 kcmil code conductor</li> <li>• Panduit® Pan-Term® Tubular Terminals for #8 AWG – 250 kcmil code conductor</li> </ul> <p>Specifications:<br/>                     Output: 14 tons<br/>                     Jaw opening: 1.65"<br/>                     Weight: 16.5 lbs.<br/>                     Length: 25"<br/>                     Handle span: 17 1/2" (open), 6" (closed)<br/>                     Warranty: 5 years</p> <p>CT-930 includes:<br/>                     • Tool<br/>                     • Plastic tool case with die storage</p> | 1              |

Uses CD-920 and CD-930 color-coded crimping dies. Dies must be purchased separately, see page D3.50. CG-920 crimp force measurement gauge available, sold separately see page D3.55.

A. System Overview

B1. Cable Ties

B2. Cable Accessories

B3. Stainless Steel Ties

C1. Wiring Duct

C2. Surface Raceway

C3. Abrasion Protection

C4. Cable Management

D1. Terminals

D2. Power Connectors

D3. Grounding Connectors

E1. Labeling Systems

E2. Labels

E3. Pre-Printed & Write-On Markers

E4. Permanent Identification

E5. Lockout/Tagout & Safety Solutions

F. Index

A. System Overview

B1. Cable Ties

B2. Cable Accessories

B3. Stainless Steel Ties

C1. Wiring Duct

C2. Surface Raceway

C3. Abrasion Protection

C4. Cable Management

D1. Terminals

D2. Power Connectors

D3. Grounding Connectors

E1. Labeling Systems

E2. Labels

E3. Pre-Printed & Write-On Markers

E4. Permanent Identification

E5. Lockout/Tagout & Safety Solutions

F. Index

## **NEW!** Die Type, Lithium-Ion Powered Hydraulic, 6 Ton, In-Line Crimping Tool

- Lithium-ion battery powered, provides fingertip operation and up to 90% more crimps per battery charge than tools powered with NiCd or NiMH batteries
- Batteries incorporate LED fuel gage so battery charge level can be checked to allow for continuous operation
- In-line tool design with low profile, 180° rotating, enclosed crimp head design for reaching into tight spaces
- Approximately 2.9 second crimp cycle time provides quick terminations, 26% faster than tools with NiCd or NiMH batteries
- Lightweight and ergonomically balanced for easy operation without fatigue, weighs 7.15 lbs. with battery
- Battery charger charges expended batteries completely in 30-60 minutes
- Self-contained unit, completely portable
- Compatible with CD-2001 and CDM-2001 color-coded crimping dies to provide easy matching of crimping die to connector
- Develops 6 tons of crimping force, up to 389 crimps per battery charge using Panduit 500 kcmil copper lugs and splices
- Embosses die index number on connector barrels to provide post crimp inspection
- Provides UL Listed and CSA Certified connections on Panduit copper lugs, splices and taps
- Dies installed using spring loaded die retention pins, no need for tools
- Audible “pop-off” valve indicates crimp completion
- Tool provided with two, Milwaukee® M18™ XC high capacity lithium-ion 18VDC rechargeable batteries, battery charger, wrist strap and tool bag



CT-3001 and CT-3001/E



**FREE! Heavy-Duty Soft Sided Tool Bag Included**



PTB-HO (sold separately)



| Part Number | Charger Voltage | Part Description   | Std. Pkg. Qty. |
|-------------|-----------------|--|----------------|
| CT-3001     | 120 VAC         | Terminates Panduit Compression Connectors: <ul style="list-style-type: none"> <li>• Copper compression lugs and splices for #8 AWG – 500 kcmil code conductor</li> <li>• Copper compression lugs for #8 AWG – 373 kcmil flex conductor</li> <li>• Copper compression CTAPF taps for #10 – 3/0 AWG code conductor</li> <li>• Copper compression CTAP taps for #8 – #2 AWG code conductor</li> <li>• Copper compression S Series Pan-Term® Tubular Terminals for #8 AWG – 250 kcmil code conductor</li> <li>• Copper compression lugs and splices for 10mm² – 240mm² class 2R conductor</li> </ul> Specifications:<br>Output: 6 tons (54 Kn)<br>Jaw opening: 1.8" (45.7mm)<br>Weight: 7.15 lbs. (3.2 kg) with battery<br>Length: 19.5" (495.3mm), Height: 4.5" (114.3mm), Width: 2.88" (73mm)<br>Warranty: 3 years on tool, 5 years on batteries and charger | 1              |
| CT-3001/E   | 230 VAC         | Specifications:<br>Output: 6 tons (54 Kn)<br>Jaw opening: 1.8" (45.7mm)<br>Weight: 7.15 lbs. (3.2 kg) with battery<br>Length: 19.5" (495.3mm), Height: 4.5" (114.3mm), Width: 2.88" (73mm)<br>Warranty: 3 years on tool, 5 years on batteries and charger  | 1              |
| PTB-HO      | —               | Streamlined holster for CT-3001 Series tools. Can be secured to installer's tool belt or ladder/fixture with quick connect hooks provided.   | 1              |

Compatible with CD-2001 and CDM-2001 crimping dies, sold separately, see page D3.42.  
 \*Tool bag also sold separately, see part number PTB-GP on page D3.55.





## Die Type, Lithium-Ion Powered Hydraulic, 6 Ton, Crimping Tool with Open “C-Head”

- Lithium-Ion battery powered, provides fingertip operation and up to 120% more crimps per battery charge than tools powered with NiCd or NiMH batteries
- Pistol grip tool design with low profile, open “C-Head” provides easy loading of crimping dies and rotates 180°, for reaching into tight spaces
- Lightweight and ergonomically balanced for easy operation without fatigue, weighs 11.75 lbs. with battery
- Self-contained unit, completely portable
- Develops 6 tons of crimping force, crimps copper compression lugs and splices up to 500 kcmil, up to 260 crimps per battery charge using Panduit 500 kcmil copper lugs and splices
- Provides UL Listed and CSA Certified connections on Panduit copper lugs, splices, and taps
- Audible “pop-off” valve indicates crimp completion
- Tool provided with two, Milwaukee® M18™ XC high capacity lithium-ion 18VDC rechargeable batteries, battery charger, shoulder strap, and tool bag
- Batteries incorporate LED fuel gage so battery charge level can be checked to allow for continuous operation
- Approximately 3.1 second crimp cycle time provides quick terminations, 18% faster than tools using NiCd or NiMH batteries
- Battery charger charges expended batteries completely in 30-60 minutes
- Compatible with CD-2001 and CDM-2001 color-coded crimping dies to provide easy matching of crimping die to connector
- Embosses die index number on connector barrels to provide post crimp inspection
- Dies installed using spring loaded die retention pins, no need for tools



**FREE! Heavy-Duty Soft Sided Tool Bag Included**

| Part Number | Charger Voltage | Part Description  | Std. Pkg. Qty. |
|-------------|-----------------|---|----------------|
| CT-2002/L   | 120 VAC         | <p>Terminates Panduit Compression Connectors:</p> <ul style="list-style-type: none"> <li>• Copper compression lugs and splices for #8 AWG – 500 kcmil code conductor</li> <li>• Copper compression lugs for #8 AWG – 373 kcmil flex conductor</li> <li>• Copper compression S Series, Pan-Term™ Tubular Terminals for #8 – 250 kcmil code conductor</li> <li>• Copper compression lugs and splices for 10mm<sup>2</sup> – 240mm<sup>2</sup> class 2R conductor</li> <li>• Copper compression CTAPF taps for #10 – 3/0 AWG code conductor</li> <li>• Copper compression CTAP taps for #8 – #2 AWG code conductor</li> </ul> <p>Specifications:<br/>                     Output: 6 tons (54 Kn)<br/>                     Jaw opening: .95" (24.1mm)<br/>                     Weight: 11.75 lbs. (5.3 kg) with battery<br/>                     Length: 13.5" (334mm), Height: 15" (381mm), Width: 3" (76.2mm)<br/>                     Warranty: 5 years on tool, batteries and charger</p> <p>CT-2002/L includes:</p> <ul style="list-style-type: none"> <li>• Two Milwaukee® M18™ XC high capacity lithium-ion 18VDC rechargeable batteries</li> <li>• One Milwaukee® battery charger</li> <li>• One shoulder strap</li> <li>• Heavy-duty bag with storage for tools, batteries, charger, and crimping dies; includes 58 pockets and a shoulder strap for added convenience; 18"L x 7"W x 14"H*</li> <li>• Tool incorporates D3 die pocket</li> </ul> | 1              |

Compatible with CD-2001 and CDM-2001 crimping dies, sold separately, see page D3.42.

\*Tool bag also sold separately, see part number PTB-GP on page D3.55.

A. System Overview

B1. Cable Ties

B2. Cable Accessories

B3. Stainless Steel Ties

C1. Wiring Duct

C2. Surface Raceway

C3. Abrasion Protection

C4. Cable Management

D1. Terminals

D2. Power Connectors

D3. Grounding Connectors

E1. Labeling Systems

E2. Labels

E3. Pre-Printed & Write-On Markers

E4. Permanent Identification

E5. Lockout/Tagout & Safety Solutions

F. Index

A. System Overview

B1. Cable Ties

B2. Cable Accessories

B3. Stainless Steel Ties

C1. Wiring Duct

C2. Surface Raceway

C3. Abrasion Protection

C4. Cable Management

D1. Terminals

D2. Power Connectors

D3. Grounding Connectors

E1. Labeling Systems

E2. Labels

E3. Pre-Printed & Write-On Markers

E4. Permanent Identification

E5. Lockout/Tagout & Safety Solutions

F. Index

## CD-2001 Crimping Dies

- Color-coded to provide easy matching to color-coding marked on connectors
- Embosses die index number on connector barrels to provide post crimp inspection
- Part number permanently marked on crimping die for easy identification
- Provide circumferential crimp results in terminations with premium electrical and mechanical performance



CD-2001

| Part Number | Used to Install Panduit Compression Lug and Splice Sizes |  |  |  | Std. Pkg. Qty. |
|-------------|--|--|--|--|----------------|
|             | Copper Die Color and Die No.                             | Copper Code Conductor Size             | Copper Code and Flex Conductor Size for LCAX, LCBX, LCDX, LCCX | Copper Metric Class 2R Conductor Size  |                |
| CD-2001-8   | Red P21  | #8 AWG                                 | #8 AWG   | 10mm <sup>2</sup>                      | 1              |
| CD-2001-6   | Blue P24   | #6 AWG                                 | #6 AWG   | 16mm <sup>2</sup>                      | 1              |
| CD-2001-4   | Gray P29   | #4 AWG STR<br>#3 AWG STR<br>#2 AWG SOL | #4 AWG<br>#5, #4, #3 AWG<br>DLO flex                           | 25mm <sup>2</sup><br>35mm <sup>2</sup> | 1              |
| CD-2001-2   | Brown P33  | #2 AWG                                 | #2 AWG   | —                                      | 1              |
| CD-2001-1   | Green P37  | #1 AWG                                 | #1 AWG   | 50mm <sup>2</sup>                      | 1              |
| CD-2001-1/0 | Pink P42   | 1/0 AWG                                | 1/0 AWG  | —                                      | 1              |
| CD-2001-2/0 | Black P45  | 2/0 AWG                                | 2/0 AWG  | 70mm <sup>2</sup>                      | 1              |
| CD-2001-3/0 | Orange P50   | 3/0 AWG                                | 3/0 AWG  | —                                      | 1              |
| CD-2001-4/0 | Purple P54   | 4/0 AWG                                | 4/0 AWG  | 95mm <sup>2</sup>                      | 1              |
| CD-2001-250 | Yellow P62   | 250 kcmil                              | 250 kcmil flex<br>262 kcmil flex                               | 120mm <sup>2</sup>                     | 1              |
| CD-2001-300 | White P66  | 300 kcmil                              | —  | 150mm <sup>2</sup>                     | 1              |
| CD-2001-350 | Red P71  | 350 kcmil                              | 300 kcmil flex<br>313 kcmil flex                               | —                                      | 1              |
| CD-2001-400 | Blue P76   | 400 kcmil                              | 350 kcmil flex<br>373 kcmil flex                               | 185mm <sup>2</sup>                     | 1              |
| CD-2001-500 | Brown P87  | 500 kcmil                              | —  | 240mm <sup>2</sup>                     | 1              |

| Part Number | Used to Install Panduit Tap Part Numbers |               |               | Std. Pkg. Qty. |
|-------------|--|---------------|---------------|----------------|
|             | Copper Die Color and Die No.             | Copper Tap    | No. of Crimps |                |
| CD-2001-8   | Red P21                                  | CTAPF10-16-C  | 1             | 1              |
| CD-2001-6   | Blue P24                                 | CTAPF8-12-C   | 1             | 1              |
| CD-2001-4   | Gray P29                                 | CTAPF6-12-C   | 1             | 1              |
| CD-2001-2   | Brown P33                                | CTAPF4-12-C   | 2             | 1              |
| CD-2001-1   | Green P37                                | CTAPF3-12-C   | 2             | 1              |
| CD-2001-1/0 | Pink P42                                 | CTAPF2-12-C   | 2             | 1              |
| CD-2001-2/0 | Black P45                                | CTAPF1-12-C   | 3             | 1              |
| CD-2001-3/0 | Orange P50                               | CTAPF1/0-12-L | 3             | 1              |
| CD-2001-4/0 | Purple P54                               | CTAPF2/0-12-Q | 3             | 1              |
| CD-2001-250 | Yellow P62                               | CTAPF3/0-12-Q | 3             | 1              |
| CD-2001-BG  | PBG                                      | CTAP4-8-L     | 1             | 1              |
|             | PBG                                      | CTAP4-6-L     | 1             |                |
|             | PBG                                      | CTAP4-4-L     | 1             |                |
| CD-2001-C   | P-C                                      | CTAP2-4-Q     | 2             | 1              |
|             | P-C                                      | CTAP2-2-X     | 2             |                |

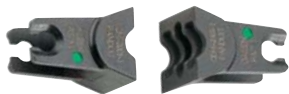

CDM-2001

### Multi-Crimp Dies – Multiple Crimps in One Tool Cycle

|              |             |               |   |   |
|--------------|-------------|---------------|---|---|
| CDM-2001-2   | Brown P33M  | CTAPF4-12-C   | 1 | 1 |
| CDM-2001-1   | Green P37M  | CTAPF3-12-C   | 1 | 1 |
| CDM-2001-1/0 | Pink P42M   | CTAPF2-12-C   | 1 | 1 |
| CDM-2001-2/0 | Black P45M  | CTAPF1-12-C   | 2 | 1 |
| CDM-2001-3/0 | Orange P50M | CTAPF1/0-12-L | 2 | 1 |



## Die Type, Lithium-Ion Powered Hydraulic, 14 Ton, Crimping Tool

- Lithium-Ion battery powered, provides fingertip operation and up to 63% more crimps per battery charge than tools powered with NiCd or NiMH batteries
- Pistol grip tool design with open "C-Head" provides easy loading of crimping dies and rotates 180°, for reaching into tight spaces
- Ergonomically balanced for easy operation without fatigue, weighs 17.9 lbs. with battery
- Self-contained unit, completely portable
- Develops 14 tons of crimping force, crimps copper compression lugs and splices up to 750 kcmil, up to 78 crimps per battery charge using Panduit 500 kcmil copper lugs and splices
- Provides UL Listed and CSA Certified connections on Panduit copper and aluminum lugs and splices and copper taps
- Audible "pop-off" valve indicates crimp completion or Ram automatically retracts when crimp cycle is complete
- Tool provided with two, Milwaukee® M18™ XC high capacity lithium-ion 18VDC rechargeable batteries, battery charger, shoulder strap, and tool bag
- Batteries incorporate LED fuel gage so battery charge level can be checked to allow for continuous operation
- Approximately 9.6 second crimp cycle time provides quick terminations, 30% faster than tools using NiCd or NiMH batteries
- Battery charger charges expended batteries completely in 30-60 minutes
- Compatible with CD-920, CDM-920, and CD-930 color-coded crimping dies to provide easy matching of crimping die to connector
- Embosses die index number on connector barrels to provide post crimp inspection
- Dies installed using spring loaded die retention pins, no need for tools



CT-2930/L and CT-2930/LE



FREE! Heavy-Duty Soft Sided Tool Bag Included



| Part Number | Charger Voltage | Part Description   | Std. Pkg. Qty. |
|-------------|-----------------|--|----------------|
| CT-2930/L   | 120 VAC         | <p>Terminates Panduit compression connectors:</p> <ul style="list-style-type: none"> <li>• Copper compression lugs and splices for #8 AWG – 750 kcmil code conductor</li> <li>• Copper compression lugs for #8 AWG – 600 kcmil flex conductor</li> <li>• Copper compression S Series, Pan-Term™ Tubular Terminals for #8 AWG – 250 kcmil code conductor</li> <li>• Copper compression lugs and splices for 10mm<sup>2</sup> – 400mm<sup>2</sup> class 2R conductor</li> <li>• StructuredGround™ Direct Burial Compression Grounding System connectors #6 AWG – 250 kcmil code conductor and select 500 kcmil conductor combinations</li> <li>• Copper compression CTAPF taps for #10 – 3/0 AWG code conductor</li> <li>• Copper compression CTAP taps for #8 – 4/0 AWG code conductor</li> <li>• Copper compression HTCT taps for #14 AWG – 250 kcmil code conductor, #14-4/0 AWG flex conductor</li> <li>• Aluminum compression lugs and splices for #6 AWG – 600 kcmil code conductor</li> </ul> <p>Specifications:<br/>                     Output: 14 tons (124.5 Kn)<br/>                     Jaw opening: 1.65" (41.9mm)<br/>                     Weight: 17.90 lbs. (8.1 kg) with battery<br/>                     Length: 14.5" (368.3mm), Height: 16.5" (419.1mm), Width: 3.25" (82.6mm)<br/>                     Warranty: 5 years on tool, batteries, and charger</p> | 1              |
| CT-2930/LE  | 230 VAC         | <p>Tool includes:</p> <ul style="list-style-type: none"> <li>• Two Milwaukee® M18™ XC high capacity lithium-ion 18VDC rechargeable batteries</li> <li>• One Milwaukee® battery charger</li> <li>• One shoulder strap</li> <li>• Heavy-duty bag with storage for tool, batteries, charger, and crimping dies; includes 58 pockets and a shoulder strap for added convenience; 18"L x 7"W x 14"H*</li> </ul>   | 1              |

Compatible with CD-920, CDM-920, and CD-930 crimping dies, sold separately, see page D3.50.

\*Tool bag also sold separately, see part number PTB-GP on page D3.55.

A. System Overview

B1. Cable Ties

B2. Cable Accessories

B3. Stainless Steel Ties

C1. Wiring Duct

C2. Surface Raceway

C3. Abrasion Protection

C4. Cable Management

D1. Terminals

D2. Power Connectors

D3. Grounding Connectors

E1. Labeling Systems

E2. Labels

E3. Pre-Printed & Write-On Markers

E4. Permanent Identification

E5. Lockout/Tagout & Safety Solutions

F. Index

A. System Overview

B1. Cable Ties

B2. Cable Accessories

B3. Stainless Steel Ties

C1. Wiring Duct

C2. Surface Raceway

C3. Abrasion Protection

C4. Cable Management

D1. Terminals

D2. Power Connectors

D3. Grounding Connectors

E1. Labeling Systems

E2. Labels

E3. Pre-Printed & Write-On Markers

E4. Permanent Identification

E5. Lockout/Tagout & Safety Solutions

F. Index



## NEW! Die Type, Lithium-Ion Powered Hydraulic, 15 Ton, Crimping Tool

- Lithium-ion battery powered, provides fingertip operation and up to 43% more crimps per battery charge than tools powered with NiCd or NiMH batteries
- Flip-top crimp head allows easy loading of crimping dies and connectors and rotates 180°
- Ergonomically balanced for easy operation without fatigue, weighs 24.4 lbs. with battery
- Self-contained unit, completely portable
- Develops 15 tons of crimping force, crimps copper compression lugs, splices and taps up to 1000 kcmil, up to 63 crimps per battery charge when crimping Panduit 500 kcmil copper lugs
- Provides UL Listed and CSA Certified connections on Panduit copper and aluminum lugs and splices and copper taps
- Audible “pop-off” valve indicates crimp completion
- Tool provided with two, Milwaukee® M18™ XC high capacity lithium-ion 18VDC rechargeable batteries, battery charger, and shoulder strap
- Batteries incorporate LED fuel gage so battery charge level can be checked to allow for continuous operation
- Approximately 8.8 second crimp cycle time provides quick terminations, 27% faster than tools using NiCd or NiMH batteries
- Battery charger charges expended batteries completely in 30-60 minutes
- Compatible with CD-940, CD-920, CDM-920, and CD-930 color-coded crimping dies to provide easy matching of crimping die to connector
- Embosses die index number on connector barrels to provide post crimp inspection
- Dies installed using spring loaded die retention pins, no need for tools



CT-2940/L and CT-2940/LE



| Part Number | Charger Voltage | Part Description  | Std. Pkg. Qty. |
|-------------|-----------------|---|----------------|
| CT-2940/L   | 120 VAC         | Terminates Panduit Compression Connectors: <ul style="list-style-type: none"> <li>• Copper compression lugs and splices for #8 AWG – 1000 kcmil code conductor</li> <li>• Copper compression lugs for #8 AWG – 777.7 kcmil flex conductor</li> <li>• Copper compression S Series, Pan-Term™ Tubular Terminals for #8 – 250 kcmil code conductor</li> <li>• Copper compression lugs and splices for 10mm<sup>2</sup> – 630mm<sup>2</sup> class 2R conductor</li> <li>• StructuredGround™ Direct Burial Compression Grounding System connectors #6 AWG – 500 kcmil code conductor</li> <li>• Copper compression CTAPF taps for #10 – 3/0 AWG code conductor</li> <li>• Copper compression CTAP taps for #8 – 4/0 AWG code conductor</li> <li>• Copper compression HTCT taps for #14 AWG – 250 kcmil code conductor, #14 – 4/0 AWG flex conductor</li> <li>• Aluminum compression lugs and splices for #6 AWG – 1000 kcmil code conductor</li> </ul> | 1              |
| CT-2940/LE  | 230 VAC         | Specifications:<br>Output: 15 tons (136 Kn)<br>Jaw opening: 2" (50.8mm)<br>Weight: 24.35 lbs. (11.0 kg) with battery<br>Length: 22" (558.8mm), Height: 10.75" (273.1mm), Width: 3.75" (95.3mm)<br>Warranty: 5 years on tool, batteries and charger<br><br>Tool includes: <ul style="list-style-type: none"> <li>• Two Milwaukee® M18™ XC high capacity lithium-ion 18VDC rechargeable batteries</li> <li>• One Milwaukee® battery charger</li> <li>• One shoulder strap</li> <li>• Plastic tool case with storage for tool, batteries, charger, shoulder strap and crimping dies</li> </ul>   | 1              |

Compatible with CD-940 crimping dies, sold separately, see page D3.51.

Also works with CD-920, CDM-920, and CD-930 crimping dies, on page D3.50 with CD-940-DA die adapter, sold separately, see page D3.51.

## Die Type, Remote Hydraulic, 14 Ton, Crimp Head

- Develops 14 tons of crimping force when used with 10,000 psi hydraulic pump and hose, crimps copper compression lugs and splices up to 750 kcmil
- Incorporates Parker type quick-connect fittings to ease installation and save time
- High quality, durable tool construction provides long-term dependability
- Provides UL Listed and CSA Certified connections on Panduit® Pan-Lug™ Copper and Aluminum Lugs and Splices and Copper Taps
- Open “C-Head” design allows easy loading of crimping dies and connectors, saves time
- Uses color-coded crimping dies to provide easy matching of crimping die to connector
- Embosses die index number on connector barrels for post crimp inspection
- Dies installed using spring loaded die retention pins, no need for tools
- Cast in handle allows crimp head to be mounted in a bench vice



| Part Number | Part Description  | Std. Pkg. Qty. |
|-------------|---|----------------|
| CT-930CH    | <p>Terminates Panduit compression connectors:</p> <ul style="list-style-type: none"> <li>• Copper compression lugs and splices for #8 AWG – 750 kcmil code conductor</li> <li>• Copper compression lugs for #8 AWG – 600 kcmil flex conductor</li> <li>• Copper compression S Series, Pan-Term™ Tubular Terminals for #8 AWG – 250 kcmil code conductor</li> <li>• Copper compression lugs and splices for 10mm<sup>2</sup> – 400mm<sup>2</sup> class 2R conductor</li> <li>• StructuredGround™ Direct Burial Compression Grounding System connectors #6 AWG – 250 kcmil code conductor and select 500 kcmil conductor combinations</li> <li>• Copper compression CTAPF taps for #10 – 3/0 AWG code conductor</li> <li>• Copper compression CTAP taps for #8 – 4/0 AWG code conductor</li> <li>• Copper compression HTCT taps for #14 AWG – 250 kcmil code conductor, #14-4/0 AWG flex conductor</li> <li>• Aluminum compression lugs and splices for #6 AWG – 600 kcmil code conductor</li> </ul> <p>Use with Panduit CT-901HP hydraulic pump and CT-900HPH 10' hydraulic hose.*</p> <p>Specifications:<br/>                     Output: 14 tons<br/>                     Jaw opening: 1.65"<br/>                     Weight: 11 lbs.<br/>                     Length: 12 1/4"<br/>                     Height: 5"<br/>                     Width: 3"<br/>                     Warranty: 5 years</p> <p>CT-930CH includes:</p> <ul style="list-style-type: none"> <li>• Tool</li> <li>• Steel tool case</li> <li>• Supplied with female Parker type quick-connect fitting assembled to tool</li> </ul> | 1              |

Uses CD-920 and CD-930 color-coded crimping dies. Dies must be purchased separately, see page D3.50.

\*CT-901RCH remote control handle available, offering one hand operation of crimp head with Panduit CT-901HP hydraulic pump and CT-900HPH hose, sold separately, see page D3.47. CG-920 crimp force measurement gauge available, sold separately, see page D3.55.

A.  
System  
Overview

B1.  
Cable Ties

B2.  
Cable  
Accessories

B3.  
Stainless  
Steel Ties

C1.  
Wiring  
Duct

C2.  
Surface  
Raceway

C3.  
Abrasion  
Protection

C4.  
Cable  
Management

D1.  
Terminals

D2.  
Power  
Connectors

D3.  
Grounding  
Connectors

E1.  
Labeling  
Systems

E2.  
Labels

E3.  
Pre-Printed  
& Write-On  
Markers

E4.  
Permanent  
Identification

E5.  
Lockout/  
Tagout  
& Safety  
Solutions

F.  
Index

A. System Overview

## Die Type, Remote Hydraulic, 15 Ton, Crimp Head

B1. Cable Ties

• Develops 15 tons of crimping force when used with 10,000 psi hydraulic pump and hose, crimps copper compression lugs and splices up to 1,000 kcmil

• Open “C-Head” design allows easy loading of crimping dies and connectors, saves time

B2. Cable Accessories

• Incorporates Parker type quick-connect fittings to ease installation and save time

• Uses color-coded crimping dies to provide easy matching of crimping die to connector

• High quality, durable tool construction provides long-term dependability

• Embosses die index number on connector barrels for post crimp inspection

B3. Stainless Steel Ties

• Provides UL Listed and CSA Certified connections on Panduit® Pan-Lug™ Copper and Aluminum Lugs and Splices and Copper Taps

• Dies installed using spring loaded die retention pins, no need for tools

• Cast in handle allows crimp head to be mounted in a bench vice



C1. Wiring Duct

C2. Surface Raceway

C3. Abrasion Protection

C4. Cable Management

D1. Terminals

D2. Power Connectors

D3. Grounding Connectors

E1. Labeling Systems

E2. Labels

E3. Pre-Printed & Write-On Markers

E4. Permanent Identification

E5. Lockout/Tagout & Safety Solutions

F. Index

| Part Number | Part Description  | Std. Pkg. Qty. |
|-------------|---|----------------|
| CT-940CH    | <p>Terminates Panduit Compression Connectors:</p> <ul style="list-style-type: none"> <li>• Copper compression lugs and splices for #8 AWG – 1000 kcmil code conductor</li> <li>• Copper compression lugs for #8 AWG – 777.7 kcmil flex conductor</li> <li>• Copper compression S Series, Pan-Term™ Tubular Terminals for #8 – 250 kcmil code conductor</li> <li>• Copper compression lugs and splices for 10mm<sup>2</sup> – 630mm<sup>2</sup> class 2R conductor</li> <li>• StructuredGround™ Direct Burial Compression Grounding System connectors #6 AWG – 500 kcmil code conductor</li> <li>• Copper compression CTAPF taps for #10 – 3/0 AWG code conductor</li> <li>• Copper compression CTAP taps for #8 – 4/0 AWG code conductor</li> <li>• Copper compression HTCT taps for #14 AWG – 250 kcmil code conductor, #14 – 4/0 AWG flex conductor</li> <li>• Aluminum compression lugs and splices for #6 AWG – 1000 kcmil code conductor</li> </ul> <p>Use with Panduit CT-901HP hydraulic pump and CT-900HPH 10' hydraulic hose.*</p> <p>Specifications:<br/>                     Output: 15 tons<br/>                     Jaw opening: 2"<br/>                     Weight: 14.5 lbs.<br/>                     Length: 14.5"<br/>                     Height: 4.1"<br/>                     Width: 2.5"<br/>                     Warranty: 5 years</p> <p>CT-940CH includes:<br/>                     • Tool<br/>                     • Steel tool case<br/>                     • Supplied with female Parker type quick-connect fitting assembled to tool</p> | 1              |

Uses CD-920 and CD-930 color-coded crimping dies with CD-940-DA die adapter. Uses color-coded CD-940 crimping dies. Crimping dies and die adapter must be purchased separately, see pages D3.50 and D3.51. CG-940 crimp force measurement gauge available, sold separately, see page D3.55.

\*CT-901RCH remote control handle available, offering one hand operation of crimp head with Panduit CT-901HP hydraulic pump and CT-900HPH hose, sold separately, see page D3.47.



## Hydraulic Pump and Accessories, Electric, 10,000 PSI

- Develops 10,000 psi of hydraulic pressure
- Easy to operate using manual switch or remote pendant supplied; or optional CT-901RFS foot switch or CT-901RCH remote controlled handle
- Factory set relief valve, pump stops when crimp is complete
- Convenient 120 VAC operation
- Incorporates Parker type quick-connect fittings to ease installation and save time
- Versatile, can be used with Panduit CT-930CH, CT-940CH, or CT-980CH crimp heads



CT-901HP



CT-900HPH



CT-901RCH



CT-901RFS

| Part Number | Part Description  | Std. Pkg. Qty. |
|-------------|---|----------------|
| CT-901HP    | <p>Hydraulic pump. Develops 10,000 PSI output. Pump shuts off when cycle is complete. Will not release until down switch is activated. Compatible with CT-900HPH hydraulic hose, CT-930CH, CT-940CH, and CT-980CH crimp heads sold separately.*</p> <p>Specifications:<br/>                     Pump output: 10,000 psi<br/>                     Tank capacity: 2.5L incorporates sight gauge for visual inspection of fluid level<br/>                     Fluid type: Aero Shell #4 or equal<br/>                     Motor: 120 VAC 50/50Hz<br/>                     Current: 6.5 Amps<br/>                     Horsepower: 1/2 hp<br/>                     Weight: 34 lbs.<br/>                     Length: 7"<br/>                     Height: 14"<br/>                     Width: 6"<br/>                     Warranty: 5 years</p> <p>CT-901HP pump includes:<br/>                     • On/off pendant switch on 10' electric cord<br/>                     • Three prong A/C plug on 10' electric cord<br/>                     • Supplied with female Parker type quick-connect fitting assembled to pump</p> | 1              |
| CT-900HPH   | Electrically non-conductive 10' hose compatible with Panduit CT-901HP hydraulic pump and CT-930CH, CT-940CH, and CT-980CH crimp heads, supplied pre-filled with hydraulic fluid for fast start up. Supplied with two male Parker type quick-connect fittings. Warranty: 5 years.  | 1              |
| CT-901RCH   | Remote control handle provides plastic carrying handle incorporating on/off activation switch that allows operator to hold crimp head and activate CT-901HP hydraulic pump with one hand. Use with Panduit remote hydraulic crimp heads CT-930CH, CT-940CH, and CT-980CH. Equipped with 3/8" Parker type quick-connect coupler for attaching crimp heads to Panduit CT-900HPH hydraulic hose. Includes a 10', three wire control cable that can be directly connected to the CT-901HP pump. Warranty: 5 years.  | 1              |
| CT-901RFS   | Dual electrical foot switch that allows convenient "hands free" operation of the Panduit CT-901HP or CT-8250HP electric hydraulic pumps used with Panduit remote hydraulic crimp heads. Supplied with 10' electric cord that can be directly connected to Panduit hydraulic pumps. Warranty: 5 years.   | 1              |

Contact Panduit Customer Service for use in production environments.  
 \*For information on crimp heads, see pages D3.45, D3.46, and D3.54.

A. System Overview

B1. Cable Ties

B2. Cable Accessories

B3. Stainless Steel Ties

C1. Wiring Duct

C2. Surface Raceway

C3. Abrasion Protection

C4. Cable Management

D1. Terminals

D2. Power Connectors

D3. Grounding Connectors

E1. Labeling Systems

E2. Labels

E3. Pre-Printed & Write-On Markers

E4. Permanent Identification

E5. Lockout/Tagout & Safety Solutions

F. Index

A. System Overview

## Die Type, Remote Hydraulic, 10.5 Ton, Crimp Head

B1. Cable Ties

- Low pressure system extends life of crimp head for high volume crimping applications

- Open “C-Head” design allows easy loading of crimping dies and connectors, saves time

B2. Cable Accessories

- Develops 10.5 tons of crimping force when used with 7,500 psi hydraulic pump and hose, crimps copper compression lugs and splices up to 250 kcmil
- Incorporates Parker type quick-connect fittings to ease installation and save time

- Uses color-coded crimping dies to provide easy matching of crimping die to connector

B3. Stainless Steel Ties

- High quality, durable tool construction and low pressure hydraulic requirements provide long-term dependability and tool life
- Provides UL Listed and CSA Certified connections on Panduit® Pan-Lug™ Copper Lugs and Splices

- Embosses die index number on connector barrels for post crimp inspection

- Dies installed using spring loaded die retention pins, no need for tools

- Cast in handle allows crimp head to be mounted in a bench vice

C1. Wiring Duct



C2. Surface Raceway

C3. Abrasion Protection

C4. Cable Management

| Part Number       | Part Description  | Std. Pkg. Qty. |
|-------------------|---|----------------|
| <b>CT-930LPCH</b> | <p>Remote hydraulic crimp head provides UL Listed or Recognized terminations of Panduit® Pan-Lug™ Copper Compression Lugs and Splices for #8 AWG – 250 kcmil copper code conductor and 10 – 120mm<sup>2</sup> copper class 2R conductor.</p> <p>Use with Panduit CT-8250HP hydraulic pump and CT-900LPHPH 10' hydraulic hose.*</p> <p>Specifications:<br/>                     Output: 10.5 tons<br/>                     Jaw opening: 1.65"<br/>                     Weight: 11 lbs.<br/>                     Length: 12 1/4"<br/>                     Height: 5"<br/>                     Width: 3"<br/>                     Warranty: 5 years</p> <p>CT-930LPCH includes:<br/>                     • Tool<br/>                     • Steel tool case<br/>                     • Supplied with male Parker type quick-connect fitting assembled to tool</p> | 1              |

Uses CD-920 color-coded crimping dies. Dies must be purchased separately, see page D3.50. PG-1 in-line pressure gauge provides visual measurement of hydraulic output pressure, sold separately, see page D3.55.  
 \*For information on hydraulic pump and hose, see page D3.49.

D1. Terminals

D2. Power Connectors

D3. Grounding Connectors

E1. Labeling Systems

E2. Labels

E3. Pre-Printed & Write-On Markers

E4. Permanent Identification

E5. Lockout/Tagout & Safety Solutions

F. Index

## Hydraulic Pump and Accessories, Electric, 7,500 PSI

- Develops 7,500 psi of hydraulic pressure
- Easy to operate using manual switch or remote pendant supplied; or optional CT-901RFS foot switch
- Factory set relief valve, pump stops when crimp is complete
- Convenient 120 VAC operation
- Incorporates Parker type quick-connect fittings to ease installation and save time
- Versatile, can be used with Panduit CT-930LPCH or CT-980LPCH crimp heads



CT-8250HP



CT-900LPPH



CT-901RFS

| Part Number | Part Description  | Std. Pkg. Qty. |
|-------------|---|----------------|
| CT-8250HP   | <p>Hydraulic pump. Develops 7,500 psi output. Pump shuts off when cycle is complete. Will not release until down switch is activated. Compatible with CT-900LPPH hydraulic hose, CT-930LPCH, and CT-980LPCH crimp heads sold separately.*</p> <p>Specifications:<br/>                     Pump output: 7,500 psi<br/>                     Tank capacity: 2.5L incorporates sight gauge for visual inspection of fluid level<br/>                     Fluid type: Aero Shell #4 or equal<br/>                     Motor: 120 VAC 50/50Hz<br/>                     Current: 6.5 Amps<br/>                     Horsepower: 1/2 hp<br/>                     Warranty: 5 years</p> <p>Weight: 34 lbs.<br/>                     Length: 7"<br/>                     Height: 14"<br/>                     Width: 6"</p> <p>CT-8250HP pump includes:<br/>                     • On/off pendant switch on 10' electric cord<br/>                     • Three prong A/C plug on 10' electric cord<br/>                     • Supplied with male Parker type quick-connect fitting assembled to pump</p> | 1              |
| CT-900LPPH  | Electrically non-conductive 10' hose compatible with Panduit CT-8250HP hydraulic pump and CT-930LPCH and CT-980LPCH crimp heads, supplied pre-filled with hydraulic fluid for fast start up. Supplied with two female Parker type quick-connect fittings. Warranty: 5 years.  | 1              |
| CT-901RFS   | Dual electrical foot switch that allows convenient "hands free" operation of the Panduit CT-901HP or CT-8250HP electric hydraulic pumps used with Panduit remote hydraulic crimp heads. Supplied with 10' electric cord that can be directly connected to Panduit hydraulic pumps. Warranty: 5 years.   | 1              |

\*For more information on crimp heads, see pages D3.48 and D3.54.

PG-1 in-line pressure gauge provides visual measurement of hydraulic output pressure, sold separately, see page D3.55.

A.  
System  
Overview

B1.  
Cable Ties

B2.  
Cable  
Accessories

B3.  
Stainless  
Steel Ties

C1.  
Wiring  
Duct

C2.  
Surface  
Raceway

C3.  
Abrasion  
Protection

C4.  
Cable  
Management

D1.  
Terminals

D2.  
Power  
Connectors

D3.  
Grounding  
Connectors

E1.  
Labeling  
Systems

E2.  
Labels

E3.  
Pre-Printed  
& Write-On  
Markers

E4.  
Permanent  
Identification

E5.  
Lockout/  
Tagout  
& Safety  
Solutions

F.  
Index

A. System Overview

## CD-920 Crimping Dies

B1. Cable Ties

- Color-coded for easy matching to color-coding marked on connectors
- Embosses die index number on connector barrels for post crimp inspection

- Part number permanently marked on crimping die for easy identification
- Provides circumferential crimp results in terminations with premium electrical and mechanical performance

B2. Cable Accessories

B3. Stainless Steel Ties

C1. Wiring Duct

C2. Surface Raceway

C3. Abrasion Protection

C4. Cable Management

D1. Terminals

D2. Power Connectors

D3. Grounding Connectors

E1. Labeling Systems

E2. Labels

E3. Pre-Printed & Write-On Markers

E4. Permanent Identification

E5. Lockout/Tagout & Safety Solutions

F. Index

### Used to Install Panduit Compression Lug and Splice Sizes

| Part Number | Copper Die Color and Die No. | Copper Code Conductor Size             | Copper Code and Flex Conductor Size for LCAX, LCBX LCDX, LCCX | Copper Flex Conductor Size for LCAF, LCCF, SCSF | Copper Metric Class 2R Conductor Size  | Aluminum Die Color and Die No. | Aluminum Code Conductor Size | Std. Pkg. Qty. |
|-------------|------------------------------|--|---|---|--|--------------------------------|------------------------------|----------------|
| CD-920-8    | Red P21                      | #8 AWG                                 | #8 AWG  | #8 AWG  | 10mm <sup>2</sup>                      | —                              | —                            | 1              |
| CD-920-6    | Blue P24                     | #6 AWG                                 | #6 AWG  | #6 AWG  | 16mm <sup>2</sup>                      | —                              | —                            | 1              |
| CD-920-4    | Gray P29                     | #4 AWG STR<br>#3 AWG STR<br>#2 AWG SOL | #4 AWG<br>#5, #4, #3 AWG<br>DLO flex                          | #4 AWG  | 25mm <sup>2</sup><br>35mm <sup>2</sup> | Gray P29                       | #6 AWG                       | 1              |
| CD-920-2    | Brown P33                    | #2 AWG                                 | #2 AWG  | #2 AWG  | —                                      | —                              | —                            | 1              |
| CD-920-1    | Green P37                    | #1 AWG                                 | #1 AWG  | —   | 50mm <sup>2</sup>                      | Green P37                      | #4 AWG                       | 1              |
| CD-920-1/0  | Pink P42                     | 1/0 AWG                                | 1/0 AWG   | #1 AWG  | —                                      | Pink P42                       | #2 AWG                       | 1              |
| CD-920-2/0  | Black P45                    | 2/0 AWG                                | 2/0 AWG   | 1/0 AWG   | 70mm <sup>2</sup>                      | Gold P45                       | #1 AWG                       | 1              |
| CD-920-3/0  | Orange P50                   | 3/0 AWG                                | 3/0 AWG   | 2/0 AWG   | —                                      | Tan P50                        | 1/0 AWG                      | 1              |
| CD-920-4/0  | Purple P54                   | 4/0 AWG                                | 4/0 AWG   | 3/0 AWG   | 95mm <sup>2</sup>                      | Olive P54                      | 2/0 AWG                      | 1              |
| CD-920-250  | Yellow P62                   | 250 kcmil                              | 250 kcmil flex<br>262 kcmil flex                              | 4/0 AWG   | 120mm <sup>2</sup>                     | Ruby P62                       | 3/0 AWG                      | 1              |
| CD-920-300  | White P66                    | 300 kcmil                              | —   | 250 kcmil<br>262 kcmil                          | 150mm <sup>2</sup>                     | White P66                      | 4/0 AWG                      | 1              |
| CD-920-350  | Red P71                      | 350 kcmil                              | 300 kcmil flex<br>313 kcmil flex                              | 300 kcmil<br>313 kcmil                          | —                                      | Red P71                        | 250 kcmil                    | 1              |
| CD-920-400  | Blue P76                     | 400 kcmil                              | 350 kcmil flex<br>373 kcmil flex                              | 350 kcmil<br>373 kcmil                          | 185mm <sup>2</sup>                     | Blue P76                       | 300 kcmil                    | 1              |
| CD-920-500  | Brown P87                    | 500 kcmil                              | 444 kcmil flex<br>450 kcmil flex                              | 444 kcmil<br>450 kcmil                          | 240mm <sup>2</sup>                     | Brown P87                      | 350 kcmil                    | 1              |
| CD-920-600  | Green P94                    | 600 kcmil                              | —   | —   | 300mm <sup>2</sup>                     | Green P94                      | 400 kcmil                    | 1              |
| CD-920-500A | Pink P99                     | 500 kcmil                              | 500 kcmil flex<br>535 kcmil flex<br>600 kcmil flex            | 500 kcmil<br>535 kcmil                          | —                                      | Pink P99                       | 500 kcmil                    | 1              |
| CD-920-750  | Black P106                   | 750 kcmil                              | —   | 646 kcmil                                       | 400mm <sup>2</sup>                     | Black P106                     | 600 kcmil                    | 1              |



CD-920



CD-930H



CD-930G

### Used to Install Panduit Tap Part Numbers

| Part Number | Copper Die Color and Die No. | Copper Tap                                | No. of Crimps | Std. Pkg. Qty. |
|-------------|------------------------------|---|---------------|----------------|
| CD-920H-6   | Orange PH6                   | HTCT6X-6X-1                               | 1             | 1              |
| CD-920H-2   | Brown PH2                    | HTCT2-2-1                                 | 1             | 1              |
| CD-930H-250 | Purple PH25                  | HTCT250-2-1, HTCT250-250-1                | 1             | 1              |
| CD-920-BG   | PBG                          | CTAP4-8-L, CTAP4-6-L, CTAP4-4-L           | 1             | 1              |
| CD-920-C    | PC                           | CTAP2-4-Q, CTAP2-2-X                      | 1             | 1              |
| CD-920-D3   | PD3                          | CTAP4/0-2-X, CTAP4/0-2/0-X, CTAP4/0-4/0-X | 1             | 1              |
| CD-920-O    | PO                           | CTAP2/0-2-X, CTAP2/0-2/0-X                | 1             | 1              |

### Multiple Crimp Dies – Multiple Crimps in One Tool Cycle

|             |             |               |   |   |
|-------------|-------------|---------------|---|---|
| CDM-920-2   | Brown P33M  | CTAPF4-12-C   | 1 | 1 |
| CDM-920-1   | Green P37M  | CTAPF3-12-C   | 1 | 1 |
| CDM-920-1/0 | Pink P42M   | CTAPF2-12-C   | 1 | 1 |
| CDM-920-2/0 | Black P45M  | CTAPF1-12-C   | 1 | 1 |
| CDM-920-3/0 | Orange P50M | CTAPF1/0-12-L | 1 | 1 |
| CDM-920-4/0 | Purple P54M | CTAPF2/0-12-Q | 1 | 1 |
| CDM-920-250 | Yellow P62M | CTAPF3/0-12-Q | 1 | 1 |

### Used to Install StructuredGround™ Direct Burial Grounding Connector Part Numbers

| Part Number | Copper Die Color and Die No. | Copper Tap   | Std. Pkg. Qty. |
|-------------|------------------------------|--|----------------|
| CD-930G-1/0 | Red PG10                     | GCE1/0-1/0, GCC6X61/0-1/0  | 1              |
| CD-930G-250 | Black PG25                   | GCE250-1/0, GCE250-250, GCC6X6250-1/0, GCC6X6250-250, GPC4H250-2 | 1              |
| CD-930G-500 | Blue PG50                    | GCE500-1/0, GCE500-250, GCC6X6500-1/0, GCC6X6500-250             | 1              |

## CD-940 Crimping Dies

- Color-coded for easy matching to color-coding marked on connectors
- Embosses die index number on connector barrels for post crimp inspection
- Part number permanently marked on crimping die for easy identification
- Provides circumferential crimp results in terminations with premium electrical and mechanical performance

| Part Number  | Used to Install Panduit Compression Lug and Splice Sizes |                            |   |   |  |                                |                              | Std. Pkg. Qty. |
|--------------|--|----------------------------|---|---|--|--------------------------------|------------------------------|----------------|
|              | Copper Die Color and Die No.                             | Copper Code Conductor Size | Copper Code and Flex Conductor Size for LCAX, LCBX LCDX, LCCX | Copper Flex Conductor Size for LCAF, LCCF, SCSF | Copper Metric Class 2R Conductor Size    | Aluminum Die Color and Die No. | Aluminum Code Conductor Size |                |
| CD-940-750   | Black P106   | 750 kcmil                  | —   | 646 kcmil                                       | 400mm <sup>2</sup>                       | —                              | —                            | 1              |
| CD-940-800   | Orange P107  | 800 kcmil                  | —   | 777 kcmil                                       | —  | —                              | —                            | 1              |
| CD-940-1000  | White P125   | 1000 kcmil                 | —   | —   | 500mm <sup>2</sup><br>630mm <sup>2</sup> | —                              | —                            | 1              |
| CD-940-750X  | Yellow P115  | —                          | 777.7 kcmil flex  | —   | —  | —                              | —                            | 1              |
| CD-940-750A  | —  | —                          | —   | —   | —  | Red P125                       | 750 kcmil                    | 1              |
| CD-940-800A  | —  | —                          | —   | —   | —  | Gray P140                      | 800 kcmil                    | 1              |
| CD-940-1000A | —  | —                          | —   | —   | —  | Brown P161                     | 1000 kcmil                   | 1              |



CD-940



CD-940-DA

| Part Number | Part Description  | Std. Pkg. Qty. |
|-------------|---|----------------|
| CD-940-DA   | Die adapter for use with Panduit CT-940CH and CT-2940 crimping tools required for installation of Panduit CD-920, CDM-920, and CD-930 crimping dies in these tools. | 1              |

A.  
System  
Overview

B1.  
Cable Ties

B2.  
Cable  
Accessories

B3.  
Stainless  
Steel Ties

C1.  
Wiring  
Duct

C2.  
Surface  
Raceway

C3.  
Abrasion  
Protection

C4.  
Cable  
Management

D1.  
Terminals

D2.  
Power  
Connectors

D3.  
Grounding  
Connectors

E1.  
Labeling  
Systems

E2.  
Labels

E3.  
Pre-Printed  
& Write-On  
Markers

E4.  
Permanent  
Identification

E5.  
Lockout/  
Tagout  
& Safety  
Solutions

F.  
Index

A.  
System  
Overview

## Uni-Die™ Dieless, Manual Hydraulic, 6.2 Ton, Crimping Tool

B1.  
Cable Ties

- Dieless crimping tool design eliminates purchase or lost crimping dies, saves cost

- Provides UL Listed and CSA Certified connections on Panduit® Pan-Lug™ Copper Lugs and Splices

B2.  
Cable  
Accessories

- Develops 6.2 tons of crimping force with four point indenter system, crimps copper compression lugs and splices up to 750 kcmil

- Provides UL Listed and CSA Certified wire range-taking capability on Panduit® Pan-Lug™ Copper Lugs and Splices, minimizes connector inventory and saves cost

B3.  
Stainless  
Steel Ties

- Two-stage rapid advance hydraulic system minimizes number of pumps required to complete a crimp

- Flip-top crimp head design allows easy loading of connectors, saves time

- High quality, durable tool construction provides long-term dependability

- Audible “pop-off” valve indicates crimp completion

- Cushioned grips prevent hands from slipping on tool, reduces fatigue

- Crimp head rotates 360 degrees, provides versatility for use in restricted spaces

C1.  
Wiring  
Duct

- Incorporates aluminum crimp head and fiberglass handles, results in lightweight tool and ease of operation

C2.  
Surface  
Raceway



C3.  
Abrasion  
Protection

C4.  
Cable  
Management

D1.  
Terminals

D2.  
Power  
Connectors

D3.  
Grounding  
Connectors

E1.  
Labeling  
Systems

E2.  
Labels

E3.  
Pre-Printed  
& Write-On  
Markers

E4.  
Permanent  
Identification

E5.  
Lockout/  
Tagout  
& Safety  
Solutions

F.  
Index

| Part Number | Part Description  | Std. Pkg. Qty. |
|-------------|---|----------------|
| CT-980      | <p>Manual hydraulic Uni-Die™ Dieless Crimping Tool provides UL Listed or Recognized and CSA Certified terminations of Panduit® Pan-Lug™ Copper Compression Lugs and Splices for #4 AWG – 750 kcmil copper code conductor.</p> <p>Specifications:<br/>                     Output: 6.2 tons<br/>                     Jaw opening: 1.46"<br/>                     Weight: 10.5 lbs.<br/>                     Length: 13"<br/>                     Height: 12"<br/>                     Width: 3"<br/>                     Handle span: 15" (open), 5.75" (closed)<br/>                     Warranty: 5 years</p> <p>CT-980 includes:<br/>                     • Tool<br/>                     • Plastic tool case</p> | 1              |

CG-980 pressure gauge for measuring tool output force available, sold separately, see page D3.55.





## Uni-Die™ Dieless, Lithium-Ion Powered Hydraulic, 6.2 Ton, Crimping Tool

- Lithium-Ion battery powered, provides fingertip operation and up to 135% more crimps per battery charge than tools powered with NiCd or NiMH batteries
- Dieless crimping tool design eliminates the cost of crimping dies
- Provides wire range-taking capability with Panduit copper compression connectors, allows use of a minimum of lug sizes to crimp a wide range of wire sizes
- Aluminum alloy flip-top crimp head allows easy loading of connectors and rotates 360°
- Ergonomically balanced and lightweight for easy operation without fatigue, weighs 11.75 lbs. with battery
- Self-contained unit, completely portable
- Develops 6.2 tons of crimping force, crimps copper compression lugs and splices up to 750 kcmil, up to 183 crimps per battery charge when crimping Panduit 500 kcmil copper lugs

- Provides UL Listed and CSA Certified connections on Panduit copper lugs and splices
- Audible “pop-off” valve indicates crimp completion
- Tool provided with two, Milwaukee® M18™ XC high capacity lithium-ion 18VDC rechargeable batteries, battery charger, shoulder strap, and tool bag
- Batteries incorporate LED fuel gage so battery charge level can be checked to allow for continuous operation
- Approximately 3.5 second crimp cycle time provides quick terminations, 25% faster than tools using NiCd or NiMH batteries
- Battery charger charges expended batteries completely in 30-60 minutes



CT-2980/L and CT-2980/LE



FREE! Heavy-Duty Soft Sided Tool Bag Included



| Part Number | Charger Voltage | Part Description   | Std. Pkg. Qty. |
|-------------|-----------------|--|----------------|
| CT-2980/L   | 120 VAC         | Terminates Panduit Compression Connectors:<br>• Copper compression lugs and splices for #4 AWG – 750 kcmil code conductor<br><br>Specifications:<br>Output: 6.2 tons (56 Kn)<br>Jaw opening: 1.50" (38.1mm)<br>Weight: 11.75 lbs. (8.3 kg) with battery<br>Length: 14.75" (374.7mm), Height: 15" (381mm), Width: 3" (76.2mm)<br>Warranty: 5 years on tool, batteries and charger<br><br>Tool includes:<br>• Two Milwaukee® M18™ XC high capacity lithium-ion 18VDC rechargeable batteries<br>• One Milwaukee battery charger<br>• One shoulder strap<br>• Heavy-duty bag with storage for tool, batteries, and charger; includes 58 pockets and a shoulder strap for added convenience; 18"L x 7"W x 14"H* | 1              |
| CT-2980/LE  | 230 VAC         |  | 1              |

\*Tool bag also sold separately, see part number PTB-GP on page D3.55.

A. System Overview

B1. Cable Ties

B2. Cable Accessories

B3. Stainless Steel Ties

C1. Wiring Duct

C2. Surface Raceway

C3. Abrasion Protection

C4. Cable Management

D1. Terminals

D2. Power Connectors

D3. Grounding Connectors

E1. Labeling Systems

E2. Labels

E3. Pre-Printed & Write-On Markers

E4. Permanent Identification

E5. Lockout/Tagout & Safety Solutions

F. Index

A. System Overview

## Uni-Die™ Dieless, Remote Hydraulic, 6.2 Ton, Crimp Head

B1. Cable Ties

• Dieless crimping tool design eliminates purchase or lost crimping dies, saves cost

• Provides UL Listed and CSA Certified connections on Panduit® Pan-Lug™ Copper Lugs and Splices

B2. Cable Accessories

• Develops 6.2 tons of crimping force when used with 10,000 psi hydraulic pump and hose, crimps copper compression lugs and splices up to 750 kcmil

• Provides UL Listed and CSA Certified wire range-taking capability on Panduit® Pan-Lug™ Copper Lugs and Splices, minimizes connector inventory and saves cost

B3. Stainless Steel Ties

• Incorporates Parker type quick-connect fittings to ease installation and save time

• Flip-top crimp head design allows easy loading of splices, saves time

C1. Wiring Duct



C2. Surface Raceway

C3. Abrasion Protection

C4. Cable Management

| Part Number     | Part Description  | Std. Pkg. Qty. |
|-----------------|---|----------------|
| <b>CT-980CH</b> | Remote hydraulic Uni-Die™ dieless crimp head provides UL Listed or Recognized and CSA Certified terminations of Panduit® Pan-Lug™ Copper Compression Lugs and Splices for #4 AWG – 750 kcmil copper code conductor.<br><br>Use with Panduit CT-901HP hydraulic pump and CT-900HPH 10' hydraulic hose.*<br><br>Specifications:<br>Output: 6.2 tons<br>Jaw opening: 1.46"<br>Weight: 6.5 lbs.<br>Length: 10.5"<br>Height: 5.3"<br>Width: 2.5"<br>Warranty: 5 years<br><br>CT-980CH includes:<br>• Tool<br>• Steel tool case<br>• Supplied with female Parker type quick-connect fitting assembled to tool | 1              |

\*CT-901RCH remote control handle available, offering one hand operation of crimp head with Panduit CT-901HP hydraulic pump and CT-900HPH hose, sold separately, see page D3.47. CG-980 crimp force measurement gauge available, sold separately, see page D3.55.

D1. Terminals

## Uni-Die™ Dieless, Remote Hydraulic, 4.7 Ton, Crimp Head

D2. Power Connectors

• Low pressure system extends life of crimp head for high volume crimping application

• Incorporates Parker type quick-connect fittings to ease installation and save time

D3. Grounding Connectors

• Dieless crimping tool design eliminates purchase or lost crimping dies, saves cost

• Provides UL Listed and CSA Certified connections on Panduit® Pan-Lug™ Copper Lugs and Splices

• Develops 4.7 tons of crimping force when used with 7,500 psi hydraulic pump and hose, crimps copper compression lugs and splices up to 250 kcmil

• Flip-top crimp head design allows easy loading of splices, saves time

E1. Labeling Systems



E2. Labels

E3. Pre-Printed & Write-On Markers

E4. Permanent Identification

E5. Lockout/Tagout & Safety Solutions

| Part Number       | Part Description  | Std. Pkg. Qty. |
|-------------------|---|----------------|
| <b>CT-980LPCH</b> | Remote hydraulic crimp head provides UL Listed or Recognized and CSA Certified terminations of Panduit® Pan-Lug™ Copper Compression Lugs and Splices for #4 AWG – 250 kcmil code conductor.<br><br>Use with Panduit CT-8250HP hydraulic pump and CT-900LPHPH 10' hydraulic hose.*<br><br>Specifications:<br>Output: 4.7 tons<br>Weight: 6.5 lbs.<br>Length: 10.5" with coupler<br>Height: 5.3"<br>Width: 2.5"<br>Warranty: 5 years<br><br>CT-980LPCH includes:<br>• Tool<br>• Steel tool case<br>• Supplied with male Parker type quick-connect fitting assembled to tool | 1              |

PG-1SC in-line pressure gauge provides visual measurement of hydraulic output pressure, sold separately, see page D3.55.

\*For information on hydraulic pump and hose, see page D3.49.

## Pressure Gauges

- Provide easy visual reading of output force for hydraulic crimping tools
- Factory calibrated to provide accuracy and quality assurance control of crimping tools in the field

- Easy-to-read crimp force tolerance zone for applicable tools marked on gauge
- Blank dies for fixture supplied with test gauge for easy mounting and operation of gauge with crimping tool



CG-920



CG-940



CG-980



PG-1

| Part Number | Part Description  | Std. Pkg. Qty. |
|-------------|---|----------------|
| CG-920      | Compression gauge – used to measure crimping force generated by Panduit crimping tools: CT-930, CT-930CH, CT-930LPCH, and CT-2930/L.<br><br>CG-920 includes:<br>• Pressure gauge<br>• Blank die set<br>• Steel storage case<br>• Warranty: 90 days                            | 1              |
| CG-940      | Compression gauge – used to measure output force generated by Panduit crimping tools: CT-940CH and CT-2940/L.<br><br>CG-940 includes:<br>• Pressure gauge<br>• Blank die set<br>• Steel storage case<br>• Warranty: 90 days   | 1              |
| CG-980      | Compression gauge – used to insure proper compression force for Uni-Die™ Dieless Crimping Tools: CT-980, CT-980CH, and CT-2980/L.<br><br>CG-980 includes:<br>• Pressure gauge<br>• Fixture for mounting gauge in crimping tool<br>• Steel storage case<br>• Warranty: 90 days | 1              |
| PG-1        | In-line pressure gauge provides visual identification of hydraulic output pressure when used with Panduit CT-930CH, CT-940CH, and CT-980CH crimp heads, CT-901HP pump and CT-900HPH hose. Includes steel storage case. Warranty: 90 days                                      | 1              |
| PG-1SC      | In-line pressure gauge provides visual identification of hydraulic output pressure when used with Panduit CT-930LPCH and CT-980LPCH crimp heads, CT-8250HP pump and CT-900LPHPH hose. Includes steel storage case. Warranty: 90 days  | 1              |

## Accessories for Battery-Powered Hydraulic Crimping Tools



PTB-GP



CT-LIBCKIT



CT-LIBA



| Part Number  | Part Description   | Std. Pkg. Qty. |
|--------------|--|----------------|
| PTB-GP       | Heavy-duty bag for crimping tools and accessories. Includes 58 pockets and a shoulder strap for added convenience. 18"L x 7"W x 14"H.  | 1              |
| CT-LIBCKIT   | Kit to convert Panduit CT-2001, CT-2002, CT-2930, CT-2940 and CT-2980 NiCd battery powered crimping tools to lithium-ion powered. Kit includes one Panduit CT-LIBA battery adapter, two Milwaukee® M18™ XC high capacity lithium-ion 18VDC rechargeable batteries, and one 120 VAC Milwaukee® battery charger. | 1              |
| CT-LIBCKIT/E | Kit to convert Panduit CT-2001, CT-2002, CT-2930, CT-2940 and CT-2980 NiCd battery powered crimping tools to lithium-ion powered. Kit includes one Panduit CT-LIBA battery adapter, two Milwaukee® M18™ XC high capacity lithium-ion 18VDC rechargeable batteries, and one 230 VAC Milwaukee® battery charger. | 1              |
| CT-LIBA      | Lithium-ion battery adapter to convert Panduit CT-2001, CT-2002, CT-2930, CT-2940 and CT-2980 NiCd tools to Milwaukee® M18™ XC high capacity lithium-ion batteries (48-11-1828).   | 1              |

A. System Overview

B1. Cable Ties

B2. Cable Accessories

B3. Stainless Steel Ties

C1. Wiring Duct

C2. Surface Raceway

C3. Abrasion Protection

C4. Cable Management

D1. Terminals

D2. Power Connectors

D3. Grounding Connectors

E1. Labeling Systems

E2. Labels

E3. Pre-Printed & Write-On Markers

E4. Permanent Identification

E5. Lockout/Tagout & Safety Solutions

F. Index

A. System Overview  
 B1. Cable Ties  
 B2. Cable Accessories  
 B3. Stainless Steel Ties  
 C1. Wiring Duct  
 C2. Surface Raceway  
 C3. Abrasion Protection  
 C4. Cable Management  
 D1. Terminals  
 D2. Power Connectors  
 D3. Grounding Connectors  
 E1. Labeling Systems  
 E2. Labels  
 E3. Pre-Printed & Write-On Markers  
 E4. Permanent Identification  
 E5. Lockout/Tagout & Safety Solutions  
 F. Index

**For use with Copper Conductors**

## Installation Tooling and Die Selections for: Types LCAS and SCSS

### How to read this chart

For LCA6 lug and CT-2001 crimping tool:

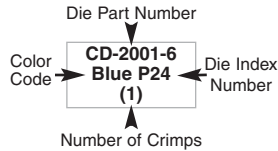

### Panduit (See Compression Connector Tools Selection Guide, Pages D3.34 – D3.36)

### Thomas & Betts

| Panduit Part Number | Std. Wire Size | Wire Strip Length (In.) | Panduit (See Compression Connector Tools Selection Guide, Pages D3.34 – D3.36) |                         |   |  |   | Thomas & Betts |               |                          |  |
|---------------------|----------------|-------------------------|--|-------------------------|---|--|---|----------------|---------------|--------------------------|--|
|                     |                |                         | CT-1700 <sup>①</sup>   | CT-720                  | CT-920, CT-920CH, CT-930, CT-930CH, CT-2930, CT-2930/L, CT-2930/LE, CT-930LPCH, CT-2931, CT-2940 <sup>③</sup> , CT-2940/L <sup>③</sup> , CT-2940/LE <sup>③</sup> , CT-2920, CT-940CH <sup>③</sup> | Uni-Die™<br>CT-980, CT-2980, CT-2980/L, CT-2980/LE, CT-980CH, CT-2981, CT-980LPCH, CT-2950 | CT-2001, CT-2001/L, CT-2001/LE, CT-2002, CT-2002/L, CT-3001, CT-3001/E, | TBM20S, TBM25S | TBM5          | TBM6, TBM6S, TBM8, 25000 |  |
| L=Lug<br>S=Splice   |                |                         | Die Part Number/Color Code and Die Index Number/(Number Of Crimps)             |                         |   |  |   |                |               |                          |  |
| <b>LCAS8</b>        | #8 AWG         | 1/2                     | Red P21 (2)  | CD-720-1 Red P21 (1)    | CD-920-8 Red P21 (1)  | —  | CD-2001-8 Red P21 (1)   | Red 21 (2)     | Red 21 (1)    | Red 21 (1)               |  |
| <b>SCSS8</b>        |                | 7/16                    | Blue P24 (2)   | CD-720-1 Blue P24 (1)   | CD-920-6 Blue P24 (1)   | —  | CD-2001-6 Blue P24 (1)  | Blue 24 (2)    | Blue 24 (1)   | Blue 24 (1)              |  |
| <b>LCAS6</b>        | #6 AWG         | 9/16                    | Gray P29 (2)   | CD-720-1 Gray P29 (1)   | CD-920-4 Gray P29 (1)   | (1)  | CD-2001-4 Gray P29 (1)  | Gray 29 (2)    | Gray 29 (2)   | Gray 29 (2)              |  |
| <b>SCSS6</b>        |                | 7/16                    | Brown P33 (2)  | CD-720-1 Brown P33 (1)  | CD-920-2 Brown P33 (1)  | (1)  | CD-2001-2 Brown P33 (1)   | Brown 33 (2)   | Brown 33 (2)  | Brown 33 (2)             |  |
| <b>LCAS4</b>        | #4 AWG         | 5/8                     | Green P37 (3)  | CD-720-2 Green P37 (1)  | CD-920-1 Green P37 (1)  | (1)  | CD-2001-1 Green P37 (1)   | —              | Green 37 (1)  | Green 37 (1)             |  |
| <b>SCSS4</b>        |                | 7/16                    | —  | CD-720-2 Pink P42 (1)   | CD-920-1/0 Pink P42 (1)   | (1)  | CD-2001-1/0 Pink P42 (1)  | —              | Pink 42 (1)   | Pink 42 (1)              |  |
| <b>LCAS2</b>        | #2 AWG         | 5/8                     | —  | CD-720-2 Black P45 (2)  | CD-920-2/0 Black P45 (1)  | (1)  | CD-2001-2/0 Black P45 (2)   | —              | Black 45 (2)  | Black 45 (2)             |  |
| <b>SCSS2</b>        |                | 9/16                    | —  | CD-720-2 Orange P50 (2) | CD-920-3/0 Orange P50 (1)   | (1)  | CD-2001-3/0 Orange P50 (2)  | —              | Orange 50 (2) | Orange 50 (2)            |  |
| <b>LCAS1</b>        | #1 AWG         | 11/16                   | —  | CD-720-3 Purple P54 (2) | CD-920-4/0 Purple P54 (1)   | (1)  | CD-2001-4/0 Purple P54 (2)  | —              | Purple 54 (2) | Purple 54 (2)            |  |
| <b>SCSS1</b>        |                | —                       | —  | CD-720-3 Yellow P62 (2) | CD-920-250 Yellow P62 (1)   | (1)  | CD-2001-250 Yellow P62 (2)  | —              | Yellow 62 (2) | Yellow 62 (2)            |  |
| <b>LCAS1/0</b>      | 1/0 AWG        | 3/4                     | —  | —                       | —   | —  | —   | —              | —             | —                        |  |
| <b>SCSS1/0</b>      |                | 11/16                   | —  | —                       | —   | —  | —   | —              | —             | —                        |  |
| <b>LCAS2/0</b>      | 2/0 AWG        | 3/4                     | —  | —                       | —   | —  | —   | —              | —             | —                        |  |
| <b>SCSS2/0</b>      |                | —                       | —  | —                       | —   | —  | —   | —              | —             | —                        |  |
| <b>LCAS3/0</b>      | 3/0 AWG        | 7/8                     | —  | —                       | —   | —  | —   | —              | —             | —                        |  |
| <b>SCSS3/0</b>      |                | 3/4                     | —  | —                       | —   | —  | —   | —              | —             | —                        |  |
| <b>LCAS4/0</b>      | 4/0 AWG        | 1                       | —  | —                       | —   | —  | —   | —              | —             | —                        |  |
| <b>SCSS4/0</b>      |                | 13/16                   | —  | —                       | —   | —  | —   | —              | —             | —                        |  |
| <b>LCAS250</b>      | 250 kcmil      | 1-1/8                   | —  | —                       | —   | —  | —   | —              | —             | —                        |  |
| <b>SCSS250</b>      |                | 1-1/16                  | —  | —                       | —   | —  | —   | —              | —             | —                        |  |

①The CT-1700 crimp die pockets are integrated into the tool frame.  
 ③CD-920 dies can be used with CT-940CH and CT-2940 tools with the CD-940-DA adapter.

For use with  
Copper  
Conductors

## Installation Tooling and Die Selections for: Types LCAS and SCSS (continued)

| Thomas & Betts   |                                |   |  | Burndy                   |            |   |  | Anderson   | Penn-Union | Greenlee      |
|--|--------------------------------|---|--|--------------------------|------------|---|--|------------|------------|---------------|
| TBM12,<br>13642M   | TBM15,<br>TBM15I,<br>TBM15BSCR | TBM8-750M-I,<br>TBM8-750,<br>TBM8-750BSCR,<br>TBM750BSCR <sup>④</sup> | TBM14M,<br>TBM14BSCR,<br>BPLT14BSCR,<br>13100A | Y2MR,<br>Y1MRTC,<br>Y1MR | MY29       | Y35, Y35BH, Y39,<br>Y39BH,<br>Y45, Y46, Y750,<br>Y750-2, Y750BH,<br>Y750BH-2,<br>Y750HS, PAT750,<br>BAT750, BAT35 | Y644M,<br>Y644HS,<br>Y644MBH,<br>PAT644,<br>BAT644 | VC6        | TDY-1      | 1989          |
| Die Part Number/Color Code and Die Index Number/(Number of Crimps) |                                |   |  |                          |            |   |  |            |            |               |
| Red 21<br>(1)  | Red 21<br>(1)                  | STD<br>(1)  | Red 21<br>(1)                                  | Red<br>(2)               | #8<br>(1)  | U8CRT<br>Red 49<br>(1)  | —  | —          | —          | —             |
| Blue 24<br>(1)   | Blue 24<br>(1)                 | STD<br>(1)  | Blue 24<br>(1)                                 | Blue<br>(2)              | #6<br>(1)  | U5CRT<br>Blue 7<br>(1)  | STD<br>(1)   | STD<br>(1) | —          | —             |
| Gray 29<br>(1)   | Gray 29<br>(1)                 | STD<br>(1)  | Gray 29<br>(1)                                 | Gray<br>(2)              | #4<br>(1)  | U4CRT<br>Gray 8<br>(1)  | STD<br>(1)   | STD<br>(1) | STD<br>(1) | STD<br>(1)    |
| Brown 33<br>(1)  | Brown 33<br>(1)                | STD<br>(1)  | Brown 33<br>(1)                                | Brown<br>(2)             | #2<br>(1)  | U2CRT<br>Brown 10<br>(1)  | STD<br>(1)   | STD<br>(1) | STD<br>(1) | STD<br>(1)    |
| Green 37<br>(1)  | Green 37<br>(1)                | STD<br>(1)  | Green 37<br>(1)                                | —                        | #1<br>(1)  | U1CRT<br>Green 11<br>(1)  | STD<br>(1)   | STD<br>(1) | STD<br>(1) | STD<br>(1)    |
| Pink 42<br>(1)   | Pink 42H <sup>②</sup><br>(2)   | STD<br>(1)  | Pink 42H <sup>②</sup><br>(2)                   | —                        | 1/0<br>(1) | U25RT<br>Pink 12<br>(1)   | STD<br>(1)   | STD<br>(1) | STD<br>(1) | STD<br>(1)    |
| Black 45<br>(1)  | Black 45<br>(1)                | STD<br>(1)  | Black 45<br>(1)                                | —                        | 2/0<br>(1) | U26RT<br>Black 13<br>(1)  | STD<br>(1)   | STD<br>(1) | STD<br>(1) | STD<br>(1)    |
| Orange 50<br>(1)   | Orange 50<br>(1)               | STD<br>(1)  | Orange 50<br>(1)                               | —                        | 3/0<br>(1) | U27RT<br>Orange 14<br>(1)   | STD<br>(1)   | STD<br>(1) | STD<br>(1) | STD<br>(1)    |
| Purple 54<br>(1)   | Purple 54H <sup>②</sup><br>(2) | STD<br>(1)  | Purple 54H <sup>②</sup><br>(2)                 | —                        | 4/0<br>(1) | U28RT<br>Purple 15<br>(1)   | STD<br>(1)   | STD<br>(1) | STD<br>(1) | STD<br>(1)    |
| Yellow 62<br>(1)   | Yellow 62<br>(1)               | STD<br>(1)  | Yellow 62<br>(1)                               | —                        | 250<br>(1) | U29RT<br>Yellow 16<br>(1)   | STD<br>(1)   | STD<br>(2) | —          | Yellow<br>(2) |

②Half width dies.

④Minimum size: #4 AWG lugs and splices.

A.  
System  
Overview

B1.  
Cable Ties

B2.  
Cable  
Accessories

B3.  
Stainless  
Steel Ties

C1.  
Wiring  
Duct

C2.  
Surface  
Raceway

C3.  
Abrasion  
Protection

C4.  
Cable  
Management

D1.  
Terminals

D2.  
Power  
Connectors

D3.  
Grounding  
Connectors

E1.  
Labeling  
Systems

E2.  
Labels

E3.  
Pre-Printed  
& Write-On  
Markers

E4.  
Permanent  
Identification

E5.  
Lockout/  
Tagout  
& Safety  
Solutions

F.  
Index

A. System Overview

B1. Cable Ties

B2. Cable Accessories

B3. Stainless Steel Ties

C1. Wiring Duct

C2. Surface Raceway

C3. Abrasion Protection

C4. Cable Management

D1. Terminals

D2. Power Connectors

D3. Grounding Connectors

E1. Labeling Systems

E2. Labels

E3. Pre-Printed & Write-On Markers

E4. Permanent Identification

E5. Lockout/Tagout & Safety Solutions

F. Index

**For use with Copper Conductors**

## Installation Tooling and Die Selections for: Types LCA, LCA<sup>N</sup>, LCD, LCD<sup>N</sup> and SCS

**How to read this chart**

For LCA6 lug and CT-2001 crimping tool:

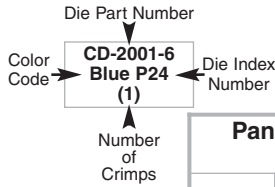

| Panduit (See Compression Connector Tools Selection Guide, Pages D3.34 – D3.36) |                                      |                         |  |                      |                      |                         |  | Thomas & Betts  |  |                |                                |               |
|--|--------------------------------------|-------------------------|--|----------------------|----------------------|-------------------------|--|---|--|----------------|--------------------------------|---------------|
| Panduit Part Number  | Std. Wire Size                       | Wire Strip Length (In.) | CT-1570  | CT-1701 <sup>①</sup> | CT-1700 <sup>①</sup> | CT-720                  | CT-920, CT-920CH, CT-930, CT-930CH, CT-930LPCH <sup>®</sup> , CT-2920, CT-2930, CT-2930/L, CT-2930/LE, CT-2931, CT-940CH <sup>®</sup> , CT-2940 <sup>®</sup> , CT-2940/LE <sup>®</sup> | Uni-Die™ Dieless CT-980, CT-2980, CT-2980/L, CT-2980/LE, CT-980LPCH <sup>®</sup> , CT-980CH, CT-2950 <sup>®</sup> , CT-2981 Extended Wire Range | CT-2001, CT-2001/L, CT-2001/LE, CT-2002, CT-2002/L, CT-3001, CT-3001/E | TBM20S, TBM25S | TBM6, TBM6S, 25000, TBM5, TBM8 | TBM12, 13642M |
| L = Lug<br>S = Splice  |                                      |                         | Die Part Number/Color Code and Die Index Number/(Number of Crimps) |                      |                      |                         |  |   |  |                |                                |               |
| LCA10<br>LCD10   | #14 – #10 AWG STR, #12 – #10 AWG SOL | 7/16                    | 12-10 (1)  | P10 (1)              | —                    | —                       | —  | —   | —  | —              | —                              | —             |
| LCA8<br>LCA <sup>N</sup> 8<br>LCD8<br>LCD <sup>N</sup> 8                       | #8 AWG                               | 5/8                     | —  | —                    | Red P21 (2)          | CD-720-1 Red P21 (1)    | CD-920-8 Red P21 (1)   | —   | CD-2001-8 Red P21 (1)  | Red 21 (2)     | Red 21 (1)                     | Red 21 (1)    |
| SCS8   |                                      | 11/16                   |  |                      |                      |                         |  |   |  |                |                                |               |
| LCA6<br>LCA <sup>N</sup> 6<br>LCD6<br>LCD <sup>N</sup> 6                       | #6 AWG                               | 7/8                     | —  | —                    | Blue P24 (2)         | CD-720-1 Blue P24 (1)   | CD-920-6 Blue P24 (1)  | —   | CD-2001-6 Blue P24 (1)   | Blue 24 (2)    | Blue 24 (1)                    | Blue 24 (1)   |
| SCS6   |                                      | 13/16                   |  |                      |                      |                         |  |   |  |                |                                |               |
| LCA4<br>LCA <sup>N</sup> 4<br>LCD4<br>LCD <sup>N</sup> 4                       | #4 – #3 AWG STR, #2 AWG SOL          | 7/8                     | —  | —                    | Gray P29 (2)         | CD-720-1 Gray P29 (1)   | CD-920-4 Gray P29 (1)  | #4 – #2 AWG #2 AWG SOL Only (1)   | CD-2001-4 Gray P29 (1)   | Gray 29 (2)    | Gray 29 (1)                    | Gray 29 (1)   |
| SCS4   |                                      | 13/16                   |  |                      |                      |                         |  |   |  |                |                                |               |
| LCA2<br>LCA <sup>N</sup> 2<br>LCD2<br>LCD <sup>N</sup> 2                       | #2 AWG                               | 15/16                   | —  | —                    | Brown P33 (2)        | CD-720-1 Brown P33 (1)  | CD-920-2 Brown P33 (1)   | #6 – #2 AWG (1)   | CD-2001-2 Brown P33 (1)  | Brown 33 (2)   | Brown 33 (1)                   | Brown 33 (1)  |
| SCS2   |                                      | 7/8                     |  |                      |                      |                         |  |   |  |                |                                |               |
| LCA1<br>LCA <sup>N</sup> 1<br>LCD1<br>LCD <sup>N</sup> 1                       | #1 AWG                               | 15/16                   | —  | —                    | Green P37 (3)        | CD-720-2 Green P37 (1)  | CD-920-1 Green P37 (1)   | #6 – #1 AWG (1)   | CD-2001-1 Green P37 (1)  | —              | Green 37 (1)                   | Green 37 (1)  |
| SCS1   |                                      | 7/8                     |  |                      |                      |                         |  |   |  |                |                                |               |
| LCA1/0<br>LCA <sup>N</sup> 1/0<br>LCD1/0<br>LCD <sup>N</sup> 1/0               | 1/0 AWG                              | 1                       | —  | —                    | —                    | CD-720-2 Pink P42 (1)   | CD-920-1/0 Pink P42 (1)  | #6 – 1/0 AWG (1)  | CD-2001-1/0 Pink P42 (1)   | —              | Pink 42 (1)                    | Pink 42 (1)   |
| SCS1/0   |                                      | 7/8                     |  |                      |                      |                         |  |   |  |                |                                |               |
| LCA2/0<br>LCA <sup>N</sup> 2/0<br>LCD2/0<br>LCD <sup>N</sup> 2/0               | 2/0 AWG                              | 1-1/16                  | —  | —                    | —                    | CD-720-2 Black P45 (2)  | CD-920-2/0 Black P45 (2)   | #4 – 2/0 AWG (1)  | CD-2001-2/0 Black P45 (2)  | —              | Black 45 (2)                   | Black 45 (1)  |
| SCS2/0   |                                      | 15/16                   |  |                      |                      |                         |  |   |  |                |                                |               |
| LCA3/0<br>LCA <sup>N</sup> 3/0<br>LCD3/0<br>LCD <sup>N</sup> 3/0               | 3/0 AWG                              | 1-3/16                  | —  | —                    | —                    | CD-720-2 Orange P50 (2) | CD-920-3/0 Orange P50 (2)  | #2 – 3/0 AWG (1)  | CD-2001-3/0 Orange P50 (2)   | —              | Orange 50 (2)                  | Orange 50 (1) |
| SCS3/0   |                                      | 1                       |  |                      |                      |                         |  |   |  |                |                                |               |

①The CT-1700 and CT-1701 crimp die pockets are integrated into the tool frame.  
 ②CD-920 dies can be used with CT-940CH and CT-2940 tools with CD-940-DA adapter.

③Maximum size: 500 kcmil lugs and 250 kcmil splices.  
 ④Maximum size: 250 kcmil lugs and splices. No extended wire range.



For use with  
Copper  
Conductors

## Installation Tooling and Die Selections for: Types LCA, LCA<sub>N</sub>, LCD, LCD<sub>N</sub> and SCS (continued)

| Thomas & Betts   |   |  | Burndy                   |            |   |   |  | Anderson   | Penn-Union | Greenlee   |
|--|---|--|--------------------------|------------|---|---|--|------------|------------|------------|
| TBM15,<br>TBM15I,<br>TBM15BSCR                                     | TBM8-750M-1,<br>TBM8-750,<br>TBM8-750BSCR,<br>TBM750BSCR® | TBM14M,<br>TBM14BSCR,<br>BPLT14BSCR,<br>13100A | Y2MR,<br>Y1MR,<br>Y1MRTC | MY29       | BAT35, Y39BH,<br>Y35BH, Y750,<br>Y750BH,<br>Y750-2, Y750HS,<br>Y750BH-2, Y39,<br>PAT750,<br>Y35, BAT750 | Y45Ⓣ,<br>Y46Ⓣ   | Y644M,<br>Y644HS,<br>PAT644,<br>BAT644,<br>Y644MBH | VC6        | TDY-1      | 1989       |
| Die Part Number/Color Code and Die Index Number/(Number of Crimps) |   |  |                          |            |   |   |  |            |            |            |
| —  | —   | —  | —                        | —          | —   | —   | —  | —          | —          | —          |
| Red 21<br>(1)  | STD<br>(1)  | Red 21<br>(1)                                  | Red 49<br>(1)            | #8<br>(1)  | U8CRT<br>Red 49<br>(1)  | U8CRT<br>Red 49<br>(1)  | —  | —          | —          | —          |
| Blue 24<br>(1)   | STD<br>(1)  | Blue 24<br>(1)                                 | Blue 7<br>(2)            | #6<br>(1)  | U5CRT<br>Blue 7<br>(1)  | U5CRT<br>Blue 7<br>(1)  | STD<br>(1)   | STD<br>(1) | —          | —          |
| Gray 29<br>(1)   | STD<br>(1)  | Gray 29<br>(1)                                 | Gray 8<br>(2)            | #4<br>(1)  | U4CRT<br>Gray 8<br>(1)  | U4CRT<br>Gray 8<br>(1)  | STD<br>(1)   | STD<br>(1) | —          | STD<br>(1) |
| Brown 33<br>(1)  | STD<br>(1)  | Brown 33<br>(1)                                | Brown 10<br>(2)          | #2<br>(1)  | U2CRT<br>Brown 9<br>[solid]/<br>Brown 10<br>[stranded]<br>(1)   | U2CRT<br>Brown 9<br>[solid]/<br>Brown 10<br>[stranded]<br>(1) | STD<br>(1)   | STD<br>(1) | STD<br>(1) | STD<br>(1) |
| Green<br>37<br>(1)   | STD<br>(1)  | Green 37<br>(1)                                | —                        | #1<br>(1)  | U1CRT<br>Green 11<br>(1)  | U1CRT<br>Green 11<br>(1)                                      | STD<br>(1)   | STD<br>(1) | STD<br>(1) | STD<br>(1) |
| Pink 42H <sup>Ⓣ</sup><br>(2)                                       | STD<br>(1)  | Pink 42H <sup>Ⓣ</sup><br>(2)                   | —                        | 1/0<br>(1) | U25RT<br>Pink 12<br>(1)   | U25RT<br>Pink 12<br>(1)                                       | STD<br>(1)   | STD<br>(1) | STD<br>(1) | STD<br>(1) |
| Black 45<br>(1)  | STD<br>(1)  | Black 45<br>(1)                                | —                        | 2/0<br>(1) | U26RT<br>Black 13<br>(1)  | U26RT<br>Black 13<br>(1)                                      | STD<br>(1)   | STD<br>(1) | STD<br>(1) | STD<br>(1) |
| Orange<br>50<br>(1)  | STD<br>(1)  | Orange 50<br>(1)                               | —                        | 3/0<br>(1) | U27RT<br>Orange 14<br>(1)   | U27RT<br>Orange 14<br>(1)                                     | STD<br>(1)   | STD<br>(1) | STD<br>(1) | STD<br>(1) |

ⓉHalf width dies.

ⓉRequires U die adapter.

ⓉMinimum size: #4 AWG lugs and splices.

Chart continues on pages D3.60 – D3.61

A.  
System  
Overview

B1.  
Cable Ties

B2.  
Cable  
Accessories

B3.  
Stainless  
Steel Ties

C1.  
Wiring  
Duct

C2.  
Surface  
Raceway

C3.  
Abrasion  
Protection

C4.  
Cable  
Management

D1.  
Terminals

D2.  
Power  
Connectors

D3.  
Grounding  
Connectors

E1.  
Labeling  
Systems

E2.  
Labels

E3.  
Pre-Printed  
& Write-On  
Markers

E4.  
Permanent  
Identification

E5.  
Lockout/  
Tagout/  
& Safety  
Solutions

F.  
Index

A. System Overview

B1. Cable Ties

B2. Cable Accessories

B3. Stainless Steel Ties

C1. Wiring Duct

C2. Surface Raceway

C3. Abrasion Protection

C4. Cable Management

D1. Terminals

D2. Power Connectors

D3. Grounding Connectors

E1. Labeling Systems

E2. Labels

E3. Pre-Printed & Write-On Markers

E4. Permanent Identification

E5. Lockout/Tagout & Safety Solutions

F. Index

**For use with Copper Conductors**

## Installation Tooling and Die Selections for: Types LCA, LCA, LCD, LCDN and SCS (continued)

|                     |                |                         | Panduit (See Compression Connector Tools Selection Guide, Pages D3.34 – D3.36) |   |  |  | Thomas & Betts |                          |                             |
|---------------------|----------------|-------------------------|--|---|--|--|----------------|--------------------------|-----------------------------|
| Panduit Part Number | Std. Wire Size | Wire Strip Length (In.) | CT-720   | CT-920, CT-920CH, CT-930, CT-930CH, CT-930LPCH <sup>⑥</sup> , CT-2920, CT-2930, CT-2930/L, CT-2930/LE, CT-2931, CT-940CH <sup>③</sup> , CT-2940 <sup>③</sup> , CT-2940/L <sup>③</sup> , CT-2940/LE <sup>③</sup> | CT-980, CT-2980, CT-2980/L, CT-2980/LE, CT-980LPCH <sup>⑥</sup> , CT-980CH, CT-2950 <sup>⑤</sup> , CT-2981 Extended Wire Range | CT-2001, CT-2001/L, CT-2001/LE, CT-2002, CT-2002/L, CT-3001, CT-3001/E | TBM5           | TBM6, TBM6S, 25000, TBM8 | TBM12, 13642M               |
| L=Lug<br>S=Splice   |                |                         | Die Part Number/Color Code and Die Index Number/(Number of Crimps)             |   |  |  |                |                          |                             |
| LCA4/0              | 4/0 AWG        | 1-1/4                   | CD-720-3 Purple P54 (2)  | CD-920-4/0 Purple P54 (2)   | 1 – 4/0 AWG (1)  | CD-2001-4/0 Purple P54 (2)   | Purple 54 (2)  | Purple 54 (2)            | Purple 54 (1)               |
| LCA4/0              |                |                         |  |   |  |  |                |                          |                             |
| LCD4/0              |                |                         |  |   |  |  |                |                          |                             |
| LCDN4/0             |                |                         |  |   |  |  |                |                          |                             |
| SCS4/0              |                | 1                       |  |   |  |  |                |                          |                             |
| LCA250              | 250 kcmil      | 1-5/16                  | CD-720-3 Yellow P62 (2)  | CD-920-250 Yellow P62 (2)   | 1/0 AWG – 250 kcmil (2)  | CD-2001-250 Yellow P62 (2)   | Yellow 62 (2)  | Yellow 62 (2)            | Yellow 62 (1)               |
| LCA250              |                |                         |  |   |  |  |                |                          |                             |
| LCD250              |                |                         |  |   |  |  |                |                          |                             |
| LCDN250             |                |                         |  |   |  |  |                |                          |                             |
| SCS250              |                | 1-1/16                  |  |   |  |  |                |                          |                             |
| LCA300              | 300 kcmil      | 1-1/2                   | CD-720-4 White P66 (2)   | CD-920-300 White P66 (2)  | 2/0 AWG – 300 kcmil (2)  | CD-2001-300 White P66 (2)  | —              | White 66 (2)             | White 66H <sup>②</sup> (1)  |
| LCA300              |                |                         |  |   |  |  |                |                          |                             |
| LCD300              |                |                         |  |   |  |  |                |                          |                             |
| LCDN300             |                |                         |  |   |  |  |                |                          |                             |
| SCS300              |                | 1-1/16                  |  |   |  |  |                |                          |                             |
| LCA350              | 350 kcmil      | 1-1/2                   | CD-720-5 Red P71 (2)   | CD-920-350 Red P71 (2)  | 3/0 AWG – 350 kcmil (2)  | CD-2001-350 Red P71 (2)  | —              | Red 71 (2)               | Red 71H <sup>②</sup> (2)    |
| LCA350              |                |                         |  |   |  |  |                |                          |                             |
| LCD350              |                |                         |  |   |  |  |                |                          |                             |
| LCDN350             |                |                         |  |   |  |  |                |                          |                             |
| SCS350              |                | 1-1/8                   |  |   |  |  |                |                          |                             |
| LCA400              | 400 kcmil      | 1-9/16                  | CD-720-6 Blue P76 (2)  | CD-920-400 Blue P76 (2)   | 4/0 AWG – 400 kcmil (2)  | CD-2001-400 Blue P76 (3)   | —              | Blue 76 (2)              | Blue 76H <sup>②</sup> (2)   |
| LCA400              |                |                         |  |   |  |  |                |                          |                             |
| LCD400              |                |                         |  |   |  |  |                |                          |                             |
| LCDN400             |                |                         |  |   |  |  |                |                          |                             |
| SCS400              |                | 1-3/16                  |  |   |  |  |                |                          |                             |
| LCA500              | 500 kcmil      | 1-13/16                 | CD-720-7 Brown P87 (2)   | CD-920-500 Brown P87 (2)  | 4/0 AWG – 500 kcmil (2)  | CD-2001-500 Brown P87 (3)  | —              | Brown 87 (2)             | Brown 87H <sup>②</sup> (2)  |
| LCA500              |                |                         |  |   |  |  |                |                          |                             |
| LCD500              |                |                         |  |   |  |  |                |                          |                             |
| LCDN500             |                |                         |  |   |  |  |                |                          |                             |
| SCS500              |                | 1-3/8                   |  |   |  |  |                |                          |                             |
| LCA600              | 600 kcmil      | 1-13/16                 | —  | CD-920-600 Green P94 (2)  | 250 – 600 kcmil (2)  | —  | —              | —                        | Green 94H <sup>②</sup> (2)  |
| LCA600              |                |                         |  |   |  |  |                |                          |                             |
| LCD600              |                |                         |  |   |  |  |                |                          |                             |
| LCDN600             |                |                         |  |   |  |  |                |                          |                             |
| SCS600              |                | 1-3/8                   |  |   |  |  |                |                          |                             |
| LCA750              | 750 kcmil      | 1-15/16                 | —  | CD920-750 CD-940-750 <sup>④</sup> Black P106 (2)  | 500 – 750 kcmil (2)  | —  | —              | —                        | Black 106H <sup>②</sup> (2) |
| LCA750              |                |                         |  |   |  |  |                |                          |                             |
| LCD750              |                |                         |  |   |  |  |                |                          |                             |
| LCDN750             |                |                         |  |   |  |  |                |                          |                             |
| SCS750              |                | 1-5/8                   |  |   |  |  |                |                          |                             |
| LCD1000             | 1000 kcmil     | 1-15/16                 | —  | CD-940-1000 <sup>④</sup> White P125 (4)   | —  | —  | —              | —                        | —                           |
| SCS1000             |                |                         |  |   |  |  |                |                          |                             |

②Half width dies.  
 ③CD-920 dies can be used with CT-940CH and CT-2940 tools with CD-940-DA adapter.  
 ④CD-940 dies to be used exclusively with CT-940CH and CT-2940 tools.  
 ⑤Maximum size: 500 kcmil lugs and 250 kcmil splices.  
 ⑥Maximum size: 250 kcmil lugs and splices. No extended wire range.

For use with  
Copper  
Conductors

## Installation Tooling and Die Selections for: Types LCA, LCA, LCD, LCDN and SCS (continued)

| Thomas & Betts   |   |  | Burndy                   |            |   |  |  | Anderson   | Penn-Union | Greenlee   |
|--|---|--|--------------------------|------------|---|--|--|------------|------------|------------|
| TBM15,<br>TBM15I,<br>TBM15BSCR                                     | TBM8-750M-1,<br>TBM8-750,<br>TBM8-750BSCR,<br>TBM750BSCR® | TBM14M,<br>TBM14BSCR,<br>BPLT14BSCR,<br>13100A | Y2MR,<br>Y1MR,<br>Y1MRTC | MY29       | BAT35, Y35BH,<br>Y750, Y39BH,<br>Y750BH,<br>Y750-2, Y750HS,<br>Y750BH-2,<br>Y39, PAT750,<br>Y35, BAT750 | Y45 <sup>⑦</sup> ,<br>Y46 <sup>⑦</sup> | Y644M,<br>Y644HS,<br>PAT644,<br>BAT644,<br>Y644MBH | VC6        | TDY-1      | 1989       |
| Die Part Number/Color Code and Die Index Number/(Number of Crimps) |   |  |                          |            |   |  |  |            |            |            |
| Purple<br>54H <sup>②</sup><br>(2)                                  | STD<br>(1)  | Purple<br>54H <sup>②</sup><br>(2)              | —                        | 4/0<br>(1) | U28RT<br>Purple 15<br>(1)   | U28RT<br>Purple 15<br>(1)              | STD<br>(1)   | STD<br>(1) | STD<br>(1) | STD<br>(1) |
| Yellow 62<br>(1)   | STD<br>(1)  | Yellow 62<br>(1)                               | —                        | 250<br>(1) | U29RT<br>Yellow 16<br>(1)   | U29RT<br>Yellow 16<br>(1)              | STD<br>(1)   | STD<br>(2) | STD<br>(1) | STD<br>(1) |
| White 66<br>(1)  | STD<br>(1)  | White 66<br>(1)                                | —                        | —          | U30RT<br>White 17<br>(2)  | U30RT<br>White 17<br>(2)               | STD<br>(1)   | STD<br>(2) | STD<br>(1) | STD<br>(1) |
| Red 71H <sup>②</sup><br>(2)  | STD<br>(1)  | Red 71H <sup>②</sup><br>(2)                    | —                        | —          | U31RT<br>Red 18<br>(2)  | U31RT<br>Red 18<br>(2)                 | STD<br>(1)   | STD<br>(2) | STD<br>(1) | STD<br>(1) |
| Blue 76H <sup>②</sup><br>(2)                                       | STD<br>(1)  | Blue 76<br>(1)                                 | —                        | —          | U32RT<br>Blue 19<br>(2)   | U32RT<br>Blue 19<br>(2)                | STD<br>(1)   | STD<br>(2) | STD<br>(1) | STD<br>(1) |
| Brown<br>87H <sup>②</sup><br>(2)                                   | STD<br>(1)  | Brown 87H <sup>②</sup><br>(2)                  | —                        | —          | U34RT<br>Brown 20<br>(2)  | U34RT<br>Brown 20<br>(2)               | STD<br>(1)   | STD<br>(2) | STD<br>(1) | STD<br>(1) |
| Green 94H <sup>②</sup><br>(2)                                      | STD<br>(1)  | Green<br>94H <sup>②</sup><br>(2)               | —                        | —          | U36RT<br>Green 22<br>(2)  | U36RT<br>Green 22<br>(2)               | STD<br>(1)   | —          | STD<br>(1) | —          |
| Black<br>106H <sup>②</sup><br>(2)                                  | STD<br>(1)  | Black 106H <sup>②</sup><br>(2)                 | —                        | —          | U39RT<br>Black 24<br>(3)  | U39RT<br>Black 24<br>(3)               | STD<br>(1)   | —          | STD<br>(1) | —          |
| 125H <sup>②</sup><br>(2)   | —   | 125H <sup>②</sup><br>(2)                       | —                        | —          | —   | S44RT<br>White 27<br>(4)               | —  | —          | —          | —          |

②Half width dies.

⑦Requires U die adapter.

⑧Minimum size: #4 AWG lugs and splices.

A.  
System  
Overview

B1.  
Cable Ties

B2.  
Cable  
Accessories

B3.  
Stainless  
Steel Ties

C1.  
Wiring  
Duct

C2.  
Surface  
Raceway

C3.  
Abrasion  
Protection

C4.  
Cable  
Management

D1.  
Terminals

D2.  
Power  
Connectors

D3.  
Grounding  
Connectors

E1.  
Labeling  
Systems

E2.  
Labels

E3.  
Pre-Printed  
& Write-On  
Markers

E4.  
Permanent  
Identification

E5.  
Lockout/  
Tagout  
& Safety  
Solutions

F.  
Index

A. System Overview

B1. Cable Ties

B2. Cable Accessories

B3. Stainless Steel Ties

C1. Wiring Duct

C2. Surface Raceway

C3. Abrasion Protection

C4. Cable Management

D1. Terminals

D2. Power Connectors

D3. Grounding Connectors

E1. Labeling Systems

E2. Labels

E3. Pre-Printed & Write-On Markers

E4. Permanent Identification

E5. Lockout/Tagout & Safety Solutions

F. Index

**For use with Copper Conductors**

## Installation Tooling and Die Selections for: Types LCB, LCBN, LCC, LCCN and SCL

How to read this chart

For LCB6 lug and CT-2001 crimping tool:

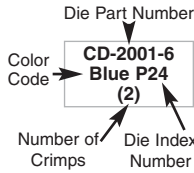

**Panduit (See Compression Connector Tools Selection Guide, Pages D3.34 – D3.36)**

**Thomas & Betts**

| Panduit Part Number                              | Std. Wire Size                       | Wire Strip Length (In.) | Panduit (See Compression Connector Tools Selection Guide, Pages D3.34 – D3.36) |                      |                      |                         |   |  |  | Thomas & Betts |               |                          |               |   |   |   |   |
|--|--------------------------------------|-------------------------|--|----------------------|----------------------|-------------------------|---|--|--|----------------|---------------|--------------------------|---------------|---|---|---|---|
|  |                                      |                         | CT-1570  | CT-1701 <sup>①</sup> | CT-1700 <sup>①</sup> | CT-720                  | CT-920, CT-920CH, CT-930, CT-930CH, CT-2920, CT-2930, CT-2930/L, CT-2930/LE, CT-2931, CT-930LPCH <sup>②</sup> , CT-940CH <sup>②</sup> , CT-2940 <sup>②</sup> , CT-2940/L <sup>②</sup> , CT-2940/LE <sup>②</sup> | Uni-Die™ CT-980, CT-980CH, CT-2950 <sup>②</sup> , CT-2980, CT-2980/L, CT-2980/LE, CT-2981, CT-980LPCH <sup>②</sup> , Extended Wire Range | CT-2001, CT-2001/L, CT-2001/LE, CT-2002, CT-2002/L, CT-3001, CT-3001/E | TBM20S, TBM25S | TBM5          | TBM6, TBM6S, 25000, TBM8 | TBM12, 13642M |   |   |   |   |
| L = Lug<br>S = Splice                            |                                      |                         | Die Part Number/Color Code and Die Index Number/(Number Of Crimps)             |                      |                      |                         |   |  |  |                |               |                          |               |   |   |   |   |
| LCB10<br>LCC10                                   | #14 – #10 AWG STR, #12 – #10 AWG SOL | 9/16                    | 12-10 (2)  | P10 (2)              | —                    | —                       | —   | —  | —  | —              | —             | —                        | —             | — | — | — | — |
| LCB8<br>LCBN8<br>LCC8<br>LCCN8<br>SCL8           | #8 AWG                               | 3/4<br>1-1/16           | —  | —                    | Red P21 (3)          | CD-720-1 Red P21 (2)    | CD-920-8 Red P21 (1)  | —  | CD-2001-8 Red P21 (2)  | Red 21 (3)     | Red 21 (1)    | Red 21 (1)               | Red 21 (1)    | — | — | — | — |
| LCB6<br>LCBN6<br>LCC6<br>LCCN6<br>SCL6           | #6 AWG                               | 1-1/8                   | —  | —                    | Blue P24 (3)         | CD-720-1 Blue P24 (2)   | CD-920-6 Blue P24 (1)   | —  | CD-2001-6 Blue P24 (2)   | Blue 24 (3)    | Blue 24 (1)   | Blue 24 (1)              | Blue 24 (1)   | — | — | — | — |
| LCB4<br>LCBN4<br>LCC4<br>LCCN4<br>SCL4           | #4 – #3 AWG STR, #2 AWG SOL          | 1-1/8                   | —  | —                    | Gray P29 (3)         | CD-720-1 Gray P29 (2)   | CD-920-4 Gray P29 (1)   | #4 – #2 AWG #2 AWG SOL Only (1)  | CD-2001-4 Gray P29 (2)   | Gray 29 (3)    | Gray 29 (1)   | Gray 29 (1)              | Gray 29 (1)   | — | — | — | — |
| LCB2<br>LCBN2<br>LCC2<br>LCCN2<br>SCL2           | #2 AWG                               | 1-1/4                   | —  | —                    | Brown P33 (3)        | CD-720-1 Brown P33 (2)  | CD-920-2 Brown P33 (1)  | #6 – #2 AWG (1)  | CD-2001-2 Brown P33 (2)  | Brown 33 (3)   | Brown 33 (1)  | Brown 33 (1)             | Brown 33 (1)  | — | — | — | — |
| LCB1<br>LCBN1<br>LCC1<br>LCCN1<br>SCL1           | #1 AWG                               | 1-7/16<br>1-3/8         | —  | —                    | Green P37 (4)        | CD-720-2 Green P37 (2)  | CD-920-1 Green P37 (1)  | #6 – #1 AWG (1)  | CD-2001-1 Green P37 (2)  | —              | Green 37 (1)  | Green 37 (1)             | Green 37 (1)  | — | — | — | — |
| LCB1/0<br>LCBN1/0<br>LCC1/0<br>LCCN1/0<br>SCL1/0 | 1/0 AWG                              | 1-1/2<br>1-3/8          | —  | —                    | —                    | CD-720-2 Pink P42 (2)   | CD-920-1/0 Pink P42 (2)   | #6 – 1/0 AWG (2)   | CD-2001-1/0 Pink P42 (2)   | —              | Pink 42 (2)   | Pink 42 (2)              | Pink 42 (2)   | — | — | — | — |
| LCB2/0<br>LCBN2/0<br>LCC2/0<br>LCCN2/0<br>SCL2/0 | 2/0 AWG                              | 1-9/16<br>1-1/2         | —  | —                    | —                    | CD-720-2 Black P45 (3)  | CD-920-2/0 Black P45 (3)  | #4 – 2/0 AWG (2)   | CD-2001-2/0 Black P45 (3)  | —              | Black 45 (3)  | Black 45 (3)             | Black 45 (2)  | — | — | — | — |
| LCB3/0<br>LCBN3/0<br>LCC3/0<br>LCCN3/0<br>SCL3/0 | 3/0 AWG                              | 1-9/16<br>1-1/2         | —  | —                    | —                    | CD-720-2 Orange P50 (3) | CD-920-3/0 Orange P50 (3)   | #2 – 3/0 AWG (2)   | CD-2001-3/0 Orange P50 (3)   | —              | Orange 50 (3) | Orange 50 (3)            | Orange 50 (2) | — | — | — | — |
| LCB4/0<br>LCBN4/0<br>LCC4/0<br>LCCN4/0<br>SCL4/0 | 4/0 AWG                              | 1-5/8                   | —  | —                    | —                    | CD-720-3 Purple P54 (3) | CD-920-4/0 Purple P54 (3)   | #1 – 4/0 AWG (2)   | CD-2001-4/0 Purple P54 (3)   | —              | Purple 54 (3) | Purple 54 (3)            | Purple 54 (2) | — | — | — | — |
| LCB250<br>LCBN250<br>LCC250<br>LCCN250<br>SLC250 | 250 kcmil                            | 1-11/16<br>1-5/8        | —  | —                    | —                    | CD-720-3 Yellow P62 (4) | CD-920-250 Yellow P62 (3)   | 1/0 AWG – 250 kcmil (3)  | CD-2001-250 Yellow P62 (3)   | —              | Yellow 62 (4) | Yellow 62 (4)            | Yellow 62 (2) | — | — | — | — |

①The CT-1700 and CT-1701 crimp die pockets are integrated into the tool frame.  
③CD-920 dies can be used with CT-940CH and CT-2940 tools with CD-940-DA adapter.

⑤Maximum size: 500 kcmil lugs and 250 kcmil splices.  
⑥Maximum size: 250 kcmil lugs and splices. No extended wire range.

For use with  
Copper  
Conductors

## Installation Tooling and Die Selections for: Types LCB, LCBN, LCC, LCCN and SCL (continued)

| Thomas & Betts   |   |  | Burndy                   |            |   |  |  | Anderson                      | Penn-Union                              | Greenlee   |
|--|---|--|--------------------------|------------|---|--|--|-------------------------------|---|------------|
| TBM15,<br>TBM15I,<br>TBM15BSCR                                     | TBM8-750M-1,<br>TBM8-750,<br>TBM750BSCR®,<br>TBM8-750BSCR | TBM14M,<br>TBM14BSCR,<br>BPLT14BSCR,<br>13100A | Y2MR,<br>Y1MR,<br>Y1MRTC | MY29       | Y35, Y35BH, Y39,<br>Y39BH, Y750,<br>Y750-2,<br>Y750BH, Y750HS,<br>Y750BH-2,<br>PAT750,<br>BAT750, BAT35 | Y45Ⓣ,<br>Y46Ⓣ  | Y644M,<br>Y644HS,<br>Y644MBH,<br>PAT644,<br>BAT644 | VC6                           | TDY-1                                   | 1989       |
| Die Part Number/Color Code and Die Index Number/(Number of Crimps) |   |  |                          |            |   |  |  |                               |   |            |
| —  | —   | —  | —                        | —          | —   | —  | —  | —                             | —                                       | —          |
| Red<br>21<br>(1)   | STD<br>(1)  | Red<br>21<br>(1)                               | Red<br>49<br>(2)         | #8<br>(1)  | U8CRT<br>Red 49<br>(1)  | U8CRT<br>Red 49<br>(1)                                     | —  | —                             | —                                       | —          |
| Blue<br>24<br>(1)  | STD<br>(1)  | Blue<br>24<br>(1)                              | Blue<br>7<br>(2)         | #6<br>(1)  | U5CRT<br>Blue 7<br>(1)  | U5CRT<br>Blue 7<br>(1)                                     | STD<br>(1)   | STD<br>(1)                    | —                                       | —          |
| Gray<br>29<br>(1)  | STD<br>(1)  | Gray<br>29<br>(1)                              | Gray<br>8<br>(2)         | #4<br>(1)  | U4CRT<br>Gray 8<br>(1)  | U4CRT<br>Gray 8<br>(1)                                     | STD<br>(1)   | STD<br>(1)                    | —                                       | STD<br>(1) |
| Brown<br>33<br>(1)   | STD<br>(1)  | Brown<br>33<br>(1)                             | Brown<br>10<br>(2)       | #2<br>(1)  | U2CRT<br>Brown 9 (solid)<br>/Brown 10<br>(stranded)<br>(2)  | U2CRT<br>Brown 9 (solid)<br>/Brown 10<br>(stranded)<br>(2) | STD<br>(1)   | STD<br>(1)                    | STD<br>(1)                              | STD<br>(1) |
| Green<br>37<br>(1)   | STD<br>(1)  | Green<br>37<br>(1)                             | —                        | #1<br>(1)  | U1CRT<br>Green 11<br>(2)  | U1CRT<br>Green 11<br>(2)                                   | STD<br>(1)   | STD<br>(1)                    | STD<br>(1)                              | STD<br>(1) |
| Pink<br>42HⓉ<br>(4)  | STD<br>(2)  | Pink<br>42H Ⓣ<br>(4)                           | —                        | 1/0<br>(2) | U25RT<br>Pink 12<br>(2)   | U25RT<br>Pink 12<br>(2)                                    | STD<br>(1)   | STD<br>(1)                    | STD<br>(1)                              | STD<br>(1) |
| Black<br>45<br>(2)   | STD<br>(2)  | Black<br>45<br>(2)                             | —                        | 2/0<br>(2) | U26RT<br>Black 13<br>(2)  | U26RT<br>Black 13<br>(2)                                   | STD<br>(1)   | STD<br>(1)                    | STD<br>(1)                              | STD<br>(1) |
| Orange<br>50<br>(2)  | STD<br>(2)  | Orange<br>50<br>(2)                            | —                        | 3/0<br>(2) | U27RT<br>Orange 14<br>(2)   | U27RT<br>Orange 14<br>(2)                                  | STD<br>(1)   | STD<br>(2)                    | STD<br>(1)                              | STD<br>(1) |
| Purple<br>54HⓉ<br>(4)  | STD<br>(2)  | Purple<br>54H Ⓣ<br>(4)                         | —                        | 4/0<br>(2) | U28RT<br>Purple 15<br>(2)   | U28RT<br>Purple 15<br>(2)                                  | STD<br>(1)   | STD<br>(2)                    | STD<br>(1)                              | STD<br>(1) |
| <b>LCB250</b><br><b>LCBN250</b><br><b>LCC250</b><br><b>LCCN250</b> | 250 kcmil   | 1-11/16  | —                        | —          | —   | CD-720-3<br>Yellow P62<br>(4)                              | CD-920-250<br>Yellow P62<br>(3)                    | 1/0 AWG –<br>250 kcmil<br>(3) | CD-2001-<br>250<br>Yellow<br>P62<br>(3) | —          |

ⓉHalf width dies.

ⓉRequires U die adapter.

ⓉMinimum size: #4 AWG lugs and splices.

Chart continues on pages D3.64 – D3.65

For technical assistance in the U.S., call 866-405-6654 (outside the U.S., see inside back cover for directory)

A.  
System  
Overview

B1.  
Cable Ties

B2.  
Cable  
Accessories

B3.  
Stainless  
Steel Ties

C1.  
Wiring  
Duct

C2.  
Surface  
Raceway

C3.  
Abrasion  
Protection

C4.  
Cable  
Management

D1.  
Terminals

D2.  
Power  
Connectors

D3.  
Grounding  
Connectors

E1.  
Labeling  
Systems

E2.  
Labels

E3.  
Pre-Printed  
& Write-On  
Markers

E4.  
Permanent  
Identification

E5.  
Lockout/  
Tagout  
& Safety  
Solutions

F.  
Index

A. System Overview

B1. Cable Ties

B2. Cable Accessories

B3. Stainless Steel Ties

C1. Wiring Duct

C2. Surface Raceway

C3. Abrasion Protection

C4. Cable Management

D1. Terminals

D2. Power Connectors

D3. Grounding Connectors

E1. Labeling Systems

E2. Labels

E3. Pre-Printed & Write-On Markers

E4. Permanent Identification

E5. Lockout/Tagout & Safety Solutions

F. Index

**For use with Copper Conductors**

## Installation Tooling and Die Selections for: Types LCB, LCBN, LCC, LCCN and SCL (continued)

| Panduit Part Number<br>L=Lug<br>S=Splice                           | Std. Wire Size | Wire Strip Length (In.) | Panduit (See Compression Connector Tools Selection Guide, Pages D3.34 – D3.36) |   |  |  | Thomas & Betts           |                                 |
|--|----------------|-------------------------|--|---|--|--|--------------------------|---------------------------------|
|  |                |                         | CT-720   | CT-920, CT-920CH, CT-930, CT-930CH, CT-2920, CT-2930, CT-2930/L, CT-2930/LE, CT-2931, CT-930LPCH <sup>⑥</sup> , CT-940CH <sup>③</sup> , CT-2940 <sup>③</sup> , CT-2940/L <sup>③</sup> , CT-2940/LE <sup>③</sup> | Uni-Die™<br>CT-980, CT-980CH, CT-2950 <sup>⑤</sup> , CT-2980, CT-2980/L, CT-2980/LE, CT2981, CT-980LPCH <sup>⑥</sup><br>Extended Wire Range <sup>⑨</sup> | CT-2001, CT-2001/L, CT-2001/LE, CT-2002, CT-2002/L, CT-3001, CT-3001/E | TBM6, TBM6S, 25000, TBM8 | TBM12, 13642M                   |
| Die Part Number/Color Code and Die Index Number/(Number Of Crimps) |                |                         |  |   |  |  |                          |                                 |
| LCB300<br>LCBN300<br>LCC300<br>LCCN300<br>SCL300                   | 300 kcmil      | 2-5/16<br>2             | CD-720-4<br>White P66<br>(4)   | CD-920-300<br>White P66<br>(3)  | 2/0 AWG – 300 kcmil<br>(3)   | CD-2001-300<br>White P66<br>(3)  | White 66<br>(4)          | White 66 <sup>②</sup><br>(4)    |
| LCB350<br>LCBN350<br>LCC350<br>LCCN350<br>SCL350                   | 350 kcmil      | 2-5/16<br>2             | CD-720-5<br>Red P71<br>(4)   | CD-920-350<br>Red P71<br>(3)  | 3/0 AWG – 350 kcmil<br>(3)   | CD-2001-350<br>Red P71<br>(3)  | Red 71<br>(4)            | Red 71H <sup>②</sup><br>(4)     |
| LCB400<br>LCBN400<br>LCC400<br>LCCN400<br>SCL400                   | 400 kcmil      | 2-3/8<br>2-1/8          | CD-720-6<br>Blue P76<br>(4)  | CD-920-400<br>Blue P76<br>(3)   | 4/0 AWG – 400 kcmil<br>(3)   | CD-2001-400<br>Blue P76<br>(4)   | Blue 76<br>(4)           | Blue 76H <sup>②</sup><br>(4)    |
| LCB500<br>LCBN500<br>LCC500<br>LCCN500<br>SCL500                   | 500 kcmil      | 2-9/16<br>2-1/4         | CD-720-7<br>Brown P87<br>(4)   | CD-920-500<br>Brown P87<br>(3)  | 4/0 AWG – 500 kcmil<br>(3)   | CD-2001-500<br>Brown P87<br>(4)  | Brown 87<br>(4)          | Brown 87H <sup>②</sup><br>(4)   |
| LCB600<br>LCBN600<br>LCC600<br>LCCN600<br>SCL600                   | 600 kcmil      | 2-3/4<br>2-11/16        | —  | CD-920-600<br>Green P94<br>(4)  | 250 – 600 kcmil<br>(3)   | —  | —                        | Green 94H <sup>②</sup><br>(4)   |
| LCB750<br>LCBN750<br>LCC750<br>LCCN750<br>SCL750                   | 750 kcmil      | 2-15/16<br>2-7/8        | —  | CD-920-750<br>CD-940-750 <sup>④</sup><br>Black P106<br>(4)  | 500 – 750 kcmil<br>(3)   | —  | —                        | Black 106H <sup>②</sup><br>(4)  |
| LCB800<br>LCBN800<br>LCC800<br>LCCN800                             | 800 kcmil      | 3                       | —  | CD-940-800 <sup>④</sup><br>Orange P107<br>(4)   | —  | —  | —                        | —                               |
| LCB1000<br>LCBN1000<br>LCC1000<br>LCCN1000<br>SCL1000              | 1000 kcmil     | 3-1/16<br>3             | —  | CD-940-1000 <sup>④</sup><br>White P125<br>(4)   | —  | —  | —                        | Yellow 125H <sup>②</sup><br>(4) |

②Half width dies.  
 ③CD-920 dies can be used with CT-940CH and CT-2940 tools with CD-940-DA adapter.  
 ④CD-940 dies to be used exclusively with CT-940CH and CT-2940 tools.  
 ⑤Maximum size: 500 kcmil lugs and 250 kcmil splices.  
 ⑥Maximum size: 250 kcmil lugs and splices. No extended wire range.  
 ⑨Maximum size: 500 kcmil lugs and splices.



For use with  
Copper  
Conductors

## Installation Tooling and Die Selections for: Types LCB, LCBN, LCC, LCCN and SCL (continued)

| Thomas & Betts   |   |  | Burdny  |  |  | Anderson   | Penn-Union | Greenlee   |
|--|---|--|---|--|--|------------|------------|------------|
| TBM15,<br>TBM15I,<br>TBM15BSCR                                     | TBM8-750M-1,<br>TBM8-750,<br>TBM750BSCR®,<br>TBM8-750BSCR | TBM14M,<br>TBM14BSCR,<br>BPLT14BSCR,<br>13100A | Y35, Y35BH, Y39,<br>Y39BH, Y750,<br>Y750-2,<br>Y750BH, Y750HS,<br>Y750BH-2,<br>PAT750,<br>BAT750, BAT35 | Y45 <sup>②</sup> ,<br>Y46 <sup>②</sup> | Y644M,<br>Y644HS,<br>Y644MBH,<br>PAT644,<br>BAT644 | VC6        | TDY-1      | 1989       |
| Die Part Number/Color Code and Die Index Number/(Number Of Crimps) |   |  |   |  |  |            |            |            |
| White 66<br>(3)  | STD<br>(3)  | White 66<br>(3)                                | U30RT<br>White 17<br>(3)  | U30RT<br>White 17<br>(3)               | STD<br>(1)   | STD<br>(3) | STD<br>(2) | STD<br>(1) |
| Red 71 <sup>②</sup><br>(4)   | STD<br>(3)  | Red 71<br>(4)                                  | U31RT<br>Red 18<br>(3)  | U31RT<br>Red 18<br>(3)                 | STD<br>(1)   | STD<br>(3) | STD<br>(2) | STD<br>(1) |
| Blue <sup>②</sup><br>(4)   | STD<br>(3)  | Blue 76<br>(4)                                 | U32RT<br>Blue 19<br>(3)   | U32RT<br>Blue 19<br>(3)                | STD<br>(1)   | STD<br>(3) | STD<br>(2) | STD<br>(1) |
| Brown 87 <sup>②</sup><br>(4)                                       | STD<br>(3)  | Brown 87<br>(4)                                | U34RT<br>Brown 20<br>(3)  | U34RT<br>Brown 20<br>(3)               | STD<br>(1)   | STD<br>(3) | STD<br>(2) | STD<br>(1) |
| Green 94 <sup>②</sup><br>(4)                                       | STD<br>(4)  | Green 94<br>(4)                                | U36RT<br>Green 22<br>(4)  | U36RT<br>Green 22<br>(4)               | STD<br>(1)   | —          | STD<br>(4) | —          |
| Black 106 <sup>②</sup><br>(4)                                      | STD<br>(4)  | Black 106<br>(4)                               | U39RT<br>Black 24<br>(5)  | U39RT<br>Black 24<br>(5)               | STD<br>(1)   | —          | STD<br>(2) | —          |
| —  | —   | —  | —   | —                                      | —  | —          | —          | —          |
| 125 <sup>②</sup><br>(4)  | —   | 125 <sup>②</sup><br>(4)                        | —   | S44RT<br>White 27<br>(6)               | —  | —          | —          | —          |

②Half width dies.

⑦Requires U die adapter.

⑧Minimum size: #4 AWG lugs and splices.

A.  
System  
Overview

B1.  
Cable Ties

B2.  
Cable  
Accessories

B3.  
Stainless  
Steel Ties

C1.  
Wiring  
Duct

C2.  
Surface  
Raceway

C3.  
Abrasion  
Protection

C4.  
Cable  
Management

D1.  
Terminals

D2.  
Power  
Connectors

D3.  
Grounding  
Connectors

E1.  
Labeling  
Systems

E2.  
Labels

E3.  
Pre-Printed  
& Write-On  
Markers

E4.  
Permanent  
Identification

E5.  
Lockout/  
Tagout  
& Safety  
Solutions

F.  
Index

A. System Overview

B1. Cable Ties

B2. Cable Accessories

B3. Stainless Steel Ties

C1. Wiring Duct

C2. Surface Raceway

C3. Abrasion Protection

C4. Cable Management

D1. Terminals

D2. Power Connectors

D3. Grounding Connectors

E1. Labeling Systems

E2. Labels

E3. Pre-Printed & Write-On Markers

E4. Permanent Identification

E5. Lockout/Tagout & Safety Solutions

F. Index

**For use with Copper Conductors**

## Installation Tooling and Die Selections for: Types LCBH, LCCH, and SCH

How to read this chart

For LCBH6 lug and CT-2001 crimping tool:

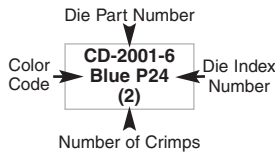

**Panduit (See Compression Connector Tools Selection Guide, Pages D3.34 – D3.36)**

**Thomas & Betts**

| Panduit Part Number             | Std. Wire Size | Wire Strip Length (In.) | Panduit (See Compression Connector Tools Selection Guide, Pages D3.34 – D3.36) |                         |   |   | Thomas & Betts   |               |                          |                             |  |
|---------------------------------|----------------|-------------------------|--|-------------------------|---|---|--|---------------|--------------------------|-----------------------------|--|
|                                 |                |                         | CT-1700 <sup>①</sup>   | CT-720                  | CT-920, CT-920CH, CT-2920, CT-930, CT-930CH, CT-2930, CT-2930/L, CT-2930/LE, CT-2931, CT-930LPCH <sup>②</sup> , CT-940CH <sup>②</sup> , CT-2940 <sup>③</sup> , CT-2940/L <sup>③</sup> , CT-2940/LE <sup>③</sup> | Uni-Die™ CT-980, CT-980CH, CT-2950 <sup>⑤</sup> , CT-2980 <sup>⑥</sup> , CT-2980/L <sup>⑥</sup> , CT-2980/LE <sup>⑥</sup> , CT-2981 <sup>⑥</sup> , CT-980LPCH <sup>⑥</sup> Wire Range | CT-2001, CT-2001/L, CT-2001/LE, CT-2002, CT-2002/L, CT-3001, CT-3001/E | TBM5          | TBM6, TBM6S, 25000, TBM8 | TBM12 13642M                |  |
| L = Lug<br>S = Splice           |                |                         | Die Part Number/Color Code and Die Index Number/(Number Of Crimps)             |                         |   |   |  |               |                          |                             |  |
| LCBH6<br>LCCH6<br>SCH6          | #6 AWG         | 1-1/8<br>15/16          | Blue P24 (3)   | CD-720-1 Blue P24 (2)   | CD-920-6 Blue P24 (1)   | —   | CD-2001-6 Blue P24 (2)   | Blue 24 (1)   | Blue 24 (1)              | Blue 24 (1)                 |  |
| LCBH4<br>LCCH4<br>SCH4          | #4 AWG         | 1-1/8<br>15/16          | Gray P29 (3)   | CD-720-1 Gray P29 (2)   | CD-920-4 Gray P29 (1)   | #2 AWG SOL, #3 AWG STR (1)  | CD-2001-4 Gray P29 (2)   | Gray 29 (1)   | Gray 29 (1)              | Gray 29 (1)                 |  |
| LCBH2<br>LCCH2<br>SCH2          | #2 AWG         | 1-1/4<br>1              | Brown P33 (3)  | CD-720-1 Brown P33 (2)  | CD-920-2 Brown P33 (1)  | #6 – #4 AWG (1)   | CD-2001-2 Brown P33 (2)  | Brown 33 (1)  | Brown 33 (1)             | Brown 33 (1)                |  |
| LCBH1<br>LCCH1<br>SCH1          | #1 AWG         | 1-7/16<br>1             | Green P37 (3)  | CD-720-2 Green P37 (2)  | CD-920-1 Green P37 (1)  | #6 – #2 AWG (1)   | CD-2001-1 Green P37 (2)  | Green 37 (1)  | Green 37 (1)             | Green 37 (1)                |  |
| LCBH1/0<br>LCCH1/0<br>SCH1/0    | 1/0 AWG        | 1-1/2<br>1              | —  | CD-720-2 Pink P42 (2)   | CD-920-1/0 Pink P42 (2)   | #6 – #1 AWG (2)   | CD-2001-1/0 Pink P42 (2)   | Pink 42 (2)   | Pink 42 (2)              | Pink 42 (2)                 |  |
| LCBH2/0<br>LCCH2/0<br>SCH2/0    | 2/0 AWG        | 1-9/16<br>1-1/16        | —  | CD-720-2 Black P45 (3)  | CD-920-2/0 Black P45 (3)  | #4 – 1/0 AWG (2)  | CD-2001-2/0 Black P45 (3)  | Black 45 (3)  | Black 45 (3)             | Black 45 (2)                |  |
| LCBH3/0<br>LCCH3/0<br>SCH3/0    | 3/0 AWG        | 1-9/16<br>1-3/16        | —  | CD-720-2 Orange P50 (3) | CD-920-3/0 Orange P50 (3)   | #2 – 2/0 AWG (2)  | CD-2001-3/0 Orange P50 (3)   | Orange 50 (3) | Orange 50 (3)            | Orange 50 (2)               |  |
| LCBH4/0<br>LCCH4/0<br>SCH4/0    | 4/0 AWG        | 1-5/8<br>1-3/16         | —  | CD-720-3 Purple P54 (3) | CD-920-4/0 Purple P54 (3)   | #1 – 3/0 AWG (2)  | CD-2001-4/0 Purple P54 (3)   | Purple 54 (3) | Purple 54 (3)            | Purple 54 (3)               |  |
| LCBH250<br>LCCH250<br>SCH250    | 250 kcmil      | 1-11/16<br>1-1/4        | —  | CD-720-3 Yellow P62 (4) | CD-920-250 Yellow P62 (3)   | 1/0 – 4/0 AWG (3)   | CD-2001-250 Yellow P62 (3)   | Yellow 62 (4) | Yellow 62 (4)            | Yellow 62 (2)               |  |
| LCBH300<br>LCCH300<br>SCH300    | 300 kcmil      | 2-5/16<br>2             | —  | CD-720-4 White P66 (4)  | CD-920-300 White P66 (3)  | 2/0 AWG – 250 kcmil (3)   | CD-2001-300 White P66 (3)  | —             | White 66 (4)             | White 66H <sup>②</sup> (4)  |  |
| LCBH350<br>LCCH350<br>SCH350    | 350 kcmil      | 2-5/16<br>2             | —  | CD-720-5 Red P71 (4)    | CD-920-350 Red P71 (3)  | 3/0 AWG – 300 kcmil (3)   | CD-2001-350 Red P71 (3)  | —             | Red 71 (4)               | Red 71H <sup>②</sup> (4)    |  |
| LCBH400<br>LCCH400<br>SCH400    | 400 kcmil      | 2-3/8<br>2-1/8          | —  | CD-720-6 Blue P76 (4)   | CD-920-400 Blue P76 (3)   | 4/0 AWG – 350 kcmil (3)   | CD-2001-400 Blue P76 (4)   | —             | Blue 76 (4)              | Blue 76H <sup>②</sup> (4)   |  |
| LCBH500<br>LCCH500<br>SCH500    | 500 kcmil      | 2-9/16<br>2-1/4         | —  | CD-720-7 Brown P87 (4)  | CD-920-500 Brown P87 (3)  | 4/0 AWG – 400 kcmil (3)   | CD-2001-500 Brown P87 (4)  | —             | Brown 87 (4)             | Brown 87H <sup>②</sup> (4)  |  |
| LCBH600<br>LCCH600<br>SCH600    | 600 kcmil      | 2-3/4<br>2-11/16        | —  | —                       | CD-920-600 Green P94 (4)  | 250 – 500 kcmil (3)   | —  | —             | —                        | Green 94H <sup>②</sup> (4)  |  |
| LCBH750<br>LCCH750<br>SCH750    | 750 kcmil      | 2-15/16<br>2-7/8        | —  | —                       | CD-920-750, CD-940-750 <sup>④</sup> Black P106 (4)  | 500 – 600 kcmil (3)   | —  | —             | —                        | Black 106H <sup>②</sup> (4) |  |
| LCBH1000<br>LCCH1000<br>SCH1000 | 1000 kcmil     | 3-1/16<br>3             | —  | —                       | CD-940-1000 <sup>④</sup> Green P125 (4)   | —   | —  | —             | —                        | 125H <sup>②</sup> (4)       |  |

①The CT-1700 crimp die pockets are integrated into the tool frame.

②Half width dies.

③CD-920 dies can be used with CT-940CH and CT-2940 tools with CD-940-DA adapter.

④CD-940 dies to be used exclusively with CT-940CH and CT-2940 tools.

⑤Maximum size: 500 kcmil lugs and 250 kcmil splices.

⑥Maximum size: 250 kcmil lugs and splices. No extended wire range.

⑦Maximum size: 500 kcmil lugs and splices.

For use with  
Copper  
Conductors

## Installation Tooling and Die Selections for: Types LCBH, LCCH, and SCH (continued)

| Thomas & Betts   |   |  | Burndy     |   |  | Anderson  | Penn-Union | Greenlee   |            |
|--|---|--|------------|---|--|---|------------|------------|------------|
| TBM15,<br>TBM15I,<br>TBM15BSCR                                     | TBM8-750M-1,<br>TBM8-750,<br>TBM8-750BSCR,<br>TBM750BSCR <sup>®</sup> | TBM14M,<br>TBM14BSCR,<br>BPLT14BSCR,<br>13100A | MY29       | Y39, Y35, Y35BH,<br>BAT35, Y750,<br>Y750BH-2,<br>Y750HS,<br>Y750-2, BAT750,<br>PAT750, Y39BH,<br>Y750BH | Y45 <sup>Ⓣ</sup> ,<br>Y46 <sup>Ⓣ</sup> | Y644,<br>Y644HS,<br>PAT644,<br>BAT644,<br>Y644MBH | VC6        | TDY-1      | 1989       |
| Die Part Number/Color Code and Die Index Number/(Number of Crimps) |   |  |            |   |  |   |            |            |            |
| Blue 24<br>(1)   | STD<br>(1)  | Blue 24<br>(1)                                 | 6<br>(1)   | U5CRT<br>Blue 7<br>(1)  | U5CRT<br>Blue 7<br>(1)                 | STD<br>(1)  | STD<br>(1) | —          | —          |
| Gray 29<br>(1)   | STD<br>(1)  | Gray 29<br>(1)                                 | 4<br>(1)   | U4CRT<br>Gray 8<br>(1)  | U4CRT<br>Gray 8<br>(1)                 | STD<br>(1)  | STD<br>(1) | —          | STD<br>(1) |
| Brown 33<br>(1)  | STD<br>(1)  | Brown 33<br>(1)                                | 2<br>(1)   | U2CRT<br>Brown 10<br>(2)  | U2CRT<br>Brown 10<br>(2)               | STD<br>(1)  | STD<br>(1) | STD<br>(1) | STD<br>(1) |
| Green 37<br>(1)  | STD<br>(1)  | Green 37<br>(1)                                | 1<br>(1)   | U1CRT<br>Green 11<br>(2)  | U1CRT<br>Green 11<br>(2)               | STD<br>(1)  | STD<br>(1) | STD<br>(1) | STD<br>(1) |
| Pink 42H <sup>Ⓣ</sup><br>(4)                                       | STD<br>(2)  | Pink 42H <sup>Ⓣ</sup><br>(4)                   | 1/0<br>(2) | U25RT<br>Pink 12<br>(2)   | U25RT<br>Pink 12<br>(2)                | STD<br>(1)  | STD<br>(1) | STD<br>(1) | STD<br>(1) |
| Black 45<br>(2)  | STD<br>(2)  | Black 45<br>(2)                                | 2/0<br>(2) | U26RT<br>Black 13<br>(2)  | U26RT<br>Black 13<br>(2)               | STD<br>(1)  | STD<br>(1) | STD<br>(1) | STD<br>(1) |
| Orange 50<br>(2)   | STD<br>(2)  | Orange 50<br>(2)                               | 3/0<br>(2) | U27RT<br>Orange 14<br>(2)   | U27RT<br>Orange 14<br>(2)              | STD<br>(1)  | STD<br>(2) | STD<br>(1) | STD<br>(1) |
| Purple 54H <sup>Ⓣ</sup><br>(4)                                     | STD<br>(2)  | Purple 54H <sup>Ⓣ</sup><br>(4)                 | 4/0<br>(2) | U28RT<br>Purple 15<br>(2)   | U28RT<br>Purple 15<br>(2)              | STD<br>(1)  | STD<br>(2) | STD<br>(1) | STD<br>(1) |
| Yellow 62<br>(2)   | STD<br>(2)  | Yellow 62<br>(2)                               | 250<br>(2) | U29RT<br>Yellow 16<br>(2)   | U29RT<br>Yellow 16<br>(2)              | STD<br>(1)  | STD<br>(2) | STD<br>(2) | STD<br>(1) |
| White 66H <sup>Ⓣ</sup><br>(4)                                      | STD<br>(3)  | White 66<br>(4)                                | —          | U30RT<br>White 17<br>(3)  | U30RT<br>White 17<br>(3)               | STD<br>(1)  | STD<br>(3) | STD<br>(2) | STD<br>(1) |
| Red 71H <sup>Ⓣ</sup><br>(4)  | STD<br>(3)  | Red 71H <sup>Ⓣ</sup><br>(4)                    | —          | U31RT<br>Red 18<br>(3)  | U31RT<br>Red 18<br>(3)                 | STD<br>(1)  | STD<br>(3) | STD<br>(2) | STD<br>(1) |
| Blue 76H <sup>Ⓣ</sup><br>(4)                                       | STD<br>(3)  | Blue 76<br>(4)                                 | —          | U32RT<br>Blue 19<br>(3)   | U32RT<br>Blue 19<br>(3)                | STD<br>(1)  | STD<br>(3) | STD<br>(2) | STD<br>(1) |
| Brown 87H <sup>Ⓣ</sup><br>(4)                                      | STD<br>(3)  | Brown 87H <sup>Ⓣ</sup><br>(4)                  | —          | U34RT<br>Brown 20<br>(3)  | U34RT<br>Brown 20<br>(3)               | STD<br>(1)  | STD<br>(3) | STD<br>(2) | STD<br>(1) |
| Green 94H <sup>Ⓣ</sup><br>(4)                                      | STD<br>(4)  | Green 94H <sup>Ⓣ</sup><br>(4)                  | —          | U36RT<br>Green 22<br>(4)  | U36RT<br>Green 22<br>(4)               | STD<br>(1)  | —          | STD<br>(2) | —          |
| Black 106H <sup>Ⓣ</sup><br>(4)                                     | STD<br>(4)  | Black 106H <sup>Ⓣ</sup><br>(4)                 | —          | U39RT<br>Black 24<br>(5)  | U39RT<br>Black 24<br>(5)               | STD<br>(1)  | —          | STD<br>(2) | —          |
| 125H <sup>Ⓣ</sup><br>(4)   | —   | 125H <sup>Ⓣ</sup><br>(4)                       | —          | —   | S44RT<br>White 27<br>(6)               | —   | —          | —          | —          |

ⓉHalf width dies.

ⓉRequires U die adapter.

ⓉMinimum size: #4 AWG lugs and splices.

A. System Overview

B1. Cable Ties

B2. Cable Accessories

B3. Stainless Steel Ties

C1. Wiring Duct

C2. Surface Raceway

C3. Abrasion Protection

C4. Cable Management

D1. Terminals

D2. Power Connectors

D3. Grounding Connectors

E1. Labeling Systems

E2. Labels

E3. Pre-Printed & Write-On Markers

E4. Permanent Identification

E5. Lockout/Tagout & Safety Solutions

F. Index

**For use with Copper Conductors**

## Installation Tooling and Die Selections for: Type SCT

### How to read this chart

For SCT2-2 splice and CT-2001 crimping tool:

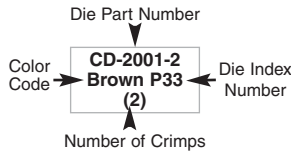

| Panduit (See Compression Connector Tools Selection Guide, Pages D3.34 – D3.36) |                |                         | Thomas & Betts   |                         |   |  |  |               |               |
|--|----------------|-------------------------|--|-------------------------|---|--|--|---------------|---------------|
| Panduit Part Number  | Std. Wire Size | Wire Strip Length (In.) | CT-1700 <sup>①</sup>   | CT-720                  | CT-920, CT-920CH, CT-2920, CT-930, CT-930CH, CT-2930, CT-2930/L, CT-2930/LE, CT-2931, CT-940CH <sup>③</sup> , CT-2940 <sup>③</sup> , CT-2940/L <sup>③</sup> , CT-2940/LE <sup>③</sup> | CT-980, CT-980CH, CT-2950 <sup>④</sup> , CT-2980, CT-2980/L, CT-2980/LE, CT-2981 | CT-2001, CT-2001/L, CT-2001/LE, CT-2002, CT-2002/L, CT-3001, CT-3001/E | TBM5          | TBM8          |
|  | Main Tap       | Main Tap                | Die Part Number/Color Code and Die Index Number/(Number of Crimps) |                         |   |  |  |               |               |
| SCT2-2   | #2 AWG         | 2                       | Brown P33 (3)  | CD-720-1 Brown P33 (2)  | CD-920-2 Brown P33 (1)  | STD (1)  | CD-2001-2 Brown P33 (2)  | Brown 33 (1)  | Brown 33 (1)  |
|  | #2 AWG         | 1-9/16                  |  |                         |   |  |  |               |               |
| SCT1/0-1/0   | 1/0 AWG        | 2-1/16                  | Pink P42 (3)   | CD-720-2 Pink P42 (2)   | CD-920-1/0 Pink P42 (2)   | STD (1)  | CD-2001-1/0 Pink P42 (2)   | Pink 42 (2)   | Pink 43 (2)   |
|  | 1/0 AWG        | 1-9/16                  |  |                         |   |  |  |               |               |
| SCT2/0-2/0   | 2/0 AWG        | 2-1/16                  | —  | CD-720-2 Black P45 (3)  | CD-920-2/0 Black P45 (3)  | STD (1)  | CD-2001-2/0 Black P45 (3)  | Black 45 (3)  | Black 45 (3)  |
|  | 2/0 AWG        | 1-9/16                  |  |                         |   |  |  |               |               |
| SCT4/0-1/0   | 4/0 AWG        | 2-1/16                  | —  | CD-720-2 Pink P42 (3)   | CD-920-1/0 Pink P42 (3)   | STD (1)  | CD-2001-1/0 Pink P42 (3)   | Pink 42 (3)   | Pink 42 (3)   |
|  | 1/0 AWG        | 1-9/16                  |  |                         |   |  |  |               |               |
| SCT4/0-4/0   | 4/0 AWG        | 2-1/8                   | —  | CD-720-3 Purple P54 (3) | CD-920-4/0 Purple P54 (3)   | STD (1)  | CD-2001-4/0 Purple P54 (3)   | Purple 54 (3) | Purple 54 (3) |
|  | 4/0 AWG        | 1-11/16                 |  |                         |   |  |  |               |               |
| SCT250-250   | 250 kcmil      | 2-3/16                  | —  | CD-720-3 Yellow P62 (4) | CD-920-250 Yellow P62 (3)   | STD (1)  | CD-2001-250 Yellow P62 (3)   | Yellow 62 (4) | Yellow 62 (4) |
|  | 250 kcmil      | 1-11/16                 |  |                         |   |  |  |               |               |
| SCT300-300   | 300 kcmil      | 2-13/16                 | —  | CD-720-4 White P65 (4)  | CD-920-300 White P65 (3)  | STD (1)  | CD-2001-300 White P66 (3)  | —             | White 66 (4)  |
|  | 300 kcmil      | 2-1/16                  |  |                         |   |  |  |               |               |
| SCT350-350   | 350 kcmil      | 2-13/16                 | —  | CD-720-5 Red P71 (4)    | CD-920-350 Red P71 (3)  | STD (1)  | CD-2001-350 Red P71 (3)  | —             | Red 71 (4)    |
|  | 350 kcmil      | 2-1/16                  |  |                         |   |  |  |               |               |
| SCT500-4/0   | 500 kcmil      | 2-15/16                 | —  | CD-720-7 Brown P87 (4)  | CD-920-500 Brown P87 (3)  | STD (1)  | CD-2001-500 Brown P87 (4)  | —             | Brown 87 (4)  |
|  | 4/0 AWG        | 2-15/16                 |  | CD-720-3 Purple P54 (4) | CD-920-4/0 Purple P54 (4)   |  | CD-2001-4/0 Purple P54 (4)   | —             | Purple 54 (4) |
| SCT500-500   | 500 kcmil      | 3-1/8                   | —  | CD-720-7 Brown P87 (4)  | CD-920-500 Brown P87 (3)  | STD (1)  | CD-2001-500 Brown P87 (4)  | —             | Brown 87 (4)  |
|  | 500 kcmil      | 2-9/16                  |  |                         |   |  |  |               |               |

① The CT-1700 crimp die pockets are integrated into the tool frame.  
 ③ CD-920 dies can be used with CT-940CH and CT-2940 tools with CD-940-DA adapter.  
 ④ Maximum size: 250 kcmil.

**For use with  
Copper  
Conductors**

## Installation Tooling and Die Selections for: Type SCT (continued)

| Thomas & Betts   |                                |   |  | Burndy     |   |   | Anderson   | Penn-Union | Greenlee   |
|--|--------------------------------|---|--|------------|---|---|------------|------------|------------|
| TBM12<br>13642M  | TBM15,<br>TBM15I,<br>TBM15BSCR | TBM8-750M-1,<br>TBM8-750,<br>TBM8-750BSCR | TBM14M,<br>TBM14BSCR,<br>BPLT14BSCR,<br>13100A | MY29       | Y39, Y35, Y35BH,<br>Y750HS, Y750,<br>BAT35, Y45,<br>Y39BH, Y46,<br>Y750-2,<br>BAT750,<br>PAT750,<br>Y750BH-2,<br>Y750BH | Y644,<br>Y644HS,<br>PAT644,<br>BAT644,<br>Y644MBH | VC6        | TDY-1      | 1989       |
| Die Part Number/Color Code and Die Index Number/(Number of Crimps) |                                |   |  |            |   |   |            |            |            |
| Brown 33<br>(1)  | Brown 33<br>(1)                | STD<br>(1)                                | Brown 33<br>(1)                                | 2<br>(1)   | U2CRT<br>Brown 10<br>(2)  | STD<br>(1)  | STD<br>(1) | STD<br>(1) | STD<br>(1) |
| Pink 42H <sup>Ⓜ</sup><br>(2)                                       | Pink 42H <sup>Ⓜ</sup><br>(4)   | STD<br>(2)                                | Pink 42H <sup>Ⓜ</sup><br>(4)                   | 1/0<br>(2) | U25RT<br>Pink 12<br>(2)   | STD<br>(1)  | STD<br>(1) | STD<br>(1) | STD<br>(1) |
| Black 45<br>(2)  | Black 45<br>(2)                | STD<br>(2)                                | Black 45<br>(2)                                | 2/0<br>(2) | U26RT<br>Black 13<br>(2)  | STD<br>(1)  | STD<br>(1) | STD<br>(1) | STD<br>(1) |
| Pink 42<br>(2)   | Pink 42H <sup>Ⓜ</sup><br>(4)   | STD<br>(2)                                | Pink 42H <sup>Ⓜ</sup><br>(4)                   | 1/0<br>(2) | U25RT<br>Pink 12<br>(2)   | STD<br>(1)  | STD<br>(2) | STD<br>(1) | STD<br>(1) |
| Purple 54<br>(2)   | Purple 54H<br>(4)              | STD<br>(2)                                | Purple 54H <sup>Ⓜ</sup><br>(4)                 | 4/0<br>(2) | U28RT<br>Purple 15<br>(2)   | STD<br>(1)  | STD<br>(2) | STD<br>(1) | STD<br>(1) |
| Yellow 62<br>(2)   | Yellow 62<br>(2)               | STD<br>(2)                                | Yellow 62<br>(2)                               | 250<br>(2) | U29RT<br>Yellow 16<br>(2)   | STD<br>(1)  | STD<br>(2) | STD<br>(1) | STD<br>(1) |
| White 66H <sup>Ⓜ</sup><br>(4)                                      | White 66H <sup>Ⓜ</sup><br>(4)  | STD<br>(3)                                | White 66H <sup>Ⓜ</sup><br>(4)                  | —          | U30RT<br>White 17<br>(3)  | STD<br>(1)  | STD<br>(3) | STD<br>(2) | STD<br>(1) |
| Red 71H <sup>Ⓜ</sup><br>(4)  | Red 71H <sup>Ⓜ</sup><br>(4)    | STD<br>(3)                                | Red 71<br>(3)                                  | —          | U31RT<br>Red 18<br>(3)  | STD<br>(1)  | STD<br>(3) | STD<br>(2) | STD<br>(1) |
| Brown 87H <sup>Ⓜ</sup><br>(4)                                      | Brown 87H <sup>Ⓜ</sup><br>(4)  | STD<br>(3)                                | Brown 87<br>(3)                                | —          | U34RT<br>Brown 20<br>(3)  | STD<br>(1)  | STD<br>(3) | STD<br>(2) | STD<br>(1) |
| Olive 54<br>(4)  | Olive 54H <sup>Ⓜ</sup><br>(4)  |   | Olive 54H <sup>Ⓜ</sup><br>(3)                  | —          | U28RT<br>Purple 15<br>(3)   |   |            |            |            |
| Brown 87H <sup>Ⓜ</sup><br>(4)                                      | Brown 87H <sup>Ⓜ</sup><br>(4)  | STD<br>(3)                                | Brown 87H <sup>Ⓜ</sup><br>(4)                  | —          | U34RT<br>Brown 20<br>(3)  | STD<br>(1)  | STD<br>(3) | STD<br>(2) | STD<br>(1) |

ⓂHalf width dies.

A.  
System  
Overview

B1.  
Cable Ties

B2.  
Cable  
Accessories

B3.  
Stainless  
Steel Ties

C1.  
Wiring  
Duct

C2.  
Surface  
Raceway

C3.  
Abrasion  
Protection

C4.  
Cable  
Management

D1.  
Terminals

D2.  
Power  
Connectors

D3.  
Grounding  
Connectors

E1.  
Labeling  
Systems

E2.  
Labels

E3.  
Pre-Printed  
& Write-On  
Markers

E4.  
Permanent  
Identification

E5.  
Lockout/  
Tagout  
& Safety  
Solutions

F.  
Index

A. System Overview

B1. Cable Ties

B2. Cable Accessories

B3. Stainless Steel Ties

C1. Wiring Duct

C2. Surface Raceway

C3. Abrasion Protection

C4. Cable Management

D1. Terminals

D2. Power Connectors

D3. Grounding Connectors

E1. Labeling Systems

E2. Labels

E3. Pre-Printed & Write-On Markers

E4. Permanent Identification

E5. Lockout/Tagout & Safety Solutions

F. Index

**For use with Copper Conductors**

## Installation Tooling and Die Selections for: Types LCAX, LCAXN, LCBX, LCDX, LCDXN and LCCX

### How to read this chart

For LCAX6 lug and CT-2001 crimping tool:

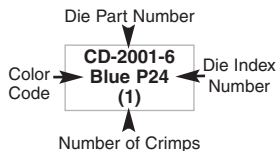

### Panduit (See Compression Connector Tools Selection Guide, Pages D3.34 – D3.36)

| Panduit Part Number                          | Std. Wire Size | Cable Classes                               | Wire Strip Length (In.) | Die Part Number/Color Code and Die Index Number (Number Of Crimps) |  |   |
|--|----------------|---|-------------------------|--|--|---|
|  |                |   |                         | CT-1700 <sup>①</sup>   | CT-2001, CT-2001/L, CT-2001/LE, CT-2002, CT-2002/L, CT-3001, CT-3001/E | CT-920, CT-920CH, CT-2920, CT-930, CT-930CH, CT-2930, CT-2930/L, CT-2930/LE, CT-2931, CT-2940 <sup>③</sup> , CT-2940/L <sup>③</sup> , CT-2940/LE <sup>③</sup> , CT-940CH <sup>③</sup> |
| LCAX8, LCDX8, LCDXN8, LCEX8, LCJX8           | #8 AWG         | Compact, B, G, H, I, K, M, Locomotive (DLO) | 1/2                     | Red P21 (2)  | CD-2001-8 Red P21 (1)  | CD-920-8 Red P21 (1)  |
| LCBX8, LCCX8                                 |                |   | 3/4                     | Red P21 (3)  | CD-2001-8 Red P21 (2)  |   |
| LCAX6, LCDX6, LCDXN6, LCEX6, LCJX6           | #6 AWG         | Compact, B, G, H, I, K, M, Locomotive (DLO) | 9/16                    | Blue P24 (2)   | CD-2001-6 Blue P24 (1)   | CD-920-6 Blue P24 (1)   |
| LCBX6, LCCX6                                 |                |   | 1-1/8                   | Blue P24 (3)   | CD-2001-6 Blue P24 (2)   |   |
| LCAX4, LCDX4, LCDXN4, LCEX4, LCJX4           | #4 AWG         | Compact, B, G, H, I, K, M                   | 5/8                     | Gray P29 (2)   | CD-2001-4 Gray P29 (1)   | CD-920-4 Gray P29 (1)   |
|  | #5, #4, #3     | Locomotive (DLO)                            |                         |  |  |   |
| LCBX4, LCCX4                                 | #4 AWG         | Compact, B, G, H, I, K, M                   | 1-1/8                   | Gray P29 (3)   | CD-2001-4 Gray P29 (2)   |   |
|  | #5, #4, #3     | Locomotive (DLO)                            |                         |  |  |   |
| LCAX2, LCDX2, LCDXN2, LCEX2, LCJX2           | #2 AWG         | Compact, B, G, H, I, K, M, Locomotive (DLO) | 11/16                   | Brown P33 (2)  | CD-2001-2 Brown P33 (1)  | CD-920-2 Brown P33 (1)  |
| LCBX2, LCCX2                                 |                |   | 1-7/16                  | Brown P33 (3)  | CD-2001-2 Brown P33 (2)  |   |
| LCAX1, LCDX1, LCDXN1, LCEX1, LCJX1           | #1 AWG         | Compact, B, G, H, I, K, M, Locomotive (DLO) | 3/4                     | —  | CD-2001-1 Green P37 (1)  | CD-920-1 Green P37 (1)  |
| LCBX1, LCCX1                                 |                |   | 1-1/2                   |  | CD-2001-1 Green P37 (2)  | CD-920-1 Green P37 (2)  |
| LCAX1/0, LCDX1/0, LCDXN1/0, LCEX1/0, LCJX1/0 | 1/0 AWG        | Compact, B, G, H, I, K, M, Locomotive (DLO) | 3/4                     | —  | CD-2001-1/0 Pink P42 (2)   | CD-920-1/0 Pink P42 (1)   |
| LCBX1/0, LCCX1/0                             |                |   | 1-9/16                  |  | CD-2001-1/0 Pink P42 (3)   | CD-920-1/0 Pink P42 (3)   |
| LCAX2/0, LCDX2/0, LCDXN2/0, LCEX2/0, LCJX2/0 | 2/0 AWG        | Compact, B, G, H, I, K, M, Locomotive (DLO) | 7/8                     | —  | CD-2001-2/0 Black P45 (2)  | CD-920-2/0 Black P45 (1)  |
| LCBX2/0, LCCX2/0                             |                |   | 1-9/16                  |  | CD-2001-2/0 Black P45 (3)  | CD-920-2/0 Black P45 (3)  |
| LCAX3/0, LCDX3/0, LCDXN3/0, LCEX3/0, LCJX3/0 | 3/0 AWG        | Compact, B, G, H, I, K, M, Locomotive (DLO) | 1                       | —  | CD-2001-3/0 Orange P50 (2)   | CD-920-3/0 Orange P50 (1)   |
| LCBX3/0, LCCX3/0                             |                |   | 1-5/8                   |  | CD-2001-3/0 Orange P50 (3)   | CD-920-3/0 Orange P50 (3)   |

①The CT-1700 crimp die pockets are integrated into the tool frame.  
 ②CD-920 dies can be used with CT-940CH and CT-2940 tools with CD-940-DA adapter.  
 ③Does not include class K flex conductor with Burndy tools.  
 ④Does not include class M flex conductor with Thomas and Betts tools.  
 ⑤Does not include class K and M flex conductor with Thomas and Betts tools.  
 ⑥Does not include class K flex conductor with Thomas and Betts tools.



For use with  
Copper  
Conductors

## Installation Tooling and Die Selections for: Types LCAX, LCAXN, LCBX, LCDX, LCDXN and LCCX (continued)

| Thomas & Betts   |                           |                                   |                            |                          |                                | Burdny                     |       |   |               |
|--|---------------------------|-----------------------------------|----------------------------|--------------------------|--------------------------------|----------------------------|-------|---|---------------|
| TBM12  | TBM8                      | TBM6,<br>25000                    | TBM6BSCR,<br>TBM6H         | TBM8-750,<br>TBM8-750M-1 | TBM14BSCR,<br>TBM14M,<br>TBM15 | BCT500HS,<br>Y500CT-HS     | Y644M | Y35, Y39, Y750,<br>Y46 <sup>®</sup> , Y750-2,<br>Y750BH, BAT35-14V,<br>BAT750-14V, Pat750-18V | MRC840        |
| Die Part Number/Color Code and Die Index Number/(Number of Crimps) |                           |                                   |                            |                          |                                |                            |       |   |               |
| TBM12D-1<br>Red 21<br>(1)  | 13461<br>Red 21<br>(1)    | 13475 & 13477<br>Red 21<br>(1)    | 6TON21<br>Red 21<br>(1)    | STD<br>(1)               | 15520<br>Red 21<br>(1)         | W8CRT<br>Red 49<br>(1)     | —     | U8CRT<br>Red 49<br>(1)  | Red 49<br>(1) |
| TBM12D-1<br>Red 21<br>(2)  | 13461<br>Red 21<br>(2)    | 13475 & 13477<br>Red 21<br>(2)    | 6TON21<br>Red 21<br>(2)    | STD<br>(2)               | 15520<br>Red 21<br>(2)         | W8CRT<br>Red 49<br>(2)     | —     | U8CRT<br>Red 49<br>(2)  | Red 49<br>(2) |
| TBM12D-1<br>Blue 24<br>(1)   | 13461<br>Blue 24<br>(1)   | 13475 & 13477<br>Blue 24<br>(1)   | 6TON24<br>Blue 24<br>(1)   | STD<br>(1)               | 15522<br>Blue 24<br>(1)        | W5CRT<br>Blue 7<br>(1)     | (1)   | U5CRT<br>Blue 7<br>(1)  | Blue 7<br>(1) |
| TBM12D-1<br>Blue 24<br>(2)   | 13461<br>Blue 24<br>(2)   | 13475 & 13477<br>Blue 24<br>(2)   | 6TON24<br>Blue 24<br>(2)   | STD<br>(2)               | 15522<br>Blue 24<br>(2)        | W5CRT<br>Blue 7<br>(2)     | (2)   | U5CRT<br>Blue 7<br>(2)  | Blue 7<br>(2) |
| TBM12D-2<br>Gray 29<br>(1)   | 13461<br>Gray 29<br>(1)   | 13472 & 13476<br>Gray 29<br>(1)   | 6TON29<br>Gray 29<br>(1)   | STD<br>(1)               | 15527-CK<br>Gray 29<br>(1)     | W4CRT<br>Gray 8<br>(1)     | (1)   | U4CRT<br>Gray 8<br>(1)  | —             |
| TBM12D-2<br>Gray 29<br>(3)   | 13461<br>Gray 29<br>(2)   | 13472 & 13476<br>Gray 29<br>(3)   | 6TON29<br>Gray 29<br>(2)   | STD<br>(3)               | 15527-CK<br>Gray 29<br>(2)     | W4CRT<br>Gray 8<br>(2)     | (2)   | U4CRT<br>Gray 8<br>(2)  | —             |
| TBM12D-2<br>Brown 33<br>(1)  | 13461<br>Brown 33<br>(1)  | 13474 & 13477<br>Brown 33<br>(1)  | 6TON33<br>Brown 33<br>(1)  | STD<br>(1)               | 15528<br>Brown 33<br>(1)       | W2CRT<br>Brown 10<br>(1)   | (1)   | U2CRT<br>Brown 10<br>(1)  | —             |
| TBM12D-2<br>Brown 33<br>(3)  | 13461<br>Brown 33<br>(3)  | 13474 & 13477<br>Brown 33<br>(3)  | 6TON33<br>Brown 33<br>(2)  | STD<br>(3)               | 15528<br>Brown 33<br>(2)       | W2CRT<br>Brown 10<br>(2)   | (2)   | U2CRT<br>Brown 10<br>(2)  | —             |
| TBM12D-1<br>Green 37<br>(1)  | 13462<br>Green 37<br>(1)  | 13474 & 13477<br>Green 37<br>(1)  | 6TON37<br>Green 37<br>(1)  | STD<br>(1)               | 15513-CK<br>Green 37<br>(1)    | W1CRT-1<br>Green 11<br>(1) | (1)   | U1CRT<br>Green 11<br>(1)  | —             |
| TBM12D-3<br>Green 37<br>(3)  | 13462<br>Green 37<br>(3)  | 13474 & 13477<br>Green 37<br>(3)  | 6TON37<br>Green 37<br>(2)  | STD<br>(3)               | 15513-CK<br>Green 37<br>(2)    | W1CRT-1<br>Green 11<br>(2) | (2)   | U1CRT<br>Green 11<br>(2)  | —             |
| TBM12D-3<br>Pink 42<br>(1)   | 13462<br>Pink 42<br>(1)   | 13475 & 13477<br>Pink 42<br>(2)   | 6TON42<br>Pink 42<br>(2)   | STD<br>(1)               | 15508<br>Pink 42<br>(2)        | W25RT<br>Pink 12<br>(2)    | (1)   | U25RT<br>Pink 12<br>(1)   | —             |
| TBM12D-3<br>Pink 42<br>(3)   | 13462<br>Pink 42<br>(3)   | 13475 & 13477<br>Pink 42<br>(3)   | 6TON42<br>Pink 42<br>(3)   | STD<br>(3)               | 15508<br>Pink 42<br>(3)        | W25RT<br>Pink 12<br>(3)    | (2)   | U25RT<br>Pink 12<br>(2)   | —             |
| TBM12D-4<br>Blk/Gold 45<br>(1)                                     | 13462<br>Black 45<br>(2)  | 13474 & 13477<br>Black 45<br>(2)  | 6TON45<br>Black 45<br>(2)  | STD<br>(1)               | 15526<br>Black 45<br>(1)       | W26RT<br>Black 13<br>(2)   | (1)   | U26RT<br>Black 13<br>(1)  | —             |
| TBM12D-4<br>Blk/Gold 45<br>(3)                                     | 13462<br>Black 45<br>(4)  | 13474 & 13477<br>Black 45<br>(3)  | 6TON45<br>Black 45<br>(3)  | STD<br>(3)               | 15526<br>Black 45<br>(2)       | W26RT<br>Black 13<br>(3)   | (2)   | U26RT<br>Black 13<br>(2)  | —             |
| TBM12D-4<br>Org/Tan 50<br>(1)                                      | 13462<br>Orange 50<br>(2) | 13474 & 13477<br>Orange 50<br>(2) | 6TON50<br>Orange 50<br>(2) | STD<br>(1)               | 15530<br>Orange 50<br>(2)      | W27RT<br>Orange 14<br>(2)  | (1)   | U27RT<br>Orange 14<br>(1)   | —             |
| TBM12D-4<br>Org/Tan 50<br>(3)                                      | 13462<br>Orange 50<br>(4) | 13474 & 13477<br>Orange 50<br>(3) | 6TON50<br>Orange 50<br>(3) | STD<br>(3)               | 15530<br>Orange 50<br>(3)      | W27RT<br>Orange 14<br>(4)  | (2)   | U27RT<br>Orange 14<br>(2)   | —             |

®Requires U die adapter.

Chart continues on pages D3.72–D3.73

A.  
System  
Overview

B1.  
Cable Ties

B2.  
Cable  
Accessories

B3.  
Stainless  
Steel Ties

C1.  
Wiring  
Duct

C2.  
Surface  
Raceway

C3.  
Abrasion  
Protection

C4.  
Cable  
Management

D1.  
Terminals

D2.  
Power  
Connectors

D3.  
Grounding  
Connectors

E1.  
Labeling  
Systems

E2.  
Labels

E3.  
Pre-Printed  
& Write-On  
Markers

E4.  
Permanent  
Identification

E5.  
Lockout/  
Tagout  
& Safety  
Solutions

F.  
Index

A. System Overview

B1. Cable Ties

B2. Cable Accessories

B3. Stainless Steel Ties

C1. Wiring Duct

C2. Surface Raceway

C3. Abrasion Protection

C4. Cable Management

D1. Terminals

D2. Power Connectors

D3. Grounding Connectors

E1. Labeling Systems

E2. Labels

E3. Pre-Printed & Write-On Markers

E4. Permanent Identification

E5. Lockout/Tagout & Safety Solutions

F. Index

**For use with Copper Conductors**

## Installation Tooling and Die Selections for: Types LCAX, LCAXN, LCBX, LCDX, LCDXN and LCCX (continued)

### Panduit (See Compression Connector Tools Selection Guide, Pages D3.34 – D3.36)

| Panduit Part Number                                    | Std. Wire Size | Cable Classes  | Wire Strip Length (In.) | Die Part Number/Color Code and Die Index Number/(Number Of Crimps) |  |   |
|--|----------------|--|-------------------------|--|--|---|
|  |                |  |                         | CT-1700 <sup>①</sup>   | CT-2001, CT-2001/L, CT-2001/LE, CT-2002, CT-2002/L, CT-3001, CT-3001/E | CT-920, CT-920CH, CT-2920, CT-930, CT-930CH, CT-2930, CT-2930/L, CT-2930/LE, CT-2931, CT-2940 <sup>②</sup> , CT-2940/L <sup>②</sup> , CT-2940/LE <sup>②</sup> , CT-940CH <sup>③</sup> |
| LCAX4/0, LCDX4/0, LCDXN4/0, LCEX4/0, LCJX4/0           | 4/0 AWG        | Compact, B, G, H, I, K, M, Locomotive (DLO) <sup>⑦</sup> | 1-1/16                  | —  | CD-2001-4/0 Purple P54 (2)   | CD-920-4/0 Purple P54 (1)   |
| LCBX4/0, LCCX4/0                                       |                |  | 2-5/16                  |  | CD-2001-4/0 Purple P54 (3)   | CD-920-4/0 Purple P54 (3)   |
| LCAX250, LCAXN250, LCDX250, LCDXN250, LCEX250, LCJX250 | 250 kcmil      | G, H, I, K, M  | 1-1/16                  | —  | CD-2001-250 Yellow P62 (2)   | CD-920-250 Yellow P62 (1)   |
| LCBX250, LCCX250                                       | 262.6 kcmil    | Locomotive (DLO)   | 2-5/16                  |  | CD-2001-250 Yellow P62 (3)   | CD-920-250 Yellow P62 (3)   |
| LCAX300, LCDX300, LCDXN300, LCEX300, LCJX300           | 300 kcmil      | G, H, I, K, M  | 1-1/4                   | —  | CD-2001-350 Red P71 (2)  | CD-920-350 Red P71 (2)  |
|  | 313.1 kcmil    | Locomotive (DLO)   |                         |  |  |   |
| LCBX300, LCCX300                                       | 300 kcmil      | G, H, I, K, M  | 2-3/8                   | —  | CD-2001-350 Red P71 (4)  | CD-920-350 Red P71 (3)  |
|  | 313.1 kcmil    | Locomotive (DLO)   |                         |  |  |   |
| LCAX350, LCDX350, LCDXN350, LCEX350, LCJX350           | 350 kcmil      | G, H, I, K, M  | 1-3/8                   | —  | CD-2001-400 Blue P76 (2)   | CD-920-400 Blue P76 (2)   |
|  | 373.7 kcmil    | Locomotive (DLO)   |                         |  |  |   |
| LCBX350, LCCX350                                       | 350 kcmil      | G, H, I, K, M  | 2-9/16                  | —  | CD-2001-400 Blue P76 (4)   | CD-920-400 Blue P76 (3)   |
|  | 373.7 kcmil    | Locomotive (DLO)   |                         |  |  |   |
| LCAX450, LCDX450, LCDXN450, LCEX450, LCJX450           | 450 kcmil      | G, H, I, K, M  | 1-7/16                  | —  | —  | CD-920-500 Brown P87 (2)  |
|  | 444.4 kcmil    | Locomotive (DLO)   |                         |  |  |   |
| LCBX450, LCCX450                                       | 450 kcmil      | G, H, I, K, M  | 2-3/4                   | —  | —  | CD-920-500 Brown P87 (4)  |
|  | 444.4 kcmil    | Locomotive (DLO)   |                         |  |  |   |
| LCAX500, LCDX500, LCDXN500, LCEX500, LCJX500           | 500 kcmil      | G, H, I, K, M  | 1-9/16                  | —  | —  | CD-920-500A Pink P99 (2)  |
| LCBX500, LCCX500                                       | 535.3 kcmil    | Locomotive (DLO)   | 2-15/16                 |  |  | CD-920-500A Pink P99 (4)  |
| LCAX600, LCDX600, LCDXN600, LCEX600, LCJX600           | 600 kcmil      | G, H, I  | 1-9/16                  | —  | —  | CD-920-500A Pink P99 (2)  |
| LCAX650, LCDX650, LCDXN650, LCEX650, LCJX650           | 646.4 kcmil    | Locomotive (DLO)   | 1-1/2                   | —  | —  | CD-940-750 <sup>④</sup> Black P106 (2)  |
| LCAX750, LCDX750, LCDXN750, LCEX750, LCJX750           | 777.7 kcmil    | Locomotive (DLO)   | 1-3/4                   | —  | —  | CD-940-750X <sup>④</sup> Yellow (2)   |

①The CT-1700 crimp die pockets are integrated into the tool frame.  
 ②CD-920 dies can be used with CT-940CH and CT-2940 tools with CD-940-DA adapter.  
 ③CD-940 dies to be used exclusively with CT-940CH and CT-2940 tools.  
 ⑦Does not include class M flex conductor with Thomas and Betts tools.

**For use with  
Copper  
Conductors**

## Installation Tooling and Die Selections for: Types LCAX, LCAXN, LCBX, LCDX, LCDXN and LCCX (continued)

| Thomas & Betts  |      |                |   |                          |  | Burndy                    |       |  |        |
|---|------|----------------|---|--------------------------|--|---------------------------|-------|--|--------|
| TBM12   | TBM8 | TBM6,<br>25000 | TBM6BSCR,<br>TBM6H                      | TBM8-750,<br>TBM8-750M-1 | TBM14BSCR,<br>TBM14M,<br>TBM15             | BCT500HS,<br>Y500CT-HS    | Y644M | Y35, Y39, Y750,<br>Y46 <sup>Ⓢ</sup> , Y750-2,<br>Y750BH,<br>BAT35-14V,<br>BAT750-14V, PAT750-18V | MRC840 |
| Die Part Number/Color Code and<br>Die Index Number (Number of Crimps) |      |                |   |                          |  |                           |       |  |        |
| TBM12D-5<br>Purp/Olive 54<br>(1)                                      | —    | —              | 6TON54<br>Purple 54<br>(2)              | STD<br>(1)               | 15511<br>Purple 54<br>(2)                  | W28RT<br>Purple 15<br>(2) | (1)   | U28RT<br>Purple 15<br>(1)  | —      |
| TBM12D-5<br>Purp/Olive 54<br>(4)                                      | —    | —              | 6TON54<br>Purple 54<br>(4)              | STD<br>(4)               | 15511<br>Purple 54<br>(4)                  | W28RT<br>Purple 15<br>(4) | (3)   | U28RT<br>Purple 15<br>(3)  | —      |
| TBM12D-5<br>Yellow 62<br>(1)  | —    | —              | 6TON62<br>Yellow 62<br>(2)              | STD<br>(1)               | 15510-CK<br>Yellow 62<br>(1)               | W29RT<br>Yellow 16<br>(2) | (1)   | U29RT<br>Yellow 16<br>(1)  | —      |
| TBM12D-5<br>Yellow 62<br>(3)  | —    | —              | 6TON62<br>Yellow 62<br>(4)              | STD<br>(4)               | 15510-CK<br>Yellow 62<br>(2)               | W29RT<br>Yellow 16<br>(4) | (3)   | U29RT<br>Yellow 16<br>(3)  | —      |
| TBM12D-4<br>Red 71H <sup>Ⓢ</sup><br>(2)                               | —    | —              | 6TON71<br>Red 71H <sup>Ⓢ</sup><br>(2)   | STD<br>(2)               | 15514-CK<br>Red 71H <sup>Ⓢ</sup><br>(2)    | W31RT<br>Red 18<br>(2)    | (1)   | U31RT<br>Red 18<br>(2)   | —      |
| TBM12D-4<br>Red 71H <sup>Ⓢ</sup><br>(4)                               | —    | —              | 6TON71<br>Red 71H <sup>Ⓢ</sup><br>(4)   | STD<br>(4)               | 15514-CK<br>Red 71H <sup>Ⓢ</sup><br>(4)    | W31RT<br>Red 18<br>(4)    | (3)   | U31RT<br>Red 18<br>(4)   | —      |
| TBM12D-4<br>Blue 76H <sup>Ⓢ</sup><br>(2)                              | —    | —              | 6TON76<br>Blue 76H <sup>Ⓢ</sup><br>(2)  | STD<br>(2)               | 15512<br>Blue 76H <sup>Ⓢ</sup><br>(2)      | W32RT<br>Blue 19<br>(3)   | (1)   | U32RT<br>Blue 19<br>(2)  | —      |
| TBM12D-4<br>Blue 76H <sup>Ⓢ</sup><br>(4)                              | —    | —              | 6TON76<br>Blue 76H <sup>Ⓢ</sup><br>(4)  | STD<br>(4)               | 15512<br>Blue 76H <sup>Ⓢ</sup><br>(4)      | W32RT<br>Blue 19<br>(4)   | (3)   | U32RT<br>Blue 19<br>(4)  | —      |
| TBM12D-3<br>Brown 87H <sup>Ⓢ</sup><br>(2)                             | —    | —              | 6TON87<br>Brown 87H <sup>Ⓢ</sup><br>(2) | STD<br>(2)               | 15506<br>Brown 87H <sup>Ⓢ</sup><br>(2)     | —                         | (1)   | U34RT<br>Brown 20<br>(2)   | —      |
| TBM12D-3<br>Brown 87H <sup>Ⓢ</sup><br>(4)                             | —    | —              | 6TON87<br>Brown 87H <sup>Ⓢ</sup><br>(4) | STD<br>(4)               | 15506<br>Brown 87H <sup>Ⓢ</sup><br>(4)     | —                         | (4)   | U34RT<br>Brown 20<br>(4)   | —      |
| TBM12D-2<br>Pink 99H <sup>Ⓢ</sup><br>(2)                              | —    | —              | —                                       | STD<br>(2)               | 15505<br>Pink 99H <sup>Ⓢ</sup><br>(2)      | —                         | (1)   | U38XRT<br>Pink L99<br>(2)  | —      |
| TBM12D-2<br>Pink 99H <sup>Ⓢ</sup><br>(4)                              | —    | —              | —                                       | STD<br>(4)               | 15505<br>Pink 99H <sup>Ⓢ</sup><br>(4)      | —                         | (4)   | U38XRT<br>Pink L99<br>(4)  | —      |
| TBM12D-2<br>Pink 99H <sup>Ⓢ</sup><br>(2)                              | —    | —              | —                                       | STD<br>(2)               | 15505<br>Pink 99H <sup>Ⓢ</sup><br>(2)      | —                         | (1)   | U38RT<br>Pink 400<br>(2)   | —      |
| TBM12D-2<br>Black 106H <sup>Ⓢ</sup><br>(2)                            | —    | —              | —                                       | —                        | 15515-CK<br>Black 106H <sup>Ⓢ</sup><br>(2) | —                         | (1)   | U39RT<br>Black 24<br>(2)   | —      |
| TBM12D-1<br>Yellow 115H <sup>Ⓢ</sup><br>(2)                           | —    | —              | —                                       | —                        | 15504<br>Yellow 115H <sup>Ⓢ</sup><br>(2)   | —                         | (1)   | U44XRT<br>Yellow L115<br>(2)   | —      |

ⓈHalf width dies.

ⓈRequires U die adapter.

A.  
System  
Overview

B1.  
Cable Ties

B2.  
Cable  
Accessories

B3.  
Stainless  
Steel Ties

C1.  
Wiring  
Duct

C2.  
Surface  
Raceway

C3.  
Abrasion  
Protection

C4.  
Cable  
Management

D1.  
Terminals

D2.  
Power  
Connectors

D3.  
Grounding  
Connectors

E1.  
Labeling  
Systems

E2.  
Labels

E3.  
Pre-Printed  
& Write-On  
Markers

E4.  
Permanent  
Identification

E5.  
Lockout/  
Tagout  
& Safety  
Solutions

F.  
Index

- A. System Overview
- B1. Cable Ties
- B2. Cable Accessories
- B3. Stainless Steel Ties
- C1. Wiring Duct
- C2. Surface Raceway
- C3. Abrasion Protection
- C4. Cable Management
- D1. Terminals
- D2. Power Connectors
- D3. Grounding Connectors
- E1. Labeling Systems
- E2. Labels
- E3. Pre-Printed & Write-On Markers
- E4. Permanent Identification
- E5. Lockout/Tagout & Safety Solutions
- F. Index

**For use with Copper Conductors**

## Installation Tooling and Die Selections for: Types LCAF, LCCF, and SCSF

### How to read this chart

For LCAF6 Lug and CT-2931 crimping tool:



**Panduit (See Compression Connector Tools Selection Guide, Pages D3.34 – D3.36)**

**CT-930, CT-930CH, CT-2930, CT-2930/L, CT-2930/LE, CT-2931, CT-920, CT-920CH, CT-2920, CT-940CH<sup>①</sup>, CT-2940<sup>①</sup>, CT-2940/L<sup>①</sup>, CT-2940/LE<sup>①</sup>**

### Die Part Number/Color Code and Die Index Number/ (Number Of Crimps)

| Panduit Part Number           | Std. Wire Size | Cable Classes             | Wire Strip Length (In.)     | Die Part Number/Color Code and Die Index Number/ (Number Of Crimps) |                               |
|-------------------------------|----------------|---------------------------|-----------------------------|---|-------------------------------|
|                               |                |                           |                             | for LCAF, SCSF Parts  | for LCCF Parts                |
| LCAF8<br>LCCF8<br>SCSF8       | #8 AWG         | Locomotive (DLO)          | 13/16<br>11/16              | CD-920-8<br>Red P21<br>(1)  |                               |
| LCAF6<br>LCCF6<br>SCSF6       | #6 AWG         | K, M,<br>Locomotive (DLO) | 7/8<br>1-5/16<br>13/16      | CD-920-6<br>Blue P24<br>(1)   | CD-920-6<br>Blue P24<br>(2)   |
| LCAF4<br>LCCF4<br>SCSF4       | #4 AWG         | K, M,<br>Locomotive (DLO) | 7/8<br>1-5/16<br>13/16      | CD-920-4<br>Gray P29<br>(1)   | CD-920-4<br>Gray P29<br>(2)   |
| LCAF2<br>LCCF2<br>SCSF2       | #2 AWG         | K, M,<br>Locomotive (DLO) | 15/16<br>1-7/16<br>7/8      | CD-920-2<br>Brown P33<br>(1)  | CD-920-2<br>Brown P33<br>(2)  |
| LCAF1<br>LCCF1<br>SCSF1       | #1 AWG         | K, M,<br>Locomotive (DLO) | 1<br>1-1/2<br>7/8           | CD-920-1/0<br>Pink P42<br>(1)                                       | CD-920-1/0<br>Pink P42<br>(2) |
| LCAF1/0<br>LCCF1/0<br>SCSF1/0 | 1/0 AWG        | K, M,<br>Locomotive (DLO) | 1-7/16<br>1-9/16<br>1-3/16  | CD-920-2/0<br>Black P45<br>(2)                                      |                               |
| LCAF2/0<br>LCCF2/0<br>SCSF2/0 | 2/0 AWG        | K, M,<br>Locomotive (DLO) | 1-7/16<br>1-9/16<br>1-3/16  | CD-920-3/0<br>Orange P50<br>(2)                                     |                               |
| LCAF3/0<br>LCCF3/0<br>SCSF3/0 | 3/0 AWG        | K, M,<br>Locomotive (DLO) | 1-7/16<br>1-5/8<br>1-3/16   | CD-920-4/0<br>Purple P54<br>(2)                                     |                               |
| LCAF4/0<br>LCCF4/0<br>SCSF4/0 | 4/0 AWG        | K, M,<br>Locomotive (DLO) | 1-7/16<br>1-11/16<br>1-3/16 | CD-920-250<br>Yellow P62<br>(2)                                     |                               |

<sup>①</sup>CD-920 dies can be used with CT-940CH and CT-2940 tools with CD-940-DA adapter.

For use with  
Copper  
Conductors

## Installation Tooling and Die Selections for: Types LCAF, LCCF, and SCSF (continued)

|                       |                          |                           |                         | Panduit (See Compression Connector Tools Selection Guide, Pages D3.34 – D3.36)  |   |
|-----------------------|--------------------------|---------------------------|-------------------------|---|---|
|                       |                          |                           |                         | CT-930, CT-930CH, CT-2930, CT-2930/L, CT-2930/LE, CT-2931, CT-920, CT-920CH, CT-2920, CT-940CH <sup>①</sup> , CT-2940 <sup>①</sup> , CT-2940/L <sup>①</sup> , CT-2940/LE <sup>①</sup> |   |
|                       |                          |                           |                         | Die Part Number/Color Code and Die Index Number/ (Number Of Crimps)   |   |
| Panduit Part Number   | Std. Wire Size           | Cable Classes             | Wire Strip Length (In.) | for LCAF, SCSF Parts  | for LCCF Parts                                |
| L = Lug<br>S = Splice |                          |                           |                         |   |   |
| LCAF250               | 250 kcmil<br>262.6 kcmil | K, M,<br>Locomotive (DLO) | 1-3/4                   | CD-920-300<br>White P66<br>(2)  | CD-920-300<br>White P66<br>(3)                |
| LCCF250               |                          |                           | 2-5/16                  |   |   |
| SCSF250               |                          |                           | 1-3/16                  |   |   |
| LCAF300               | 300 kcmil<br>313.1 kcmil | K, M,<br>Locomotive (DLO) | 1-3/4                   | CD-920-350<br>Red P71<br>(2)  | CD-920-350<br>Red P71<br>(3)                  |
| LCCF300               |                          |                           | 2-3/8                   |   |   |
| SCSF300               |                          |                           | 1-1/4                   |   |   |
| LCAF350               | 350 kcmil<br>373.7 kcmil | K, M,<br>Locomotive (DLO) | 1-15/16                 | CD-920-400<br>Blue P76<br>(2)   | CD-920-400<br>Blue P76<br>(3)                 |
| LCCF350               |                          |                           | 2-9/16                  |   |   |
| SCSF350               |                          |                           | 1-1/2                   |   |   |
| LCAF400               | 400 kcmil<br>444.4 kcmil | K, M,<br>Locomotive (DLO) | 2-1/4                   | CD-920-500<br>Brown P87<br>(2)  | CD-920-500<br>Brown P87<br>(3)                |
| LCCF400               |                          |                           | 2-3/4                   |   |   |
| SCSF400               |                          |                           | 1-11/16                 |   |   |
| LCAF500               | 500 kcmil<br>535.3 kcmil | K, M,<br>Locomotive (DLO) | 2-5/16                  | CD-920-500A<br>Pink P99<br>(2)  | CD-920-500A<br>Pink P99<br>(3)                |
| LCCF500               |                          |                           | 2-15/16                 |   |   |
| SCSF500               |                          |                           | 1-5/8                   |   |   |
| LCAF600 <sup>③</sup>  | 646.4 kcmil              | Locomotive (DLO)          | 2-3/8                   | CD-920-750<br>Black P106<br>(2)   | CD-920-750<br>Black P106<br>(3)               |
| LCCF600 <sup>③</sup>  |                          |                           | 3                       |   |   |
| SCSF600 <sup>③</sup>  |                          |                           | 1-5/8                   |   |   |
| LCAF750 <sup>③</sup>  | 777.7 kcmil              | Locomotive (DLO)          | 2-7/16                  | CD-940-800 <sup>②</sup><br>Orange P107<br>(2)   | CD-940-800 <sup>②</sup><br>Orange P107<br>(4) |
| LCCF750 <sup>③</sup>  |                          |                           | 3-1/16                  |   |   |
| SCSF750 <sup>③</sup>  |                          |                           | 1-5/8                   |   |   |

① CD-920 dies can be used with CT-940CH and CT-2940 tools with CD-940-DA adapter.

② CD-940 dies to be used exclusively with CT-940CH and CT-2940 tools.

③ Can only be crimped with CT-940CH and CT-2940 tools.

A.  
System  
Overview

B1.  
Cable Ties

B2.  
Cable  
Accessories

B3.  
Stainless  
Steel Ties

C1.  
Wiring  
Duct

C2.  
Surface  
Raceway

C3.  
Abrasion  
Protection

C4.  
Cable  
Management

D1.  
Terminals

D2.  
Power  
Connectors

D3.  
Grounding  
Connectors

E1.  
Labeling  
Systems

E2.  
Labels

E3.  
Pre-Printed  
& Write-On  
Markers

E4.  
Permanent  
Identification

E5.  
Lockout/  
Tagout  
& Safety  
Solutions

F.  
Index

A. System Overview

B1. Cable Ties

B2. Cable Accessories

B3. Stainless Steel Ties

C1. Wiring Duct

C2. Surface Raceway

C3. Abrasion Protection

C4. Cable Management

D1. Terminals

D2. Power Connectors

D3. Grounding Connectors

E1. Labeling Systems

E2. Labels

E3. Pre-Printed & Write-On Markers

E4. Permanent Identification

E5. Lockout/Tagout & Safety Solutions

F. Index

**For use with Copper Conductors**

## Installation Tooling and Die Selections for: Type RSC In-Line Reducing Splice

### How to read this chart

For RSC4-6 splice and CT-2001 crimping tool:



| Panduit Part Number | Reducing From               |               |                         | Reducing To                 |               |                         |
|---------------------|-----------------------------|---------------|-------------------------|-----------------------------|---------------|-------------------------|
|                     | Standard Wire Size          | Cable Classes | Wire Strip Length (In.) | Standard Wire Size          | Cable Classes | Wire Strip Length (In.) |
| <b>RSC4-6</b>       | #4 – #3 AWG STR, #2 AWG SOL | B, C, Compact | 1                       | #6 AWG                      | B, C, Compact | 1-5/16                  |
| <b>RSC2-6</b>       | #2 AWG                      | B, C, Compact | 1                       | #6 AWG                      | B, C, Compact | 1-5/16                  |
| <b>RSC2-4</b>       | #2 AWG                      | B, C, Compact | 1                       | #4 – #3 AWG STR, #2 AWG SOL | B, C, Compact | 1-5/16                  |
| <b>RSC1/0-6</b>     | 1/0 AWG                     | B, C, Compact | 1                       | #6 AWG                      | B, C, Compact | 1-5/16                  |
| <b>RSC1/0-4</b>     | 1/0 AWG                     | B, C, Compact | 1                       | #4 – #3 AWG STR, #2 AWG SOL | B, C, Compact | 1-5/16                  |
| <b>RSC2/0-6</b>     | 2/0 AWG                     | B, C, Compact | 1-1/16                  | #6 AWG                      | B, C, Compact | 1-5/16                  |
| <b>RSC2/0-4</b>     | 2/0 AWG                     | B, C, Compact | 1-1/16                  | #4 – #3 AWG STR, #2 AWG SOL | B, C, Compact | 1-5/16                  |
| <b>RSC4/0-6</b>     | 4/0 AWG                     | B, C, Compact | 1-1/16                  | #6 AWG                      | B, C, Compact | 1-5/16                  |
| <b>RSC4/0-4</b>     | 4/0 AWG                     | B, C, Compact | 1-1/16                  | #4 – #3 AWG STR, #2 AWG SOL | B, C, Compact | 1-5/16                  |
| <b>RSC4/0-1/0</b>   | 4/0 AWG                     | B, C, Compact | 1-1/16                  | 1/0 AWG                     | B, C, Compact | 1-9/16                  |
| <b>RSC4/0-2/0</b>   | 4/0 AWG                     | B, C, Compact | 1-1/16                  | 2/0 AWG                     | B, C, Compact | 1-7/16                  |
| <b>RSC500-X4/0</b>  | 500 kcmil                   | B, C, Compact | 1-7/8                   | 4/0 AWG                     | I             | 1-7/16                  |
| <b>RSC500-X350</b>  | 500 kcmil                   | B, C, Compact | 1-7/8                   | 350 kcmil                   | I             | 1-7/8                   |
| <b>RSC750-4/0</b>   | 750 kcmil                   | B, C, Compact | 2                       | 4/0 AWG                     | B, C, Compact | 1-5/8                   |
| <b>RSC750-X4/0</b>  | 750 kcmil                   | B, C, Compact | 2                       | 4/0 AWG                     | I             | 1-7/16                  |
| <b>RSC750-X350</b>  | 750 kcmil                   | B, C, Compact | 2                       | 350 kcmil                   | I             | 1-7/8                   |
| <b>RSC750-500</b>   | 750 kcmil                   | B, C, Compact | 2                       | 500 kcmil                   | B, C, Compact | 1-7/8                   |
| <b>RSC750-X500</b>  | 750 kcmil                   | B, C, Compact | 2                       | 500 kcmil                   | I             | 2                       |
| <b>RSC750-750</b>   | 750 kcmil                   | B, C, Compact | 2                       | 750 kcmil                   | B, C, Compact | 2                       |
| <b>RSCX750-4/0</b>  | 750 kcmil                   | I             | 2                       | 4/0 AWG                     | B, C, Compact | 1-5/8                   |
| <b>RSCX750-750</b>  | 750 kcmil                   | I             | 2                       | 750 kcmil                   | B, C, Compact | 2                       |



For use with  
Copper  
Conductors

## Installation Tooling and Die Selections for: Type RSC In-Line Reducing Splice (continued)

| Panduit (See Compression Connector Tools Selection Guide, Pages D3.34–D3.36) |              |                         |                         |   |                            |   |  |
|--|--------------|-------------------------|-------------------------|---|----------------------------|---|--|
| CT-1700 <sup>①</sup>   |              | CT-720                  |                         | CT-2001,<br>CT-2001/L, CT-2001/LE,<br>CT-2002, CT-2002/L,<br>CT-3001, CT-3001/E |                            | CT-930 <sup>⑤</sup> , CT-930CH <sup>⑤</sup> , CT-920 <sup>⑥</sup> ,<br>CT-920CH <sup>⑥</sup> , CT-2920 <sup>⑥</sup> ,<br>CT-2940 <sup>③</sup> , CT-2940/L <sup>③</sup> , CT-2940/LE <sup>③</sup> ,<br>CT-940CH <sup>③</sup> , CT-2930 <sup>⑤</sup> ,<br>CT-2930/L, CT-2930/LE <sup>⑤</sup> , CT-2931 <sup>⑤</sup> |  |
| Reducing From  | Reducing To  | Reducing From           | Reducing To             | Reducing From   | Reducing To                | Reducing From   | Reducing To                            |
| Die Part Number/Color Code and Die Index Number/<br>(Number Of Crimps)       |              |                         |                         |   |                            |   |  |
| Gray P29 (2)   | Blue P24 (2) | CD-720-1 Gray P29 (1)   | CD-720-1 Blue P24 (1)   | CD-2001-4 Gray P29 (1)  | CD-2001-6 Blue P24 (1)     | CD-920-4 Gray P29 (1)   | CD-920-6 Blue P24 (1)                  |
| Brown P33 (2)  | Blue P24 (2) | CD-720-1 Brown P33 (1)  | CD-720-1 Blue P24 (1)   | CD-2001-2 Brown P33 (1)   | CD-2001-6 Blue P24 (1)     | CD-920-2 Brown P33 (1)  | CD-920-6 Blue P24 (1)                  |
| Brown P33 (2)  | Gray P29 (2) | CD-720-1 Brown P33 (1)  | CD-720-1 Gray P29 (1)   | CD-2001-2 Brown P33 (1)   | CD-2001-4 Gray P29 (1)     | CD-920-2 Brown P33 (1)  | CD-920-4 Gray P29 (1)                  |
| —  | —            | CD-720-2 Pink P42 (1)   | CD-720-1 Blue P24 (1)   | CD-2001-1/0 Pink P42 (1)  | CD-2001-6 Blue P24 (1)     | CD-920-1/0 Pink P42 (1)   | CD-920-6 Blue P24 (1)                  |
| —  | —            | CD-720-2 Pink P42 (1)   | CD-720-1 Gray P29 (1)   | CD-2001-1/0 Pink P42 (1)  | CD-2001-4 Gray P29 (1)     | CD-920-1/0 Pink P42 (1)   | CD-920-4 Gray P29 (1)                  |
| —  | —            | CD-720-2 Black P45 (2)  | CD-720-1 Blue P24 (1)   | CD-2001-2/0 Black P45 (2)   | CD-2001-6 Blue P24 (1)     | CD-920-2/0 Black P45 (1)  | CD-920-6 Blue P24 (1)                  |
| —  | —            | CD-720-2 Black P45 (2)  | CD-720-1 Gray P29 (1)   | CD-2001-2/0 Black P45 (2)   | CD-2001-4 Gray P29 (1)     | CD-920-2/0 Black P45 (1)  | CD-920-4 Gray P29 (1)                  |
| —  | —            | CD-720-3 Purple P54 (2) | CD-720-1 Blue P24 (1)   | CD-2001-4/0 Purple P54 (2)  | CD-2001-6 Blue P24 (1)     | CD-920-4/0 Purple P54 (1)   | CD-920-6 Blue P24 (1)                  |
| —  | —            | CD-720-3 Purple P54 (2) | CD-720-1 Gray P29 (1)   | CD-2001-4/0 Purple P54 (2)  | CD-2001-4 Gray P29 (1)     | CD-920-4/0 Purple P54 (1)   | CD-920-4 Gray P29 (1)                  |
| —  | —            | CD-720-3 Purple P54 (2) | CD-720-2 Pink P42 (2)   | CD-2001-4/0 Purple P54 (2)  | CD-2001-1/0 Pink P42 (2)   | CD-920-4/0 Purple P54 (1)   | CD-920-1/0 Pink P42 (2)                |
| —  | —            | CD-720-3 Purple P54 (2) | CD-720-2 Black P45 (2)  | CD-2001-4/0 Purple P54 (2)  | CD-2001-2/0 Black P45 (2)  | CD-920-4/0 Purple P54 (1)   | CD-920-2/0 Black P45 (2)               |
| —  | —            | CD-720-7 Brown P87 (2)  | CD-720-3 Yellow P62 (2) | CD-2001-500 Brown P87 (3)   | CD-2001-250 Yellow P62 (2) | CD-920-500 Brown P87 (2)  | CD-920-250 Yellow P62 (2)              |
| —  | —            | CD-720-7 Brown P87 (2)  | CD-720-6 Blue P76 (2)   | CD-2001-500 Brown P87 (3)   | CD-2001-400 Blue P76 (3)   | CD-920-500 Brown P87 (2)  | CD-920-400 Blue P76 (2)                |
| —  | —            | —                       | —                       | —   | —                          | CD-920-750, CD-940-750 <sup>④</sup> Black P106 (2)  | CD-920-4/0 Purple P54 (1)              |
| —  | —            | —                       | —                       | —   | —                          | CD-920-750, CD-940-750 <sup>④</sup> Black P106 (2)  | CD-920-250 Yellow P62 (1)              |
| —  | —            | —                       | —                       | —   | —                          | CD-920-750, CD-940-750 <sup>④</sup> Black P106 (2)  | CD-920-400 Blue P76 (2)                |
| —  | —            | —                       | —                       | —   | —                          | CD-920-750, CD-940-750 <sup>④</sup> Black P106 (2)  | CD-920-500 Brown P87 (2)               |
| —  | —            | —                       | —                       | —   | —                          | CD-920-750, CD-940-750 <sup>④</sup> Black P106 (2)  | CD-920-500A Pink P99 (2)               |
| —  | —            | —                       | —                       | —   | —                          | CD-920-750, CD-940-750 <sup>④</sup> Black P106 (2)  | CD-920-750, CD-940-750 Black P106 (2)  |
| —  | —            | —                       | —                       | —   | —                          | CD-940-750X <sup>④</sup> Yellow P115 (2)  | CD-920-4/0 Purple P54 (1)              |
| —  | —            | —                       | —                       | —   | —                          | CD-940-750X <sup>④</sup> Yellow P115 (2)  | CD-940-750 <sup>④</sup> Black P106 (2) |

①The CT-1700 crimp die pockets are integrated into the tool frame.  
 ②CD-920 dies can be used with CT-940CH and CT-2940 tools with CD-940-DA adapter.  
 ③CD-940 dies to be used with CT-940CH and CT-2940 tools.  
 ④Maximum conductor size: 500 kcmil class I and 750 kcmil class I, B, C, Compact.  
 ⑤Maximum conductor size: 250 kcmil class I and 400 kcmil class I, B, C, Compact.

For Burndy tooling, see pages D3.78 – D3.79  
 For Thomas and Betts tooling, see pages D3.80 – D3.81

A.  
System  
Overview

B1.  
Cable Ties

B2.  
Cable  
Accessories

B3.  
Stainless  
Steel Ties

C1.  
Wiring  
Duct

C2.  
Surface  
Raceway

C3.  
Abrasion  
Protection

C4.  
Cable  
Management

D1.  
Terminals

D2.  
Power  
Connectors

D3.  
Grounding  
Connectors

E1.  
Labeling  
Systems

E2.  
Labels

E3.  
Pre-Printed  
& Write-On  
Markers

E4.  
Permanent  
Identification

E5.  
Lockout/  
Tagout  
& Safety  
Solutions

F.  
Index

A.  
System  
Overview

B1.  
Cable Ties

B2.  
Cable  
Accessories

B3.  
Stainless  
Steel Ties

C1.  
Wiring  
Duct

C2.  
Surface  
Raceway

C3.  
Abrasion  
Protection

C4.  
Cable  
Management

D1.  
Terminals

D2.  
Power  
Connectors

D3.  
Grounding  
Connectors

E1.  
Labeling  
Systems

E2.  
Labels

E3.  
Pre-Printed  
& Write-On  
Markers

E4.  
Permanent  
Identification

E5.  
Lockout/  
Tagout  
& Safety  
Solutions

F.  
Index

**For use with  
Copper  
Conductors**

## Installation Tooling and Die Selections for: Type RSC In-Line Reducing Splice (continued)

| Panduit Part Number | Reducing From                  |               |                         | Reducing To                    |               |                         |
|---------------------|--------------------------------|---------------|-------------------------|--------------------------------|---------------|-------------------------|
|                     | Standard Wire Size             | Cable Classes | Wire Strip Length (In.) | Standard Wire Size             | Cable Classes | Wire Strip Length (In.) |
| RSC4-6              | #4 – #3 AWG STR,<br>#2 AWG SOL | B, C, Compact | 1                       | #6 AWG                         | B, C, Compact | 1-5/16                  |
| RSC2-6              | #2 AWG                         | B, C, Compact | 1                       | #6 AWG                         | B, C, Compact | 1-5/16                  |
| RSC2-4              | #2 AWG                         | B, C, Compact | 1                       | #4 – #3 AWG STR,<br>#2 AWG SOL | B, C, Compact | 1-5/16                  |
| RSC1/0-6            | 1/0 AWG                        | B, C, Compact | 1                       | #6 AWG                         | B, C, Compact | 1-5/16                  |
| RSC1/0-4            | 1/0 AWG                        | B, C, Compact | 1                       | #4 – #3 AWG STR,<br>#2 AWG SOL | B, C, Compact | 1-5/16                  |
| RSC2/0-6            | 2/0 AWG                        | B, C, Compact | 1-1/16                  | #6 AWG                         | B, C, Compact | 1-5/16                  |
| RSC2/0-4            | 2/0 AWG                        | B, C, Compact | 1-1/16                  | #4 – #3 AWG STR,<br>#2 AWG SOL | B, C, Compact | 1-5/16                  |
| RSC4/0-6            | 4/0 AWG                        | B, C, Compact | 1-1/16                  | #6 AWG                         | B, C, Compact | 1-5/16                  |
| RSC4/0-4            | 4/0 AWG                        | B, C, Compact | 1-1/16                  | #4 – #3 AWG STR,<br>#2 AWG SOL | B, C, Compact | 1-5/16                  |
| RSC4/0-1/0          | 4/0 AWG                        | B, C, Compact | 1-1/16                  | 1/0 AWG                        | B, C, Compact | 1-9/16                  |
| RSC4/0-2/0          | 4/0 AWG                        | B, C, Compact | 1-1/16                  | 2/0 AWG                        | B, C, Compact | 1-7/16                  |
| RSC500-X4/0         | 500 kcmil                      | B, C, Compact | 1-7/8                   | 4/0 AWG                        | I             | 1-7/16                  |
| RSC500-X350         | 500 kcmil                      | B, C, Compact | 1-7/8                   | 350 kcmil                      | I             | 1-7/8                   |
| RSC750-4/0          | 750 kcmil                      | B, C, Compact | 2                       | 4/0 AWG                        | B, C, Compact | 1-5/8                   |
| RSC750-X4/0         | 750 kcmil                      | B, C, Compact | 2                       | 4/0 AWG                        | I             | 1-7/16                  |
| RSC750-X350         | 750 kcmil                      | B, C, Compact | 2                       | 350 kcmil                      | I             | 1-7/8                   |
| RSC750-500          | 750 kcmil                      | B, C, Compact | 2                       | 500 kcmil                      | B, C, Compact | 1-7/8                   |
| RSC750-X500         | 750 kcmil                      | B, C, Compact | 2                       | 500 kcmil                      | I             | 2                       |
| RSC750-750          | 750 kcmil                      | B, C, Compact | 2                       | 750 kcmil                      | B, C, Compact | 2                       |
| RSCX750-4/0         | 750 kcmil                      | I             | 2                       | 4/0 AWG                        | B, C, Compact | 1-5/8                   |
| RSCX750-750         | 750 kcmil                      | I             | 2                       | 750 kcmil                      | B, C, Compact | 2                       |

For use with  
Copper  
Conductors

## Installation Tooling and Die Selections for: Type RSC In-Line Reducing Splice (continued)

| Burndy   |                |                  |                |  |                        |
|--|----------------|------------------|----------------|--|------------------------|
| Y1MR,<br>Y2MR  |                | Y1MRTC           |                | Y35, Y35BH, Y39, Y39BH,<br>Y45, Y46, Y750, Y750HS,<br>Y750-2, Y750BH-2, BAT35,<br>BAT750, PAT644, PAT750 |                        |
| Reducing<br>From   | Reducing<br>To | Reducing<br>From | Reducing<br>To | Reducing<br>From   | Reducing<br>To         |
| Die Part Number/Color Code and Die Index Number/<br>(Number of Crimps) |                |                  |                |  |                        |
| Gray (2)   | Blue (3)       | White (2)        | Blue (3)       | U4CR<br>Gray 8 (1)   | U5CRT<br>Blue 7 (1)    |
| Brown (2)  | Blue (3)       | Brown (2)        | Blue (3)       | U2CRT<br>Brown 10 (1)  | U5CRT<br>Blue 7 (1)    |
| Brown (2)  | Gray (3)       | Brown (2)        | White (3)      | U2CRT<br>Brown 10 (1)  | U4CRT<br>Gray 8 (1)    |
| —  | —              | —                | —              | U25RT<br>Pink 12 (1)   | U5CRT<br>Blue 7 (1)    |
| —  | —              | —                | —              | U25RT<br>Pink 12 (1)   | U4CRT<br>Gray 8 (1)    |
| —  | —              | —                | —              | U26RT<br>Black 13 (1)  | U5CRT<br>Blue 7 (1)    |
| —  | —              | —                | —              | U26RT<br>Black 13 (1)  | U4CRT<br>Gray 8 (1)    |
| —  | —              | —                | —              | U28RT<br>Purple 15 (1)   | U5CRT<br>Blue 7 (1)    |
| —  | —              | —                | —              | U28RT<br>Purple 15 (1)   | U4CRT<br>Gray 8 (1)    |
| —  | —              | —                | —              | U28RT<br>Purple 15 (1)   | U25RT<br>Pink 12 (2)   |
| —  | —              | —                | —              | U28RT<br>Purple 15 (1)   | U26RT<br>Black 13 (1)  |
| —  | —              | —                | —              | U34RT<br>Brown 20 (2)  | U29RT<br>Yellow 16 (1) |
| —  | —              | —                | —              | U34RT<br>Brown 20 (2)  | U32RT<br>Blue 19 (2)   |
| —  | —              | —                | —              | U39RT<br>Black 24 (3)  | U28RT<br>Purple 15 (1) |
| —  | —              | —                | —              | U39RT<br>Black 24 (3)  | U29RT<br>Yellow 16 (1) |
| —  | —              | —                | —              | U39RT<br>Black 24 (3)  | U32RT<br>Blue 19 (2)   |
| —  | —              | —                | —              | U39RT<br>Black 24 (3)  | U34RT<br>Brown 20 (2)  |
| —  | —              | —                | —              | U39RT<br>Black 24 (3)  | U38XRT<br>Pink L99 (3) |
| —  | —              | —                | —              | U39RT<br>Black 24 (3)  | U39RT<br>Black 24 (3)  |
| —  | —              | —                | —              | —  | —                      |
| —  | —              | —                | —              | —  | —                      |

For Panduit tooling, see pages D3.76 – D3.77  
For Thomas and Betts tooling, see pages D3.80 – D3.81

A.  
System  
Overview

B1.  
Cable Ties

B2.  
Cable  
Accessories

B3.  
Stainless  
Steel Ties

C1.  
Wiring  
Duct

C2.  
Surface  
Raceway

C3.  
Abrasion  
Protection

C4.  
Cable  
Management

D1.  
Terminals

D2.  
Power  
Connectors

D3.  
Grounding  
Connectors

E1.  
Labeling  
Systems

E2.  
Labels

E3.  
Pre-Printed  
& Write-On  
Markers

E4.  
Permanent  
Identification

E5.  
Lockout/  
Tagout  
& Safety  
Solutions

F.  
Index

A.  
System  
Overview

B1.  
Cable Ties

B2.  
Cable  
Accessories

B3.  
Stainless  
Steel Ties

C1.  
Wiring  
Duct

C2.  
Surface  
Raceway

C3.  
Abrasion  
Protection

C4.  
Cable  
Management

D1.  
Terminals

D2.  
Power  
Connectors

D3.  
Grounding  
Connectors

E1.  
Labeling  
Systems

E2.  
Labels

E3.  
Pre-Printed  
& Write-On  
Markers

E4.  
Permanent  
Identification

E5.  
Lockout/  
Tagout  
& Safety  
Solutions

F.  
Index

**For use with  
Copper  
Conductors**

## Installation Tooling and Die Selections for: Type RSC In-Line Reducing Splice (continued)

| Panduit Part Number | Reducing From                   |               |                   | Reducing To          |               |                   |
|---------------------|---------------------------------|---------------|-------------------|----------------------|---------------|-------------------|
|                     | Standard Wire Size              | Cable Classes | Wire Strip Length | Standard Wire Size   | Cable Classes | Wire Strip Length |
| RSC4-6              | #4 – #3 AWG STR<br>#2 AWG Solid | B, C, Compact | 1                 | 6 AWG                | B, C, Compact | 1-5/16            |
| RSC2-6              | #2 AWG                          | B, C, Compact | 1                 | 6 AWG                | B, C, Compact | 1-5/16            |
| RSC2-4              | #2 AWG                          | B, C, Compact | 1                 | 4-3 AWG<br>2 Solid   | B, C, Compact | 1-5/16            |
| RSC1/0-6            | 1/0 AWG                         | B, C, Compact | 1                 | 6 AWG                | B, C, Compact | 1-5/16            |
| RSC1/0-4            | 1/0 AWG                         | B, C, Compact | 1                 | 4 – 3 AWG<br>2 Solid | B, C, Compact | 1-5/16            |
| RSC2/0-6            | 2/0 AWG                         | B, C, Compact | 1-1/16            | 6 AWG                | B, C, Compact | 1-5/16            |
| RSC2/0-4            | 2/0 AWG                         | B, C, Compact | 1-1/16            | 4 – 3 AWG<br>2 Solid | B, C, Compact | 1-5/16            |
| RSC4/0-6            | 4/0 AWG                         | B, C, Compact | 1-1/16            | 6 AWG                | B, C, Compact | 1-5/16            |
| RSC4/0-4            | 4/0 AWG                         | B, C, Compact | 1-1/16            | 4 – 3 AWG<br>2 Solid | B, C, Compact | 1-5/16            |
| RSC4/0-1/0          | 4/0 AWG                         | B, C, Compact | 1-1/16            | 1/0 AWG              | B, C, Compact | 1-9/16            |
| RSC4/0-2/0          | 4/0 AWG                         | B, C, Compact | 1-1/16            | 2/0 AWG              | B, C, Compact | 1-7/16            |
| RSC500-X4/0         | 500 kcmil                       | B, C, Compact | 1-7/8             | 4/0 AWG              | I             | 1-7/16            |
| RSC500-X350         | 500 kcmil                       | B, C, Compact | 1-7/8             | 350 kcmil            | I             | 1-7/8             |
| RSC750-4/0          | 750 kcmil                       | B, C, Compact | 2                 | 4/0 AWG              | B, C, Compact | 1-5/8             |
| RSC750-X4/0         | 750 kcmil                       | B, C, Compact | 2                 | 4/0 AWG              | I             | 1-7/16            |
| RSC750-X350         | 750 kcmil                       | B, C, Compact | 2                 | 350 AWG              | I             | 1-7/8             |
| RSC750-500          | 750 kcmil                       | B, C, Compact | 2                 | 500 kcmil            | B, C, Compact | 1-7/8             |
| RSC750-X500         | 750 kcmil                       | B, C, Compact | 2                 | 500 kcmil            | I             | 2                 |
| RSC750-750          | 750 kcmil                       | B, C, Compact | 2                 | 750 kcmil            | B, C, Compact | 2                 |
| RSCX750-4/0         | 750 kcmil                       | I             | 2                 | 4/0 AWG              | B, C, Compact | 1-5/8             |
| RSCX750-750         | 750 kcmil                       | I             | 2                 | 750 kcmil            | B, C, Compact | 2                 |

For use with  
Copper  
Conductors

## Installation Tooling and Die Selections for: Type RSC In-Line Reducing Splice (continued)

| Thomas & Betts                                     |                |                     |                |                                    |                                    |  |                             |
|--|----------------|---------------------|----------------|------------------------------------|------------------------------------|--|-----------------------------|
| TBM20S,<br>TBM25S                                  |                | TBM5,<br>TBM6, TBM8 |                | TBM12,<br>13642M                   |                                    | TBM14BSCR,<br>BPLT14BSCR,<br>13100A,<br>TBM14M |                             |
| Reducing<br>From                                   | Reducing<br>To | Reducing<br>From    | Reducing<br>To | Reducing<br>From                   | Reducing<br>To                     | Reducing<br>From                               | Reducing<br>To              |
| Color Code/Die Index Number/<br>(Number of Crimps) |                |                     |                |                                    |                                    |  |                             |
| Gray 29 (2)  | Blue 24 (3)    | Gray 29 (1)         | Blue 24 (1)    | Gray 29 (1)                        | Blue 24 (1)                        | Gray 29 (1)                                    | Blue 24 (1)                 |
| Brown 33 (2)                                       | Blue 24 (3)    | Brown 33 (1)        | Blue 24 (1)    | Brown 33 (1)                       | Blue 24 (1)                        | Brown 33 (1)                                   | Blue 24 (1)                 |
| Brown 33 (2)                                       | Gray 29 (3)    | Brown 33 (1)        | Gray 29 (1)    | Brown 33 (1)                       | Gray 29 (1)                        | Brown 33 (1)                                   | Gray 29 (1)                 |
| —  | —              | Pink 42 (1)         | Blue 24 (1)    | Pink 42 (1)                        | Blue 24 (1)                        | Pink 42H <sup>®</sup> (2)                      | Blue 24 (1)                 |
| —  | —              | Pink 42 (1)         | Gray 29 (1)    | Pink 42 (1)                        | Gray 29 (1)                        | Pink 42H <sup>®</sup> (2)                      | Gray 29 (1)                 |
| —  | —              | Black 45 (2)        | Blue 24(1)     | Black/Gold 45 (1)                  | Blue 24 (1)                        | Black 45 (1)                                   | Blue 24 (1)                 |
| —  | —              | Black 45 (2)        | Gray 29 (1)    | Black/Gold 45 (1)                  | Gray 29 (1)                        | Black 45 (1)                                   | Gray 29 (1)                 |
| —  | —              | Purple 54 (2)       | Blue 24 (1)    | Purple/Olive 54 (1)                | Blue 24 (1)                        | Olive 54H <sup>®</sup> (2)                     | Blue 24 (1)                 |
| —  | —              | Purple 54 (2)       | Gray 29 (1)    | Purple/Olive 54 (1)                | Gray 29 (1)                        | Olive 54H <sup>®</sup> (2)                     | Gray 29 (1)                 |
| —  | —              | Purple 54 (2)       | Pink 42 (2)    | Purple/Olive 54 (1)                | Pink 42 (2)                        | Olive 54H <sup>®</sup> (2)                     | Pink 42H <sup>®</sup> (4)   |
| —  | —              | Purple 54 (2)       | Black 45 (2)   | Purple/Olive 54 (1)                | Black/Gold 45 (1)                  | Olive 54H <sup>®</sup> (2)                     | Black 45 (1)                |
| —  | —              | —                   | —              | Brown 87H <sup>®</sup> (2)         | Yellow 62 (1)                      | Brown 87H <sup>®</sup> (2)                     | Yellow 62 (1)               |
| —  | —              | —                   | —              | Brown 87H <sup>®</sup> (2)         | Blue 76H <sup>®</sup> (2)          | Brown 87H <sup>®</sup> (2)                     | Blue 76 (1)                 |
| —  | —              | —                   | —              | Black/Orange 106H <sup>®</sup> (2) | Purple/Olive 54 (1)                | Black 106H <sup>®</sup> (2)                    | Olive 54H <sup>®</sup> (2)  |
| —  | —              | —                   | —              | Black/Orange 106H <sup>®</sup> (2) | Yellow 62 (1)                      | Black 106H <sup>®</sup> (2)                    | Yellow 62 (1)               |
| —  | —              | —                   | —              | Black/Orange 106H <sup>®</sup> (2) | Blue 76H <sup>®</sup> (2)          | Black 106H <sup>®</sup> (2)                    | Blue 76 (1)                 |
| —  | —              | —                   | —              | Black/Orange 106H <sup>®</sup> (2) | Brown 87H <sup>®</sup> (2)         | Black 106H <sup>®</sup> (2)                    | Brown 87H <sup>®</sup> (2)  |
| —  | —              | —                   | —              | Black/Orange 106H <sup>®</sup> (2) | Pink 99H (2)                       | Black 106H <sup>®</sup> (2)                    | Pink 99H (2)                |
| —  | —              | —                   | —              | Black/Orange 106H <sup>®</sup> (2) | Black/Orange 106H <sup>®</sup> (2) | Black 106H <sup>®</sup> (2)                    | Black 106H <sup>®</sup> (2) |
| —  | —              | —                   | —              | —                                  | —                                  | —  | —                           |
| —  | —              | —                   | —              | —                                  | —                                  | —  | —                           |

®Half width dies.

For Panduit tooling, see pages D3.76 – D3.77  
For Burndy tooling, see pages D3.78 – D3.79

A.  
System  
Overview

B1.  
Cable Ties

B2.  
Cable  
Accessories

B3.  
Stainless  
Steel Ties

C1.  
Wiring  
Duct

C2.  
Surface  
Raceway

C3.  
Abrasion  
Protection

C4.  
Cable  
Management

D1.  
Terminals

D2.  
Power  
Connectors

D3.  
Grounding  
Connectors

E1.  
Labeling  
Systems

E2.  
Labels

E3.  
Pre-Printed  
& Write-On  
Markers

E4.  
Permanent  
Identification

E5.  
Lockout/  
Tagout  
& Safety  
Solutions

F.  
Index

A. System Overview

B1. Cable Ties

B2. Cable Accessories

B3. Stainless Steel Ties

C1. Wiring Duct

C2. Surface Raceway

C3. Abrasion Protection

C4. Cable Management

D1. Terminals

D2. Power Connectors

D3. Grounding Connectors

E1. Labeling Systems

E2. Labels

E3. Pre-Printed & Write-On Markers

E4. Permanent Identification

E5. Lockout/Tagout & Safety Solutions

F. Index

**For use with Copper Conductors**

## Installation Tooling and Die Selections for: Type PSC

### How to read this chart

For PSCBRN-L parallel splice and CT-2001 crimping tool:

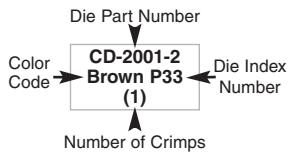

### Panduit Crimping Tool Part Number (See Compression Connector Tools Selection Guide, pages D3.34 – D3.36)

| Panduit Splice Part Number | Wire Strip Length (In.) | Uni-Die™ Dieless<br>CT-980, CT-980CH, CT-2950,<br>CT-2980, CT-2980/L,<br>CT-2980/LE, CT-2981 | CT-2001,<br>CT-2001/L, CT-2001/LE,<br>CT-2002, CT-2002/L,<br>CT-3001, CT-3001/E | CT-920, CT-930, CT-2940*, CT-2940/L*,<br>CT-2940/LE*, CT-920CH, CT-930CH,<br>CT-940CH*, CT-2920, CT-2930,<br>CT-2930/L, CT-2930/LE, CT-2931 |
|----------------------------|-------------------------|--|---|---|
|                            |                         | Die Part Number/Color Code and Die Index Number/(Number of Crimps)                           |   |   |
| PSCRED-L                   | 7/16                    | —  | CD-2001-8<br>Red P21<br>(1)   | CD-920-8<br>Red P21<br>(1)  |
| PSCBLU-L                   | 7/16                    | —  | CD-2001-6<br>Blue P24<br>(1)  | CD-920-6<br>Blue P24<br>(1)   |
| PSCGRY-L                   | 7/16                    | (1)  | CD-2001-4<br>Gray P29<br>(1)  | CD-920-4<br>Gray P29<br>(1)   |
| PSCBRN-L                   | 11/16                   | (1)  | CD-2001-2<br>Brown P33<br>(1)   | CD-920-2<br>Brown P33<br>(1)  |
| PSCGRN-L                   | 11/16                   | (1)  | CD-2001-1<br>Green P37<br>(1)   | CD-920-1<br>Green P37<br>(1)  |
| PSCPNK-L                   | 11/16                   | (1)  | CD-2001-1/0<br>Pink P42<br>(1)  | CD-920-1/0<br>Pink P42<br>(1)   |
| PSCBLK-Q                   | 7/8                     | (1)  | CD-2001-2/0<br>Black P45<br>(1)   | CD-920-2/0<br>Black P45<br>(1)  |
| PSCORG-Q                   | 7/8                     | (1)  | CD-2001-3/0<br>Orange P50<br>(1)  | CD-920-3/0<br>Orange P50<br>(1)   |
| PSCPUR-Q                   | 1                       | (1)  | CD-2001-4/0<br>Purple P54<br>(1)  | CD-920-4/0<br>Purple P54<br>(1)   |
| PSCYEL-Q                   | 1 1/16                  | (1)  | CD-2001-250<br>Yellow P62<br>(1)  | CD-920-250<br>Yellow P62<br>(1)   |

\*CD-920 dies can be used with CT-940CH and CT-2940 tools with the CD-940-DA die adapter.



For use with  
Copper  
Conductors

## Installation Tooling and Die Selections for: Types LCMA, LCMD, and SCMS

### How to read this chart

For LCMA16  
lug and CT-2001  
crimping tool:

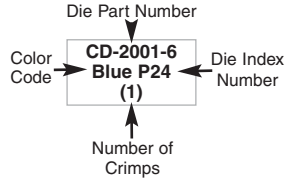

| Panduit Tool P/N   |   |
|--|---|
| Die Part Number/Color Code and Die Index Number (Number of Crimps)     |   |
| CT-2001, CT-2001/L, CT-2001/LE, CT-2002, CT-2002/L, CT-3001, CT-3001/E | CT-930LPCH***, CT-920, CT-920CH, CT-2931, CT-2920, CT-930, CT-930CH, CT-2930, CT-2930/L, CT-2930/LE, CT-940CH*, CT-2940*, CT-2940/L*, CT-2940/LE* |
| —  | —   |
| CD-2001-8 Red P21 (1)  | CD-920-8 Red P21 (1)  |
| CD-2001-6 Blue P24 (1)   | CD-920-6 Blue P24 (1)   |
| CD-2001-4 Gray P29 (1)   | CD-920-4 Gray P29 (1)   |
| CD-2001-4 Gray P29 (1)   | CD-920-4 Gray P29 (1)   |
| CD-2001-1 Green P37 (1)  | CD-920-1 Green P37 (1)  |
| CD-2001-2/0 Black P45 (2)  | CD-920-2/0 Black P45 (2)  |
| CD-2001-4/0 Purple P54 (2)   | CD-920-4/0 Purple P54 (2)   |
| CD-2001-250 Yellow P62 (2)   | CD-920-250 Yellow P62 (2)   |
| CD-2001-300 White P66 (2)  | CD-920-300 White P66 (2)  |
| CD-2001-400 Blue P76 (2)   | CD-920-400 Blue P76 (2)   |
| CD-2001-500 Brown P87 (2)  | CD-920-500 Brown P87 (2)  |
| —  | CD-920-600 Green P94 (2)  |
| —  | CD-920-750 CD-940-750** Black P106(2)   |
| —  | CD-940-1000** White P125 (3)  |
| —  | CD-940-1000** White P125 (4)  |

| Panduit Part Number       | Wire Size          | Wire Type | Wire Strip Length (mm) | Current Rating | CT-100, CT-200, CT-1570 (Manual) | CT-600 (Air)       | CT-1701 (Manual) |
|---------------------------|--------------------|-----------|------------------------|----------------|----------------------------------|--------------------|------------------|
| LCMA6, LCMD6              | 4-6mm <sup>2</sup> | Class 2R  | 11.0<br>11.0           | 30A            | 22-10 (1)                        | CT-570CH 12-10 (1) | P10 (1)          |
| LCMA10, LCMD10, SCMS10    | 10mm <sup>2</sup>  | Class 2R  | 12.5<br>12.5<br>16.5   | —<br>—<br>50A  | —                                | —                  | —                |
| LCMA16, LCMD16, SCMS16    | 16mm <sup>2</sup>  | Class 2R  | 16.0<br>16.0<br>19.0   | 65A            | —                                | —                  | —                |
| LCMA25, LCMD25, SCMS25    | 25mm <sup>2</sup>  | Class 2R  | 16.5<br>16.5<br>19.5   | —              | —                                | —                  | —                |
| LCMA35, LCMD35, SCMS35    | 35mm <sup>2</sup>  | Class 2R  | 19.0<br>19.0<br>19.5   | —              | —                                | —                  | —                |
| LCMA50, LCMD50, SCMS50    | 50mm <sup>2</sup>  | Class 2R  | 21.8<br>21.8<br>26.0   | —              | —                                | —                  | —                |
| LCMA70, LCMD70, SCMS70    | 70mm <sup>2</sup>  | Class 2R  | 24.8<br>24.8<br>27.5   | —              | —                                | —                  | —                |
| LCMA95, LCMD95, SCMS95    | 95mm <sup>2</sup>  | Class 2R  | 26.0<br>26.0<br>28.5   | —              | —                                | —                  | —                |
| LCMA120, LCMD120, SCMS120 | 120mm <sup>2</sup> | Class 2R  | 26.0<br>26.0<br>30.0   | —              | —                                | —                  | —                |
| LCMA150, LCMD150, SCMS150 | 150mm <sup>2</sup> | Class 2R  | 29.0<br>29.0<br>30.0   | —              | —                                | —                  | —                |
| LCMA185, LCMD185, SCMS185 | 185mm <sup>2</sup> | Class 2R  | 29.7<br>29.7<br>32.0   | —              | —                                | —                  | —                |
| LCMA240, LCMD240, SCMS240 | 240mm <sup>2</sup> | Class 2R  | 36.5<br>36.5<br>37.5   | —              | —                                | —                  | —                |
| LCMA300, LCMD300, SCMS300 | 300mm <sup>2</sup> | Class 2R  | 41.8<br>41.8<br>39.0   | —              | —                                | —                  | —                |
| LCMA400, LCMD400, SCMS400 | 400mm <sup>2</sup> | Class 2R  | 46.3<br>46.3<br>49.0   | —              | —                                | —                  | —                |
| LCMA500, LCMD500, SCMS500 | 500mm <sup>2</sup> | Class 2R  | 48.0<br>48.0<br>49.5   | —              | —                                | —                  | —                |
| LCMA630, LCMD630, SCMS630 | 630mm <sup>2</sup> | Class 2R  | 57.7<br>57.7<br>67.0   | —              | —                                | —                  | —                |

\*CD-920 dies can be used with CT-940CH and CT-2940 tools with CD-940-DA adapter.

\*\*CD-940 dies to be used exclusively with CT-940CH and CT-2940 tools.

\*\*\*Maximum size: 120mm lugs and splices.

A.  
System  
Overview

B1.  
Cable Ties

B2.  
Cable  
Accessories

B3.  
Stainless  
Steel Ties

C1.  
Wiring  
Duct

C2.  
Surface  
Raceway

C3.  
Abrasion  
Protection

C4.  
Cable  
Management

D1.  
Terminals

D2.  
Power  
Connectors

D3.  
Grounding  
Connectors

E1.  
Labeling  
Systems

E2.  
Labels

E3.  
Pre-Printed  
& Write-On  
Markers

E4.  
Permanent  
Identification

E5.  
Lockout/  
Tagout  
& Safety  
Solutions

F.  
Index

A. System Overview

B1. Cable Ties

B2. Cable Accessories

B3. Stainless Steel Ties

C1. Wiring Duct

C2. Surface Raceway

C3. Abrasion Protection

C4. Cable Management

D1. Terminals

D2. Power Connectors

D3. Grounding Connectors

E1. Labeling Systems

E2. Labels

E3. Pre-Printed & Write-On Markers

E4. Permanent Identification

E5. Lockout/Tagout & Safety Solutions

F. Index

**For use with Copper or Aluminum Conductors**

## Installation Tooling and Die Selections for: Types LAA, LAB, and SA

### How to read this chart

For LAA6 and CT-2931 crimping tool:

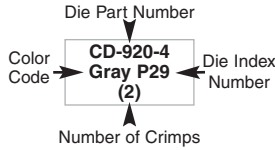

### Panduit (See Compression Connector Tools Selection Guide, Pages D3.34 – D3.36)

| Panduit Part Number<br>L = Lug<br>S = Splice                       | Std. Wire Size | Wire Strip Length (In.) | Panduit (See Compression Connector Tools Selection Guide, Pages D3.34 – D3.36) |                        |   |
|--|----------------|-------------------------|--|------------------------|---|
|  |                |                         | CT-1700 <sup>①</sup>   | CT-720                 | CT-930, CT-930CH, CT-920, CT-920CH, CT-2920, CT-2930, CT-2930/L, CT-2930/LE, CT-2931, CT-2940 <sup>②</sup> , CT-2940/L <sup>③</sup> , CT-2940/LE <sup>③</sup> , CT-940CH <sup>③</sup> |
| Die Part Number/Color Code and Die Index Number/(Number Of Crimps) |                |                         |  |                        |   |
| LAA6   | #6 AWG         | 1                       | Gray P29 (5)   | CD-720-1 Gray P29 (2)  | CD-920-4 Gray P29 (2)   |
| SA6  |                | 3/4                     |  |                        |   |
| LAA4   | #4 AWG         | 1-1/16                  | Green P37 (5)  | CD-720-2 Green P37 (2) | CD-920-1 Green P37 (2)  |
| SA4  |                | 7/8                     |  |                        |   |
| LAA2   | #2 AWG         | 1                       | —  | CD-720-2 Pink P42 (2)  | CD-920-1/0 Pink P42 (2)   |
| SA2  |                | 7/16                    |  |                        |   |
| LAA1   | #1 AWG         | 1                       | —  | CD-720-2 Gold P45 (3)  | CD-920-2/0 Gold P45 (2)   |
| SA1  |                | 7/16                    |  |                        |   |
| LAA1/0   | 1/0 AWG        | 1-9/16                  | —  | CD-720-2 Tan P50 (3)   | CD-920-3/0 Tan P50 (2)  |
| LAB1/0   |                |                         |  |                        |   |
| SA1/0  |                | 1                       |  |                        |   |
| LAA2/0   | 2/0 AWG        | 1-9/16                  | —  | CD-720-3 Olive P54 (3) | CD-920-4/0 Olive P54 (2)  |
| LAB2/0   |                |                         |  |                        |   |
| SA2/0  |                | 1-1/8                   |  |                        |   |
| LAA3/0   | 3/0 AWG        | 1-9/16                  | —  | CD-720-3 Ruby P60 (4)  | CD-920-250 Ruby P60 (2)   |
| LAB3/0   |                |                         |  |                        |   |
| SA3/0  |                | 1-1/4                   |  |                        |   |
| LAA4/0   | 4/0 AWG        | 1-3/4                   | —  | CD-720-4 White P66 (4) | CD-920-300 White P66 (2)  |
| LAB4/0   |                |                         |  |                        |   |
| SA4/0  |                | 1-5/16                  |  |                        |   |
| LAA250   | 250 kcmil      | 1-3/4                   | —  | CD-720-5 Red P71 (4)   | CD-920-350 Red P71 (2)  |
| LAB250   |                |                         |  |                        |   |
| SA250  |                | 1-7/16                  |  |                        |   |
| LAA300   | 300 kcmil      | 2-5/16                  | —  | CD-720-6 Blue P76 (4)  | CD-920-400 Blue P76 (2)   |
| LAB300   |                |                         |  |                        |   |
| SA300  |                | 1-1/2                   |  |                        |   |
| LAA350   | 350 kcmil      | 2-5/16                  | —  | CD-720-7 Brown P87 (4) | CD-920-500 Brown P87 (2)  |
| LAB350   |                |                         |  |                        |   |
| SA350  |                | 1-5/8                   |  |                        |   |
| LAA400   | 400 kcmil      | 2-9/16                  | —  | —                      | CD-920-600 Green P94 (4)  |
| LAB400   |                |                         |  |                        |   |
| SA400  |                | 1-13/16                 |  |                        |   |
| LAA500   | 500 kcmil      | 3-1/16                  | —  | —                      | CD-920-500A Pink P99 (4)  |
| LAB500   |                |                         |  |                        |   |
| SA500  |                | 1-7/8                   |  |                        |   |
| LAA600   | 600 kcmil      | 3-1/16                  | —  | —                      | CD-920-750, CD-940-750 <sup>④</sup> Black P106 (4)  |
| LAB600   |                |                         |  |                        |   |
| SA600  |                | 2                       |  |                        |   |
| LAA750   | 750 kcmil      | 3-7/16                  | —  | —                      | CD-940-750A <sup>④</sup> Red P125 (4)   |
| LAB750   |                |                         |  |                        |   |
| SA750  |                | 2-1/4                   |  |                        |   |
| LAA800   | 800 kcmil      | 3-7/16                  | —  | —                      | CD-940-800A <sup>④</sup> Gray P140 (4)  |
| LAB800   |                |                         |  |                        |   |
| SA800  |                | 2-5/16                  |  |                        |   |
| LAA1000  | 1000 kcmil     | 4-3/4                   | —  | —                      | CD-940-1000A <sup>④</sup> Brown P161 (4)  |
| LAB1000  |                |                         |  |                        |   |
| SA1000   |                | 2-9/16                  |  |                        |   |

①The CT-1700 crimp die pockets are integrated into the tool frame.

②CD-920 dies can be used with CT-940CH and CT-2940 tools with CD-940-DA die adapter. Maximum size splice is 250 kcmil with CT-920, CT-920CH, and CT-2920 tools.

③CD-940 dies to be used exclusively with CT-940CH and CT-2940 tools.

For use with  
Copper or  
Aluminum  
Conductors

## Installation Tooling and Die Selections for: Types LAA, LAB, and SA (continued)

| Panduit Part Number<br>L = Lug<br>S = Splice | Std. Wire Size | Wire Strip Length (In.) | Thomas & Betts   |          |                          | Burdny |                  |                  |                  | Anderson |
|--|----------------|-------------------------|--|----------|--------------------------|--------|------------------|------------------|------------------|----------|
|  |                |                         | TBM5   | TBM8     | TBM15, TBMISI, TBMISBSCR | MY29   | Y35              | Y39              | Y45, Y46         | VC8      |
|  |                |                         | Die Part Number/Color Code and Die Index Number/(Number of Crimps) |          |                          |        |                  |                  |                  |          |
| LAA6   | #6 AWG         | 1                       | Gray 29  | Gray 29  | Gray 29                  | 6AL    | U6CABT Gray 346  | U6CABT Gray 346  | U6CABT Gray 346  | STD      |
| SA6  |                | 3/4                     | (2)  | (2)      | (2)                      | (1)    | (1)              | (1)              | (1)              | (1)      |
| LAA4   | #4 AWG         | 1-1/16                  | Green 37   | Green 37 | Green 37                 | 4AL    | U4CABT Green 375 | U4CABT Green 375 | U4CABT Green 375 | STD      |
| SA4  |                | 7/8                     | (2)  | (2)      | (2)                      | (1)    | (1)              | (1)              | (1)              | (1)      |
| LAA2   | #2 AWG         | 1                       | Pink 42  | Pink 42  | Pink 42                  | 2AL    | U2CABT Pink 348  | U2CABT Pink 348  | U2CABT Pink 348  | STD      |
| SA2  |                | 7/16                    | (3)  | (3)      | (2)                      | (1)    | (2)              | (2)              | (2)              | (1)      |
| LAA1   | #1 AWG         | 1                       | Gold 45  | Gold 45  | Gold 45                  | 1AL    | U1CART Gold 471  | U1CART Gold 471  | U1CART Gold 471  | STD      |
| SA1  |                | 7/16                    | (3)  | (3)      | (2)                      | (1)    | (2)              | (2)              | (2)              | (1)      |
| LAA1/0                                       | 1/0 AWG        | 1-9/16                  | Tan 50   | Tan 50   | Tan 50                   | 1/0AL  | U25ART Tan 298   | U25ART Tan 298   | U25ART Tan 298   | STD      |
| LAB1/0                                       |                | 1                       | (3)  | (3)      | (2)                      | (1)    | (2)              | (2)              | (2)              | (2)      |
| SA1/0  |                |                         |  |          |                          |        |                  |                  |                  |          |
| LAA2/0                                       | 2/0 AWG        | 1-9/16                  | Olive 54   | Olive 54 | Olive 54                 | 2/0AL  | U26ART Olive 297 | U26ART Olive 297 | U26ART Olive 297 | STD      |
| LAB2/0                                       |                | 1-1/8                   | (3)  | (3)      | (3)                      | (2)    | (2)              | (2)              | (2)              | (2)      |
| SA2/0  |                |                         |  |          |                          |        |                  |                  |                  |          |
| LAA3/0                                       | 3/0 AWG        | 1-9/16                  | Ruby 60  | Ruby 60  | Ruby 60                  | 3/0AL  | U27ART Ruby 467  | U27ART Ruby 467  | U27ART Ruby 467  | STD      |
| LAB3/0                                       |                | 1-1/4                   | (4)  | (4)      | (2)                      | (2)    | (2)              | (2)              | (2)              | (2)      |
| SA3/0  |                |                         |  |          |                          |        |                  |                  |                  |          |
| LAA4/0                                       | 4/0 AWG        | 1-3/4                   | —  | White 66 | White 66                 | 4/0AL  | U28ART White 298 | U28ART White 298 | U28ART White 298 | STD      |
| LAB4/0                                       |                | 1-5/16                  |  |          | (4)                      | (2)    | (2)              | (2)              | (2)              | (2)      |
| SA4/0  |                |                         |  |          |                          |        |                  |                  |                  |          |
| LAA250                                       | 250 kcmil      | 1-3/4                   | —  | Red 71   | Red 71H <sup>®</sup>     | —      | U29ART Red 324   | U29ART Red 324   | U29ART Red 324   | STD      |
| LAB250                                       |                | 1-7/16                  |  |          | (4)                      | (4)    |                  | (2)              | (2)              | (2)      |
| SA250  |                |                         |  |          |                          |        |                  |                  |                  |          |
| LAA300                                       | 300 kcmil      | 2-5/16                  | —  | Blue 76  | Blue 76                  | —      | U30ART Blue 470  | U30ART Blue 470  | U30ART Blue 470  | STD      |
| LAB300                                       |                | 1-1/2                   |  |          | (4)                      | (2)    |                  | (2)              | (2)              | (2)      |
| SA300  |                |                         |  |          |                          |        |                  |                  |                  |          |
| LAA350                                       | 350 kcmil      | 2-5/16                  | —  | Brown 87 | Brown 87H <sup>®</sup>   | —      | U31ART Brown 299 | U31ART Brown 299 | U31ART Brown 299 | STD      |
| LAB350                                       |                | 1-5/8                   |  |          | (4)                      | (4)    |                  | (2)              | (2)              | (2)      |
| SA350  |                |                         |  |          |                          |        |                  |                  |                  |          |
| LAA400                                       | 400 kcmil      | 2-9/16                  | —  | —        | Green 94H <sup>®</sup>   | —      | U32ART Green 472 | U32ART Green 472 | U32ART Green 472 | —        |
| LAB400                                       |                | 1-13/16                 |  |          | (4)                      |        | (4)              | (4)              | (4)              |          |
| SA400  |                |                         |  |          |                          |        |                  |                  |                  |          |
| LAA500                                       | 500 kcmil      | 3-1/16                  | —  | —        | Pink 99H <sup>®</sup>    | —      | U34ART Pink 300  | U34ART Pink 300  | U34ART Pink 300  | —        |
| LAB500                                       |                | 1-7/8                   |  |          | (4)                      |        | (4)              | (4)              | (4)              |          |
| SA500  |                |                         |  |          |                          |        |                  |                  |                  |          |
| LAA600                                       | 600 kcmil      | 3-1/16                  | —  | —        | Black 106                | —      | U36ART Black 473 | U36ART Black 473 | U36ART Black 473 | —        |
| LAB600                                       |                | 2                       |  |          | (3)                      |        | (4)              | (4)              | (4)              |          |
| SA600  |                |                         |  |          |                          |        |                  |                  |                  |          |
| LAA750                                       | 750 kcmil      | 3-7/16                  | —  | —        | Yellow 115H <sup>®</sup> | —      | —                | S39ART Red 301   | S39ART Red 301   | —        |
| LAB750                                       |                | 2-1/4                   |  |          | (4)                      |        |                  | (4)              | (4)              |          |
| SA750  |                |                         |  |          |                          |        |                  |                  |                  |          |
| LAA800                                       | 800 kcmil      | 3-7/16                  | —  | —        | 125H <sup>®</sup>        | —      | —                | Gray 474         | Gray 474         | —        |
| LAB800                                       |                | 2-5/16                  |  |          | (4)                      |        |                  | (4)              | (4)              |          |
| SA800  |                |                         |  |          |                          |        |                  |                  |                  |          |
| LAA1000                                      | 1000 kcmil     | 4-3/4                   | —  | —        | 161                      | —      | —                | S44ART Brown 302 | S44ART Brown 302 | —        |
| LAB1000                                      |                | 2-9/16                  |  |          | (5)                      |        |                  | (4)              | (4)              |          |
| SA1000                                       |                |                         |  |          |                          |        |                  |                  |                  |          |

®Half width dies.

- A. System Overview
- B1. Cable Ties
- B2. Cable Accessories
- B3. Stainless Steel Ties
- C1. Wiring Duct
- C2. Surface Raceway
- C3. Abrasion Protection
- C4. Cable Management
- D1. Terminals
- D2. Power Connectors
- D3. Grounding Connectors
- E1. Labeling Systems
- E2. Labels
- E3. Pre-Printed & Write-On Markers
- E4. Permanent Identification
- E5. Lockout/Tagout & Safety Solutions
- F. Index

**For use with Copper or Aluminum Conductors**

## Installation Tooling and Die Selections for: Type SAR

### How to read this chart

For SAR2-4 splice and CT-2001 crimping tool:

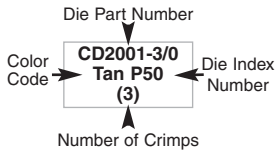

### Panduit (See Compression Connector Tools Selection Guide, Pages D3.34 – D3.36)

| Panduit Part Number | Aluminum Wire Size | Aluminum or Copper Wire Size | Wire Strip Length (both ends) (In.) | Die Part Number/Color Code and Die Index Number/ (Number Of Crimps) |   |   |
|---------------------|--------------------|------------------------------|-------------------------------------|---|---|---|
|                     |                    |                              |                                     | CT-720  | CT-2001, CT-2001L, CT-2001/LE, CT-2002, CT-2002/L, CT-3001, CT-3001/E | CT-920, CT-920CH, CT-930, CT-930CH, CT-2930, CT-2930/L, CT-2930/LE, CT-2931, CT-930LPCH, CT-2920, CT-940CH <sup>②</sup> , CT-2940 <sup>②</sup> , CT-2940/L <sup>②</sup> , CT-2940/LE <sup>②</sup> |
| <b>SAR2-4</b>       | #2 AWG             | #4 AWG                       | 2-1/16                              | CD-720-2<br>Tan P50<br>(3)  | CD-2001-3/0<br>Tan P50<br>(3)   | CD-920-3/0<br>Tan P50<br>(2)  |
| <b>SAR1/0-2</b>     | 1/0 AWG            | #2 AWG                       | 2-1/16                              | CD-720-2<br>Tan P50<br>(3)  | CD-2001-3/0<br>Tan P50<br>(3)   | CD-920-3/0<br>Tan P50<br>(2)  |
| <b>SAR3/0-1/0</b>   | 3/0 AWG            | 1/0 AWG                      | 2-5/16                              | CD-720-5<br>Red P71<br>(3)  | CD-2001-350<br>Red P71<br>(4)   | CD-920-350<br>Red P71<br>(2)  |
| <b>SAR4/0-2/0</b>   | 4/0 AWG            | 2/0 AWG                      | 2-3/16                              | CD-720-5<br>Red P71<br>(3)  | CD-2001-350<br>Red P71<br>(4)   | CD-920-350<br>Red P71<br>(2)  |
| <b>SAR350-4/0</b>   | 350 kcmil          | 4/0 AWG                      | 3-3/16                              | CD-720-7<br>Brown P87<br>(4)  | —   | CD-920-500<br>Brown P87<br>(4)  |
| <b>SAR500-350</b>   | 500 kcmil          | 350 kcmil                    | 4-1/4                               | —   | —   | CD-920-500A<br>Pink P99<br>(4)  |
| <b>SAR600-500</b>   | 600 kcmil          | 500 kcmil                    | 4                                   | —   | —   | CD-920-750, CD-940-750 <sup>③</sup><br>Black P106<br>(4)  |
| <b>SAR750-600</b>   | 750 kcmil          | 600 kcmil                    | 4-7/16                              | —   | —   | CD-940-750 <sup>③</sup><br>Red P125<br>(4)  |

②CD-920 dies can be used with CT-940CH and CT-2940 tools with CD-940-DA die adapter. Maximum size splice is 250 kcmil with Panduit CT-920, CT-920CH and CT-2920 tools and Burndy Y35, Y35BH and BAT35 tools.

③CD-940 dies to be used exclusively with CT-940CH and CT-2940 tools.

For use with  
Copper or  
Aluminum  
Conductors

## Installation Tooling and Die Selections for: Type SAR (continued)

| Thomas & Betts   |                 |                                 | Burndy        |   |                            | Anderson   |
|--|-----------------|---------------------------------|---------------|---|----------------------------|------------|
| TBM5   | TBM8            | TBM15, TBM15I,<br>TBM15BSCR     | MY29          | Y35, Y39, Y750, Y750-HS,<br>BAT35, BAT750, PAT750,<br>Y35BH, Y39BH, Y750BH,<br>Y750-2, Y750BH-2 | Y45, Y46                   | VC6        |
| <b>Die Part Number/Color Code and Die Index Number/<br/>(Number of Crimps)</b> |                 |                                 |               |   |                            |            |
| Tan 50<br>(3)  | Tan 50<br>(3)   | Tan 50<br>(2)                   | 1/0 AL<br>(1) | U25ART<br>Tan 296<br>(2)  | U25ART<br>Tan 296<br>(2)   | STD<br>(1) |
| Tan 50<br>(3)  | Tan 50<br>(3)   | Tan 50<br>(2)                   | 1/0 AL<br>(1) | U25ART<br>Tan 296<br>(2)  | U25ART<br>Tan 296<br>(2)   | STD<br>(1) |
| —  | Red 71<br>(4)   | Red 71H <sup>①</sup><br>(4)     | —             | U29ART<br>Red 324<br>(2)  | U29ART<br>Red 324<br>(2)   | STD<br>(2) |
| —  | Red 71<br>(4)   | Red 71H <sup>①</sup><br>(4)     | —             | U29ART<br>Red 324<br>(2)  | U29ART<br>Red 324<br>(2)   | STD<br>(2) |
| —  | Brown 87<br>(4) | Brown 87H <sup>①</sup><br>(4)   | —             | U31ART<br>Brown 299<br>(2)  | U31ART<br>Brown 299<br>(2) | STD<br>(2) |
| —  | —               | Pink 99H <sup>①</sup><br>(4)    | —             | U34ART<br>Pink 300<br>(4)   | U34ART<br>Pink 300<br>(4)  | —          |
| —  | —               | Black 106<br>(3)                | —             | U36ART<br>Black 473<br>(4)  | U36ART<br>Black 473<br>(4) | —          |
| —  | —               | Yellow 115H <sup>①</sup><br>(4) | —             | —   | P39ART<br>Red 301<br>(4)   | —          |

①Half width dies.

A.  
System  
Overview

B1.  
Cable Ties

B2.  
Cable  
Accessories

B3.  
Stainless  
Steel Ties

C1.  
Wiring  
Duct

C2.  
Surface  
Raceway

C3.  
Abrasion  
Protection

C4.  
Cable  
Management

D1.  
Terminals

D2.  
Power  
Connectors

D3.  
Grounding  
Connectors

E1.  
Labeling  
Systems

E2.  
Labels

E3.  
Pre-Printed  
& Write-On  
Markers

E4.  
Permanent  
Identification

E5.  
Lockout/  
Tagout  
& Safety  
Solutions

F.  
Index

A. System Overview

B1. Cable Ties

B2. Cable Accessories

B3. Stainless Steel Ties

C1. Wiring Duct

C2. Surface Raceway

C3. Abrasion Protection

C4. Cable Management

D1. Terminals

D2. Power Connectors

D3. Grounding Connectors

E1. Labeling Systems

E2. Labels

E3. Pre-Printed & Write-On Markers

E4. Permanent Identification

E5. Lockout/Tagout & Safety Solutions

F. Index

**For use with Copper or Aluminum Conductors**

## Installation Tooling and Die Selections for: Type BPC

How to read this chart

For BPC6 connector and CT-2001 crimping tool:

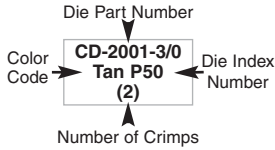

**Panduit (See Compression Connector Tools Selection Guide, Pages D3.34 – D3.36)**

**CT-2001, CT-2001/L, CT-2001/LE, CT-2002, CT-2002/L, CT-3001, CT-3001/E**

**CT-930, CT-930CH, CT-2930, CT-2930/L, CT-2930/LE, CT-2931, CT-920, CT-920CH, CT-2940<sup>②</sup>, CT-2940/L<sup>②</sup>, CT-2940/LE<sup>②</sup>, CT-2920, CT-940CH<sup>②</sup>**

| Panduit Part Number | Standard Wire Size | Wire Strip Length (In.) | Die Part Number/Color Code and Die Index Number/(Number Of Crimps) |  |   |
|---------------------|--------------------|-------------------------|--|--|---|
|                     |                    |                         | CT-720   | CT-2001, CT-2001/L, CT-2001/LE, CT-2002, CT-2002/L, CT-3001, CT-3001/E | CT-930, CT-930CH, CT-2930, CT-2930/L, CT-2930/LE, CT-2931, CT-920, CT-920CH, CT-2940 <sup>②</sup> , CT-2940/L <sup>②</sup> , CT-2940/LE <sup>②</sup> , CT-2920, CT-940CH <sup>②</sup> |
| <b>BPC6</b>         | #6 AWG             | 1-1/16                  | CD-720-2<br>Tan P50<br>(2)   | CD-2001-3/0<br>Tan P50<br>(2)  | CD-920-3/0<br>Tan P50<br>(2)  |
| <b>BPC4</b>         | #4 AWG             | 1-1/16                  | CD-720-2<br>Tan P50<br>(2)   | CD-2001-3/0<br>Tan P50<br>(2)  | CD-920-3/0<br>Tan P50<br>(2)  |
| <b>BPC2</b>         | #2 AWG             | 1-1/16                  | CD-720-2<br>Tan P50<br>(2)   | CD-2001-3/0<br>Tan P50<br>(2)  | CD-920-3/0<br>Tan P50<br>(2)  |
| <b>BPC1</b>         | #1 AWG             | 1-1/16                  | CD-720-2<br>Tan P50<br>(2)   | CD-2001-3/0<br>Tan P50<br>(2)  | CD-920-3/0<br>Tan P50<br>(2)  |
| <b>BPC1/0</b>       | 1/0 AWG            | 1-5/16                  | CD-720-5<br>Red P71<br>(2)   | CD-2001-350<br>Red P71<br>(3)  | CD-920-350<br>Red P71<br>(2)  |
| <b>BPC2/0</b>       | 2/0 AWG            | 1-5/16                  | CD-720-5<br>Red P71<br>(2)   | CD-2001-350<br>Red P71<br>(3)  | CD-920-350<br>Red P71<br>(2)  |
| <b>BPC3/0</b>       | 3/0 AWG            | 1-5/16                  | CD-720-5<br>Red P71<br>(2)   | CD-2001-350<br>Red P71<br>(3)  | CD-920-350<br>Red P71<br>(2)  |
| <b>BPC4/0</b>       | 4/0 AWG            | 1-5/16                  | CD-720-5<br>Red P71<br>(2)   | CD-2001-350<br>Red P71<br>(3)  | CD-920-350<br>Red P71<br>(2)  |
| <b>BPC250</b>       | 250 kcmil          | 1-7/16                  | —  | —  | CD-920-600<br>Green P94<br>(2)  |
| <b>BPC300</b>       | 300 kcmil          | 1-7/16                  | —  | —  | CD-920-600<br>Green P94<br>(2)  |
| <b>BPC350</b>       | 350 kcmil          | 1-7/16                  | —  | —  | CD-920-600<br>Green P94<br>(2)  |
| <b>BPC400</b>       | 400 kcmil          | 1-7/16                  | —  | —  | CD-920-750,<br>CD-940-750 <sup>③</sup><br>Black P106<br>(2)   |
| <b>BPC500</b>       | 500 kcmil          | 1-7/16                  | —  | —  | CD-920-750,<br>CD-940-750 <sup>③</sup><br>Black P106<br>(2)   |
| <b>BPC600</b>       | 600 kcmil          | 1-15/16                 | —  | —  | CD-940-750A <sup>③</sup><br>Red P125 (2)  |
| <b>BPC750</b>       | 750 kcmil          | 1-15/16                 | —  | —  | CD-940-750A <sup>③</sup><br>Red P125 (2)  |

②CD-920 dies can be used with CT-940CH and CT-2940 tools with CD-940-DA die adapter. Maximum size splice is 250 kcmil with CT-920, CT-920CH, and CT-2920 tools.

③CD-940 dies to be used exclusively with CT-940CH and CT-2940 tools.



For use with  
Copper or  
Aluminum  
Conductors

## Installation Tooling and Die Selections for: Type BPC (continued)

| Thomas & Betts   |                 |                                 | Burndy                     |                               |
|--|-----------------|---------------------------------|----------------------------|-------------------------------|
| 13642M   | TBM8            | TBM15, TBM15I,<br>TBM15BSCR     | Y35, BAT35                 | Y39, Y45, Y46,<br>Y39BH       |
| Die Part Number/Color Code and Die Index Number/(Number of Crimps) |                 |                                 |                            |                               |
| Orange 50<br>(2)   | Tan 50<br>(2)   | Orange 50<br>(2)                | U25ART<br>Tan 296<br>(2)   | U25ART<br>Tan 296<br>(2)      |
| Orange 50<br>(2)   | Tan 50<br>(2)   | Orange 50<br>(2)                | U25ART<br>Tan 296<br>(2)   | U25ART<br>Tan 296<br>(2)      |
| Orange 50<br>(2)   | Tan 50<br>(2)   | Orange 50<br>(2)                | U25ART<br>Tan 296<br>(2)   | U25ART<br>Tan 296<br>(2)      |
| Orange 50<br>(2)   | Tan 50<br>(2)   | Orange 50<br>(2)                | U25ART<br>Tan 296<br>(2)   | U25ART<br>Tan 296<br>(2)      |
| Blue 76H <sup>①</sup><br>(2)                                       | Blue 76<br>(2)  | Blue 76<br>(2)                  | U28ART<br>White 298<br>(2) | U28ART<br>White 298<br>(2)    |
| Blue 76H <sup>①</sup><br>(2)                                       | Blue 76<br>(2)  | Blue 76<br>(2)                  | U28ART<br>White 298<br>(2) | U28ART<br>White 298<br>(2)    |
| Blue 76H <sup>①</sup><br>(2)                                       | Blue 76<br>(2)  | Blue 76<br>(2)                  | U28ART<br>White 298<br>(2) | U28ART<br>White 298<br>(2)    |
| Blue 76H <sup>①</sup><br>(2)                                       | Blue 76<br>(2)  | Blue 76<br>(2)                  | U28ART<br>White 298<br>(2) | U28ART<br>White 298<br>(2)    |
| Pink 99H <sup>①</sup><br>(2)                                       | Brown 87<br>(3) | Brown 87H <sup>①</sup><br>(2)   | U31ART<br>Brown 299<br>(2) | U31ART<br>Brown 299<br>(2)    |
| Pink 99H <sup>①</sup><br>(2)                                       | Brown 87<br>(3) | Brown 87H <sup>①</sup><br>(2)   | U31ART<br>Brown 299<br>(2) | U31ART<br>Brown 299<br>(2)    |
| Pink 99H <sup>①</sup><br>(2)                                       | Brown 87<br>(3) | Brown 87H <sup>①</sup><br>(2)   | U31ART<br>Brown 299<br>(2) | U31ART<br>Brown 299<br>(2)    |
| Black 106H <sup>①</sup><br>(3)                                     | —               | Black 106H <sup>①</sup><br>(3)  | U34ART<br>Pink 300<br>(3)  | U34ART<br>Pink 300<br>(3)     |
| Black 106H <sup>①</sup><br>(3)                                     | —               | Black 106H <sup>①</sup><br>(3)  | U34ART<br>Pink 300<br>(3)  | U34ART<br>Pink 300<br>(3)     |
| Yellow 115H <sup>①</sup><br>(3)                                    | —               | Yellow 115H <sup>①</sup><br>(3) | —                          | U39ART-2<br>Yellow 936 (3)    |
| Yellow 115H <sup>①</sup><br>(3)                                    | —               | Yellow 115H <sup>①</sup><br>(3) | —                          | U39ART-2<br>Yellow 936<br>(3) |

① Half width dies.

A.  
System  
Overview

B1.  
Cable Ties

B2.  
Cable  
Accessories

B3.  
Stainless  
Steel Ties

C1.  
Wiring  
Duct

C2.  
Surface  
Raceway

C3.  
Abrasion  
Protection

C4.  
Cable  
Management

D1.  
Terminals

D2.  
Power  
Connectors

D3.  
Grounding  
Connectors

E1.  
Labeling  
Systems

E2.  
Labels

E3.  
Pre-Printed  
& Write-On  
Markers

E4.  
Permanent  
Identification

E5.  
Lockout/  
Tagout  
& Safety  
Solutions

F.  
Index

A. System Overview

B1. Cable Ties

B2. Cable Accessories

B3. Stainless Steel Ties

C1. Wiring Duct

C2. Surface Raceway

C3. Abrasion Protection

C4. Cable Management

D1. Terminals

D2. Power Connectors

D3. Grounding Connectors

E1. Labeling Systems

E2. Labels

E3. Pre-Printed & Write-On Markers

E4. Permanent Identification

E5. Lockout/Tagout & Safety Solutions

F. Index

**For use with Copper Conductors**

## Installation Tooling and Die Selections for: Types GCE, GCC and GPC

### How to read this chart

For GCE250-1/0 and CT-2930 tool:

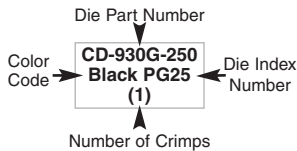

| Installation Tools   |   |  |
|--|---|--|
| 12 TON   | 14 TON  | 15 TON   |
| <b>Panduit</b>   |   |  |
| CT-2931  | CT-930<br>CT-930CH<br>CT-2930<br>CT-2930/L<br>CT-2930/LE                | CT-940CH<br>CT-2940<br>CT-2940/L<br>CT-2940/LE |
| <b>Burndy</b>  |   |  |
| Y750,<br>Y750-2,<br>Y750BH,<br>Y750BH-2,<br>BAT750-14V,<br>PAT750-18V,<br>PAT750C-18V,<br>PAT750XT-18V,<br>PAT750CXT-18V,<br>LPHY750 | —   | Y46,<br>Y46C,<br>LPHY46                        |
| <b>Thomas &amp; Betts</b>  |   |  |
|  | TBM14M,<br>TBM14MC,<br>13100A,<br>TBM14RH,<br>TBM14BSCR,<br>BPLT14BSCRI | TBM15<br>TBM15BSCR                             |
| Panduit Crimp Die Part Number/Color Code/Die Index Number/(Number of Crimps)   |   |  |
| CD-930G-1/0  |   |  |
| Red  |   |  |
| PG10   |   |  |
| (1)  |   |  |
| CD-930G-250  |   |  |
| Black  |   |  |
| PG25   |   |  |
| (1)  |   |  |
| CD-930G-250  |   |  |
| Black  |   |  |
| PG25   |   |  |
| (1)  |   |  |
| CD-930G-500  |   |  |
| Blue   |   |  |
| PG50   |   |  |
| (1)  |   |  |
| CD-930G-500  |   |  |
| Blue   |   |  |
| PG50   |   |  |
| (1)  |   |  |

| Panduit Part Number | Element | Copper Conductor Size Range | Ground Rod Size (In.) | Rebar Size (In.)   |
|---------------------|---------|-----------------------------|-----------------------|--------------------|
| GCE1/0-1/0          | Main    | #6 AWG SOL – 1/0 AWG STR    | —                     | —                  |
|                     | Tap     | #6 AWG SOL – 1/0 AWG STR    | —                     | —                  |
| GCC6X61/0-1/0       | A       | #6 AWG SOL – 1/0 AWG STR    | —                     | —                  |
|                     | B       | #6 AWG SOL – 1/0 AWG STR    | —                     | —                  |
| GCE250-1/0          | Main    | 1/0 AWG SOL – 250 kcmil     | 1/2 – 5/8             | 3/8 – 1/2, #3 – #4 |
|                     | Tap     | #6 AWG SOL – 1/0 AWG STR    | —                     | —                  |
| GCC6X6250-1/0       | A       | #2 AWG SOL – 250 kcmil      | 1/2 – 5/8             | 3/8 – 1/2, #3 – #4 |
|                     | B       | #6 AWG SOL – 1/0 AWG STR    | —                     | —                  |
| GCE250-250          | Main    | 1/0 AWG SOL – 250 kcmil     | 1/2 – 5/8             | 3/8 – 1/2, #3 – #4 |
|                     | Tap     | 1/0 AWG SOL – 250 kcmil     | 1/2 – 5/8             | 3/8 – 1/2, #3 – #4 |
| GCE6X6250-250       | A       | #2 AWG SOL – 250 kcmil      | 1/2 – 5/8             | 3/8 – 1/2, #3 – #4 |
|                     | B       | #2 AWG SOL – 250 kcmil      | 1/2 – 5/8             | 3/8 – 1/2, #3 – #4 |
| GPC4H250-2          |         | #2 AWG SOL – 250 kcmil      | —                     | —                  |
| GCE500-1/0          | Main    | 250 – 500 kcmil             | 1/2 – 3/4             | 5/8 – 3/4, #5 – #6 |
|                     | Tap     | #6 AWG SOL – 1/0 AWG STR    | —                     | —                  |
| GCC6X6500-1/0       | A       | 250 – 500 kcmil             | 1/2 – 3/4             | 5/8 – 3/4, #5 – #6 |
|                     | B       | #6 AWG SOL – 1/0 AWG STR    | —                     | —                  |
| GCE500-250          | Main    | 250 – 500 kcmil             | 1/2 – 3/4             | 5/8 – 3/4, #5 – #6 |
|                     | Tap     | 1/0 AWG SOL – 250 kcmil     | —                     | —                  |
| GCC6X6500-250       | A       | 250 – 500 kcmil             | 1/2 – 3/4             | 5/8 – 3/4, #5 – #6 |
|                     | B       | #2 AWG SOL – 250 kcmil      | —                     | —                  |

15 ton tools require the CD-940-DA adapter when used with CD-930G series crimping dies. Panduit crimping dies must be used with all tooling (Panduit and competitor).

**For use with  
Copper  
Conductors**

## Installation Tooling and Die Selections for: Type CTAP

**How to read  
this chart**

For  
CTAPF4-6 tap  
and CT-2001  
crimping tool:

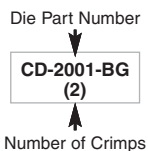

| Panduit Part Number  | Conductor Size                |                        | Wire Strip Length (In.) | Panduit   |  | Burdny             |   |
|--|-------------------------------|------------------------|-------------------------|---|--|--------------------|---|
|  | Main                          | Tap                    |                         | CT-920, CT-920CH, CT-930, CT-2920, CT-930CH, CT-2930, CT-2930/L, CT-2930/LE, CT-2931, CT-940CH <sup>①</sup> , CT-2940 <sup>①</sup> , CT-2940/L <sup>①</sup> , CT-2940/LE <sup>①</sup> | CT-2001, CT-2001/L, CT-2001/LE, CT-2002, CT-2002/L, CT-3001, CT-3001/E | MD6, MD7           | BAT35, BAT750, PAT750, Y35, Y35BH, Y39, Y39BH, Y45, Y46, Y750, Y750HS, Y750BH |
| Crimp Die Number/Index Number or Color Code/(Number Of Crimps) |                               |                        |                         |   |  |                    |   |
| CTAP4-8  | #6 – #4 AWG SOL or STR        | #8 AWG SOL or STR      | 3/4                     | CD-920-BG (1)   | CD-2001-BG (1)   | W-BG (1)<br>BG (2) | U-BG (1)  |
| CTAP4-6  | #6 AWG STR, #4 AWG SOL or STR | #6 AWG SOL or STR      | 3/4                     | CD-920-BG (1)   | CD-2001-BG (2)   | W-BG (1)<br>BG (2) | U-BG (1)  |
| CTAP4-4  | #4 AWG SOL or STR             | #4 AWG STR             | 3/4                     | CD-920-BG (1)   | CD-2001-BG (1)   | W-BG (1)<br>BG (2) | U-BG (1)  |
| CTAP2-4  | #2 AWG SOL or STR             | #8 – #4 AWG SOL or STR | 7/8                     | CD-920-C (1)  | CD-2001-C (2)  | W-C Brown (2)      | U-C (1)   |
| CTAP2-2  | #2 AWG SOL or STR             | #2 AWG SOL or STR      | 7/8                     | CD-920-C (1)  | CD-2001-C (2)  | W-C Brown (2)      | U-C (1)   |
| CTAP2/0-2  | 1/0 – 2/0 AWG                 | #8 – #2 AWG SOL or STR | 1-1/16                  | CD-920-0 Green (1)  | —  | —                  | U-O (1)<br>U-E (3)  |
| CTAP2/0-2/0  | 1/0 – 2/0 AWG STR             | 1/0 – 2/0 AWG STR      | 1-1/16                  | CD-920-0 Green (1)  | —  | —                  | U-O (1)<br>U-E (3)  |
| CTAP4/0-2  | 3/0 – 4/0 AWG STR             | #6 – #2 AWG SOL or STR | 1-1/4                   | CD-920-D3 Blue (1)  | —  | —                  | U-F (2)<br>U-D3 (1)   |
| CTAP4/0-2/0  | 3/0 – 4/0 AWG STR             | 1/0 – 2/0 AWG STR      | 1-1/4                   | CD-920-D3 Blue (1)  | —  | —                  | U-F (2)<br>U-D3 (1)   |
| CTAP4/0-4/0  | 3/0 – 4/0 AWG STR             | 3/0 – 4/0 AWG STR      | 1-1/4                   | CD-920-D3 Blue (1)  | —  | —                  | U-F (2)<br>U-D3 (1)   |

<sup>①</sup>CD-920 dies can be used with CT-940CH and CT-2940 tools with CD-940-DA adapter.

A.  
System  
Overview

B1.  
Cable  
Ties

B2.  
Cable  
Accessories

B3.  
Stainless  
Steel Ties

C1.  
Wiring  
Duct

C2.  
Surface  
Raceway

C3.  
Abrasion  
Protection

C4.  
Cable  
Management

D1.  
Terminals

D2.  
Power  
Connectors

D3.  
Grounding  
Connectors

E1.  
Labeling  
Systems

E2.  
Labels

E3.  
Pre-Printed  
& Write-On  
Markers

E4.  
Permanent  
Identification

E5.  
Lockout/  
Tagout  
& Safety  
Solutions

F.  
Index

A. System Overview

B1. Cable Ties

B2. Cable Accessories

B3. Stainless Steel Ties

C1. Wiring Duct

C2. Surface Raceway

C3. Abrasion Protection

C4. Cable Management

D1. Terminals

D2. Power Connectors

D3. Grounding Connectors

E1. Labeling Systems

E2. Labels

E3. Pre-Printed & Write-On Markers

E4. Permanent Identification

E5. Lockout/Tagout & Safety Solutions

F. Index

**For use with Copper Conductors**

## Installation Tooling and Die Selections for: Type CTAPF

### How to read this chart

For CTAPF6-12 tap and CT-2001 crimping tool:

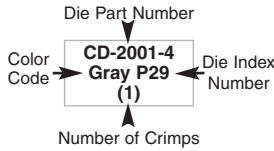

| Panduit Part Number   | Stranded Wire Size |               | Panduit           |   |   |                            |
|---|--------------------|---------------|-------------------|---|---|----------------------------|
|   | Main               | Tap           | 1700 <sup>①</sup> | CT-920, CT-920CH, CT-2920, CT-930, CT-930CH, CT-2930, CT-2930/L, CT-2930/LE, CT-2931, CT-940CH <sup>②</sup> , CT-2940 <sup>②</sup> , CT-2940/L <sup>②</sup> , CT-2940/LE <sup>②</sup> | CT-2001, CT-2001/L, CT-2001/LE, CT-2002, CT-2002/L, CT-3001, CT-3001E |                            |
| Die Part Number/Color Code and Die Index Number/ (Number of Crimps) |                    |               |                   |   |   |                            |
| CTAPF10-16  | #14 AWG            | #16 – #14 AWG | Red P21 (2)       | —   | —   | CD-2001-8 Red P21 (1)      |
|   | #12 AWG            | #16 – #12 AWG |                   |   |   |                            |
|   | #10 AWG            | #14 AWG       |                   |   |   |                            |
| CTAPF8-12   | #10 AWG            | #10 AWG       | Blue P24 (2)      | —   | —   | CD-2001-6 Blue P24 (1)     |
|   | #8 AWG             | #12 AWG       |                   |   |   |                            |
| CTAPF6-12   | #8 AWG             | #8 – #12 AWG  | Gray P29 (2)      | —   | —   | CD-2001-4 Gray P29 (1)     |
|   | #6 AWG             | #12 – #10 AWG |                   |   |   |                            |
| CTAPF4-12   | #6 AWG             | #8 – #6 AWG   | Brown P33 (4)     | CDM-920-2 Brown P33M (1)  | CDM-2001-2 Brown P33M (1)   | CD-2001-2 Brown P33 (2)    |
|   | #5, #4 AWG         | #12 – #8 AWG  |                   |   |   |                            |
| CTAPF3-12   | #5, #4 AWG         | #6 – #5 AWG   | Green P37 (4)     | CDM-920-1 Green P37M (1)  | CDM-2001-1 Green P37M (1)   | CD-2001-1 Green P37 (2)    |
|   | #3 AWG             | #12 – #6 AWG  |                   |   |   |                            |
| CTAPF2-12   | #4 AWG             | #4 AWG        | —                 | CDM-920-1/0 Pink P42M (1)   | CDM-2001-1/0 Pink P42M (1)  | CD-2001-1/0 Pink P42 (2)   |
|   | #3 AWG             | #5 AWG        |                   |   |   |                            |
|   | #2 AWG             | #12 – #6 AWG  |                   |   |   |                            |
| CTAPF1-12   | #3 AWG             | #4 – #3 AWG   | —                 | CDM-920-2/0 Black P45M (1)  | CDM-2001-2/0 Black P45M (2)   | CD-2001-2/0 Black P45 (3)  |
|   | #2 AWG             | #5 – #4 AWG   |                   |   |   |                            |
|   | #1 AWG             | #12 – #5 AWG  |                   |   |   |                            |
| CTAPF1/0-12   | #2 AWG             | #4 – #2 AWG   | —                 | CDM-920-3/0 Orange P50M (1)   | CDM-2001-3/0 Orange P50M (2)  | CD-2001-3/0 Orange P50 (3) |
|   | #1 AWG             | #4 – #3 AWG   |                   |   |   |                            |
|   | 1/0 AWG            | #12 – #4 AWG  |                   |   |   |                            |
| CTAPF2/0-12   | #1 AWG             | #2 – #1 AWG   | —                 | CDM-920-4/0 Purple P54M (1)   | —   | CD-2001-4/0 Purple P54 (3) |
|   | 1/0 AWG            | #3 – #2 AWG   |                   |   |   |                            |
|   | 2/0 AWG            | #12 – #3 AWG  |                   |   |   |                            |
| CTAPF3/0-12   | 1/0 AWG            | #1 – 1/0 AWG  | —                 | CDM-920-250 Yellow P62M (1)   | —   | CD-2001-250 Yellow P62 (3) |
|   | 2/0 AWG            | #2 – #1 AWG   |                   |   |   |                            |
|   | 3/0 AWG            | #12 – #2 AWG  |                   |   |   |                            |

①The CT-1700 crimp die pockets are integrated into the tool frame.  
 ②CDM-920 dies can be used with CT-940CH and CT-2940 tools with CD-940-DA adapter.

For use with  
Copper  
Conductors

## Installation Tooling and Die Selections for: Type CTAPF (continued)

| Panduit Part Number | Stranded Wire Size |               | Burndy  |  | Thomas & Betts                            |
|---------------------|--------------------|---------------|---|--|---|
|                     | Run                | Tap           | Y35, Y39, Y45, Y46, Y750BH-2<br>Y750, BAT35, BAT750,<br>Y35BH, Y39BH, Y750BH,<br>Y750HS, PAT750, Y750-2 | Y500CT-HS,<br>BCT500-HS,<br>BCT500, Y500CT | TBM8-750,<br>TBM8-750M-1,<br>TBM8-750BSCR |
|                     |                    |               | Die Part Number/Color Code and Die Index Number/<br>(Number of Crimps)                                  |  |   |
| CTAPF10-16          | #14 AWG            | #16 – #14 AWG | —   | —  | —   |
|                     | #12 AWG            | #16 – #12 AWG | —   | —  | —   |
|                     | #10 AWG            | #14 AWG       | —   | —  | —   |
| CTAPF8-12           | #10 AWG            | #10 AWG       | —   | —  | —   |
|                     | #8 AWG             | #12 AWG       | —   | —  | —   |
| CTAPF6-12           | #8 AWG             | #8 – #12 AWG  | —   | —  | —   |
|                     | #6 AWG             | #12 – #10 AWG | —   | —  | —   |
| CTAPF4-12           | #6 AWG             | #8 – #6 AWG   | UC4<br>Brown 10M<br>(1)   | WC4<br>Brown 10M<br>(1)                    | TBM8-750C20<br>(1)                        |
|                     | #5, #4 AWG         | #12 – #8 AWG  | —   | —  | —   |
| CTAPF3-12           | #5, #4 AWG         | #6 – #5 AWG   | —   | —  | TBM8-750C2530<br>(1)                      |
|                     | #3 AWG             | #12 – #6 AWG  | —   | —  | —   |
| CTAPF2-12           | #4 AWG             | #4 AWG        | UC2<br>Pink 12M<br>(1)  | WC2<br>Pink 12M<br>(1)                     | TBM8-750C2530<br>(1)                      |
|                     | #3 AWG             | #5 AWG        | —   | —  | —   |
|                     | #2 AWG             | #12 – #6 AWG  | —   | —  | —   |
| CTAPF1-12           | #3 AWG             | #4 – #3 AWG   | UC1<br>Black 13M<br>(1)   | WC1<br>Black 13M<br>(2)                    | TBM8-750C3540<br>(1)                      |
|                     | #2 AWG             | #5 – #4 AWG   | —   | —  | —   |
|                     | #1 AWG             | #12 – #5 AWG  | —   | —  | —   |
| CTAPF1/0-12         | #2 AWG             | #4 – #2 AWG   | UC25<br>Orange 14M<br>(1)   | WC25<br>Orange 14M<br>(2)                  | TBM8-750C3540<br>(1)                      |
|                     | #1 AWG             | #4 – #3 AWG   | —   | —  | —   |
|                     | 1/0 AWG            | #12 – #4 AWG  | —   | —  | —   |
| CTAPF2/0-12         | #1 AWG             | #2 – #1 AWG   | —   | —  | TBM8-750C4550<br>(1)                      |
|                     | 1/0 AWG            | #3 – #2 AWG   | —   | —  | —   |
| CTAPF3/0-12         | 2/0 AWG            | #12 – #3 AWG  | —   | —  | —   |
|                     | 1/0 AWG            | #1 – 1/0 AWG  | —   | —  | TBM8-750C4550<br>(1)                      |
|                     | 2/0 AWG            | #2 – #1 AWG   | —   | —  | —   |
|                     | 3/0 AWG            | #12 – #2 AWG  | —   | —  | —   |

A.  
System  
Overview

B1.  
Cable Ties

B2.  
Cable  
Accessories

B3.  
Stainless  
Steel Ties

C1.  
Wiring  
Duct

C2.  
Surface  
Raceway

C3.  
Abrasion  
Protection

C4.  
Cable  
Management

D1.  
Terminals

D2.  
Power  
Connectors

D3.  
Grounding  
Connectors

E1.  
Labeling  
Systems

E2.  
Labels

E3.  
Pre-Printed  
& Write-On  
Markers

E4.  
Permanent  
Identification

E5.  
Lockout/  
Tagout  
& Safety  
Solutions

F.  
Index

A. System Overview

B1. Cable Ties

B2. Cable Accessories

B3. Stainless Steel Ties

C1. Wiring Duct

C2. Surface Raceway

C3. Abrasion Protection

C4. Cable Management

D1. Terminals

D2. Power Connectors

D3. Grounding Connectors

E1. Labeling Systems

E2. Labels

E3. Pre-Printed & Write-On Markers

E4. Permanent Identification

E5. Lockout/Tagout & Safety Solutions

F. Index

**For use with Copper Conductors**

## Installation Tooling and Die Selections for: Type HTCT

### How to read this chart

For HTCT6X-6X tap and CT-2931 crimping tool:

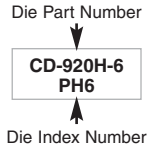

| Installation Tools   |  |  |
|--|--|--|
| 15 TON   | 14 TON   | 12 TON   |
| <b>Panduit</b>   |  |  |
| CT-940CH <sup>①</sup><br>CT-2940 <sup>①</sup><br>CT-2940/L <sup>①</sup><br>CT-2940/LE <sup>①</sup> | CT-930,<br>CT-930CH,<br>CT-2930,<br>CT-2930/L,<br>CT-2930/LE | CT-920,<br>CT-920CH,<br>CT-2920,<br>CT-2931,<br>CT-2931/E  |
| <b>Burndy</b>  |  |  |
| Y46 <sup>①</sup><br>Y46C <sup>①</sup>  | —  | Y35, Y35-2,<br>Y35BH,<br>Y35BH-4,<br>Y750,<br>Y39, Y39BH,<br>Y750-2,<br>Y750BH,<br>Y750BH-2,<br>Y750HS,<br>BAT35,<br>BAT750,<br>BAT750C,<br>PAT750,<br>PAT750C |
| <b>Thomas &amp; Betts</b>  |  |  |
| TBM151,<br>TBM15BSCR   | TBM14M,<br>TBM14BSCR,<br>BPLT14BSCR,<br>13100A               | —  |
| <b>Panduit Crimp Die Part Number/Die Index Number (Number of Crimps = 1)</b>                       |  |  |
| HTCT6X-6X  | HTCT2-2  | HTCT250-2  |
| HTCT250-250  |  |  |

| Panduit Part Number | Copper Conductor Sizes (Code Cable) |                   |            |            | Copper Conductor Sizes (Flex Cable) Types G, H, I, K, M and Locomotive (DLO) |            |            |            | Crimp Die Color Code |
|---------------------|-------------------------------------|-------------------|------------|------------|--|------------|------------|------------|----------------------|
|                     | Run                                 | Tap 1             | Tap 2      | Tap 3      | Main   | Tap 1      | Tap 2      | Tap 3      |                      |
| HTCT6X-6X           | #6-#14 AWG                          | #6-#14 AWG        | —          | —          | #6-#10 AWG   | #6-#14 AWG | —          | —          | Orange               |
| HTCT2-2             | #2-#6 AWG                           | #2-#6 AWG         | #8-#14 AWG | #8-#14 AWG | #2-#8 AWG  | #2-#8 AWG  | #8-#14 AWG | #8-#14 AWG | Brown                |
| HTCT250-2           | 250 kcmil -#2 AWG                   | #2-#6 AWG         | #8-#14 AWG | —          | 4/0-#2 AWG   | #2-#8 AWG  | #8-#14 AWG | —          | Purple               |
| HTCT250-250         | 250 kcmil -#2 AWG                   | 250 kcmil -#2 AWG | —          | —          | 4/0-#2 AWG   | 4/0-#2 AWG | —          | —          | Purple               |

①CD-920H and CD-930H dies can be used with CT-940CH and CT-2940 Panduit tools and Y46 and Y46C Burndy tools with CD-940-DA adapter. Panduit crimping dies must be used with all tooling (Panduit and competitor) to maintain UL/CSA certifications for applications up to 600 V.



# NOTES

A.  
System  
Overview

B1.  
Cable Ties

B2.  
Cable  
Accessories

B3.  
Stainless  
Steel Ties

C1.  
Wiring  
Duct

C2.  
Surface  
Raceway

C3.  
Abrasion  
Protection

C4.  
Cable  
Management

D1.  
Terminals

D2.  
Power  
Connectors

D3.  
Grounding  
Connectors

E1.  
Labeling  
Systems

E2.  
Labels

E3.  
Pre-Printed  
& Write-On  
Markers

E4.  
Permanent  
Identification

E5.  
Lockout/  
Tagout  
& Safety  
Solutions

F.  
Index

|                                       |
|---------------------------------------|
| A. System Overview                    |
| B1. Cable Ties                        |
| B2. Cable Accessories                 |
| B3. Stainless Steel Ties              |
| C1. Wiring Duct                       |
| C2. Surface Raceway                   |
| C3. Abrasion Protection               |
| C4. Cable Management                  |
| D1. Terminals                         |
| D2. Power Connectors                  |
| D3. Grounding Connectors              |
| E1. Labeling Systems                  |
| E2. Labels                            |
| E3. Pre-Printed & Write-On Markers    |
| E4. Permanent Identification          |
| E5. Lockout/Tagout & Safety Solutions |
| F. Index                              |

## LABELING SYSTEMS

Panduit is a global leader in reliable and innovative solutions for identification and safety. Products are engineered for a wide variety of industries and applications – including electrical, electronics, industrial and network. Panduit provides enhanced productivity, reliability, and value with leading-edge software development, materials and equipment by designing and manufacturing a full line of labeling products, software and printers to assist you with your labeling requirements.



- World-class quality – ISO 9001 and ISO 14001
- High performance and reliability
- Wide variety of system solutions to meet the most demanding requirements
- Meet and exceed the requirements of UL, CSA, ISO, NEC and OSHA
- Strong service and support network – distributor partners, knowledgeable sales people, expert technical support and world-class customer service



Panduit provides a complete range of industrial products and tools – including hand-held labeling systems, desktop labeling systems, pre-printed labels and safety systems. Use Panduit for all your identification needs for wire and cable, electrical and electronic devices, agency compliance, workplace safety and more.



## PRINTERS: THERMAL TRANSFER DESKTOP AND HAND-HELD

Panduit desktop thermal transfer printers enable fast, high quality label production for all your identification requirements. Use Panduit labeling software and desktop thermal transfer printers to produce on demand identification solutions quickly and economically. Panduit hand-held printers are designed for flexibility. Programmed with advanced functionality, Panduit printers make custom labeling easy.



### Hand-Held Printers

- Create labels at remote job sites
- Provide crisp, clear, high quality thermal transfer print
- Easily identify moves, adds, or changes

### Desktop Printers

- Compatible with Panduit® Easy-Mark™ Labeling Software
- Provide crisp, clear, high quality thermal transfer print
- Compatible with WINDOWS^ based PC operating systems

Panduit printers and our wide variety of labels provide solutions for all your project labeling needs.

^WINDOWS is a registered trademark of Microsoft Corporation in the United States and/or other countries.

A.  
System  
Overview

B1.  
Cable Ties

B2.  
Cable  
Accessories

B3.  
Stainless  
Steel Ties

C1.  
Wiring  
Duct

C2.  
Surface  
Raceway

C3.  
Abrasion  
Protection

C4.  
Cable  
Management

D1.  
Terminals

D2.  
Power  
Connectors

D3.  
Grounding  
Connectors

E1.  
Labeling  
Systems

E2.  
Labels

E3.  
Pre-Printed  
& Write-On  
Markers

E4.  
Permanent  
Identification

E5.  
Lockout/  
Tagout  
& Safety  
Solutions

F.  
Index

A. System Overview

## PanTher™ LS8E Hand-Held Thermal Transfer Printer and Accessories

- Cut-to-length functionality eliminates label waste and label trimming labor
- Partial cut feature available to provide tear-apart strips of labels
- P1™ Label Cassette contains an integrated memory device for automatic formatting, recall of last legend used, and number of labels remaining in the cassette
- Market specific labeling tools simplify label creation for electrical components, panel building, and construction and maintenance
- USB interface for importing data, system upgrades, and printing from a wireless laptop or desktop computer
- Prints self-laminating labels, heat shrink tubing, die-cut component labels and continuous tapes
- Fast loading label cassette includes both label material and ribbon to make changing labels easy
- Large graphic display with backlight for improved visibility



LS8E-KIT



LS8EQ

| Part Number          | Part Description   | Std. Pkg. Qty. |
|----------------------|--|----------------|
| <b>LS8EQ-KIT-ACS</b> | Includes LS8EQ printer with QWERTY keypad, one cassette of S100X150VAC self-laminating labels, six AA alkaline batteries, LS8E-ACS, LS8-CASE, LS8-PCKIT, LS8-IB, LS8-WS, quick reference card and operator's manual. | 1              |
| <b>LS8EQ-KIT</b>     | Includes LS8EQ printer with QWERTY keypad, one cassette of S100X150VAC self-laminating labels, six AA alkaline batteries, LS8-CASE, LS8-PCKIT, LS8-IB, LS8-WS, quick reference card and operator's manual.           | 1              |
| <b>LS8EQ</b>         | Includes LS8EQ printer with QWERTY keypad, one cassette of S100X150VAC self-laminating labels, six AA alkaline batteries and quick reference card.   | 1              |
| <b>LS8E-KIT-ACS</b>  | Includes LS8E printer, one cassette of S100X150VAC self-laminating labels, six AA alkaline batteries, LS8E-ACS, LS8-CASE, LS8-PCKIT, LS8-IB, LS8-WS, quick reference card and operator's manual.                     | 1              |
| <b>LS8E-KIT</b>      | Includes LS8E printer, one cassette of S100X150VAC self-laminating labels, six AA alkaline batteries, LS8-CASE, LS8-PCKIT, LS8-IB, LS8-WS, quick reference card and operator's manual.                               | 1              |
| <b>LS8E</b>          | Includes LS8E printer, one cassette of S100X150VAC self-laminating labels, six AA alkaline batteries and quick reference card.   | 1              |
| <b>LS8E-ACS*</b>     | 120 VAC power adapter for North America.   | 1              |
| <b>LS8-CASE</b>      | Rigid carrying case.   | 1              |
| <b>LS8-PCKIT</b>     | Includes USB cable and PC interface software for importing data, system upgrades, or printing from a wireless laptop or desktop computer.  | 1              |
| <b>LS8-IB</b>        | Protective impact bumper.  | 1              |
| <b>LS8-WS</b>        | Wrist strap.   | 1              |
| <b>LS8-CLN</b>       | LS8/LS8E cleaning kit – contains bottle of cleaning solution with MSDS, cleaning pen, swabs, alcohol wipes and cleaning instructions.  | 1              |

\*Cannot be used to charge batteries.

Other adapters available, replace S with A (Australia), C (China), E (Europe) and U (UK).

## Cougar™ LS9 Hand-Held Thermal Transfer Printer and Accessories

- Economical identification system provides premium quality solutions at the lowest installed cost
- Cut-to-length functionality eliminates label waste and label trimming labor
- Partial cut feature available to provide tear-apart strips of labels
- P1™ Label Cassette contains an integrated memory device for automatic formatting, recall of last legend used, and number of labels remaining in the cassette
- Prints continuous military grade heat shrink tubing
- Prints a wide variety of continuous tapes for marking of wire marking, component labeling, and safety/facility identification
- Fast loading label cassette includes both label material and ribbon to make changing labels easy



LS9Q

| Part Number     | Part Description  | Std. Pkg. Qty. |
|-----------------|---|----------------|
| <b>LS9Q</b>     | Includes LS9Q printer with QWERTY keypad, one cassette of T100X000C1C-BK continuous nylon cloth tape, six AA alkaline batteries and quick reference card. | 1              |
| <b>LS9</b>      | Includes LS9 printer, one cassette of T100X000VPC-BK continuous vinyl tape, six AA alkaline batteries and quick reference card.                           | 1              |
| <b>LS9-ACS*</b> | 120 VAC power adapter for North America.  | 1              |
| <b>LS9-CASE</b> | Rigid carrying case.  | 1              |
| <b>LS9-IB</b>   | Protective impact bumper.   | 1              |
| <b>LS9-WS</b>   | Wrist strap.  | 1              |
| <b>LS9-CLN</b>  | Cleaning kit.   | 1              |

\*Cannot be used to charge batteries.

Other adapters available, replace S with A (Australia), C (China), E (Europe) and U (UK).

B1. Cable Ties

B2. Cable Accessories

B3. Stainless Steel Ties

C1. Wiring Duct

C2. Surface Raceway

C3. Abrasion Protection

C4. Cable Management

D1. Terminals

D2. Power Connectors

D3. Grounding Connectors

E1. Labeling Systems

E2. Labels

E3. Pre-Printed & Write-On Markers

E4. Permanent Identification

E5. Lockout/Tagout & Safety Solutions

F. Index

## PANDUIT® Hand-Held Thermal Transfer Printing Solutions



PanTher™ LS8E



Cougar™ LS9

|                               |            |            |
|-------------------------------|------------|------------|
| Self-Laminating Labels        | Page E1.3  |            |
| Die-Cut Vinyl Cloth Labels    | Page E1.6  |            |
| Turn-Tell™ Labels             | Page E1.6  |            |
| Marker Plates                 | Page E1.7  |            |
| Flag Labels                   | Page E1.7  |            |
| Die-Cut Heat Shrink Tubing    | Page E1.9  |            |
| Die-Cut Component Labels      | Page E1.10 |            |
| Vinyl Cloth Continuous Tapes  | Page E1.5  | Page E1.5  |
| Nylon Cloth Continuous Tapes  | Page E1.5  | Page E1.5  |
| Continuous Heat Shrink Tubing | Page E1.8  | Page E1.8  |
| Continuous Tapes              | Page E1.11 | Page E1.11 |
| Continuous Reflective Tapes   | Page E1.12 | Page E1.12 |

### P1™ Self-Laminating Label Cassettes for PanTher™ LS8E Hand-Held Thermal Transfer Printer

- P1™ Label Cassette contains an integrated memory device for automatic formatting, recall of last legend used, and number of labels remaining in the cassette
- Fast loading label cassette includes both label material and ribbon to make changing labels easy
- Self-laminating adhesive labels for wire/cable identification include a colored print-on area and clear overlamine
- Labels are available in a large range of wire/cable sizes



### Part Number System for Wire/Cable Labeling

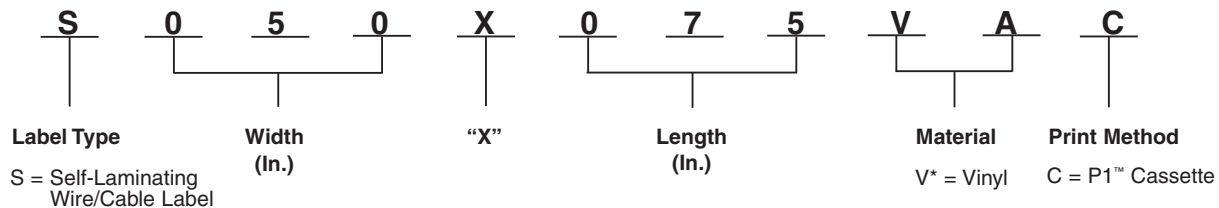

### Material/Print Method Selection Chart

| Material                                   | Print Method | Temperature Range                  | Features   |
|--|--------------|------------------------------------|--|
| Self-Laminating Vinyl, White Print-On (V*) | P1™ Cassette | -50°F to 225°F<br>(-45°C to 107°C) | Indoor/outdoor rated; thin and conformable; preferred material for most general wire/cable labeling. |

Table continues on page E1.4



A.  
System  
Overview

## P1™ Self-Laminating Label Cassettes for PanTher™ LS8E Hand-Held Thermal Transfer Printer (continued)

B1.  
Cable Ties

B2.  
Cable  
Accessories

B3.  
Stainless  
Steel Ties

C1.  
Wiring  
Duct

C2.  
Surface  
Raceway

C3.  
Abrasion  
Protection

C4.  
Cable  
Management

D1.  
Terminals

D2.  
Power  
Connectors

D3.  
Grounding  
Connectors

E1.  
Labeling  
Systems

E2.  
Labels

E3.  
Pre-Printed  
& Write-On  
Markers

E4.  
Permanent  
Identification

E5.  
Lockout/  
Tagout  
& Safety  
Solutions

F.  
Index

| Part Number        | Part Description   | Width |       | Length |        | Print-On Height |       | Min. Cable O.D. |       | Max. Cable O.D. |       | Std. Pkg. Qty. | Std. Ctn. Qty. |
|--------------------|--|-------|-------|--------|--------|-----------------|-------|-----------------|-------|-----------------|-------|----------------|----------------|
|                    |  | In.   | mm    | In.    | mm     | In.             | mm    | In.             | mm    | In.             | mm    |                |                |
| <b>S050X075VAC</b> | White print-on area, vinyl label for 18 – 14 AWG wires, 450/cassette.      | .50   | 12.70 | 0.75   | 19.05  | 0.25            | 6.35  | 0.08            | 2.02  | 0.16            | 4.04  | 1              | 10             |
| <b>S050X125VAC</b> | White print-on area, vinyl label for 12 – 10 AWG wires, 225/cassette.      | .50   | 12.70 | 1.25   | 31.75  | 0.38            | 9.65  | 0.12            | 3.07  | 0.28            | 7.03  | 1              | 10             |
| <b>S050X150VAC</b> | White print-on area, vinyl label for Cat. 5e/Cat. 6 cables, 200/cassette.  | .50   | 12.70 | 1.50   | 38.10  | 0.50            | 12.70 | 0.16            | 4.04  | 0.32            | 8.09  | 1              | 10             |
| <b>S075X075VAC</b> | White print-on area, vinyl label for 18 – 14 AWG wires, 350/cassette.      | .75   | 19.05 | 0.75   | 19.05  | 0.25            | 6.35  | 0.08            | 2.02  | 0.16            | 4.04  | 1              | 10             |
| <b>S075X100VAC</b> | White print-on area, vinyl label for 12 – 10 AWG wires, 275/cassette.      | .75   | 19.05 | 1.00   | 25.40  | 0.38            | 9.65  | 0.12            | 3.05  | 0.20            | 5.08  | 1              | 10             |
| <b>S075X125VAC</b> | White print-on area, vinyl label for 12 – 10 AWG wires, 225/cassette.      | .75   | 19.05 | 1.25   | 31.75  | 0.38            | 9.65  | 0.12            | 3.07  | 0.28            | 7.03  | 1              | 10             |
| <b>S075X150VAC</b> | White print-on area, vinyl label for Cat. 5e/Cat. 6 cables, 200/cassette.  | .75   | 19.05 | 1.50   | 38.10  | 0.50            | 12.70 | 0.16            | 4.04  | 0.32            | 8.09  | 1              | 10             |
| <b>S100X075VAC</b> | White print-on area, vinyl label for 18 – 14 AWG wires, 350/cassette.      | 1.00  | 25.40 | 0.75   | 19.05  | 0.25            | 6.35  | 0.08            | 2.02  | 0.16            | 4.04  | 1              | 10             |
| <b>S100X125VAC</b> | White print-on area, vinyl label for 12 – 10 AWG wires, 225/cassette.      | 1.00  | 25.40 | 1.25   | 31.75  | 0.38            | 9.65  | 0.12            | 3.07  | 0.28            | 7.03  | 1              | 10             |
| <b>S100X150VAC</b> | White print-on area, vinyl label for Cat. 5e/Cat. 6 cables, 200/cassette.  | 1.00  | 25.40 | 1.50   | 38.10  | 0.50            | 12.70 | 0.16            | 4.04  | 0.32            | 8.09  | 1              | 10             |
| <b>S100X150VBC</b> | Blue print-on area, vinyl label for Cat. 5e/Cat. 6 cables, 200/cassette.   | 1.00  | 25.40 | 1.50   | 38.10  | 0.50            | 12.70 | 0.16            | 4.04  | 0.32            | 8.09  | 1              | 10             |
| <b>S100X150VDC</b> | Green print-on area, vinyl label for Cat. 5e/Cat. 6 cables, 200/cassette.  | 1.00  | 25.40 | 1.50   | 38.10  | 0.50            | 12.70 | 0.16            | 4.04  | 0.32            | 8.09  | 1              | 10             |
| <b>S100X150VHC</b> | Red print-on area, vinyl label for Cat. 5e/Cat. 6 cables, 200/cassette.    | 1.00  | 25.40 | 1.50   | 38.10  | 0.50            | 12.70 | 0.16            | 4.04  | 0.32            | 8.09  | 1              | 10             |
| <b>S100X150VIC</b> | Yellow print-on area, vinyl label for Cat. 5e/Cat. 6 cables, 200/cassette. | 1.00  | 25.40 | 1.50   | 38.10  | 0.50            | 12.70 | 0.16            | 4.04  | 0.32            | 8.09  | 1              | 10             |
| <b>S100X225VAC</b> | White print-on area, vinyl label for 8 – 4 AWG wires, 125/cassette.        | 1.00  | 25.40 | 2.25   | 57.15  | 0.75            | 19.05 | 0.24            | 6.06  | 0.48            | 12.19 | 1              | 10             |
| <b>S100X225VBC</b> | Blue print-on area, vinyl label for 8 – 4 AWG wires, 125/cassette.         | 1.00  | 25.40 | 2.25   | 57.15  | 0.75            | 19.05 | 0.24            | 6.06  | 0.48            | 12.19 | 1              | 10             |
| <b>S100X225VDC</b> | Green print-on area, vinyl label for 8 – 4 AWG wires, 125/cassette.        | 1.00  | 25.40 | 2.25   | 57.15  | 0.75            | 19.05 | 0.24            | 6.06  | 0.48            | 12.19 | 1              | 10             |
| <b>S100X225VHC</b> | Red print-on area, vinyl label for 8 – 4 AWG wires, 125/cassette.          | 1.00  | 25.40 | 2.25   | 57.15  | 0.75            | 19.05 | 0.24            | 6.06  | 0.48            | 12.19 | 1              | 10             |
| <b>S100X225VIC</b> | Yellow print-on area, vinyl label for 8 – 4 AWG wires, 125/cassette.       | 1.00  | 25.40 | 2.25   | 57.15  | 0.75            | 19.05 | 0.24            | 6.06  | 0.48            | 12.19 | 1              | 10             |
| <b>S100X400VAC</b> | White print-on area, vinyl label for 2 – 1 AWG wires, 75/cassette.         | 1.00  | 25.40 | 4.00   | 101.60 | 1.00            | 25.40 | 0.32            | 8.09  | 0.95            | 24.26 | 1              | 10             |
| <b>S100X650VAC</b> | White print-on area, vinyl label for 1/0 – 250 MCM wires, 50/cassette.     | 1.00  | 25.40 | 6.50   | 165.10 | 1.50            | 38.10 | 0.48            | 12.19 | 1.59            | 40.39 | 1              | 10             |

Order number of cassettes required.

Other colors available, replace A with B (Blue), D (Green), H (Red) and I (Yellow).



## P1™ Non-Laminated Label Cassettes

- P1™ Label Cassette contains an integrated memory device for automatic formatting, recall of last legend used, and number of labels remaining in the cassette

- Fast loading label cassette includes both label material and ribbon to make changing labels easy
- Non-laminated adhesive labels for wire/cable identification



## Part Number System for Wire/Cable Labeling

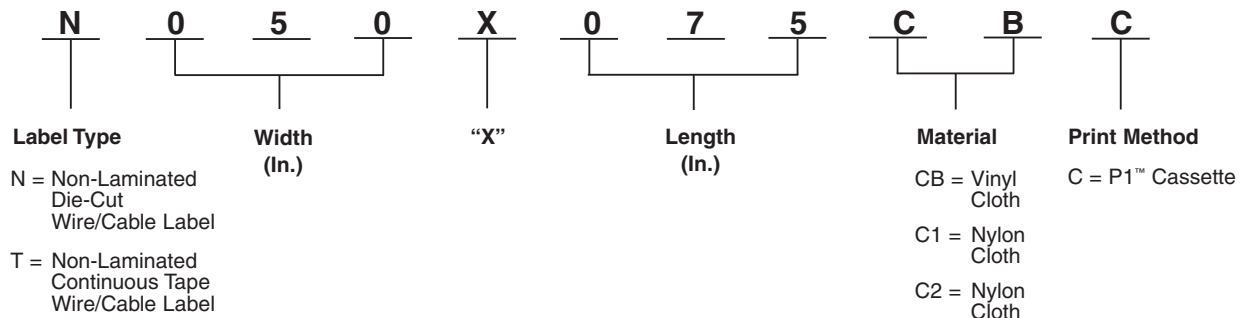

### Material/Print Method Selection Chart

| Material   | Print Method | Temperature Range                  | Features   |
|--|--------------|------------------------------------|--|
| Vinyl Cloth<br>White Print-On (CB)                         | P1™ Cassette | 50°F to 170°F<br>(10°C to 77°C)    | General purpose material, vinyl impregnated cloth resists oil and abrasion; material can be removed, repositioned, and reused. |
| Nylon Cloth<br>White Print-On (C1)<br>Yellow Print-On (C2) |              | -40°F to 285°F<br>(-40°C to 140°C) | General purpose material for wire and cable marking as well as flat surfaces; superior legibility; not repositionable.         |

| Part Number  | Part Description                         | Height |      | Length |     | Std. Pkg. Qty. | Std. Ctn. Qty. |
|--|--|--------|------|--------|-----|----------------|----------------|
|  |  | In.    | mm   | Ft.    | m   |                |                |
| <b>Continuous – For Use in PanTher™ LS8E and Cougar™ LS9 Hand-Held Thermal Transfer Printers</b> |  |        |      |        |     |                |                |
| T050X000CBC-BK   | Black on white, vinyl cloth tape.        | 0.50   | 12.7 | 12.5   | 3.8 | 1              | 10             |
| T100X000CBC-BK   | Black on white, vinyl cloth tape.        | 1.00   | 25.4 | 12.5   | 3.8 | 1              | 10             |
| T038X000C1C-BK   | Black on white, nylon cloth label tape.  | 0.38   | 9.7  | 18.0   | 5.5 | 1              | 10             |
| T038X000C2C-BK   | Black on yellow, nylon cloth label tape. | 0.38   | 9.7  | 18.0   | 5.5 | 1              | 10             |
| T050X000C1C-BK   | Black on white, nylon cloth label tape.  | 0.50   | 12.7 | 18.0   | 5.5 | 1              | 10             |
| T050X000C2C-BK   | Black on yellow, nylon cloth label tape. | 0.50   | 12.7 | 18.0   | 5.5 | 1              | 10             |
| T075X000C1C-BK   | Black on white, nylon cloth label tape.  | 0.75   | 19.1 | 18.0   | 5.5 | 1              | 10             |
| T075X000C2C-BK   | Black on yellow, nylon cloth label tape. | 0.75   | 19.1 | 18.0   | 5.5 | 1              | 10             |
| T100X000C1C-BK   | Black on white, nylon cloth label tape.  | 1.00   | 25.4 | 18.0   | 5.5 | 1              | 10             |
| T100X000C2C-BK   | Black on yellow, nylon cloth label tape. | 1.00   | 25.4 | 18.0   | 5.5 | 1              | 10             |

Table continues on page E1.6

A. System Overview

## P1™ Non-Laminated Label Cassettes (continued)

B1. Cable Ties

| Part Number   | Part Description   | Width |       | Length |       | Min. Cable O.D. |       | Max. Cable O.D. |       | Std. Pkg. Qty. | Std. Ctn. Qty. |
|---|--|-------|-------|--------|-------|-----------------|-------|-----------------|-------|----------------|----------------|
|   |  | In.   | mm    | In.    | mm    | In.             | mm    | In.             | mm    |                |                |
| <b>Die-Cut – For Use in PanTher™ LS8E Hand-Held Thermal Transfer Printers</b> |  |       |       |        |       |                 |       |                 |       |                |                |
| <b>N050X075CBC</b>  | White, perforated vinyl cloth label for 18 – 14 AWG wires, 125/cassette.   | .50   | 12.70 | .75    | 19.05 | .24             | 6.10  | .51             | 12.95 | 1              | 10             |
| <b>N050X150CBC</b>  | White, perforated vinyl cloth label for Cat. 5e/Cat. 6 cable, 75/cassette. | .50   | 12.70 | 1.50   | 38.10 | .48             | 12.19 | 1.02            | 25.91 | 1              | 10             |
| <b>N100X125CBC</b>  | White, perforated vinyl cloth label for 12 – 10 AWG wires, 75/cassette.    | 1.00  | 25.40 | 1.25   | 31.75 | .40             | 10.16 | .85             | 21.59 | 1              | 10             |
| <b>N100X150CBC</b>  | White, vinyl cloth label for Cat. 5e/Cat. 6 cable, 75/cassette.            | 1.00  | 25.40 | 1.50   | 38.10 | .48             | 12.19 | 1.02            | 25.91 | 1              | 10             |
| <b>N100X175CBC</b>  | White, perforated vinyl cloth label for 8 – 4 AWG wires, 50/cassette.      | 1.00  | 25.40 | 1.75   | 44.45 | .56             | 14.22 | 1.19            | 30.23 | 1              | 10             |

Order number of rolls required.

C2. Surface Raceway



## P1™ Turn-Tell™ Label Cassettes for PanTher™ LS8E Hand-Held Thermal Transfer Printer

C3. Abrasion Protection

- Fast loading P1™ Label Cassette includes both label material and ribbon to make changing labels easy
- Innovative label design allows labels to rotate for visibility from any angle, and for repositioning on the wire/cable to align legends and improve aesthetics

- Labels can be easily installed on existing terminated wires and assemblies without disconnecting the wires/cables
- Temperature range: -40°F to 200°F (-40°C to 93°C)

C4. Cable Management



D1. Terminals

D2. Power Connectors

D3. Grounding Connectors

## Part Number System for Wire/Cable Labeling

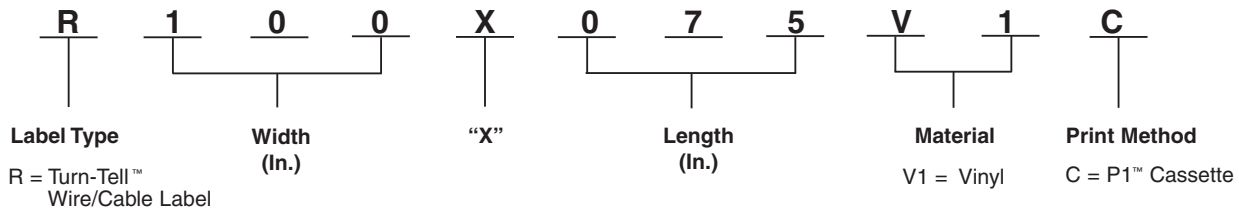

E1. Labeling Systems

E2. Labels

E3. Pre-Printed & Write-On Markers

E4. Permanent Identification

E5. Lockout/Tagout & Safety Solutions

| Part Number        | Part Description                                      | Width |      | Length |      | Print-On Area Height |      | Min. Cable O.D. |     | Max. Wire O.D. |     | Std. Pkg. Qty. | Std. Ctn. Qty. |
|--------------------|---|-------|------|--------|------|----------------------|------|-----------------|-----|----------------|-----|----------------|----------------|
|                    |   | In.   | mm   | In.    | mm   | In.                  | mm   | In.             | mm  | In.            | mm  |                |                |
| <b>R100X075V1C</b> | White print-on, 18 – 14 AWG wire/cable, 150/cassette. | 1.00  | 25.4 | 0.75   | 19.1 | 0.25                 | 6.4  | 0.12            | 3.1 | 0.16           | 4.1 | 1              | 10             |
| <b>R100X125V1C</b> | White print-on, 12 – 10 AWG wire/cable, 100/cassette. | 1.00  | 25.4 | 1.25   | 31.8 | 0.38                 | 9.7  | 0.16            | 4.1 | 0.22           | 5.6 | 1              | 10             |
| <b>R100X150V1C</b> | White print-on, Cat. 5/5e/6 cable, 100/cassette.      | 1.00  | 25.4 | 1.50   | 38.1 | 0.50                 | 12.7 | 0.22            | 5.6 | 0.28           | 7.1 | 1              | 10             |
| <b>R100X225V1C</b> | White print-on, 8 – 4 AWG wire/cable, 75/cassette.    | 1.00  | 25.4 | 2.25   | 57.2 | 0.75                 | 19.1 | 0.28            | 7.1 | 0.39           | 9.9 | 1              | 10             |

Order number of cassettes required.

F. Index

## P1™ Marker Plate Label Cassettes for PanTher™ LS8E Hand-Held Thermal Transfer Printer

- Fast loading P1™ Label Cassette includes both label material and ribbon to make changing labels easy
- Marker plates are designed for use on larger diameter wire/cables and may be applied after all terminations are complete

- Meets requirements for MIL-STD-202F, Notice 12 Method 215J
- Temperature range: -40°F to 176°F (-40°C to 80°C)



### Part Number System for Wire/Cable Labeling

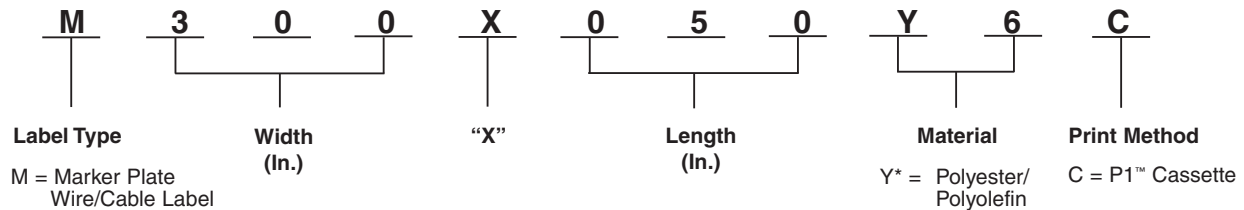

| Part Number | Color  | Width |      | Length |      | Print-On Area Width |      | Recommended Cable Tie |            | Std. Pkg. Qty. | Std. Ctn. Qty. |
|-------------|--------|-------|------|--------|------|---------------------|------|-----------------------|------------|----------------|----------------|
|             |        | In.   | mm   | In.    | mm   | In.                 | mm   | Vertical              | Horizontal |                |                |
| M300X050Y6C | Yellow | 3.00  | 76.2 | 0.50   | 12.7 | 1.80                | 45.7 | PLT2.5I-C             | PLT2.5I-C  | 1              | 10             |
| M300X050Y7C | White  | 3.00  | 76.2 | 0.50   | 12.7 | 1.80                | 45.7 | PLT2.5I-C             | PLT2.5I-C  | 1              | 10             |

Order number of cassettes required.

## P1™ Flag Label Cassettes for PanTher™ LS8E Hand-Held Thermal Transfer Printer

- Fast loading P1™ Label Cassette includes both label material and ribbon to make changing labels easy
- Provides larger labeling area for small cables

- Innovative design allows flag labels to be applied in either adhesive or non-adhesive orientations
- Temperature range: -40°F to 302°F (-40°C to 150°C)



### Part Number System for Wire/Cable Labeling

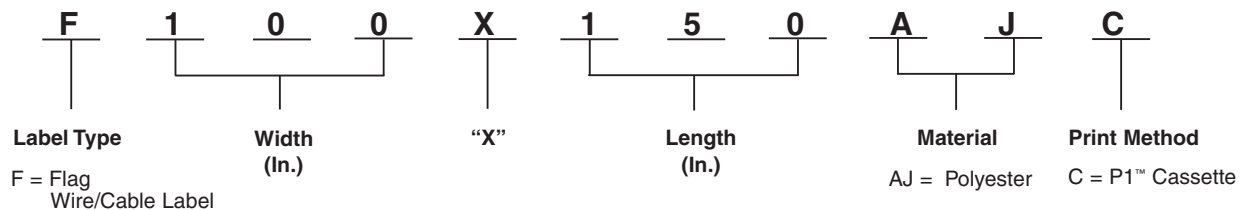

| Part Number | Width |      | Length |      | Min. Cable O.D. |     | Max. Wire O.D. |     | Std. Pkg. Qty. | Std. Ctn. Qty. |
|-------------|-------|------|--------|------|-----------------|-----|----------------|-----|----------------|----------------|
|             | In.   | mm   | In.    | mm   | In.             | mm  | In.            | mm  |                |                |
| F100X150AJC | 1.00  | 25.4 | 1.50   | 38.1 | 0.12            | 3.1 | 0.20           | 5.1 | 1              | 10             |

Order number of cassettes required.

A. System Overview

## P1™ Military Grade Continuous Heat Shrink Label Cassettes for PanTher™ LS8E or Cougar™ LS9 Hand-Held Thermal Transfer Printers

B1. Cable Ties

- P1™ Label Cassette contains an integrated memory device for automatic formatting, recall of last legend used, and number of labels remaining in the cassette
- Fast loading label cassette includes both label material and ribbon to make changing labels easy

- Meets print performance requirements of MIL-M-81531 and MIL-STD-202F Method 215A, Solution A, C, and D
- Meets UL Standard 224 for flammability
- Shrink ratio 3:1
- Each cassette contains a continuous roll of non-adhesive flattened polyolefin that can be cut-to-length

B2. Cable Accessories

B3. Stainless Steel Ties



C1. Wiring Duct

C2. Surface Raceway

C3. Abrasion Protection

### Part Number System for Wire/Cable Labeling

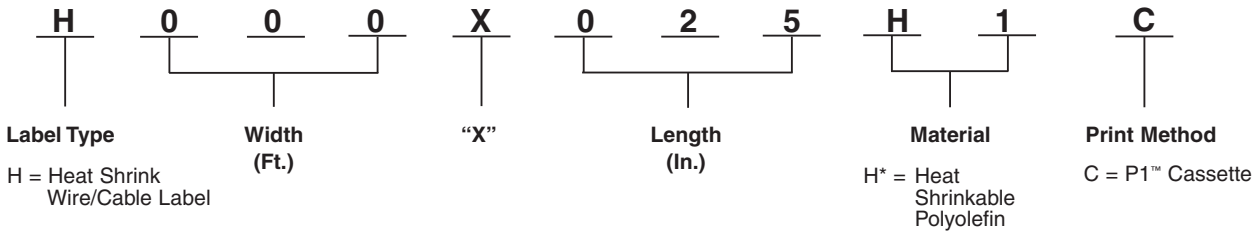

C4. Cable Management

D1. Terminals

D2. Power Connectors

### Material/Print Method Selection Chart

| Material                               | Print Method | Temperature Range                  | Features  |
|--|--------------|------------------------------------|---|
| Heat Shrinkable Polyolefin, White (H*) | P1™ Cassette | -67°F to 275°F<br>(-55°C to 135°C) | Durable flattened polyolefin, high quality heat shrink wire/cable labels. |

D3. Grounding Connectors

E1. Labeling Systems

| Part Number        | Part Description  | Width |      | Length |     | Min. Cable Diameter |     | Max. Cable Diameter |      | Std. Pkg. Qty. | Std. Ctn. Qty. |
|--------------------|---|-------|------|--------|-----|---------------------|-----|---------------------|------|----------------|----------------|
|                    |   | In.   | mm   | Ft.    | m   | In.                 | mm  | In.                 | mm   |                |                |
| <b>H000X025H1C</b> | White, 1/8" diameter heat shrinkable polyolefin, 22 – 16 AWG.   | 0.25  | 6.4  | 8.0    | 2.4 | 0.04                | 1.0 | 0.13                | 3.3  | 1              | 10             |
| <b>H000X025H2C</b> | Yellow, 1/8" diameter heat shrinkable polyolefin, 22 – 16 AWG.  | 0.25  | 6.4  | 8.0    | 2.4 | 0.04                | 1.0 | 0.13                | 3.3  | 1              | 10             |
| <b>H000X034H1C</b> | White, 3/16" diameter heat shrinkable polyolefin, 18 – 12 AWG.  | 0.34  | 8.6  | 8.0    | 2.4 | 0.06                | 1.5 | 0.19                | 4.8  | 1              | 10             |
| <b>H000X034H2C</b> | Yellow, 3/16" diameter heat shrinkable polyolefin, 18 – 12 AWG. | 0.34  | 8.6  | 8.0    | 2.4 | 0.06                | 1.5 | 0.19                | 4.8  | 1              | 10             |
| <b>H000X044H1C</b> | White, 1/4" diameter heat shrinkable polyolefin, 16 – 10 AWG.   | 0.44  | 11.2 | 6.0    | 1.8 | 0.08                | 2.0 | 0.25                | 6.4  | 1              | 10             |
| <b>H000X044H2C</b> | Yellow, 1/4" diameter heat shrinkable polyolefin, 16 – 10 AWG.  | 0.44  | 11.2 | 6.0    | 1.8 | 0.08                | 2.0 | 0.25                | 6.4  | 1              | 10             |
| <b>H000X064H1C</b> | White, 3/8" diameter heat shrinkable polyolefin, 12 – 6 AWG.    | 0.64  | 16.3 | 6.0    | 1.8 | 0.13                | 3.3 | 0.38                | 9.7  | 1              | 10             |
| <b>H000X064H2C</b> | Yellow, 3/8" diameter heat shrinkable polyolefin, 12 – 6 AWG.   | 0.64  | 16.3 | 6.0    | 1.8 | 0.13                | 3.3 | 0.38                | 9.7  | 1              | 10             |
| <b>H000X084H1C</b> | White, 1/2" diameter heat shrinkable polyolefin, 8 – 1 AWG.     | 0.84  | 21.3 | 6.0    | 1.8 | 0.17                | 4.3 | 0.50                | 12.7 | 1              | 10             |
| <b>H000X084H2C</b> | Yellow, 1/2" diameter heat shrinkable polyolefin, 8 – 1 AWG.    | 0.84  | 21.3 | 6.0    | 1.8 | 0.17                | 4.3 | 0.50                | 12.7 | 1              | 10             |

E2. Labels

E3. Pre-Printed & Write-On Markers

E4. Permanent Identification

E5. Lockout/Tagout & Safety Solutions

F. Index

Order number of cassettes required.

## P1™ Military Grade Die-Cut Heat Shrink Label Cassettes for PanTher™ LS8E Hand-Held Thermal Transfer Printer

- P1™ Label Cassette contains an integrated memory device for automatic formatting, recall of last legend used, and number of labels remaining in the cassette
- Fast loading label cassette includes both label material and ribbon to make changing labels easy
- Meets print performance requirements of MIL-M-81531 and MIL-STD-202F Method 215A, Solution A, C, and D
- Meets UL Standard 224 for flammability
- Shrink ratio 3:1
- Each cassette contains a roll of die-cut non-adhesive flattened polyolefin

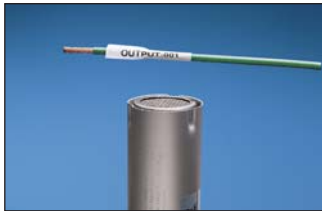

### Part Number System for Wire/Cable Labeling

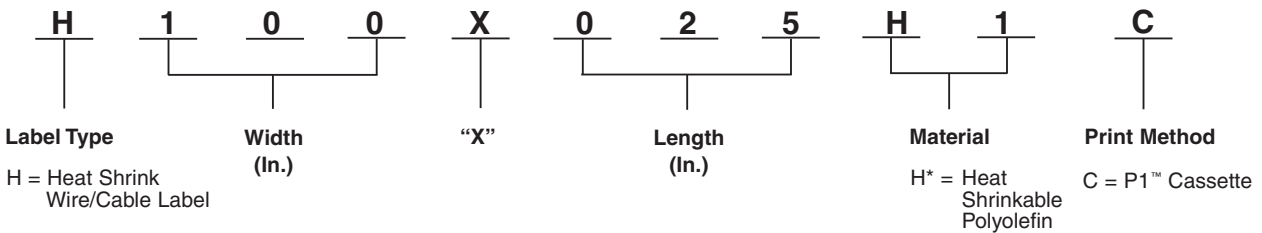

### Material/Print Method Selection Chart

| Material                        | Print Method | Temperature Range               | Features  |
|---------------------------------|--------------|---------------------------------|---|
| Heat Shrinkable Polyolefin (H*) | P1™ Cassette | -67°F to 275°F (-55°C to 135°C) | Durable flattened polyolefin, high quality heat shrink wire/cable labels. |

| Part Number | Part Description  | Width |      | Length |      | Min. Cable Diameter |     | Max. Cable Diameter |      | Std. Pkg. Qty. | Std. Ctn. Qty. |
|-------------|---|-------|------|--------|------|---------------------|-----|---------------------|------|----------------|----------------|
|             |   | In.   | mm   | In.    | mm   | In.                 | mm  | In.                 | mm   |                |                |
| H100X025H1C | White, 1/8" diameter heat shrinkable polyolefin, 22 – 16 AWG, 100/cassette.   | 0.25  | 6.4  | 1.00   | 25.4 | 0.04                | 1.0 | 0.13                | 3.3  | 1              | 10             |
| H100X025H2C | Yellow, 1/8" diameter heat shrinkable polyolefin, 22 – 16 AWG, 100/cassette.  | 0.25  | 6.4  | 1.00   | 25.4 | 0.04                | 1.0 | 0.13                | 3.3  | 1              | 10             |
| H100X034H1C | White, 3/16" diameter heat shrinkable polyolefin, 18 – 12 AWG, 100/cassette.  | 0.34  | 8.6  | 1.00   | 25.4 | 0.06                | 1.5 | 0.19                | 4.8  | 1              | 10             |
| H100X034H2C | Yellow, 3/16" diameter heat shrinkable polyolefin, 18 – 12 AWG, 100/cassette. | 0.34  | 8.6  | 1.00   | 25.4 | 0.06                | 1.5 | 0.19                | 4.8  | 1              | 10             |
| H100X044H1C | White, 1/4" diameter heat shrinkable polyolefin, 16 – 10 AWG, 100/cassette.   | 0.44  | 11.2 | 1.00   | 25.4 | 0.08                | 2.0 | 0.25                | 6.4  | 1              | 10             |
| H100X044H2C | Yellow, 1/4" diameter heat shrinkable polyolefin, 16 – 10 AWG, 100/cassette.  | 0.44  | 11.2 | 1.00   | 25.4 | 0.08                | 2.0 | 0.25                | 6.4  | 1              | 10             |
| H100X064H1C | White, 3/8" diameter heat shrinkable polyolefin, 12 – 6 AWG, 75/cassette.     | 0.64  | 16.3 | 1.00   | 25.4 | 0.13                | 3.3 | 0.38                | 9.7  | 1              | 10             |
| H100X064H2C | Yellow, 3/8" diameter heat shrinkable polyolefin, 12 – 6 AWG, 75/cassette.    | 0.64  | 16.3 | 1.00   | 25.4 | 0.13                | 3.3 | 0.38                | 9.7  | 1              | 10             |
| H100X084H1C | White, 1/2" diameter heat shrinkable polyolefin, 8 – 1 AWG, 75/cassette.      | 0.84  | 21.3 | 1.00   | 25.4 | 0.17                | 4.3 | 0.50                | 12.7 | 1              | 10             |
| H100X084H2C | Yellow, 1/2" diameter heat shrinkable polyolefin, 8 – 1 AWG, 75/cassette.     | 0.84  | 21.3 | 1.00   | 25.4 | 0.17                | 4.3 | 0.50                | 12.7 | 1              | 10             |

Order number of cassettes required.

A. System Overview

## P1™ General Component Label Cassettes for PanTher™ LS8E Hand-Held Thermal Transfer Printers

B1. Cable Ties

B2. Cable Accessories

B3. Stainless Steel Ties

C1. Wiring Duct

C2. Surface Raceway

C3. Abrasion Protection

C4. Cable Management

D1. Terminals

D2. Power Connectors

D3. Grounding Connectors

E1. Labeling Systems

E2. Labels

E3. Pre-Printed & Write-On Markers

E4. Permanent Identification

E5. Lockout/Tagout & Safety Solutions

F. Index

- P1™ Label Cassette contains an integrated memory device for automatic formatting, recall of last legend used, and number of labels remaining in the cassette
- Fast loading label cassette includes both label material and ribbon to make changing labels easy
- Use for identifying flat surfaces such as components, control panels, circuit boards and general labeling
- Die-cut labels designed to provide maximum aesthetic quality and appearance
- Available in polyester and vinyl cloth materials



### Part Number System for Component Labeling

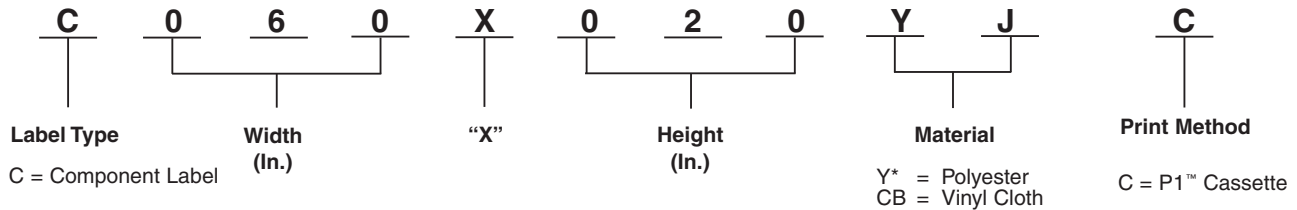

### Material/Print Method Selection Chart

| Material  | Print Method | Temperature Range                  | Features  |
|---|--------------|------------------------------------|---|
| Polyester, White (YJ)<br>Silver (YM)<br>SuperTack Polyester, White (YP) | P1™ Cassette | -40°F to 302°F<br>(-40°C to 150°C) | Indoor/outdoor rated; provides durability, high temperature resistance, and dimensional stability, does not stretch or easily tear. |
| Vinyl Cloth, White (CB)   |              | -50°F to 170°F<br>(10°C to 77°C)   | General purpose material, vinyl impregnated cloth resists oil and abrasion; material can be removed, repositioned, and reused.      |

| Part Number        | Part Description                                | Width |      | Height |      | Std. Pkg. Qty. | Std. Ctn. Qty. |
|--------------------|---|-------|------|--------|------|----------------|----------------|
|                    |   | In.   | mm   | In.    | mm   |                |                |
| <b>C060X020YJC</b> | White, polyester label, 750/cassette.           | 0.60  | 15.2 | 0.20   | 5.1  | 1              | 10             |
| <b>C100X025YJC</b> | White, polyester label, 500/cassette.           | 1.00  | 25.4 | 0.25   | 6.4  | 1              | 10             |
| <b>C100X050CBC</b> | White, vinyl cloth label, 175/cassette.         | 1.00  | 25.4 | 0.50   | 12.7 | 1              | 10             |
| <b>C100X050YJC</b> | White, polyester label, 500/cassette.           | 1.00  | 25.4 | 0.50   | 12.7 | 1              | 10             |
| <b>C100X050YMC</b> | Silver, polyester label, 500/cassette.          | 1.00  | 25.4 | 0.50   | 12.7 | 1              | 10             |
| <b>C150X075YJC</b> | White, polyester label, 250/cassette.           | 1.50  | 38.1 | 0.75   | 19.1 | 1              | 10             |
| <b>C200X050CBC</b> | White, vinyl cloth label, 50/cassette.          | 2.00  | 50.8 | 0.50   | 12.7 | 1              | 10             |
| <b>C200X050YJC</b> | White, polyester label, 200/cassette.           | 2.00  | 50.8 | 0.50   | 12.7 | 1              | 10             |
| <b>C200X100YJC</b> | White, polyester label, 200/cassette.           | 2.00  | 50.8 | 1.00   | 25.4 | 1              | 10             |
| <b>C200X100YMC</b> | Silver, polyester label, 150/cassette.          | 2.00  | 50.8 | 1.00   | 25.4 | 1              | 10             |
| <b>C200X100YPC</b> | White, high tack polyester label, 200/cassette. | 2.00  | 50.8 | 1.00   | 25.4 | 1              | 10             |

Order number of cassettes required.



## P1™ Continuous Tape Cassettes for PanTher™ LS8E and Cougar™ LS9 Hand-Held Thermal Transfer Printers

- P1™ Label Cassette contains an integrated memory device for automatic formatting, recall of last legend used, and number of labels remaining in the cassette
- Fast loading label cassette includes both label material and ribbon to make changing labels easy
- Print custom pipe markers, voltage markers, signs and bin marker labels on demand
- Available in a variety of colors, widths, and adhesive materials including continuous polyolefin, polyester, and vinyl
- For flat label applications only



### Part Number System for Continuous Tapes

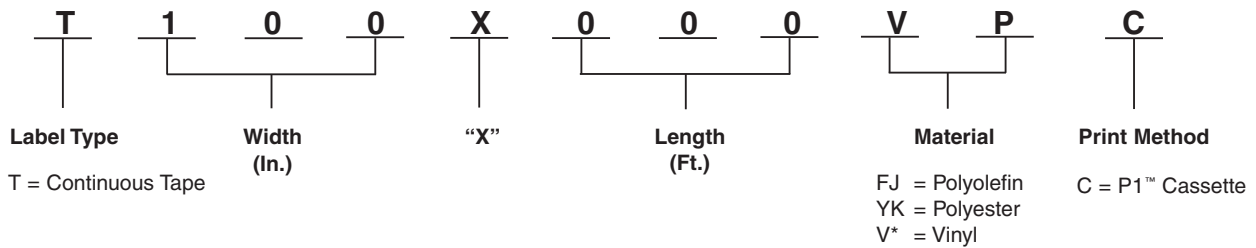

### Material/Print Method Selection Chart

| Material  | Print Method | Temperature Range                  | Features  |
|---|--------------|------------------------------------|---|
| Polyolefin, White (FJ)  | P1™ Cassette | -40°F to 180°F<br>(-40°C to 82°C)  | Indoor/outdoor rated; thin conformable material for general identification; excellent print quality.  |
| Polyester, Clear (YK)   |              | -40°F to 257°F<br>(-40°C to 125°C) | Indoor/outdoor rated; laminated label material protects legend from abrasion and chemicals; resistant to UV light chemical atmosphere and abrasion; excellent life and adhesion properties. |
| Polymer Film,<br>White (RP)<br>Orange (RU)<br>Yellow (RX)   |              | -40°F to 180°F<br>(-40°C to 82°C)  | Indoor/outdoor rated; heavy duty reflective material for flat applications and safety and facility identification; resistant to UV light, chemical atmosphere and abrasion.                 |
| Vinyl,<br>White (VP)<br>Blue (VQ)<br>Green (VS)<br>Orange (VU)<br>Red (VV)<br>Yellow (VX)<br>Black (VY) |              | -58°F to 176°F<br>(-50°C to 80°C)  | Indoor/outdoor rated; conformable material for flat applications and safety and facility identification; can be overlaminated to increase durability.                                       |

| Part Number    | Part Description                                       | Height |      | Length |     | Std. Pkg. Qty. | Std. Ctn. Qty. |
|----------------|--|--------|------|--------|-----|----------------|----------------|
|                |  | In.    | mm   | Ft.    | m   |                |                |
| T019X000FJC-BK | Black on white, polyolefin module label tape.          | .19    | 4.83 | 25.0   | 7.6 | 1              | 10             |
| T024X000FJC-BK | Black on white, polyolefin tape, terminal block label. | .24    | 6.10 | 25.0   | 7.6 | 1              | 10             |
| T031X000FJC-BK | Black on white, polyolefin tape, terminal block label. | .31    | 7.87 | 25.0   | 7.6 | 1              | 10             |
| T038X000FJC-BK | Black on white, polyolefin tape, terminal block label. | .38    | 9.65 | 25.0   | 7.6 | 1              | 10             |

Order number of cassettes required.

Table continues on page E1.12

A. System Overview

## P1™ Continuous Tape Cassettes for PanTher™ LS8E and Cougar™ LS9 Hand-Held Thermal Transfer Printers (continued)

B1. Cable Ties

| Part Number           | Part Description                | Height |       | Length |     | Std. Pkg. Qty. | Std. Ctn. Qty. |
|-----------------------|---------------------------------|--------|-------|--------|-----|----------------|----------------|
|                       |                                 | In.    | mm    | Ft.    | m   |                |                |
| <b>T038X000VPC-BK</b> | Black on white, vinyl tape.     | 0.38   | 9.65  | 25.0   | 7.6 | 1              | 10             |
| <b>T038X000VYC-WH</b> | White on black, vinyl tape.     | 0.38   | 9.65  | 25.0   | 7.6 | 1              | 10             |
| <b>T038X000YKC-BK</b> | Black on clear, polyester tape. | 0.38   | 9.65  | 25.0   | 7.6 | 1              | 10             |
| <b>T050X000VPC-BK</b> | Black on white, vinyl tape.     | 0.50   | 12.70 | 25.0   | 7.6 | 1              | 10             |
| <b>T050X000VQC-BK</b> | Black on blue, vinyl tape.      | 0.50   | 12.70 | 25.0   | 7.6 | 1              | 10             |
| <b>T050X000VQC-WH</b> | White on blue, vinyl tape.      | 0.50   | 12.70 | 25.0   | 7.6 | 1              | 10             |
| <b>T050X000VSC-BK</b> | Black on green, vinyl tape.     | 0.50   | 12.70 | 25.0   | 7.6 | 1              | 10             |
| <b>T050X000VSC-WH</b> | White on green, vinyl tape.     | 0.50   | 12.70 | 25.0   | 7.6 | 1              | 10             |
| <b>T050X000VUC-BK</b> | Black on orange, vinyl tape.    | 0.50   | 12.70 | 25.0   | 7.6 | 1              | 10             |
| <b>T050X000VWC-BK</b> | Black on red, vinyl tape.       | 0.50   | 12.70 | 25.0   | 7.6 | 1              | 10             |
| <b>T050X000VWC-WH</b> | White on red, vinyl tape.       | 0.50   | 12.70 | 25.0   | 7.6 | 1              | 10             |
| <b>T050X000VXC-BK</b> | Black on yellow, vinyl tape.    | 0.50   | 12.70 | 25.0   | 7.6 | 1              | 10             |
| <b>T050X000VYC-WH</b> | White on black, vinyl tape.     | 0.50   | 12.70 | 25.0   | 7.6 | 1              | 10             |
| <b>T050X000YKC-BK</b> | Black on clear, polyester tape. | 0.50   | 12.70 | 25.0   | 7.6 | 1              | 10             |
| <b>T050X000YKC-WH</b> | White on clear, polyester tape. | 0.50   | 12.70 | 25.0   | 7.6 | 1              | 10             |
| <b>T075X000VPC-BK</b> | Black on white, vinyl tape.     | 0.75   | 19.05 | 25.0   | 7.6 | 1              | 10             |
| <b>T075X000YKC-BK</b> | Black on clear, polyester tape. | 0.75   | 19.05 | 25.0   | 7.6 | 1              | 10             |
| <b>T100X000VPC-BK</b> | Black on white, vinyl tape.     | 1.00   | 25.40 | 25.0   | 7.6 | 1              | 10             |
| <b>T100X000VQC-BK</b> | Black on blue, vinyl tape.      | 1.00   | 25.40 | 25.0   | 7.6 | 1              | 10             |
| <b>T100X000VQC-WH</b> | White on blue, vinyl tape.      | 1.00   | 25.40 | 25.0   | 7.6 | 1              | 10             |
| <b>T100X000VSC-BK</b> | Black on green, vinyl tape.     | 1.00   | 25.40 | 25.0   | 7.6 | 1              | 10             |
| <b>T100X000VSC-WH</b> | White on green, vinyl tape.     | 1.00   | 25.40 | 25.0   | 7.6 | 1              | 10             |
| <b>T100X000VUC-BK</b> | Black on orange, vinyl tape.    | 1.00   | 25.40 | 25.0   | 7.6 | 1              | 10             |
| <b>T100X000VUC-WH</b> | White on orange, vinyl tape.    | 1.00   | 25.40 | 25.0   | 7.6 | 1              | 10             |
| <b>T100X000VWC-BK</b> | Black on red, vinyl tape.       | 1.00   | 25.40 | 25.0   | 7.6 | 1              | 10             |
| <b>T100X000VWC-WH</b> | White on red, vinyl tape.       | 1.00   | 25.40 | 25.0   | 7.6 | 1              | 10             |
| <b>T100X000VXC-BK</b> | Black on yellow, vinyl tape.    | 1.00   | 25.40 | 25.0   | 7.6 | 1              | 10             |
| <b>T100X000VXC-WH</b> | White on yellow, vinyl tape.    | 1.00   | 25.40 | 25.0   | 7.6 | 1              | 10             |
| <b>T100X000VYC-WH</b> | White on black, vinyl tape.     | 1.00   | 25.40 | 25.0   | 7.6 | 1              | 10             |
| <b>T100X000YKC-BK</b> | Black on clear, polyester tape. | 1.00   | 25.40 | 25.0   | 7.6 | 1              | 10             |
| <b>T100X000YKC-WH</b> | White on clear, polyester tape. | 1.00   | 25.40 | 25.0   | 7.6 | 1              | 10             |

Order number of cassettes required.

E1. Labeling Systems

## P1™ Continuous Reflective Tape Cassettes for PanTher™ LS8E and Cougar™ LS9 Hand-Held Thermal Transfer Printers

- Fast loading P1™ Label Cassette includes both label material and ribbon to make changing labels easy
- Reflective material improves label visibility in low light conditions
- For flat label applications only

E3. Pre-Printed & Write-On Markers

| Part Number           | Part Description                  | Height |      | Length |     | Std. Pkg. Qty. | Std. Ctn. Qty. |
|-----------------------|-----------------------------------|--------|------|--------|-----|----------------|----------------|
|                       |                                   | In.    | mm   | Ft.    | m   |                |                |
| <b>T100X000RPC-BK</b> | Black on white, reflective tape.  | 1.00   | 25.4 | 18.0   | 5.5 | 1              | 10             |
| <b>T100X000RUC-BK</b> | Black on orange, reflective tape. | 1.00   | 25.4 | 18.0   | 5.5 | 1              | 10             |
| <b>T100X000RXC-BK</b> | Black on yellow, reflective tape. | 1.00   | 25.4 | 18.0   | 5.5 | 1              | 10             |

Order number of cassettes required.

E5. Lockout/Tagout & Safety Solutions

F. Index

## TDP43MY Thermal Transfer Desktop Printer and Accessories

- Compact, lightweight design enables use in office or remote locations
- 300 dpi thermal transfer printer creates crisp, clear legends with superior legibility
- Up to 2.00 inches per second print speed for fast label production
- Use to print a wide variety of self-laminating labels, component labels, non-laminated labels, heat shrink labels, marker plates and continuous tapes up to 4.00 inches wide
- Easy-Mark™ Labeling Software and hybrid ribbon included with printer



| Part Number | Description   | Std. Pkg. Qty. |
|-------------|---|----------------|
| TDP43MY     | 300 dpi printer; includes printer, Panduit® Easy-Mark™ Labeling Software, RMH4BL hybrid black ribbon, AC power adapter with US and Europlug power cords, manual and quick start card. | 1              |
| TDP43ME-RS  | External label roll stand – used to rear feed labels that are supplied on 3.00" cores.  | 1              |
| TDP43M-CASE | Hardside carrying case. Accommodates printer, AC power adapter, ribbons, printer cable, labels and tools.   | 1              |
| TDP43M-ACY  | Replacement AC power adapter with power cord (US cord only).  | 1              |
| PTR-CLN     | Printer cleaning kit – contains bottle of cleaning solution with MSDS, cleaning pen, swabs, alcohol wipes and cleaning instructions.  | 1              |

## Ribbons for Use with the TDP43MY Thermal Transfer Desktop Printer

- **Hybrid** – Recommended for use with self-laminating, heat shrink, component and non-laminated labels
- **Wax** – Recommended for use with self-laminating and non-laminated labels
- **Resin** – Recommended for use with component labels, marker plates, and continuous tape



| Part Number | Part Description  | Height |       | Length |      | Std. Pkg. Qty. | Std. Ctn. Qty. |
|-------------|---|--------|-------|--------|------|----------------|----------------|
|             |   | In.    | mm    | Ft.    | m    |                |                |
| RMH2BL      | Black, hybrid thermal transfer ribbon. For use with self-laminating, component, heat shrink and non-laminated labels. | 2.52   | 63.5  | 240.00 | 73.0 | 1              | 12             |
| RMH4BL      | Black, hybrid thermal transfer ribbon. For use with self-laminating, component, heat shrink and non-laminated labels. | 4.33   | 110.0 | 240.00 | 73.0 | 1              | 12             |
| RMW2BL      | Black, wax thermal transfer ribbon. For use with self-laminating vinyl and non-laminated labels.                      | 2.52   | 63.5  | 240.00 | 73.0 | 1              | 12             |
| RMW4BL      | Black, wax thermal transfer ribbon. For use with self-laminating and non-laminated labels.                            | 4.33   | 110.0 | 240.00 | 73.0 | 1              | 12             |
| RMR2BL      | Black, resin thermal transfer ribbon. For use with component labels, marker plates, and continuous tape.              | 2.52   | 63.5  | 240.00 | 73.0 | 1              | 12             |
| RMR2WH      | White, resin thermal transfer ribbon. For use with component labels, marker plates, and continuous tape.              | 2.52   | 63.5  | 240.00 | 73.0 | 1              | 12             |
| RMR4BL*     | Black, resin thermal transfer ribbon. For use with component labels, marker plates, and continuous tape.              | 4.33   | 110.0 | 240.00 | 73.0 | 1              | 12             |
| RMR4BL-A    | Black, resin thermal transfer ribbon. For use with component labels, marker plates, and continuous tape.              | 4.33   | 110.0 | 240.0  | 73.0 | 1              | 12             |

Order number of ribbons required.

\*Other colors available, replace BL (Black) with WH (White), BU (Blue), GR (Green) or RD (Red).

A. System Overview

## TDP42HY, TDP43HY, TDP46HY Thermal Transfer Desktop Printers

B1. Cable Ties

- Rugged, high speed industrial printer
- 203, 305, or 609 dpi thermal transfer printers create crisp, clear legends with superior legibility
- Up to 10.00 inches per second print speed for fast label production
- Use to print a wide variety of self-laminating labels, component labels, non-laminated labels, marker plate, continuous tapes and heat shrink labels up to 4.00 inches wide
- Easy-Mark™ Labeling Software and hybrid ribbon included with printer

B2. Cable Accessories

B3. Stainless Steel Ties



| Part Number    | Part Description  | Std. Pkg. Qty. |
|----------------|---|----------------|
| <b>TDP42HY</b> | 203 dpi printer for high volume applications, Panduit® Easy-Mark™ Labeling Software, RHH4BL-S hybrid black ribbon, AC power adapter and manual. | 1              |
| <b>TDP43HY</b> | 305 dpi printer for high volume applications, Panduit® Easy-Mark™ Labeling Software, RHH4BL-S hybrid black ribbon, AC power adapter and manual. | 1              |
| <b>TDP46HY</b> | 609 dpi printer for high volume applications, Panduit® Easy-Mark™ Labeling Software, RHH4BL-S hybrid black ribbon, AC power adapter and manual. | 1              |

C1. Wiring Duct

C2. Surface Raceway

C3. Abrasion Protection

C4. Cable Management

D1. Terminals

## Ribbons for use with the TDP42HY, TDP43HY and TDP46HY Thermal Transfer Desktop Printers

D2. Power Connectors

- **Hybrid** – Recommended for use with self-laminating, heat shrink, component and non-laminated labels
- **Resin** – Recommended for use with component labels, marker plates, and continuous tape
- **Wax** – Recommended for use with self-laminating and non-laminated labels

D3. Grounding Connectors



| Part Number     | Part Description  | Height |        | Length |        | Std. Pkg. Qty. | Std. Ctn. Qty. |
|-----------------|---|--------|--------|--------|--------|----------------|----------------|
|                 |   | In.    | mm     | Ft.    | m      |                |                |
| <b>RHH4BL-S</b> | Black, hybrid thermal transfer ribbon. Recommended for use with self-laminating, heat shrink, component and non-laminated labels. | 4.33   | 109.98 | 1181.0 | 359.96 | 1              | 2              |
| <b>RHW4BL-S</b> | Black, wax thermal transfer ribbon. Recommended for use with self-laminating and non-laminated labels.                            | 4.33   | 109.98 | 1181.0 | 359.96 | 1              | 2              |
| <b>RHR4BL-S</b> | Black, resin thermal transfer ribbon. Recommended for use with component labels and continuous tape.                              | 4.33   | 109.98 | 1181.0 | 359.96 | 1              | 2              |

Order number of ribbons required.

E1. Labeling Systems

E2. Labels

E3. Pre-Printed & Write-On Markers

E4. Permanent Identification

E5. Lockout/Tagout & Safety Solutions

F. Index

## LABELING SOFTWARE

Panduit labeling software is custom designed to address your requirements for wire/cable labeling, component identification, network administration, as well as, safety and facility identification. From control panel wire identification, terminal block and facility pipe marking to patch panel, faceplate and wire/cable marking, Panduit software is the solution for your on-demand identification requirements.



- Easy-Mark™ Labeling Software is an easy-to-use, intuitive general purpose labeling software
- CAD-Connect™ Labeling Software generates labels quickly and easily directly from an electronic CAD file

Panduit user-friendly software packages meet the unique requirements of your applications.



A.  
System  
Overview

B1.  
Cable  
Ties

B2.  
Cable  
Accessories

B3.  
Stainless  
Steel Ties

C1.  
Wiring  
Duct

C2.  
Surface  
Raceway

C3.  
Abrasion  
Protection

C4.  
Cable  
Management

D1.  
Terminals

D2.  
Power  
Connectors

D3.  
Grounding  
Connectors

E1.  
Labeling  
Systems

E2.  
Labels

E3.  
Pre-Printed  
& Write-On  
Markers

E4.  
Permanent  
Identification

E5.  
Lockout/  
Tagout  
& Safety  
Solutions

F.  
Index

A.  
System  
Overview

## Easy-Mark™ Labeling Software

B1.  
Cable Ties

- Easy-Mark™ Labeling Software simplifies label creation for the specific needs of your applications

- Easy-Mark™ Labeling Software is part of a complete line of innovative identification solutions from Panduit

B2.  
Cable  
Accessories

- Instructions and user interface are available in English, French, German, Italian, Spanish, Korean, Japanese, Chinese and Portuguese

- Supports most WINDOWS^ fonts drivers for standard thermal transfer, dot matrix, laser and ink jet, including Panduit thermal transfer printers

B3.  
Stainless  
Steel Ties

- Intuitive interview process allows automatic generation of labels and signs
- Software selects and formats the optimum label for your specific application
- WYSIWYG (What You See Is What You Get) user interface, alpha/numeric serialization, data import, symbol import

### System Requirements:

- WINDOWS^ 2000, XP, Vista, or 7; 64MB hard drive space and 64MB RAM (256MB RAM recommended)

C1.  
Wiring  
Duct



| Part Number       | Part Description                                  | Std. Pkg. Qty. | Std. Ctn. Qty. |
|-------------------|---|----------------|----------------|
| <b>PROG-EMCD3</b> | Easy-Mark™ Labeling Software supplied on CD-ROM.  | 1              | 10             |
| <b>PROG-EM2GO</b> | Easy-Mark™ Portable Application, USB Flash Drive. | 1              | 10             |

^WINDOWS is a registered trademark of Microsoft Corporation in the United States and/or other countries.

C2.  
Surface  
Raceway

C3.  
Abrasion  
Protection

## CAD-Connect™ Labeling Software

C4.  
Cable  
Management

- Generates labels quickly and easily directly from electronic CAD files

- Exports to alternative formats such as EXCEL^ (XLS) or Text (CSV) files for future use and documentation

D1.  
Terminals

- Eliminates steps and time spent manually copying CAD identifiers into labeling software

### System Requirements:

- WINDOWS^ 2000, XP, Vista, or 7; 64MB hard drive space and 64MB RAM (256MB RAM recommended)

D2.  
Power  
Connectors

- Program combines the power of an innovative wizard interview and Easy-Mark™ Labeling Software to capture and organize identifiers from electronic CAD files to automatically create and print labels
- Compatible with full versions of AutoCAD\* 2000i, 2002, 2004, 2006, 2007; AutoCAD Electrical 2005 and 2006; AutoCAD Architectural 2007 and 2008; AutoCAD Mechanical 2007 and 2008; and Visio^ 2002 and newer versions

D3.  
Grounding  
Connectors



| Part Number      | Part Description  | Std. Pkg. Qty. | Std. Ctn. Qty. |
|------------------|---|----------------|----------------|
| <b>PROG-CCCD</b> | CAD-Connect™ Labeling Software, including Easy-Mark™ Labeling Software, supplied on CD-ROM. | 1              | 10             |

\*AutoCAD is a registered trademark of Autodesk, Inc.

^Visio, WINDOWS, and EXCEL are registered trademarks of Microsoft Corporation in the United States and/or other countries.

E1.  
Labeling  
Systems

E2.  
Labels

E3.  
Pre-Printed  
& Write-On  
Markers

E4.  
Permanent  
Identification

E5.  
Lockout/  
Tagout  
& Safety  
Solutions

F.  
Index



## LABELS: LASER, INK JET, AND THERMAL TRANSFER

Panduit provides a full line of on demand printable labels designed to meet all of your identification needs.



- Laser/ink jet labels supplied on 8.50" x 11.00" sheets and can be printed in commercially available laser and ink jet printers not sold by Panduit
- Thermal transfer labels supplied on rolls offer crisp, clear legends with superior legibility and can be printed on Panduit thermal transfer desktop printers or commercially available models
- Size illustrations are provided for reference

Panduit labeling solutions meet customer needs at the lowest total installed cost.



A.  
System  
Overview

B1.  
Cable Ties

B2.  
Cable  
Accessories

B3.  
Stainless  
Steel Ties

C1.  
Wiring  
Duct

C2.  
Surface  
Raceway

C3.  
Abrasion  
Protection

C4.  
Cable  
Management

D1.  
Terminals

D2.  
Power  
Connectors

D3.  
Grounding  
Connectors

E1.  
Labeling  
Systems

E2.  
Labels

E3.  
Pre-Printed  
& Write-On  
Markers

E4.  
Permanent  
Identification

E5.  
Lockout/  
Tagout  
& Safety  
Solutions

F.  
Index

A.  
System  
Overview

## Laser/Ink Jet Self-Laminating Labels

B1.  
Cable Ties



- Labels can be printed in both laser and ink jet printers
- Self-laminating adhesive labels include a colored print-on area and clear overlamine

B2.  
Cable Accessories

B3.  
Stainless  
Steel Ties

## Part Number System for Self-Laminating Labels

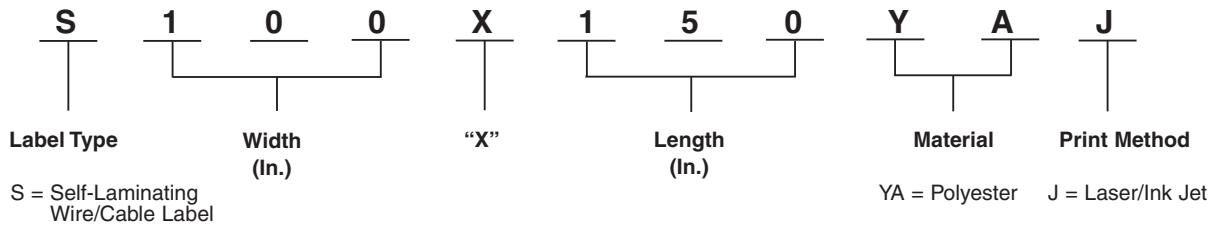

C1.  
Wiring  
Duct

C2.  
Surface Raceway

C3.  
Abrasion  
Protection

C4.  
Cable  
Management

## Material/Print Method Selection Guide

|                          | Material   | Print Method      | Temperature Range                | Features   |
|--------------------------|--|-------------------|----------------------------------|--|
| D1. Terminals            | Self-Laminating Polyester,<br>White Print-On (YA)<br>Blue Print-On (YB)<br>Green Print-On (YD)<br>Red Print-On (YH)<br>Yellow Print-On (YI)<br>Brown Print-On (YC)<br>Gray Print-On (YE)<br>Orange Print-On (YF)<br>Purple Print-On (YG) | Laser/Ink Jet (J) | 0°F to 275°F<br>(-18°C to 135°C) | Indoor/outdoor rated; provides durability, high temperature resistance, and dimensional stability; does not stretch or easily tear; preferred material for wire/cable labeling |
| D2. Power Connectors     |  |                   |                                  |  |
| D3. Grounding Connectors |  |                   |                                  |  |

E1.  
Labeling Systems

E2.  
Labels

E3.  
Pre-Printed  
& Write-On  
Markers

E4.  
Permanent  
Identification

E5.  
Lockout/  
Tagout/  
& Safety  
Solutions

F.  
Index

## Laser/Ink Jet Self-Laminating Labels (continued)

| Part Number  | Part Description  | Width |      | Length |       | Print-On Height |      | Min. Cable O.D. |      | Max. Cable O.D. |      | Std. Pkg. Qty. | Std. Ctn. Qty. |
|--------------|---|-------|------|--------|-------|-----------------|------|-----------------|------|-----------------|------|----------------|----------------|
|              |   | In.   | mm   | In.    | mm    | In.             | mm   | In.             | mm   | In.             | mm   |                |                |
| S050X075YAJ  | White print-on area, polyester label for 18 – 14 AWG wire.              | 0.50  | 12.7 | 0.75   | 19.1  | 0.25            | 6.4  | 0.08            | 2.0  | 0.16            | 4.1  | 5000           | 25000          |
| S050X125YAJ  | White print-on area, polyester label for 12 – 10 AWG wire.              | 0.50  | 12.7 | 1.25   | 31.8  | 0.38            | 9.7  | 0.12            | 3.0  | 0.28            | 7.0  | 5000           | 25000          |
| S050X150YAJ  | White print-on area, polyester label for Cat. 5e/Cat. 6/Cat. 6A cables. | 0.50  | 12.7 | 1.50   | 38.1  | 0.50            | 12.7 | 0.16            | 4.1  | 0.32            | 8.1  | 5000           | 25000          |
| S075X075YAJ  | White print-on area, polyester label for 18 – 14 AWG wire.              | 0.75  | 19.1 | 0.75   | 19.1  | 0.25            | 6.4  | 0.08            | 2.0  | 0.16            | 4.1  | 2500           | 10000          |
| S075X125YAJ  | White print-on area, polyester label for 12 – 10 AWG wire.              | 0.75  | 19.1 | 1.25   | 31.8  | 0.38            | 9.7  | 0.12            | 3.1  | 0.28            | 7.0  | 2500           | 10000          |
| S075X150YAJ  | White print-on area, polyester label for Cat. 5e/Cat. 6/Cat. 6A cables. | 0.75  | 19.1 | 1.50   | 38.1  | 0.50            | 12.7 | 0.16            | 4.1  | 0.32            | 8.1  | 2500           | 10000          |
| S100X075YAJ  | White print-on area, polyester label for 18 – 14 AWG wire.              | 1.00  | 25.4 | 0.75   | 19.1  | 0.25            | 6.4  | 0.08            | 2.0  | 0.16            | 4.1  | 2500           | 10000          |
| S100X125YAJ  | White print-on area, polyester label for 12 – 10 AWG wire.              | 1.00  | 25.4 | 1.25   | 31.8  | 0.38            | 9.7  | 0.12            | 3.1  | 0.28            | 7.0  | 2500           | 10000          |
| S100X150YAJ* | White print-on area, polyester label for Cat. 5e/Cat. 6/Cat. 6A cables. | 1.00  | 25.4 | 1.50   | 38.1  | 0.50            | 12.7 | 0.16            | 4.0  | 0.32            | 8.1  | 2500           | 10000          |
| S100X225YAJ* | Red print-on area, polyester label for 8 – 4 AWG wire.                  | 1.00  | 25.4 | 2.25   | 57.2  | 0.75            | 19.1 | 0.24            | 6.0  | 0.48            | 12.1 | 1000           | 5000           |
| S100X400YAJ  | White print-on area, polyester label for 2 – 1 AWG wire.                | 1.00  | 25.4 | 4.00   | 101.6 | 1.00            | 25.4 | 0.32            | 8.1  | 0.95            | 24.3 | 1000           | 5000           |
| S100X650YAJ  | White print-on area, polyester label for 1/0 – 350 MCM wires.           | 1.00  | 25.4 | 6.50   | 165.1 | 1.50            | 38.1 | 0.48            | 12.1 | 1.59            | 40.4 | 1000           | 5000           |
| S150X400YAJ  | White print-on area, polyester label.                                   | 1.50  | 38.1 | 4.00   | 101.6 | 1.00            | 25.4 | 0.32            | 8.1  | 0.95            | 24.1 | 1000           | 5000           |
| S150X400YIJ  | Yellow print-on area, polyester label.                                  | 1.50  | 38.1 | 4.00   | 101.6 | 1.00            | 25.4 | 0.32            | 8.1  | 0.95            | 24.1 | 1000           | 5000           |
| S200X150YAJ  | White print-on area, polyester label.                                   | 2.00  | 50.8 | 1.50   | 38.1  | 0.50            | 12.7 | 0.16            | 4.1  | 0.32            | 8.1  | 1000           | 5000           |
| S200X225YAJ  | White print-on area, polyester label for 8 – 4 AWG wire.                | 2.00  | 50.8 | 2.25   | 57.2  | 0.75            | 19.1 | 0.24            | 6.1  | 0.48            | 12.1 | 1000           | 5000           |
| S200X400YAJ  | White print-on area, polyester label for 2 – 1 AWG wire.                | 2.00  | 50.8 | 4.00   | 101.6 | 1.00            | 25.4 | 0.32            | 8.1  | 0.95            | 24.3 | 1000           | 5000           |
| S200X650YAJ  | White print-on area, polyester label for 1/0 – 350 MCM wires.           | 2.00  | 50.8 | 6.50   | 165.1 | 1.50            | 38.1 | 0.48            | 12.1 | 1.59            | 40.4 | 500            | 2500           |

Order number of labels required in multiples of Std. Pkg. Qty.

\*Other colors available, replace A with B (Blue), C (Brown), D (Green), E (Gray), F (Orange), G (Purple), H (Red) and I (Yellow).

A.  
System  
Overview

B1.  
Cable Ties

B2.  
Cable  
Accessories

B3.  
Stainless  
Steel Ties

C1.  
Wiring  
Duct

C2.  
Surface  
Raceway

C3.  
Abrasion  
Protection

C4.  
Cable  
Management

D1.  
Terminals

D2.  
Power  
Connectors

D3.  
Grounding  
Connectors

E1.  
Labeling  
Systems

E2.  
Labels

E3.  
Pre-Printed  
& Write-On  
Markers

E4.  
Permanent  
Identification

E5.  
Lockout/  
Tagout  
& Safety  
Solutions

F.  
Index

A. System Overview

## Laser/Ink Jet Non-Laminated Labels

B1. Cable Ties

- Labels can be printed in both laser/ink jet printers
- Use as a wrap around label or flag style labels for wire/cable labeling

- Available in polyolefin material and supplied on 8.50" x 11.00" sheets
- Panduit labeling software packages include all label formats for quick and easy label production

B2. Cable Accessories



B3. Stainless Steel Ties

C1. Wiring Duct

C2. Surface Raceway

## Part Number System for Non-Laminated Labels

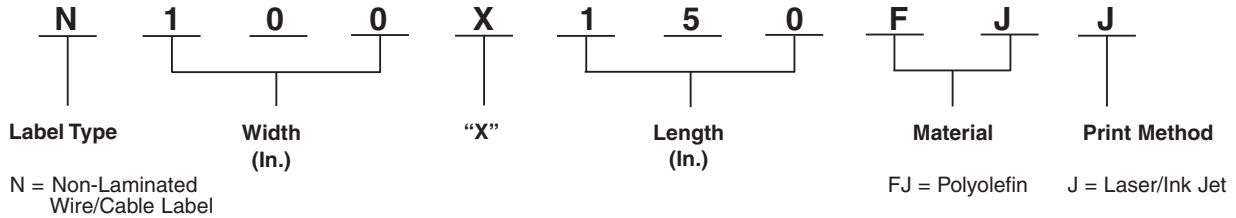

C3. Abrasion Protection

C4. Cable Management

D1. Terminals

## Material/Print Method Selection Guide

| Material               | Print Method      | Temperature Range              | Features   |
|------------------------|-------------------|--------------------------------|--|
| Polyolefin, White (FJ) | Laser/Ink Jet (J) | -40°F to 180°F (-40°C to 82°C) | Indoor/outdoor rated; conformable material for general identification; excellent print quality |

D2. Power Connectors

D3. Grounding Connectors

| Part Number        | Part Description         | Width |      | Length |      | Min. Cable O.D. |      | Max. Cable O.D. |      | Std. Pkg. Qty. | Std. Ctn. Qty. |
|--------------------|--------------------------|-------|------|--------|------|-----------------|------|-----------------|------|----------------|----------------|
|                    |                          | In.   | mm   | In.    | mm   | In.             | mm   | In.             | mm   |                |                |
| <b>N025X075FJJ</b> | White, polyolefin label. | 0.25  | 6.4  | 0.75   | 19.1 | 0.240           | 6.1  | 0.51            | 13.0 | 10000          | 50000          |
| <b>N025X125FJJ</b> | White, polyolefin label. | 0.25  | 6.4  | 1.25   | 31.8 | 0.400           | 10.2 | 0.85            | 22.0 | 10000          | 50000          |
| <b>N025X150FJJ</b> | White, polyolefin label. | 0.25  | 6.4  | 1.50   | 38.1 | 0.48            | 12.2 | 1.02            | 25.9 | 10000          | 50000          |
| <b>N050X075FJJ</b> | White, polyolefin label. | 0.50  | 12.7 | 0.75   | 19.1 | 0.240           | 6.1  | 0.51            | 13.0 | 10000          | 50000          |
| <b>N050X125FJJ</b> | White, polyolefin label. | 0.50  | 12.7 | 1.25   | 31.8 | 0.400           | 10.2 | 0.85            | 21.6 | 10000          | 50000          |
| <b>N050X150FJJ</b> | White, polyolefin label. | 0.50  | 12.7 | 1.50   | 38.1 | 0.48            | 12.2 | 1.02            | 25.9 | 5000           | 25000          |
| <b>N100X075FJJ</b> | White, polyolefin label. | 1.00  | 25.4 | 0.75   | 19.1 | 0.240           | 6.1  | 0.51            | 13.0 | 5000           | 25000          |
| <b>N100X125FJJ</b> | White, polyolefin label. | 1.00  | 25.4 | 1.25   | 31.8 | 0.400           | 10.2 | 0.85            | 22.0 | 5000           | 25000          |
| <b>N100X150FJJ</b> | White, polyolefin label. | 1.00  | 25.4 | 1.50   | 38.1 | 0.48            | 12.2 | 1.02            | 25.9 | 2500           | 10000          |

E1. Labeling Systems

E2. Labels

E3. Pre-Printed & Write-On Markers

E4. Permanent Identification

E5. Lockout/Tagout & Safety Solutions

F. Index

Order number of labels required in multiples of Std. Pkg. Qty.

## Laser/Ink Jet Flag Style Labels

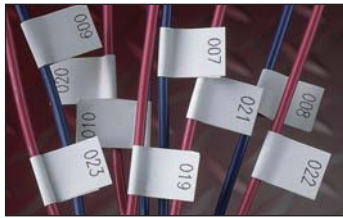

| Part Number | Part Description         | Width |       | Length |       | Min. Cable O.D. |      | Max. Cable O.D. |      | Std. Pkg. Qty. | Std. Ctn. Qty. |
|-------------|--------------------------|-------|-------|--------|-------|-----------------|------|-----------------|------|----------------|----------------|
|             |                          | In.   | mm    | In.    | mm    | In.             | mm   | In.             | mm   |                |                |
| N050X150FJJ | White, polyolefin label. | .50   | 12.70 | 1.50   | 38.10 | .06             | 1.52 | .15             | 3.81 | 5000           | 25000          |
| N100X150FJJ | White, polyolefin label. | 1.00  | 25.40 | 1.50   | 38.10 | .12             | 3.05 | .22             | 5.58 | 2500           | 10000          |

Order number of labels required in multiples of Std. Pkg. Qty.

## Laser/Ink Jet Component Labels

- Labels can be printed in both laser and ink jet printers
- Use for identifying patch panels, faceplates, punchdown blocks and other network systems hardware
- Die-cut labels designed to provide maximum aesthetic quality and appearance
- Available in adhesive polyolefin and non-adhesive polyester materials



## Part Number System for Component Labels

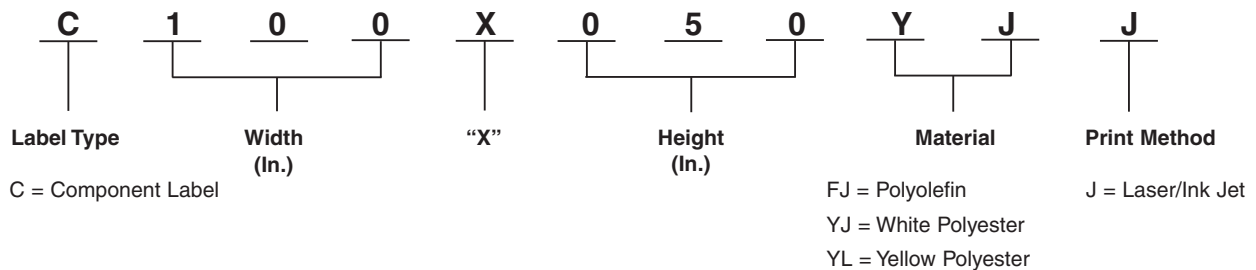

### Material/Print Method Selection Guide

| Material                             | Print Method      | Temperature Range                  | Features   |
|--------------------------------------|-------------------|------------------------------------|--|
| Polyester, White (YJ)<br>Yellow (YL) | Laser/Ink Jet (J) | -40°F to 311°F<br>(-40°C to 154°C) | Indoor/outdoor rated; provides durability, high temperature resistance, and dimensional stability. Does not stretch or easily tear |
| Polyolefin, White (FJ)               |                   | -40°F to 180°F<br>(-40°C to 82°C)  | Indoor/outdoor rated; thin conformable material for general identification; excellent print quality                                |

Table continues on page E2.6

A.  
System  
Overview

## Laser/Ink Jet Component Labels (continued)

B1.  
Cable Ties

B2.  
Cable Accessories

B3.  
Stainless  
Steel Ties

C1.  
Wiring  
Duct

C2.  
Surface Raceway

C3.  
Abrasion  
Protection

C4.  
Cable  
Management

D1.  
Terminals

D2.  
Power Connectors

D3.  
Grounding  
Connectors

E1.  
Labeling Systems

E2.  
Labels

E3.  
Pre-Printed  
& Write-On  
Markers

E4.  
Permanent  
Identification

E5.  
Lockout/  
Tagout  
& Safety  
Solutions

F.  
Index

| Part Number         | Part Description  | Width |       | Height |       | Std. Pkg. Qty. | Std. Ctn. Qty. |
|---------------------|---|-------|-------|--------|-------|----------------|----------------|
|                     |   | In.   | mm    | In.    | mm    |                |                |
| <b>C038X038YJJ</b>  | White, polyester label.                                 | 0.38  | 9.7   | 0.38   | 9.7   | 10000          | 50000          |
| <b>C038X038YLJ</b>  | Yellow, polyester label.                                | 0.38  | 9.7   | 0.38   | 9.7   | 10000          | 50000          |
| <b>C050X044YJJ</b>  | White, polyester label.                                 | 0.50  | 12.7  | 0.44   | 11.2  | 10000          | 50000          |
| <b>C060X020YJJ</b>  | White, polyester label.                                 | 0.60  | 15.3  | 0.20   | 5.1   | 10000          | 50000          |
| <b>C075X025YJJ</b>  | White, polyester label.                                 | 0.75  | 19.1  | 0.25   | 6.4   | 10000          | 50000          |
| <b>C075X025YLJ</b>  | Yellow, polyester label.                                | 0.75  | 19.1  | 0.25   | 6.4   | 10000          | 50000          |
| <b>C075X050YJJ</b>  | White, polyester label.                                 | 0.75  | 19.1  | 0.50   | 12.7  | 10000          | 50000          |
| <b>C080X020YJJ</b>  | White, polyester label.                                 | 0.80  | 20.3  | 0.20   | 5.1   | 10000          | 50000          |
| <b>C100X025YJJ</b>  | White, polyester label.                                 | 1.00  | 25.4  | 0.25   | 6.4   | 10000          | 50000          |
| <b>C100X038YJJ</b>  | White, polyester label.                                 | 1.00  | 25.4  | 0.38   | 9.7   | 5000           | 50000          |
| <b>C100X050YJJ</b>  | White, polyester label.                                 | 1.00  | 25.4  | 0.50   | 12.7  | 10000          | 50000          |
| <b>C100X050YLJ</b>  | Yellow, polyester label.                                | 1.00  | 25.4  | 0.50   | 12.7  | 5000           | 25000          |
| <b>C100X075YJJ</b>  | White, polyester label.                                 | 1.00  | 25.4  | 0.75   | 19.1  | 5000           | 25000          |
| <b>C100X150YJJ</b>  | White, polyester label.                                 | 1.00  | 25.4  | 1.50   | 38.1  | 2500           | 25000          |
| <b>C150X050YJJ</b>  | White, polyester label.                                 | 1.50  | 38.1  | 0.50   | 12.7  | 2500           | 12500          |
| <b>C150X075YJJ</b>  | White, polyester label.                                 | 1.50  | 38.1  | 0.75   | 19.1  | 2500           | 12500          |
| <b>C160X020YJJ</b>  | White, polyester label.                                 | 1.60  | 40.6  | 0.20   | 5.1   | 5000           | 20000          |
| <b>C200X050YJJ</b>  | White, polyester label.                                 | 2.00  | 50.8  | 0.50   | 12.7  | 1000           | 5000           |
| <b>C200X100FJJ</b>  | White, polyolefin label, SLCT bundle marker identifier. | 2.00  | 50.8  | 1.00   | 25.4  | 1000           | 5000           |
| <b>C200X100YJJ</b>  | White, polyester label.                                 | 2.00  | 50.8  | 1.00   | 25.4  | 1000           | 5000           |
| <b>C200X100YLJ</b>  | Yellow, polyester label.                                | 2.00  | 50.8  | 1.00   | 25.4  | 1000           | 5000           |
| <b>C225X450FJJ</b>  | White, polyolefin label.                                | 2.25  | 57.2  | 4.50   | 114.3 | 150            | 750            |
| <b>C275X125YJJ</b>  | White, polyester label.                                 | 2.75  | 69.9  | 1.25   | 31.8  | 1000           | 5000           |
| <b>C300X038YJJ</b>  | White, polyester label.                                 | 3.00  | 76.2  | 0.38   | 9.7   | 1000           | 5000           |
| <b>C300X100YJJ</b>  | White, polyester label.                                 | 3.00  | 76.2  | 1.00   | 25.4  | 1000           | 5000           |
| <b>C350X100YJJ</b>  | White, polyester label.                                 | 3.50  | 88.9  | 1.00   | 25.4  | 1000           | 5000           |
| <b>C350X500FJJ</b>  | White, polyolefin label.                                | 3.50  | 88.9  | 5.00   | 127.0 | 100            | 500            |
| <b>C400X100YJJ</b>  | White, polyester label.                                 | 4.00  | 101.6 | 1.00   | 25.4  | 1000           | 5000           |
| <b>C400X200YJJ</b>  | White, polyester label.                                 | 4.00  | 101.6 | 2.00   | 50.8  | 1000           | 5000           |
| <b>C400X400YJJ</b>  | White, polyester label.                                 | 4.00  | 101.6 | 4.00   | 101.6 | 1000           | 4000           |
| <b>C500X700FJJ</b>  | White, polyolefin label.                                | 5.00  | 127.0 | 7.00   | 177.8 | 50             | 250            |
| <b>C788X050YJJ</b>  | White, polyester label.                                 | 7.88  | 200.2 | 0.50   | 12.7  | 400            | 2000           |
| <b>C850X1100YJJ</b> | White, polyester label.                                 | 8.50  | 215.9 | 11.00  | 279.4 | 25             | 100            |
| <b>C850X1100YLJ</b> | Yellow, polyester label.                                | 8.50  | 215.9 | 11.00  | 279.4 | 25             | 100            |

Order number of labels required in multiples of Std. Pkg. Qty.



## Thermal Transfer Self-Laminating Labels

- Self-laminating adhesive labels supplied on rolls, include a colored print-on area and clear overlamine
- Use with Panduit RMH4BL hybrid thermal transfer ribbon



### Material/Print Method Selection Guide

| Material                                   | Print Method         | Temperature Range                 | Features   |
|--|----------------------|-----------------------------------|--|
| Self-Laminating Vinyl, White Print-On (VA) | Thermal Transfer (T) | -40°F to 200°F<br>(-40°C to 93°C) | Indoor/outdoor rated; thin and conformable; preferred material for most general wire/cable labeling. |

## Part Number System for Self-Laminating Labels

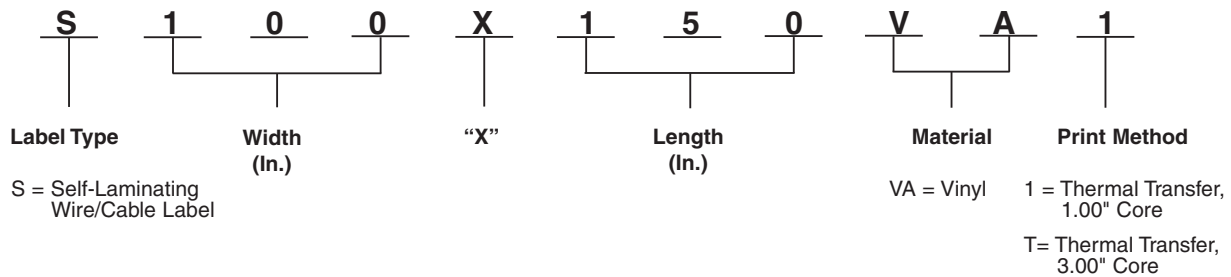

| Part Number   | Part Description  | Width |      | Length |      | Print-On Area Height |      | Min. Cable O.D. |      | Max. Wire O.D. |      | Std. Pkg. Qty. | Std. Ctn. Qty. |
|---------------|---|-------|------|--------|------|----------------------|------|-----------------|------|----------------|------|----------------|----------------|
|               |   | In.   | mm   | In.    | mm   | In.                  | mm   | In.             | mm   | In.            | mm   |                |                |
| S050X075VA1Y  | White print-on area, vinyl label for 18 – 14 AWG wires.             | 0.50  | 12.7 | 0.75   | 19.1 | 0.25                 | 6.4  | 0.08            | 2.03 | 0.16           | 4.0  | 5000           | 20000          |
| S050X075VATY* | White print-on area, vinyl label for 18 – 14 AWG wires.             | 0.50  | 12.7 | 0.75   | 19.1 | 0.25                 | 6.4  | 0.08            | 2.03 | 0.16           | 4.0  | 5000           | 40000          |
| S050X125VA1Y  | White print-on area, vinyl label for 12 – 10 AWG wires.             | 0.50  | 12.7 | 1.25   | 31.8 | 0.38                 | 9.7  | 0.12            | 3.1  | 0.28           | 7.0  | 5000           | 20000          |
| S050X125VATY* | White print-on area, vinyl label for 12 – 10 AWG wires.             | 0.50  | 12.7 | 1.25   | 31.8 | 0.38                 | 9.7  | 0.12            | 3.1  | 0.28           | 7.0  | 5000           | 10000          |
| S050X150VA1Y  | White print-on area, vinyl label for Cat. 5e/Cat. 6 cables.         | 0.50  | 12.7 | 1.50   | 38.1 | 0.50                 | 12.7 | 0.16            | 4.0  | 0.32           | 8.1  | 5000           | 60000          |
| S050X150VATY* | White print-on area, vinyl label for Cat. 5e/Cat. 6/Cat. 6A cables. | 0.50  | 12.7 | 1.50   | 38.1 | 0.50                 | 12.7 | 0.16            | 4.0  | 0.32           | 8.1  | 5000           | 40000          |
| S050X250VATY* | White print-on area, vinyl label for 6 – 2 AWG wires.               | 0.50  | 12.7 | 2.50   | 63.5 | 1.00                 | 25.4 | 0.32            | 8.1  | 0.95           | 24.3 | 5000           | 20000          |

Order number of labels required in multiples of Std. Pkg. Qty.

Use with Panduit thermal transfer hybrid or wax ribbons.

\*Labels are roll mounted on 3.00" cores; when using the TDP43MY printer and 3.00" cores, the roll stand (TDP43ME-RS) is required.

**Table continues on page E2.8**

A.  
System  
Overview

## Thermal Transfer Self-Laminating Labels (continued)

B1.  
Cable Ties

B2.  
Cable Accessories

B3.  
Stainless  
Steel Ties

C1.  
Wiring  
Duct

C2.  
Surface Raceway

C3.  
Abrasion  
Protection

C4.  
Cable  
Management

D1.  
Terminals

D2.  
Power Connectors

D3.  
Grounding  
Connectors

E1.  
Labeling Systems

E2.  
Labels

E3.  
Pre-Printed  
& Write-On  
Markers

E4.  
Permanent  
Identification

E5.  
Lockout/  
Tagout  
& Safety  
Solutions

F.  
Index

| Part Number          | Part Description   | Width |      | Length |      | Print-On Area Height |      | Min. Cable O.D. |      | Max. Wire O.D. |      | Std. Pkg. Qty. | Std. Ctn. Qty. |
|----------------------|--|-------|------|--------|------|----------------------|------|-----------------|------|----------------|------|----------------|----------------|
|                      |  | In.   | mm   | In.    | mm   | In.                  | mm   | In.             | mm   | In.            | mm   |                |                |
| <b>S075X075VATY*</b> | White print-on area, vinyl label for 18 – 14 AWG wires.              | 0.75  | 19.1 | 0.75   | 19.1 | 0.25                 | 6.4  | 0.08            | 2.03 | 0.16           | 4.04 | 5000           | 20000          |
| <b>S075X125VATY*</b> | White print-on area, vinyl label for 12 – 10 AWG wires.              | 0.75  | 19.1 | 1.25   | 31.8 | 0.38                 | 9.7  | 0.12            | 3.1  | 0.28           | 7.0  | 5000           | 20000          |
| <b>S075X150VATY*</b> | White print-on area, vinyl label for Cat. 5e/Cat. 6/Cat. 6A cables.  | 0.75  | 19.1 | 1.50   | 38.1 | 0.50                 | 12.7 | 0.16            | 4.0  | 0.32           | 8.1  | 5000           | 20000          |
| <b>S100X075VA1Y</b>  | White print-on area, vinyl label for 18 – 14 AWG wires.              | 1.00  | 25.4 | 0.75   | 19.1 | 0.25                 | 6.4  | 0.08            | 2.0  | 0.16           | 4.0  | 2500           | 10000          |
| <b>S100X075VATY*</b> | White print-on area, vinyl label for 18 – 14 AWG wires.              | 1.00  | 25.4 | 0.75   | 19.1 | 0.25                 | 6.4  | 0.08            | 2.1  | 0.16           | 4.0  | 5000           | 10000          |
| <b>S100X125VA1Y</b>  | White print-on area, vinyl label for 12 – 10 AWG wires..             | 1.00  | 25.4 | 1.25   | 31.8 | 0.38                 | 9.7  | 0.12            | 3.1  | 0.28           | 7.0  | 2500           | 10000          |
| <b>S100X125VATY*</b> | White print-on area, vinyl label for 12 – 10 AWG wires.              | 1.00  | 25.4 | 1.25   | 31.8 | 0.38                 | 9.7  | 0.12            | 3.1  | 0.28           | 7.0  | 5000           | 10000          |
| <b>S100X150VA1Y</b>  | White print-on area, vinyl label for Cat. 5e/Cat. 6/Cat. 6A cables.  | 1.00  | 25.4 | 1.50   | 38.1 | 0.50                 | 12.7 | 0.16            | 4.0  | 0.32           | 8.1  | 2500           | 30000          |
| <b>S100X150VATY*</b> | White print-on area, vinyl label for Cat. 5e/Cat. 6/Cat. 6A cables.  | 1.00  | 25.4 | 1.50   | 38.1 | 0.50                 | 12.7 | 0.16            | 4.0  | 0.32           | 8.1  | 5000           | 20000          |
| <b>S100X150VBTY*</b> | Blue print-on area, vinyl label for Cat. 5e/Cat. 6/Cat. 6A cables.   | 1.00  | 25.4 | 1.50   | 38.1 | 0.50                 | 12.7 | 0.16            | 4.0  | 0.32           | 8.1  | 5000           | 20000          |
| <b>S100X150VCTY*</b> | Brown print-on area, vinyl label for Cat. 5e/Cat. 6/Cat. 6A cables.  | 1.00  | 25.4 | 1.50   | 38.1 | 0.50                 | 12.7 | 0.16            | 4.0  | 0.32           | 8.1  | 5000           | 20000          |
| <b>S100X150VDTY*</b> | Green print-on area, vinyl label for Cat. 5e/Cat. 6/Cat. 6A cables.  | 1.00  | 25.4 | 1.50   | 38.1 | 0.50                 | 12.7 | 0.16            | 4.0  | 0.32           | 8.1  | 5000           | 20000          |
| <b>S100X150VETY*</b> | Gray print-on area, vinyl label for Cat. 5e/Cat. 6/Cat. 6A cables.   | 1.00  | 25.4 | 1.50   | 38.1 | 0.50                 | 12.7 | 0.16            | 4.0  | 0.32           | 8.1  | 5000           | 20000          |
| <b>S100X150VFTY*</b> | Orange print-on area, vinyl label for Cat. 5e/Cat. 6/Cat. 6A cables. | 1.00  | 25.4 | 1.50   | 38.1 | 0.50                 | 12.7 | 0.16            | 4.0  | 0.32           | 8.1  | 5000           | 20000          |
| <b>S100X150VGTY*</b> | Purple print-on area, vinyl label for Cat. 5e/Cat. 6/Cat. 6A cables. | 1.00  | 25.4 | 1.50   | 38.1 | 0.50                 | 12.7 | 0.16            | 4.0  | 0.32           | 8.1  | 5000           | 20000          |
| <b>S100X150VHTY*</b> | Red print-on area, vinyl label for Cat. 5e/Cat. 6/Cat. 6A cables.    | 1.00  | 25.4 | 1.50   | 38.1 | 0.50                 | 12.7 | 0.16            | 4.0  | 0.32           | 8.1  | 5000           | 20000          |
| <b>S100X150VITY*</b> | Yellow print-on area, vinyl label for Cat. 5e/Cat. 6/Cat. 6A cables. | 1.00  | 25.4 | 1.50   | 38.1 | 0.50                 | 12.7 | 0.16            | 4.0  | 0.32           | 8.1  | 5000           | 20000          |
| <b>S100X150V0TY*</b> | Black print-on area, vinyl label for Cat. 5e/Cat. 6/Cat. 6A cables.  | 1.00  | 25.4 | 1.50   | 38.1 | 0.50                 | 12.7 | 0.16            | 4.0  | 0.32           | 8.1  | 5000           | 20000          |
| <b>S100X150V9TY*</b> | Gold print-on area, vinyl label for Cat. 5e/Cat. 6/Cat. 6A cables.   | 1.00  | 25.4 | 1.50   | 38.1 | 0.50                 | 12.7 | 0.16            | 4.0  | 0.32           | 8.1  | 5000           | 20000          |
| <b>S100X225VA1Y</b>  | White print-on area, vinyl label for 8 – 4 AWG wires.                | 1.00  | 25.4 | 2.25   | 57.2 | 0.75                 | 19.1 | 0.24            | 6.1  | 0.48           | 12.1 | 1500           | 18000          |
| <b>S100X225VATY*</b> | White print-on area, vinyl label for 8 – 4 AWG wires.                | 1.00  | 25.4 | 2.25   | 57.2 | 0.75                 | 19.1 | 0.24            | 6.1  | 0.48           | 12.1 | 5000           | 20000          |
| <b>S100X225VBTY*</b> | Blue print-on area, vinyl label for 8 – 4 AWG wires.                 | 1.00  | 25.4 | 2.25   | 57.2 | 0.75                 | 19.1 | 0.24            | 6.1  | 0.48           | 12.1 | 5000           | 20000          |
| <b>S100X225VCTY*</b> | Brown print-on area, vinyl label for 8 – 4 AWG wires.                | 1.00  | 25.4 | 2.25   | 57.2 | 0.75                 | 19.1 | 0.24            | 6.1  | 0.48           | 12.1 | 5000           | 20000          |

Order number of labels required in multiples of Std. Pkg. Qty.  
Use with Panduit thermal transfer hybrid or wax ribbons.

\*Labels are roll mounted on 3.00" cores; when using the TDP43MY printer and 3.00" cores, the roll stand (TDP43M-RS) is required.

## Thermal Transfer Self-Laminating Labels (continued)

| Part Number   | Part Description  | Width |      | Length |       | Print-On Area Height |      | Min. Cable O.D. |      | Max. Wire O.D. |      | Std. Pkg. Qty. | Std. Ctn. Qty. |
|---------------|---|-------|------|--------|-------|----------------------|------|-----------------|------|----------------|------|----------------|----------------|
|               |   | In.   | mm   | In.    | mm    | In.                  | mm   | In.             | mm   | In.            | mm   |                |                |
| S100X225VDTY* | Green print-on area, vinyl label for 8 – 4 AWG wires.               | 1.00  | 25.4 | 2.25   | 57.2  | 0.75                 | 19.1 | 0.24            | 6.06 | 0.48           | 12.1 | 5000           | 20000          |
| S100X225VETY* | Gray print-on area, vinyl label for 8 – 4 AWG wires.                | 1.00  | 25.4 | 2.25   | 57.2  | 0.75                 | 19.1 | 0.24            | 6.1  | 0.48           | 12.1 | 5000           | 20000          |
| S100X225VFTY* | Orange print-on area, vinyl label for 8 – 4 AWG wires.              | 1.00  | 25.4 | 2.25   | 57.2  | 0.75                 | 19.1 | 0.24            | 6.1  | 0.48           | 12.1 | 5000           | 20000          |
| S100X225VGTY* | Purple print-on area, vinyl label for 8 – 4 AWG wires.              | 1.00  | 25.4 | 2.25   | 57.2  | 0.75                 | 19.1 | 0.24            | 6.1  | 0.48           | 12.1 | 5000           | 20000          |
| S100X225VHTY* | Red print-on area, vinyl label for 8 – 4 AWG wires.                 | 1.00  | 25.4 | 2.25   | 57.2  | 0.75                 | 19.1 | 0.24            | 6.1  | 0.48           | 12.1 | 5000           | 20000          |
| S100X225VITY* | Yellow print-on area, vinyl label for 8 – 4 AWG wires.              | 1.00  | 25.4 | 2.25   | 57.2  | 0.75                 | 19.1 | 0.24            | 6.1  | 0.48           | 12.1 | 5000           | 20000          |
| S100X225V0TY* | Black print-on area, vinyl label for 8 – 4 AWG wires.               | 1.00  | 25.4 | 2.25   | 57.2  | 0.75                 | 19.1 | 0.24            | 6.1  | 0.48           | 12.1 | 5000           | 20000          |
| S100X225V9TY* | Gold print-on area, vinyl label for 8 – 4 AWG wires.                | 1.00  | 25.4 | 2.25   | 57.2  | 0.75                 | 19.1 | 0.24            | 6.1  | 0.48           | 12.1 | 5000           | 20000          |
| S100X250VATY* | White print-on area, vinyl label for 6 – 2 AWG wires.               | 1.00  | 25.4 | 2.50   | 63.5  | 1.00                 | 25.4 | 0.32            | 8.1  | 0.48           | 12.1 | 5000           | 20000          |
| S100X400VA1Y  | White print-on area, vinyl label for 2 – 1 AWG wires.               | 1.00  | 25.4 | 4.00   | 101.6 | 1.00                 | 25.4 | 0.32            | 8.1  | 0.95           | 24.3 | 1000           | 4000           |
| S100X400VATY* | White print-on area, vinyl label for 2 – 1 AWG wires.               | 1.00  | 25.4 | 4.00   | 101.6 | 1.00                 | 25.4 | 0.32            | 8.1  | 0.95           | 24.3 | 2500           | 12500          |
| S100X650VA1Y  | White print-on area, vinyl label for 1/0 – 250 MCM wires.           | 1.00  | 25.4 | 6.50   | 165.1 | 1.50                 | 38.1 | 0.48            | 12.1 | 1.59           | 40.4 | 250            | 1000           |
| S100X650VATY* | White print-on area, vinyl label for 1/0 – 250 MCM wires.           | 1.00  | 25.4 | 6.50   | 165.1 | 1.50                 | 38.1 | 0.48            | 12.1 | 1.59           | 40.4 | 1000           | 2000           |
| S150X150VATY* | White print-on area, vinyl label for Cat. 5e/Cat. 6/Cat. 6A cables. | 1.50  | 38.1 | 1.50   | 38.1  | 0.50                 | 12.7 | 0.16            | 4.0  | 0.32           | 8.1  | 5000           | 20000          |
| S150X225VATY* | White print-on area, vinyl label for 8 – 4 AWG wires.               | 1.50  | 38.1 | 2.25   | 57.2  | 0.75                 | 19.1 | 0.24            | 6.1  | 0.48           | 12.1 | 5000           | 20000          |
| S150X400VATY* | White print-on area, vinyl label for 2 – 1 AWG wires.               | 1.50  | 38.1 | 4.00   | 101.6 | 1.00                 | 25.4 | 0.32            | 8.1  | 0.95           | 24.3 | 2500           | 10000          |
| S200X225VA1Y  | White print-on area, vinyl label for 8 – 4 AWG wires.               | 2.00  | 50.8 | 2.25   | 57.2  | 0.75                 | 19.1 | 0.24            | 6.1  | 0.48           | 12.1 | 500            | 2000           |
| S200X225VATY* | White print-on area, vinyl label for 8 – 4 AWG wires.               | 2.00  | 50.8 | 2.25   | 57.2  | 0.75                 | 19.1 | 0.24            | 6.1  | 0.48           | 12.1 | 1000           | 4000           |
| S200X250VATY* | White print-on area, vinyl label for 6 – 2 AWG wires.               | 2.00  | 50.8 | 2.50   | 63.5  | 1.00                 | 25.4 | 0.32            | 8.1  | 0.48           | 12.1 | 1000           | 4000           |
| S200X400VA1Y  | White print-on area, vinyl label for 2 – 1 AWG wires.               | 2.00  | 50.8 | 4.00   | 101.6 | 1.00                 | 25.4 | 0.32            | 8.1  | 0.95           | 24.3 | 500            | 2000           |
| S200X400VATY* | White print-on area, vinyl label for 2 – 1 AWG wires.               | 2.00  | 50.8 | 4.00   | 101.6 | 1.00                 | 25.4 | 0.32            | 8.1  | 0.95           | 24.3 | 1000           | 3000           |
| S200X650VA1Y  | White print-on area, vinyl label for 1/0 – 250 MCM wires.           | 2.00  | 50.8 | 6.50   | 165.1 | 1.50                 | 38.1 | 0.48            | 12.1 | 1.59           | 40.4 | 250            | 1000           |
| S200X650VATY* | White print-on area, vinyl label for 1/0 – 250 MCM wires.           | 2.00  | 50.8 | 6.50   | 165.1 | 1.50                 | 38.1 | 0.48            | 12.1 | 1.59           | 40.4 | 1000           | 2000           |

Order number of labels required in multiples of Std. Pkg. Qty.

Use with Panduit thermal transfer hybrid or wax ribbons.

\*Labels are roll mounted on 3.00" cores; when using the TDP43MY printer and 3.00" cores, the roll stand (TDP43M-RS) is required.

A.  
System  
Overview

B1.  
Cable Ties

B2.  
Cable  
Accessories

B3.  
Stainless  
Steel Ties

C1.  
Wiring  
Duct

C2.  
Surface  
Raceway

C3.  
Abrasion  
Protection

C4.  
Cable  
Management

D1.  
Terminals

D2.  
Power  
Connectors

D3.  
Grounding  
Connectors

E1.  
Labeling  
Systems

E2.  
Labels

E3.  
Pre-Printed  
& Write-On  
Markers

E4.  
Permanent  
Identification

E5.  
Lockout/  
Tagout  
& Safety  
Solutions

F.  
Index

## **NEW!** Turn-Tell™ Labels

A. System Overview

B1. Cable Ties

- Innovative label design allows labels to rotate for visibility from any angle, and for repositioning on the wire/cable to align legends and improve aesthetics

- Available in P1 Cassettes for the LS8E or LS8EQ printers and in computer printable rolls, for use with Easy-Mark™ Labeling Software and desktop thermal transfer printers

B2. Cable Accessories

- Labels can be easily installed on existing terminated wires and assemblies without disconnecting the wires/cables

- Temperature range: -40°F to 200°F (-40°C to 93°C)

B3. Stainless Steel Ties



C1. Wiring Duct

C2. Surface Raceway

| Part Number        | Part Description                   | Width |      | Length |       | Print-On Area Height |      | Min. Cable O.D. |     | Max. Wire O.D. |      | Std. Pkg. Qty. | Std. Ctn. Qty. |
|--------------------|------------------------------------|-------|------|--------|-------|----------------------|------|-----------------|-----|----------------|------|----------------|----------------|
|                    |                                    | In.   | mm   | In.    | mm    | In.                  | mm   | In.             | mm  | In.            | mm   |                |                |
| <b>R100X075V1T</b> | White, 18 – 14 AWG wire/cable.     | 1.00  | 25.4 | 0.75   | 19.1  | 0.25                 | 6.4  | 0.12            | 3.1 | 0.16           | 4.1  | 2500           | 10000          |
| <b>R100X125V1T</b> | White, 12 – 10 AWG wire/cable.     | 1.00  | 25.4 | 1.25   | 31.8  | 0.38                 | 9.7  | 0.16            | 4.1 | 0.22           | 5.6  | 2500           | 10000          |
| <b>R100X150V1T</b> | White, Cat 5/5e/6 cable.           | 1.00  | 25.4 | 1.50   | 38.1  | 0.50                 | 12.7 | 0.22            | 5.6 | 0.28           | 7.11 | 2500           | 10000          |
| <b>R100X150V2T</b> | Blue, Cat 5/5e/6 cable.            | 1.00  | 25.4 | 1.50   | 38.1  | 0.50                 | 12.7 | 0.22            | 5.6 | 0.28           | 7.11 | 2500           | 10000          |
| <b>R100X150V3T</b> | Green, Cat 5/5e/6 cable.           | 1.00  | 25.4 | 1.50   | 38.1  | 0.50                 | 12.7 | 0.22            | 5.6 | 0.28           | 7.11 | 2500           | 10000          |
| <b>R100X150V7T</b> | Red, Cat 5/5e/6 cable.             | 1.00  | 25.4 | 1.50   | 38.1  | 0.50                 | 12.7 | 0.22            | 5.6 | 0.28           | 7.11 | 2500           | 10000          |
| <b>R100X150V8T</b> | Yellow, Cat 5/5e/6 cable.          | 1.00  | 25.4 | 1.50   | 38.1  | 0.50                 | 12.7 | 0.22            | 5.6 | 0.28           | 7.11 | 2500           | 10000          |
| <b>R100X225V1T</b> | White, 8 – 4 AWG wire/cable.       | 1.00  | 25.4 | 2.25   | 57.2  | 0.75                 | 19.1 | 0.28            | 7.1 | 0.39           | 9.9  | 2500           | 10000          |
| <b>R100X225V2T</b> | Blue, 8 – 4 AWG wire/cable.        | 1.00  | 25.4 | 2.25   | 57.2  | 0.75                 | 19.1 | 0.28            | 7.1 | 0.39           | 9.9  | 2500           | 10000          |
| <b>R100X225V3T</b> | Green, 8 – 4 AWG wire/cable.       | 1.00  | 25.4 | 2.25   | 57.2  | 0.75                 | 19.1 | 0.28            | 7.1 | 0.39           | 9.9  | 2500           | 10000          |
| <b>R100X225V7T</b> | Red, 8 – 4 AWG wire/cable.         | 1.00  | 25.4 | 2.25   | 57.2  | 0.75                 | 19.1 | 0.28            | 7.1 | 0.39           | 9.9  | 2500           | 10000          |
| <b>R100X225V8T</b> | Yellow, 8 – 4 AWG wire/cable.      | 1.00  | 25.4 | 2.25   | 57.2  | 0.75                 | 19.1 | 0.28            | 7.1 | 0.39           | 9.9  | 2500           | 10000          |
| <b>R100X400V1T</b> | White, 2 AWG – 250 MCM wire/cable. | 1.00  | 25.4 | 4.00   | 101.6 | 1.00                 | 25.4 | 0.39            | 9.9 | 0.95           | 24.1 | 1000           | 4000           |
| <b>R200X225V1T</b> | White, 8 – 4 AWG wire/cable.       | 2.00  | 50.8 | 2.25   | 57.2  | 0.75                 | 19.1 | 0.28            | 7.1 | 0.39           | 9.9  | 1000           | 4000           |
| <b>R200X400V1T</b> | White, 2 AWG – 250 MCM wire/cable. | 2.00  | 50.8 | 4.00   | 101.6 | 1.00                 | 25.4 | 0.39            | 9.9 | 0.95           | 24.1 | 1000           | 4000           |

Order number of labels required in multiples of Std. Pkg. Qty.

D3. Grounding Connectors

## Thermal Transfer Marker Plates

E1. Labeling Systems



- Non-adhesive marker plates offer crisp, clear legends with superior legibility
- Attachable in a horizontal or vertical orientation
- Available in a variety of colors and sizes

- Use with Panduit RMR4BL resin thermal transfer ribbon

- Temperature range: -58°F to 221°F (-50°C to 105°C)

E2. Labels

E3. Pre-Printed & Write-On Markers

E4. Permanent Identification

E5. Lockout/Tagout & Safety Solutions

F. Index

| Part Number         | Part Description                       | Width |      | Height |      | Print-On Area Width |      | Std. Pkg. Qty. | Std. Ctn. Qty. |
|---------------------|--|-------|------|--------|------|---------------------|------|----------------|----------------|
|                     |  | In.   | mm   | In.    | mm   | In.                 | mm   |                |                |
| <b>M300X100Y6T*</b> | Yellow, thermal transfer marker plate. | 3.00  | 76.2 | 1.00   | 25.4 | 1.80                | 45.7 | 1              | 4              |
| <b>M300X100Y7T</b>  | White, thermal transfer marker plate.  | 3.00  | 76.2 | 1.00   | 25.4 | 1.80                | 45.7 | 1              | 4              |
| <b>M300X050Y6T*</b> | Yellow, thermal transfer marker plate. | 3.00  | 76.2 | 0.50   | 12.7 | 1.80                | 45.7 | 1              | 4              |
| <b>M300X050Y7T</b>  | White, thermal transfer marker plate.  | 3.00  | 76.2 | 0.50   | 12.7 | 1.80                | 45.7 | 1              | 4              |
| <b>M200X100Y6T*</b> | Yellow, thermal transfer marker plate. | 2.00  | 50.8 | 1.00   | 25.4 | 0.80                | 20.3 | 1              | 4              |
| <b>M200X100Y7T</b>  | White, thermal transfer marker plate.  | 2.00  | 50.8 | 1.00   | 25.4 | 0.80                | 20.3 | 1              | 4              |
| <b>M200X050Y6T*</b> | Yellow, thermal transfer marker plate. | 2.00  | 50.8 | 0.50   | 12.7 | 1.07                | 27.3 | 1              | 4              |
| <b>M200X050Y7T</b>  | White, thermal transfer marker plate.  | 2.00  | 50.8 | 0.50   | 12.7 | 1.07                | 27.3 | 1              | 4              |

\*Other colors available, replace Y6 with AC (Blue), AE (Green), AF (Gray), AG (Orange), and AI (Red).

Order number of marker plates required in multiples of Std. Pkg. Qty.

## Thermal Transfer Non-Laminated Labels

- Labels offer crisp, clear legends with superior legibility
- Use as a wrap-around label or flag style marker for wire/cable labeling
- Available in vinyl cloth material for long-term or temporary labeling and supplied on rolls
- Panduit labeling software packages include all label formats for quick and easy label production

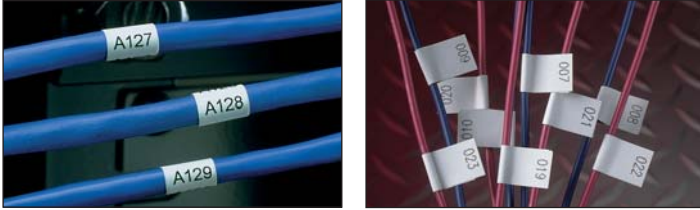

## Part Number System for Non-Laminated Labels

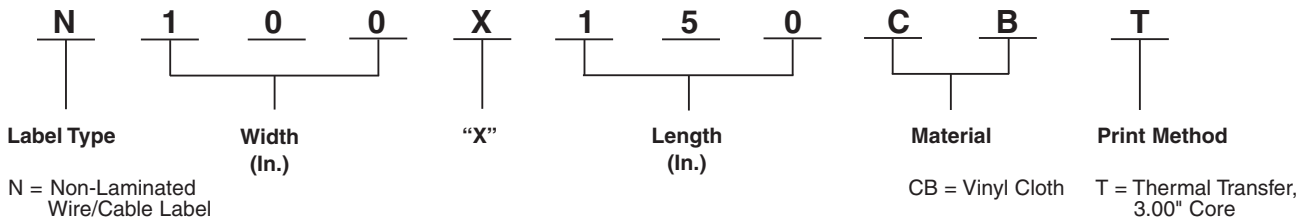

## Material/Print Method Selection Guide

| Material                | Print Method         | Temperature Range            | Features  |
|-------------------------|----------------------|------------------------------|---|
| Vinyl Cloth, White (CB) | Thermal Transfer (T) | 50°F to 170°F (10°C to 77°C) | Indoor/outdoor rated; thin conformable material with repositionable adhesive allows label to be removed and reused or used in temporary applications; provides durability, high temperature resistance, and dimensional stability for rough or textured surfaces; resists oil and abrasion. |

| Part Number | Part Description          | Width |       | Length |       | Min. Cable O.D. |       | Max. Cable O.D. |       | Std. Pkg. Qty. | Std. Ctn. Qty. |
|-------------|---------------------------|-------|-------|--------|-------|-----------------|-------|-----------------|-------|----------------|----------------|
|             |                           | In.   | mm    | In.    | mm    | In.             | mm    | In.             | mm    |                |                |
| N025X075CBT | White, vinyl cloth label. | 0.25  | 6.35  | 0.75   | 19.05 | 0.24            | 6.10  | 0.51            | 12.95 | 10000          | 40000          |
| N025X125CBT | White, vinyl cloth label. | 0.25  | 6.35  | 1.25   | 31.75 | 0.40            | 10.16 | 0.85            | 21.59 | 10000          | 40000          |
| N025X150CBT | White, vinyl cloth label. | 0.25  | 6.35  | 1.50   | 38.10 | 0.48            | 12.19 | 1.02            | 25.91 | 2500           | 10000          |
| N025X175CBT | White, vinyl cloth label. | 0.25  | 6.35  | 1.75   | 44.45 | 0.56            | 14.22 | 1.19            | 30.23 | 10000          | 40000          |
| N050X075CBT | White, vinyl cloth label. | 0.50  | 12.70 | 0.75   | 19.05 | 0.24            | 6.10  | 0.51            | 12.95 | 10000          | 40000          |
| N050X100CBT | White, vinyl cloth label. | 0.50  | 12.70 | 1.00   | 25.40 | 0.32            | 8.13  | 0.68            | 17.27 | 10000          | 40000          |
| N050X125CBT | White, vinyl cloth label. | 0.50  | 12.70 | 1.25   | 31.75 | 0.40            | 10.16 | 0.85            | 21.59 | 10000          | 40000          |
| N050X150CBT | White, vinyl cloth label. | 0.50  | 12.70 | 1.50   | 38.10 | 0.48            | 12.19 | 1.02            | 25.91 | 2500           | 10000          |
| N050X175CBT | White, vinyl cloth label. | 0.50  | 12.70 | 1.75   | 44.45 | 0.56            | 14.12 | 1.19            | 30.23 | 2500           | 10000          |
| N100X075CBT | White, vinyl cloth label. | 1.00  | 25.40 | 0.8    | 19.05 | 0.24            | 6.10  | 0.51            | 12.95 | 10000          | 40000          |
| N100X125CBT | White, vinyl cloth label. | 1.00  | 25.40 | 1.25   | 31.75 | 0.40            | 10.16 | 0.85            | 21.59 | 5000           | 20000          |
| N100X150CBT | White, vinyl cloth label. | 1.00  | 25.40 | 1.50   | 38.10 | 0.48            | 12.19 | 1.02            | 25.91 | 5000           | 20000          |
| N100X175CBT | White, vinyl cloth label. | 1.00  | 25.40 | 1.75   | 44.45 | 0.56            | 14.22 | 1.19            | 30.23 | 2500           | 10000          |

Order number of labels required in multiples of Std. Pkg. Qty.  
 Use with Panduit thermal transfer hybrid or wax ribbons found on pages E1.13 and E1.14.  
 \*Labels are roll mounted on 3.00" cores; when using the TDP43M printer and 3.00" cores, the roll stand (TDP43M-RS) is required.

A.  
System  
Overview

B1.  
Cable Ties

B2.  
Cable  
Accessories

B3.  
Stainless  
Steel Ties

C1.  
Wiring  
Duct

C2.  
Surface  
Raceway

C3.  
Abrasion  
Protection

C4.  
Cable  
Management

D1.  
Terminals

D2.  
Power  
Connectors

D3.  
Grounding  
Connectors

E1.  
Labeling  
Systems

E2.  
Labels

E3.  
Pre-Printed  
& Write-On  
Markers

E4.  
Permanent  
Identification

E5.  
Lockout/  
Tagout  
& Safety  
Solutions

F.  
Index



A. System Overview

## Thermal Transfer Military Grade Heat Shrink Labels

- Labels offer crisp, clear legends with superior legibility
- Meets UL Standard 224 for flammability and AMS-DTL-23053/5C (Class 1 and Class 3)
- Will meet MIL-M-81531, MIL-STD202F, and MIL-STD-883E when printed with RMH4BL or RHH4BL-S ribbons
- Shrink ratio 3:1
- Pre-cut flattened polyolefin is both thermal transfer and dot matrix printable and supplied roll mounted on plastic carrier
- Panduit labeling software packages include all label formats for quick and easy label production

B1. Cable Ties

B2. Cable Accessories



B3. Stainless Steel Ties

C1. Wiring Duct

## Part Number System for Heat Shrink Labels

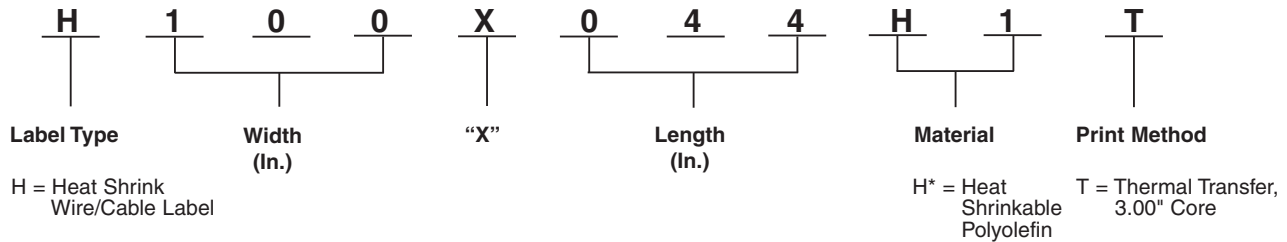

C2. Surface Raceway

C3. Abrasion Protection

C4. Cable Management

## Material/Print Method Selection Guide

| Material  | Print Method         | Temperature Range                  | Features  |
|---|----------------------|------------------------------------|---|
| Heat Shrinkable Polyolefin, White (H1)<br>Yellow (H2)<br>Black (H3)<br>Red (H4) | Thermal Transfer (T) | -67°F to 275°F<br>(-55°C to 135°C) | Durable flattened polyolefin, high quality heat shrink wire/cable labels. |

D2. Power Connectors

D3. Grounding Connectors

E1. Labeling Systems

E2. Labels

E3. Pre-Printed & Write-On Markers

E4. Permanent Identification

E5. Lockout/Tagout & Safety Solutions

F. Index

| Part Number          | Part Description                              | Width |      | Length |      | Min. Cable O.D. |     | Max. Cable O.D. |     | Std. Pkg. Qty. |
|----------------------|---|-------|------|--------|------|-----------------|-----|-----------------|-----|----------------|
|                      |   | In.   | mm   | In.    | mm   | In.             | mm  | In.             | mm  |                |
| <b>H050X025H1T*</b>  | White, 1/8" diameter polyolefin, 2000/roll.   | 0.50  | 12.7 | 0.25   | 6.4  | 0.04            | 1.0 | 0.13            | 3.3 | 1              |
| <b>H050X025H1T-B</b> | White, 1/8" diameter polyolefin, 10000/roll.  | 0.50  | 12.7 | 0.25   | 6.4  | 0.04            | 1.0 | 0.13            | 3.3 | 1              |
| <b>H050X034H1T*</b>  | White, 3/16" diameter polyolefin, 2000/roll.  | 0.50  | 12.7 | 0.34   | 8.6  | 0.06            | 1.5 | 0.19            | 4.8 | 1              |
| <b>H050X034H1T-B</b> | White, 3/16" diameter polyolefin, 10000/roll. | 0.50  | 12.7 | 0.34   | 8.6  | 0.06            | 1.5 | 0.19            | 4.8 | 1              |
| <b>H050X044H1T*</b>  | White, 1/4" diameter polyolefin, 2000/roll.   | 0.50  | 12.7 | 0.44   | 11.2 | 0.08            | 2.0 | 0.25            | 6.4 | 1              |
| <b>H050X044H1T-B</b> | White, 1/4" diameter polyolefin, 10000/roll.  | 0.50  | 12.7 | 0.44   | 11.2 | 0.08            | 2.0 | 0.25            | 6.4 | 1              |
| <b>H050X064H1T*</b>  | White, 3/8" diameter polyolefin, 2000/roll.   | 0.50  | 12.7 | 0.64   | 16.3 | 0.13            | 3.3 | 0.38            | 9.7 | 1              |
| <b>H050X064H1T-B</b> | White, 3/8" diameter polyolefin, 10000/roll.  | 0.50  | 12.7 | 0.64   | 16.3 | 0.13            | 3.3 | 0.38            | 9.7 | 1              |
| <b>H075X025H1T*</b>  | White, 1/8" diameter polyolefin, 1000/roll.   | 0.75  | 19.1 | 0.25   | 6.4  | 0.04            | 1.0 | 0.13            | 3.3 | 1              |
| <b>H075X034H1T*</b>  | White, 1/8" diameter polyolefin, 1000/roll.   | 0.75  | 19.1 | 0.25   | 6.4  | 0.04            | 1.0 | 0.13            | 3.3 | 1              |
| <b>H075X044H1T*</b>  | White, 1/8" diameter polyolefin, 5000/roll.   | 0.75  | 19.1 | 0.25   | 6.4  | 0.04            | 1.0 | 0.13            | 3.3 | 1              |
| <b>H100X025H1T*</b>  | White, 1/8" diameter polyolefin, 1000/roll.   | 1.00  | 25.4 | 0.25   | 6.4  | 0.04            | 1.0 | 0.13            | 3.3 | 1              |
| <b>H100X025H1T-B</b> | White, 1/8" diameter polyolefin, 5000/roll.   | 1.00  | 25.4 | 0.25   | 6.4  | 0.04            | 1.0 | 0.13            | 3.3 | 1              |
| <b>H100X034H1T*</b>  | White, 3/16" diameter polyolefin, 1000/roll.  | 1.00  | 25.4 | 0.34   | 8.6  | 0.06            | 1.5 | 0.19            | 4.8 | 1              |
| <b>H100X034H1T-B</b> | White, 3/16" diameter polyolefin, 5000/roll.  | 1.00  | 25.4 | 0.34   | 8.6  | 0.06            | 1.5 | 0.19            | 4.8 | 1              |
| <b>H100X044H1T*</b>  | White, 1/4" diameter polyolefin, 1000/roll.   | 1.00  | 25.4 | 0.44   | 11.2 | 0.08            | 2.0 | 0.25            | 6.4 | 1              |
| <b>H100X044H1T-B</b> | White, 1/4" diameter polyolefin, 5000/roll.   | 1.00  | 25.4 | 0.44   | 11.2 | 0.08            | 2.0 | 0.25            | 6.4 | 1              |
| <b>H100X064H1T*</b>  | White, 3/8" diameter polyolefin, 1000/roll.   | 1.00  | 25.4 | 0.64   | 16.3 | 0.13            | 3.3 | 0.38            | 9.7 | 1              |
| <b>H100X064H1T-B</b> | White, 3/8" diameter polyolefin, 5000/roll.   | 1.00  | 25.4 | 0.64   | 16.3 | 0.13            | 3.3 | 0.38            | 9.7 | 1              |

\*Other colors available, replace H1T with H2T (Yellow), H3T (Black), and H4T (Red).  
Order number of rolls required.



## Thermal Transfer Military Grade Heat Shrink Labels (continued)

| Part Number   | Part Description                             | Width |      | Length |      | Min. Cable O.D. |     | Max. Cable O.D. |      | Std. Pkg. Qty. |
|---------------|--|-------|------|--------|------|-----------------|-----|-----------------|------|----------------|
|               |  | In.   | mm   | In.    | mm   | In.             | mm  | In.             | mm   |                |
| H100X084H1T*  | White, 1/2" diameter polyolefin, 1000/roll.  | 1.00  | 25.4 | 0.84   | 21.3 | 0.170           | 4.3 | 0.50            | 12.7 | 1              |
| H100X165H1T*  | White, 1" diameter polyolefin, 500/roll.     | 1.00  | 25.4 | 1.65   | 41.9 | 0.33            | 8.4 | 1.00            | 25.4 | 1              |
| H150X025H1T*  | White, 1/8" diameter polyolefin, 500/roll.   | 1.50  | 38.1 | 0.25   | 6.4  | 0.04            | 1.0 | 0.13            | 3.3  | 1              |
| H150X034H1T*  | White, 3/16" diameter polyolefin, 500/roll.  | 1.50  | 38.1 | 0.34   | 8.6  | 0.06            | 1.5 | 0.19            | 4.8  | 1              |
| H150X044H1T*  | White, 1/4" diameter polyolefin, 500/roll.   | 1.50  | 38.1 | 0.44   | 11.2 | 0.08            | 2.0 | 0.25            | 6.4  | 1              |
| H200X025H1T*  | White, 1/8" diameter polyolefin, 500/roll.   | 2.00  | 50.8 | 0.25   | 6.4  | 0.04            | 1.0 | 0.13            | 3.2  | 1              |
| H200X025H1T-B | White, 1/8" diameter polyolefin, 2500/roll.  | 2.00  | 50.8 | 0.25   | 6.4  | 0.04            | 1.0 | 0.13            | 3.2  | 1              |
| H200X034H1T*  | White, 3/16" diameter polyolefin, 500/roll.  | 2.00  | 50.8 | 0.34   | 8.6  | 0.06            | 1.5 | 0.19            | 4.8  | 1              |
| H200X034H1T-B | White, 3/16" diameter polyolefin, 2500/roll. | 2.00  | 50.8 | 0.34   | 8.6  | 0.06            | 1.5 | 0.19            | 4.8  | 1              |
| H200X044H1T*  | White, 1/4" diameter polyolefin, 500/roll.   | 2.00  | 50.8 | 0.44   | 11.2 | 0.08            | 2.0 | 0.25            | 6.4  | 1              |
| H200X044H1T-B | White, 1/4" diameter polyolefin, 2500/roll.  | 2.00  | 50.8 | 0.44   | 11.2 | 0.08            | 2.0 | 0.25            | 6.4  | 1              |
| H200X064H1T*  | White, 3/8" diameter polyolefin, 500/roll.   | 2.00  | 50.8 | 0.64   | 16.3 | 0.13            | 3.3 | 0.38            | 9.7  | 1              |
| H200X064H1T-B | White, 3/8" diameter polyolefin, 2500/roll.  | 2.00  | 50.8 | 0.64   | 16.3 | 0.13            | 3.3 | 0.38            | 9.7  | 1              |
| H200X084H1T*  | White, 1/2" diameter polyolefin, 500/roll.   | 2.00  | 50.8 | 0.84   | 21.3 | 0.170           | 4.3 | 0.50            | 12.7 | 1              |
| H200X084H2T   | Yellow, 1/2" diameter polyolefin, 500/roll.  | 2.00  | 50.8 | 0.84   | 21.3 | 0.170           | 4.3 | 0.50            | 12.7 | 1              |
| H200X165H1T*  | White, 1" diameter polyolefin, 250/roll.     | 2.00  | 50.8 | 1.65   | 41.9 | 0.33            | 8.4 | 1.00            | 25.4 | 1              |

\*Other colors available, replace H1T with H2T (Yellow), H3T (Black), and H4T (Red).  
Order number of rolls required.

A.  
System  
Overview

B1.  
Cable Ties

B2.  
Cable  
Accessories

B3.  
Stainless  
Steel Ties

C1.  
Wiring  
Duct

C2.  
Surface  
Raceway

C3.  
Abrasion  
Protection

C4.  
Cable  
Management

D1.  
Terminals

D2.  
Power  
Connectors

D3.  
Grounding  
Connectors

E1.  
Labeling  
Systems

E2.  
Labels

E3.  
Pre-Printed  
& Write-On  
Markers

E4.  
Permanent  
Identification

E5.  
Lockout/  
Tagout  
& Safety  
Solutions

F.  
Index

## **NEW!** 2-Sided Military Grade Printable Heat Shrink Labels



A.  
System  
Overview

B1.  
Cable Ties

B2.  
Cable Accessories

B3.  
Stainless  
Steel Ties

C1.  
Wiring  
Duct



- Labels offer crisp, clear legends with superior legibility
- Meets UL Standard 224 for flammability and AMS-DTL-23053/5C (Class 1 and Class 3)
- Will meet MIL-M-81531, MIL-STD202F, and MIL-STD-883E when printed with RMH4BL or RHH4BL-S ribbons

- Shrink ratio 3:1
- Pre-cut flattened polyolefin is thermal transfer printable and supplied roll mounted on plastic carrier
- Panduit labeling software packages include all label formats for quick and easy label production

C2.  
Surface Raceway

C3.  
Abrasion  
Protection

C4.  
Cable  
Management

D1.  
Terminals

D2.  
Power Connectors

D3.  
Grounding  
Connectors

E1.  
Labeling Systems

E2.  
Labels

E3.  
Pre-Printed  
& Write-On  
Markers

E4.  
Permanent  
Identification

E5.  
Lockout/  
Tagout  
& Safety  
Solutions

F.  
Index

| Part Number*           | Part Description   | Width |      | Height |      | Min. Cable O.D. |     | Max. Wire O.D. |      | Std. Pkg. Qty. | Std. Ctn. Qty. |
|------------------------|--|-------|------|--------|------|-----------------|-----|----------------|------|----------------|----------------|
|                        |  | In.   | mm   | In.    | mm   | In.             | mm  | In.            | mm   |                |                |
| <b>H100X025H1T-2</b>   | 2-sided Military Grade printable heat shrink label, white, 1/8" (3.1mm) diameter polyolefin, 1000/roll.  | 1.00  | 25.4 | 0.25   | 6.4  | 0.04            | 1.0 | 0.13           | 3.3  | 1              | —              |
| <b>H100X025H1T-2-B</b> | 2-sided Military Grade printable heat shrink label, white, 1/8" diameter polyolefin, 5000/roll.          | 1.00  | 25.4 | 0.25   | 6.4  | 0.04            | 1.0 | 0.13           | 3.3  | 1              | 1              |
| <b>H100X034H1T-2</b>   | 2-sided Military Grade printable heat shrink label, white, 3/16" (4.7mm) diameter polyolefin, 1000/roll. | 1.00  | 25.4 | 0.34   | 8.6  | 0.06            | 1.5 | 0.19           | 4.8  | 1              | —              |
| <b>H100X034H1T-2-B</b> | 2-sided Military Grade printable heat shrink label, white, 3/16" diameter polyolefin, 5000/roll.         | 1.00  | 25.4 | 0.34   | 8.6  | 0.06            | 1.5 | 0.19           | 4.0  | 1              | 1              |
| <b>H100X044H1T-2</b>   | 2-sided Military Grade printable heat shrink label, white, 1/4" (6.3mm) diameter polyolefin, 1000/roll.  | 1.00  | 25.4 | 0.44   | 11.2 | 0.08            | 2.0 | 0.25           | 6.4  | 1              | —              |
| <b>H100X044H1T-2-B</b> | 2-sided Military Grade printable heat shrink label, white, 1/4" diameter polyolefin, 5000/roll.          | 1.00  | 25.4 | 0.44   | 11.2 | 0.08            | 2.0 | 0.25           | 6.4  | 1              | 1              |
| <b>H100X064H1T-2</b>   | 2-sided Military Grade printable heat shrink label, white, 3/8" (9.5mm) diameter polyolefin, 1000/roll.  | 1.00  | 25.4 | 0.64   | 16.3 | 0.13            | 3.3 | 0.38           | 9.7  | 1              | —              |
| <b>H100X064H1T-2-B</b> | 2-sided Military Grade printable heat shrink label, white, 3/8" diameter polyolefin, 5000/roll.          | 1.00  | 25.4 | 0.64   | 16.3 | 0.13            | 3.3 | 0.38           | 9.7  | 1              | —              |
| <b>H100X084H1T-2</b>   | 2-sided Military Grade printable heat shrink label, white, 1/2" (12.7mm) diameter polyolefin, 1000/roll. | 1.00  | 25.4 | 0.84   | 21.3 | 0.170           | 4.3 | 0.50           | 12.7 | 1              | —              |
| <b>H100X084H1T-2-B</b> | 2-sided Military Grade printable heat shrink label, white, 1/2" (12.7mm) diameter polyolefin, 5000/roll. | 1.00  | 25.4 | 0.84   | 21.3 | 0.17            | 4.3 | 0.50           | 12.7 | 1              | 1              |
| <b>H100X122H1T-2</b>   | 2-sided Military Grade printable heat shrink label, white, 3/4" (19.0mm) diameter polyolefin, 500/roll.  | 1.00  | 25.4 | 1.22   | 31.0 | 0.04            | 1.0 | 0.13           | 3.3  | 1              | —              |
| <b>H100X165H1T-2</b>   | 2-sided Military Grade printable heat shrink label, white, 1" (25.4mm) diameter polyolefin, 500/roll.    | 1.00  | 25.4 | 1.65   | 41.9 | 0.33            | 8.4 | 1.00           | 25.4 | 1              | —              |
| <b>H200X025H1T-2</b>   | 2-sided Military Grade printable heat shrink label, white, 1/8" (3.1mm) diameter polyolefin, 500/roll.   | 2.00  | 50.8 | 0.25   | 6.4  | 0.04            | 1.0 | 0.13           | 3.3  | 1              | —              |

\*Other color available, replace H1T with H2T (Yellow).  
Order number of labels required in multiples of Std. Pkg. Qty.

## 2-Sided Military Grade Printable Heat Shrink Labels (continued)

| Part Number*    | Part Description   | Width |      | Height |      | Min. Cable O.D. |     | Max. Wire O.D. |      | Std. Pkg. Qty. | Std. Ctn. Qty. |
|-----------------|--|-------|------|--------|------|-----------------|-----|----------------|------|----------------|----------------|
|                 |  | In.   | mm   | In.    | mm   | In.             | mm  | In.            | mm   |                |                |
| H200X025H1T-2-B | 2-sided Military Grade printable heat shrink label, white, 1/8" diameter polyolefin, 2500/roll.          | 2.00  | 50.8 | 0.25   | 6.4  | 0.04            | 1.0 | 0.13           | 3.3  | 1              | —              |
| H200X034H1T-2   | 2-sided Military Grade printable heat shrink label, white, 3/16" (4.7mm) diameter polyolefin, 500/roll.  | 2.00  | 50.8 | 0.34   | 8.7  | 0.06            | 1.5 | 0.19           | 4.8  | 1              | —              |
| H200X034H1T-2-B | 2-sided Military Grade printable heat shrink label, white, 3/16" diameter polyolefin, 2500/roll.         | 2.00  | 50.8 | 0.34   | 8.6  | 0.06            | 1.5 | 0.19           | 4.0  | 1              | 1              |
| H200X044H1T-2   | 2-sided Military Grade printable heat shrink label, white, 1/4" (6.3mm) diameter polyolefin, 500/roll.   | 2.00  | 50.8 | 0.44   | 11.2 | 0.08            | 2.0 | 0.25           | 6.4  | 1              | —              |
| H200X044H1T-2-B | 2-sided Military Grade printable heat shrink label, white, 1/4" diameter polyolefin, 2500/roll.          | 2.00  | 50.8 | 0.44   | 11.2 | 0.08            | 2.0 | 0.25           | 6.4  | 1              | 1              |
| H200X064H1T-2   | 2-sided Military Grade printable heat shrink label, white, 3/8" (9.5mm) diameter polyolefin, 500/roll.   | 2.00  | 50.8 | 0.64   | 16.3 | 0.13            | 3.3 | 0.38           | 9.7  | 1              | —              |
| H200X064H1T-2-B | 2-sided Military Grade printable heat shrink label, white, 3/8" diameter polyolefin, 2500/roll.          | 2.00  | 50.8 | 0.64   | 16.3 | 0.13            | 3.3 | 0.38           | 9.7  | 1              | 1              |
| H200X084H1T-2   | 2-sided Military Grade printable heat shrink label, white, 1/2" (12.7mm) diameter polyolefin, 500/roll.  | 2.00  | 50.8 | 0.84   | 21.3 | 0.170           | 4.3 | 0.50           | 12.7 | 1              | —              |
| H200X084H1T-2-B | 2-sided Military Grade printable heat shrink label, white, 1/2" (12.7mm) diameter polyolefin, 2500/roll. | 2.00  | 50.8 | 0.84   | 21.3 | 0.17            | 4.3 | 0.50           | 12.7 | 1              | 1              |
| H200X122H1T-2   | 2-sided Military Grade printable heat shrink label, white, 3/4" (19.0mm) diameter polyolefin, 250/roll.  | 2.00  | 50.8 | 1.22   | 31.0 | 0.25            | 6.3 | 0.75           | 19.0 | 1              | —              |
| H200X165H1T-2   | 2-sided Military Grade printable heat shrink label, white, 1" (25.4mm) diameter polyolefin, 250/roll.    | 2.00  | 50.8 | 1.65   | 41.9 | 0.33            | 8.4 | 1.00           | 25.4 | 1              | —              |

\*Other color available, replace H1T with H2T (Yellow).  
Order number of labels required in multiples of Std. Pkg. Qty.

### Heat Shrink Tools and Accessories

- Adjustable air intake regulator provides variable temperature adjustment within the units rated heat range
- Toggle type control switch provides hot/cold/off operation
- Replaceable brushes are easy to service and extend the operating life of the gun
- Unique suspended quick change heating element design prolongs life and eases servicing



| Part Number  | Part Description   | Std. Pkg. Qty. | Std. Ctn. Qty. |
|--------------|--|----------------|----------------|
| HSG-115V-650 | Heat gun with temperature range of 650°F (344°C) to 900°F (482°C).   | 1              | —              |
| HSG-A1       | Shrink tube reflector for tubing up to 3/4" inside diameter. Directs heat around tubing to reduce shrink time.   | 1              | 10             |
| HSG-A2       | Shrink tube reflector for tubing up to 1 1/2" inside diameter. Directs heat around tubing to reduce shrink time. | 1              | 10             |
| HSG-A3       | Shrink tube concentrator. Directs heat toward tubing and away from heat sensitive items.                         | 1              | 10             |
| HSG-A4       | Black polyethylene case stores heat gun, stand, and all three accessories.                                       | 1              | —              |
| HSG-P1       | Replacement brush/spring kit.  | 1              | 5              |
| HSG-P2       | Replacement switch 20 Amps.  | 1              | 5              |
| HSG-P3       | Replacement bearing kit.   | 1              | 5              |
| HSG-P7       | Replacement heat element 650°F.  | 1              | —              |

A.  
System  
Overview

## Thermal Transfer Component Labels

- Labels offer crisp, clear legends with superior legibility
- Available in polyester, vinyl cloth, and polyimide materials and supplied on rolls

- Designed for use with thermal transfer desktop printers, including the TDP43MY and TDP42HY printers
- Panduit labeling software packages include all label formats for quick and easy label production

B1.  
Cable Ties

B2.  
Cable Accessories

B3.  
Stainless  
Steel Ties



C1.  
Wiring  
Duct

## Part Number System for Component Labels

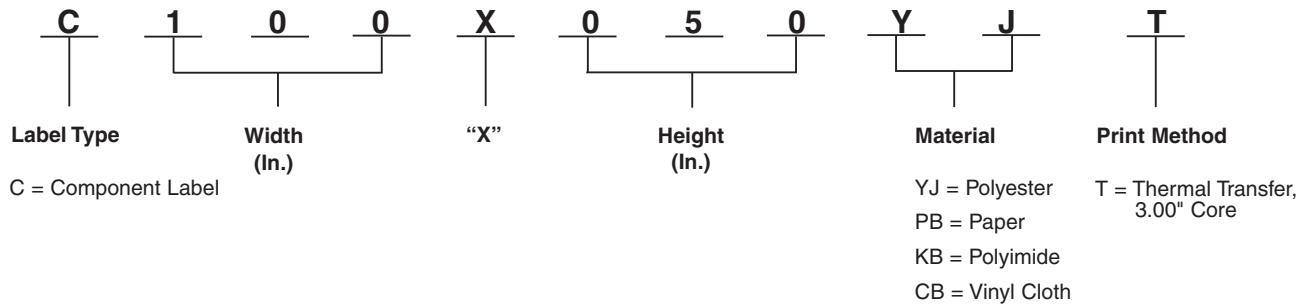

C2.  
Surface Raceway

C3.  
Abrasion  
Protection

C4.  
Cable  
Management

D1.  
Terminals

### Material/Print Method Selection Guide

| Material   | Print Method         | Temperature Range                  | Features  |
|--|----------------------|------------------------------------|---|
| Polyester, White (YJ)                                | Thermal Transfer (T) | -40°F to 302°F<br>(-40°C to 150°C) | Indoor/outdoor rated; provides durability, high temperature resistance and dimensional stability; does not stretch or easily tear.  |
| Paper, White (PB)                                    |                      | -65°F to 160°F<br>(-54°C to 71°C)  | Indoor rated; general purpose material; excellent adhesion properties when applied to a clean dry surface.  |
| Polyimide, White (KB)                                |                      | -40°F to 350°F<br>(-40°C to 177°C) | Indoor rated; ideal for electronic components and internal circuitry applications; material is intended for applications requiring solvent and high temperature resistance performance, such as the wave solder process.  |
| Vinyl Cloth, White (CB)<br>Silver (YM)<br>Clear (YK) |                      | 50°F to 170°F<br>(10°C to 77°C)    | Indoor/outdoor rated; thin conformable material with repositionable adhesive allows label to be removed and reused or used in temporary applications; provides durability, high temperature resistance, and dimensional stability for rough or textured surfaces; resists oil and abrasion. |

D2.  
Power Connectors

D3.  
Grounding  
Connectors

E1.  
Labeling Systems

E2.  
Labels

E3.  
Pre-Printed  
& Write-On  
Markers

E4.  
Permanent  
Identification

E5.  
Lockout/  
Tagout/  
& Safety  
Solutions

F.  
Index

## Thermal Transfer Component Labels (continued)

| Part Number | Part Description          | Width |      | Height |      | Std. Pkg. Qty. | Std. Ctn. Qty. |
|-------------|---------------------------|-------|------|--------|------|----------------|----------------|
|             |                           | In.   | mm   | In.    | mm   |                |                |
| C025X025KBT | White, polyimide label.   | 0.25  | 6.4  | 0.25   | 6.4  | 10000          | 40000          |
| C025X025KCT | Tan, polyimide label.     | 0.25  | 6.4  | 0.25   | 6.4  | 10000          | 40000          |
| C025X025YJT | White, polyester label.   | 0.25  | 6.4  | 0.25   | 6.4  | 10000          | 40000          |
| C038X038KBT | White, polyimide label.   | 0.38  | 9.7  | 0.38   | 9.7  | 10000          | 40000          |
| C038X038KCT | Tan, polyimide label.     | 0.38  | 9.7  | 0.38   | 9.7  | 10000          | 40000          |
| C038X038YJT | White, polyester label.   | 0.38  | 9.7  | 0.38   | 9.7  | 10000          | 40000          |
| C050X013KBT | White, polyimide label.   | 0.50  | 12.7 | 0.13   | 3.3  | 10000          | 40000          |
| C050X013KCT | Tan, polyimide label.     | 0.50  | 12.7 | 0.13   | 3.3  | 10000          | 40000          |
| C050X020KBT | White, polyimide label.   | 0.50  | 12.7 | 0.20   | 5.1  | 10000          | 40000          |
| C050X044KCT | Tan, polyimide label.     | 0.50  | 12.7 | 0.44   | 11.2 | 10000          | 40000          |
| C050X044CBT | White, vinyl cloth label. | 0.50  | 12.7 | 0.44   | 11.2 | 10000          | 40000          |
| C050X044KBT | White, polyimide label.   | 0.50  | 12.7 | 0.44   | 11.2 | 10000          | 40000          |
| C050X044YJT | White, polyester label.   | 0.50  | 12.7 | 0.44   | 11.2 | 10000          | 40000          |
| C060X020CBT | White, vinyl cloth label. | 0.60  | 15.2 | 0.20   | 5.1  | 10000          | 40000          |
| C060X020KBT | White, polyimide label.   | 0.60  | 15.2 | 0.20   | 5.1  | 10000          | 40000          |
| C060X020KCT | Tan, polyimide label.     | 0.60  | 15.3 | 0.20   | 5.1  | 10000          | 40000          |
| C060X020YJT | White, polyester label.   | 0.60  | 15.2 | 0.20   | 5.1  | 10000          | 40000          |
| C065X019KBT | White, polyimide label.   | 0.65  | 16.5 | 0.19   | 4.8  | 10000          | 40000          |
| C065X019KCT | Tan, polyimide label.     | 0.65  | 16.5 | 0.19   | 4.8  | 10000          | 40000          |
| C075X025CBT | White, vinyl cloth label. | 0.75  | 19.1 | 0.25   | 6.4  | 10000          | 40000          |
| C075X025KBT | White, polyimide label.   | 0.75  | 19.1 | 0.25   | 6.4  | 10000          | 40000          |
| C075X025KCT | Tan, polyimide label.     | 0.75  | 19.1 | 0.25   | 6.4  | 10000          | 40000          |
| C075X025YJT | White, polyester label.   | 0.75  | 19.1 | 0.25   | 6.4  | 10000          | 40000          |
| C080X020KBT | White, polyimide label.   | 0.80  | 20.3 | 0.20   | 5.1  | 10000          | 40000          |
| C080X020KCT | Tan, polyimide label.     | 0.80  | 20.3 | 0.20   | 5.1  | 10000          | 40000          |
| C080X020YJT | White, polyester label.   | 0.80  | 20.3 | 0.20   | 5.1  | 10000          | 40000          |
| C090X025KBT | White, polyimide label.   | 0.90  | 22.9 | 0.25   | 6.4  | 10000          | 40000          |
| C090X025KCT | Tan, polyimide label.     | 0.90  | 22.9 | 0.25   | 6.4  | 10000          | 40000          |
| C090X025YJT | White, polyester label.   | 0.90  | 22.9 | 0.25   | 6.4  | 10000          | 40000          |
| C100X019KBT | White, polyimide label.   | 1.00  | 25.4 | 0.19   | 4.8  | 10000          | 40000          |
| C100X019KCT | Tan, polyimide label.     | 1.00  | 25.4 | 0.19   | 4.8  | 10000          | 40000          |
| C100X025CBT | White, vinyl cloth label. | 1.00  | 25.4 | 0.25   | 6.4  | 10000          | 40000          |
| C100X025KBT | White, polyimide label.   | 1.00  | 25.4 | 0.25   | 6.4  | 10000          | 40000          |
| C100X025KCT | Tan, polyimide label.     | 1.00  | 25.4 | 0.25   | 6.4  | 10000          | 40000          |
| C100X025YJT | White, polyester label.   | 1.00  | 25.4 | 0.25   | 6.4  | 10000          | 40000          |
| C100X038CBT | White, vinyl cloth label. | 1.00  | 25.4 | 0.38   | 9.7  | 10000          | 40000          |
| C100X038KBT | White, polyimide label.   | 1.00  | 25.4 | 0.38   | 9.7  | 10000          | 40000          |
| C100X038KCT | Tan, polyimide label.     | 1.00  | 25.4 | 0.38   | 9.7  | 10000          | 40000          |
| C100X038YJT | White, polyester label.   | 1.00  | 25.4 | 0.38   | 9.7  | 10000          | 40000          |
| C100X050CBT | White, vinyl cloth label. | 1.00  | 25.4 | 0.50   | 12.7 | 10000          | 40000          |
| C100X050YJT | White, polyester label.   | 1.00  | 25.4 | 0.50   | 12.7 | 10000          | 40000          |
| C125X025KBT | White, polyimide label.   | 1.25  | 31.8 | 0.25   | 6.4  | 10000          | 40000          |
| C125X025KCT | Tan, polyimide label.     | 1.25  | 31.8 | 0.25   | 6.4  | 10000          | 40000          |

Order number of labels required in multiples of Std. Pkg. Qty.  
Use with Panduit thermal transfer ribbons.

Labels roll mounted on 3.00" cores; when using the TDP43MY printer and 3.00" cores, the roll stand (TDP43M-RS) is required.

*Table continues on page E2.18*

A.  
System  
Overview

## Thermal Transfer Component Labels (continued)

B1.  
Cable Ties

| Part Number        | Part Description           | Width |       | Height |       | Std. Pkg. Qty. | Std. Ctn. Qty. |
|--------------------|----------------------------|-------|-------|--------|-------|----------------|----------------|
|                    |                            | In.   | mm    | In.    | mm    |                |                |
| <b>C125X038YJT</b> | White, polyester label.    | 1.25  | 31.8  | 0.38   | 9.7   | 10000          | 20000          |
| <b>C150X025KBT</b> | White, polyimide label.    | 1.50  | 38.1  | 0.25   | 6.4   | 5000           | 20000          |
| <b>C150X025KCT</b> | Tan, polyimide label.      | 1.50  | 38.1  | 0.25   | 6.4   | 5000           | 20000          |
| <b>C150X050YJT</b> | White, polyester label.    | 1.50  | 38.1  | 0.50   | 12.7  | 5000           | 20000          |
| <b>C150X075YJT</b> | White, polyester label.    | 1.50  | 38.1  | 0.75   | 19.1  | 5000           | 20000          |
| <b>C150X075YMT</b> | Silver, polyester label..  | 1.50  | 38.1  | 0.75   | 19.1  | 5000           | 20000          |
| <b>C150X075CBT</b> | White, vinyl cloth label.. | 1.50  | 38.1  | 0.75   | 19.1  | 5000           | 20000          |
| <b>C160X020CBT</b> | White, vinyl cloth label.  | 1.60  | 40.6  | 0.20   | 5.1   | 10000          | 40000          |
| <b>C160X020KBT</b> | White, polyimide label.    | 1.60  | 40.6  | 0.20   | 5.1   | 10000          | 40000          |
| <b>C160X020KCT</b> | Tan, polyimide label.      | 1.60  | 40.6  | 0.20   | 5.1   | 10000          | 40000          |
| <b>C160X020YJT</b> | White, polyester label.    | 1.60  | 40.6  | 0.20   | 5.1   | 10000          | 40000          |
| <b>C200X025KBT</b> | White, polyimide label.    | 2.00  | 50.8  | 0.25   | 6.4   | 5000           | 20000          |
| <b>C200X025KCT</b> | Tan, polyimide label.      | 2.00  | 50.8  | 0.25   | 6.4   | 5000           | 20000          |
| <b>C200X025YJT</b> | White, polyester label.    | 2.00  | 50.8  | 0.25   | 6.4   | 5000           | 20000          |
| <b>C200X038YJT</b> | White, polyester label.    | 2.00  | 50.8  | 0.38   | 9.7   | 5000           | 20000          |
| <b>C200X038KBT</b> | White, polyimide label.    | 2.00  | 50.8  | 0.38   | 9.7   | 5000           | 20000          |
| <b>C200X050CBT</b> | White, vinyl cloth label.  | 2.00  | 50.8  | 0.50   | 12.7  | 5000           | 20000          |
| <b>C200X050YJT</b> | White, polyester label.    | 2.00  | 50.8  | 0.50   | 12.7  | 5000           | 20000          |
| <b>C200X100YJT</b> | White, polyester label.    | 2.00  | 50.8  | 1.00   | 25.4  | 2500           | 10000          |
| <b>C200X100YKT</b> | Clear, polyester label.    | 2.00  | 50.8  | 1.00   | 25.4  | 2500           | 10000          |
| <b>C200X100YMT</b> | Silver, polyester label.   | 2.00  | 50.8  | 1.00   | 25.4  | 2500           | 10000          |
| <b>C275X125YMT</b> | Silver, polyester label.   | 2.75  | 69.9  | 1.25   | 31.8  | 2500           | 10000          |
| <b>C275X125YJT</b> | White, polyester label.    | 2.75  | 69.9  | 1.25   | 31.8  | 2500           | 10000          |
| <b>C275X125YMT</b> | Silver, polyester label.   | 2.75  | 69.9  | 1.25   | 31.8  | 2500           | 10000          |
| <b>C300X025KBT</b> | White, polyimide label.    | 3.00  | 76.2  | 0.25   | 6.4   | 5000           | 20000          |
| <b>C300X025KCT</b> | Tan, polyimide label.      | 3.00  | 76.2  | 0.25   | 6.4   | 5000           | 20000          |
| <b>C300X025YJT</b> | White, polyester label.    | 3.00  | 76.2  | 0.25   | 6.4   | 5000           | 20000          |
| <b>C300X038YJT</b> | White, polyester label.    | 3.00  | 76.2  | 0.38   | 9.7   | 5000           | 20000          |
| <b>C300X100YJT</b> | White, polyester label.    | 3.00  | 76.2  | 1.00   | 25.4  | 2500           | 10000          |
| <b>C300X100YMT</b> | Silver, polyester label.   | 3.00  | 76.2  | 1.00   | 25.4  | 2500           | 10000          |
| <b>C300X200YJT</b> | White, polyester label.    | 3.00  | 76.2  | 2.00   | 50.8  | 1000           | 4000           |
| <b>C300X200YMT</b> | Silver, polyester label.   | 3.00  | 76.2  | 2.00   | 50.8  | 1000           | 4000           |
| <b>C400X100CBT</b> | White, vinyl cloth label.  | 4.00  | 101.6 | 1.00   | 25.4  | 2500           | 10000          |
| <b>C400X100YJT</b> | White, polyester label.    | 4.00  | 101.6 | 1.00   | 25.4  | 2500           | 10000          |
| <b>C400X200YJT</b> | White, polyester label.    | 4.00  | 101.6 | 2.00   | 50.8  | 1000           | 4000           |
| <b>C400X200YMT</b> | Silver, polyester label..  | 4.00  | 101.6 | 2.00   | 50.8  | 1000           | 4000           |
| <b>C400X300YJT</b> | White, polyester label..   | 4.00  | 101.6 | 3.00   | 76.2  | 2500           | 10000          |
| <b>C400X400YJT</b> | White, polyester label.    | 4.00  | 101.6 | 4.00   | 101.6 | 1000           | 4000           |
| <b>C400X600PBT</b> | White, paper label.        | 4.00  | 101.6 | 6.00   | 152.4 | 1000           | 4000           |
| <b>C400X600YJT</b> | White, polyester label.    | 4.00  | 101.6 | 6.00   | 152.4 | 1000           | 4000           |

Order number of labels required in multiples of Std. Pkg. Qty.  
 Use with Panduit thermal transfer ribbons.  
 Labels roll mounted on 3.00" cores; when using the TDP43MY printer and 3.00" cores, the roll stand (TDP43M-RS) is required.

E5.  
Lockout/  
Tagout/  
& Safety  
Solutions

F.  
Index



## Thermal Transfer Tamper Evident Polyester Component Labels

• Labels offer crisp, clear legends with superior legibility

• Panduit labeling software packages include all label formats for quick and easy label production

| Part Number | Part Description   | Width |      | Length |      | Std. Pkg. Qty. | Std. Ctn. Qty. |
|-------------|--|-------|------|--------|------|----------------|----------------|
|             |  | In.   | mm   | In.    | mm   |                |                |
| C075X025AAT | Tamper-evident polyester, silver, for indoor/outdoor applications. | 0.75  | 19.1 | 0.25   | 6.4  | 10000          | 40000          |
| C100X050AAT | Tamper-evident polyester, silver, for indoor/outdoor applications. | 1.00  | 25.4 | 0.50   | 12.7 | 10000          | 40000          |
| C200X100AAT | Tamper-evident polyester, silver, for indoor/outdoor applications. | 2.00  | 50.8 | 1.00   | 25.4 | 2500           | 10000          |
| C275X125AAT | Tamper-evident polyester, silver, for indoor/outdoor applications. | 2.75  | 69.9 | 1.25   | 31.8 | 2500           | 10000          |

Order number of labels required in multiples of Std. Pkg. Qty.

Use with Panduit thermal transfer ribbons.

Labels roll mounted on 3.00" cores; when using the TDP43MY printer and 3.00" cores, the roll stand (TDP43M-RS) is required.

## Thermal Transfer Raised Panel Labels



• Raised thermal transfer printable surface with high-tack adhesive for strong holding power

• Variety of sizes and colors for a wide range of applications

• Thermal transfer print technology provides crisp, clear, and durable text

• Use with Panduit RMR4BL-A and RMR4WH resin thermal transfer ribbons



| Part Number | Part Description | Width |    | Height |    | Print-On Area Height |    | Hole Diameter |    | Std. Pkg. Qty. | Std. Ctn. Qty. |
|-------------|------------------|-------|----|--------|----|----------------------|----|---------------|----|----------------|----------------|
|             |                  | In.   | mm | In.    | mm | In.                  | mm | In.           | mm |                |                |

### Raised Panel Push Button Labels

|                |   |      |      |      |      |      |      |      |      |     |      |
|----------------|---|------|------|------|------|------|------|------|------|-----|------|
| C120X150APT-22 | White, raised panel component label.              | 1.20 | 30.5 | 1.50 | 38.1 | 0.45 | 11.4 | 0.87 | 22.0 | 500 | 2000 |
| C120X150A8T-22 | Yellow, raised panel component label.             | 1.20 | 30.5 | 1.50 | 38.1 | 0.45 | 11.4 | 0.87 | 22.0 | 500 | 2000 |
| C120X150AST-22 | Green, raised panel component label.              | 1.20 | 30.5 | 1.50 | 38.1 | 0.45 | 11.4 | 0.87 | 22.0 | 500 | 2000 |
| C120X150AWT-22 | Red, raised panel component label.                | 1.20 | 30.5 | 1.50 | 38.1 | 0.45 | 11.4 | 0.87 | 22.0 | 500 | 2000 |
| C120X150A0T-22 | Black, raised panel component label.              | 1.20 | 30.5 | 1.50 | 38.1 | 0.45 | 11.4 | 0.87 | 22.0 | 500 | 2000 |
| C120X150YK-22* | Clear, raised panel component overlaminate label. | 1.20 | 30.5 | 1.50 | 38.1 | —    | —    | 0.87 | 22.0 | 500 | 2000 |
| C120X190APT-22 | White, raised panel component label.              | 1.20 | 30.5 | 1.90 | 48.3 | 0.85 | 21.6 | 0.87 | 22.0 | 500 | 2000 |
| C120X190A8T-22 | Yellow, raised panel component label.             | 1.20 | 30.5 | 1.90 | 48.3 | 0.85 | 21.6 | 0.87 | 22.0 | 500 | 2000 |
| C120X190AST-22 | Green, raised panel component label.              | 1.20 | 30.5 | 1.90 | 48.3 | 0.85 | 21.6 | 0.87 | 22.0 | 500 | 2000 |
| C120X190AWT-22 | Red, raised panel component label.                | 1.20 | 30.5 | 1.90 | 48.3 | 0.85 | 21.6 | 0.87 | 22.0 | 500 | 2000 |
| C120X190A0T-22 | Black, raised panel component label.              | 1.20 | 30.5 | 1.90 | 48.3 | 0.85 | 21.6 | 0.87 | 22.0 | 500 | 2000 |
| C120X190YK-22* | Clear, raised panel component overlaminate label. | 1.20 | 30.5 | 1.90 | 48.3 | —    | —    | 0.87 | 22.0 | 500 | 2000 |

\*Cannot print on overlaminate labels.

Order number of labels required in multiples of Std. Pkg. Qty.

Table continues on page E2.20

A. System Overview

## Thermal Transfer Raised Panel Labels (continued)

B1. Cable Ties

B2. Cable Accessories

B3. Stainless Steel Ties

C1. Wiring Duct

C2. Surface Raceway

C3. Abrasion Protection

C4. Cable Management

D1. Terminals

D2. Power Connectors

D3. Grounding Connectors

E1. Labeling Systems

E2. Labels

E3. Pre-Printed & Write-On Markers

E4. Permanent Identification

E5. Lockout/Tagout & Safety Solutions

F. Index

| Part Number           | Part Description                                | Width |      | Height |      | Print-On Area Height |      | Hole Diameter |      | Std. Pkg. Qty. | Std. Ctn. Qty. |
|-----------------------|---|-------|------|--------|------|----------------------|------|---------------|------|----------------|----------------|
|                       |   | In.   | mm   | In.    | mm   | In.                  | mm   | In.           | mm   |                |                |
| <b>C180X180APT-30</b> | White, raised panel component label.            | 1.80  | 45.7 | 1.80   | 45.7 | 0.36                 | 9.1  | 1.18          | 30.0 | 500            | 2000           |
| <b>C180X180A8T-30</b> | Yellow, raised panel component label.           | 1.80  | 45.7 | 1.80   | 45.7 | 0.36                 | 9.1  | 1.18          | 30.0 | 500            | 2000           |
| <b>C180X180AST-30</b> | Green, raised panel component label.            | 1.80  | 45.7 | 1.80   | 45.7 | 0.36                 | 9.1  | 1.18          | 30.0 | 500            | 2000           |
| <b>C180X180AWT-30</b> | Red, raised panel component label.              | 1.80  | 45.7 | 1.80   | 45.7 | 0.36                 | 9.1  | 1.18          | 30.0 | 500            | 2000           |
| <b>C180X180A0T-30</b> | Black, raised panel component label.            | 1.80  | 45.7 | 1.80   | 45.7 | 0.36                 | 9.1  | 1.18          | 30.0 | 500            | 2000           |
| <b>C180X180YK-30*</b> | Clear, raised panel component overlamine label. | 1.80  | 45.7 | 1.80   | 45.7 | —                    | —    | 1.18          | 30.0 | 500            | 2000           |
| <b>C240X240APT-30</b> | White, raised panel component label.            | 2.40  | 61.0 | 2.40   | 61.0 | 0.90                 | 22.9 | 1.18          | 30.0 | 500            | 2000           |
| <b>C240X240A8T-30</b> | Yellow, raised panel component label.           | 2.40  | 60.9 | 2.40   | 60.9 | 0.90                 | 22.9 | 1.18          | 30.0 | 500            | 2000           |
| <b>C240X240AST-30</b> | Green, raised panel component label.            | 2.40  | 60.9 | 2.40   | 60.9 | 0.90                 | 22.9 | 1.18          | 30.0 | 500            | 2000           |
| <b>C240X240AWT-30</b> | Red, raised panel component label.              | 2.40  | 60.9 | 2.40   | 60.9 | 0.90                 | 22.9 | 1.18          | 30.0 | 500            | 2000           |
| <b>C240X240A0T-30</b> | Black, raised panel component label.            | 2.40  | 60.9 | 2.40   | 60.9 | 0.90                 | 22.9 | 1.18          | 30.0 | 500            | 2000           |
| <b>C240X240YK-30*</b> | Clear, raised panel component overlamine label. | 2.40  | 60.9 | 2.40   | 60.9 | —                    | —    | 1.18          | 30.0 | 500            | 2000           |

### Raised Panel Component Labels

|                    |   |      |       |      |      |      |      |   |   |     |      |
|--------------------|---|------|-------|------|------|------|------|---|---|-----|------|
| <b>C100X050APT</b> | White, raised panel component label.            | 1.00 | 25.4  | 0.50 | 12.7 | 0.50 | 12.7 | — | — | 500 | 2000 |
| <b>C100X050A8T</b> | Yellow, raised panel component label.           | 1.00 | 25.4  | 0.50 | 12.7 | 0.50 | 12.7 | — | — | 500 | 2000 |
| <b>C100X050AST</b> | Green, raised panel component label.            | 1.00 | 25.4  | 0.50 | 12.7 | 0.50 | 12.7 | — | — | 500 | 2000 |
| <b>C100X050AWT</b> | Red, raised panel component label.              | 1.00 | 25.4  | 0.50 | 12.7 | 0.50 | 12.7 | — | — | 500 | 2000 |
| <b>C100X050A0T</b> | Black, raised panel component label.            | 1.00 | 25.4  | 0.50 | 12.7 | 0.50 | 12.7 | — | — | 500 | 2000 |
| <b>C100X050AMT</b> | Silver, raised panel component label.           | 1.00 | 25.4  | 0.50 | 12.7 | 0.50 | 12.7 | — | — | 500 | 2000 |
| <b>C200X100APT</b> | White, raised panel component label.            | 2.00 | 50.8  | 1.00 | 25.4 | 1.00 | 25.4 | — | — | 500 | 2000 |
| <b>C200X100A8T</b> | Yellow, raised panel component label.           | 2.00 | 50.8  | 1.00 | 25.4 | 1.00 | 25.4 | — | — | 500 | 2000 |
| <b>C200X100AST</b> | Green, raised panel component label.            | 2.00 | 50.8  | 1.00 | 25.4 | 1.00 | 25.4 | — | — | 500 | 2000 |
| <b>C200X100AWT</b> | Red, raised panel component label.              | 2.00 | 50.8  | 1.00 | 25.4 | 1.00 | 25.4 | — | — | 500 | 2000 |
| <b>C200X100A0T</b> | Black, raised panel component label.            | 2.00 | 50.8  | 1.00 | 25.4 | 1.00 | 25.4 | — | — | 500 | 2000 |
| <b>C200X100AMT</b> | Silver, raised panel component label.           | 2.00 | 50.8  | 1.00 | 25.4 | 1.00 | 25.4 | — | — | 500 | 2000 |
| <b>C200X100YK*</b> | Clear, raised panel component overlamine label. | 2.00 | 50.8  | 1.00 | 25.4 | —    | —    | — | — | 500 | 2000 |
| <b>C300X100APT</b> | White, raised panel component label.            | 3.00 | 76.2  | 1.00 | 25.4 | 1.00 | 25.4 | — | — | 500 | 2000 |
| <b>C300X100A8T</b> | Yellow, raised panel component label.           | 3.00 | 76.2  | 1.00 | 25.4 | 1.00 | 25.4 | — | — | 500 | 2000 |
| <b>C300X100A0T</b> | Black, raised panel component label.            | 3.00 | 76.2  | 1.00 | 25.4 | 1.00 | 25.4 | — | — | 500 | 2000 |
| <b>C300X250APT</b> | White, raised panel component label.            | 3.00 | 76.2  | 2.50 | 63.5 | 2.50 | 63.5 | — | — | 500 | 2000 |
| <b>C300X250A8T</b> | Yellow, raised panel component label.           | 3.00 | 76.2  | 2.50 | 63.5 | 2.50 | 63.5 | — | — | 500 | 2000 |
| <b>C300X250AST</b> | Green, raised panel component label.            | 3.00 | 76.2  | 2.50 | 63.5 | 2.50 | 63.5 | — | — | 500 | 2000 |
| <b>C300X250AWT</b> | Red, raised panel component label.              | 3.00 | 76.2  | 2.50 | 63.5 | 2.50 | 63.5 | — | — | 500 | 2000 |
| <b>C300X250A0T</b> | Black, raised panel component label.            | 3.00 | 76.2  | 2.50 | 63.5 | 2.50 | 63.5 | — | — | 500 | 2000 |
| <b>C300X250AMT</b> | Silver, raised panel component label.           | 3.00 | 76.2  | 2.50 | 63.5 | 2.50 | 63.5 | — | — | 500 | 2000 |
| <b>C300X250YK*</b> | Clear, raised panel component overlamine label. | 3.00 | 76.2  | 2.50 | 63.5 | —    | —    | — | — | 500 | 2000 |
| <b>C400X100APT</b> | White, raised panel component label.            | 4.00 | 101.6 | 1.00 | 25.4 | 1.00 | 25.4 | — | — | 500 | 2000 |
| <b>C400X100A8T</b> | Yellow, raised panel component label.           | 4.00 | 101.6 | 1.00 | 25.4 | 1.00 | 25.4 | — | — | 500 | 2000 |
| <b>C400X100AST</b> | Green, raised panel component label.            | 4.00 | 101.6 | 1.00 | 25.4 | 1.00 | 25.4 | — | — | 500 | 2000 |
| <b>C400X100AWT</b> | Red, raised panel component label.              | 4.00 | 101.6 | 1.00 | 25.4 | 1.00 | 25.4 | — | — | 500 | 2000 |
| <b>C400X100A0T</b> | Black, raised panel component label.            | 4.00 | 101.6 | 1.00 | 25.4 | 1.00 | 25.4 | — | — | 500 | 2000 |
| <b>C400X100AMT</b> | Silver, raised panel component label.           | 4.00 | 101.6 | 1.00 | 25.4 | 1.00 | 25.4 | — | — | 500 | 2000 |
| <b>C400X100YK*</b> | Clear, raised panel component overlamine label. | 4.00 | 101.6 | 1.00 | 25.4 | —    | —    | — | — | 500 | 2000 |

\*Cannot print on overlamine labels.  
Order number of labels required in multiples of Std. Pkg. Qty.

## Thermal Transfer Continuous Tapes

- Tapes offer crisp, clear legends with superior legibility
- Available in continuous color vinyl or clear polyester and supplied on rolls

- Panduit labeling software packages include all label formats for quick and easy label production



## Part Number System for Continuous Tapes

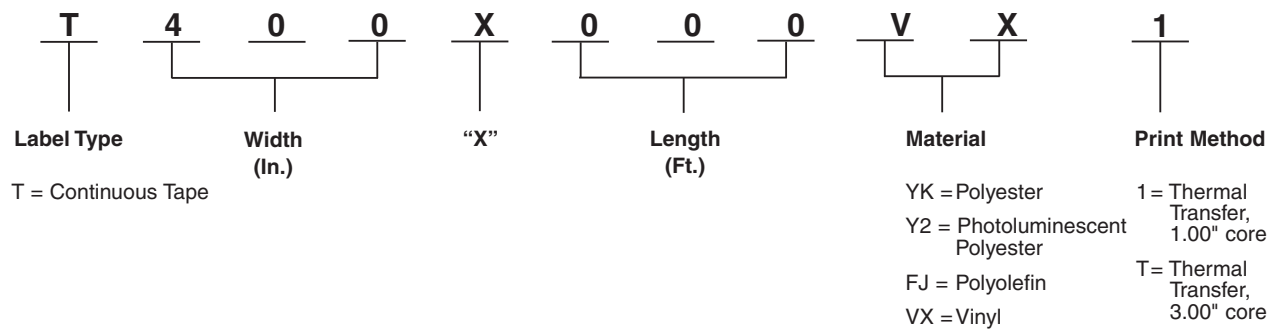

## Material/Print Method Selection Guide

| Material   | Print Method         | Temperature Range                  | Features   |
|--|----------------------|------------------------------------|--|
| Polyester, Clear (YK)  | Thermal Transfer (T) | -51°F to 275°F<br>(-46°C to 135°C) | Indoor/outdoor rated; provides durability, high temperature resistance, and dimensional stability; does not stretch or easily tear                   |
| Vinyl, Yellow (VX)<br>Black (VY)<br>Blue (VQ)<br>Brown (VR)<br>Gray (VT)<br>Green (VS)<br>Orange (VU)<br>Purple (VV)<br>Red (VW)<br>White (VP) |                      | -58°F to 176°F<br>(-50°C to 80°C)  | Indoor/outdoor rated; conformable material for flat applications and safety and facility identification; can be overlaminated to increase durability |

Table continues on page E2.22

A.  
System  
Overview

## Thermal Transfer Continuous Tapes (continued)

B1.  
Cable Ties

B2.  
Cable Accessories

B3.  
Stainless  
Steel Ties

C1.  
Wiring  
Duct

C2.  
Surface Raceway

C3.  
Abrasion  
Protection

C4.  
Cable  
Management

D1.  
Terminals

D2.  
Power Connectors

D3.  
Grounding  
Connectors

E1.  
Labeling Systems

E2.  
Labels

E3.  
Pre-Printed  
& Write-On  
Markers

E4.  
Permanent  
Identification

E5.  
Lockout/  
Tagout  
& Safety  
Solutions

F.  
Index

| Part Number         | Part Description       | Height |       | Length |      | Std. Pkg. Qty. | Std. Ctn. Qty. |
|---------------------|------------------------|--------|-------|--------|------|----------------|----------------|
|                     |                        | In.    | mm    | Ft.    | m    |                |                |
| <b>T100X000VP1Y</b> | White, vinyl tape.     | 1.00   | 25.4  | 100.0  | 30.5 | 1              | 4              |
| <b>T100X000VQ1Y</b> | Blue, vinyl tape.      | 1.00   | 25.4  | 100.00 | 30.5 | 1              | 4              |
| <b>T100X000VS1Y</b> | Green, vinyl tape.     | 1.00   | 25.4  | 100.00 | 30.5 | 1              | 4              |
| <b>T100X000VU1Y</b> | Orange, vinyl tape.    | 1.00   | 25.40 | 100.0  | 30.5 | 1              | 4              |
| <b>T100X000VW1Y</b> | Red, vinyl tape.       | 1.00   | 25.4  | 100.00 | 30.5 | 1              | 4              |
| <b>T100X000VX1Y</b> | Yellow, vinyl tape.    | 1.00   | 25.40 | 100.0  | 30.5 | 1              | 4              |
| <b>T100X000VY1Y</b> | Black, vinyl tape.     | 1.00   | 25.4  | 100.00 | 30.5 | 1              | 4              |
| <b>T100X000YK1</b>  | Clear, polyester tape. | 1.00   | 25.4  | 100.00 | 30.5 | 1              | 4              |
| <b>T200X000VP1Y</b> | White, vinyl tape.     | 2.00   | 50.8  | 100.0  | 30.5 | 1              | 4              |
| <b>T200X000VQ1Y</b> | Blue, vinyl tape.      | 2.00   | 50.80 | 100.0  | 30.5 | 1              | 4              |
| <b>T200X000VS1Y</b> | Green, vinyl tape.     | 2.00   | 50.8  | 100.0  | 30.5 | 1              | 4              |
| <b>T200X000VU1Y</b> | Orange, vinyl tape.    | 2.00   | 50.8  | 100.0  | 30.5 | 1              | 4              |
| <b>T200X000VV1Y</b> | Purple, vinyl tape.    | 2.00   | 50.8  | 100.0  | 30.5 | 1              | 4              |
| <b>T200X000VW1Y</b> | Red, vinyl tape.       | 2.00   | 50.8  | 100.0  | 30.5 | 1              | 4              |
| <b>T200X000VX1Y</b> | Yellow, vinyl tape.    | 2.00   | 50.8  | 100.0  | 30.5 | 1              | 4              |
| <b>T200X000VY1Y</b> | Black, vinyl tape.     | 2.00   | 50.8  | 100.0  | 30.5 | 1              | 4              |
| <b>T200X000YK1</b>  | Clear, polyester tape. | 2.00   | 50.8  | 100.0  | 30.5 | 1              | 4              |
| <b>T225X000YK1</b>  | Clear, polyester tape. | 2.25   | 57.2  | 100.0  | 30.5 | 1              | 4              |
| <b>T400X000VP1Y</b> | White, vinyl tape.     | 4.00   | 101.6 | 100.0  | 30.5 | 1              | 4              |
| <b>T400X000VQ1Y</b> | Blue, vinyl tape.      | 4.00   | 101.6 | 100.0  | 30.5 | 1              | 4              |
| <b>T400X000VS1Y</b> | Green, vinyl tape.     | 4.00   | 101.6 | 100.0  | 30.5 | 1              | 4              |
| <b>T400X000VU1Y</b> | Orange, vinyl tape.    | 4.00   | 101.6 | 100.0  | 30.5 | 1              | 4              |
| <b>T400X000VV1Y</b> | Purple, vinyl tape.    | 4.00   | 101.6 | 100.0  | 30.5 | 1              | 4              |
| <b>T400X000VW1Y</b> | Red, vinyl tape.       | 4.00   | 101.6 | 100.0  | 30.5 | 1              | 4              |
| <b>T400X000VX1Y</b> | Yellow, vinyl tape.    | 4.00   | 101.6 | 100.0  | 30.5 | 1              | 4              |
| <b>T400X000VY1Y</b> | Black, vinyl tape.     | 4.00   | 101.6 | 100.0  | 30.5 | 1              | 4              |
| <b>T400X000YK1</b>  | Clear, polyester tape. | 4.00   | 101.6 | 100.0  | 30.5 | 1              | 4              |
| <b>T425X000YK1</b>  | Clear, polyester tape. | 4.25   | 107.9 | 100.0  | 30.5 | 1              | 4              |

Order number of rolls required.

Use with Panduit thermal transfer ribbons.

Labels roll mounted on 3.00" cores; when using the TDP43MY printer and 3.00" cores, the roll stand (TDP43M-RS) is required.

## Size Illustrations of Self-Laminating Labels

The following table lists the part numbers and their corresponding dimensions as shown in the illustrations:

| Part Number | Dimensions (Approximate) |
|-------------|--------------------------|
| S050X075*   | Small rectangular label  |
| S050X125*   | Medium rectangular label |
| S050X150*   | Medium rectangular label |
| S075X075*   | Small rectangular label  |
| S075X125*   | Medium rectangular label |
| S075X150*   | Medium rectangular label |
| S100X075*   | Small rectangular label  |
| S100X125*   | Medium rectangular label |
| S100X150*   | Medium rectangular label |
| S100X225*   | Medium rectangular label |
| S100X400*   | Large rectangular label  |
| S150X150*   | Medium rectangular label |
| S150X225*   | Medium rectangular label |
| S150X400*   | Large rectangular label  |

\*Represents material type and print method of part number.

A.  
System  
Overview

B1.  
Cable Ties

B2.  
Cable  
Accessories

B3.  
Stainless  
Steel Ties

C1.  
Wiring  
Duct

C2.  
Surface  
Raceway

C3.  
Abrasion  
Protection

C4.  
Cable  
Management

D1.  
Terminals

D2.  
Power  
Connectors

D3.  
Grounding  
Connectors

E1.  
Labeling  
Systems

E2.  
Labels

E3.  
Pre-Printed  
& Write-On  
Markers

E4.  
Permanent  
Identification

E5.  
Lockout/  
Tagout  
& Safety  
Solutions

F.  
Index

## Size Illustrations of Self-Laminating Labels (continued)

|     |                                   |
|-----|-----------------------------------|
| A.  | System Overview                   |
| B1. | Cable Ties                        |
| B2. | Cable Accessories                 |
| B3. | Stainless Steel Ties              |
| C1. | Wiring Duct                       |
| C2. | Surface Raceway                   |
| C3. | Abrasion Protection               |
| C4. | Cable Management                  |
| D1. | Terminals                         |
| D2. | Power Connectors                  |
| D3. | Grounding Connectors              |
| E1. | Labeling Systems                  |
| E2. | Labels                            |
| E3. | Pre-Printed & Write-On Markers    |
| E4. | Permanent Identification          |
| E5. | Lockout/Tagout & Safety Solutions |
| F.  | Index                             |

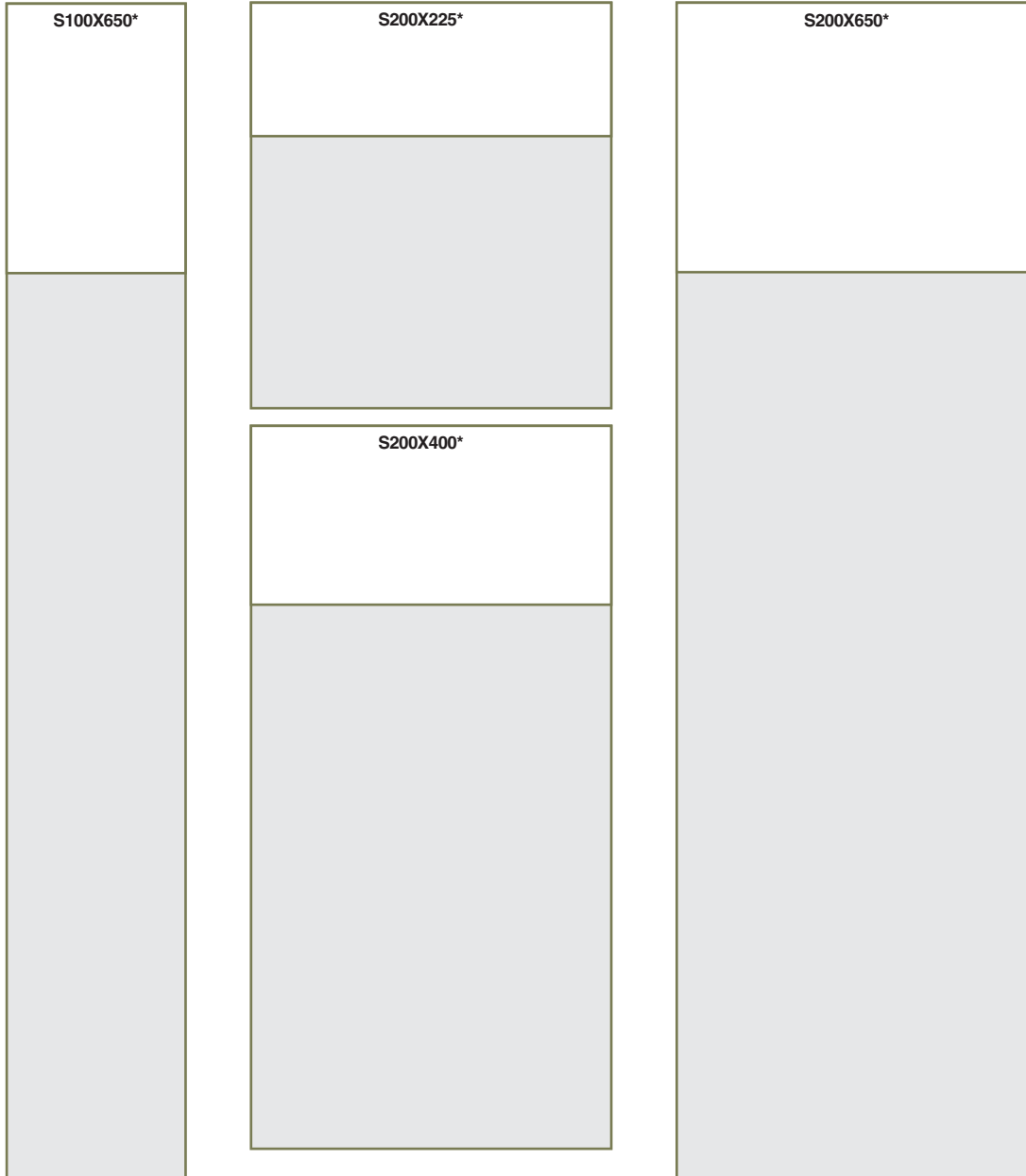

\*Represents material type and print method of part number.



## Size Illustrations of Non-Laminated and Flag Style Labels

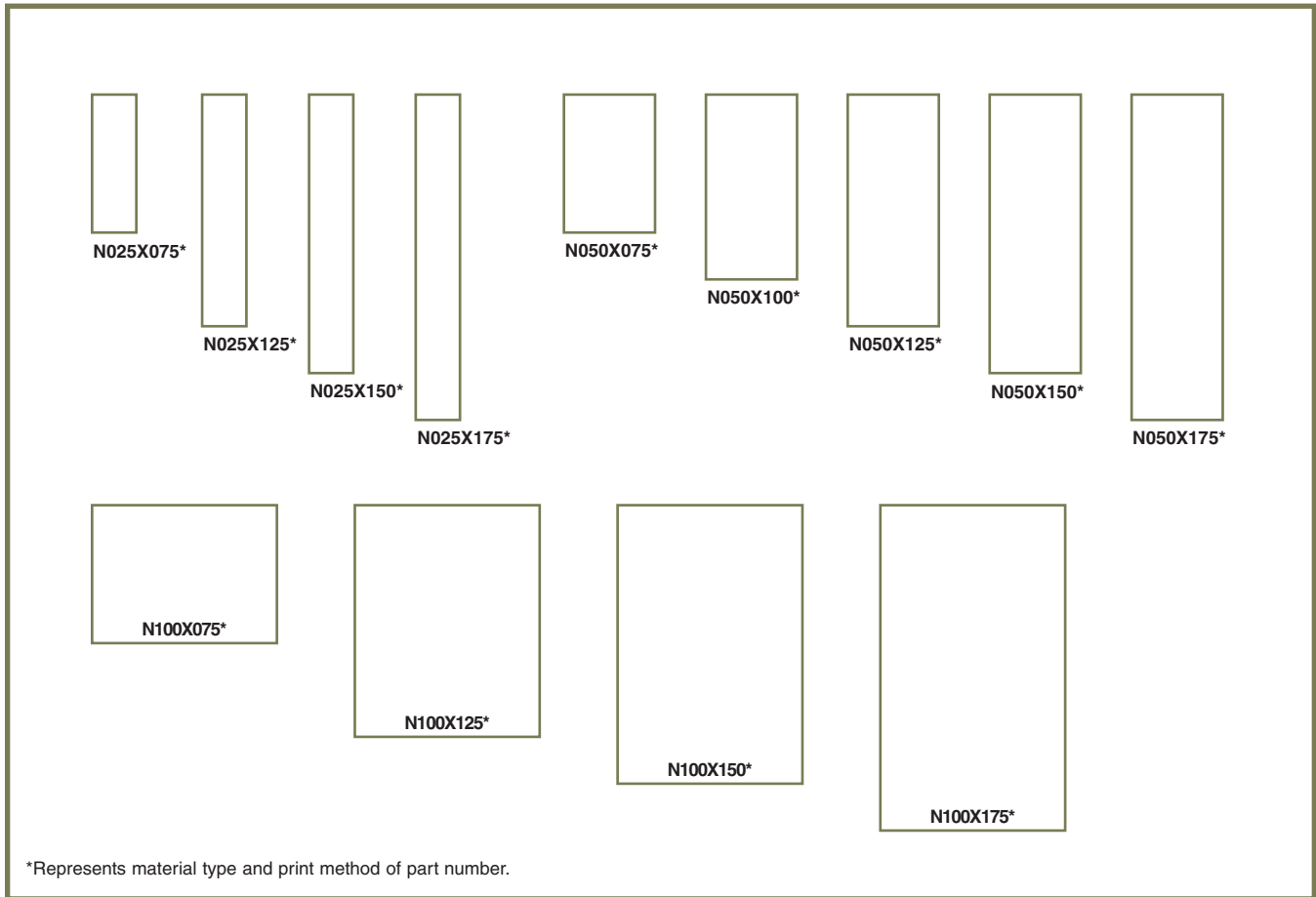

A.  
System  
Overview

B1.  
Cable  
Ties

B2.  
Cable  
Accessories

B3.  
Stainless  
Steel Ties

C1.  
Wiring  
Duct

C2.  
Surface  
Raceway

C3.  
Abrasion  
Protection

C4.  
Cable  
Management

D1.  
Terminals

D2.  
Power  
Connectors

D3.  
Grounding  
Connectors

E1.  
Labeling  
Systems

E2.  
Labels

E3.  
Pre-Printed  
& Write-On  
Markers

E4.  
Permanent  
Identification

E5.  
Lockout/  
Tagout  
& Safety  
Solutions

F.  
Index

## Size Illustrations of Flattened Heat Shrink Labels

A. System Overview

B1. Cable Ties

B2. Cable Accessories

B3. Stainless Steel Ties

C1. Wiring Duct

C2. Surface Raceway

C3. Abrasion Protection

C4. Cable Management

D1. Terminals

D2. Power Connectors

D3. Grounding Connectors

E1. Labeling Systems

E2. Labels

E3. Pre-Printed & Write-On Markers

E4. Permanent Identification

E5. Lockout/Tagout & Safety Solutions

F. Index



H050X025\*



H050X034\*



H050X044\*



H050X064\*



H075X025\*



H075X034\*



H075X044\*



H100X025\*



H100X034\*



H100X044\*



H100X064\*



H100X084\*



H100X165\*



H150X025\*



H150X034\*



H150X044\*



H200X025\*



H200X034\*



H200X044\*



H200X064\*



H200X084\*

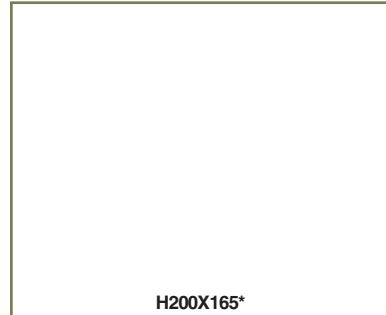

H200X165\*

\*Represents material type and print method of part number.

## Size Illustrations for Component Labels

The following table lists the part numbers and their corresponding dimensions as shown in the illustrations:

| Part Number | Dimensions (Approximate)      |
|-------------|-------------------------------|
| C025X025*   | Small square                  |
| C038X038*   | Small square                  |
| C050X044*   | Small square                  |
| C060X020*   | Small horizontal rectangle    |
| C075X025*   | Small horizontal rectangle    |
| C080X020*   | Small horizontal rectangle    |
| C100X025*   | Small horizontal rectangle    |
| C100X050*   | Medium horizontal rectangle   |
| C150X075*   | Medium horizontal rectangle   |
| C160X020*   | Small horizontal rectangle    |
| C200X050*   | Medium horizontal rectangle   |
| C200X075*   | Medium horizontal rectangle   |
| C200X100*   | Medium horizontal rectangle   |
| C300X100*   | Large horizontal rectangle    |
| C400X100*   | Large horizontal rectangle    |
| C400X200*   | Large horizontal rectangle    |
| C225X450*   | Very large vertical rectangle |

\*Represents material type and print method of part number.

A.  
System  
Overview

B1.  
Cable Ties

B2.  
Cable  
Accessories

B3.  
Stainless  
Steel Ties

C1.  
Wiring  
Duct

C2.  
Surface  
Raceway

C3.  
Abrasion  
Protection

C4.  
Cable  
Management

D1.  
Terminals

D2.  
Power  
Connectors

D3.  
Grounding  
Connectors

E1.  
Labeling  
Systems

E2.  
Labels

E3.  
Pre-Printed  
& Write-On  
Markers

E4.  
Permanent  
Identification

E5.  
Lockout/  
Tagout  
& Safety  
Solutions

F.  
Index

## Size Illustrations for Component Labels (continued)

|     |                                   |
|-----|-----------------------------------|
| A.  | System Overview                   |
| B1. | Cable Ties                        |
| B2. | Cable Accessories                 |
| B3. | Stainless Steel Ties              |
| C1. | Wiring Duct                       |
| C2. | Surface Raceway                   |
| C3. | Abrasion Protection               |
| C4. | Cable Management                  |
| D1. | Terminals                         |
| D2. | Power Connectors                  |
| D3. | Grounding Connectors              |
| E1. | Labeling Systems                  |
| E2. | Labels                            |
| E3. | Pre-Printed & Write-On Markers    |
| E4. | Permanent Identification          |
| E5. | Lockout/Tagout & Safety Solutions |
| F.  | Index                             |

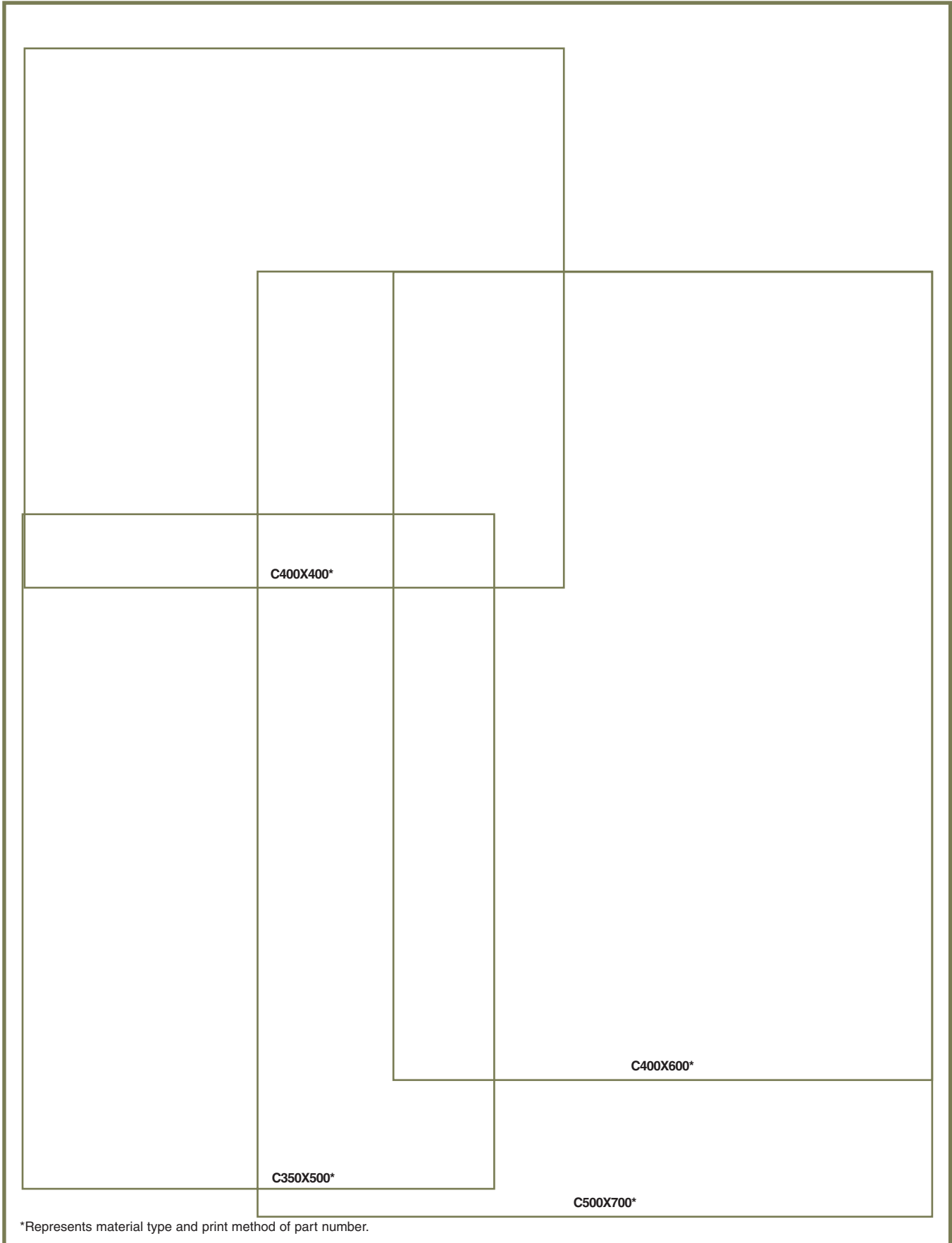

\*Represents material type and print method of part number.

## PRE-PRINTED AND WRITE-ON MARKERS

Panduit offers a variety of pre-printed and write-on marker solutions in multiple formats to meet your specific requirements.



- Marker books are a convenient pocket-sized method to identify many electrical and network components
- Marker cards are available in a variety of legends and combination packs
- Dispensers are available in both pre-printed and write-on formats for quick identification of wire/cable
- Clip-on markers provide a fast, convenient, non-adhesive method to identify wire/cable

Panduit offers a variety of innovative books, cards, clip-ons and dispensers to provide you with the wire/cable label that best fits your needs.

A.  
System  
Overview

B1.  
Cable Ties

B2.  
Cable  
Accessories

B3.  
Stainless  
Steel Ties

C1.  
Wiring  
Duct

C2.  
Surface  
Raceway

C3.  
Abrasion  
Protection

C4.  
Cable  
Management

D1.  
Terminals

D2.  
Power  
Connectors

D3.  
Grounding  
Connectors

E1.  
Labeling  
Systems

E2.  
Labels

E3.  
Pre-Printed  
& Write-On  
Markers

E4.  
Permanent  
Identification

E5.  
Lockout/  
Tagout/  
& Safety  
Solutions

F.  
Index

A. System Overview

## Pre-Printed Marker Books

B1. Cable Ties

- Convenient, pocket-sized book
- Markers are perforated and can be torn in half to mark both ends of conductors

- Terminal block markers are included to properly identify connectors
- Ten pages of markers per book

B2. Cable Accessories

B3. Stainless Steel Ties

C1. Wiring Duct

C2. Surface Raceway

C3. Abrasion Protection

C4. Cable Management

D1. Terminals

D2. Power Connectors

D3. Grounding Connectors

E1. Labeling Systems

E2. Labels

E3. Pre-Printed & Write-On Markers

E4. Permanent Identification

E5. Lockout/Tagout & Safety Solutions

F. Index

### Material Chart

| Material           | Print Method | Temperature Range                 | Features   |
|--------------------|--------------|-----------------------------------|--|
| Vinyl Cloth, White | Pre-Printed  | -50°F to 170°F<br>(-46°C to 77°C) | Indoor/outdoor rated; conformable material with repositionable adhesive allows label to be removed and reused or used in temporary applications; provides durability, high temperature resistance, and dimensional stability for rough or textured surfaces; resists oil and abrasion. |

### Perforation for half marker

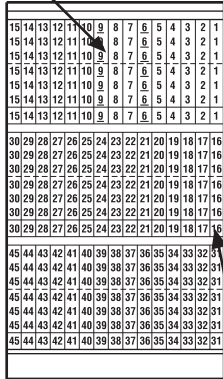

### Terminal Block Marker

| Part Number    | Legend  | Total Markers Each Legend | Std. Pkg. Book(s) | Std. Ctn. Book(s) |
|----------------|---|---------------------------|-------------------|-------------------|
| <b>PCMB-1</b>  | 0 thru 9  | 45                        | 1                 | 10                |
| <b>PCMB-2</b>  | A thru Z, 0 thru 15, +, -, /  | 10                        | 1                 | 10                |
| <b>PCMB-3</b>  | 1 thru 45   | 10                        | 1                 | 10                |
| <b>PCMB-4</b>  | 1, 2, 3   | 150                       | 1                 | 10                |
| <b>PCMB-5</b>  | A, B, C   | 150                       | 1                 | 10                |
| <b>PCMB-6</b>  | T1, T2, T3  | 150                       | 1                 | 10                |
| <b>PCMB-7</b>  | L1, L2, L3  | 150                       | 1                 | 10                |
| <b>PCMB-8</b>  | 1 thru 15<br>16 thru 90<br>A thru Z, +, -, /, 0   | 6<br>4<br>2               | 1                 | 10                |
| <b>PCMB-9</b>  | 1, 2, 3, A, B, C<br>L1, L2, L3, T1, T2, T3  | 45<br>30                  | 1                 | 10                |
| <b>PCMB-10</b> | Solid NEMA colors red, yellow, white, light blue, light green, black, brown, orange, gray, dark green | 45                        | 1                 | 10                |
| <b>PCMB-11</b> | 1 thru 30   | 15                        | 1                 | 10                |
| <b>PCMB-12</b> | A thru Z<br>+<br>-<br>Blank (write-on)  | 15<br>8<br>7<br>21        | 1                 | 10                |
| <b>PCMB-13</b> | + , - , AC, DC<br>POS, NEG, GND<br>NEUT<br>SPARE, Blank (write-on)                                    | 45<br>21<br>21<br>21      | 1                 | 10                |
| <b>PCMB-14</b> | 46 thru 90  | 10                        | 1                 | 10                |
| <b>PCMB-15</b> | 0, +, -<br>1 thru 45  | 15<br>10                  | 1                 | 10                |
| <b>PCMB-16</b> | 0 thru 33, A, B, C, +, -, L1, L2, L3, T1, T2, T3  | 10                        | 1                 | 10                |
| <b>PCMB-25</b> | 0 thru 9<br>L1, L2, L3, T1, T2, T3  | 45<br>15                  | 1                 | 10                |

Legend: Black Background: White

Marker sizes:

Full size marker – .22" x 1.38" (5.60mm x 34.90mm). Maximum wire O.D., .38" (9.50mm).

Half size marker – .22" x .69" (5.60mm x 17.40mm). Maximum wire O.D., .19" (4.70mm).

Terminal block marker – .22" x .25" (5.60mm x 6.30mm).



## Blank Self-Laminating Write-On Cable Marker Books

- 10 pages of markers per book
- Clear section of marker over laminates and protects printed legend
- Markers have ink receptive area to allow handwritten legends



| Part Number | Width |      | Length |       | Markers Per Book | Std. Pkg. Book(s) | Std. Ctn. Book(s) |
|-------------|-------|------|--------|-------|------------------|-------------------|-------------------|
|             | In.   | mm   | In.    | mm    |                  |                   |                   |
| PSCB-12Y    | 0.50  | 12.7 | 1.50   | 38.1  | 180              | 1                 | 10                |
| PSCB-13Y    | 1.50  | 38.1 | 3.00   | 76.2  | 40               | 1                 | 10                |
| PSCB-16Y    | 1.50  | 38.1 | 6.00   | 152.4 | 20               | 1                 | 10                |
| PSCB-3Y     | 1.00  | 25.4 | 3.00   | 76.2  | 60               | 1                 | 10                |
| PSCB-3YELY* | 1.00  | 25.4 | 3.00   | 76.2  | 60               | 1                 | 10                |
| PSCB-5Y     | 1.00  | 25.4 | 5.00   | 127.0 | 30               | 1                 | 10                |
| PSCB-6Y     | 1.00  | 25.4 | 6.00   | 152.4 | 30               | 1                 | 10                |

\*Yellow.

A.  
System  
Overview

B1.  
Cable Ties

B2.  
Cable  
Accessories

B3.  
Stainless  
Steel Ties

C1.  
Wiring  
Duct

C2.  
Surface  
Raceway

C3.  
Abrasion  
Protection

C4.  
Cable  
Management

D1.  
Terminals

D2.  
Power  
Connectors

D3.  
Grounding  
Connectors

E1.  
Labeling  
Systems

E2.  
Labels

E3.  
Pre-Printed  
& Write-On  
Markers

E4.  
Permanent  
Identification

E5.  
Lockout/  
Tagout  
& Safety  
Solutions

F.  
Index

A. System Overview

## Pre-Printed Marker Cards PCM Type

B1. Cable Ties

• Marker cards printed in a variety of legends allows “kitting” for project builds

• Plastic liner provides easy removal of markers while protecting unused markers

B2. Cable Accessories



B3. Stainless Steel Ties

### Material Chart

| Material           | Print Method | Temperature Range                 | Features   |
|--------------------|--------------|-----------------------------------|--|
| Vinyl Cloth, White | Pre-Printed  | -50°F to 170°F<br>(-46°C to 77°C) | Indoor/outdoor rated; conformable material with repositionable adhesive allows label to be removed and reused or used in temporary applications; provides durability, high temperature resistance, and dimensional stability for rough or textured surfaces; resists oil and abrasion. |

C1. Wiring Duct

C2. Surface Raceway



PCM-7

C3. Abrasion Protection

C4. Cable Management

D1. Terminals

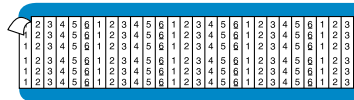

PCM-1-6

D2. Power Connectors

D3. Grounding Connectors

E1. Labeling Systems

E2. Labels

E3. Pre-Printed & Write-On Markers

E4. Permanent Identification

E5. Lockout/Tagout & Safety Solutions

F. Index

| Part Number        | Legend       | Width |      | Length |       | Markers Per Card | Std. Pkg. Card(s) | Std. Ctn. Card(s) |
|--------------------|--------------|-------|------|--------|-------|------------------|-------------------|-------------------|
|                    |              | In.   | mm   | In.    | mm    |                  |                   |                   |
| <b>PCM-0</b>       | 0            | 0.25  | 6.35 | 1.50   | 38.1  | 36               | 25                | 100               |
| thru               | thru         |       |      |        |       |                  |                   |                   |
| <b>PCM-99</b>      | 99           |       |      |        |       |                  |                   |                   |
| <b>PCM-100</b>     | 100          | 0.36  | 9.14 | 1.50   | 38.1  | 25               | 25                | 100               |
| thru               | thru         |       |      |        |       |                  |                   |                   |
| <b>PCM-202</b>     | 202          |       |      |        |       |                  |                   |                   |
| <b>PCMH-0</b>      | 0            | 0.25  | 6.35 | 1.50   | 38.1  | 72               | 25                | 100               |
| thru               | thru         |       |      |        |       |                  |                   |                   |
| <b>PCMH-25</b>     | 25           |       |      |        |       |                  |                   |                   |
| <b>PCM-1-3</b>     | 1 thru 3     | 0.25  | 6.35 | 1.50   | 38.10 | 36               | 25                | 100               |
| <b>PCM-1-4</b>     | 1 thru 4     |       |      |        |       |                  |                   |                   |
| <b>PCM-1-5</b>     | 1 thru 5     |       |      |        |       |                  |                   |                   |
| <b>PCM-1-6</b>     | 1 thru 6     |       |      |        |       |                  |                   |                   |
| <b>PCM-1-8</b>     | 1 thru 8     |       |      |        |       |                  |                   |                   |
| <b>PCM-1-9</b>     | 1 thru 9     |       |      |        |       |                  |                   |                   |
| <b>PCM-0-9</b>     | 0 thru 9     |       |      |        |       |                  |                   |                   |
| <b>PCM-1-10</b>    | 1 thru 10    |       |      |        |       |                  |                   |                   |
| <b>PCM-1-12</b>    | 1 thru 12    |       |      |        |       |                  |                   |                   |
| <b>PCM-1-16</b>    | 1 thru 16    |       |      |        |       |                  |                   |                   |
| <b>PCM-1-18</b>    | 1 thru 18    |       |      |        |       |                  |                   |                   |
| <b>PCM-19-36</b>   | 19 thru 36   |       |      |        |       |                  |                   |                   |
| <b>PCM-1-33</b>    | 1 thru 33    |       |      |        |       |                  |                   |                   |
| <b>PCM-34-66</b>   | 34 thru 66   |       |      |        |       |                  |                   |                   |
| <b>PCM-67-99</b>   | 67 thru 99   |       |      |        |       |                  |                   |                   |
| <b>PCM-100-124</b> | 100 thru 124 |       |      |        |       |                  |                   |                   |
| <b>PCM-125-149</b> | 125 thru 149 |       |      |        |       |                  |                   |                   |
| <b>PCM-150-174</b> | 150 thru 174 |       |      |        |       |                  |                   |                   |
| <b>PCM-175-199</b> | 175 thru 199 |       |      |        |       |                  |                   |                   |
| <b>PCM-200-224</b> | 200 thru 224 |       |      |        |       |                  |                   |                   |
| <b>PCM-225-249</b> | 225 thru 249 |       |      |        |       |                  |                   |                   |
| <b>PCM-250-274</b> | 250 thru 274 |       |      |        |       |                  |                   |                   |
| <b>PCM-275-299</b> | 275 thru 299 |       |      |        |       |                  |                   |                   |
| <b>PCM-300-324</b> | 300 thru 324 |       |      |        |       |                  |                   |                   |
| <b>PCM-325-349</b> | 325 thru 349 |       |      |        |       |                  |                   |                   |
| <b>PCM-350-374</b> | 350 thru 374 |       |      |        |       |                  |                   |                   |
| <b>PCM-375-399</b> | 375 thru 399 |       |      |        |       |                  |                   |                   |
| <b>PCM-400-424</b> | 400 thru 424 |       |      |        |       |                  |                   |                   |
| <b>PCM-425-449</b> | 425 thru 449 |       |      |        |       |                  |                   |                   |
| <b>PCM-450-474</b> | 450 thru 474 |       |      |        |       |                  |                   |                   |
| <b>PCM-475-499</b> | 475 thru 499 |       |      |        |       |                  |                   |                   |
| <b>PCM-500-524</b> | 500 thru 524 |       |      |        |       |                  |                   |                   |

## Pre-Printed Marker Cards PCM Type (continued)



PCM-A1

| Part Number              | Legend               | Width |      | Length |      | Markers Per Card | Std. Pkg. Card(s) | Std. Ctn. Card(s) |
|--------------------------|----------------------|-------|------|--------|------|------------------|-------------------|-------------------|
|                          |                      | In.   | mm   | In.    | mm   |                  |                   |                   |
| PCM-A<br>thru<br>PCM-Z   | A<br>thru<br>Z       | 0.25  | 6.35 | 1.50   | 38.1 | 36               | 25                | 100               |
| PCM-A-Z                  | A thru Z             | 0.25  | 6.35 | 1.50   | 38.1 |                  | 25                | 100               |
| PCM-A-Z-0-9              | A thru Z<br>0 thru 9 | 0.25  | 6.35 | 1.50   | 38.1 |                  | 25                | 100               |
| PCM-A1<br>thru<br>PCM-A4 | A1<br>thru<br>A4     | 0.25  | 6.35 | 1.50   | 38.1 |                  | 25                | 100               |
| PCM-B1<br>thru<br>PCM-B5 | B1<br>thru<br>B5     | 0.25  | 6.35 | 1.50   | 38.1 |                  | 25                | 100               |
| PCM-C1<br>thru<br>PCM-C4 | C1<br>thru<br>C4     | 0.25  | 6.35 | 1.50   | 38.1 |                  | 25                | 100               |
| PCM-E1<br>thru<br>PCM-E3 | E1<br>thru<br>E3     | 0.25  | 6.35 | 1.50   | 38.1 |                  | 25                | 100               |
| PCM-F1<br>thru<br>PCM-F4 | F1<br>thru<br>F4     | 0.25  | 6.35 | 1.50   | 38.1 |                  | 25                | 100               |
| PCM-H1<br>thru<br>PCM-H5 | H1<br>thru<br>H5     | 0.25  | 6.35 | 1.50   | 38.1 |                  | 25                | 100               |
| PCM-L1<br>thru<br>PCM-L5 | L1<br>thru<br>L5     | 0.25  | 6.35 | 1.50   | 38.1 |                  | 25                | 100               |
| PCM-M1<br>thru<br>PCM-M2 | M1<br>thru<br>M2     | 0.25  | 6.35 | 1.50   | 38.1 |                  | 25                | 100               |
| PCM-P1<br>thru<br>PCM-P3 | P1<br>thru<br>P3     | 0.25  | 6.35 | 1.50   | 38.1 |                  | 25                | 100               |
| PCM-R1<br>thru<br>PCM-R5 | R1<br>thru<br>R5     | 0.25  | 6.35 | 1.50   | 38.1 |                  | 25                | 100               |
| PCM-S1<br>thru<br>PCM-S5 | S1<br>thru<br>S5     | 0.25  | 6.35 | 1.50   | 38.1 |                  | 25                | 100               |
| PCM-T1<br>thru<br>PCM-T9 | T1<br>thru<br>T9     | 0.25  | 6.35 | 1.50   | 38.1 |                  | 25                | 100               |
| PCM-X1<br>thru<br>PCM-X4 | X1<br>thru<br>X4     | 0.25  | 6.35 | 1.50   | 38.1 |                  | 25                | 100               |

Table continues on page E3.6

A.  
System  
Overview

B1.  
Cable Ties

B2.  
Cable  
Accessories

B3.  
Stainless  
Steel Ties

C1.  
Wiring  
Duct

C2.  
Surface  
Raceway

C3.  
Abrasion  
Protection

C4.  
Cable  
Management

D1.  
Terminals

D2.  
Power  
Connectors

D3.  
Grounding  
Connectors

E1.  
Labeling  
Systems

E2.  
Labels

E3.  
Pre-Printed  
& Write-On  
Markers

E4.  
Permanent  
Identification

E5.  
Lockout/  
Tagout  
& Safety  
Solutions

F.  
Index

A. System Overview

## Pre-Printed Marker Cards PCM Type (continued)

B1. Cable Ties

B2. Cable Accessories



PCM-1T1

B3. Stainless Steel Ties

C1. Wiring Duct

C2. Surface Raceway

C3. Abrasion Protection

C4. Cable Management

D1. Terminals

D2. Power Connectors

D3. Grounding Connectors

E1. Labeling Systems

E2. Labels

E3. Pre-Printed & Write-On Markers

E4. Permanent Identification

E5. Lockout/Tagout & Safety Solutions

F. Index

| Part Number | Legend | Width |      | Length |       | Markers Per Card | Std. Pkg. Card(s) | Std. Ctn. Card(s) |
|-------------|--------|-------|------|--------|-------|------------------|-------------------|-------------------|
|             |        | In.   | mm   | In.    | mm    |                  |                   |                   |
| PCM-1L1     | 1L1    | 0.36  | 9.14 | 1.50   | 38.10 | 25               | 25                | 100               |
| thru        | thru   |       |      |        |       |                  |                   |                   |
| PCM-1L3     | 1L3    | 0.36  | 9.14 | 1.50   | 38.10 |                  | 25                | 100               |
| thru        | thru   |       |      |        |       |                  |                   |                   |
| PCM-2L1     | 2L1    | 0.36  | 9.14 | 1.50   | 38.10 |                  | 25                | 100               |
| thru        | thru   |       |      |        |       |                  |                   |                   |
| PCM-2L3     | 2L3    | 0.36  | 9.14 | 1.50   | 38.10 |                  | 25                | 100               |
| thru        | thru   |       |      |        |       |                  |                   |                   |
| PCMH-3L1    | 3L1    | 0.36  | 9.14 | 1.50   | 38.10 |                  | 25                | 100               |
| thru        | thru   |       |      |        |       |                  |                   |                   |
| PCMH-3L3    | 3L3    | 0.36  | 9.14 | 1.50   | 38.10 | 25               | 100               |                   |
| thru        | thru   |       |      |        |       |                  |                   |                   |
| PCM-4L1     | 4L1    | 0.36  | 9.14 | 1.50   | 38.10 | 25               | 100               |                   |
| thru        | thru   |       |      |        |       |                  |                   |                   |
| PCM-4L3     | 4L3    | 0.36  | 9.14 | 1.50   | 38.10 | 25               | 100               |                   |
| thru        | thru   |       |      |        |       |                  |                   |                   |
| PCM-1T1     | 1T1    | 0.36  | 9.14 | 1.50   | 38.10 | 25               | 100               |                   |
| thru        | thru   |       |      |        |       |                  |                   |                   |
| PCM-1T3     | 1T3    | 0.36  | 9.14 | 1.50   | 38.10 | 25               | 100               |                   |
| thru        | thru   |       |      |        |       |                  |                   |                   |
| PCM-3T1     | 3T1    | 0.36  | 9.14 | 1.50   | 38.10 | 25               | 100               |                   |
| thru        | thru   |       |      |        |       |                  |                   |                   |
| PCM-3T3     | 3T3    |       |      |        |       |                  |                   |                   |



| Part Number | Color       | Width |      | Length |       | Markers Per Card | Std. Pkg. Card(s) | Std. Ctn. Card(s) |
|-------------|-------------|-------|------|--------|-------|------------------|-------------------|-------------------|
|             |             | In.   | mm   | In.    | mm    |                  |                   |                   |
| PCM-BLK     | Black       | .25   | 6.35 | 1.50   | 38.10 | 36               | 25                | 100               |
| PCM-BRN     | Brown       | .25   | 6.35 | 1.50   | 38.10 |                  | 25                | 100               |
| PCM-DBL     | Dark Blue   | .25   | 6.35 | 1.50   | 38.10 |                  | 25                | 100               |
| PCM-DGN     | Dark Green  | .25   | 6.35 | 1.50   | 38.10 |                  | 25                | 100               |
| PCM-GRY     | Gray        | .25   | 6.35 | 1.50   | 38.10 |                  | 25                | 100               |
| PCM-LBL     | Light Blue  | .25   | 6.35 | 1.50   | 38.10 |                  | 25                | 100               |
| PCM-LGN     | Light Green | .25   | 6.35 | 1.50   | 38.10 |                  | 25                | 100               |
| PCM-ORN     | Orange      | .25   | 6.35 | 1.50   | 38.10 |                  | 25                | 100               |
| PCM-PNK     | Pink        | .25   | 6.35 | 1.50   | 38.10 |                  | 25                | 100               |
| PCM-PUR     | Purple      | .25   | 6.35 | 1.50   | 38.10 |                  | 25                | 100               |
| PCM-RED     | Red         | .25   | 6.35 | 1.50   | 38.10 |                  | 25                | 100               |
| PCM-TAN     | Tan         | .25   | 6.35 | 1.50   | 38.10 |                  | 25                | 100               |
| PCM-WHT     | White       | .25   | 6.35 | 1.50   | 38.10 |                  | 25                | 100               |
| PCM-YEL     | Yellow      | .25   | 6.35 | 1.50   | 38.10 |                  | 25                | 100               |

Marker size:

Full size marker – 1.50" (38.10mm). Maximum wire O.D., .38" (9.50mm).

## Wire Marker Card Number Combination Packs



Numbers



Letters

| Part Number    | Legend            | Cards Per Legend | Markers Per Card | Std. Pkg. Qty. | Std. Ctn. Qty. |
|----------------|-------------------|------------------|------------------|----------------|----------------|
| PCMCP-1-25*    | 1 thru 25         | 1 each           | 36               | 1              | 4              |
| PCMCP-26-50*   | 26 thru 50        | 1 each           |                  | 1              | 4              |
| PCMCP-51-75*   | 51 thru 75        | 1 each           |                  | 1              | 4              |
| PCMCP-76-100*  | 76 thru 99<br>100 | 1 each           | 36<br>25         | 1              | 4              |
| PCMCP-101-125* | 101 thru 125      | 1 each           | 25               | 1              | 4              |
| PCMCP-126-150* | 126 thru 150      | 1 each           |                  | 1              | 4              |
| PCMCP-A-Z**    | A thru Z          | 1 each           | 36               | 1              | 4              |

Marker size:

Full size marker – 1.50" (38.10mm). Maximum wire O.D. .38" (9.50mm).

\*One card each number, 25 cards per package.

\*\*One card each letter, 26 cards per package.

## Pre-Printed Marker Cards

- Choose from the many legends available in general purpose vinyl cloth, or from special materials available to meet a variety of application environments

- All markers are offered in full size – 1.50" (38.1mm) long for wire outside diameter up to 0.38" (9.5mm); half size markers for wire outside diameter up to 0.19" (4.7mm) can be ordered
- Each marker on card has a different legend

### Material Chart



PSM-7

| Material                              | Print Method | Temperature Range                 | Features   |
|---------------------------------------|--------------|-----------------------------------|--|
| Self-Laminating Vinyl, White Print-On | Pre-Printed  | -40°F to 150°F<br>(-40°C to 66°C) | Indoor/outdoor rated; thin and conformable; preferred material for most general wire/cable labeling. |



PSM-1-33



PSM-W

| Part Number                 | Legend          | Width |      | Length |      | Markers Per Card | Std. Pkg. Card(s) | Std. Ctn. Card(s) |
|-----------------------------|-----------------|-------|------|--------|------|------------------|-------------------|-------------------|
|                             |                 | In.   | mm   | In.    | mm   |                  |                   |                   |
| PSM-0-Y<br>thru<br>PSM-52-Y | 0<br>thru<br>52 | 0.25  | 6.35 | 0.75   | 19.1 | 36               | 25                | 100               |
| PSM-0-9-Y                   | 0 thru 9        | 0.27  | 6.86 | 0.75   | 19.1 | 33               | 25                | 100               |
| PSM-1-33-Y                  | 1 thru 33       | 0.27  | 6.86 | 0.75   | 19.1 |                  | 25                | 100               |
| PSM-34-66-Y                 | 34 thru 66      | 0.27  | 6.86 | 0.75   | 19.1 |                  | 25                | 100               |
| PSM-67-99-Y                 | 67 thru 99      | 0.27  | 6.86 | 0.75   | 19.1 |                  | 25                | 100               |
| PSM-A-Y<br>thru<br>PSM-Z-Y  | A<br>thru<br>Z  | 0.25  | 6.35 | 0.75   | 19.1 | 36               | 25                | 100               |
| PSM-A-Z-Y                   | A thru Z        | 0.25  | 6.35 | 0.75   | 19.1 |                  | 25                | 100               |

Legend: Black Background: White

Marker sizes:

Full size marker – 1.50" (38.10mm). Maximum wire O.D., 0.38" (9.50mm).

Half size marker – 0.75" (19.10mm). Maximum wire O.D., 0.19" (4.70mm).

A. System Overview

## Pre-Printed Marker Cards PPM Type

B1. Cable Ties

B2. Cable Accessories

B3. Stainless Steel Ties

### Material Chart



PPM-7

| Material         | Print Method | Temperature Range                  | Features   |
|------------------|--------------|------------------------------------|--|
| High Temp, White | Pre-Printed  | -40°F to 275°F<br>(-40°C to 135°C) | Indoor/outdoor rated; self-extinguishing; ideal for component labeling in harsh environments |

C1. Wiring Duct

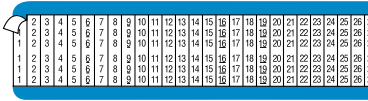

PPM-1-33

| Part Number       | Legend    | Width |      | Length |       | Markers Per Card | Std. Pkg. Card(s) | Std. Ctn. Card(s) |
|-------------------|-----------|-------|------|--------|-------|------------------|-------------------|-------------------|
|                   |           | In.   | mm   | In.    | mm    |                  |                   |                   |
| PPM-0 thru PPM-25 | 0 thru 25 | 0.25  | 6.35 | 1.50   | 38.10 | 36               | 25                | 100               |
| PPM-1-33          | 1 thru 33 | 0.27  | 6.91 | 1.50   | 38.10 | 33               | 25                | 100               |
| PPM-A thru PPM-C  | A thru C  | 0.25  | 6.35 | 1.50   | 38.10 | 36               | 25                | 100               |

C2. Surface Raceway

C3. Abrasion Protection

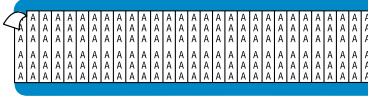

PPM-A

Legend: Black Background: White  
 Marker sizes:  
 Half size marker – 1.50" (38.10mm). Maximum wire O.D., .38" (9.50mm).

C4. Cable Management

D1. Terminals

D2. Power Connectors

D3. Grounding Connectors

E1. Labeling Systems

E2. Labels

E3. Pre-Printed & Write-On Markers

E4. Permanent Identification

E5. Lockout/Tagout & Safety Solutions

F. Index



## Write-On Marker Cards – Self-Laminating

- Clear section of marker overlaminates and protects write-on legend
- Markers have ink receptive area to allow hand-written legends

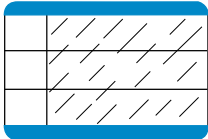

Type PSCC

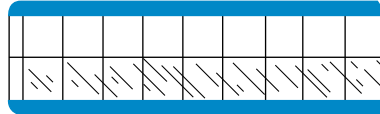

Type PSWM

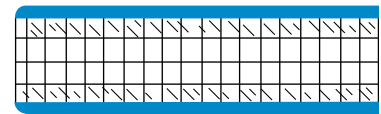

Type PSWMH

| Part Number | Width |       | Length |        | Print-On Height |       | Min. Cable O.D. |     | Max. Cable O.D. |      | Markers Per Card | Std. Pkg. Card(s) | Std. Ctn. Card(s) |
|-------------|-------|-------|--------|--------|-----------------|-------|-----------------|-----|-----------------|------|------------------|-------------------|-------------------|
|             | In.   | mm    | In.    | mm     | In.             | mm    | In.             | mm  | In.             | mm   |                  |                   |                   |
| PSCC-3Y     | 1.00  | 25.40 | 3.00   | 76.20  | 0.75            | 19.05 | 0.240           | 6.1 | 0.72            | 18.2 | 3                | 25                | 100               |
| PSCC-5Y     | 1.00  | 25.40 | 5.00   | 127.00 | 1.00            | 25.40 | 0.320           | 8.1 | 1.27            | 32.3 | 3                | 25                | 100               |
| PSWM-375Y   | 0.38  | 9.53  | 1.50   | 38.05  | 0.75            | 19.05 | 0.240           | 6.1 | 0.24            | 6.1  | 25               | 25                | 100               |
| PSWM-750Y   | 0.75  | 19.05 | 1.50   | 38.05  | 0.75            | 19.05 | 0.240           | 6.1 | 0.24            | 6.1  | 12               | 25                | 100               |
| PSWM-1500Y  | 1.50  | 38.05 | 1.50   | 38.05  | 0.75            | 19.05 | 0.240           | 6.1 | 0.24            | 6.1  | 6                | 25                | 100               |
| PSWMH-375Y  | 0.38  | 9.53  | 0.75   | 19.05  | 0.38            | 9.53  | 0.120           | 3.1 | 0.12            | 3.0  | 50               | 25                | 100               |
| PSWMH-750Y  | 0.75  | 19.05 | 0.75   | 19.05  | 0.38            | 9.53  | 0.120           | 3.1 | 0.12            | 3.0  | 24               | 25                | 100               |

## Pre-Printed Marker Tape Dispenser

- Flexible polyester marker tape conforms tightly to wires/cables
- Dispenser allows marker tape to be cut to the exact length required for marking any size wire/cable
- Durable plastic dispenser can be attached to tool belt for industrial use



### Material Chart

| Material         | Print Method | Temperature Range               | Features  |
|------------------|--------------|---------------------------------|---|
| Polyester, White | Pre-Printed  | -40°F to 250°F (-40°C to 121°C) | Indoor/outdoor rated; laminated label material protects legend from abrasion and chemicals; resistant to UV light chemical atmosphere and abrasion; excellent life and adhesion properties. |

| Part Number | Part Description  | Roll |     | Rolls Per Legend Per Pkg. | Std. Pkg. Qty. | Std. Ctn. Qty. |
|-------------|---|------|-----|---------------------------|----------------|----------------|
|             |   | Ft.  | m   |                           |                |                |
| PMD         | Empty dispenser.  | —    | —   | —                         | 1              | 10             |
| PMD-0-9     | Dispenser filled with one roll each legend 0 thru 9.  | 8.0  | 2.4 | 1                         | 1              | 10             |
| PMD-NEMA    | Dispenser filled with one roll each of solid NEMA colors: black, light blue, brown, gray, light green, orange, purple, red, white and yellow. | 8.0  | 2.4 | 1                         | 1              | 10             |

A. System Overview

## Pre-Printed Marker Tape Refills

B1. Cable Ties



B2. Cable Accessories

B3. Stainless Steel Ties



C1. Wiring Duct

C2. Surface Raceway

C3. Abrasion Protection

C4. Cable Management

D1. Terminals

D2. Power Connectors

D3. Grounding Connectors

E1. Labeling Systems

E2. Labels

E3. Pre-Printed & Write-On Markers

E4. Permanent Identification

E5. Lockout/Tagout & Safety Solutions

F. Index

| Part Number                    | Legend  | Roll Length |     | Rolls Per Legend Per Pkg. | Std. Pkg. Roll(s) | Std. Ctn. Roll(s) |
|--------------------------------|---|-------------|-----|---------------------------|-------------------|-------------------|
|                                |   | Ft.         | m   |                           |                   |                   |
| PMDR-0-9<br>thru<br>PMDR-90-99 | 0 thru 9<br>thru<br>90 thru 99                | 8.0         | 2.4 | 10                        | 10                | 1                 |
| PMDR-0<br>thru<br>PMDR-9       | 0<br>thru<br>9                                |             |     |                           |                   | 10                |
| PMDR-A<br>thru<br>PMDR-Z       | A<br>thru<br>Z                                |             |     |                           |                   | 10                |
| PMDR-L1<br>thru<br>PMDR-L3     | L1<br>thru<br>L3                              |             |     |                           |                   | 10                |
| PMDR-T1<br>thru<br>PMDR-T3     | T1<br>thru<br>T3                              |             |     |                           |                   | 10                |
| PMDR-GRS                       | Ground symbol                                 |             |     |                           |                   | 10                |
| PMDR-MIN                       | Minus symbol                                  |             |     |                           |                   | 10                |
| PMDR-PLS                       | Plus symbol                                   |             |     |                           |                   | 10                |
| PMDR-BLK                       | Black   |             |     |                           |                   | 10                |
| PMDR-BL                        | Light Blue                                    |             |     |                           |                   | 10                |
| PMDR-BRN                       | Brown   | 10          |     |                           |                   |                   |
| PMDR-GRN                       | Light Green                                   | 10          |     |                           |                   |                   |
| PMDR-GRY                       | Gray  | 8.0         | 2.4 | 10                        | 10                | 10                |
| PMDR-ORN                       | Orange  |             |     |                           |                   | 10                |
| PMDR-PUR                       | Purple  |             |     |                           |                   | 10                |
| PMDR-RED                       | Red   |             |     |                           |                   | 10                |
| PMDR-WHT                       | White   |             |     |                           |                   | 10                |
| PMDR-YEL                       | Yellow  |             |     |                           |                   | 10                |
| PMDR-NEMA                      | One of each of the NEMA colors featured above |             |     |                           |                   | 1                 |

## Self-Laminating Wire Marker Dispenser

- Self-laminating labels are provided in handy dispenser which protects markers when not in use
- Clear section of marker overlaminates and protects write-on legend
- Quick, easy to use for smaller installations and maintenance



### Material Chart

| Material                              | Print Method | Temperature Range              | Features   |
|---------------------------------------|--------------|--------------------------------|--|
| Self-Laminating Vinyl, White Print-On | Pre-Printed  | -40°F to 150°F (-40°C to 66°C) | Indoor/outdoor rated; thin and conformable; preferred material for most general wire/cable labeling. |

| Part Number          | Part Description   | Width |       | Length |       | Print-On Height |       | Min. Cable O.D. |      | Max. Cable O.D. |       | Std. Pkg. Qty. | Std. Ctn. Qty. |
|----------------------|--|-------|-------|--------|-------|-----------------|-------|-----------------|------|-----------------|-------|----------------|----------------|
|                      |  | In.   | mm    | In.    | mm    | In.             | mm    | In.             | mm   | In.             | mm    |                |                |
| <b>Dispenser Kit</b> |  |       |       |        |       |                 |       |                 |      |                 |       |                |                |
| <b>S100X125VARY</b>  | (1) Dispenser.<br>(1) Roll, white write-on, vinyl label, 200/roll.<br>(1) PFX-0 pen. | 1.00  | 25.40 | 1.25   | 31.75 | 0.38            | 9.65  | 0.12            | 3.07 | 0.28            | 7.03  | 1              | 10             |
| <b>S100X225VARY</b>  | (1) Dispenser.<br>(1) Roll, white write-on, vinyl label, 100/roll.<br>(1) PFX-0 pen. | 1.00  | 25.40 | 2.25   | 57.15 | 0.75            | 19.05 | 0.24            | 6.06 | 0.48            | 12.13 | 1              | 10             |
| <b>Refill Rolls</b>  |  |       |       |        |       |                 |       |                 |      |                 |       |                |                |
| <b>S100X125VAFY</b>  | Replacement roll. White write-on, vinyl label, 200/roll.                             | 1.00  | 25.40 | 1.25   | 31.75 | 0.38            | 9.65  | 0.12            | 3.07 | 0.28            | 7.03  | 1              | 10             |
| <b>S100X225VAFY</b>  | Replacement roll. White write-on, vinyl label 100/roll.                              | 1.00  | 25.40 | 2.25   | 57.15 | 0.75            | 19.05 | 0.24            | 6.06 | 0.48            | 12.13 | 1              | 10             |

Can be clearly identified with Panduit permanent marking pens shown on page E5.19.

## Pre-Printed Clip-On Wire Markers

- Non-adhesive markers grip tightly to wire/cable
- Markers supplied on application wand tool
- Chevron cut keeps multiple markers aligned
- Black legend is embossed into wire marker clip



### Material Chart

| Material            | Print Method | Temperature Range              | Features   |
|---------------------|--------------|--------------------------------|--|
| Non-Adhesive Acetal | Pre-Printed  | -22°F to 194°F (-30°C to 90°C) | Indoor/outdoor rated; durable material that has excellent resiliency to oils and solvents. |

| Part Number | Legend | No. of Markers Per Wand | Markers Per Pkg. | Std. Pkg. Qty. | Std. Ctn. Qty. |
|-------------|--------|-------------------------|------------------|----------------|----------------|
|-------------|--------|-------------------------|------------------|----------------|----------------|

### Wire/Cable Diameter 0.08" – 0.10" (2.00mm – 2.50mm)

|                                    |          |    |     |   |    |
|------------------------------------|----------|----|-----|---|----|
| <b>PCA07-A</b> thru <b>PCA07-Z</b> | A thru Z | 30 | 300 | 1 | 10 |
| <b>PCA07-A-J</b>                   | A-J      |    |     | 1 | 10 |
| <b>PCA07-K-T</b>                   | K-T      |    |     | 1 | 10 |
| <b>PCA07-U-Z</b>                   | U-Z      |    |     | 1 | 10 |
| <b>PCA07-0</b> thru <b>PCA07-9</b> | 0 thru 9 |    |     | 1 | 10 |
| <b>PCA07-0-9</b>                   | 0-9      |    |     | 1 | 10 |
| <b>PCA07-MIN</b>                   | —        |    |     | 1 | 10 |
| <b>PCA07-PLS</b>                   | +        |    |     | 1 | 10 |

Table continues on page E3.12

## Pre-Printed Clip-On Wire Markers (continued)

|     |                                   |
|-----|-----------------------------------|
| A.  | System Overview                   |
| B1. | Cable Ties                        |
| B2. | Cable Accessories                 |
| B3. | Stainless Steel Ties              |
| C1. | Wiring Duct                       |
| C2. | Surface Raceway                   |
| C3. | Abrasion Protection               |
| C4. | Cable Management                  |
| D1. | Terminals                         |
| D2. | Power Connectors                  |
| D3. | Grounding Connectors              |
| E1. | Labeling Systems                  |
| E2. | Labels                            |
| E3. | Pre-Printed & Write-On Markers    |
| E4. | Permanent Identification          |
| E5. | Lockout/Tagout & Safety Solutions |
| F.  | Index                             |

| Part Number  | Legend     | No. of Markers Per Wand | Markers Per Pkg. | Std. Pkg. Qty. | Std. Ctn. Qty. |    |    |
|--|------------|-------------------------|------------------|----------------|----------------|----|----|
| <b>Wire/Cable Diameter 0.11" – 0.13" (2.80mm – 3.30mm)</b> |            |                         |                  |                |                |    |    |
| PCA11-A thru PCA11-Z                                       | A thru Z   | 30                      | 300              | 1              | 10             |    |    |
| PCA11-A-J  | A-J        |                         |                  | 1              | 10             |    |    |
| PCA11-K-T  | K-T        |                         |                  | 1              | 10             |    |    |
| PCA11-U-Z  | U-Z        |                         |                  | 1              | 10             |    |    |
| PCA11-0 thru PCA11-9                                       | 0 thru 9   |                         |                  | 1              | 10             |    |    |
| PCA11-0-9  | 0-9        |                         |                  | 1              | 10             |    |    |
| PCA11-MIN  | —          |                         |                  | 1              | 10             |    |    |
| PCA11-PLS  | +          |                         |                  | 1              | 10             |    |    |
| <b>Wire/Cable Diameter 0.13" – 0.15" (3.30mm – 3.80mm)</b> |            |                         |                  |                |                |    |    |
| PCA13-A thru PCA13-Z                                       | A thru Z   |                         |                  | 30             | 300            | 1  | 10 |
| PCA13-A-J  | A-J        | 1                       | 10               |                |                |    |    |
| PCA13-K-T  | K-T        | 1                       | 10               |                |                |    |    |
| PCA13-U-Z  | U-Z        | 1                       | 10               |                |                |    |    |
| PCA13-0 thru PCA13-9                                       | 0 thru 9   | 1                       | 10               |                |                |    |    |
| PCA13-0-9  | 0-9        | 1                       | 10               |                |                |    |    |
| PCA13-MIN  | —          | 1                       | 10               |                |                |    |    |
| PCA13-PLS  | +          | 1                       | 10               |                |                |    |    |
| <b>Wire/Cable Diameter 0.19" – 0.23" (4.80mm – 5.80mm)</b> |            |                         |                  |                |                |    |    |
| PCA18-A thru PCA18-Z                                       | A thru Z   | 30                      | 300              |                |                | 1  | 10 |
| PCA18-A-J  | A-J        |                         |                  | 1              | 10             |    |    |
| PCA18-K-T  | K-T        |                         |                  | 1              | 10             |    |    |
| PCA18-U-Z  | U-Z        |                         |                  | 1              | 10             |    |    |
| PCA18-0 thru PCA18-9                                       | 0 thru 9   |                         |                  | 1              | 10             |    |    |
| PCA18-0-9  | 0-9        |                         |                  | 1              | 10             |    |    |
| PCA18-MIN  | —          |                         |                  | 1              | 10             |    |    |
| PCA18-PLS  | +          |                         |                  | 1              | 10             |    |    |
| <b>Wire/Cable Diameter 0.23" – 0.37" (5.80mm – 9.40mm)</b> |            |                         |                  |                |                |    |    |
| PCA23-A thru PCA23-Z                                       | A thru Z   |                         |                  | 20             | 60             | 1  | 10 |
| PCA23-A-D  | A-D        | 80                      | 1                |                | 10             |    |    |
| PCA23-E-H  | E-H        |                         | 1                |                | 10             |    |    |
| PCA23-I-L  | I-L        |                         | 1                |                | 10             |    |    |
| PCA23-M-P  | M-P        |                         | 1                |                | 10             |    |    |
| PCA23-Q-T  | Q-T        | 60                      | 1                |                | 10             |    |    |
| PCA23-U-X  | U-X        |                         | 1                |                | 10             |    |    |
| PCA23-Y-Z  | Y-Z, +, -  |                         | 80               |                | 1              | 10 |    |
| PCA23-0 thru PCA23-9                                       | 0 thru 9   |                         |                  |                | 1              | 10 |    |
| PCA23-0-3  | 0-3        | 80                      | 1                |                | 10             |    |    |
| PCA23-4-7  | 4-7        |                         | 1                | 10             |                |    |    |
| PCA23-8-9  | 8, 9, +, - |                         | 1                | 10             |                |    |    |
| PCA23-MIN  | —          | 60                      | 1                | 10             |                |    |    |
| PCA23-PLS  | +          |                         | 1                | 10             |                |    |    |

## PERMANENT IDENTIFICATION

Panduit offers the widest range of permanent identification solutions in the industry to withstand the test of time and provide legibility in harsh environments. Safe, quick, and easy to install, Panduit permanent identification solutions include stainless steel and aluminum marker plates, tags, marking tools and ties to deliver improved productivity and workplace safety.

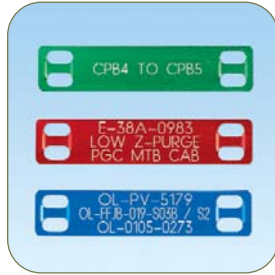
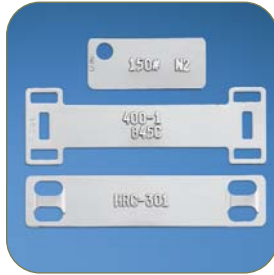

- **Factory Custom Marking Service** creates embossed or laser etched metal plates, tags, and ties to speed installation time and reduce labor costs
- **Portable on-site marking tools** for quick and easy identification on demand
- **Large identification selection** delivers maximum design flexibility to match your specific application requirements
- **Optimized for easy use** with Panduit self-locking stainless steel and aluminum ties; for details, refer to Pan-Steel® System Section B3

Panduit continues to design permanent identification products for harsh environments by addressing customer problems with innovative solutions and reliable tooling to achieve lowest installed cost.

A.  
System  
Overview

B1.  
Cable  
Ties

B2.  
Cable  
Accessories

B3.  
Stainless  
Steel Ties

C1.  
Wiring  
Duct

C2.  
Surface  
Raceway

C3.  
Abrasion  
Protection

C4.  
Cable  
Management

D1.  
Terminals

D2.  
Power  
Connectors

D3.  
Grounding  
Connectors

E1.  
Labeling  
Systems

E2.  
Labels

E3.  
Pre-Printed  
& Write-On  
Markers

E4.  
Permanent  
Identification

E5.  
Lockout/  
Tagout  
& Safety  
Solutions

F.  
Index

A. System Overview

## Panduit Factory Custom Marking Service

B1. Cable Ties

Panduit factory custom marking service simplifies identification with high quality, made-to-order custom embossed marker plates and tags or laser etched cable ties, marker plates, and tags. Panduit offers rapid direct shipment with fast turn around on custom marking orders worldwide. Work with Panduit to create an effectively identified workplace.

B2. Cable Accessories

### EMBOSSING SERVICE

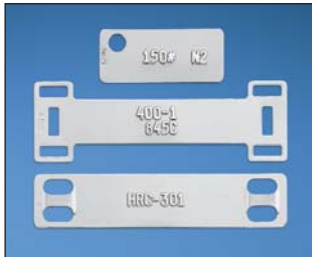

- Used on rectangular metal marker plates and tags which are a maximum of .020 inches (.5mm) thick and minimum .38 inches (10mm) width
- Excellent for applications that are exposed to dirt and paint
- Upper case "raised" character
- Alphanumeric and sequential numbering

### LASER MARKING SERVICE

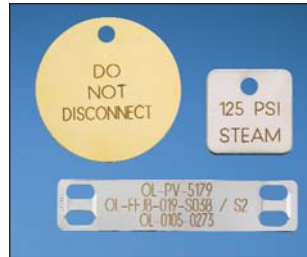

- Used on all metal marker plates, tags, and cable ties
- BOLD block letters
- Upper and lower case character capability
- Ability to create text and graphics
- Alphanumeric and sequential numbering

B3. Stainless Steel Ties

C1. Wiring Duct

C2. Surface Raceway

C3. Abrasion Protection

C4. Cable Management

D1. Terminals

D2. Power Connectors

D3. Grounding Connectors

E1. Labeling Systems

E2. Labels

E3. Pre-Printed & Write-On Markers

E4. Permanent Identification

E5. Lockout/Tagout & Safety Solutions

F. Index

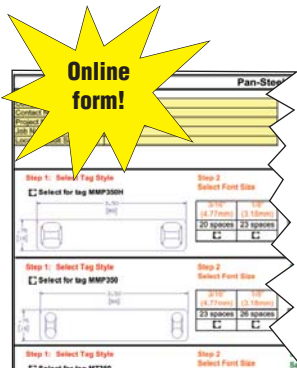

Online form!

To select and order custom laser and embossed marker plates and tags:

Use on-line order form (C2-0677) at [www.panduit.com/permanentID](http://www.panduit.com/permanentID) to select the proper marker plate or tag for your application. Email order form to your Authorized Panduit Distributor for order placement or contact Panduit Customer Service for assistance.

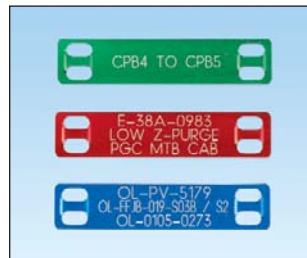

#### Character sizes available:

- 1/8 inches (3.18mm) – For high character volume tags
- 3/16 inches (4.77mm) – The most common size
- 1/4 inches (6.35mm) – Larger font for greater flexibility
- 5/16 inches (7.94mm) – Maximum visibility for tags requiring only a few characters.



Panduit offers a full line of labeling products, software and printers to assist you with your labeling requirements.

See pages E1.0 – E2.30.



Panduit permanent identification products are optimized for easy use with Panduit self-locking stainless steel and aluminum ties. For details, refer to Pan-Steel® System Section B3.



## Stainless Steel and Brass Marker Plates and Tags

- Provides permanent identification of pipes, conduit, valves, cables and equipment in harsh environments
- Designed for use with Panduit® Pan-Steel® Stainless Steel Cable Ties for fast installation at lowest installed cost
- All marker plates/tags can be embossed or laser etched with Panduit Factory Custom Marking Service
- For on-site custom marking see page E4.6
- Designated plates feature easy feed design with a raised slot to simplify cable tie installation and improve productivity



MMP350-C

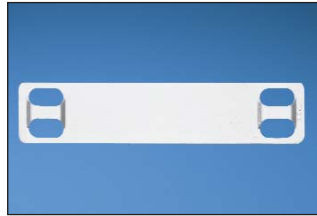

MMP350H-C

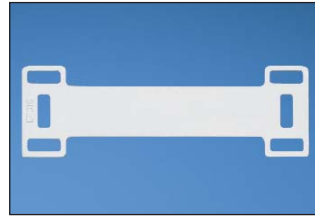

MMP350DB-C



MMP350W38-C



MMP172-C



MMP172W38-C



MMP350W17-Q

| Part Number            | Material            | Color   | Length/<br>Diameter |                     | Width   |      | Custom Marking<br>Parameters*                   |                       | Used<br>with<br>Pan-Steel®<br>Cable<br>Ties** | Thickness |      | Std.<br>Pkg.<br>Qty. | Std.<br>Ctn.<br>Qty. |
|------------------------|---------------------|---------|---------------------|---------------------|---------|------|---|-----------------------|---|-----------|------|----------------------|----------------------|
|                        |                     |         | In.                 | mm                  | In.     | mm   | Max. 3/16"<br>(4.77mm)<br>Character<br>Per Line | Max. Lines<br>of Text |   | In.       | mm   |                      |                      |
|                        |                     |         | <b>MMP350-C‡</b>    | 304 Stainless Steel | Natural | 3.50 | 89.0  | 0.75                  |   | 19.0      | 23   |                      |                      |
| <b>MMP350-C316‡</b>    | 316 Stainless Steel | Natural | 3.50                | 89.0                | 0.75    | 19.0 | 23  | 3                     | MLT-S   | 0.010     | 0.25 | 100                  | 1000                 |
| <b>MMP350H-C‡</b>      | 304 Stainless Steel | Natural | 3.50                | 89.0                | 0.75    | 19.0 | 20  | 3                     | MLT-H   | 0.010     | 0.25 | 100                  | 1000                 |
| <b>MMP350H-C316‡</b>   | 316 Stainless Steel | Natural | 3.50                | 89.0                | 0.75    | 19.0 | 20  | 3                     | MLT-H   | 0.010     | 0.25 | 100                  | 1000                 |
| <b>MMP350DB-C‡</b>     | 304 Stainless Steel | Natural | 3.50                | 89.0                | 1.12    | 29.0 | 20  | 3                     | MLT-H   | 0.015     | 0.38 | 100                  | 1000                 |
| <b>MMP350DB-C316‡</b>  | 316 Stainless Steel | Natural | 3.50                | 89.0                | 1.12    | 29.0 | 20  | 3                     | MLT-H   | 0.015     | 0.38 | 100                  | 1000                 |
| <b>MMP350W38-C‡</b>    | 304 Stainless Steel | Natural | 3.50                | 89.0                | 0.38    | 10.0 | 23  | 1                     | MLT-S   | 0.010     | 0.25 | 100                  | 1000                 |
| <b>MMP350W38-C316‡</b> | 316 Stainless Steel | Natural | 3.50                | 89.0                | 0.38    | 10.0 | 23  | 1                     | MLT-S   | 0.010     | 0.25 | 100                  | 1000                 |
| <b>MMP172-C‡</b>       | 304 Stainless Steel | Natural | 1.72                | 44.0                | 0.75    | 19.0 | 8   | 3                     | MLT-S   | 0.010     | 0.25 | 100                  | 1000                 |
| <b>MMP172-C316‡</b>    | 316 Stainless Steel | Natural | 1.72                | 44.0                | 0.75    | 19.0 | 8   | 3                     | MLT-S   | 0.010     | 0.25 | 100                  | 1000                 |
| <b>MMP172W38-C‡</b>    | 304 Stainless Steel | Natural | 1.72                | 44.0                | 0.38    | 10.0 | 8   | 1                     | MLT-S   | 0.010     | 0.25 | 100                  | 1000                 |
| <b>MMP172W38-C316‡</b> | 316 Stainless Steel | Natural | 1.72                | 44.0                | 0.38    | 10.0 | 8   | 1                     | MLT-S   | 0.010     | 0.25 | 100                  | 1000                 |
| <b>MMP350W17-Q</b>     | 304 Stainless Steel | Natural | 3.50                | 89.0                | 1.73    | 44.0 | 23  | 6                     | MLT-S   | 0.015     | 0.38 | 25                   | 250                  |

\*See page E4.2 for Panduit Factory Custom Marking Service information.

\*\*See pages B3.5 – B3.7 for Pan-Steel® Stainless Steel Cable Ties.

‡Easy feed marker plate with raised cable tie slot.

Table continues on page E4.4

A. System Overview

## Stainless Steel and Brass Marker Plates and Tags (continued)

B1. Cable Ties

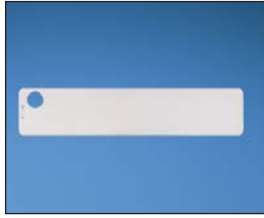

MT350-C

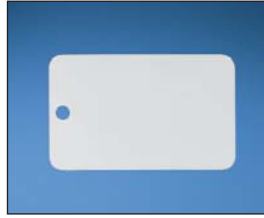

MT350W17-Q



MT172-C

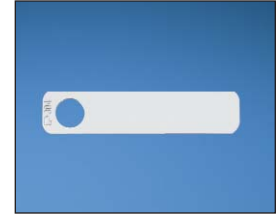

MT172W38-C

B2. Cable Accessories

B3. Stainless Steel Ties

C1. Wiring Duct

C2. Surface Raceway



MTB1D-Q



MTB150D-Q

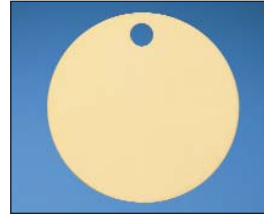

MTB213D-Q



MT125S-Q

C3. Abrasion Protection

C4. Cable Management

D1. Terminals

D2. Power Connectors

D3. Grounding Connectors

E1. Labeling Systems

E2. Labels

E3. Pre-Printed & Write-On Markers

E4. Permanent Identification

E5. Lockout/Tagout & Safety Solutions

F. Index

| Part Number        | Material            | Color   | Length/<br>Diameter |                | Width            |      | Custom Marking<br>Parameters*                   |                       | Used<br>with<br>Pan-Steel®<br>Cable<br>Ties** | Thickness |      | Std.<br>Pkg.<br>Qty. | Std.<br>Ctn.<br>Qty. |
|--------------------|---------------------|---------|---------------------|----------------|------------------|------|---|-----------------------|---|-----------|------|----------------------|----------------------|
|                    |                     |         | In.                 | mm             | In.              | mm   | Max. 3/16"<br>(4.77mm)<br>Character<br>Per Line | Max. Lines<br>of Text |   | In.       | mm   |                      |                      |
| <b>MT350-C</b>     | 304 Stainless Steel | Natural | 3.50                | 89.0           | 0.75             | 19.0 | 26  | 3                     | MLT-S   | 0.010     | 0.25 | 100                  | 1000                 |
| <b>MT350-C316</b>  | 316 Stainless Steel | Natural | 3.50                | 89.0           | 0.75             | 19.0 | 26  | 3                     | MLT-S   | 0.010     | 0.25 | 100                  | 1000                 |
| <b>MT350W17-Q</b>  | 304 Stainless Steel | Natural | 3.50                | 89.0           | 1.73             | 44.0 | 26  | 6                     | MLT-S   | 0.015     | 0.38 | 25                   | 250                  |
| <b>MT172-C</b>     | 304 Stainless Steel | Natural | 1.72                | 44.0           | 0.75             | 19.0 | 10  | 3                     | MLT-S   | 0.010     | 0.25 | 100                  | 1000                 |
| <b>MT172-C316</b>  | 316 Stainless Steel | Natural | 1.72                | 44.0           | 0.75             | 19.0 | 10  | 3                     | MLT-S   | 0.010     | 0.25 | 100                  | 1000                 |
| <b>MT172W38-C</b>  | 304 Stainless Steel | Natural | 1.72                | 44.0           | 0.38             | 10.0 | 10  | 1                     | MLT-S   | 0.010     | 0.25 | 100                  | 1000                 |
| <b>MT1D-Q</b>      | 304 Stainless Steel | Natural | —                   | —              | 1.00<br>circular | 25.0 | 5   | 1                     | MLT-S   | 0.035     | 0.89 | 25                   | 250                  |
| <b>MT1D-Q316</b>   | 316 Stainless Steel | Natural | —                   | —              | 1.00<br>circular | 25.0 | 5   | 1                     | MLT-S   | 0.035     | 0.89 | 25                   | 250                  |
| <b>MTB1D-Q</b>     | Brass               | Brass   | —                   | —              | 1.00<br>circular | 25.0 | 5   | 1                     | MLT-S   | 0.040     | 1.02 | 25                   | 250                  |
| <b>MT150D-Q</b>    | 304 Stainless Steel | Natural | —                   | —              | 1.50<br>circular | 38.0 | 5, 6, 5   | 3                     | MLT-S   | 0.035     | 0.89 | 25                   | 250                  |
| <b>MT150D-Q316</b> | 316 Stainless Steel | Natural | —                   | —              | 1.50<br>circular | 38.0 | 5, 6, 5   | 3                     | MLT-S   | 0.035     | 0.89 | 25                   | 250                  |
| <b>MTB150D-Q</b>   | Brass               | Brass   | —                   | —              | 1.50<br>circular | 38.0 | 5, 6, 5   | 3                     | MLT-S   | 0.040     | 1.02 | 25                   | 250                  |
| <b>MT213D-Q</b>    | 304 Stainless Steel | Natural | —                   | —              | 2.13<br>circular | 54.0 | 6, 12, 8  | 3                     | MLT-S   | 0.015     | 0.38 | 25                   | 250                  |
| <b>MT213D-Q316</b> | 316 Stainless Steel | Natural | —                   | —              | 2.13<br>circular | 54.0 | 6, 12, 8  | 3                     | MLT-S   | 0.015     | 0.38 | 25                   | 250                  |
| <b>MTB213D-Q</b>   | Brass               | Brass   | —                   | —              | 2.13<br>circular | 54.0 | 6, 12, 8  | 3                     | MLT-S   | 0.015     | 0.38 | 25                   | 250                  |
| <b>MT125S-Q</b>    | 304 Stainless Steel | Natural | 1.25<br>square      | 32.0<br>square | 1.25<br>square   | 32.0 | 5   | 2                     | MLT-S   | 0.035     | 0.89 | 25                   | 250                  |

\*See page E4.2 for Panduit Factory Custom Marking Service information.

\*\*See pages B3.5 – B3.7 for Pan-Steel® Stainless Steel Cable Ties.

## Aluminum Marker Plates – Pan-Alum™ MMP Series

- Lightweight, aluminum construction for flexibility and ease of handling
- Five color options in addition to natural aluminum provide quick visual identification, ideal for applications requiring color-coding
- Easy feed marker plate design includes a raised slot to simplify cable tie installation and improve productivity

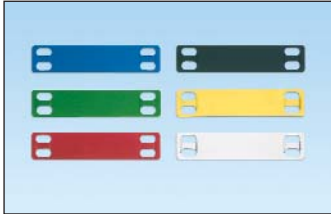

| Part Number          | Material | Color   | Length               |                   | Width |      | Custom Marking Parameters**             |            | Used with Pan-Alum™ Cable Ties | Std. Pkg. Qty. | Std. Ctn. Qty. |
|----------------------|----------|---------|----------------------|-------------------|-------|------|---|------------|--------------------------------|----------------|----------------|
|                      |          |         | In.                  | mm                | In.   | mm   | Max. 3/16" (4.77mm) Characters per Line | Max. Lines |                                |                |                |
|                      |          |         | <b>MMP350H-CALBU</b> | Anodized Aluminum | Blue  | 3.50 | 89.0                                    | 0.75       |                                |                |                |
| <b>MMP350H-CALGR</b> | Green    | 100     | 1000                 |                   |       |      |   |            |                                |                |                |
| <b>MMP350H-CALRD</b> | Red      | 100     | 1000                 |                   |       |      |   |            |                                |                |                |
| <b>MMP350H-CALBL</b> | Black    | 100     | 1000                 |                   |       |      |   |            |                                |                |                |
| <b>MMP350H-CALYL</b> | Yellow   | 100     | 1000                 |                   |       |      |   |            |                                |                |                |
| <b>MMP350H-CAL</b>   | Aluminum | Natural |                      |                   |       |      |   |            |                                | 100            | 1000           |

\*See Pan-Alum™ Aluminum Ties on page B3.10 for matching natural finish and five colors.

\*\*See page, E4.2 for Panduit Factory Custom Marking Service.

## **NEW!** Metal Embossing Hand Tool and Tape System

- New multi-functional cutting die design creates embossed marker plates with raised cable tie slot in one step instead of three, for faster installation
- Lightweight, compact and portable, allows user to create custom length identification on demand at remote job sites
- Embosses 3/16" characters onto stainless steel or aluminum tape, to improve visibility in applications that are subjected to dirt or paint



| Part Number     | Part Description  | Std. Pkg. Qty. |
|-----------------|---|----------------|
| <b>Tool Kit</b> |   |                |
| <b>MEHT187</b>  | Includes tool, additional marking wheel, carrying case, one roll each META (aluminum) and METS (stainless steel) tape. Characters included: A B C D E F G H I J K L M N O P Q R S T U V W X Y Z 1 2 3 4 5 6 7 8 9 / ( ) | 1              |
| <b>Tape</b>     |   |                |
| <b>META-X</b>   | .50" x 16' (12.7mm x 4.9m) aluminum tape*.  | 10             |
| <b>METS3-X</b>  | .50" x 21' (12.7mm x 6.4m) 316 grade stainless steel tape.  | 10             |
| <b>METS4-X</b>  | .50" x 21' (12.7mm x 6.4m) 304 grade stainless steel tape.  | 10             |

\*Aluminum ties are recommended for use with aluminum tape to prevent galvanic reaction (corrosion that can occur between stainless steel and aluminum in certain environments).

A.  
System  
Overview

B1.  
Cable Ties

B2.  
Cable  
Accessories

B3.  
Stainless  
Steel Ties

C1.  
Wiring  
Duct

C2.  
Surface  
Raceway

C3.  
Abrasion  
Protection

C4.  
Cable  
Management

D1.  
Terminals

D2.  
Power  
Connectors

D3.  
Grounding  
Connectors

E1.  
Labeling  
Systems

E2.  
Labels

E3.  
Pre-Printed  
& Write-On  
Markers

E4.  
Permanent  
Identification

E5.  
Lockout/  
Tagout  
& Safety  
Solutions

F.  
Index

A. System Overview

## Metal Indenting Machine

- Provides quick, easy, and permanent identification with Panduit® Pan-Alum™ Marker Plates and Cable Ties and Pan-Steel® Stainless Steel Marker Plates, Tags, Cable Ties and Straps
- Automatic table indexing advances material forward for convenience and improved productivity
- New, improved design features aluminum base and durable construction

B1. Cable Ties

B2. Cable Accessories



B3. Stainless Steel Ties

| Part Number              | Part Description                                       | Std. Pkg. Qty. |
|--------------------------|--|----------------|
| <b>Indenting Machine</b> |  |                |
| <b>MIM094</b>            | Indenting machine with 3/32" (2.38mm) character wheel. | 1              |
| <b>MIM125</b>            | Indenting machine with 1/8" (3.18mm) character wheel.  | 1              |
| <b>MIM187</b>            | Indenting machine with 3/16" (4.77mm) character wheel. | 1              |

### Interchangeable Wheel Kits

|               |   |   |
|---------------|---|---|
| <b>MIW094</b> | 3/32" (2.38mm) character wheel kit (wheel and indexing gear). | 1 |
| <b>MIW125</b> | 1/8" (3.18mm) character wheel kit (wheel and indexing gear).  | 1 |
| <b>MIW187</b> | 3/16" (4.77mm) character wheel kit (wheel and indexing gear). | 1 |

C1. Wiring Duct



C2. Surface Raceway

C3. Abrasion Protection

## **NEW!** Portable Embossing System\*

- Easily moved from jobsite to jobsite to deliver a permanent identification solution where it's needed, when it's needed
- Creates raised characters on stainless steel and aluminum marker plates, to deliver maximum visibility for medium to high volume applications that are exposed to dirt and paint
- Improves productivity by providing a reliable connection from the embossing machine to your PC using Easy-Mark™ Software
- Easy-Mark™ Software allows for a quick print legend and exact preview saving time and reducing print costs
- Easy loading hopper allows for easy stacking of up to 200 plates, saving time and money

C4. Cable Management

D1. Terminals

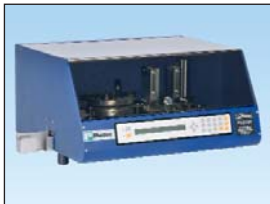

D2. Power Connectors

D3. Grounding Connectors

| Part Number    | Part Description  | Std. Pkg. Qty. |
|----------------|---|----------------|
| <b>PES197*</b> | Portable embossing system 3/16" (4.77mm) character, 11.5" (292mm) x 21.0" (534mm) x 19.0" (483mm), 95 lbs. (43 kg), 115 volt, 60 Hz with Easy-Mark™ Software. | 1              |

Characters include: ABCD...Z, 0123...9, ! @ # \$ % & \* ( ) - + = : " ' . / ?

\*For use with 1000 pack marker plates only.

**System Requirements:** Designed for Windows^ 98, Windows MS, Windows 2000, Windows NT 4.x, Windows XP, Windows Vista 64 MB hard drive space, and 64 MB RAM (256 MB RAM recommended). Female DB9 serial communication port.

^Windows is either a registered trademark or trademark of Microsoft Corporation in the United States and/or other countries.

E1. Labeling Systems

E2. Labels

E3. Pre-Printed & Write-On Markers

E4. Permanent Identification

E5. Lockout/Tagout & Safety Solutions

F. Index

| Part Number                     | Material            | Color   | Length/Diameter |      | Width |      | Max. 3/16" (4.77mm) Character Per Line | Thickness |      | Std. Pkg. Qty. | Std. Ctn. Qty. |
|---------------------------------|---------------------|---------|-----------------|------|-------|------|--|-----------|------|----------------|----------------|
|                                 |                     |         | In.             | mm   | In.   | mm   |  | In.       | mm   |                |                |
| <b>Pan-Steel® Marker Plates</b> |                     |         |                 |      |       |      |  |           |      |                |                |
| <b>MMP350-M</b>                 | 304 Stainless Steel | Natural | 3.50            | 89   | 0.75  | 19   | 18                                     | 0.010     | 0.25 | 1000           | 4000           |
| <b>MMP350-M316</b>              | 316 Stainless Steel |         |                 |      |       |      |  |           |      | 1000           | 4000           |
| <b>MMP350H-M</b>                | 304 Stainless Steel |         |                 |      |       |      |  |           |      | 1000           | 4000           |
| <b>MMP350H-M316</b>             | 316 Stainless Steel | 1000    |                 |      |       |      |  |           |      | 4000           |                |
| <b>MMP350H-MALBU</b>            | Anodized Aluminum   | Blue    |                 |      |       |      |  |           |      | 1000           | 4000           |
| <b>MMP350H-MALGR</b>            |                     | Green   |                 |      |       |      |  |           |      | 1000           | 4000           |
| <b>MMP350H-MALRD</b>            |                     | Red     |                 |      | 1000  | 4000 |  |           |      |                |                |
| <b>MMP350H-MALBL</b>            |                     | Black   |                 |      | 1000  | 4000 |  |           |      |                |                |
| <b>MMP350H-MALYL</b>            |                     | Yellow  |                 |      | 1000  | 4000 |  |           |      |                |                |
| <b>MMP350H-MAL</b>              | Aluminum            | Natural |                 |      | 0.54  | 13.7 | 0.012                                  | 0.30      | 1000 | 4000           |                |
| <b>MMP350HW54-MAL</b>           |                     |         |                 |      | 0.38  | 10   | 0.010                                  | 0.25      | 1000 | 4000           |                |
| <b>MMP350W38-M</b>              | 304 Stainless Steel | Natural |                 |      | 0.38  | 10   | 18                                     | 0.010     | 0.25 | 1000           | 4000           |
| <b>MMP350W38-M316</b>           | 316 Stainless Steel |         | 1000            | 4000 |       |      |  |           |      |                |                |

## LOCKOUT/TAGOUT

The Occupational Safety and Health Administration (OSHA) mandates that all energy sources be isolated and locked out to protect employees from injuries caused by the accidental startup of equipment under repair or service. OSHA 1910.147 outlines the control of this hazardous energy with an effective lockout/tagout program. Panduit offers a complete line of lockout/tagout products to aid in compliance with OSHA 1910.147 including:



- Training manuals and videos to help train employees on the requirements of lockout/tagout
- Extensive line of universal, high quality devices to lockout a variety of energy sources
- Lockout/tagout kits and stations that offer a convenient method to store and contain lockout devices, tags, and padlocks
- High quality, durable, secure padlocks in a variety of styles, colors, and keying configurations that ensure safety and security
- Extensive line of safety identification products that include tags, signs, and warning labels

Panduit offers everything you need to establish and maintain an effective lockout/tagout program. Ensure employee safety while conducting lockout/tagout procedures by utilizing Panduit innovative products and high quality materials.

A.  
System  
Overview

B1.  
Cable  
Ties

B2.  
Cable  
Accessories

B3.  
Stainless  
Steel Ties

C1.  
Wiring  
Duct

C2.  
Surface  
Raceway

C3.  
Abrasion  
Protection

C4.  
Cable  
Management

D1.  
Terminals

D2.  
Power  
Connectors

D3.  
Grounding  
Connectors

E1.  
Labeling  
Systems

E2.  
Labels

E3.  
Pre-Printed  
& Write-On  
Markers

E4.  
Permanent  
Identification

E5.  
Lockout/  
Tagout  
& Safety  
Solutions

F.  
Index



A. System Overview

## OSHA Lockout/Tagout Compliance and Training Kit

B1. Cable Ties

• Takes you step-by-step through the process of bringing your company into compliance with OSHA Standard 1910.147; also provides training materials and devices for educating employees on the elements and applications of lockout/tagout

• This complete package includes:

**Training video:** DVD video “Life is on the Line” for training employees on the elements and application of lockout/tagout (LOTO)

**Compliance CD containing:**

**Training materials:** Training agenda, quiz, certificate, and key points for hands on device training

**Templates:** Step-by-step interactive presentation; facility and machine specific procedure templates; equipment, training, and inspection logs; lockout/tagout program template; periodic and lockout/tagout checklists

**Components:** Demonstration components for thorough “hands-on” training including circuit breakers, ball valves, etc., and the compatible lockout devices

B2. Cable Accessories

B3. Stainless Steel Ties



| Part Number    | Part Description                    | Std. Pkg. Qty. |
|----------------|-------------------------------------|----------------|
| PSL-LOTO-TRAIN | OSHA lockout/tagout compliance kit. | 1              |

C1. Wiring Duct

C2. Surface Raceway

## Group Lockout/Tagout Training Video

C3. Abrasion Protection

• “Your Lock is Your Key to Life” Training Program provides thorough instruction on OSHA recommended safety practices and procedures for group lockout – multi-craft/multi-shift lockout operations

This complete package includes:

- Group lockout/tagout video
- Participant guides with quizzes
- Certificate of completion cards
- Leader’s guide complete with quiz key
- Training log
- Lockout/tagout samples
- Panduit lockout/tagout bulletin
- Lockout steps wallet cards

C4. Cable Management

D1. Terminals

D2. Power Connectors

D3. Grounding Connectors



| Part Number | Part Description   | Number of Guides and Cards Included | Std. Pkg. Qty. | Std. Ctn. Qty. |
|-------------|--|-------------------------------------|----------------|----------------|
| PSL-LTPGP   | Group lockout/tagout video complete training program, English, VHS format. | 10                                  | 1              | 5              |
| PSL-LTMGP   | Replacement group lockout/tagout participant guides and cards, English.    | 10                                  | 1              | 10             |

E1. Labeling Systems

## Lockout/Tagout Steps/Calendar Wallet Card

• Provides those employees responsible for lockout/tagout with a constant reminder of the OSHA recommended steps for shutdown and startup

• Current calendar year is printed on back side

E2. Labels

E3. Pre-Printed & Write-On Markers

E4. Permanent Identification

E5. Lockout/Tagout & Safety Solutions

F. Index

DANGER

A LIFE IS ON THE LINE!

OSHA LOCKOUT STEPS

SHUTDOWN

Inform operator and supervisor about work to be done

- 1) Prepare for shutdown
- 2) Shutdown/turn off equipment
- 3) Isolate from energy source
- 4) Apply lockout/tagout to energy isolating device
- 5) Release all potentially hazardous stored or residual energy
- 6) Verify the isolation

STARTUP

- 1) Assure equipment operationally intact, clear all personnel & tools
- 2) Notify all affected employees about startup and lockout/tagout device removal
- 3) Assure lockout/tagout is removed from each energy-isolating device  
(See section 6(e) and 6(f) of 29 CFR 1910.147 for specific requirements of the standard)

| Part Number | Part Description                           | Width |       | Height |       | Number of Cards Included | Std. Pkg. Qty. | Std. Ctn. Qty. |
|-------------|--|-------|-------|--------|-------|--------------------------|----------------|----------------|
|             |  | In.   | mm    | In.    | mm    |                          |                |                |
| PSL-STEPS   | Lockout/tagout steps/calendar wallet card. | 2.13  | 54.00 | 3.38   | 86.00 | 25                       | 1              | 4              |



## “No Tool” Circuit Breaker Lockout Devices

- Individual circuit breaker can be locked in the off position quickly and easily without any tools
- Compact, universal design fits a wide range of single, double, and triple handle circuit breakers
- Accommodates breaker handle sizes ranging from .30 – .60 inches (7.62mm – 15.24mm) tall and .16 – .35 inches (4.06mm x 8.89mm) thick
- Easily attached with no modifications to panel or circuit breaker and does not require holes in circuit breaker handle
- Constructed of rugged nylon and stainless steel providing strength, durability, added security and corrosion resistance



| Part Number | Part Description   | Std. Pkg. Qty. | Std. Ctn. Qty. |
|-------------|--|----------------|----------------|
| PSL-CBNT    | “No Tool” universal circuit breaker lockout.   | 1              | 10             |
| PSL-CBILNT  | “No Tool” circuit breaker lockout for use with Square D I-LINE <sup>^</sup> /Federal Pacific (FPE) circuit breakers. | 1              | 10             |

<sup>^</sup>I-LINE is a registered trademark of Square D Company.

## Large Handle Circuit Breaker Lockout Device

- Individual circuit breakers can be locked in the off position quickly and easily without any tools
- Compact, universal design fits a wide range of large handle circuit breakers
- Accommodates breaker handle dimensions up to .80 inches thick x 3.00 inches wide (20.32mm x 76.20mm)
- Easily attached with no modifications to panel or circuit breaker
- Constructed of rugged nylon and stainless steel providing strength, durability, added security and corrosion resistance



| Part Number | Part Description                      | Std. Pkg. Qty. | Std. Ctn. Qty. |
|-------------|---------------------------------------|----------------|----------------|
| PSL-CBL     | Large handle circuit breaker lockout. | 1              | 10             |

## Circuit Breaker Lockout Devices

- Individual circuit breakers can be locked in the off position quickly and easily
- Compact, universal design fits a wide range of single, double, and triple handle circuit breakers
- Accommodates breaker handles .30 – .60 inches (7.62mm – 15.24mm) tall and .25 – .44 inches (6.35mm – 11.18mm) thick
- Easily attached with no modifications to panel or circuit breaker and does not require hole in circuit breaker handle
- Constructed of rugged nylon and stainless steel, providing strength, durability, added security and corrosion resistance



| Part Number | Part Description  | Std. Pkg. Qty. | Std. Ctn. Qty. |
|-------------|---|----------------|----------------|
| PSL-CB      | Universal circuit breaker lockout.  | 1              | 10             |
| PSL-CBIL    | Circuit breaker lockout device for use with Square D I-LINE <sup>^</sup> /Federal Pacific (FPE) circuit breakers. | 1              | 10             |
| PSL-CBKIT   | Circuit breaker lockout kit (1 each PSL-CBL, CBNT, CBILNT).   | 1              | 10             |
| PSL-CB-3PC  | (3) PSL-CB universal circuit breaker lockout.   | 1              | 10             |

<sup>^</sup>I-LINE is a registered trademark of Square D Company.

A.  
System  
Overview

B1.  
Cable Ties

B2.  
Cable  
Accessories

B3.  
Stainless  
Steel Ties

C1.  
Wiring  
Duct

C2.  
Surface  
Raceway

C3.  
Abrasion  
Protection

C4.  
Cable  
Management

D1.  
Terminals

D2.  
Power  
Connectors

D3.  
Grounding  
Connectors

E1.  
Labeling  
Systems

E2.  
Labels

E3.  
Pre-Printed  
& Write-On  
Markers

E4.  
Permanent  
Identification

E5.  
Lockout/  
Tagout  
& Safety  
Solutions

F.  
Index

A. System Overview

## Plug Lockout Device

B1. Cable Ties

- Individual plugs in a wide range of sizes can be locked out to prevent energization
- Accommodates padlocks with shackle lengths of 1.50 inches (38.10mm) or greater and plugs with a hole in a blade

- Constructed of rugged polycarbonate providing strength, durability, added security and corrosion resistance

B2. Cable Accessories



B3. Stainless Steel Ties

| Part Number   | Part Description  | Std. Pkg. Qty. | Std. Ctn. Qty. |
|---------------|---|----------------|----------------|
| <b>PSL-P</b>  | Plug lockout.   | 1              | 10             |
| <b>PSL-PI</b> | Global plug lockout for 220 - 240 Volt AC/Industrial Plugs. | 1              | 10             |

C1. Wiring Duct

C2. Surface Raceway

## Cord Lockout Devices

C3. Abrasion Protection

- Individual corded plugs in a wide range of sizes can be locked out to prevent energization

- Constructed of rugged polypropylene providing strength, durability, and added security

C4. Cable Management



D1. Terminals

D2. Power Connectors

D3. Grounding Connectors

| Part Number      | Part Description   | Std. Pkg. Qty. | Std. Ctn. Qty. |
|------------------|--|----------------|----------------|
| <b>PSL-CL110</b> | Lockout for 120 VAC corded plugs, 2.00" x 2.00" x 3.50" inside dimensions.       | 1              | 10             |
| <b>PSL-CL480</b> | Lockout for 240 – 480 VAC corded plugs, 3.25" x 3.25" x 6.50" inside dimensions. | 1              | 10             |

E1. Labeling Systems

## Receptacle Blockout Device

- Accommodates standard 120 V electrical receptacles
- Blockout receptacles to prevent equipment damage from overloading circuits or electrical interference

- Constructed of high density polyethylene providing strength, durability, and added security

E2. Labels



E3. Pre-Printed & Write-On Markers

E4. Permanent Identification

E5. Lockout/Tagout & Safety Solutions

| Part Number    | Part Description                          | Std. Pkg. Qty. | Std. Ctn. Qty. |
|----------------|---|----------------|----------------|
| <b>PSL-ERB</b> | Blockout for 120 V electrical receptacle. | 1              | 25             |

F. Index

## Toggle Switch Lockout Device

- Compact secure design fits most toggle switches and some small circuit breakers
- Easily attached without removal of faceplate or screws
- Accommodates switches
  - .45 – .78 inches (11.43mm – 19.81mm) tall x
  - .25 – .38 inches (6.35mm – 9.65mm) wide x
  - .25 – .40 inches (6.35mm – 10.16mm) thick
- Constructed of rugged nylon and stainless steel providing strength, durability, added security and corrosion resistance



| Part Number | Part Description       | Std. Pkg. Qty. | Std. Ctn. Qty. |
|-------------|------------------------|----------------|----------------|
| PSL-WS      | Toggle switch lockout. | 1              | 10             |

## Toggle/Rocker Switch Lockout Device

- Toggle/rocker switches controlling electrical supply can be locked out
- Accommodates standard wall switch faceplates
- Install using faceplate screws
- Constructed of rugged polypropylene providing strength, durability, and added security



| Part Number | Part Description              | Std. Pkg. Qty. | Std. Ctn. Qty. |
|-------------|-------------------------------|----------------|----------------|
| PSL-WS1A    | Toggle/rocker switch lockout. | 1              | 10             |

## Gate Valve Lockout Devices

- Gate valves regulating hydraulic, pneumatic, and chemical energy can be locked out quickly and easily
- Accommodates valve handles ranging from 1.00 inch (25.40mm) to 13.00 inches (330.20mm) in diameter
- Constructed of rugged polypropylene providing strength, durability, and added security



| Part Number | Part Description  | Std. Pkg. Qty. | Std. Ctn. Qty. |
|-------------|---|----------------|----------------|
| PSL-V2A     | Gate valve lockout, accommodates 1.00" – 2.50" diameter handle.   | 1              | 10             |
| PSL-V6A     | Gate valve lockout, accommodates 2.50" – 6.50" diameter handle.   | 1              | 10             |
| PSL-V9      | Gate valve lockout, accommodates 6.50" – 10.00" diameter handle.  | 1              | 10             |
| PSL-V13     | Gate valve lockout, accommodates 10.00" – 13.00" diameter handle. | 1              | —              |

A.  
System  
Overview

B1.  
Cable Ties

B2.  
Cable  
Accessories

B3.  
Stainless  
Steel Ties

C1.  
Wiring  
Duct

C2.  
Surface  
Raceway

C3.  
Abrasion  
Protection

C4.  
Cable  
Management

D1.  
Terminals

D2.  
Power  
Connectors

D3.  
Grounding  
Connectors

E1.  
Labeling  
Systems

E2.  
Labels

E3.  
Pre-Printed  
& Write-On  
Markers

E4.  
Permanent  
Identification

E5.  
Lockout/  
Tagout  
& Safety  
Solutions

F.  
Index

A. System Overview

## Ball Valve Lockout Devices

B1. Cable Ties

- Ball valves regulating hydraulic, pneumatic, and chemical energy can be locked out quickly and easily
- Accommodates valve diameters ranging from .25 inches (6.35mm) to 3.00 inches (76.20mm)

- Constructed of rugged polypropylene providing strength, durability, and added security

B2. Cable Accessories



B3. Stainless Steel Ties

C1. Wiring Duct

| Part Number    | Part Description  | Std. Pkg. Qty. | Std. Ctn. Qty. |
|----------------|---|----------------|----------------|
| <b>PSL-BV1</b> | Ball valve lockout, accommodates .25" – 1.00" valve pipe diameter.  | 1              | 10             |
| <b>PSL-BV2</b> | Ball valve lockout, accommodates 1.25" – 3.00" valve pipe diameter. | 1              | 10             |
| <b>PSL-BV3</b> | Ball valve lockout, accommodates 2.00" – 8.00" valve pipe diameter. | 1              | 10             |
| <b>PSL-BFV</b> | Butterfly valve lockout, accommodates most butterfly valve handles. | 1              | 10             |

C2. Surface Raceway

## Multiple Lockout Device

- Device can be used alone as a lockout hasp or with provided 0.19 inches (4.8mm) diameter cable to lockout electrical disconnects, gate valves, or large cumbersome devices

- Compact and easy to install
- Constructed of rugged polycarbonate and stainless steel providing strength, durability, added security and corrosion resistance

C3. Abrasion Protection



C4. Cable Management

D1. Terminals

D2. Power Connectors

| Part Number          | Part Description   | Std. Pkg. Qty. | Std. Ctn. Qty. |
|----------------------|--|----------------|----------------|
| <b>PSL-MLD</b>       | Multiple lockout device; includes lockout hasp and 6.0' (1.8m) vinyl coated galvanized steel cable with loop hole. | 1              | 20             |
| <b>PSL-MLDH-X</b>    | Multiple lockout device (hasp only).   | 10             | —              |
| <b>PSL-MLDC</b>      | 6.0' (1.8m) vinyl coated galvanized steel cable with loop hole (cable only).                                       | 1              | 5              |
| <b>PSL-MLDC200</b>   | 200.0' (61.0m) vinyl coated galvanized steel cable on roll without loop hole (cable only).                         | 1              | —              |
| <b>PSL-MLDCT</b>     | 6.0' (1.8m) nylon coated high temperature rating galvanized steel cable with loop hole (cable only).               | 1              | —              |
| <b>PSL-MLD-CRIMP</b> | Additional crimps for creating cable loop holes.   | 10             | 20             |
| <b>PSL-MLD-TOOL</b>  | Tool for installing crimps on custom-length cables using the PSL-MDLC200.  | 1              | 6              |

D3. Grounding Connectors

E1. Labeling Systems

E2. Labels

E3. Pre-Printed & Write-On Markers

E4. Permanent Identification

E5. Lockout/Tagout & Safety Solutions

F. Index



Lockout single or multiple electrical disconnects



Lockout gate valves



Immobilize large or cumbersome devices, such as forklifts

## Pneumatic Energy Lockout Device

- Pneumatic energy devices can be locked out quickly and easily without costly tool modifications or inconvenient in-line valves
- When installed on the male pneumatic fitting, prevents the ability to engage into the female fitting

- Universal compact design makes the pneumatic lockout device easy to transport and install on almost any fitting, even in tight spaces
- Rugged stainless steel construction offers superior strength, durability, added security and corrosion resistance



| Part Number    | Part Description   | Std. Pkg. Qty. | Std. Ctn. Qty. |
|----------------|--|----------------|----------------|
| <b>PSL-PEL</b> | Pneumatic energy lockout device, 3.50" (88.9mm) diameter x 0.10" (2.54mm) thick. | 1              | 20             |

## Electrician Lockout Kit

- Kit contains a variety of lockout/tagout devices commonly used by an individual electrician



| Part Number | Contents  | Std. Pkg. Qty. | Std. Ctn. Qty. |
|-------------|---|----------------|----------------|
| PSL-PK-EA   | (1) Screwdriver.<br>(1) PSL-PK pouch.<br>(1) PSL-8 red non-conductive lockout padlock.<br>(1) PSL-MLD multiple lockout device.<br>(1) PSL-WS wall switch lockout device.<br>(1) PSL-CBNT "No Tool" circuit breaker lockout device.<br>(1) PSL-P plug lockout device.<br>(5) PVT-30 electrician's blocking tags. | 1              | 5              |

## Contractor Lockout Kit

- Kit contains a variety of lockout/tagout devices commonly used by electrical contractors



| Part Number | Contents  | Std. Pkg. Qty. |
|-------------|---|----------------|
| PSL-KT-CONA | (1) Screwdriver.<br>(1) PSL-KT carrying case – 5.0" x 3.5" x 11.0" (127mm x 89mm x 279mm).<br>(6) PSL-8 red non-conductive lockout padlocks.<br>(1) PSL-1A lockout hasp – 1.0" (25mm) jaw diameter.<br>(1) PSL-MLD multiple lockout device.<br>(3) PSL-WS wall switch lockouts.<br>(3) PSL-CBNT "No Tool" circuit breaker lockout device.<br>(3) PSL-P plug lockouts.<br>(15 Tags) PVT-98 "EQUIPMENT LOCKED OUT BY..." safety tags. | 1              |

## MRO Lockout Kit

- Kit contains a variety of lockout/tagout devices commonly used by maintenance and repair personnel



| Part Number | Contents   | Std. Pkg. Qty. |
|-------------|--|----------------|
| PSL-KT-MROA | (1) Screwdriver.<br>(1) PSL-BX carrying case – 6.5" x 5.0" x 14.5" (32mm x 127mm x 368mm).<br>(3) PSL-8 red non-conductive lockout padlocks.<br>(1) PSL-MLD multiple lockout device.<br>(2) PSL-WS wall switch lockouts.<br>(2) PSL-CBNT "No Tool" circuit breaker lockout device.<br>(2) PSL-P plug lockouts.<br>(1) PSL-V6A gate valve lockout – 6.5" (165mm).<br>(1) PSL-V2A gate valve lockout – 2.5" (64mm).<br>(1) PSL-BV2 ball valve lockout – 3.0" (76mm).<br>(1) PSL-CL110 110V plug lockout.<br>(10) PVT-44 "DO NOT OPERATE" maintenance tags. | 1              |

## Power and Panel Distribution Lockout Kit

- Kit contains a variety of lockout/tagout devices commonly used to isolate electrical distribution panels
- Durable steel case can be wall mounted or used as a portable case



| Part Number | Contents   | Std. Pkg. Qty. |
|-------------|--|----------------|
| PSL-KT-PWR  | (1) Screwdriver.<br>(1) PSL-STATION metal wall mount cabinet.<br>(2) PSL-8 red non-conductive lockout padlocks.<br>(1) PSL-MLD multiple lockout device.<br>(2) PSL-CBNT "No Tool" circuit breaker lockout device.<br>(2) PSL-CBILNT circuit breaker lockout device for Square D I-LINE^/Federal Pacific (FPE) circuit breakers.<br>(2) PSL-CBL large handle circuit breaker lockout devices.<br>(1) PSL-P plug lockout.<br>(25) PVT-23-Q "DO NOT OPERATE ELECTRICIANS AT WORK" tags. | 1              |

^ I-LINE is a registered trademark of Square D Company.

A. System Overview

B1. Cable Ties

B2. Cable Accessories

B3. Stainless Steel Ties

C1. Wiring Duct

C2. Surface Raceway

C3. Abrasion Protection

C4. Cable Management

D1. Terminals

D2. Power Connectors

D3. Grounding Connectors

E1. Labeling Systems

E2. Labels

E3. Pre-Printed & Write-On Markers

E4. Permanent Identification

E5. Lockout/Tagout & Safety Solutions

F. Index



A. System Overview

## Metal Wall Mount Cabinet

B1. Cable Ties

- Conveniently store lockout tools and accessories in one common area

- Durable steel case can be wall-mounted (nine mounting holes) or used as a portable case
- 14.75" x 10.25" x 4.63" (375.00mm x 260.00mm x 117.00mm)



| Part Number        | Part Description                       | Std. Pkg. Qty. |
|--------------------|--|----------------|
| <b>PSL-STATION</b> | Metal wall mount cabinet.              | 1              |
| <b>PSL-PK</b>      | Empty pouch for PSL-PK-EA.             | 1              |
| <b>PSL-KT</b>      | Empty plastic kit box for PSL-KT-CONA. | 1              |
| <b>PSL-BX</b>      | Empty plastic kit Box for PSL-KT-MROA. | 1              |

B2. Cable Accessories

B3. Stainless Steel Ties

C1. Wiring Duct

## Lockout Stations

C2. Surface Raceway

- Conveniently store padlocks, tags, and lockout devices in one common area



PSL-10SWCA

| Part Number       | Part Description  | Width |       | Height |       | Std. Pkg. Qty. |
|-------------------|---|-------|-------|--------|-------|----------------|
|                   |   | In.   | mm    | In.    | mm    |                |
| <b>PSL-20SA</b>   | Lockout station only, 20 person.  | 23.00 | 584.2 | 23.00  | 584.2 | 1              |
| <b>PSL-20SWCA</b> | Lockout station with components, 20 person.<br>Components include:<br>(20) PSL-8 red non-conductive lockout padlocks (keyed differently)<br>(6) PSL-1.5 lockout hasps<br>(25 tags) PVT-98 safety tags<br>(25 tags) PVT-41 safety tags | 23.00 | 584.2 | 23.00  | 584.2 | 1              |
| <b>PSL-10SA</b>   | Lockout station only, 10 person.  | 11.50 | 292.1 | 23.00  | 584.2 | 1              |
| <b>PSL-10SWCA</b> | Lockout station with components, 10 person.<br>Components include:<br>(10) PSL-8 red non-conductive lockout padlocks (keyed differently)<br>(3) PSL-1.5 lockout hasps<br>(15 tags) PVT-98 safety tags<br>(10 tags) PVT-41 safety tags | 11.50 | 292.1 | 23.00  | 584.2 | 1              |
| <b>PSL-4SA</b>    | Lockout station only, 4 person.   | 11.50 | 292.1 | 11.50  | 292.1 | 1              |
| <b>PSL-4SWCA</b>  | Lockout station with components, 4 person.<br>Components include:<br>(4) PSL-8 red non-conductive lockout padlocks (keyed differently)<br>(3) PSL-1.5 lockout hasps<br>(15 tags) PVT-98 safety tags                                   | 11.50 | 292.1 | 11.50  | 292.1 | 1              |

C3. Abrasion Protection

C4. Cable Management

D1. Terminals

D2. Power Connectors

D3. Grounding Connectors

E1. Labeling Systems

E2. Labels

E3. Pre-Printed & Write-On Markers

## Group Lock Box

E4. Permanent Identification

- Manage multiple employees and energy sources involved in a group lockout procedure
- Accommodates up to thirteen padlocks (not included)

- Industrial powder coated steel construction
- Dimensions: 9.00"W x 6"H x 3.25"D (228.60mm x 152.40mm x 82.55mm)



| Part Number     | Part Description | Std. Pkg. Qty. |
|-----------------|------------------|----------------|
| <b>PSL-GLBN</b> | Group lock box.  | 1              |

E5. Lockout/Tagout & Safety Solutions

F. Index



## Warning Label

- Warning label prohibits tampering with push buttons during repair or service
- Write-on area for adding your own warning message
- Made of vinyl cloth material that allows label to be removed easily after repairs are completed
- Features the international prohibition symbol for “Do Not Throw Switch”



### Material Chart

| Material           | Print Method | Temperature Range                 | Features  |
|--------------------|--------------|-----------------------------------|---|
| Vinyl Cloth, White | Pre-Printed  | -50°F to 170°F<br>(-46°C to 77°C) | Indoor/outdoor rated; thin conformable material with repositionable adhesive allows label to be removed and reused or used in temporary applications; provides durability, high temperature resistance, and dimensional stability for rough or textured surfaces. |

| Part Number | Part Description | Width |        | Height |       | Markers Per Book | Std. Pkg. Qty. (Book) | Std. Ctn. Qty. (Books) |
|-------------|------------------|-------|--------|--------|-------|------------------|-----------------------|------------------------|
|             |                  | In.   | mm     | In.    | mm    |                  |                       |                        |
| PSL-CBWL    | Warning label    | 4.84  | 123.00 | .54    | 14.00 | 60               | 1                     | 10                     |

Can be clearly identified with Panduit permanent marking pens, page E5.18.

## Circuit Breaker Directory Sign

- Adhesive paper sign designed to provide clear identification of circuit breaker connections, list up to 40 circuits
- Eliminate the guesswork when identifying power sources – a must for lockout/tagout compliance



### Material Chart

| Material | Print Method | Temperature Range                 | Features  |
|----------|--------------|-----------------------------------|---|
| Paper    | Pre-Printed  | -65°F to 200°F<br>(-54°C to 93°C) | Indoor rated; general purpose material; excellent adhesion properties when applied to a clean, dry surface. |

| Part Number | Part Description                | Color (Legend/Background) | Labels Per Pkg. | Width |        | Height |        | Std. Pkg. Qty. | Std. Ctn. Qty. |
|-------------|---------------------------------|---------------------------|-----------------|-------|--------|--------|--------|----------------|----------------|
|             |                                 |                           |                 | In.   | mm     | In.    | mm     |                |                |
| PES-S1      | Circuit breaker directory sign. | Red and Black/White       | 5               | 13.00 | 330.00 | 5.50   | 140.00 | 1              | 20             |

A. System Overview

## Non-Conductive Lockout Padlocks

B1. Cable Ties

- Non-conductive lock body and shackle provide protection against electrical hazards
- Available in six assorted colors for quick visual color identification
- Padlocks can be ordered with various keying options (keyed-alike and master-keyed)
- Key-retention feature means that key cannot be removed from padlock when open
- Six-pin cylinder design allows for a large number of key options

B2. Cable Accessories



B3. Stainless Steel Ties

| Part Number | Color  | Std. Pkg. Qty. |
|-------------|--------|----------------|
| PSL-8       | Red    | 1              |
| PSL-8BL     | Black  | 1              |
| PSL-8BU     | Blue   | 1              |
| PSL-8GR     | Green  | 1              |
| PSL-8OR     | Orange | 1              |
| PSL-8YL     | Yellow | 1              |
| PSL-8BR     | Brown  | 1              |
| PSL-8PU     | Purple | 1              |

C1. Wiring Duct

C2. Surface Raceway

C3. Abrasion Protection

| Part Number | Part Description                                     | Std. Pkg. Qty. |
|-------------|--|----------------|
| PSL-8-LABEL | Package of 20 replacement labels for PSL-8 padlocks. | 1              |

C4. Cable Management

These locks can be master keyed or keyed alike. These locks can also be custom engraved. See Custom Lock Options on page E5.12 and Order Form on page E5.43.

D1. Terminals

## High Security Padlocks

D2. Power Connectors

- Solid aluminum body with anodized aluminum finish provides improved durability and corrosion resistance
- Available in six assorted colors for quick visual color identification
- Padlocks can be ordered with various keying options (keyed-alike and master-keyed)
- Six-pin cylinder design allows for a large number of key change options

D3. Grounding Connectors



| Part Number                           | Color  | Std. Pkg. Qty. |
|---------------------------------------|--------|----------------|
| <b>Short shackle – 1.00" (25.4mm)</b> |        |                |
| PSL-7                                 | Red    | 1              |
| PSL-7BL                               | Black  | 1              |
| PSL-7BU                               | Blue   | 1              |
| PSL-7GR                               | Green  | 1              |
| PSL-7OR                               | Orange | 1              |
| PSL-7YL                               | Yellow | 1              |
| PSL-7BR                               | Brown  | 1              |
| PSL-7PU                               | Purple | 1              |

E1. Labeling Systems

E2. Labels

E3. Pre-Printed & Write-On Markers

E4. Permanent Identification

E5. Lockout/Tagout & Safety Solutions

|                                      |        |   |
|--------------------------------------|--------|---|
| <b>Long shackle – 3.00" (76.2mm)</b> |        |   |
| PSL-7-LS                             | Red    | 1 |
| PSL-7BL-LS                           | Black  | 1 |
| PSL-7BU-LS                           | Blue   | 1 |
| PSL-7GR-LS                           | Green  | 1 |
| PSL-7OR-LS                           | Orange | 1 |
| PSL-7YL-LS                           | Yellow | 1 |
| PSL-7BR-LS                           | Brown  | 1 |
| PSL-7PU-LS                           | Purple | 1 |

These locks can be ordered with various keying options (keyed-alike or master-keyed) and custom engraved. See Custom Lock Options on page E5.12 and Order Form on page E5.43.

## Laminated Steel Padlocks

- Standard locks are keyed differently – each padlock is supplied with two keys
- Hardened steel shackle with double-ball locking mechanism provides protection from cutting, prying, and rusting
- Available in six vinyl bumper colors for quick visual color identification
- Padlocks can be ordered with various keying options (keyed-alike and master-keyed)
- Galvanized layer design provides corrosion resistance in harsh environments



| Part Number                          | Color  | Std. Pkg. Qty. |
|--------------------------------------|--------|----------------|
| <b>Short shackle – .75" (19.3mm)</b> |        |                |
| PSL-6                                | Red    | 1              |
| PSL-6BL                              | Black  | 1              |
| PSL-6BU                              | Blue   | 1              |
| PSL-6GR                              | Green  | 1              |
| PSL-6WH                              | White  | 1              |
| PSL-6YL                              | Yellow | 1              |
| <b>Long shackle – 2.00" (46.8mm)</b> |        |                |
| PSL-6-LS                             | Red    | 1              |
| PSL-6BL-LS                           | Black  | 1              |
| PSL-6BU-LS                           | Blue   | 1              |
| PSL-6GR-LS                           | Green  | 1              |
| PSL-6WH-LS                           | White  | 1              |
| PSL-6YL-LS                           | Yellow | 1              |

These locks are not suitable for custom engraving.

See Custom Lock Options on page E5.12 and Order Form on page E5.43.

## Lockout Hasps

- Energy sources can be locked out quickly and easily by more than one worker for group lockout applications
- Heavy duty hasps with tamper-resistant designs to deter vandalism
- Variety of lockout hasp styles and sizes to accommodate a wide range of lockout applications

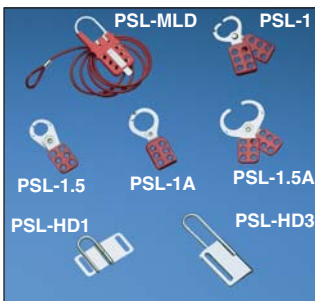

| Part Number | Part Description   | Max. No. Locks | Std. Pkg. Qty. | Std. Ctn. Qty. |
|-------------|--|----------------|----------------|----------------|
| PSL-MLD     | Multiple lockout device; includes lockout hasp and 6.0' (1.8m) vinyl coated galvanized steel cable with loop-hole. | 6              | 1              | 20             |
| PSL-MLDH-X  | Multiple lockout device (hasp only).   | 6              | 10             | —              |
| PSL-1       | Hasp with 1.00" (25.40mm) diameter jaw and overlapping tabs.   | 6              | 12             | 144            |
| PSL-1.5     | Hasp with 1.50" (38.10mm) diameter jaw and overlapping tabs.   | 6              | 12             | 144            |
| PSL-1A      | Hasp with 1.00" (25.40mm) diameter jaw.  | 6              | 12             | 144            |
| PSL-1.5A    | Hasp with 1.50" (38.10mm) diameter jaw.  | 6              | 12             | 48             |
| PSL-HD1     | Heavy duty hasp with 1.00" x 1.00" (25.40mm x 25.40mm) clearance.  | 5              | 12             | —              |
| PSL-HD2.4   | Heavy duty hasp with 1.00" x 2.40" (25.40mm x 60.00mm) clearance.  | 5              | 12             | —              |
| PSL-HD3     | Heavy duty hasp with 1.00" x 3.00" (25.40mm x 76.00mm) clearance.  | 7              | 12             | —              |

A.  
System  
Overview

B1.  
Cable Ties

B2.  
Cable  
Accessories

B3.  
Stainless  
Steel Ties

C1.  
Wiring  
Duct

C2.  
Surface  
Raceway

C3.  
Abrasion  
Protection

C4.  
Cable  
Management

D1.  
Terminals

D2.  
Power  
Connectors

D3.  
Grounding  
Connectors

E1.  
Labeling  
Systems

E2.  
Labels

E3.  
Pre-Printed  
& Write-On  
Markers

E4.  
Permanent  
Identification

E5.  
Lockout/  
Tagout  
& Safety  
Solutions

F.  
Index

A. System Overview

## Self-Laminating Padlock Labels

B1. Cable Ties

- Used to identify employees' locks; employees sign the label, attach it to the padlock, and overwrap with the clear vinyl to protect the legend
- Available in six colors for departmental coding
- One-piece design is easy to use

B2. Cable Accessories



B3. Stainless Steel Ties

C1. Wiring Duct

| Part Number | Color  | Width |        | Height |       | Std. Pkg. Qty. | Std. Ctn. Qty. |
|-------------|--------|-------|--------|--------|-------|----------------|----------------|
|             |        | In.   | mm     | In.    | mm    |                |                |
| PSL-PL1BLKY | Black  | 10.00 | 254.00 | .75    | 19.00 | 25             | 150            |
| PSL-PL1BLUY | Blue   | 10.00 | 254.00 | .75    | 19.00 | 25             | 150            |
| PSL-PL1GRNY | Green  | 10.00 | 254.00 | .75    | 19.00 | 25             | 150            |
| PSL-PL1REDY | Red    | 10.00 | 254.00 | .75    | 19.00 | 25             | 150            |
| PSL-PL1WHTY | White  | 10.00 | 254.00 | .75    | 19.00 | 25             | 150            |
| PSL-PL1YELY | Yellow | 10.00 | 254.00 | .75    | 19.00 | 25             | 150            |

Labels are designed with blank write-on area for name and department designation and can be clearly identified with Panduit permanent marking pens.

C2. Surface Raceway

C3. Abrasion Protection

## Custom Lock Options

Padlocks are available with the following common lock options:

C4. Cable Management

- Master keyed
- Keyed-alike
- Variety of lock sizes and shackle lengths
- Engraving available on PSL-8 Safety Lockout and PSL-7 High Security Padlocks

D1. Terminals

D2. Power Connectors

D3. Grounding Connectors

E1. Labeling Systems

E2. Labels

E3. Pre-Printed & Write-On Markers

E4. Permanent Identification

E5. Lockout/Tagout & Safety Solutions

F. Index

Individually Keyed

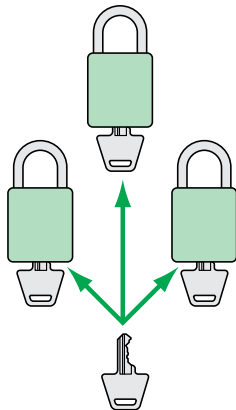

Master Key

Keyed-Alike Systems



## Metal I.D. Tags and Collars



| Part Number | Part Description  | Std. Pkg. Qty. | Std. Ctn. Qty. |
|-------------|---|----------------|----------------|
| PSL-TG1     | Brass padlock identification tag.                                   | 12             | 48             |
| PSL-SC      | Padlock shackle collar and rivet.                                   | 12             | 48             |
| MTB1D-Q     | Marker tag, 1.00" circular, brass.                                  | 25             | 250            |
| MT172W38-C  | Marker tag, one hole, 304 Stainless Steel, rectangle, 1.72" x .38". | 100            | 1000           |

## Padlock Eyes

- Padlock eyes assist with compliance to OSHA standards requiring that equipment be modified to accept locks and lockout devices
- Surface mounted eyes are made of .13 inches (3.00mm) hard wrought steel
- Tamper resistant inside mounting eyes – 2.50 inches W (64.00mm), accept shackle diameters up to .63 inches (16.00mm)



| Part Number | Part Description  | Std. Pkg. Qty. | Std. Ctn. Qty. |
|-------------|---|----------------|----------------|
| PSL-PE1     | Padlock eyes, angled (metal mounting screws included).  | 1              | 10             |
| PSL-PE2     | Padlock eyes, straight (wood mounting screws included). | 1              | 10             |

## Chain Attachment

- Optional 9.00 inches (229.00mm) chain for permanently attaching lockouts at pre-designed locations



| Part Number | Part Description   | Std. Pkg. Qty. | Std. Ctn. Qty. |
|-------------|--|----------------|----------------|
| PSL-PC      | Heavy duty zinc plated steel chain with chain holder attached. | 1              | 10             |

A.  
System  
Overview

B1.  
Cable Ties

B2.  
Cable  
Accessories

B3.  
Stainless  
Steel Ties

C1.  
Wiring  
Duct

C2.  
Surface  
Raceway

C3.  
Abrasion  
Protection

C4.  
Cable  
Management

D1.  
Terminals

D2.  
Power  
Connectors

D3.  
Grounding  
Connectors

E1.  
Labeling  
Systems

E2.  
Labels

E3.  
Pre-Printed  
& Write-On  
Markers

E4.  
Permanent  
Identification

E5.  
Lockout/  
Tagout  
& Safety  
Solutions

F.  
Index

A. System Overview

## Write-On Safety Tags

B1. Cable Ties

- Meet OSHA Standard 1910.147 requirements for tagout applications
- Semi-rigid plastic tags are 3.00" (76.00mm) W x 5.75" (146.00mm) H with a .38" (9.00mm) brass grommet for greater strength and increased durability
- Tags can be attached with a lockout device or with a Panduit PLT2S nylon tie (50 lb. loop tensile strength) supplied with each tag

- PVT-\* Package consists of five tags and five cable ties
- PVT-\*-Q Package consists of 25 tags and 25 cable ties
- Can be clearly identified with Panduit permanent marking pens

B2. Cable Accessories

B3. Stainless Steel Ties



C1. Wiring Duct

C2. Surface Raceway

C3. Abrasion Protection

C4. Cable Management

D1. Terminals

D2. Power Connectors

D3. Grounding Connectors

### Material Chart

| Material    | Print Method | Temperature Range              | Features  |
|-------------|--------------|--------------------------------|---|
| Rigid Vinyl | Pre-Printed  | -40°F to 150°F (-40°C to 66°C) | Indoor/outdoor rated; rigid material accepts ink; resistant to UV light, chemical atmosphere, and abrasion; excellent for applications where adhesives will not work. |



Front PVT-9-Q Back



Front PVT-15 Back



Front PVT-23 Back PVT-23-Q



Front PVT-30 Back PVT-30-Q



Front PVT-41 Back



Front PVT-42-Q Back

E1. Labeling Systems

E2. Labels

E3. Pre-Printed & Write-On Markers

E4. Permanent Identification

E5. Lockout/Tagout & Safety Solutions

F. Index



## Write-On Safety Tags (continued)

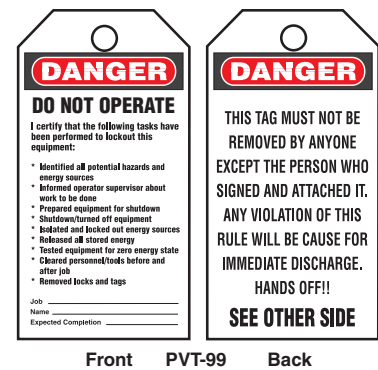
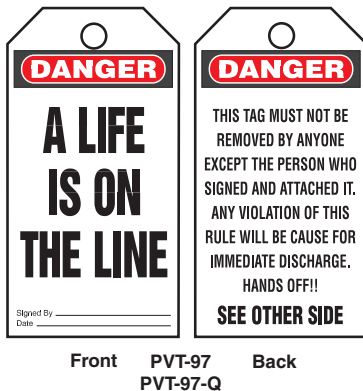
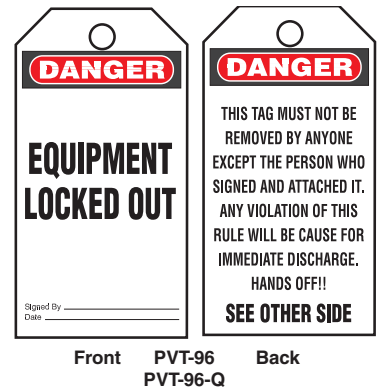
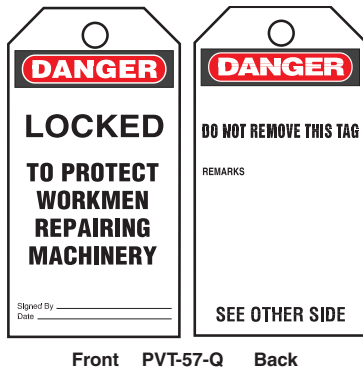
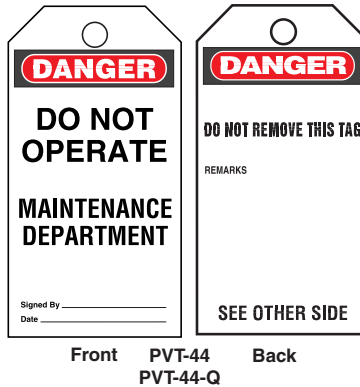

Tags continue on page E5.16.

A. System Overview

B1. Cable Ties

B2. Cable Accessories

B3. Stainless Steel Ties

C1. Wiring Duct

C2. Surface Raceway

C3. Abrasion Protection

C4. Cable Management

D1. Terminals

D2. Power Connectors

D3. Grounding Connectors

E1. Labeling Systems

E2. Labels

E3. Pre-Printed & Write-On Markers

E4. Permanent Identification

E5. Lockout/Tagout & Safety Solutions

F. Index

A. System Overview

## Write-On Safety Tags (continued)

B1. Cable Ties

B2. Cable Accessories

B3. Stainless Steel Ties

C1. Wiring Duct

C2. Surface Raceway

C3. Abrasion Protection

C4. Cable Management

D1. Terminals

D2. Power Connectors

D3. Grounding Connectors

E1. Labeling Systems

E2. Labels

E3. Pre-Printed & Write-On Markers

E4. Permanent Identification

E5. Lockout/Tagout & Safety Solutions

F. Index

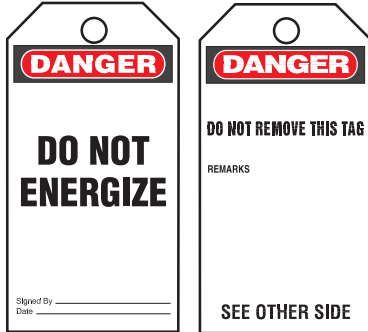

Front PVT-148-Q Back

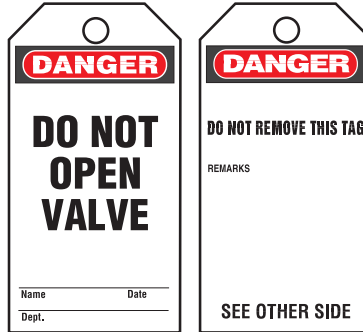

Front PVT-150-Q Back

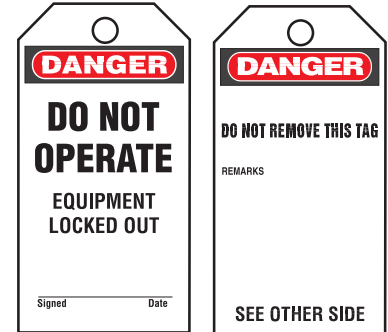

Front PVT-153-Q Back

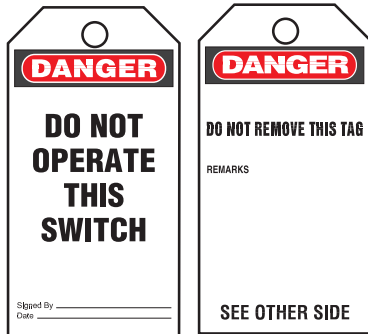

Front PVT-155-Q Back

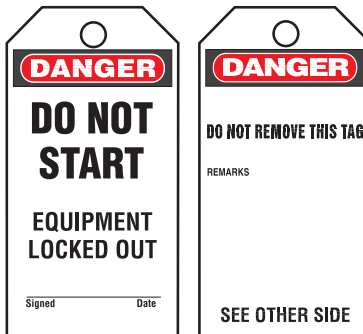

Front PVT-156-Q Back

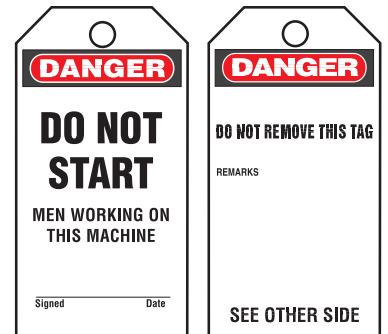

Front PVT-157-Q Back



Front PVT-158-Q Back



Front PVT-160-Q Back

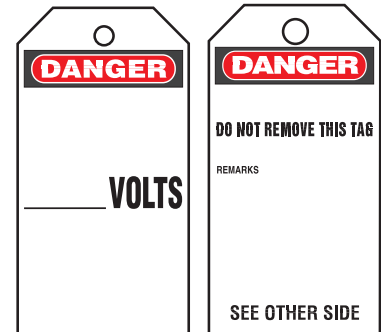

Front PVT-238-Q Back

## Bilingual Write-On Safety Tags

- Meet OSHA Standard 1910.147 requirements for tagout applications
- Semi-rigid plastic tags are 3.00"W x 5.75"H (76.00mm x 146.00mm) with a .38" (9.00mm) brass grommet for greater strength and increased durability

- Tags can be attached with a lockout device or with a Panduit PLT2S nylon tie (50 lb. loop tensile strength) supplied with each tag
- Package consists of 25 tags and 25 cable ties
- Can be clearly identified with Panduit permanent marking pens



## ISO Symbol Safety Tags

- Meets International Organization for Standardization (ISO) to communicate safety information
- Semi-rigid plastic tags are 3.00"W x 5.75"H (76.00mm x 146.00mm) with a .38" (9.00mm) brass grommet for greater strength and durability

- Tags have write-on surface and can be attached with a lockout device or with a Panduit PLT2S nylon tie (50 lb. loop tensile strength) supplied with each tag
- Package consists of five tags and five cable ties
- Can be clearly identified with Panduit permanent marking pens



## Do It Yourself Tags

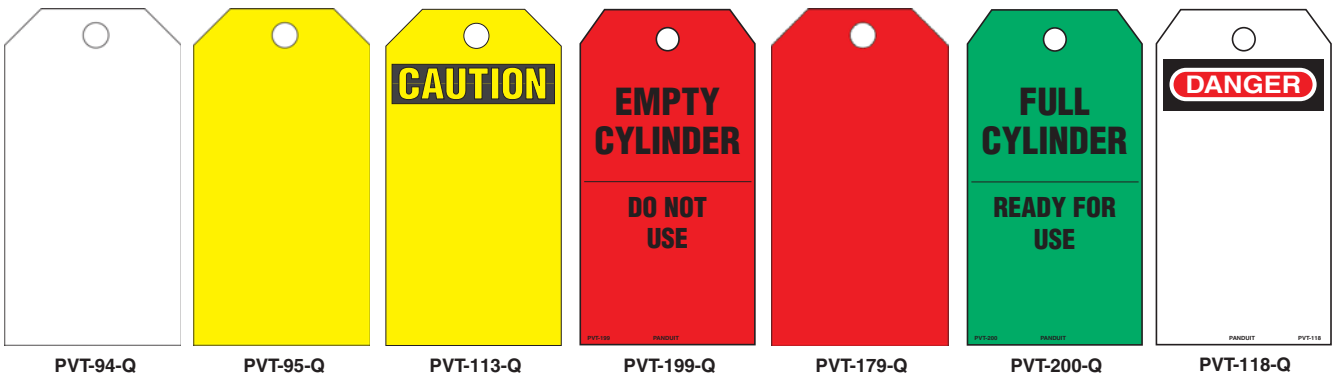

A. System Overview

B1. Cable Ties

B2. Cable Accessories

B3. Stainless Steel Ties

C1. Wiring Duct

C2. Surface Raceway

C3. Abrasion Protection

C4. Cable Management

D1. Terminals

D2. Power Connectors

D3. Grounding Connectors

E1. Labeling Systems

E2. Labels

E3. Pre-Printed & Write-On Markers

E4. Permanent Identification

E5. Lockout/Tagout & Safety Solutions

F. Index

A. System Overview

## Self-Laminating Photo Tags

B1. Cable Ties

- Semi-rigid plastic tags with polyester laminate to protect photos and other written data are 3.00"W x 5.75"H (76.00mm x 146.00mm) with a .38" (9.00mm) brass grommet for greater strength and durability

- Package consists of five tags and five cable ties
- Can be clearly identified with Panduit permanent marking pens

B2. Cable Accessories

- Tags have write-on surface and can be attached with a lockout device or with a Panduit PLT2S nylon tie (50 lb. loop tensile strength) supplied with each tag

B3. Stainless Steel Ties

C1. Wiring Duct

C2. Surface Raceway



Front PST-3 Back

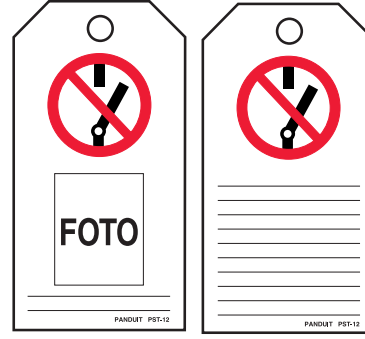

Front PST-12 Back

C3. Abrasion Protection

C4. Cable Management

D1. Terminals

D2. Power Connectors

## Permanent Marking Pens

- Fast drying, permanent ink – legible identification on nylon

- Used with marker ties, write-on labels and tags, where ordinary marking pens will not work

D3. Grounding Connectors



| Part Number | Part Description                  | Ink Color | Std. Pkg. Qty. | Std. Ctn. Qty. |
|-------------|-----------------------------------|-----------|----------------|----------------|
| PFX-0       | Permanent marking pen – fine tip. | Black     | 12             | 144            |
| PFX-2       | Permanent marking pen – fine tip. | Red       | 12             | 144            |

E1. Labeling Systems

E2. Labels

E3. Pre-Printed & Write-On Markers

E4. Permanent Identification

E5. Lockout/Tagout & Safety Solutions

F. Index

## Lockout/Tagout Safety Signs

### Indoor/Outdoor Sub-Surface Printed Adhesive Polyester (Type PPS)

- High quality signs for use indoors and outdoors
- Excellent resistance to UV light, chemical atmosphere, and abrasion
- Excellent life and adhesion properties
- Printed graphics are protected by clear polyester laminate

### Indoor/Outdoor Rigid Polyethylene (Type PRS)

- Rugged signs for indoors and outdoors
- Abrasion resistant
- Used where adhesives will not work

### Indoor Adhesive Vinyl (Type PVS)

- Economical general purpose signs for use in most environments
- Very good adhesive properties when applied to a clean, dry surface

### Material Chart



| Material                 | Print Method | Temperature Range                | Features  |
|--------------------------|--------------|----------------------------------|---|
| Polyester (PPS)          | Pre-Printed  | -40°F to 275°F (-40°C to 135°C)  | Indoor/outdoor rated; laminated label material protects legend from abrasion and chemicals; resistant to UV light, chemical atmosphere, and abrasion; excellent life and adhesion properties. |
| Rigid Polyethylene (PRS) |              | -105°F to 250°F (-76°C to 121°C) | Indoor/outdoor rated; high quality, rugged material resistant to abrasion; use where adhesives will not work.   |
| Vinyl (PVS)              |              | -40°F to 200°F (-40°C to 93°C)   | Indoor rated; economical general purpose material; excellent adhesion properties when applied to a clean, dry surface.  |

### Size Reference Chart

| Part Number | Width |        | Height |        | Signs per Card |
|-------------|-------|--------|--------|--------|----------------|
|             | In.   | mm     | In.    | mm     |                |
| *0109*      | 9.00  | 228.60 | 1.50   | 38.10  | 1              |
| *0204*      | 4.50  | 114.30 | 2.25   | 57.15  | 2              |
| *0209*      | 9.00  | 228.60 | 2.25   | 57.15  | 1              |
| *0305*      | 5.00  | 127.00 | 3.50   | 88.90  | 1              |
| *0503*      | 3.00  | 76.20  | 5.00   | 127.00 | 2              |
| *0507*      | 7.00  | 177.80 | 5.00   | 127    | 1              |
| *0509*      | 9.00  | 228.60 | 5.00   | 127    | 1              |
| *0710*      | 10.00 | 254.00 | 7.00   | 177.8  | 1              |
| *1014*      | 14.00 | 355.60 | 10.00  | 254    | 1              |
| *0202*      | 2.25  | 57.15  | 2.25   | 57.15  | 4              |
| *0505*      | 5.00  | 127.00 | 5.00   | 127.00 | 1              |

\*Denotes the part numbers' prefix and suffix.



PVS0305W2102Y



PVS0305W2101Y^  
PVS0507W2101Y^



PRS1014B364  
PVS0509B364Y  
PVS0710B364Y  
PPS0710B364  
PRS0710B364



PPS0710D72  
PRS0710D72  
PRS1014D72  
PVS0109D72Y  
PVS0204D72Y  
PVS0710D72Y

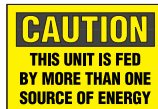

PVS0305C174Y  
PVS0505C174Y  
PPS0305C174



PVS0710C173Y



PVS0204D100Y



PVS0209D445Y



PVS0204C171Y



PVS0710C180Y

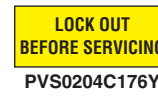

PVS0204C176Y



PVS0204C177Y

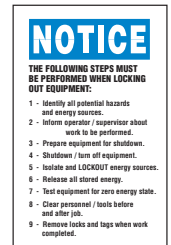

PVS0503N458Y



PVS0204C179Y



PVS0204W172Y



PVS0204C178Y



PPS0202B493

^Can be clearly identified with Panduit permanent marking pens.

A. System Overview

B1. Cable Ties

B2. Cable Accessories

B3. Stainless Steel Ties

C1. Wiring Duct

C2. Surface Raceway

C3. Abrasion Protection

C4. Cable Management

D1. Terminals

D2. Power Connectors

D3. Grounding Connectors

E1. Labeling Systems

E2. Labels

E3. Pre-Printed & Write-On Markers

E4. Permanent Identification

E5. Lockout/Tagout & Safety Solutions

F. Index

A. System Overview

## Jack Module Blockout Device

B1. Cable Ties

- Blocks unauthorized access to jacks and potentially harmful foreign objects, saving time and money associated with data security breaches, network downtime, repair and hardware replacement
- Compatible with most RJ45 jacks to accommodate a variety of applications and does not interfere with jack contacts

- Can be installed/removed without interfering with adjacent jacks or hardware
- May only be released with the special removal tool, ensuring the safety and security of your network infrastructure

B2. Cable Accessories

B3. Stainless Steel Ties

C1. Wiring Duct

C2. Surface Raceway

C3. Abrasion Protection

C4. Cable Management

D1. Terminals

D2. Power Connectors

D3. Grounding Connectors

E1. Labeling Systems

E2. Labels

E3. Pre-Printed & Write-On Markers

E4. Permanent Identification

E5. Lockout/Tagout & Safety Solutions

F. Index



| Part Number*       | Part Description  | Color               | Std. Pkg. Qty. | Std. Ctn. Qty. |
|--------------------|---|---------------------|----------------|----------------|
| <b>PSL-DCJB</b>    | Package of ten RJ45 jack blockout devices and one removal tool. | Red                 | 1              | 20             |
| <b>PSL-DCJB-BL</b> | Package of ten RJ45 jack blockout devices and one removal tool. | Black               | 1              | 20             |
| <b>PSL-DCJB-BU</b> | Package of ten RJ45 jack blockout devices and one removal tool. | Blue                | 1              | 20             |
| <b>PSL-DCJB-YL</b> | Package of ten RJ45 jack blockout devices and one removal tool. | Yellow              | 1              | 20             |
| <b>PSL-DCJB-IW</b> | Package of ten RJ45 jack blockout devices and one removal tool. | International White | 1              | 20             |
| <b>PSL-DCJB-GR</b> | Package of ten RJ45 jack blockout devices and one removal tool. | Green               | 1              | 20             |
| <b>PSL-DCJB-IG</b> | Package of ten RJ45 jack blockout devices and one removal tool. | International Gray  | 1              | 20             |
| <b>PSL-DCJB-OR</b> | Package of ten RJ45 jack blockout devices and one removal tool. | Orange              | 1              | 20             |

\*Available in bulk packages of 100 devices and five removal tools. To order bulk package add -C to the suffix of part number.



## RJ45 Plug Lock-In Device

- Tamper-resistant design blocks unauthorized removal of cable, IP phone, other networking equipment or critical connection
- Deters unauthorized users from moving or stealing VoIP phones helping to maintain E911 service
- Compact design does not interfere with adjacent jacks, even in high-density applications



| Part Number*  | Part Description   | Color               | Std. Pkg. Qty. | Std. Ctn. Qty. |
|---------------|--|---------------------|----------------|----------------|
| PSL-DCPLX     | Package of ten RJ45 plug lock-in devices and one installation/removal tool.          | Red                 | 1              | 20             |
| PSL-DCPLX-BL  | Package of ten RJ45 plug lock-in devices and one installation/removal tool.          | Black               | 1              | 20             |
| PSL-DCPLX-BU  | Package of ten RJ45 plug lock-in devices and one installation/removal tool.          | Blue                | 1              | 20             |
| PSL-DCPLX-YL  | Package of ten RJ45 plug lock-in devices and one installation/removal tool.          | Yellow              | 1              | 20             |
| PSL-DCPLX-IW  | Package of ten RJ45 plug lock-in devices and one installation/removal tool.          | International White | 1              | 20             |
| PSL-DCPLX-GR  | Package of ten RJ45 plug lock-in devices and one installation/removal tool.          | Green               | 1              | 20             |
| PSL-DCPLX-OR  | Package of ten RJ45 plug lock-in devices and one installation/removal tool.          | Orange              | 1              | 20             |
| PSL-DCPLX-IG  | Package of ten RJ45 plug lock-in devices and one installation/removal tool.          | International Gray  | 1              | 20             |
| PSL-DCPLRX    | Package of ten recessed RJ45 plug lock-in devices and one installation/removal tool. | Red                 | 1              | 20             |
| PSL-DCPLRX-BL | Package of ten recessed RJ45 plug lock-in devices and one installation/removal tool. | Black               | 1              | 20             |
| PSL-DCPLRX-BU | Package of ten recessed RJ45 plug lock-in devices and one installation/removal tool. | Blue                | 1              | 20             |
| PSL-DCPLRX-YL | Package of ten recessed RJ45 plug lock-in devices and one installation/removal tool. | Yellow              | 1              | 20             |
| PSL-DCPLRX-IW | Package of ten recessed RJ45 plug lock-in devices and one installation/removal tool. | International White | 1              | 20             |
| PSL-DCPLRX-GR | Package of ten recessed RJ45 plug lock-in devices and one installation/removal tool. | Green               | 1              | 20             |
| PSL-DCPLRX-OR | Package of ten recessed RJ45 plug lock-in devices and one installation/removal tool. | Orange              | 1              | 20             |
| PSL-DCPLRX-IG | Package of ten recessed RJ45 plug lock-in devices and one installation/removal tool. | International Gray  | 1              | 20             |

\*Available in bulk packages of 100 devices and five installation/removal tools. To order bulk package add -C to the suffix of part number.

A.  
System  
Overview

B1.  
Cable Ties

B2.  
Cable  
Accessories

B3.  
Stainless  
Steel Ties

C1.  
Wiring  
Duct

C2.  
Surface  
Raceway

C3.  
Abrasion  
Protection

C4.  
Cable  
Management

D1.  
Terminals

D2.  
Power  
Connectors

D3.  
Grounding  
Connectors

E1.  
Labeling  
Systems

E2.  
Labels

E3.  
Pre-Printed  
& Write-On  
Markers

E4.  
Permanent  
Identification

E5.  
Lockout/  
Tagout  
& Safety  
Solutions

F.  
Index

A. System Overview

## LC Duplex Adapter Blockout Device

B1. Cable Ties

- TIA/EIA-604 FOCIS-10 compliant device fits all LC duplex adapters for a variety of applications and installations
- Tamper-resistant design blocks unauthorized access to LC duplex ports to reduce the risk of damage, saving time and money associated with downtime, repair and hardware replacement

- Also functions as dust plug to mechanically protect the LC adapter optics and render it "eye-safe"
- Removal tool allows only authorized personnel to release the device, ensuring safety and security of your network infrastructure
- Available in multiple colors to match or contrast adapter colors for easy identification of blocked out adapters

B2. Cable Accessories

- Compact, low profile design allows installation or removal without disturbing adjacent ports or installed patch cords in high-density applications

B3. Stainless Steel Ties

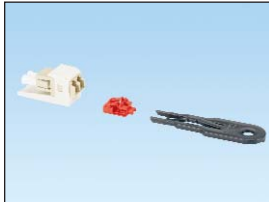

C1. Wiring Duct

C2. Surface Raceway



C3. Abrasion Protection

C4. Cable Management

| Part Number*       | Part Description  | Color          | Std. Pkg. Qty. | Std. Ctn. Qty. |
|--------------------|---|----------------|----------------|----------------|
| <b>PSL-LCAB</b>    | Package of ten LC duplex adapter blockout devices and one removal tool. | Red            | 1              | 20             |
| <b>PSL-LCAB-AQ</b> | Package of ten LC duplex adapter blockout devices and one removal tool. | Aqua           | 1              | 20             |
| <b>PSL-LCAB-BL</b> | Package of ten LC duplex adapter blockout devices and one removal tool. | Black          | 1              | 20             |
| <b>PSL-LCAB-BU</b> | Package of ten LC duplex adapter blockout devices and one removal tool. | Blue           | 1              | 20             |
| <b>PSL-LCAB-EI</b> | Package of ten LC duplex adapter blockout devices and one removal tool. | Electric Ivory | 1              | 20             |

\*Also available in bulk packages of 100 devices and five removal tools. To order bulk package, add -C to the end of the part number.

D1. Terminals

## SC Adapter Blockout Device

D2. Power Connectors

- TIA/EIA-604 FOCIS-3 compliant device fits all SC adapters for a variety of applications and installations
- Tamper-resistant design blocks unauthorized access to SC switch and HBA/NIC ports, switch uplinks and user outlets, saving time and money associated with data security breaches, network downtime, repairs and hardware replacement
- Compact, low profile design allows installation or removal without disturbing adjacent ports or installed patch cords in high-density applications

- Also functions as dust plug to mechanically protect the SC adapters/receptacle optics and renders it "eye-safe" to prevent exposure to laser radiation and contamination on dust sensitive transceivers
- Removal tool allows only authorized personnel to release the device, ensuring safety and security of your network infrastructure
- Available in multiple colors for visual identification or aesthetics

D3. Grounding Connectors

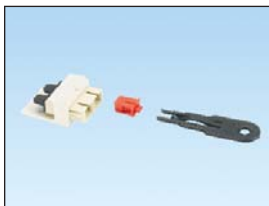

E1. Labeling Systems

E2. Labels

E3. Pre-Printed & Write-On Markers

E4. Permanent Identification

E5. Lockout/Tagout & Safety Solutions

F. Index

| Part Number*       | Part Description   | Color          | Std. Pkg. Qty. | Std. Ctn. Qty. |
|--------------------|--|----------------|----------------|----------------|
| <b>PSL-SCBD</b>    | Package of ten SC adapter blockout devices and one removal tool. | Red            | 1              | 20             |
| <b>PSL-SCBD-AG</b> | Package of ten SC adapter blockout devices and one removal tool. | Green          | 1              | 20             |
| <b>PSL-SCBD-AQ</b> | Package of ten SC adapter blockout devices and one removal tool. | Aqua           | 1              | 20             |
| <b>PSL-SCBD-BL</b> | Package of ten SC adapter blockout devices and one removal tool. | Black          | 1              | 20             |
| <b>PSL-SCBD-BU</b> | Package of ten SC adapter blockout devices and one removal tool. | Blue           | 1              | 20             |
| <b>PSL-SCBD-EI</b> | Package of ten SC adapter blockout devices and one removal tool. | Electric Ivory | 1              | 20             |

\*Also available in bulk packages of 100 devices and five removal tools. To order bulk package, add -C to the end of the part number.

## SAFETY AND FACILITY IDENTIFICATION

Panduit offers a full line of safety and facility identification products to ensure employee safety with an effectively identified workplace.



- Safety signs and labels offered in a variety of materials, colors, sizes and legends
- Voltage markers in adhesive and snap-on style
- Utility tapes in a variety of materials, colors, sizes and legends
- Letters and numbers in a variety of materials and sizes
- Tags in a variety of materials, colors, sizes and legends

Panduit safety and facility identification products are designed to assist you with creating a safe, compliant, and efficient workplace.

A.  
System  
Overview

B1.  
Cable Ties

B2.  
Cable  
Accessories

B3.  
Stainless  
Steel Ties

C1.  
Wiring  
Duct

C2.  
Surface  
Raceway

C3.  
Abrasion  
Protection

C4.  
Cable  
Management

D1.  
Terminals

D2.  
Power  
Connectors

D3.  
Grounding  
Connectors

E1.  
Labeling  
Systems

E2.  
Labels

E3.  
Pre-Printed  
& Write-On  
Markers

E4.  
Permanent  
Identification

E5.  
Lockout/  
Tagout/  
& Safety  
Solutions

F.  
Index

A. System Overview

## Electrical Hazard Safety Signs

B1. Cable Ties



B2. Cable Accessories

B3. Stainless Steel Ties

### Material Chart

| Material                 | Print Method | Temperature Range                | Features  |
|--------------------------|--------------|----------------------------------|---|
| Polyester (PPS)          | Pre-Printed  | -40°F to 275°F (-40°C to 135°C)  | Indoor/outdoor rated; laminated label material protects legend from abrasion and chemicals; resistant to UV light, chemical atmosphere, and abrasion; excellent life and adhesion properties. |
| Rigid Polyethylene (PRS) |              | -105°F to 250°F (-76°C to 121°C) | Indoor/outdoor rated; high quality, rugged material resistant to abrasion; use where adhesives will not work.   |
| Vinyl (PVS)              |              | -40°F to 200°F (-40°C to 93°C)   | Indoor rated; economical general purpose material; excellent adhesion properties when applied to a clean, dry surface.  |

C1. Wiring Duct

### Size Reference Chart

| Part Number | Width |        | Height |        | Signs Per Card |
|-------------|-------|--------|--------|--------|----------------|
|             | In.   | mm     | In.    | mm     |                |
| *0109*      | 9.00  | 228.60 | 1.50   | 38.10  | 1              |
| *0204*      | 4.50  | 114.30 | 2.25   | 57.15  | 2              |
| *0305*      | 5.00  | 127.00 | 3.50   | 88.90  | 1              |
| *0507*      | 7.00  | 177.80 | 5.00   | 127.00 | 1              |
| *0509*      | 9.00  | 228.60 | 5.00   | 127.00 | 1              |
| *0514*      | 14.00 | 355.60 | 5.00   | 127.00 | 1              |
| *0710*      | 10.00 | 254.00 | 7.00   | 177.80 | 1              |
| *1007*      | 10.00 | 254.00 | 7.00   | 177.80 | 1              |
| *1014*      | 14.00 | 355.60 | 10.00  | 254.00 | 1              |
| *1420*      | 20.00 | 508.00 | 14.00  | 355.60 | 1              |

\*Denotes the part numbers' prefix and suffix.

C2. Surface Raceway

C3. Abrasion Protection

C4. Cable Management

D1. Terminals

D2. Power Connectors

D3. Grounding Connectors

E1. Labeling Systems

E2. Labels

E3. Pre-Printed & Write-On Markers

E4. Permanent Identification

E5. Lockout/Tagout & Safety Solutions

F. Index

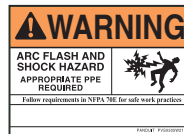

PVS0305W2102Y



PVS0305W2101Y^  
PVS0507W2101Y^

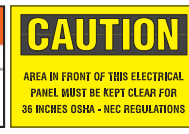

PPS0710C141



PPS0710D28^



PPS0710D66



PRS0710D68



PPS0710D70  
PRS1014D70



PRS1014D71



PPS0710D101



PPS0710D72  
PRS0710D72  
PRS1014D72  
PVS0109D72Y  
PVS0204D72Y  
PVS0710D72Y



PPS0305D73  
PPS0710D73  
PPS1014D73  
PRS1014D73



PPS0305D75  
PPS0710D75  
PRS1420D75



PPS0710D77



PVS0204D100Y

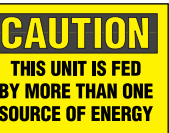

PPS0305C174  
PVS0305C174Y  
PVS0505C174Y



PPS1007D72SE



PPS0710D24



PPS0514B363



PPS0710B364  
PRS0710B364  
PRS1014B364  
PVS0509B364Y  
PVS0710B364Y



PRS1014D79



PRS0910D453



PPS0710N203

^Can be clearly identified with Panduit permanent marking pens.

## Short Circuit Warning Signs

- Aids in compliance with UL 508A requirement

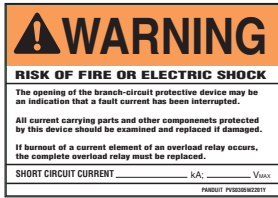

PPS0305W2201Y  
PPS0507W2201Y

### Material Chart

| Material        | Print Method | Temperature Range               | Features   |
|-----------------|--------------|---------------------------------|--|
| Polyester (PPS) | Pre-Printed  | -40°F to 275°F (-40°C to 135°C) | Indoor/outdoor rated; laminated label material protects legend from abrasion and chemicals; resistant to resistant to UV light, chemical atmosphere, and abrasion; excellent life and adhesion properties. |

### Size Reference Chart

| Part Number | Width |        | Height |        | Signs Per Card |
|-------------|-------|--------|--------|--------|----------------|
|             | In.   | mm     | In.    | mm     |                |
| *0305*      | 5.00  | 127.00 | 3.00   | 76.20  | 5              |
| *0507*      | 7.00  | 177.80 | 5.00   | 127.00 | 5              |
| *0710*      | 10.00 | 254.00 | 7.00   | 177.80 | 1              |
| *1014*      | 14.00 | 355.60 | 10.00  | 254.00 | 1              |
| *1209*      | 9.00  | 228.60 | 12.00  | 304.80 | 1              |

\*Denotes the part numbers' prefix and suffix.

## Photoluminescent Safety Signs

- Used to mark egress routes, fire alarms, and fire equipment that is clearly visible for up to ten hours after power is lost
- Absorbs energy from ambient light and releases this energy in the form of a glow when power is lost
- Panduit Photoluminescent Signs meet or exceed the following safety standard specification for photoluminescent safety markings including: ASTM E 2072-00, ASTM E 2073-00, ASTM E 2030-99, DIN67510-1, IMO Resolution A.752.18, ISO/CD 15370, DIN 67510, UL 924, ASTM 162, ASTM 648, ASTM 662, MIL-L-3891 B, NFPA 101 Life Safety Code, OSHA 1910.37



PPS0710G001  
PPS1014G002



PPS0710G020



PPS1209G010



PPS1209G011



PPS1209G012

## Electrical Symbols on Cards

### Material Chart

| Material    | Print Method | Temperature Range              | Features   |
|-------------|--------------|--------------------------------|--|
| Vinyl Cloth | Pre-Printed  | -50°F to 170°F (-46°C to 77°C) | Indoor/outdoor rated; conformable material with repositionable adhesive allows label to be removed and reused or used in temporary applications; provides durability, high temperature resistance, and dimensional stability for rough or textured surfaces. |

| Part Number | Symbol | Description   | Marker Size |               | Markers Per Card | Std. Pkg. Card(s) | Std. Ctn. Card(s) |
|-------------|--------|---|-------------|---------------|------------------|-------------------|-------------------|
|             |        |   | In.         | mm            |                  |                   |                   |
| PESC-H-AT   |        | WARNING OF DANGEROUS ELECTRICAL VOLTAGE                 | 0.51 x 0.51 | 13.00 x 13.00 | 68               | 10                | 100               |
| PESC-J-AT   |        |   | 0.75 x 0.75 | 19.00 x 19.00 | 36               | 10                | 100               |
| PESC-H-E    |        | EARTH (GROUND)  | 0.51 x 0.51 | 13.00 x 13.00 | 68               | 10                | 200               |
| PESC-J-E    |        |   | 0.75 x 0.75 | 19.00 x 19.00 | 36               | 10                | 100               |
| PESC-H-EC   |        | SAFETY FUNCTION   | 0.51 x 0.51 | 13.00 x 13.00 | 68               | 10                | 200               |
| PESC-J-EC   |        |   | 0.75 x 0.75 | 19.00 x 19.00 | 36               | 10                | 100               |
| PESC-H-HT   |        | STATIC SENSITIVE DEVICE - HANDLING PRECAUTIONS REQUIRED | 0.51 x 0.51 | 13.00 x 13.00 | 68               | 10                | 100               |
| PESC-J-HT   |        |   | 0.75 x 0.75 | 19.00 x 19.00 | 36               | 10                | 100               |
| PESC-H-PE   |        | PROTECTIVE CONDUCTOR                                    | 0.51 x 0.51 | 13.00 x 13.00 | 68               | 10                | 100               |
| PESC-J-PE   |        |   | 0.75 x 0.75 | 19.00 x 19.00 | 36               | 10                | 100               |

A. System Overview

## Conductor Identification Labels











B1. Cable Ties

### Material Chart

| Material  | Print Method | Temperature Range                  | Features   |
|-----------|--------------|------------------------------------|--|
| Polyester | Pre-Printed  | -40°F to 250°F<br>(-40°C to 121°C) | Indoor/outdoor rated; laminated label material protects legend from abrasion and chemicals; resistant to UV light, chemical atmosphere, and abrasion; excellent life and adhesion properties |

B2. Cable Accessories

B3. Stainless Steel Ties

| Part Number | Symbol  | Legend                    | Marker Diameter |       | Labels Per Sheet | Std. Pkg. Sheet(s) | Std. Ctn. Sheet(s) |
|-------------|---|---------------------------|-----------------|-------|------------------|--------------------|--------------------|
|             |   |                           | In.             | mm    |                  |                    |                    |
| PESS-A-CE   |    | CE SYMBOL                 | 0.49            | 12.50 | 20               | 10                 | 100                |
| PESS-B-CE   |   |                           | 0.63            | 16.00 | 20               | 10                 | 100                |
| PESS-C-CE   |   |                           | 0.79            | 20.00 | 10               | 10                 | 100                |
| PESS-D-CE   |   |                           | 0.98            | 25.00 | 10               | 10                 | 100                |
| PESS-E-CE   |   |                           | 1.24            | 31.50 | 10               | 10                 | 100                |
| PESS-A-ES   |    | EARTH (GROUND)            | 0.49            | 12.50 | 20               | 10                 | 100                |
| PESS-B-ES   |   |                           | 0.63            | 16.00 | 20               | 10                 | 100                |
| PESS-C-ES   |   |                           | 0.79            | 20.00 | 10               | 10                 | 100                |
| PESS-D-ES   |   |                           | 0.98            | 25.00 | 10               | 10                 | 100                |
| PESS-E-ES   |   |                           | 1.24            | 31.50 | 10               | 10                 | 100                |
| PESS-A-L1   |   | OUTER CONDUCTOR – L1      | 0.49            | 12.50 | 20               | 10                 | 100                |
| PESS-B-L1   |   |                           | 0.63            | 16.00 | 20               | 10                 | 100                |
| PESS-C-L1   |   |                           | 0.79            | 20.00 | 10               | 10                 | 100                |
| PESS-D-L1   |   |                           | 0.98            | 25.00 | 10               | 10                 | 100                |
| PESS-E-L1   |   |                           | 1.24            | 31.50 | 10               | 10                 | 100                |
| PESS-A-L2   |  | OUTER CONDUCTOR 2 – L2    | 0.49            | 12.50 | 20               | 10                 | 100                |
| PESS-B-L2   |   |                           | 0.63            | 16.00 | 20               | 10                 | 100                |
| PESS-C-L2   |   |                           | 0.79            | 20.00 | 10               | 10                 | 100                |
| PESS-D-L2   |   |                           | 0.98            | 25.00 | 10               | 10                 | 100                |
| PESS-E-L2   |   |                           | 1.24            | 31.50 | 10               | 10                 | 100                |
| PESS-A-L3   |  | OUTER CONDUCTOR 3 – L3    | 0.49            | 12.50 | 20               | 10                 | 100                |
| PESS-B-L3   |   |                           | 0.63            | 16.00 | 20               | 10                 | 100                |
| PESS-C-L3   |   |                           | 0.79            | 20.00 | 10               | 10                 | 100                |
| PESS-D-L3   |   |                           | 0.98            | 25.00 | 10               | 10                 | 100                |
| PESS-E-L3   |   |                           | 1.24            | 31.50 | 10               | 10                 | 100                |
| PESS-A-LF   |  | LEAD FREE SYMBOL          | 0.49            | 12.50 | 20               | 10                 | 100                |
| PESS-A-N    |  | NEUTRAL CONDUCTOR – N     | 0.49            | 12.50 | 20               | 10                 | 100                |
| PESS-B-N    |   |                           | 0.63            | 16.00 | 20               | 10                 | 100                |
| PESS-C-N    |   |                           | 0.79            | 20.00 | 10               | 10                 | 100                |
| PESS-D-N    |   |                           | 0.98            | 25.00 | 10               | 10                 | 100                |
| PESS-A-PE   |  | PROTECTIVE CONDUCTOR – PE | 0.49            | 12.50 | 20               | 10                 | 100                |
| PESS-A-ROHS |  | RoHS WHEELED BIN SYMBOL   | 0.49            | 12.50 | 20               | 10                 | 100                |
| PESS-A-SS   |  | SAFETY FUNCTION           | 0.49            | 12.50 | 20               | 10                 | 100                |
| PESS-B-SS   |   |                           | 0.63            | 16.00 | 20               | 10                 | 100                |
| PESS-C-SS   |   |                           | 0.79            | 20.00 | 10               | 10                 | 100                |
| PESS-D-SS   |   |                           | 0.98            | 25.00 | 10               | 10                 | 100                |

C1. Wiring Duct

C2. Surface Raceway

C3. Abrasion Protection

C4. Cable Management

D1. Terminals

D2. Power Connectors

D3. Grounding Connectors

E1. Labeling Systems

E2. Labels

E3. Pre-Printed & Write-On Markers

E4. Permanent Identification

E5. Lockout/Tagout & Safety Solutions

F. Index

Order number of cards required.



## ISO Warning Symbols

### Material Chart

| Material                                 | Print Method | Temperature Range              | Features  |
|--|--------------|--------------------------------|---|
| Paper (WL1, WL3)                         | Pre-Printed  | -65°F to 200°F (-54°C to 80°C) | Indoor rated; general purpose and material; excellent adhesion properties when applied to a clean, dry surface.   |
| Polyester (WL25)                         |              | -40°F to 250°F (-54°C to 93°C) | Indoor/outdoor rated; laminated label material protects legend from abrasion and chemicals; resistant to UV light, chemical atmosphere, and abrasion; excellent life and adhesion properties. |
| Vinyl (PESW, WL32Y, WL33Y, WL35Y, WL36Y) |              | -40°F to 176°F (-40°C to 80°C) | Indoor/outdoor rated; laminated label material protects legend from abrasion and chemicals; resistant to UV light, chemical atmosphere, and abrasion; excellent life and adhesion properties. |

| Part Number | Symbol | Description | Triangle Width |    | Markers Per Card/Pkg | Std. Pkg. Card(s) | Std. Ctn. Card(s) |
|-------------|--------|-------------|----------------|----|----------------------|-------------------|-------------------|
|             |        |             | In.            | mm |                      |                   |                   |

### Cards

|            |  |   |      |       |    |    |     |
|------------|--|---|------|-------|----|----|-----|
| PESW-A-1Y  |  | CAUTION - RISK OF ELECTRIC SHOCK          | 0.50 | 13.0  | 10 | 10 | 200 |
| PESW-B-1Y  |  |   | 1.00 | 25.4  | 10 | 10 | 200 |
| PESW-C-1Y  |  |   | 1.97 | 50.0  | 10 | 10 | 200 |
| PESW-D-1Y  |  |   | 3.90 | 99.1  | 3  | 10 | 200 |
| PESW-E-1Y  |  |   | 7.90 | 200.7 | 1  | 10 | 200 |
| PESW-A-6Y  |  | CAUTION - RISK OF IONIZING RADIATION      | 0.50 | 13.0  | 10 | 10 | 100 |
| PESW-B-6Y  |  |   | 1.00 | 25.4  | 10 | 10 | 100 |
| PESW-C-6Y  |  |   | 1.97 | 50.0  | 10 | 10 | 100 |
| PESW-D-6Y  |  |   | 3.90 | 99.1  | 3  | 10 | 100 |
| PESW-E-6Y  |  |   | 7.90 | 200.7 | 1  | 10 | 100 |
| PESW-A-8Y  |  | CAUTION - LASER BEAM                      | 0.50 | 13.0  | 10 | 10 | 200 |
| PESW-B-8Y  |  |   | 1.00 | 25.4  | 10 | 10 | 200 |
| PESW-C-8Y  |  |   | 1.97 | 50.0  | 10 | 10 | 100 |
| PESW-D-8Y  |  |   | 3.90 | 99.1  | 3  | 10 | 100 |
| PESW-E-8Y  |  |   | 7.90 | 200.7 | 1  | 10 | 100 |
| PESW-A-9Y  |  | CAUTION - GENERAL WARNING, RISK OF DANGER | 0.50 | 13.0  | 10 | 10 | 200 |
| PESW-B-9Y  |  |   | 1.00 | 25.4  | 10 | 10 | 200 |
| PESW-C-9Y  |  |   | 1.97 | 50.0  | 10 | 10 | 100 |
| PESW-D-9Y  |  |   | 3.90 | 99.1  | 3  | 10 | 100 |
| PESW-E-9Y  |  |   | 7.90 | 200.7 | 1  | 10 | 100 |
| PESW-A-11Y |  | WARNING OF STATIC SENSITIVE DEVICE        | 0.50 | 13.0  | 10 | 10 | 100 |
| PESW-B-11Y |  |   | 1.00 | 25.4  | 10 | 10 | 100 |
| PESW-C-11Y |  |   | 1.97 | 50.0  | 10 | 10 | 100 |
| PESW-D-11Y |  |   | 3.90 | 99.1  | 3  | 10 | 100 |
| PESW-E-11Y |  |   | 7.90 | 200.7 | 1  | 10 | 100 |

### Rolls

|       |  |                               |      |        |     |   |    |
|-------|--|-------------------------------|------|--------|-----|---|----|
| WL1   |  | STATIC AWARENESS WARNING      | 2.00 | 50.8   | 500 | 1 | 10 |
| WL3   |  |                               | 2.00 | 50.8   | 500 | 1 | 10 |
| WL32Y |  | RISK OF ELECTRIC SHOCK symbol | 1.50 | 38.10  | 50  | 1 | 10 |
| WL33Y |  |                               | 4.50 | 114.30 | 50  | 1 | 10 |
| WL35Y |  | CAUTION - HOT SURFACE WARNING | 2.00 | 50.80  | 50  | 1 | 10 |
| WL36Y |  | WARNING - HOT SURFACE WARNING | 2.00 | 50.80  | 50  | 1 | 10 |

A. System Overview

## Electrical Labels in Dispenser

B1. Cable Ties



















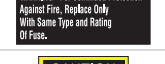

B2. Cable Accessories

### Material Chart

| Material  | Print Method | Temperature Range              | Features  |
|-----------|--------------|--------------------------------|---|
| Polyester | Pre-Printed  | -40°F to 250°F (-40° to 121°C) | Indoor/outdoor rated; laminated label material protects legend from abrasion and chemicals; resistant to UV light chemical atmosphere and abrasion; excellent life and adhesion properties. |

B3. Stainless Steel Ties

| Part Number         | Symbol  | Description                            | Width |       | Height |       | Labels Per Pkg. | Std. Pkg. Dispenser(s) | Std. Ctn. Dispenser(s) |  |
|---------------------|---|--|-------|-------|--------|-------|-----------------|------------------------|------------------------|--|
|                     |   |  | In.   | mm    | In.    | mm    |                 |                        |                        |  |
| <b>Dispensers</b>   |   |  |       |       |        |       |                 |                        |                        |  |
| PLD-12 <sup>^</sup> |    | CIRCUIT NO., LOCATION                  | 1.50  | 38.10 | 1.00   | 25.40 | 200             | 1                      | 10                     |  |
| PLD-30 <sup>^</sup> |    | CAUTION                                | 1.50  | 38.10 | 1.00   | 25.40 | 200             | 1                      | 10                     |  |
| PLD-36              |    | CAUTION 120 V                          | 1.50  | 38.10 | 1.00   | 25.40 | 200             | 1                      | 10                     |  |
| PLD-37              |   | CAUTION 220 V                          | 1.50  | 38.10 | 1.00   | 25.40 | 200             | 1                      | 10                     |  |
| PLD-38              |    | CAUTION 240 V                          | 1.50  | 38.10 | 1.00   | 25.40 | 200             | 1                      | 10                     |  |
| PLD-43 <sup>^</sup> |   | DANGER HIGH VOLTAGE                    | 1.50  | 38.10 | 1.00   | 25.40 | 200             | 1                      | 10                     |  |
| PLD-45              |    | CAUTION 230 V                          | 1.50  | 38.10 | 1.00   | 25.40 | 200             | 1                      | 10                     |  |
| PLD-46              |   | CAUTION 277 V                          | 1.50  | 38.10 | 1.00   | 25.40 | 200             | 1                      | 10                     |  |
| PLD-47              |   | CAUTION 277/480 V                      | 1.50  | 38.10 | 1.00   | 25.40 | 200             | 1                      | 10                     |  |
| PLD-52              |   | ATTENTION SYMBOL (ISO 3864)            | 1.50  | 38.10 | 1.00   | 25.40 | 200             | 1                      | 10                     |  |
| PLD-56              |  | HIGH VOLTAGE SYMBOL (ISO 3864)         | 1.50  | 38.10 | 1.00   | 25.40 | 200             | 1                      | 10                     |  |
| PLD-57              |  | GROUND SYMBOL (ISO 3864)               | .75   | 19.10 | .75    | 19.10 | 300             | 1                      | 10                     |  |
| PLD-58              |  | STATIC AWARENESS WARNING               | 1.50  | 38.10 | 1.00   | 25.40 | 200             | 1                      | 10                     |  |
| PLD-60              |  | STATIC AWARENESS WARNING               | 3.00  | 76.20 | 1.00   | 25.40 | 100             | 1                      | 10                     |  |
| PLD-67              |  | DANGER HIGH VOLTAGE                    | 1.50  | 38.10 | 1.00   | 25.40 | 200             | 1                      | 10                     |  |
| PLD-68 <sup>^</sup> |  | LOCKOUT BY _____<br>DATE _____         | 1.50  | 38.10 | 1.00   | 25.40 | 200             | 1                      | 10                     |  |
| PLD-71              |  | WARNING - FOR CONTINUED PROTECTION ... | 2.00  | 50.80 | 1.00   | 25.40 | 150             | 1                      | 10                     |  |
| PLD-72              |  | CAUTION LOCK OUT FOR SAFETY BEFORE ... | 1.50  | 38.10 | 1.00   | 25.40 | 200             | 1                      | 10                     |  |
| PLD-74              |  | CAUTION HAZARD OF ELECTRIC SHOCK ...   | 1.50  | 38.10 | 1.00   | 25.40 | 200             | 1                      | 10                     |  |
| PLD-80              |  | INTRINSICALLY SAFE WIRING              | 1.00  | 25.40 | 1.50   | 38.10 | 200             | 1                      | 10                     |  |
| PLD-81              |  | SERVICE DISCONNECT                     | 1.50  | 38.10 | 1.00   | 25.40 | 200             | 1                      | 10                     |  |
| PLD-91              |  | CAUTION 480 V                          | 1.50  | 38.10 | 1.00   | 25.40 | 200             | 1                      | 10                     |  |

C1. Wiring Duct

C2. Surface Raceway

C3. Abrasion Protection

C4. Cable Management

D1. Terminals

D2. Power Connectors

D3. Grounding Connectors

E1. Labeling Systems

E2. Labels

E3. Pre-Printed & Write-On Markers

E4. Permanent Identification

E5. Lockout/Tagout & Safety Solutions

F. Index





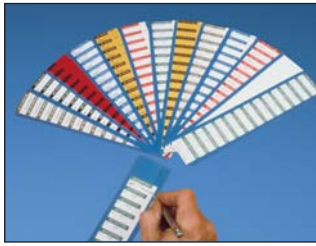

Order number of dispensers required in multiples of Std. Pkg.  
<sup>^</sup>Can be clearly identified with Panduit permanent marking pens.

## Write-On Labels on Cards



### Material Chart

| Material    | Print Method | Temperature Range                 | Features   |
|-------------|--------------|-----------------------------------|--|
| Vinyl Cloth | Pre-Printed  | -50°F to 170°F<br>(-46°C to 77°C) | Indoor/outdoor rated; conformable material with repositionable adhesive allows label to be removed and reused or used in temporary applications; provides durability, high temperature resistance, and dimensional stability for rough or textured surfaces. |

| Part Number | Symbol  | Description | Width |       | Height |       | Markers Per Card | Std. Pkg. Card(s) | Std. Ctn. Card(s) |
|-------------|---|-------------|-------|-------|--------|-------|------------------|-------------------|-------------------|
|             |   |             | In.   | mm    | In.    | mm    |                  |                   |                   |
| PCWL-BL     |    | BLANK       |       |       |        |       |                  | 25                | 100               |
| PCWL-ACC    |    | ACCEPTED    |       |       |        |       |                  | 25                | 100               |
| PCWL-CAL    |    | CALIBRATION |       |       |        |       |                  | 25                | 100               |
| PCWL-CALD   |   | CALIBRATED  | 1.50  | 38.10 | 0.63   | 15.90 | 14               | 25                | 100               |
| PCWL-ICAL   |  | CALIBRATION |       |       |        |       |                  | 25                | 100               |
| PCWL-REJ    |  | REJECTED    |       |       |        |       |                  | 25                | 100               |

Order number of cards required.  
Can be clearly identified with Panduit permanent marking pens.

A.  
System  
Overview

B1.  
Cable Ties

B2.  
Cable  
Accessories

B3.  
Stainless  
Steel Ties

C1.  
Wiring  
Duct

C2.  
Surface  
Raceway

C3.  
Abrasion  
Protection

C4.  
Cable  
Management

D1.  
Terminals

D2.  
Power  
Connectors

D3.  
Grounding  
Connectors

E1.  
Labeling  
Systems

E2.  
Labels

E3.  
Pre-Printed  
& Write-On  
Markers

E4.  
Permanent  
Identification

E5.  
Lockout/  
Tagout  
& Safety  
Solutions

F.  
Index

A. System Overview

## Write-On Quality Labels in Dispenser

B1. Cable Ties

B2. Cable Accessories

B3. Stainless Steel Ties



### Material Chart

| Material  | Print Method | Temperature Range              | Features  |
|-----------|--------------|--------------------------------|---|
| Polyester | Pre-Printed  | -40°F to 250°F (-40° to 121°C) | Indoor/outdoor rated; laminated label material protects legend from abrasion and chemicals; resistant to UV light, chemical atmosphere, and abrasion; excellent life and adhesion properties. |

C1. Wiring Duct

C2. Surface Raceway

C3. Abrasion Protection

C4. Cable Management

D1. Terminals

D2. Power Connectors

D3. Grounding Connectors

E1. Labeling Systems

E2. Labels

E3. Pre-Printed & Write-On Markers

E4. Permanent Identification

E5. Lockout/Tagout & Safety Solutions

F. Index



| Part Number^ | Symbol | Legend                     | Width |      | Height |      | Labels Per Dispenser | Std. Pkg. Dispenser(s) | Std. Ctn. Dispenser(s) |
|--------------|--------|----------------------------|-------|------|--------|------|----------------------|------------------------|------------------------|
|              |        |                            | In.   | mm   | In.    | mm   |                      |                        |                        |
| PLD-17       |        | BLANK                      | 1.50  | 38.1 | 1.00   | 25.4 | 200                  | 1                      | 10                     |
| PLD-18       |        | BLANK                      |       |      |        |      |                      |                        |                        |
| PLD-3        |        | CALIBRATION, BY, DATE, DUE |       |      |        |      |                      |                        |                        |
| PLD-4        |        | ACCEPTED, BY, DATE         |       |      |        |      |                      |                        |                        |
| PLD-7        |        | TESTED, DATE, BY           |       |      |        |      |                      |                        |                        |
| PLD-11       |        | DO NOT USE AFTER           |       |      |        |      |                      |                        |                        |
| PLD-22       |        | CALIBRATION, BY, DATE, DUE |       |      |        |      |                      |                        |                        |
| PLD-28       |        | INSPECTED, BY, DATE        |       |      |        |      |                      |                        |                        |
| PLD-29       |        | MAINTENANCE, BY, DATE      |       |      |        |      |                      |                        |                        |
| PLD-62       |        | BLANK                      |       |      |        |      |                      |                        |                        |
| PLD-63       |        | BLANK                      |       |      |        |      |                      |                        |                        |
| PLD-64       |        | BLANK                      |       |      |        |      |                      |                        |                        |
| PLD-77       |        | BLANK                      |       |      |        |      |                      |                        |                        |
| PLD-78       |        | BLANK                      |       |      |        |      |                      |                        |                        |
|              |        |                            |       |      |        |      |                      |                        |                        |

Order number of dispensers required in multiples of Std. Pkg.  
Can be clearly identified with Panduit permanent marking pens.

## Inspection Plates

### Material Chart

| Material           | Print Method | Temperature Range                  | Features  |
|--------------------|--------------|------------------------------------|---|
| Destructible Vinyl | Pre-Printed  | -50°F to 225°F<br>(-46°C to 107°C) | Indoor/outdoor rated; label will destruct upon removal; for permanent and tamper resistant labeling applications. |

| Part Number | Symbol  | Year | Marker Diameter |      | Markers Per Card | Std. Pkg. Card(s) | Std. Ctn. Card(s) |
|-------------|---|------|-----------------|------|------------------|-------------------|-------------------|
|             |   |      | In.             | mm   |                  |                   |                   |
| PEIP-A-12Y  |  | 12   | 0.59            | 15.0 | 10               | 10                | 100               |
| PEIP-A-13Y  |   | 13   | 0.59            | 15.0 | 10               | 10                | 100               |
| PEIP-A-14Y  |   | 14   | 0.59            | 15.0 | 10               | 10                | 100               |
| PEIP-A-15Y  |   | 15   | 0.59            | 15.0 | 10               | 10                | 100               |
| PEIP-D-12Y  |  | 2012 | 1.38            | 35.0 | 5                | 10                | 100               |
| PEIP-D-13Y  |   | 2013 | 1.38            | 35.0 | 5                | 10                | 100               |
| PEIP-D-14Y  |   | 2014 | 1.38            | 35.0 | 5                | 10                | 100               |
| PEIP-D-15Y  |   | 2015 | 1.38            | 35.0 | 5                | 10                | 100               |

## Inspection Arrows

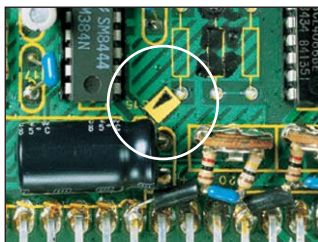

### Material Chart

| Material    | Print Method | Temperature Range                 | Features   |
|-------------|--------------|-----------------------------------|--|
| Vinyl Cloth | Pre-Printed  | -50°F to 170°F<br>(-46°C to 77°C) | Indoor/outdoor rated; conformable material with repositionable adhesive allows label to be removed and reused or used in temporary applications; provides durability, high temperature resistance, and dimensional stability for rough or textured surfaces. |

| Part Number | Symbol  | Width |      | Height |      | Markers Per Card | Std. Pkg. Card(s) | Std. Pkg. Card(s) |
|-------------|---|-------|------|--------|------|------------------|-------------------|-------------------|
|             |   | In.   | mm   | In.    | mm   |                  |                   |                   |
| PARW125-RED |  | 0.13  | 3.00 | 0.19   | 5.00 | 576              | 25                | —                 |
| PARW125-YEL |  | 0.13  | 3.00 | 0.19   | 5.00 | 576              | 25                | 100               |

A.  
System  
Overview

B1.  
Cable  
Ties

B2.  
Cable  
Accessories

B3.  
Stainless  
Steel Ties

C1.  
Wiring  
Duct

C2.  
Surface  
Raceway

C3.  
Abrasion  
Protection

C4.  
Cable  
Management

D1.  
Terminals

D2.  
Power  
Connectors

D3.  
Grounding  
Connectors

E1.  
Labeling  
Systems

E2.  
Labels

E3.  
Pre-Printed  
& Write-On  
Markers

E4.  
Permanent  
Identification

E5.  
Lockout/  
Tagout  
& Safety  
Solutions

F.  
Index

A. System Overview

## Voltage and Fiber Optic Markers

B1. Cable Ties



B2. Cable Accessories

B3. Stainless Steel Ties

C1. Wiring Duct

C2. Surface Raceway

C3. Abrasion Protection

C4. Cable Management

D1. Terminals

D2. Power Connectors

D3. Grounding Connectors

E1. Labeling Systems

E2. Labels

E3. Pre-Printed & Write-On Markers

E4. Permanent Identification

E5. Lockout/Tagout & Safety Solutions

F. Index

| Style    | Width |        | Length |       | Pipe/Conduit O.D. Range |                 | Markers Per Card |
|----------|-------|--------|--------|-------|-------------------------|-----------------|------------------|
|          | In.   | mm     | In.    | mm    | In.                     | mm              |                  |
| <b>A</b> | 9.00  | 228.00 | 2.25   | 57.10 | 3.00 and Over           | 76.20 and Over  | 1                |
| <b>B</b> | 4.50  | 114.30 | 1.13   | 28.60 | 1.25 – 3.00             | 31.70 – 76.20   | 4                |
| <b>C</b> | 2.20  | 57.10  | 0.50   | 12.70 | 1.25 – Under            | 31.70 and Under | 18               |

### Material Chart

| Material  | Print Method | Temperature Range               | Features   |
|-----------|--------------|---------------------------------|--|
| Polyester | Pre-Printed  | -40°F to 275°F (-40°C to 135°C) | Indoor/outdoor rated; pre-coiled material protects legend from abrasion and chemicals; resistant to UV light, chemical atmosphere, and abrasion. |

| Part Number   |               |               | Legend            | Color (Legend/Background) | Std. Pkg. Qty. | Std. Ctn. Qty. |
|---------------|---------------|---------------|-------------------|---------------------------|----------------|----------------|
| Style A       | Style B       | Style C       |                   |                           |                |                |
| PCV-110AY     | PCV-110BY     | PCV-110CY     | 110 Volts         | Black/Orange              | 5              | 50             |
| PCV-115AY     | PCV-115BY     | PCV-115CY     | 115 Volts         |                           | 5              | 50             |
| PCV-120/208AY | PCV-120/208BY | PCV-120/208CY | 120/208 Volts     |                           | 5              | 50             |
| PCV-120AY     | PCV-120BY     | PCV-120CY     | 120 Volts         |                           | 5              | 50             |
| PCV-12470AY   | PCV-12470BY   | PCV-12470CY   | 12470 Volts       |                           | 5              | 50             |
| PCV-13200AY   | PCV-13200BY   | PCV-13200CY   | 13200 Volts       |                           | 5              | 50             |
| PCV-13800AY   | PCV-13800BY   | PCV-13800CY   | 13800 Volts       |                           | 5              | 50             |
| PCV-1PHAY     | PCV-1PHBY     | PCV-1PHCY     | Single Phase      |                           | 5              | 50             |
| PCV-208AY     | PCV-208BY     | PCV-208CY     | 208 Volts         |                           | 5              | 50             |
| PCV-220AY     | PCV-220BY     | PCV-220CY     | 220 Volts         |                           | 5              | 50             |
| PCV-2300AY    | PCV-2300BY    | PCV-2300CY    | 2300 Volts        |                           | 5              | 50             |
| PCV-230AY     | PCV-230BY     | PCV-230CY     | 230 Volts         |                           | 5              | 50             |
| PCV-2400AY    | PCV-2400BY    | PCV-2400CY    | 2400 Volts        |                           | 5              | 50             |
| PCV-240AY     | PCV-240BY     | PCV-240CY     | 240 Volts         |                           | 5              | 50             |
| PCV-277/480AY | PCV-277/480BY | PCV-277/480CY | 277/480 Volts     |                           | 5              | 50             |
| PCV-277AY     | PCV-277BY     | PCV-277CY     | 277 Volts         |                           | 5              | 50             |
| PCV-380AY     | PCV-380BY     | PCV-380CY     | 380 Volts         |                           | 5              | 50             |
| PCV-3PHAY     | PCV-3PHBY     | PCV-3PHCY     | Three Phase       |                           | 5              | 50             |
| PCV-415AY     | PCV-415BY     | PCV-415CY     | 415 Volts         |                           | 5              | 50             |
| PCV-4160AY    | PCV-4160BY    | PCV-4160CY    | 4160 Volts        |                           | 5              | 50             |
| PCV-440AY     | PCV-440BY     | PCV-440CY     | 440 Volts         |                           | 5              | 50             |
| PCV-460AY     | PCV-460BY     | PCV-460CY     | 460 Volts         |                           | 5              | 50             |
| PCV-480AY     | PCV-480BY     | PCV-480CY     | 480 Volts         |                           | 5              | 50             |
| PCV-600AY     | PCV-600BY     | PCV-600CY     | 600 Volts         |                           | 5              | 50             |
| PCV-BLANKAY   | PCV-BLANKBY   | PCV-BLANKCY   | Blank – No Legend |                           | 5              | 50             |
| PCV-ESAY      | PCV-ESBY      | PCV-ESCY      | Emergency Service |                           | 5              | 50             |
| PCV-FAAY      | PCV-FABY      | PCV-FACY      | Fire Alarm        |                           | 5              | 50             |
| PCV-FOAY      | PCV-FOBY      | PCV-FOCY      | Fiber Optic       |                           | 5              | 50             |
| PCV-FOCAY     | PCV-FOCBY     | PCV-FOCCY     | Fiber Optic Cable |                           | 5              | 50             |
| PCV-MAINAY    | PCV-MAINBY    | PCV-MAINCY    | Main              |                           | 5              | 50             |
| PCV-TELEAY    | PCV-TELEBY    | PCV-TELECY    | Telephone         |                           | 5              | 50             |

| Style    | Width |        | Length |        | Pipe/Conduit O.D. Range |                | Markers Per Card |
|----------|-------|--------|--------|--------|-------------------------|----------------|------------------|
|          | In.   | mm     | In.    | mm     | In.                     | mm             |                  |
| <b>M</b> | 14.00 | 355.60 | 23.00  | 584.20 | 2.25 – 6.00             | 57.20 – 152.40 | 1                |
| <b>R</b> | 8.00  | 230.20 | 8.00   | 230.20 | 0.75 – 2.25             | 19.10 – 57.20  | 1                |

| Part Number |           |  | Legend      | Color (Legend/Background) | Std. Pkg. Qty. | Std. Ctn. Qty. |
|-------------|-----------|--|-------------|---------------------------|----------------|----------------|
| Style M     | Style R   |  |             |                           |                |                |
|             | PCV-120RY |  | 120 Volts   | Black/Orange              | 1              | 25             |
|             | PCV-480RY |  | 480 Volts   |                           | 1              | 25             |
| PCV-FOMY    | PCV-FORY  |  | Fiber Optic |                           | 1              | 25             |



## Panduit® Voltage and Safety Marker Books



### Material Chart

| Material | Print Method | Temperature Range              | Features   |
|----------|--------------|--------------------------------|--|
| Vinyl    | Pre-Printed  | -40°F to 200°F (-40°C to 93°C) | Indoor rated; economical general purpose material; excellent adhesion properties when applied to a clean, dry surface. |

| Part Number | Legend | Markers Per Page | Markers Per Book | Std. Qty. Book(s) |
|-------------|--------|------------------|------------------|-------------------|
|-------------|--------|------------------|------------------|-------------------|

### Voltage Markers 1.50" x 3.25" (38.00mm x 82.00mm)

| Part Number   | Legend        | Markers Per Page | Markers Per Book | Std. Qty. Book(s) |
|---------------|---------------|------------------|------------------|-------------------|
| PCVB-110Y     | 110 Volts     | 3                | 30               | 1                 |
| PCVB-220Y     | 220 Volts     |                  |                  |                   |
| PCVB-277Y     | 277 Volts     |                  |                  |                   |
| PCVB-277/480Y | 277/480 Volts |                  |                  |                   |
| PCVB-440Y     | 440 Volts     |                  |                  |                   |
| PCVB-480Y     | 480 Volts     |                  |                  |                   |
| PCVB-4160Y    | 4160 Volts    |                  |                  |                   |

### Safety Markers 1.50" x 3.25" (38.00mm x 82.00mm)

| Part Number | Legend              | Markers Per Page | Markers Per Book | Std. Qty. Book(s) |
|-------------|---------------------|------------------|------------------|-------------------|
| PSSB-13     | Danger High Voltage | 3                | 30               | 1                 |

## Panduit® Hazard Tape



### Material Chart

| Material | Print Method | Temperature Range              | Features   |
|----------|--------------|--------------------------------|--|
| Vinyl    | Pre-Printed  | -20°F to 175°F (-29°C to 79°C) | Indoor rated; color-coded for quick identification; can be used in place of paint; excellent adhesion properties when applied to a clean, dry surface. |

| Part Number  | Part Description                                | Width |       | Length |      | Std. Pkg. Qty. | Std. Ctn. Qty. |
|--------------|---|-------|-------|--------|------|----------------|----------------|
|              |   | In.   | mm    | Ft.    | m    |                |                |
| HT2S-BLK-YEL | Black/yellow stripe, adhesive continuous tape.  | 2.00  | 50.80 | 54.0   | 16.5 | 1              | 12             |
| HT2S-RED-WHT | Red/white striped, adhesive continuous tape.    | 2.00  | 50.80 | 54.0   | 16.5 | 1              | 12             |
| HT3S-BLK-YEL | Black/yellow striped, adhesive continuous tape. | 3.00  | 76.20 | 54.0   | 16.5 | 1              | 10             |
| HT3S-RED-WHT | Red/white striped, adhesive continuous tape.    | 3.00  | 76.20 | 54.0   | 16.5 | 1              | 10             |

## Panduit® Solid Color Adhesive Warning Tape



### Material Chart

| Material | Temperature Range              | Features   |
|----------|--------------------------------|--|
| Vinyl    | -20°F to 175°F (-29°C to 79°C) | Indoor rated; color-coded for quick identification; can be used in place of paint; excellent adhesion properties when applied to a clean, dry surface. |

| Part Number | Color  | Width |       | Length |      | Std. Pkg. Qty. | Std. Ctn. Qty. |
|-------------|--------|-------|-------|--------|------|----------------|----------------|
|             |        | In.   | mm    | Ft.    | m    |                |                |
| HT2-BLU     | Blue   | 2.00  | 50.80 | 180.0  | 55.0 | 1              | 5              |
| HT2-GRN     | Green  | 2.00  | 50.80 | 180.0  | 55.0 | 1              | 5              |
| HT2-ORN     | Orange | 2.00  | 50.80 | 180.0  | 55.0 | 1              | 5              |
| HT2-RED     | Red    | 2.00  | 50.80 | 180.0  | 55.0 | 1              | 5              |
| HT2-WHT     | White  | 2.00  | 50.80 | 180.0  | 55.0 | 1              | 5              |
| HT2-YEL     | Yellow | 2.00  | 50.80 | 180.0  | 55.0 | 1              | 5              |

A. System Overview

## Reflective Tapes

- Reflective tapes can be used for illuminating or highlighting a range of objects
- Increases safety during power outages or other low light conditions
- Custom legends can be printed using a Panduit TDP43MY thermal printer
- Tapes are laminated for improved print quality and durability

B1. Cable Ties

B2. Cable Accessories

B3. Stainless Steel Ties

| Part Number        | Color  | Width |       | Length |      | Std. Pkg. Qty. |
|--------------------|--------|-------|-------|--------|------|----------------|
|                    |        | In.   | mm    | Ft.    | m    |                |
| <b>T100X000RP1</b> | White  | 1.00  | 25.4  | 50.0   | 15.2 | 1              |
| <b>T200X000RP1</b> | White  | 2.00  | 50.8  | 50.0   | 15.2 | 1              |
| <b>T400X000RP1</b> | White  | 4.00  | 101.6 | 50.0   | 15.2 | 1              |
| <b>T100X000RU1</b> | Orange | 1.00  | 25.4  | 50.0   | 15.2 | 1              |
| <b>T200X000RU1</b> | Orange | 2.00  | 50.8  | 50.0   | 15.2 | 1              |
| <b>T400X000RU1</b> | Orange | 4.00  | 101.6 | 50.0   | 15.2 | 1              |
| <b>T100X000RX1</b> | Yellow | 1.00  | 25.4  | 50.0   | 15.2 | 1              |
| <b>T200X000RX1</b> | Yellow | 2.00  | 50.8  | 50.0   | 15.2 | 1              |
| <b>T400X000RX1</b> | Yellow | 4.00  | 101.6 | 50.0   | 15.2 | 1              |
| <b>T400X000RW1</b> | Red    | 4.00  | 101.6 | 50.0   | 15.2 | 1              |
| <b>T400X000RQ1</b> | Blue   | 4.00  | 101.6 | 50.0   | 15.2 | 1              |

C1. Wiring Duct

C2. Surface Raceway

C3. Abrasion Protection

## Photoluminescent Tapes – Thermal Transfer Printable

C4. Cable Management



Normal Lighting

D1. Terminals

D2. Power Connectors

D3. Grounding Connectors

- Used to mark egress routes, fire alarms, and fire equipment that is clearly visible for up to ten hours after power is lost
- Absorb energy from ambient light and releases this energy in the form of a glow when power is lost
- Can be used in the Panduit thermal transfer desktop printers to create direction arrow tape, striped tape, or safety signs on demand
- Panduit Photoluminescent Tapes meet or exceed the following safety standard specification for photoluminescent safety markings including: ASTM E 2072-00, ASTM E 2073-00, ASTM E 2030-99, DIN67510-1, IMO Resolution A.752.18, ISO/CD 15370, DIN 67510, UL 924, ASTM 162, ASTM 648, ASTM 662, MIL-L-3891 B, NFPA 101 Life Safety Code, OSHA 1910.37



Black Light

E1. Labeling Systems

E2. Labels

E3. Pre-Printed & Write-On Markers

E4. Permanent Identification

E5. Lockout/Tagout & Safety Solutions

### Material Chart

| Material                         | Print Method         | Temperature Range               | Features  |
|----------------------------------|----------------------|---------------------------------|---|
| Polyester, Photoluminescent (Y2) | Thermal Transfer (T) | -40°F to 230°F (-40°C to 110°C) | Indoor/outdoor rated; provides durability, high temperature resistance, and dimensional stability; does not stretch or easily tear; After power is lost, material emits glow that is clearly visible for up to ten hours. |

| Part Number        | Part Description                                | Width |       | Length |      | Std. Pkg. Qty. | Std. Ctn. Qty. |
|--------------------|---|-------|-------|--------|------|----------------|----------------|
|                    |   | In.   | mm    | Ft.    | m    |                |                |
| <b>Pre-Printed</b> |   |       |       |        |      |                |                |
| <b>PT2S-ARW</b>    | Photoluminescent, polyester tape, black arrow.  | 2.00  | 50.80 | 30.00  | 9.14 | 1              | 4              |
| <b>PT2S-BLK</b>    | Photoluminescent, polyester tape, black stripe. | 2.00  | 50.80 | 30.00  | 9.14 | 1              | 4              |
| <b>PT2S-RED</b>    | Photoluminescent, polyester tape, red stripe.   | 2.00  | 50.80 | 30.00  | 9.14 | 1              | 4              |

### Blank

|                    |                                   |      |        |       |     |   |   |
|--------------------|-----------------------------------|------|--------|-------|-----|---|---|
| <b>T200X000Y2T</b> | Photoluminescent, polyester tape. | 2.00 | 50.80  | 15.00 | 4.5 | 1 | 4 |
| <b>T400X000Y2T</b> | Photoluminescent, polyester tape. | 4.00 | 101.60 | 15.0  | 4.5 | 1 | 4 |

Order number of rolls required.

Labels roll mounted on 3.00" cores; when using the TDP43MY thermal transfer desktop printer and 3.00" cores, the roll stand (TDP43M-RS) is required.



PT2S-ARW



PT2S-BLK



PT2S-RED

## Underground Hazard Tape



### Material Chart

| Material                             | Print Method | Temperature Range               | Features   |
|--------------------------------------|--------------|---------------------------------|--|
| Polyethylene (HTU, HTB)              | Pre-Printed  | -30°F to 200°F (-34°C to 93°C)  | Indoor/outdoor rated; designed for direct burial; highly visible legend is protected from abrasion and chemicals; resistant to UV light, chemical atmosphere, and abrasion; will not biodegrade.                               |
| Detectible Laminated Aluminum (HTDU) | Pre-Printed  | -30°F to 220°F (-34°C to 104°C) | Indoor/outdoor rated; aluminum embedded material is designed for direct burial; highly visible legend is protected from abrasion and chemicals; resistant to UV light, chemical atmosphere, and abrasion; will not biodegrade. |

| Part Number                          | Legend                                    | Color (Legend/Background) | Height |        | Length  |        | Std. Pkg. Qty. |
|--------------------------------------|---|---------------------------|--------|--------|---------|--------|----------------|
|                                      |   |                           | In.    | mm     | Ft.     | m      |                |
| <b>Laminated Detectable Aluminum</b> |   |                           |        |        |         |        |                |
| HTDU2B-W                             | CAUTION<br>WATER LINE BURIED BELOW        | Black/Blue                | 2.00   | 50.80  | 1000.00 | 305.00 | 1              |
| HTDU2O-FO                            | CAUTION<br>FIBER OPTIC CABLE BURIED BELOW | Black/Orange              |        |        |         |        | 1              |
| HTDU2O-T                             | CAUTION<br>TELEPHONE LINE BURIED BELOW    | Black/Orange              |        |        |         |        | 1              |
| HTDU2R-E                             | CAUTION<br>ELECTRIC LINE BURIED BELOW     | Black/Red                 |        |        |         |        | 1              |
| HTDU3O-FO                            | CAUTION<br>FIBER OPTIC CABLE BURIED BELOW | Black/Orange              | 3.00   | 76.00  | 1000.00 | 305.00 | 1              |
| HTDU3O-T                             | CAUTION<br>TELEPHONE LINE BURIED BELOW    | Black/Orange              |        |        |         |        | 1              |
| HTDU3R-E                             | CAUTION<br>ELECTRIC LINE BURIED BELOW     | Black/Red                 |        |        |         |        | 1              |
| HTDU6O-FO                            | CAUTION<br>FIBER OPTIC CABLE BURIED BELOW | Black/Orange              | 6.00   | 152.00 | 1000.00 | 305.00 | 1              |
| HTDU6O-T                             | CAUTION<br>TELEPHONE LINE BURIED BELOW    | Black/Orange              |        |        |         |        | 1              |
| HTDU6R-E                             | CAUTION<br>ELECTRIC LINE BURIED BELOW     | Black/Red                 |        |        |         |        | 1              |
| <b>Polyethylene</b>                  |   |                           |        |        |         |        |                |
| HTU3G-T-M                            | CAUTION<br>TELEPHONE LINE BURIED BELOW    | Black/Green               | 3.00   | 76.00  | 1000.00 | 305.00 | 1              |
| HTU3O-FO-M                           | CAUTION<br>BURIED FIBER OPTIC CABLE       | Black/Orange              |        |        |         |        | 1              |
| HTU3O-T-M                            | CAUTION<br>TELEPHONE LINE BURIED BELOW    | Black/Orange              |        |        |         |        | 1              |
| HTU3R-E-M                            | CAUTION<br>ELECTRIC LINE BURIED BELOW     | Black/Red                 |        |        |         |        | 1              |
| HTU3Y-E-M                            | CAUTION<br>ELECTRIC LINE BURIED BELOW     | Black/Yellow              | 6.00   | 152.00 | 1000.00 | 305.00 | 1              |
| HTU6R-E                              | CAUTION<br>ELECTRIC LINE BURIED BELOW     | Black/Red                 |        |        |         |        | 1              |
| HTU6O-FO                             | CAUTION<br>BURIED FIBER OPTIC CABLE       | Black/Orange              |        |        |         |        | 1              |
| HTU6O-T                              | CAUTION<br>TELEPHONE LINE BURIED BELOW    | Black/Orange              |        |        |         |        | 1              |
| HTU6O-TV                             | CAUTION<br>CABLE TV LINE BURIED BELOW     | Black/Orange              |        |        |         |        | 1              |
| HTU6Y-E                              | CAUTION<br>ELECTRIC LINE BURIED BELOW     | Black/Yellow              |        |        |         |        | 1              |
| HTU6Y-G                              | CAUTION<br>GAS LINE BURIED BELOW          | Black/Yellow              |        |        |         |        | 1              |

A. System Overview

## Barricade Tapes

B1. Cable Ties



B2. Cable Accessories

B3. Stainless Steel Ties

| Part Number       | Legend               | Color (Legend/Background) | Height |       | Length  |        | Std. Pkg. Qty. |
|-------------------|----------------------|---------------------------|--------|-------|---------|--------|----------------|
|                   |                      |                           | In.    | mm    | Ft.     | m      |                |
| <b>HTB3-C-M</b>   | CAUTION              | Black/Yellow              | 3.00   | 76.20 | 1000.00 | 305.00 | 1              |
| <b>HTB3-DNE-M</b> | CAUTION DO NOT ENTER | Black/Yellow              | 3.00   | 76.00 | 1000.00 | 305.00 | 1              |
| <b>HTB3-HV-M</b>  | CAUTION HIGH VOLTAGE | Black/Yellow              | 3.00   | 76.00 | 1000.00 | 305.00 | 1              |

C1. Wiring Duct

## Vinyl Letters and Numbers

### Material Chart

| Material    | Print Method | Temperature Range              | Features  |
|-------------|--------------|--------------------------------|---|
| Vinyl (PVL) | Pre-Printed  | -50°F to 225°F (-46°C to 107°) | Indoor/outdoor rated; heavy duty material for flat applications and safety and facility identification; resistant to UV light, chemical atmosphere, and abrasion. |

C2. Surface Raceway



C3. Abrasion Protection

C4. Cable Management

D1. Terminals

D2. Power Connectors

D3. Grounding Connectors

E1. Labeling Systems

E2. Labels

E3. Pre-Printed & Write-On Markers

E4. Permanent Identification

E5. Lockout/Tagout & Safety Solutions

F. Index

| Part Number                           | Legend   | Legend Height |       | Height |       | Width |       | Color (Legend/Background) | Markers Per Card | Std. Pkg. Card(s) |
|---------------------------------------|----------|---------------|-------|--------|-------|-------|-------|---------------------------|------------------|-------------------|
|                                       |          | In.           | mm    | In.    | mm    | In.   | mm    |                           |                  |                   |
| <b>PVL100BY-0-Y</b>                   | 0        | 1.00          | 25.40 | 1.50   | 38.10 | 0.88  | 22.35 | Black/Yellow              | 10               | 25                |
| <b>PVL100BY-1-Y thru PVL100BY-9-Y</b> | 1 thru 9 |               |       |        |       |       |       |                           |                  | 25                |
| <b>PVL100BY-A-Y thru PVL100BY-Z-Y</b> | A thru Z |               |       |        |       |       |       |                           |                  | 25                |
| <b>PVL100BY-DSH-Y</b>                 | —        | 2.00          | 50.80 | 2.25   | 57.15 | 0.88  | 22.35 | Black/Yellow              | 10               | 25                |
| <b>PVL200BY-0-Y</b>                   | 0        |               |       |        |       |       |       |                           |                  | 25                |
| <b>PVL200BY-1-Y thru PVL200BY-9-Y</b> | 1 thru 9 |               |       |        |       |       |       |                           |                  | 25                |
| <b>PVL200BY-A-Y thru PVL200BY-Z-Y</b> | A thru Z | 2.00          | 50.80 | 2.25   | 57.15 | 0.88  | 22.35 | Black/Yellow              | 10               | 25                |
| <b>PVL200BY-DSH-Y</b>                 | —        |               |       |        |       |       |       |                           |                  | 25                |

## Vinyl Cloth Letters and Numbers



### Material Chart

| Material                 | Print Method | Temperature Range              | Features  |
|--------------------------|--------------|--------------------------------|---|
| Vinyl Cloth, (PCL,PCLCP) | Pre-Printed  | -50°F to 170°F (-46°C to 77°C) | Indoor/outdoor rated; thin conformable material with repositionable adhesive allows label to be removed and reused or used in temporary applications; provides durability, high temperature resistance, and dimensional stability for rough or textured surfaces. |

| Part Number            | Legend               | Legend Height |      | Height |      | Width |      | Color (Legend/Background) | Markers Per Card | Std. Pkg. Card(s) | Std. Ctn. Card(s) |      |      |      |      |              |    |    |     |
|------------------------|----------------------|---------------|------|--------|------|-------|------|---------------------------|------------------|-------------------|-------------------|------|------|------|------|--------------|----|----|-----|
|                        |                      | In.           | mm   | In.    | mm   | In.   | mm   |                           |                  |                   |                   |      |      |      |      |              |    |    |     |
| PCL037-0               | 0                    | 0.38          | 9.7  | 0.50   | 12.7 | 0.34  | 8.7  | Black/Yellow              | 78               | 25                | 100               |      |      |      |      |              |    |    |     |
| PCL037-1 thru PCL037-9 | 1 thru 9             |               |      |        |      |       |      |                           |                  | 25                | 100               |      |      |      |      |              |    |    |     |
| PCL037-0-9             | 0 thru 9             |               |      |        |      |       |      |                           |                  | 25                | 100               |      |      |      |      |              |    |    |     |
| PCL037-A thru PCL037-Z | A thru Z             |               |      |        |      |       |      |                           |                  | 25                | 100               |      |      |      |      |              |    |    |     |
| PCL037-A-Z             | A thru Z             |               |      |        |      |       |      |                           |                  | 25                | 100               |      |      |      |      |              |    |    |     |
| PCLCP037-A-Z           | A thru Z             |               |      |        |      |       |      |                           |                  | 1                 | 4                 |      |      |      |      |              |    |    |     |
| PCLCP037-0-9           | 0 thru 9             |               |      |        |      |       |      |                           |                  | 1                 | 4                 |      |      |      |      |              |    |    |     |
| PCL037-DSH             | -                    |               |      |        |      |       |      |                           |                  | 25                | 100               |      |      |      |      |              |    |    |     |
| PCL062-0               | 0                    |               |      |        |      |       |      |                           |                  | 0.63              | 16.0              | 0.75 | 19.1 | 0.56 | 14.2 | Black/Yellow | 32 | 25 | 100 |
| PCL062-1 thru PCL062-9 | 1 thru 9             |               |      |        |      |       |      |                           |                  |                   |                   |      |      |      |      |              |    | 25 | 100 |
| PCL062-0-9             | 0 thru 9             | 1             | 4    |        |      |       |      |                           |                  |                   |                   |      |      |      |      |              |    |    |     |
| PCL062-A thru PCL062-Z | A thru Z             | 25            | 100  |        |      |       |      |                           |                  |                   |                   |      |      |      |      |              |    |    |     |
| PCL062-A-Z             | A thru Z             | 25            | 100  |        |      |       |      |                           |                  |                   |                   |      |      |      |      |              |    |    |     |
| PCLCP062-0-9           | 1 thru 5<br>6 thru 0 | 1             | 4    |        |      |       |      |                           |                  |                   |                   |      |      |      |      |              |    |    |     |
| PCLCP062-A-Z           | A thru Z             | 1             | 4    |        |      |       |      |                           |                  |                   |                   |      |      |      |      |              |    |    |     |
| PCL062-DSH             | -                    | 25            | 100  |        |      |       |      |                           |                  |                   |                   |      |      |      |      |              |    |    |     |
| PCL100-0               | 0                    | 1.00          | 25.4 | 1.50   | 38.1 | 0.88  | 22.4 | Black/Yellow              | 10               |                   |                   |      |      |      |      |              |    | 25 | 100 |
| PCL100-1 thru PCL100-9 | 1 thru 9             |               |      |        |      |       |      |                           |                  |                   |                   |      |      |      |      |              |    | 25 | 100 |
| PCL100-0-9             | 0 thru 9             |               |      |        |      |       |      |                           |                  | 25                | 100               |      |      |      |      |              |    |    |     |
| PCL100-A thru PCL100-Z | A thru Z             |               |      |        |      |       |      |                           |                  | 25                | 100               |      |      |      |      |              |    |    |     |
| PCL100-A-J             | A thru J             |               |      |        |      |       |      |                           |                  | 25                | 100               |      |      |      |      |              |    |    |     |
| PCL100-K-T             | K thru T             |               |      |        |      |       |      |                           |                  | 25                | 100               |      |      |      |      |              |    |    |     |
| PCL100-U-Z             | U thru Z             |               |      |        |      |       |      |                           |                  | 25                | 100               |      |      |      |      |              |    |    |     |
| PCLCP100-0-9           | 1 thru 5<br>6 thru 0 |               |      |        |      |       |      |                           |                  | 1                 | 4                 |      |      |      |      |              |    |    |     |
| PCLCP100-A-Z           | A thru Z             |               |      |        |      |       |      |                           |                  | 1                 | 4                 |      |      |      |      |              |    |    |     |
| PCL100-DSH             | -                    |               |      |        |      |       |      |                           |                  | 25                | 100               |      |      |      |      |              |    |    |     |
| PCL200-0               | 0                    | 2.00          | 50.8 | 2.25   | 57.2 | 0.88  | 22.4 | Black/Yellow              | 10               | 25                | 100               |      |      |      |      |              |    |    |     |
| PCL200-1 thru PCL200-9 | 1 thru 9             |               |      |        |      |       |      |                           |                  | 25                | 100               |      |      |      |      |              |    |    |     |
| PCL200-0-9             | 0 thru 9             |               |      |        |      |       |      |                           |                  | 25                | 100               |      |      |      |      |              |    |    |     |
| PCL200-A thru PCL200-Z | A thru Z             |               |      |        |      |       |      |                           |                  | 25                | 100               |      |      |      |      |              |    |    |     |
| PCL200-A-J             | A thru J             |               |      |        |      |       |      |                           |                  | 25                | 100               |      |      |      |      |              |    |    |     |
| PCL200-K-T             | K thru T             |               |      |        |      |       |      |                           |                  | 25                | 100               |      |      |      |      |              |    |    |     |
| PCL200-U-Z             | UK thru TZ           |               |      |        |      |       |      |                           |                  | 25                | 100               |      |      |      |      |              |    |    |     |
| PCLCP200-0-9           | 1 thru 5<br>6 thru 0 |               |      |        |      |       |      |                           |                  | 1                 | 4                 |      |      |      |      |              |    |    |     |
| PCLCP200-A-Z           | A thru Z             |               |      |        |      |       |      |                           |                  | 1                 | 4                 |      |      |      |      |              |    |    |     |
| PCL200-DSH             | -                    |               |      |        |      |       |      |                           |                  | 25                | 100               |      |      |      |      |              |    |    |     |

Table continues on page E5.38

A. System Overview

## Vinyl Cloth Letters and Numbers (continued)

B1. Cable Ties

B2. Cable Accessories

B3. Stainless Steel Ties

C1. Wiring Duct

| Part Number            | Legend               | Legend Height |      | Height |      | Width |      | Color (Legend/Background) | Markers Per Card | Std. Pkg. Card(s) | Std. Ctn. Card(s) |
|------------------------|----------------------|---------------|------|--------|------|-------|------|---------------------------|------------------|-------------------|-------------------|
|                        |                      | In.           | mm   | In.    | mm   | In.   | mm   |                           |                  |                   |                   |
| PCL300-0               | 0                    | 3.00          | 76.2 | 3.50   | 88.9 | 1.50  | 38.1 | Black/Yellow              | 6                | 25                | 100               |
| PCL300-1 thru PCL300-9 | 1 thru 9             |               |      |        |      |       |      |                           |                  | 25                | 100               |
| PCL300-A thru PCL300-Z | A thru Z             |               |      |        |      |       |      |                           |                  | 25                | 100               |
| PCLCP300-0-9           | 1 thru 5<br>6 thru 0 |               |      |        |      |       |      |                           |                  | 1                 | 4                 |
| PCLCP300-A-Z           | A thru Z             |               |      |        |      |       |      |                           |                  | 1                 | 4                 |
| PCL300-DSH             | —                    |               |      |        |      |       |      |                           |                  | 25                | 100               |

C2. Surface Raceway

## Reflective Letters and Numbers

C3. Abrasion Protection

C4. Cable Management



### Material Chart

| Material                | Print Method | Temperature Range              | Features   |
|-------------------------|--------------|--------------------------------|--|
| Reflective Vinyl, (PRL) | Pre-Printed  | -30°F to 200°F (-34°C to 93°C) | Indoor/outdoor rated; heavy duty reflective material for flat applications and safety and facility identification; resistant to UV light, chemical atmosphere, and abrasion. |

D1. Terminals

D2. Power Connectors

D3. Grounding Connectors

E1. Labeling Systems

E2. Labels

E3. Pre-Printed & Write-On Markers

E4. Permanent Identification

E5. Lockout/Tagout & Safety Solutions

F. Index

| Part Number                | Legend                         | Legend Height |       | Height |       | Width |       | Color (Legend/Background) | Markers Per Pkg. | Std. Pkg. Qty. | Std. Ctn. Qty. |     |   |   |
|----------------------------|--------------------------------|---------------|-------|--------|-------|-------|-------|---------------------------|------------------|----------------|----------------|-----|---|---|
|                            |                                | In.           | mm    | In.    | mm    | In.   | mm    |                           |                  |                |                |     |   |   |
| PRL100BY-0 thru PRL100BY-9 | 0 thru 9                       | 1.00          | 25.40 | 1.63   | 41.40 | 1.00  | 25.40 | Black/Yellow              | 25               | 1              | 4              |     |   |   |
| PRL100BY-A thru PRL100BY-Z | A thru Z                       |               |       |        |       |       |       |                           |                  |                |                |     |   |   |
| PRL100BY-DSH               | —                              |               |       |        |       |       |       |                           |                  |                |                |     |   |   |
| PRL100BY-18KIT             | 0 thru 9, A thru D, L, P, R, S |               |       |        |       |       |       |                           |                  |                |                | 900 | 1 | — |
| PRL100BY-36KIT             | 0 thru 9, A thru Z, —, Blank   |               |       |        |       |       |       |                           |                  |                |                | 950 | 1 | — |
| PRL100BY-BLNK              | BLANK                          |               |       |        |       |       |       |                           |                  |                |                | 25  | 1 | 4 |
| PRL150YB-0 thru PRL150YB-9 | 0 thru 9                       | 1.50          | 38.10 | 1.88   | 47.75 | 1.38  | 35.05 | Yellow/Black              | 25               | 1              | 4              |     |   |   |
| PRL150YB-A thru PRL150YB-Z | A thru Z                       |               |       |        |       |       |       |                           |                  |                |                |     |   |   |
| PRL150YB-DSH               | —                              |               |       |        |       |       |       |                           |                  |                |                |     |   |   |
| PRL250YB-0 thru PRL250YB-9 | 0 thru 9                       | 2.50          | 63.50 | 2.88   | 73.15 | 1.75  | 44.45 | Yellow/Black              | 25               | 1              | 4              |     |   |   |
| PRL250YB-A thru PRL250YB-Z | A thru Z                       |               |       |        |       |       |       |                           |                  |                |                |     |   |   |
| PRL250YB-DSH               | —                              |               |       |        |       |       |       |                           |                  |                |                |     |   |   |



## Sign Panels – Blank Space for Custom Messages

### Indoor/Outdoor Sub-Surface Printed Adhesive Polyester (Type PPS)

- High quality signs for use indoors and outdoors
- Excellent resistance to UV light, chemical atmosphere, and abrasion
- Excellent life and adhesion properties
- Printed graphics are protected by clear polyester laminate





### Indoor/Outdoor Rigid Polyethylene (Type PRS)

- Rugged signs for indoors and outdoors
- Abrasion resistant
- Used where adhesives will not work

- Can be used with Panduit Thermal Transfer Desktop Printers and Easy-Mark™ Labeling Software to create your own custom signs
- Print your own legend on clear polyester tape with the TDP43MY Thermal Transfer Desktop Printer and adhere label to adhesive or non-adhesive sign panel
- Can also be used with Panduit Die Cut Letter and Numbers

### Material Chart

| Material                 | Print Method | Temperature Range                | Features  |
|--------------------------|--------------|----------------------------------|---|
| Polyester (PPS)          | Pre-Printed  | -40°F to 275°F (-40°C to 135°C)  | Indoor/outdoor rated; laminated label material protects legend from abrasion and chemicals; resistant to UV light, chemical atmosphere, and abrasion; excellent life and adhesion properties. |
| Rigid Polyethylene (PRS) |              | -105°F to 250°F (-76°C to 121°C) | Indoor/outdoor rated; high quality, rugged material resistant to abrasion; use where adhesives will not work.   |

| Part Number | Symbol  | Header  | Width |       | Height |       | Std. Pkg. Qty | Std. Ctn. Qty. |
|-------------|---|---------|-------|-------|--------|-------|---------------|----------------|
|             |   |         | In.   | mm    | In.    | mm    |               |                |
| PPS0710BWHT |  | BLANK   | 10.00 | 254.0 | 7.00   | 177.8 | 1             | 25             |
| PPS1014BWHT |   |         | 14.00 | 355.6 | 10.00  | 254.0 | 1             | 25             |
| PPS1420BWHT |   |         | 20.00 | 508.0 | 14.00  | 355.6 | 1             | 25             |
| PRS0710BWHT |   |         | 10.00 | 254.0 | 7.00   | 177.8 | 1             | 10             |
| PRS1014BWHT |   |         | 14.00 | 355.6 | 10.00  | 254.0 | 1             | 10             |
| PRS1420BWHT |   |         | 20.00 | 508.0 | 14.00  | 355.6 | 1             | 10             |
| PPS0710BYEL |  | BLANK   | 10.00 | 254.0 | 7.00   | 177.8 | 1             | 25             |
| PPS1014BYEL |   |         | 14.00 | 355.6 | 10.00  | 254.0 | 1             | 25             |
| PPS1420BYEL |   |         | 20.00 | 508.0 | 14.00  | 355.6 | 1             | 25             |
| PRS0710BYEL |   |         | 10.00 | 254.0 | 7.00   | 177.8 | 1             | 10             |
| PRS1014BYEL |   |         | 14.00 | 355.6 | 10.00  | 254.0 | 1             | 10             |
| PRS1420BYEL |   |         | 20.00 | 508.0 | 14.00  | 355.6 | 1             | 10             |
| PPS0710C442 |  | CAUTION | 10.00 | 254.0 | 7.00   | 177.8 | 1             | 25             |
| PPS1014C442 |   |         | 14.00 | 355.6 | 10.00  | 254.0 | 1             | 25             |
| PPS1420C442 |   |         | 20.00 | 508.0 | 14.00  | 355.6 | 1             | 25             |
| PRS0710C442 |   |         | 10.00 | 254.0 | 7.00   | 177.8 | 1             | 10             |
| PRS1014C442 |   |         | 14.00 | 355.6 | 10.00  | 254.0 | 1             | 10             |
| PRS1420C442 |   |         | 20.00 | 508.0 | 14.00  | 355.6 | 1             | 10             |
| PPS0710D440 |  | DANGER  | 10.00 | 254.0 | 7.00   | 177.8 | 1             | 25             |
| PPS1014D440 |   |         | 14.00 | 355.6 | 10.00  | 254.0 | 1             | 25             |
| PPS1420D440 |   |         | 20.00 | 508.0 | 14.00  | 355.6 | 1             | 25             |
| PRS0710D440 |   |         | 10.00 | 254.0 | 7.00   | 177.8 | 1             | 10             |
| PRS1014D440 |   |         | 14.00 | 355.6 | 10.00  | 254.0 | 1             | 10             |
| PRS1420D440 |   |         | 20.00 | 508.0 | 14.00  | 355.6 | 1             | 10             |
| PPS0710N443 |  | NOTICE  | 10.00 | 254.0 | 7.00   | 177.8 | 1             | 25             |
| PPS1014N443 |   |         | 14.00 | 355.6 | 10.00  | 254.0 | 1             | 25             |
| PPS1420N443 |   |         | 20.00 | 508.0 | 14.00  | 355.6 | 1             | 25             |
| PRS0710N443 |   |         | 10.00 | 254.0 | 7.00   | 177.8 | 1             | 10             |
| PRS1014N443 |   |         | 14.00 | 355.6 | 10.00  | 254.0 | 1             | 10             |
| PRS1420N443 |   |         | 20.00 | 508.0 | 14.00  | 355.6 | 1             | 10             |

Order number of Standard Packages required

A. System Overview

## Thermal Transfer Printable Arc Flash Labels

B1. Cable Ties

- Provide employees with the highest degree of safety through proper identification and communication
- Labels are constructed of durable polyester designed to withstand UV exposure, outdoor use, water, abrasion
- Clearly visible and recognizable hazard information to communicate arc flash hazards present
- Custom Arc Flash Hazard Labels can be printed using Panduit labeling software and desktop thermal transfer printers

B2. Cable Accessories

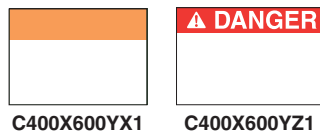

B3. Stainless Steel Ties

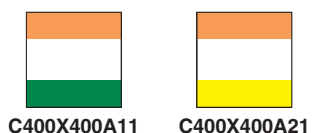

C1. Wiring Duct

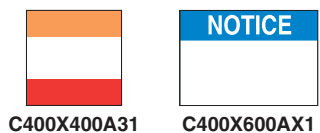

C2. Surface Raceway

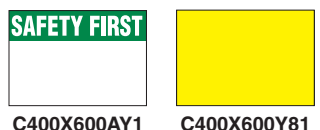

C3. Abrasion Protection

C4. Cable Management



D1. Terminals

D2. Power Connectors

D3. Grounding Connectors

## Laser Printable Adhesive Signs

- Signs can be printed with a standard laser printer
- Signs are 8.50" x 11.00" (215.90mm x 279.40mm) in size
- Indoor polyolefin pressure sensitive signs with square corners on stay flat liner
- 25 signs per package



E2. Labels



E3. Pre-Printed & Write-On Markers

E4. Permanent Identification

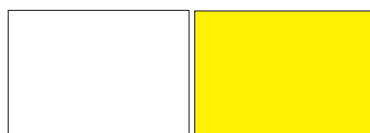

E5. Lockout/Tagout & Safety Solutions

F. Index

| Part Number | Part Description | Std. Pkg. Qty. | Std. Ctn. Qty. |
|-------------|------------------|----------------|----------------|
|-------------|------------------|----------------|----------------|

### Custom – Die-Cut

|                    |  |   |   |
|--------------------|--|---|---|
| <b>C400X600YX1</b> | 4.00" x 6.00" (101.6mm x 152.4mm), polyester arc flash label, orange header, 100 labels per roll.                | 1 | 4 |
| <b>C400X600YZ1</b> | 4.00" x 6.00" (101.6mm x 152.4mm), polyester arc flash label, red/white danger header, 100 labels per roll.      | 1 | 4 |
| <b>C400X400A11</b> | 4.00" x 4.00" (101.6mm x 101.6mm), polyester safety label, orange header, green footer, 250 labels per roll.     | 1 | 4 |
| <b>C400X400A21</b> | 4.00" x 4.00" (101.6mm x 101.6mm), polyester safety label, orange header, yellow footer, 250 labels per roll.    | 1 | 4 |
| <b>C400X400A31</b> | 4.00" x 4.00" (101.6mm x 101.6mm), polyester safety label, orange header, red footer, 250 labels per roll.       | 1 | 4 |
| <b>C400X600AX1</b> | 4.00" x 6.00" (101.6mm x 152.4mm), polyester safety label, blue/white NOTICE header, 100 labels per roll.        | 1 | 4 |
| <b>C400X600AY1</b> | 4.00" x 6.00" (101.6mm x 152.4mm), polyester safety label, green/white SAFETY FIRST header, 100 labels per roll. | 1 | 4 |
| <b>C400X600Y81</b> | 4.00" x 6.00" (101.6mm x 152.4mm), polyester safety label, yellow, 100 labels per roll.                          | 1 | 4 |
| <b>C400X600AZ1</b> | 4.00" x 6.00" (101.6mm x 152.4mm), polyester arc flash label, yellow header, 100 labels per roll.                | 1 | 4 |

### Custom – Continuous Tape

|                    |  |   |   |
|--------------------|--|---|---|
| <b>T400X000YX1</b> | 4.00" x 50.0' (101.6mm x 15.24M), polyester arc flash tape, orange header. | 1 | 4 |
|--------------------|--|---|---|

| Part Number      | Legend  | Color (Legend/Background) | Width |        | Height |        | Signs Per Pkg. | Std. Pkg. Qty. | Std. Ctn. Qty. |
|------------------|---------|---------------------------|-------|--------|--------|--------|----------------|----------------|----------------|
|                  |         |                           | In.   | mm     | In.    | mm     |                |                |                |
| <b>SEZ-1CLL</b>  | CAUTION | Black/Yellow              | 8.50  | 216.00 | 11.00  | 279.00 | 25             | 1              | 5              |
| <b>SEZ-1DLL</b>  | DANGER  | Red and Black/White       | 8.50  | 216.00 | 11.00  | 279.00 | 25             | 1              | 5              |
| <b>SEZ-1NLL</b>  | NOTICE  | Blue/White                | 8.50  | 216.00 | 11.00  | 279.00 | 25             | 1              | 5              |
| <b>SEZ-1WLL</b>  | WARNING | Black/Orange              | 8.50  | 216.00 | 11.00  | 279.00 | 25             | 1              | 5              |
| <b>SEZ-1WHLL</b> | BLANK   | White                     | 8.50  | 216.00 | 11.00  | 279.00 | 25             | 1              | 5              |
| <b>SEZ-1YLL</b>  | BLANK   | Yellow                    | 8.50  | 216.00 | 11.00  | 279.00 | 25             | 1              | 5              |

## Self-Laminating Adhesive Sign Carriers



### Material Chart

| Material    | Print Method | Temperature Range                 | Features  |
|-------------|--------------|-----------------------------------|---|
| Rigid Vinyl | Pre-Printed  | -40°F to 150°F<br>(-40°C to 66°C) | Indoor/outdoor rated; rigid material accepts ink; resistant to UV light, chemical atmosphere, and abrasion; excellent for applications where adhesives will not work. |

| Part Number | Height |    |     |    | Carriers Per Pkg. | Std. Pkg. Qty. | Std. Ctn. Qty. |
|-------------|--------|----|-----|----|-------------------|----------------|----------------|
|             | In.    | mm | In. | mm |                   |                |                |

### Adhesive

|          |       |       |      |       |   |   |    |
|----------|-------|-------|------|-------|---|---|----|
| SEZ-SNC4 | 7.00  | 178.0 | 6.00 | 152.0 | 5 | 1 | 10 |
| SEZ-SNC3 | 12.00 | 305.0 | 6.00 | 152.0 | 5 | 1 | 10 |
| SEZ-SNC2 | 10.50 | 267.0 | 7.00 | 178.0 | 5 | 1 | 10 |
| SEZ-SNC1 | 12.00 | 305.0 | 9.50 | 241.0 | 5 | 1 | 10 |

### Non-Adhesive

|          |       |       |      |       |   |   |    |
|----------|-------|-------|------|-------|---|---|----|
| SEZ-RSC1 | 7.00  | 178.0 | 6.00 | 152.0 | 5 | 1 | 10 |
| SEZ-RSC2 | 10.50 | 267.0 | 7.00 | 178.0 | 5 | 1 | 10 |
| SEZ-RSC3 | 12.00 | 305.0 | 9.50 | 241.0 | 5 | 1 | 10 |
| SEZ-RSC4 | 12.00 | 305.0 | 6.00 | 152.0 | 5 | 1 | 10 |

## Self-Laminating Cable Marker Holders for Large Cables or Cable Bundles



### Material Chart

| Material                     | Print Method | Temperature Range               | Features   |
|------------------------------|--------------|---------------------------------|--|
| Rigid Vinyl, Self-Laminating | Pre-Printed  | 0°F to 176°F<br>(-18°C to 80°C) | Indoor/outdoor rated; high quality, rugged material resistant to abrasion; legend is protected by overlamine; use where adhesives will not work. |

| Part Number | Color  | Width |       | Height |      | Tags Per Pkg. | Std. Pkg. Qty. | Std. Ctn. Qty. |
|-------------|--------|-------|-------|--------|------|---------------|----------------|----------------|
|             |        | In.   | mm    | In.    | mm   |               |                |                |
| SLCT-IG     | Gray   | 3.00  | 76.2  | 1.31   | 33.3 | 25            | 1              | 4              |
| SLCT-OR     | Orange | 3.00  | 76.2  | 1.31   | 33.3 | 25            | 1              | 4              |
| SLCT-WH     | White  | 3.00  | 76.2  | 1.31   | 33.3 | 25            | 1              | 4              |
| SLCT-YL     | Yellow | 3.00  | 76.2  | 1.31   | 33.3 | 25            | 1              | 4              |
| SLCT-3      | White  | 4.00  | 101.6 | 0.50   | 12.7 | 25            | 1              | 4              |
| SLCT-3OR    | Orange | 4.00  | 101.6 | 0.50   | 12.7 | 25            | 1              | 4              |
| SLCT-3YL    | Yellow | 4.00  | 101.6 | 0.50   | 12.7 | 25            | 1              | 4              |

Attach with Panduit Intermediate or Standard Cross-Section Cable Ties.

### Component Labels for Laser/Ink Jet Printers Supplied on 8.5" x 11" Sheets

|             |                         |      |      |      |      |   |      |      |
|-------------|-------------------------|------|------|------|------|---|------|------|
| C200X100YJJ | White, polyester label. | 2.00 | 50.8 | 1.00 | 25.4 | — | 1000 | 5000 |
|-------------|-------------------------|------|------|------|------|---|------|------|

### Component Labels for Thermal Transfer Desktop Printers Supplied on Rolls

|             |                         |      |      |      |      |   |      |       |
|-------------|-------------------------|------|------|------|------|---|------|-------|
| C200X100YJT | White, polyester label. | 2.00 | 50.8 | 1.00 | 25.4 | — | 2500 | 10000 |
|-------------|-------------------------|------|------|------|------|---|------|-------|

### Component Cassettes for Panther™ LS8 Hand-Held Thermal Transfer Printer

|             |                                       |      |      |      |      |   |   |    |
|-------------|---------------------------------------|------|------|------|------|---|---|----|
| C200X100YJC | White, polyester label, 200/cassette. | 2.00 | 50.8 | 1.00 | 25.4 | — | 1 | 10 |
|-------------|---------------------------------------|------|------|------|------|---|---|----|

A. System Overview

## Self-Laminating Fiber Optic Cable Marker Tags

B1. Cable Ties

B2. Cable Accessories

B3. Stainless Steel Ties

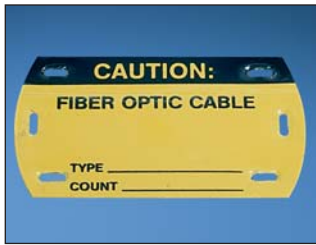

### Material Chart

| Material                     | Print Method | Temperature Range            | Features   |
|------------------------------|--------------|------------------------------|--|
| Rigid Vinyl, Self-Laminating | Pre-Printed  | 0°F to 176°F (-18°C to 80°C) | Indoor/outdoor rated; high quality, rugged material resistant to abrasion; legend is protected by overlamine; use where adhesives will not work. |

C1. Wiring Duct

C2. Surface Raceway

C3. Abrasion Protection

C4. Cable Management

D1. Terminals

D2. Power Connectors

D3. Grounding Connectors

E1. Labeling Systems

E2. Labels

E3. Pre-Printed & Write-On Markers

E4. Permanent Identification

E5. Lockout/Tagout & Safety Solutions

F. Index

| Part Number       | Legend  | Color (Legend/Background) | Width |       | Height |       | Tags Per Pkg. | Std. Pkg. Qty. | Std. Ctn. Qty. |
|-------------------|---|---------------------------|-------|-------|--------|-------|---------------|----------------|----------------|
|                   |   |                           | In.   | mm    | In.    | mm    |               |                |                |
| <b>PST-FO</b>     | CAUTION FIBER OPTIC CABLE TYPE _____<br>COUNT _____ | Black/Yellow              | 3.50  | 89.00 | 2.00   | 51.00 | 5             | 1              | 40             |
| <b>PST-FOBLNK</b> | BLANK   | Yellow                    | 3.50  | 89.00 | 2.00   | 51.00 | 5             | 1              | 40             |

Order number of packages required in multiples of Std. Pkg. Qty.

## Ground Warning Tags



### Material Chart

| Material           | Print Method | Temperature Range               | Features  |
|--------------------|--------------|---------------------------------|---|
| Rigid Polyethylene | Pre-Printed  | -30°F to 250°F (-34°C to 121°C) | Indoor/outdoor rated; high quality, rugged material resistant to abrasion; use where adhesives will not work. |

| Part Number    | Legend                               | Color (Legend/Background) | Width |       | Height |       | Tags Per Pkg. | Std. Pkg. Qty. | Std. Ctn. Qty. |
|----------------|--------------------------------------|---------------------------|-------|-------|--------|-------|---------------|----------------|----------------|
|                |                                      |                           | In.   | mm    | In.    | mm    |               |                |                |
| <b>PT-BGND</b> | NETWORK BUILDING GROUND              | Green/Yellow              | 2.75  | 70.00 | 1.38   | 35.00 | 100           | 1              | 5              |
| <b>PT-GND</b>  | WARNING GROUND WIRE DO NOT REMOVE    | Black/Yellow              | 2.75  | 70.00 | 1.38   | 35.00 | 100           | 1              | 5              |
| <b>PT-TGND</b> | WARNING TELEPHONE CO. REPAIR SERVICE | Black/Yellow              | 2.75  | 70.00 | 1.38   | 35.00 | 100           | 1              | 5              |

Attach with Panduit Intermediate or Standard cross section cable ties.

## Panduit Corp. Generic Padlock Order Form

One Form per Generic Padlock Option  
**Fax orders to Panduit Corp., Attn: Customer Service (708) 570-3570**  
**Generic Locks are Non-Returnable**

Date: \_\_\_\_\_  
 From: \_\_\_\_\_  
 Telephone #: \_\_\_\_\_  
 End User: \_\_\_\_\_  
 \_\_\_\_\_  
 Telephone#/Fax#: \_\_\_\_\_  
 Account #: \_\_\_\_\_

Panduit Sales Rep: \_\_\_\_\_  
 Distributor: \_\_\_\_\_  
 \_\_\_\_\_  
 \_\_\_\_\_  
 Distributor Contact: \_\_\_\_\_  
 Telephone#/Fax#: \_\_\_\_\_  
 Account #: \_\_\_\_\_

### Generic Padlock Options

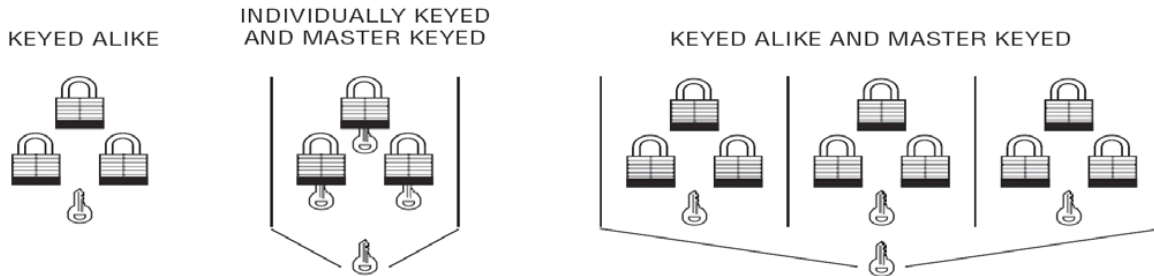

| Generic Padlock Part Number  | Description   | Qty. Min. 12/ Padlock Series | Notes (Colors, Key Numbers, Set Description) |
|--|---|------------------------------|--|
| <b>PSL-6 Laminated Steel Padlocks: (Select from red, yellow, blue, black, green, or white bumper colors)</b> |   |                              |  |
| GPSL-6KA   | Keyed Alike Padlock – ¾" Shackle                    |                              |  |
| GPSL-6LSKA   | Keyed Alike Padlock – 2" Shackle                    |                              |  |
| GPSL-6MK   | Master Keyed Padlock – ¾" Shackle                   |                              |  |
| GPSL-6LSMK   | Master Keyed Padlock – 2" Shackle                   |                              |  |
| GPSL-6KAMK   | Keyed Alike and Master Keyed Padlock – ¾" Shackle   |                              |  |
| GPSL-6LSKAMK   | Keyed Alike and Master Keyed Padlock – 2" Shackle   |                              |  |
| GPSL-6MKEY   | Master Key for a PSL -6 Master Keyed Padlock        |                              |  |
| <b>PSL-7 Coated Aluminum Padlocks: (Select from red, yellow, blue, black, green, or orange body colors)</b>  |   |                              |  |
| GPSL-7KA   | Keyed Alike Padlock – 1" Shackle                    |                              |  |
| GPSL-7LSKA   | Keyed Alike Padlock – 3" Shackle                    |                              |  |
| GPSL-7MK   | Master Keyed Padlock – 1" Shackle                   |                              |  |
| GPSL-7LSMK   | Master Keyed Padlock – 3" Shackle                   |                              |  |
| GPSL-7KAMK   | Keyed Alike and Master Keyed Padlock – 1" Shackle   |                              |  |
| GPSL-7LSKAMK   | Keyed Alike and Master Keyed Padlock – 3" Shackle   |                              |  |
| GPSL-7MKEY   | Master Key for a PSL -7 Master Keyed Padlock        |                              |  |
| <b>PSL-8 Safety Lockout Padlocks: (Select from red, yellow, blue, black, green, or orange body colors)</b>   |   |                              |  |
| GPSL-8KA   | Keyed Alike Padlock – 1.5" Shackle                  |                              |  |
| GPSL-8MK   | Master Keyed Padlock – 1.5" Shackle                 |                              |  |
| GPSL-8KAMK   | Keyed Alike and Master Keyed Padlock – 1.5" Shackle |                              |  |
| GPSL-8MKEY   | Master Key for a PSL -8 Master Keyed Padlock        |                              |  |

For Pricing and Lead Time Information, Contact Panduit Customer Service at 800-777-3300

A. System Overview

B1. Cable Ties

B2. Cable Accessories

B3. Stainless Steel Ties

C1. Wiring Duct

C2. Surface Raceway

C3. Abrasion Protection

C4. Cable Management

D1. Terminals

D2. Power Connectors

D3. Grounding Connectors

E1. Labeling Systems

E2. Labels

E3. Pre-Printed & Write-On Markers

E4. Permanent Identification

E5. Lockout/Tagout & Safety Solutions

F. Index

## Panduit Corp. Generic PVT Vinyl Tag Order Form

One Form per Generic Tag Option

**Fax orders to Panduit Corp., Attn: Customer Service (708) 570-3570**

**Generic Tags are Non-Returnable**

Date: \_\_\_\_\_ Panduit Sales Rep: \_\_\_\_\_  
 From: \_\_\_\_\_ Distributor: \_\_\_\_\_  
 Telephone #: \_\_\_\_\_  
 End User: \_\_\_\_\_  
 \_\_\_\_\_  
 \_\_\_\_\_  
 Telephone#/Fax#: \_\_\_\_\_ Telephone#/Fax#: \_\_\_\_\_  
 Account #: \_\_\_\_\_ Account #: \_\_\_\_\_

### Select the Generic Vinyl Tag Part Number and Quantity:

| Number of Sides Printed | <b>DANGER</b><br>Black on White | <b>CAUTION</b><br>Black on Yellow | <b>NOTICE</b><br>Black on White | "No Header"<br>Black on White | "No Header"<br>Black on Yellow | "No Header"<br>Black on Red | "No Header"<br>Black on Green |
|-------------------------|---------------------------------|-----------------------------------|---------------------------------|-------------------------------|--------------------------------|-----------------------------|-------------------------------|
| 1                       | GPVT-RBW1                       | GPVT-BY1                          | GPVT-BBW1                       | GPVT-W1-1                     | GPVT-Y1-1                      | GPVT-R1-1                   | GPVT-G1-1                     |
| 2                       | GPVT-RBW2                       | GPVT-BY2                          | GPVT-BBW2                       | GPVT-W1-2                     | GPVT-Y1-2                      | GPVT-R1-2                   | GPVT-G1-2                     |

Quantity In Packs (min. of 4 packs, 25 tags and ties/pack): \_\_\_\_\_ Part Number: \_\_\_\_\_

Use this space to create a rough sketch of your tag.  
 Please indicate colors and legend. Please print.  
 Attach an additional page or customer sketch if needed.

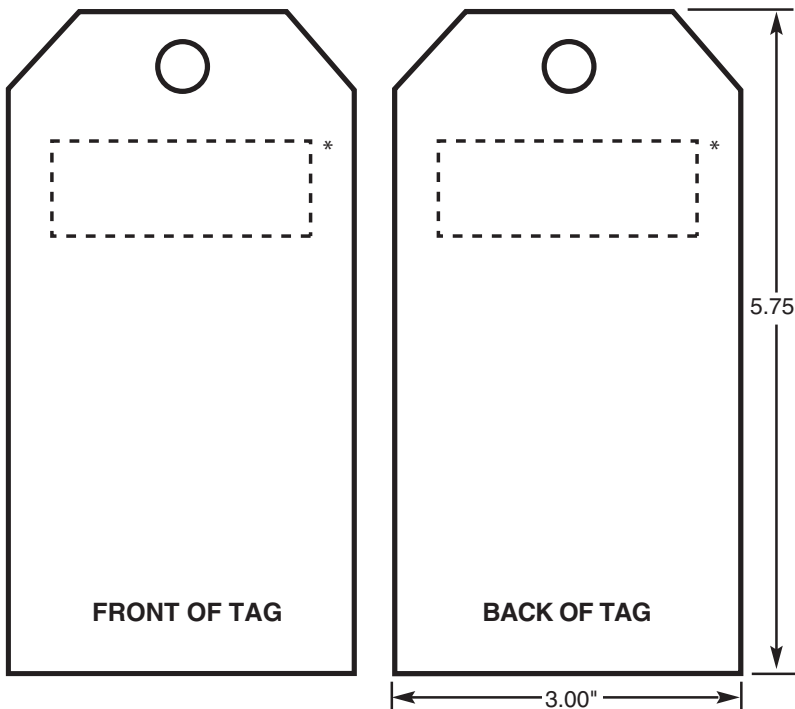

### Check Applicable Order Requirements:

**Pictogram** (type \_\_\_\_\_)  
**Logo Required** (camera ready artwork must accompany the order form)

**Character Height** (legend will be formatted to fit the size of the tag unless otherwise specified)

**Logo Required** \_\_\_\_\_  
 (Panduit reserves the right to assign artwork approval when necessary)

\*Normal position of header. Hole size = .375" with grommet.

One Panduit tie is included per tag.

For Pricing and Lead Time Information, Contact Panduit Customer Service at 800-777-3300







## Panduit Corp. Generic Adhesive PPS Safety Sign Order Form

One Form per Generic Sign Option  
**Fax orders to Panduit Corp., Attn: Customer Service (708) 570-3570**  
**Generic Signs are Non-Returnable**

Date: \_\_\_\_\_ Panduit Sales Rep: \_\_\_\_\_  
 From: \_\_\_\_\_ Distributor: \_\_\_\_\_  
 Telephone #: \_\_\_\_\_  
 End User: \_\_\_\_\_  
 \_\_\_\_\_  
 \_\_\_\_\_  
 Telephone#/Fax#: \_\_\_\_\_ Distributor Contact: \_\_\_\_\_  
 Account #: \_\_\_\_\_ Telephone#/Fax#: \_\_\_\_\_  
 Account #: \_\_\_\_\_

### Generic PPS Sign Options

Select the Generic Polyester Sign Part Number and Quantity

| Size      |  Black on White |  Black on Yellow |  Black on White |  Black on White |  Black on Orange | "No Header"<br>Black on Orange | "No Header"<br>Black on White | "No Header"<br>Black on Yellow | "No Header"<br>Red on White |
|-----------|--|---|--|--|---|--------------------------------|-------------------------------|--------------------------------|-----------------------------|
| 3" x 5"   | GPPS0305D  | GPPS0305C   | GPPS0305N  | GPPS0305SF   | GPPS0305W   | GPPS0305B-BO                   | GPPS0305B-BW                  | GPPS0305B-BY                   | GPPS0305B-RW                |
| 7" x 10"  | GPPS0710D  | GPPS0710C   | GPPS0710N  | GPPS0710SF   | GPPS0710W   | GPPS0710B-BO                   | GPPS0710B-BW                  | GPPS0710B-BY                   | GPPS0710B-RW                |
| 10" x 14" | GPPS1014D  | GPPS1014C   | GPPS1014N  | GPPS1014SF   | GPPS1014W   | GPPS1014B-BO                   | GPPS1014B-BW                  | GPPS1014B-BY                   | GPPS1014B-RW                |

Quantity Per Legend Per Size (Minimum of 10): \_\_\_\_\_ Part Number: \_\_\_\_\_

**Print Legend in the Format Required:**  
 Include Logos and/or Pictograms

Check Applicable Order Requirements

\_\_\_\_\_ Pictogram (type \_\_\_\_\_)  
 \_\_\_\_\_ Logo Required (camera ready artwork must accompany order form)  
 \_\_\_\_\_ Character Height (legend will be formatted to fit the size of the sign unless otherwise specified): \_\_\_\_\_

**ARTWORK APPROVAL** (Panduit reserves the right to assign artwork approval when necessary)

Notes: \_\_\_\_\_  
 \_\_\_\_\_  
 \_\_\_\_\_

**For Pricing and Lead Time Information, Contact Panduit Customer Service at 800-777-3300**

A. System Overview

B1. Cable Ties

B2. Cable Accessories

B3. Stainless Steel Ties

C1. Wiring Duct

C2. Surface Raceway

C3. Abrasion Protection

C4. Cable Management

D1. Terminals

D2. Power Connectors

D3. Grounding Connectors

E1. Labeling Systems

E2. Labels

E3. Pre-Printed & Write-On Markers

E4. Permanent Identification

E5. Lockout/Tagout & Safety Solutions

F. Index

A. System Overview

## Panduit Corp. Generic Semi-Rigid PRS Safety Sign Order Form

B1. Cable Ties

One Form per Generic Sign Option  
**Fax orders to Panduit Corp., Attn: Customer Service (708) 570-3570**  
**Generic Signs are Non-Returnable**

B2. Cable Accessories

Date: \_\_\_\_\_ Panduit Sales Rep: \_\_\_\_\_

From: \_\_\_\_\_ Distributor: \_\_\_\_\_

Telephone #: \_\_\_\_\_

B3. Stainless Steel Ties

End User: \_\_\_\_\_

\_\_\_\_\_

Distributor Contact: \_\_\_\_\_

C1. Wiring Duct





Telephone#/Fax#: \_\_\_\_\_ Telephone#/Fax#: \_\_\_\_\_

Account #: \_\_\_\_\_ Account #: \_\_\_\_\_

C2. Surface Raceway

### Generic PRS Sign Options

Select the Generic Semi-Rigid GMPE1 Polyethylene Sign Part Number and Quantity

| Size      |  Black on White |  Black on Yellow |  Black on White |  Black on White |  Black on Orange | "No Header"<br>Black on Orange | "No Header"<br>Black on White | "No Header"<br>Black on Yellow | "No Header"<br>Red on White |
|-----------|--|---|--|--|---|--------------------------------|-------------------------------|--------------------------------|-----------------------------|
| 7" x 10"  | GPRS0710D  | GPRS0710C   | GPRS0710N  | GPRS0710SF   | GPRS0710W   | GPRS0710B-BO                   | GPRS0710B-BW                  | GPRS0710B-BY                   | GPRS0710B-RW                |
| 10" x 14" | GPRS1014D  | GPRS1014C   | GPRS1014N  | GPRS1014SF   | GPRS1014W   | GPRS1014B-BO                   | GPRS1014B-BW                  | GPRS1014B-BY                   | GPRS1014B-RW                |
| 14" x 20" | GPRS1420D  | GPRS1420C   | GPRS1420N  | GPRS1420SF   | GPRS1420W   | GPRS1420B-BO                   | GPRS1420B-BW                  | GPRS1420B-BY                   | GPRS1420B-RW                |

D1. Terminals

Quantity Per Legend Per Size (Minimum of 10): \_\_\_\_\_ Part Number: \_\_\_\_\_

D2. Power Connectors

### Print Legend in the Format Required:

Include Logos and/or Pictograms



Each sign will have (1) .1875" hole in each corner and .375" radius corners.

Check Applicable Order Requirements

D3. Grounding Connectors

\_\_\_\_\_ Pictogram (type \_\_\_\_\_)

\_\_\_\_\_ Logo Required (camera ready artwork must accompany order form)

\_\_\_\_\_ Character Height (legend will be formatted to fit the size of the sign unless otherwise specified): \_\_\_\_\_

E4. Permanent Identification

**ARTWORK APPROVAL** (Panduit reserves the right to assign artwork approval when necessary)

**Notes:** \_\_\_\_\_

E5. Lockout/Tagout & Safety Solutions

F. Index

**For Pricing and Lead Time Information, Contact Panduit Customer Service at 800-777-3300**

## Panduit Corp. Generic Conduit and Voltage Marker Order Form

One Form per Generic Marker Option

**Fax orders to Panduit Corp., Attn: Customer Service (708) 570-3570**

**Generic Markers are Non-Returnable**

Date: \_\_\_\_\_

Panduit Sales Rep: \_\_\_\_\_

From: \_\_\_\_\_

Distributor: \_\_\_\_\_

Telephone #: \_\_\_\_\_

End User: \_\_\_\_\_

Distributor Contact: \_\_\_\_\_

Telephone#/Fax#: \_\_\_\_\_

Telephone#/Fax#: \_\_\_\_\_

Account #: \_\_\_\_\_

Account #: \_\_\_\_\_

### Generic Conduit and Voltage Marker Options

#### Pressure Sensitive Adhesive GMV1 Vinyl Conduit and Voltage Markers

#### LEGEND

|        |        |
|--------|--------|
| LEGEND | LEGEND |
| LEGEND | LEGEND |

#### STYLE A

Marker size: 2.25" x 9"  
1 marker per card  
Character height: 1.75"



#### STYLE B

Marker size: 1.125" x 4.5"  
1 marker per card  
Character height: .75"

#### STYLE C

Marker size: .50" x 2.25" – 18 marker per card  
Character height: .3125"

**Minimum Order Quantity:** 10 cards per legend per size and in multiples of 5 cards

| Part Desired ✓ | Quantity of Cards | Part Number | Legend Color | Backgrnd Color | Style | Markers/ Card |
|----------------|-------------------|-------------|--------------|----------------|-------|---------------|
|                |                   | GPCV-AOY    | BLACK        | ORANGE         | A     | 1             |
|                |                   | GPCV-BOY    | BLACK        | ORANGE         | B     | 4             |
|                |                   | GPCV-COY    | BLACK        | ORANGE         | C     | 18            |
|                |                   | GPCV-AYY    | BLACK        | YELLOW         | A     | 1             |
|                |                   | GPCV-BYY    | BLACK        | YELLOW         | B     | 4             |
|                |                   | GPCV-CYY    | BLACK        | YELLOW         | C     | 18            |

Print Legend Required

Legend to fit on one line. Max. 17 characters including spaces.

\*Note: In Style B and C, if you want several different legends on a card, draw the lines to signify label division on the legend area. Write in the different legends needed.

#### Semi-Rigid Snap-On GMPET Polyester Conduit and Voltage Markers



- Protected graphics
- Six reversible legends per marker
- Character height: Size M – .50"  
Size R – .75"

**Minimum Order Quantity:** 10 markers per legend per size

| Part Desired ✓ | Quantity of Markers | Part Number | Legend Color | Backgrnd Color | Style | Length of Marker | Conduit O.D. Range (In.) |
|----------------|---------------------|-------------|--------------|----------------|-------|------------------|--------------------------|
|                |                     | GPCV-ROY    | BLACK        | ORANGE         | R     | 8"               | .75" - 2.25"             |
|                |                     | GPCV-MOY    | BLACK        | ORANGE         | M     | 14"              | 2.50" - 6.00"            |
|                |                     | GPCV-RYY    | BLACK        | YELLOW         | R     | 8"               | .75" - 2.25"             |
|                |                     | GPCV-MYY    | BLACK        | YELLOW         | M     | 14"              | 2.50" - 6.00"            |

Print Legend Required

Legend to fit on one line. Max. 19 characters including spaces.

**For Pricing and Lead Time Information, Contact Panduit Customer Service at 800-777-3300**

A. System Overview

B1. Cable Ties

B2. Cable Accessories

B3. Stainless Steel Ties

C1. Wiring Duct

C2. Surface Raceway

C3. Abrasion Protection

C4. Cable Management

D1. Terminals

D2. Power Connectors

D3. Grounding Connectors

E1. Labeling Systems

E2. Labels

E3. Pre-Printed & Write-On Markers

E4. Permanent Identification

E5. Lockout/Tagout & Safety Solutions

F. Index

A. System Overview

B1. Cable Ties

B2. Cable Accessories

B3. Stainless Steel Ties

C1. Wiring Duct

C2. Surface Raceway

C3. Abrasion Protection

C4. Cable Management

D1. Terminals

D2. Power Connectors

D3. Grounding Connectors

E1. Labeling Systems

E2. Labels

E3. Pre-Printed & Write-On Markers

E4. Permanent Identification

E5. Lockout/Tagout & Safety Solutions

F. Index

## Panduit Corp. Generic Utility Tapes Order Form

One Form per Generic Utility Tape Option  
**Fax orders to Panduit Corp., Attn: Customer Service (708) 570-3570**  
Generic Utility Tapes are Non-Returnable

Date: \_\_\_\_\_ Panduit Sales Rep: \_\_\_\_\_  
 From: \_\_\_\_\_ Distributor: \_\_\_\_\_  
 Telephone #: \_\_\_\_\_  
 End User: \_\_\_\_\_  
 \_\_\_\_\_  
 \_\_\_\_\_  
 \_\_\_\_\_  
 Telephone#/Fax#: \_\_\_\_\_ Distributor Contact: \_\_\_\_\_  
 Account #: \_\_\_\_\_ Telephone#/Fax#: \_\_\_\_\_  
 Account #: \_\_\_\_\_

### Generic Utility Tape Options

| Part Number | Material                      | Width        | Length        | Use                    | Min. Order Qty. | Order Increments |
|-------------|-------------------------------|--------------|---------------|------------------------|-----------------|------------------|
| GHTB3       | Polyethylene                  | 3.0" (76mm)  | 1,000' (305m) | Barricade              | 64              | 16               |
| GHTU3       | Polyethylene                  | 3.0" (76mm)  | 1,000' (305m) | Underground            | 64              | 16               |
| GHTU6       | Polyethylene                  | 6.0" (152mm) | 1,000' (305m) | Underground            | 32              | 8                |
| GHTDU3      | Polyethylene Encased Aluminum | 3.0" (76mm)  | 1,000' (305m) | Underground Detectable | 32              | 16               |
| GHTDU6      | Polyethylene Encased Aluminum | 6.0" (152mm) | 1,000' (305m) | Underground Detectable | 16              | 8                |

**ALL LEGENDS ARE BLACK      MAXIMUM OF TWO LINES OF TEXT      ROLLS ARE ON 3 INCH CORE**

Part Number: \_\_\_\_\_ Quantity: \_\_\_\_\_

Color: \_\_\_\_\_ (select from Blue, Green, Orange, Red, or Yellow)

Sketch Legend and/or Artwork Below:

Comments: \_\_\_\_\_  
 \_\_\_\_\_  
 \_\_\_\_\_

**For Pricing and Lead Time Information, Contact Panduit Customer Service at 800-777-3300**

## Panduit Corp. Generic Custom Engraved Marker Plate Order Form

One Form per Custom Engraved Marker Plate Option  
**Fax orders to Panduit Corp., Attn: Customer Service (708) 570-3570**  
**Custom Engraved Marker Plates are Non-Returnable**

Date: \_\_\_\_\_ Panduit Sales Rep: \_\_\_\_\_  
 From: \_\_\_\_\_ Distributor: \_\_\_\_\_  
 Telephone #: \_\_\_\_\_  
 End-User: \_\_\_\_\_  
 \_\_\_\_\_  
 \_\_\_\_\_  
 Telephone #: \_\_\_\_\_ Distributor Contact: \_\_\_\_\_  
 Telephone # / Fax #: \_\_\_\_\_  
 Account #: \_\_\_\_\_ Account #: \_\_\_\_\_

### Generic Custom Engraved Marker Plate Options

**1 – Material:**

1/16" Thick Acrylic

**2 – Select Mounting Method (Check One):**

- With Adhesive
- Screw Mounting Holes
- No Mounting Method

**3 – Select Color (Check One):**

- Black Text on White Marker Plate
- Black Text on Yellow Marker Plate
- White Text on Black Marker Plate
- White Text on Blue Marker Plate
- White Text on Green Marker Plate
- White Text on Red Marker Plate

**4 – Select Size (Check One):**

- 2.0" Wide x 1.0" High
- 3.0" Wide x 1.0" High
- 3.0" Wide x 2.5" High
- 4.0" Wide x 1.0" High
- 6.0" Wide x 3.0" High
- 8.5" Wide x 11.0" High

**5 – Print Custom Legend Below (3 Lines x 30 Characters Maximum):**

**6 – Specify Part Number:** \_\_\_\_\_  
 (See Table Below)

**7 – Specify Order Quantity:** \_\_\_\_\_

| Material                 | 2.0" x 1.0" | 3.0" x 1.0" | 3.0" x 2.5" | 4.0" x 1.0" | 6.0" X 3.0" | 8.5" X 11.0" |
|--------------------------|-------------|-------------|-------------|-------------|-------------|--------------|
| ACRYLIC WITH ADHESIVE    | GAP2010-A   | GAP3010-A   | GAP3025-A   | GAP4010-A   | GAP6030-A   | GAP85110-A   |
| ACRYLIC WITHOUT ADHESIVE | GAP2010     | GAP3010     | GAP3025     | GAP4010     | GAP6030     | GAP85110     |

**Comments:** \_\_\_\_\_

**For Pricing and Lead Time Information, Contact Customer Service at 800-777-3300**

A. System Overview

B1. Cable Ties

B2. Cable Accessories

B3. Stainless Steel Ties

C1. Wiring Duct

C2. Surface Raceway

C3. Abrasion Protection

C4. Cable Management

D1. Terminals

D2. Power Connectors

D3. Grounding Connectors

E1. Labeling Systems

E2. Labels

E3. Pre-Printed & Write-On Markers

E4. Permanent Identification

E5. Lockout/Tagout & Safety Solutions

F. Index

A. System Overview

## Wire Size Selection Guide

B1. Cable Ties

To use this guide place your wire or cable in the appropriate circle to determine wire, outside diameter.

The charts below indicate the approximate cable outside diameter or various electrical and communication cables.

B2. Cable Accessories

Diameter .10" (2.50mm)

Diameter .20" (5.10mm)

B3. Stainless Steel Ties

Diameter .28" (7.10mm)

C1. Wiring Duct

Diameter .54" (13.70mm)

C2. Surface Raceway

Diameter .94" (23.90mm)

C3. Abrasion Protection

C4. Cable Management

D1. Terminals

Diameter 1.40" (35.50mm)

D2. Power Connectors

D3. Grounding Connectors

E1. Labeling Systems

Diameter 1.90" (48.30mm)

E2. Labels

E3. Pre-Printed & Write-On Markers

E4. Permanent Identification

E5. Lockout/Tagout & Safety Solutions

F. Index

Diameter 2.40" (61.00mm)

### Electrical Cables

| Size     | Approximate Wire Outside Diameter In. (mm) |              |              |               |
|----------|--|--------------|--------------|---------------|
|          | TF   | THW          | TW           | TFN/THHN/THWN |
| 18 AWG   | .11 (2.80)                                 | .11 (2.80)   | .11 (2.80)   | .09 (2.30)    |
| 16 AWG   | .12 (3.00)                                 | .12 (3.00)   | .12 (3.00)   | .10 (2.50)    |
| 14 AWG   | .13 (3.30)                                 | .16 (4.10)   | .16 (4.10)   | .10 (2.50)    |
| 12 AWG   | .15 (3.80)                                 | .18 (4.60)   | .18 (4.60)   | .12 (3.00)    |
| 10 AWG   | .17 (4.30)                                 | .20 (5.10)   | .20 (5.10)   | .15 (3.80)    |
| 8 AWG    | .24 (6.10)                                 | .28 (7.10)   | .28 (7.10)   | .22 (5.60)    |
| 6 AWG    | .32 (8.10)                                 | .32 (8.10)   | .32 (8.10)   | .26 (6.60)    |
| 4 AWG    | .37 (9.40)                                 | .37 (9.40)   | .37 (9.40)   | .33 (8.40)    |
| 3 AWG    | .40 (10.20)                                | .40 (10.20)  | .40 (10.20)  | .36 (9.10)    |
| 2 AWG    | .43 (10.90)                                | .43 (10.90)  | .43 (10.90)  | .39 (9.90)    |
| 1AWG     | .51 (12.90)                                | .51 (12.90)  | .51 (12.90)  | .45 (11.40)   |
| 1/0      | .55 (14.00)                                | .55 (14.00)  | .55 (14.00)  | .49 (12.40)   |
| 2/0      | .59 (15.00)                                | .59 (15.00)  | .59 (15.00)  | .54 (13.70)   |
| 3/0      | .65 (16.50)                                | .65 (16.50)  | .65 (16.50)  | .59 (15.00)   |
| 4/0      | .70 (17.80)                                | .70 (17.80)  | .70 (17.80)  | .65 (16.50)   |
| 250 MCM  | .79 (20.10)                                | .79 (20.10)  | .79 (20.10)  | .72 (18.30)   |
| 300 MCM  | .84 (21.30)                                | .84 (21.30)  | .84 (21.30)  | .77 (19.60)   |
| 350 MCM  | .89 (22.60)                                | .89 (22.60)  | .89 (22.60)  | .82 (20.80)   |
| 400 MCM  | .94 (23.90)                                | .94 (23.90)  | .94 (23.90)  | .87 (22.10)   |
| 500 MCM  | 1.03 (26.20)                               | 1.03 (26.20) | 1.03 (26.20) | .95 (24.10)   |
| 600 MCM  | 1.14 (29.00)                               | 1.14 (29.00) | 1.14 (29.00) | 1.06 (26.90)  |
| 700 MCM  | 1.21 (30.70)                               | 1.21 (30.70) | 1.21 (30.70) | 1.13 (28.70)  |
| 750 MCM  | 1.25 (31.80)                               | 1.25 (31.80) | 1.25 (31.80) | 1.16 (29.50)  |
| 800 MCM  | 1.28 (32.50)                               | 1.28 (32.50) | 1.28 (32.50) | 1.20 (30.50)  |
| 900 MCM  | 1.34 (34.00)                               | 1.34 (34.00) | 1.34 (34.00) | 1.26 (32.00)  |
| 1000 MCM | 1.40 (35.60)                               | 1.40 (35.60) | 1.40 (35.60) | 1.32 (33.50)  |
| 1250 MCM | 1.58 (40.10)                               | 1.58 (40.10) | 1.58 (40.10) |               |
| 1500 MCM | 1.70 (43.20)                               | 1.70 (43.20) | 1.70 (43.20) |               |
| 1750 MCM | 1.82 (46.20)                               | 1.82 (46.20) | 1.82 (46.20) |               |
| 2000 MCM | 1.92 (48.80)                               | 1.92 (48.80) | 1.92 (48.80) |               |

### Category 3, Category 5/5e/6 and 6a Cable

| Size     | Category 3             |                       | Category 5/5e/6       |                       |                       |
|----------|------------------------|-----------------------|-----------------------|-----------------------|-----------------------|
|          | Voice Grade 24 AWG UTP | Data Grade 24 AWG UTP | Data Grade 24 AWG STP | Data Grade 22 AWG UTP | Data Grade 22 AWG STP |
| 2-Pair   | .12 (3.00)             |                       |                       |                       |                       |
| 3-Pair   | .15 (3.80)             |                       |                       |                       |                       |
| 4-Pair   | .19 (4.80)             | .22 (5.60)            | .25 (6.30)            | .23 (5.80)            | .29 (7.40)            |
| 25-Pair  |                        | .42 (10.70)           | .51 (12.90)           | .54 (13.70)           | .63 (16.00)           |
| 50-Pair  | .46 (11.70)            | .66 (16.80)           |                       |                       |                       |
| 100-Pair | .63 (16.00)            | .96 (24.40)           |                       |                       |                       |
| 300-Pair | 1.07 (27.20)           |                       |                       |                       |                       |

### Coaxial Cable

| Size    | Coax        |
|---------|-------------|
| RG58/u  | .19 (4.80)  |
| RG59/u  | .24 (6.10)  |
| RG62A/u | .24 (6.10)  |
| RG6/u   | .27 (6.80)  |
| RG11/u  | .40 (10.20) |

### Fiber Optic Distribution (62.5/125)

| Size      | Non-Plenum  | Plenum      |
|-----------|-------------|-------------|
| 6 Strand  | .26 (6.60)  | .18 (4.60)  |
| 8 Strand  | .27 (6.90)  | .18 (4.60)  |
| 12 Strand | .28 (7.10)  | .21 (5.30)  |
| 18 Strand | .49 (12.4)  | .47 (11.90) |
| 24 Strand | .54 (13.70) | .52 (13.2)  |
| 36 Strand | .54 (13.70) | .52 (13.2)  |
| 48 Strand | .59 (15.00) | .56 (14.2)  |
| 72 Strand | .72 (18.30) | .71 (18.0)  |





A.  
System  
Overview

B1.  
Cable Ties

B2.  
Cable  
Accessories

B3.  
Stainless  
Steel Ties

C1.  
Wiring  
Duct

C2.  
Surface  
Raceway

C3.  
Abrasion  
Protection

C4.  
Cable  
Management

D1.  
Terminals

D2.  
Power  
Connectors

D3.  
Grounding  
Connectors

E1.  
Labeling  
Systems

E2.  
Labels

E3.  
Pre-Printed  
& Write-On  
Markers

E4.  
Permanent  
Identification

E5.  
Lockout/  
Tagout  
& Safety  
Solutions

F.  
Index

## NOTES

| Part Number   | Page Number |
|---------------|-------------|
| <b>A</b>      |             |
| A1C12-A-C8    | B2.32       |
| A1C25-A-C8    | B2.32       |
| A1C38-A-C8    | B2.32       |
| A1C50-A-C8    | B2.32       |
| A2C12-A-C8    | B2.33       |
| A2C25-A-C8    | B2.33       |
| A2C38-A-C8    | B2.33       |
| A2C50-A-C8    | B2.33       |
| ABM100-A-C    | B2.4        |
| ABM100-A-C15  | B2.4        |
| ABM100-AT-C   | B2.4        |
| ABM100-AT-C0  | B2.4        |
| ABM100-S6-C   | B2.5        |
| ABM100-S6-C69 | B2.5        |
| ABM112-A-C    | B2.4        |
| ABM112-AT-C   | B2.4        |
| ABM112-AT-C0  | B2.4        |
| ABM112-S6-C   | B2.5        |
| ABM112-S6-C69 | B2.5        |
| ABM1M-A-C     | B2.4        |
| ABM1M-AT-C    | B2.4        |
| ABM2S-A-C     | B2.4        |
| ABM2S-A-C14   | B2.4        |
| ABM2S-A-C15   | B2.4        |
| ABM2S-AT-C    | B2.4        |
| ABM2S-AT-C0   | B2.4        |
| ABM2S-S6-D    | B2.5        |
| ABM3H-A-L     | B2.4        |
| ABM3H-AT-L    | B2.4        |
| ABM3H-S6-T    | B2.5        |
| ABM4H-A-L     | B2.4        |
| ABM4H-AT-L    | B2.4        |
| ABM4H-S6-T    | B2.5        |
| ABMM-A-C      | B2.4        |
| ABMM-AT-C     | B2.4        |
| ABMM-AT-C0    | B2.4        |
| ABMM-D        | B2.5        |
| ABMQS-A-Q     | B2.6        |
| ABMQS-A-Q20   | B2.6        |
| ABMQS-AT-Q    | B2.6        |
| ABMQS-AT-Q0   | B2.6        |
| ABMQS-S6-C    | B2.6        |
| ABMQS-S6-C0   | B2.6        |
| ABMT-A-C      | B2.6, C4.13 |
| ABMT-A-C20    | B2.6, C4.13 |
| ABMT-S6-C     | B2.6, C4.13 |
| ABMT-S6-C20   | B2.6, C4.13 |
| ABMT-S6-C60   | B2.6, C4.13 |
| ABMT-S6-C69   | B2.6, C4.13 |
| ACC19-A-C     | B2.31       |
| ACC19-A-C20   | B2.31       |
| ACC19-AT-C    | B2.31       |
| ACC19-AT-C0   | B2.31       |
| ACC19-AV-M300 | B2.31       |
| ACC38-A-C     | B2.31       |
| ACC38-A-C20   | B2.31       |
| ACC38-AT-C    | B2.31       |
| ACC38-AT-C0   | B2.31       |
| ACC38-AV-M300 | B2.31       |
| ACC62-A-C     | B2.31       |
| ACC62-A-C20   | B2.31       |
| ACC62-AT-C    | B2.31       |
| ACC62-AT-C0   | B2.31       |
| ACC62-AV-D300 | B2.31       |
| ADCC31-AT-C10 | B2.36       |
| AJC12-A-C     | B2.32       |
| AJC19-A-C     | B2.32       |
| AJC25-A-C     | B2.32       |
| AJC31-A-C     | B2.32       |
| AJC38-A-C     | B2.32       |
| AM2-C         | B2.10       |
| AMC25-AT-C10  | B2.36       |
| ARC.68-A-Q    | B2.30       |
| ARC.68-A-Q14  | B2.30       |
| ARC.68-S6-Q   | B2.30       |

| Part Number         | Page Number  |
|---------------------|--------------|
| ARC.68-S6-Q14       | B2.30        |
| ASMS-A-X            | B2.9         |
| AST10-5-C100        | B2.28        |
| AST15-5-C100        | B2.28        |
| AST20-5-C100        | B2.28        |
| AST25-5-C100        | B2.28        |
| <b>ATMB</b>         | <b>B2.52</b> |
| <b>ATMC</b>         | <b>B2.52</b> |
| <b>ATMI-W187-X</b>  | <b>B2.52</b> |
| <b>ATMI-W250-X</b>  | <b>B2.52</b> |
| <b>ATMI-XMR-X</b>   | <b>B2.52</b> |
| <b>ATM-W187-M</b>   | <b>B2.52</b> |
| <b>ATMI-W250-X</b>  | <b>B2.52</b> |
| <b>ATMI-XMR-X</b>   | <b>B2.52</b> |
| <b>ATM-W187-M</b>   | <b>B2.52</b> |
| <b>ATM-W187-M20</b> | <b>B2.52</b> |
| <b>ATM-W187-M30</b> | <b>B2.52</b> |
| <b>ATM-W250-M</b>   | <b>B2.52</b> |
| <b>ATM-W250-M20</b> | <b>B2.52</b> |
| <b>ATM-W250-M30</b> | <b>B2.52</b> |
| <b>B</b>            |              |
| B2M2S-D             | B1.52        |
| B2M2S-D0            | B1.52        |
| B3M2S-TL            | B1.52        |
| B3M2S-TL0           | B1.52        |
| B4M2S-TL            | B1.52        |
| B4M2S-TL0           | B1.52        |
| BC1.5I-S8-M         | B1.48        |
| BC1.5I-S8-M0        | B1.49        |
| BC1M-S4-M           | B1.48        |
| BC1M-S4-M0          | B1.49        |
| BC2M-S4-M           | B1.48        |
| BC2M-S4-M0          | B1.49        |
| BC2S-S10-C          | B1.48        |
| BC2S-S10-C0         | B1.49        |
| BC3S-S10-D          | B1.48        |
| BC3S-S10-D0         | B1.49        |
| BC4LH-S25-L         | B1.48        |
| BC4LH-S25-L0        | B1.49        |
| BC4S-S10-C          | B1.48        |
| BC4S-S10-C0         | B1.49        |
| BC4S-S10-D30        | B1.49        |
| BEC38-A-L           | B2.35        |
| BEC38-A-L20         | B2.35        |
| BEC38-AT-L0         | B2.35        |
| BEC62-A-L           | B2.35        |
| BEC62-A-L20         | B2.35        |
| BEC62-AT-L0         | B2.35        |
| BEC75-A-L           | B2.35        |
| BEC75-A-L20         | B2.35        |
| BEC75-AT-L0         | B2.35        |
| BECP38H25-L         | B2.35        |
| BECP38H25-L20       | B2.35        |
| BECP75H25-L         | B2.35        |
| BECP75H25-L20       | B2.35        |
| BF1M-C              | B1.52        |
| BF1M-M0             | B1.52        |
| BF2M-C              | B1.52        |
| BF2M-M0             | B1.52        |
| BM1M-C              | B1.52        |
| BM1M-M0             | B1.52        |
| BM2M-C              | B1.52        |
| BM2M-M0             | B1.52        |
| BM2S-C              | B1.52        |
| BM2S-D0             | B1.52        |
| BM4S-C              | B1.52        |
| BM4S-D0             | B1.52        |
| BP2S-D0             | B1.52        |
| BPC1-X              | D2.117       |
| BPC1/0-X            | D2.117       |
| BPC2-L              | D2.117       |
| BPC2/0-X            | D2.117       |
| BPC250-X            | D2.117       |
| BPC3/0-X            | D2.117       |
| BPC300-X            | D2.117       |

| Part Number       | Page Number  |
|-------------------|--------------|
| BPC350-X          | D2.117       |
| BPC4-L            | D2.117       |
| BPC4/0-X          | D2.117       |
| BPC400-X          | D2.117       |
| BPC500-X          | D2.117       |
| BPC6-L            | D2.117       |
| BPC600-6          | D2.117       |
| BPC750-6          | D2.117       |
| BR-.50            | C4.9         |
| BR-.50-10-24      | C4.9         |
| BR-.75            | C4.9         |
| BR-1.25           | C4.9         |
| BR-1.25-1/4-20    | C4.9         |
| BR-1.25-10-24     | C4.9         |
| BR-1.25-14WS      | C4.9         |
| BR-1.5-PAF        | C4.9         |
| BR-1.5-SN         | C4.9         |
| BR-1.5-TW         | C4.9         |
| BR-2.0            | C4.9         |
| BR-2.0-1/4-20     | C4.9         |
| BR-2.0-10-24      | C4.9         |
| BR-2.0-14WS       | C4.9         |
| BR-2.0-PAF        | C4.9         |
| BR-2.0-SN         | C4.9         |
| BR-2.0-TW         | C4.9         |
| BR-4.0-1/4-20     | C4.9         |
| BR.5-E6-C         | B2.48        |
| BR.75-E6-C        | B2.48        |
| BR2-1.3-A-X       | B2.48        |
| BR2-1.3-X         | B2.48        |
| BR2-1.5-X         | B2.48        |
| BR2-4-X           | B2.48        |
| BR2-6-X           | B2.48        |
| BR-MPCL           | C4.9         |
| <b>BS10-L</b>     | <b>D1.66</b> |
| <b>BS100445</b>   | <b>D3.30</b> |
| <b>BS100445U</b>  | <b>D3.30</b> |
| <b>BS100645</b>   | <b>D3.30</b> |
| <b>BS100645U</b>  | <b>D3.30</b> |
| <b>BS100845</b>   | <b>D3.30</b> |
| <b>BS100845U</b>  | <b>D3.30</b> |
| <b>BS101245</b>   | <b>D3.30</b> |
| <b>BS101245U</b>  | <b>D3.30</b> |
| <b>BS14-C</b>     | <b>D1.66</b> |
| BS18-C            | D1.66        |
| <b>BS201246EU</b> | <b>D3.30</b> |
| <b>BS201846EU</b> | <b>D3.30</b> |
| <b>BS202446EU</b> | <b>D3.30</b> |
| BS22-C            | D1.66        |
| BSH10-E           | D1.68        |
| BSH14-Q           | D1.68        |
| BSH18-Q           | D1.68        |
| BSM1-C            | D1.69        |
| BSM2-C            | D1.69        |
| BSM6-L            | D1.69        |
| BSMN1-3K          | D1.139       |
| BSMN2-3K          | D1.139       |
| BSMN6-2K          | D1.139       |
| BSMP1-3K          | D1.139       |
| BSMP2-3K          | D1.139       |
| BSMV1BX-LY        | D1.68        |
| BSMV2BX-L         | D1.68        |
| BSMV6X-Q          | D1.68        |
| BSN10-2K          | D1.130       |
| BSN10-L           | D1.65        |
| BSN14-3K          | D1.130       |
| BSN14-C           | D1.65        |
| BSN18-3K          | D1.130       |
| BSN18-C           | D1.65        |
| BSN22-C           | D1.65        |
| BSP14-3K          | D1.130       |
| BSP18-3K          | D1.130       |
| BSV10X-Q          | D1.65        |
| BSV14X-L          | D1.65        |
| BSV18X-LY         | D1.65        |
| BT1.5I-C          | B1.45        |
| BT1.5I-C0         | B1.46        |

|                                       |
|---------------------------------------|
| A. System Overview                    |
| B1. Cable Ties                        |
| B2. Cable Accessories                 |
| B3. Stainless Steel Ties              |
| C1. Wiring Duct                       |
| C2. Surface Raceway                   |
| C3. Abrasion Protection               |
| C4. Cable Management                  |
| D1. Terminals                         |
| D2. Power Connectors                  |
| D3. Grounding Connectors              |
| E1. Labeling Systems                  |
| E2. Labels                            |
| E3. Pre-Printed & Write-On Markers    |
| E4. Permanent Identification          |
| E5. Lockout/Tagout & Safety Solutions |
| F. Index                              |

| A. System Overview                    | Part Number    | Page Number           | Part Number    | Page Number                | Part Number    | Page Number                      |
|---------------------------------------|----------------|-----------------------|----------------|----------------------------|----------------|----------------------------------|
| B1. Cable Ties                        | BT1.5I-M30     | B1.47                 | C038X038KCT    | E2.17                      | C120X190YK-22  | E2.19                            |
|                                       | BT1.5I-M39     | B1.47                 | C038X038YJJ    | E2.6                       | C125X025KBT    | E2.17                            |
|                                       | BT1.5M-C       | B1.45                 | C038X038YJT    | E2.17                      | C125X025KCT    | E2.17                            |
| B2. Cable Accessories                 | BT1.5M-C0      | B1.46                 | C038X038YLJ    | E2.6                       | C125X038YJT    | E2.18                            |
|                                       | BT1.5M-M30     | B1.47                 | C050X013KBT    | E2.17                      | C150X025KBT    | E2.18                            |
|                                       | BT1.5M-XMR0    | B1.116, B1.120        | C050X013KCT    | E2.17                      | C150X025KCT    | E2.18                            |
|                                       | BT1.5M-XMR30   | B1.116, B1.120        | C050X020KBT    | E2.17                      | C150X050YJJ    | E2.6                             |
|                                       | BT1M-C         | B1.45                 | C050X044CBT    | E2.17                      | C150X050YJT    | E2.18                            |
|                                       | BT1M-C0        | B1.46                 | C050X044KBT    | E2.17                      | C150X075CBT    | E2.18                            |
| B3. Stainless Steel Ties              | BT1M-C30       | B1.47                 | C050X044KCT    | E2.17                      | C150X075YJC    | E1.10                            |
|                                       | BT1M-M39       | B1.47                 | C050X044YJJ    | E2.6                       | C150X075YJJ    | E2.6                             |
|                                       | BT1M-XMR       | B1.55, B1.116, B1.120 | C050X044YJT    | E2.17                      | C150X075YJT    | E2.18                            |
|                                       | BT1M-XMR0      | B1.116, B1.120        | C060X020CBT    | E2.17                      | C150X075YMT    | E2.18                            |
| C1. Wiring Duct                       | BT1M-XMR30     | B1.116, B1.120        | C060X020KBT    | E2.17                      | C160X020CBT    | E2.18                            |
|                                       | BT2HT          | B3.26                 | C060X020KCT    | E2.17                      | C160X020KBT    | E2.18                            |
|                                       | BT2I-C         | B1.45                 | C060X020TJT    | E2.16                      | C160X020KCT    | E2.18                            |
|                                       | BT2I-C0        | B1.46                 | C060X020YJC    | E1.10                      | C160X020YJJ    | E2.6                             |
|                                       | BT2I-M30       | B1.47                 | C060X020YJJ    | E2.6                       | C160X020YJT    | E2.18                            |
|                                       | BT2LH-L        | B1.45                 | C060X020YJT    | E2.17                      | C180X180AOT-30 | E2.20                            |
|                                       | BT2LH-L0       | B1.46                 | C065X019KBT    | E2.17                      | C180X180A8T-30 | E2.20                            |
|                                       | BT2M-C         | B1.45                 | C065X019KCT    | E2.17                      | C180X180APT-30 | E2.20                            |
|                                       | BT2M-C0        | B1.46                 | C075X025AAT    | E2.19                      | C180X180AST-30 | E2.20                            |
|                                       | BT2M-M30       | B1.47                 | C075X025CBT    | E2.17                      | C180X180AWT-30 | E2.20                            |
| C2. Surface Raceway                   | BT2S-C         | B1.45                 | C075X025KBT    | E2.17                      | C180X180YK-30  | E2.20                            |
|                                       | BT2S-C0        | B1.46                 | C075X025KCT    | E2.17                      | C1LG6          | C1.13, C1.15, C1.17, C1.21       |
|                                       | BT2S-M30       | B1.47                 | C075X025YJJ    | E2.6                       | C2.5LG6        | C1.13, C1.15, C1.17              |
|                                       | BT2S-M39       | B1.47                 | C075X025YJT    | E2.17                      | C200X025KBT    | E2.18                            |
| C3. Abrasion Protection               | BT3I-C         | B1.45                 | C075X025YLJ    | E2.6                       | C200X025KCT    | E2.18                            |
|                                       | BT3I-C0        | B1.46                 | C080X020KBT    | E2.17                      | C200X025YJT    | E2.18                            |
|                                       | BT3I-M30       | B1.47                 | C080X020KCT    | E2.17                      | C200X038KBT    | E2.18                            |
| C4. Cable Management                  | BT3LH-L        | B1.45                 | C080X020YJJ    | E2.6                       | C200X038YJT    | E2.18                            |
|                                       | BT3LH-L0       | B1.46                 | C080X020YJT    | E2.17                      | C200X050CBC    | E1.10                            |
|                                       | BT3S-C         | B1.45                 | C090X025KBT    | E2.17                      | C200X050CBT    | E2.18                            |
|                                       | BT3S-C0        | B1.46                 | C090X025KCT    | E2.17                      | C200X050YJC    | E1.10                            |
|                                       | BT3S-M30       | B1.47                 | C090X025YJT    | E2.17                      | C200X050YJJ    | E2.6                             |
| D1. Terminals                         | BT3S-M39       | B1.47                 | C1.5LG6        | C1.13, C1.15, C1.17, C1.21 | C200X050YJT    | E2.18                            |
|                                       | BT4I-C         | B1.45                 | C100IG2        | C1.19                      | C200X100AOT    | E2.20                            |
|                                       | BT4I-C0        | B1.46                 | C100X019KBT    | E2.17                      | C200X100A8T    | E2.20                            |
| D2. Power Connectors                  | BT4LH-L        | B1.45                 | C100X019KCT    | E2.17                      | C200X100AAT    | E2.19                            |
|                                       | BT4LH-L0       | B1.46                 | C100X025CBT    | E2.17                      | C200X100AMT    | E2.20                            |
|                                       | BT4LH-TL30     | B1.47                 | C100X025KBT    | E2.17                      | C200X100APT    | E2.20                            |
|                                       | BT4LH-TL39     | B1.47                 | C100X025KCT    | E2.17                      | C200X100AST    | E2.20                            |
|                                       | BT4M-C         | B1.45                 | C100X025YJC    | E1.10                      | C200X100AWT    | E2.20                            |
|                                       | BT4M-C0        | B1.46                 | C100X025YJJ    | E2.6                       | C200X100FJJ    | E2.6                             |
| D3. Grounding Connectors              | BT4S-C         | B1.45                 | C100X025YJT    | E2.17                      | C200X100YJC    | E1.10, E5.41                     |
|                                       | BT4S-C0        | B1.46                 | C100X038CBT    | E2.17                      | C200X100YJJ    | E2.6, E5.41                      |
|                                       | BT4S-M30       | B1.47                 | C100X038KBT    | E2.17                      | C200X100YJT    | E2.18, E5.41                     |
|                                       | BT4S-M39       | B1.47                 | C100X038KCT    | E2.17                      | C200X100YK     | E2.20                            |
| E1. Labeling Systems                  | BT5LH-L        | B1.45                 | C100X038YJJ    | E2.6                       | C200X100YKT    | E2.18                            |
|                                       | BT5LH-L0       | B1.46                 | C100X038YJT    | E2.17                      | C200X100YLJ    | E2.5                             |
|                                       | BT6LH-L        | B1.45                 | C100X050AOT    | E2.20                      | C200X100YMC    | E1.10                            |
|                                       | BT6LH-L0       | B1.46                 | C100X050A8T    | E2.20                      | C200X100YMT    | E2.18                            |
|                                       | <b>BT75SDT</b> | <b>B3.26</b>          | C100X050AAT    | E2.19                      | C200X100YPC    | E1.10                            |
|                                       | BT7LH-L        | B1.45                 | C100X050AMT    | E2.20                      | C225X450FJJ    | E2.6                             |
| E2. Labels                            | BT7LH-L0       | B1.46                 | C100X050APT    | E2.20                      | C240X240AOT-30 | E2.20                            |
|                                       | BT8LH-L        | B1.45                 | C100X050AST    | E2.20                      | C240X240A8T-30 | E2.20                            |
|                                       | BT8LH-L0       | B1.46                 | C100X050AWT    | E2.20                      | C240X240APT-30 | E2.20                            |
|                                       | BT9LH-L        | B1.45                 | C100X050CBC    | E1.10                      | C240X240AST-30 | E2.20                            |
|                                       | BT9LH-L0       | B1.46                 | C100X050CBT    | E2.17                      | C240X240AWT-30 | E2.20                            |
| E3. Pre-Printed & Write-On Markers    | BW1.5I-D       | B1.50                 | C100X050YJC    | E1.10                      | C240X240YK-30  | E2.20                            |
|                                       | BW2S-D         | B1.50                 | C100X050YJJ    | E2.6                       | C25IG2         | C1.19                            |
|                                       | BW2S-D0        | B1.50                 | C100X050YJT    | E2.17                      | C275X125AAT    | E2.19                            |
|                                       | BW3S-D         | B1.50                 | C100X050YLJ    | E2.6                       | C275X125YJJ    | E2.6                             |
| E4. Permanent Identification          | BW3S-D0        | B1.50                 | C100X050YMC    | E1.10                      | C275X125YJT    | E2.18                            |
|                                       |                |                       | C100X075YJJ    | E2.6                       | C275X125YMT    | E2.18                            |
|                                       |                |                       | C100X150YJJ    | E2.6                       | C2LG6          | C1.9, C1.13, C1.15, C1.17, C1.21 |
|                                       |                |                       | C120X150AOT-22 | E2.19                      | C2WH6          | C1.9                             |
|                                       |                |                       | C120X150A8T-22 | E2.19                      | C2YL6          | C1.56                            |
|                                       |                |                       | C120X150APT-22 | E2.19                      | C300X025KBT    | E2.18                            |
|                                       |                |                       | C120X150AST-22 | E2.19                      | C300X025KCT    | E2.18                            |
|                                       |                |                       | C120X150AWT-22 | E2.19                      | C300X025YJT    | E2.18                            |
|                                       |                |                       | C120X150YK-22  | E2.19                      | C300X038YJJ    | E2.6                             |
|                                       |                |                       | C120X190AOT-22 | E2.19                      | C300X038YJT    | E2.18                            |
| E5. Lockout/Tagout & Safety Solutions |                |                       | C120X190A8T-22 | E2.19                      | C300X100AOT    | E2.20                            |
|                                       |                |                       | C120X190APT-22 | E2.19                      | C300X100A8T    | E2.20                            |
|                                       |                |                       | C120X190AST-22 | E2.19                      | C300X100APT    | E2.20                            |
|                                       |                |                       | C120X190AWT-22 | E2.19                      | C300X100YJJ    | E2.6                             |
|                                       |                |                       | C025X025KBT    | E2.17                      |                |                                  |
|                                       |                |                       | C025X025KCT    | E2.17                      |                |                                  |
| F. Index                              |                |                       | C025X025YJT    | E2.17                      |                |                                  |
|                                       |                |                       | C038X038KBT    | E2.17                      |                |                                  |

# PANDUIT® ELECTRICAL SOLUTIONS

| Part Number    | Page Number                |
|----------------|----------------------------|
| C300X100YJT    | E2.18                      |
| C300X100YMT    | E2.18                      |
| C300X200YJT    | E2.18                      |
| C300X200YMT    | E2.18                      |
| C300X250A0T    | E2.20                      |
| C300X250A8T    | E2.20                      |
| C300X250AMT    | E2.20                      |
| C300X250APT    | E2.20                      |
| C300X250AST    | E2.20                      |
| C300X250AWT    | E2.20                      |
| C300X250YK     | E2.20                      |
| C350X100YJJ    | E2.6                       |
| C350X500FJJ    | E2.6                       |
| C37IG2         | C1.19                      |
| C3LG6          | C1.13, C1.15, C1.17, C1.21 |
| C400X100A0T    | E2.20                      |
| C400X100A8T    | E2.20                      |
| C400X100AMT    | E2.20                      |
| C400X100APT    | E2.20                      |
| C400X100AST    | E2.20                      |
| C400X100AWT    | E2.20                      |
| C400X100CBT    | E2.18                      |
| C400X100YJJ    | E2.6                       |
| C400X100YJT    | E2.18                      |
| C400X100YK     | E2.20                      |
| C400X200YJJ    | E2.6                       |
| C400X200YJT    | E2.18                      |
| C400X200YMT    | E2.18                      |
| C400X300YJT    | E2.18                      |
| C400X400A11    | E5.40                      |
| C400X400A21    | E5.40                      |
| C400X400A31    | E5.40                      |
| C400X400YJJ    | E2.6                       |
| C400X400YJT    | E2.18                      |
| C400X600AX1    | E5.40                      |
| C400X600AY1    | E5.40                      |
| C400X600AZ1    | E5.40                      |
| C400X600PBT    | E2.18                      |
| C400X600Y81    | E5.40                      |
| C400X600YJT    | E2.18                      |
| C400X600YX1    | E5.40                      |
| C400X600YZ1    | E5.40                      |
| C4LG6          | C1.13, C1.15, C1.17, C1.21 |
| C4YL6          | C1.56                      |
| C500X700FJJ    | E2.6                       |
| C50IG2         | C1.19                      |
| C62IG2         | C1.19                      |
| C6LG6          | C1.13, C1.15, C1.21        |
| C-720          | D1.87, D3.37               |
| C75IG2         | C1.19                      |
| C788X050YJJ    | E2.6                       |
| C850X1100YJJ   | E2.6                       |
| C850X1100YLJ   | E2.6                       |
| CA-800EZ       | D1.143                     |
| CA10           | D1.143                     |
| CA3IW-X        | C2.82                      |
| CA5IW-X        | C2.82                      |
| CA-800EZ       | D1.143                     |
| CA9            | D1.143                     |
| CAMT           | B3.14                      |
| CB125-14-QY    | D2.139                     |
| CB175-38-QY    | D2.139                     |
| CB225-56-QY    | D2.139                     |
| CB25-18-CY     | D2.139                     |
| CB300-38-QY    | D2.139                     |
| CB35-36-CY     | D2.139                     |
| CB400-38-3Y    | D2.139                     |
| CB650-12-3Y    | D2.139                     |
| CB70-14-CY     | D2.139                     |
| CBA70-14-CY    | D2.139                     |
| CBLS18-C       | B2.46                      |
| CBLS25-C       | B2.46                      |
| CBLS37-C       | B2.46                      |
| CBLS50-C       | B2.46                      |
| CBLS62-C       | B2.46                      |
| CBLS75-C       | B2.46                      |
| <b>CBOT24K</b> | <b>B1.92</b>               |

| Part Number      | Page Number  |
|------------------|--------------|
| CBP100-C         | B2.46        |
| CBP12-C          | B2.46        |
| CBP25-C          | B2.46        |
| CBP31-C          | B2.46        |
| CBP37-C          | B2.46        |
| CBP50-C          | B2.46        |
| CBP62-C          | B2.46        |
| CBP75-C          | B2.46        |
| CBP87-C          | B2.46        |
| CBR1M-M          | B1.58        |
| CBR1M-M0         | B1.59        |
| CBR1M-M30        | B1.60        |
| CBR1.5I-M        | B1.58        |
| CBR1.5I-M0       | B1.59        |
| CBR1.5I-M30      | B1.60        |
| CBR1.5M-M        | B1.58        |
| CBR1.5M-M0       | B1.59        |
| CBR2HS-D         | B1.58        |
| CBR2HS-D0        | B1.59        |
| CBR2M-M          | B1.58        |
| CBR2M-M0         | B1.59        |
| CBR2S-M          | B1.58        |
| CBR2S-M0         | B1.59        |
| CBR2S-M30        | B1.60        |
| CBR2S-M39        | B1.60        |
| CBR3I-M          | B1.58        |
| CBR3I-M0         | B1.59        |
| CBR3S-M          | B1.58        |
| CBR3S-M0         | B1.59        |
| <b>CBR3S-M30</b> | <b>B1.60</b> |
| CBR3S-M69        | B1.60        |
| CBR4I-M          | B1.58        |
| CBR4I-M0         | B1.59        |
| CBR4LH-TL        | B1.58        |
| CBR4LH-TL0       | B1.59        |
| CBR4LH-TL30      | B1.60        |
| CBR4S-M          | B1.58        |
| CBR4S-M0         | B1.59        |
| CBR4S-M30        | B1.60        |
| CBR6LH-C         | B1.58        |
| CBR6LH-C0        | B1.59        |
| CBR6LH-C30       | B1.60        |
| CC-720           | D1.87, D3.37 |
| CCH100-S10-C     | B2.40        |
| CCH112-S10-C     | B2.40        |
| CCH119-S10-C     | B2.40        |
| CCH125-S10-C     | B2.40        |
| CCH12-S10-C      | B2.40        |
| CCH138-S10-C     | B2.40        |
| CCH150-S10-C     | B2.40        |
| CCH19-S10-C      | B2.40        |
| CCH25-S10-C      | B2.40        |
| CCH31-S10-C      | B2.40        |
| CCH38-S10-C      | B2.40        |
| CCH44-S10-C      | B2.40        |
| CCH50-S10-C      | B2.40        |
| CCH56-S10-C      | B2.40        |
| CCH62-S10-C      | B2.40        |
| CCH69-S10-C      | B2.40        |
| CCH75-S10-C      | B2.40        |
| CCH81-S10-C      | B2.40        |
| CCH87-S10-C      | B2.40        |
| CCMKIT1          | C4.14        |
| CCMKIT2          | C4.14        |
| CCS12-S8-C       | B2.40        |
| CCS19-S8-C       | B2.40        |
| CCS25-S10-C      | B2.40        |
| CCS25-S8-C       | B2.40        |
| CCS31-S8-C       | B2.40        |
| CCS38-S8-C       | B2.40        |
| CCS44-S8-C       | B2.40        |
| CCS50-S8-C       | B2.40        |
| CCT-320          | D3.39        |
| CCT-500          | D3.39        |
| CD125-14-QY      | D2.138       |
| CD-2001-1        | D3.42        |
| CD-2001-1/0      | D3.42        |

| Part Number        | Page Number    |
|--------------------|----------------|
| CD-2001-2          | D3.42          |
| CD-2001-2/0        | D3.42          |
| CD-2001-250        | D3.42          |
| CD-2001-3/0        | D3.42          |
| CD-2001-300        | D3.42          |
| CD-2001-350        | D3.42          |
| CD-2001-4          | D3.42          |
| CD-2001-4/0        | D3.42          |
| CD-2001-400        | D3.42          |
| CD-2001-500        | D3.42          |
| CD-2001-6          | D3.42          |
| CD-2001-8          | D3.42          |
| CD-2001-BG         | D3.42          |
| CD-2001-C          | D3.42          |
| CCS12-S8-C         | B2.40          |
| CCS19-S8-C         | B2.40          |
| CCS25-S10-C        | B2.40          |
| CCS25-S8-C         | B2.40          |
| CCS31-S8-C         | B2.40          |
| CCS38-S8-C         | B2.40          |
| CCS44-S8-C         | B2.40          |
| CCS50-S8-C         | B2.40          |
| CD10-1             | D1.143, D1.146 |
| CD10-2             | D1.143, D1.146 |
| CD10-3             | D1.143, D1.146 |
| CD225-56-QY        | D2.138         |
| CD125-14-QY        | D2.138         |
| CD35-36-QY         | D2.138         |
| CD70-14-QY         | D2.138         |
| CD300-38-3Y        | D2.138         |
| CD400-38-3Y        | D2.138         |
| CD650-12-3Y        | D2.138         |
| <b>CD-2600-P2</b>  | <b>D1.89</b>   |
| <b>CD-2600-P4</b>  | <b>D1.89</b>   |
| <b>CD-2600-P6</b>  | <b>D1.89</b>   |
| <b>CD-2600-P8</b>  | <b>D1.89</b>   |
| <b>CD-2600-PV2</b> | <b>D1.89</b>   |
| <b>CD-2600-PV4</b> | <b>D1.89</b>   |
| <b>CD-2600-PV6</b> | <b>D1.89</b>   |
| <b>CD-2600-PV8</b> | <b>D1.89</b>   |
| CD-525             | D1.88          |
| CD-550             | D1.88          |
| CD-570             | D1.88          |
| CD-720-1           | D3.37          |
| CD-720-2           | D3.37          |
| CD-720-3           | D3.37          |
| CD-720-4           | D3.37          |
| CD-720-5           | D3.37          |
| CD-720-6           | D3.37          |
| CD-720-7           | D3.37          |
| CD-720PV8-2        | D3.37          |
| CD-800-1           | D1.145         |
| CD-800-10          | D1.145         |
| CD-800-11          | D1.145         |
| CD-800-12          | D1.145         |
| CD-800-13          | D1.145         |
| CD-800-14          | D1.145         |
| CD-800-15          | D1.145         |
| CD-800-16          | D1.145         |
| CD-800-17          | D1.145         |
| CD-800-18          | D1.145         |
| CD-800-1D          | D1.145         |
| CD-800-2           | D1.145         |
| CD-800-2D          | D1.145         |
| CD-800-3           | D1.145         |
| CD-800-4           | D1.145         |
| CD-800-5           | D1.145         |
| CD-800-6           | D1.145         |
| CD-800-7           | D1.145         |
| CD-800-8           | D1.145         |
| CD-800-9           | D1.145         |
| CD-920-1           | D3.50          |
| CD-920-1/0         | D3.50          |
| CD-920-2           | D3.50          |
| CD-920-2/0         | D3.50          |
| CD-920-250         | D3.50          |
| CD-920-3/0         | D3.50          |

|  |
|--|
| A. System Overview                     |
| B1. Cable Ties                         |
| B2. Cable Accessories                  |
| B3. Stainless Steel Ties               |
| C1. Wiring Duct                        |
| C2. Surface Raceway                    |
| C3. Abrasion Protection                |
| C4. Cable Management                   |
| D1. Terminals                          |
| D2. Power Connectors                   |
| D3. Grounding Connectors               |
| E1. Labeling Systems                   |
| E2. Labels                             |
| E3. Pre-Printed & Write-On Markers     |
| E4. Permanent Identification           |
| E5. Lockout/ Tagout & Safety Solutions |
| F. Index                               |



# PANDUIT® ELECTRICAL SOLUTIONS

| A. System Overview                    | Part Number  | Page Number | Part Number     | Page Number         | Part Number | Page Number           |
|---------------------------------------|--------------|-------------|-----------------|---------------------|-------------|-----------------------|
| B1. Cable Ties                        | CD-920-300   | D3.50       | CF5IW-E         | C2.79               | CLTS100N-C  | C3.13                 |
|                                       | CD-920-350   | D3.50       | CF752575F-Q     | C3.14               | CLTS125F-L  | C3.12                 |
|                                       | CD-920-4     | D3.50       | CF753875F-Q     | C3.14               | CLTS125F-L3 | C3.12                 |
|                                       | CD-920-4/0   | D3.50       | CFX10IW-X       | C2.75, C2.80, C2.81 | CLTS125N-L  | C3.13                 |
| B2. Cable Accessories                 | CD-920-400   | D3.50       | CFX3IW-X        | C2.80, C2.81        | CLTS150F-D  | C3.12                 |
|                                       | CD-920-500   | D3.50       | CFX5IW-X        | C2.80, C2.81        | CLTS150F-D3 | C3.12                 |
|                                       | CD-920-500A  | D3.50       | CG-920          | D3.55               | CLTS25F-10M | C3.12                 |
|                                       | CD-920-6     | D3.50       | CG-940          | D3.55               | CLTS25F-C   | C3.12                 |
|                                       | CD-920-600   | D3.50       | CG-980          | D3.55               | CLTS25F-C3  | C3.12                 |
|                                       | CD-920-750   | D3.50       | CH105-A-C14     | B2.37               | CLTS25N-10M | C3.13                 |
|                                       | CD-920-8     | D3.50       | CH105-S6-C14    | B2.37               | CLTS25N-C   | C3.13                 |
|                                       | CD-920-BG    | D3.50       | CLRCVR1-1       | D3.13               | CLTS35F-C   | C3.12                 |
| B3. Stainless Steel Ties              | CD-920-C     | D3.50       | CLRCVR2-1       | D3.13               | CLTS35F-C3  | C3.12                 |
|                                       | CD-920-D3    | D3.50       | CLRCVR3-1       | D3.13               | CLTS35N-C   | C3.13                 |
|                                       | CD-920-O     | D3.50       | CLT100F-125M20  | C3.12               | CLTS38F-C   | C3.12                 |
|                                       | CD-930G-1/0  | D3.50       | CLT100F-C20     | C3.12               | CLTS38F-C3  | C3.12                 |
| C1. Wiring Duct                       | CD-930G-250  | D3.50       | CLT100F-C3      | C3.12               | CLTS38N-C   | C3.13                 |
|                                       | CD-930G-500  | D3.50       | CLT100F-C4      | C3.12               | CLTS50F-C   | C3.12                 |
|                                       | CD-920H-2    | D3.50       | CLT100F-X4      | C3.12               | CLTS50F-C3  | C3.12                 |
|                                       | CD-920H-6    | D3.50       | CLT100N-125M630 | C3.13               | CLTS50N-C   | C3.13                 |
| C2. Surface Raceway                   | CD-930H-250  | D3.50       | CLT100N-C630    | C3.13               | CLTS62F-C   | C3.12                 |
|                                       | CD-940-1000  | D3.51       | CLT125N-.75M630 | C3.13               | CLTS62F-C3  | C3.12                 |
|                                       | CD-940-1000A | D3.51       | CLT125F-L20     | C3.12               | CLTS62N-C   | C3.13                 |
|                                       | CD-940-750   | D3.51       | CLT125F-L3      | C3.12               | CLTS75F-2M  | C3.12                 |
| C3. Abrasion Protection               | CD-940-750A  | D3.51       | CLT125F-L4      | C3.12               | CLTS75F-C   | C3.12                 |
|                                       | CD-940-750X  | D3.51       | CLT125F-.75M20  | C3.12               | CLTS75F-C3  | C3.12                 |
|                                       | CD-940-800   | D3.51       | CLT125N-L630    | C3.13               | CLTS75N-2M  | C3.13                 |
|                                       | CD-940-800A  | D3.51       | CLT150F-D20     | C3.12               | CLTS75N-C   | C3.13                 |
| C4. Cable Management                  | CD-940-DA    | D3.51       | CLT150F-D3      | C3.12               | CM4S-L2     | B1.80                 |
|                                       | CD9-10A      | D1.146      | CLT150F-D4      | C3.12               | CM4S-L8     | B1.80                 |
|                                       | CD9-10B      | D1.146      | CLT150F-T20     | C3.12               | CMP-100-1   | D2.118, D2.155, D3.24 |
|                                       | CD9-11A      | D1.146      | CLT150F-X20     | C3.12               | CMP-200-1   | D2.118, D3.24         |
|                                       | CD9-11B      | D1.146      | CLT150F-X3      | C3.12               | CMP-300-1   | D3.24                 |
|                                       | CD9-12A      | D1.146      | CLT150F-X4      | C3.12               | CMP-300-4-1 | D3.24                 |
|                                       | CD9-13B      | D1.146      | CLT150N-D630    | C3.13               | CMVDR1      | C4.13                 |
|                                       | CD9-14A      | D1.146      | CLT188F-X20     | C3.12               | CMVDR1S     | C4.13                 |
|                                       | CD9-15A      | D1.146      | CLT188F-X3      | C3.12               | CMVDR2      | C4.13                 |
|                                       | CD9-16A      | D1.146      | CLT188F-X4      | C3.12               | CMVDR2S     | C4.13                 |
| D1. Terminals                         | CD9-17B      | D1.146      | CLT188N-6C630   | C3.13               | CMVDRC      | C4.13                 |
|                                       | CD9-18B      | D1.146      | CLT25F-10M20    | C3.11               | CMW-KIT     | C4.11                 |
|                                       | CD9-1A       | D1.146      | CLT25F-C20      | C3.11               | CMW2B       | C4.11                 |
|                                       | CD9-1AD      | D1.146      | CLT25F-C3       | C3.11               | CMWB        | C4.11                 |
| D2. Power Connectors                  | CD9-1B       | D1.146      | CLT25F-C4       | C3.11               | CMWW        | C4.11                 |
|                                       | CD9-2A       | D1.146      | CLT25N-10M630   | C3.13               | CO125-14-QY | D2.140                |
|                                       | CD9-2AD      | D1.146      | CLT25N-C630     | C3.13               | CO225-56-QY | D2.140                |
|                                       | CD9-2B       | D1.146      | CLT35F-7M20     | C3.11               | CO300-38-3Y | D2.140                |
| D3. Grounding Connectors              | CD9-3B       | D1.146      | CLT35F-C20      | C3.11               | CO35-36-QY  | D2.140                |
|                                       | CD9-4A       | D1.146      | CLT35F-C3       | C3.11               | CO400-38-3Y | D2.140                |
|                                       | CD9-4B       | D1.146      | CLT35F-C4       | C3.11               | CO650-12-3Y | D2.140                |
|                                       | CD9-5A       | D1.146      | CLT35N-C630     | C3.13               | CO70-14-QY  | D2.140                |
|                                       | CD9-5B       | D1.146      | CLT38F-5M20     | C3.11               | CP-871      | D1.144                |
|                                       | CD9-6B       | D1.146      | CLT38F-C20      | C3.11               | CP106IW     | C2.60                 |
|                                       | CD9-7A       | D1.146      | CLT38F-C3       | C3.11               | CP106IW-2G  | C2.60                 |
|                                       | CD9-8B       | D1.146      | CLT38F-C4       | C3.11               | CPGIW       | C2.60                 |
| E1. Labeling Systems                  | CD9-9C       | D1.146      | CLT38N-5M630    | C3.13               | CPGIW-2G    | C2.60                 |
|                                       | CDCLP3       | C1.9        | CLT38N-C630     | C3.13               | CPH.75-S8-X | B2.48                 |
|                                       | CDCLP4       | C1.9        | CLT50F-4M20     | C3.11               | CPL.75-S8-X | B2.48                 |
|                                       | CDLB3        | C1.9        | CLT50F-C20      | C3.11               | CPM122S-C   | B2.23                 |
| E2. Labels                            | CDLB4        | C1.9        | CLT50F-C3       | C3.11               | CPM87S-C    | B2.23                 |
|                                       | CDM-2001-1   | D3.42       | CLT50F-C4       | C3.11               | CPNIW       | C2.60                 |
|                                       | CDM-2001-1/0 | D3.42       | CLT50N-4M630    | C3.13               | CPNIW-2G    | C2.60                 |
|                                       | CDM-2001-2   | D3.42       | CLT50N-C630     | C3.13               | CR2-M       | B2.26                 |
| E3. Pre-Printed & Write-On Markers    | CDM-2001-2/0 | D3.42       | CLT62F-2.5M20   | C3.11               | CR4H-M      | B2.26                 |
|                                       | CDM-2001-3/0 | D3.42       | CLT62F-C20      | C3.11               | CR4H-M0     | B2.26                 |
|                                       | CDM-920-1    | D3.50       | CLT62F-C3       | C3.11               | CRFC5IW-X   | C2.79, C2.80          |
|                                       | CDM-920-1/0  | D3.50       | CLT62F-C4       | C3.11               | CRFX5IW-X   | C2.81                 |
| E4. Permanent Identification          | CDM-920-2    | D3.50       | CLT62N-2.5M630  | C3.13               | CROS-M      | B2.26                 |
|                                       | CDM-920-2/0  | D3.50       | CLT62N-C630     | C3.13               | CRS1-125-X  | C4.12                 |
|                                       | CDM-920-250  | D3.50       | CLT75F-2M20     | C3.12               | CRS1-X      | C4.12                 |
|                                       | CDM-920-250  | D3.50       | CLT75F-C20      | C3.12               | CRS4-125-X  | C4.12                 |
| E5. Lockout/Tagout & Safety Solutions | CDM-920-3/0  | D3.50       | CLT75F-C3       | C3.11               | CRS6-X      | C4.12                 |
|                                       | CDM-920-4/0  | D3.50       | CLT75F-C4       | C3.12               | CS125-14-QY | D2.137                |
|                                       | CEFXIW-X     | C2.81       | CLT75N-2M630    | C3.13               | CS175-38-QY | D2.137                |
|                                       | CF10IW-X     | C2.79       | CLT75N-C630     | C3.13               | CS1LG6      | C1.30                 |
| F. Index                              | CF382538F-Q  | C3.14       | CLTS100F-1.25M  | C3.12               | CS225-56-QY | D2.137                |
|                                       | CF3IW-E      | C2.79       | CLTS100F-C      | C3.12               | CS25-18-CY  | D2.137                |
|                                       | CF502550F-Q  | C3.14       | CLTS100F-C3     | C3.12               | CS300-38-QY | D2.137                |
|                                       | CF503850F-Q  | C3.14       |                 |                     |             |                       |
|                                       |              |             |                 |                     |             |                       |
|                                       |              |             |                 |                     |             |                       |



| Part Number       | Page Number   |
|-------------------|---------------|
| CS35-36-CY        | D2.137        |
| CS400-38-3Y       | D2.137        |
| CS650-12-3Y       | D2.137        |
| CS70-14-CY        | D2.137        |
| CSA70-14-CY       | D2.137        |
| CSC1LG6           | C1.29         |
| CSCS-M            | B2.27         |
| CSH-D0            | B2.26         |
| CSH-D20           | B2.26         |
| CSM-1.25-C        | C4.10         |
| CST101            | D3.38         |
| CST114-157        | D3.38         |
| CST114-157B       | D3.38         |
| CST115            | D1.83, D3.38  |
| CT-1              | D1.85         |
| CT-100A           | D1.83         |
| CT-1000           | D1.86, D1.142 |
| CT-1002           | D1.85         |
| CT-1003           | D1.85         |
| CT-1004           | D1.85         |
| CT-1005           | D1.85         |
| CT-1006           | D1.85         |
| CT-1014           | D1.84         |
| CT-1015           | D1.84         |
| CT-1104           | D1.85         |
| CT-1123           | D1.85         |
| CT-1525           | D1.84         |
| CT-1550           | D1.84         |
| CT-1551           | D1.84         |
| CT-1570           | D1.84         |
| CT-160            | D1.83         |
| CT-1700           | D1.84         |
| CT-1701           | D1.84         |
| CT-200            | D1.83         |
| <b>CT-2002/L</b>  | <b>D3.41</b>  |
| CT-2500           | D1.88         |
| CT-2500/E         | D1.88         |
| CT-2500BC         | D1.88, D1.89  |
| CT-2500CASE       | D1.88         |
| CT-2500CHR        | D1.88, D1.89  |
| CT-2500CHR/E      | D1.88, D1.89  |
| CT-2525CH         | D1.88         |
| CT-2550CH         | D1.88         |
| CT-2570CH         | D1.88         |
| CT-260            | D1.83         |
| <b>CT-2600</b>    | <b>D1.89</b>  |
| <b>CT-2600/E</b>  | <b>D1.89</b>  |
| <b>CT-2930/L</b>  | <b>D3.43</b>  |
| <b>CT-2930/LE</b> | <b>D3.43</b>  |
| <b>CT-2940/L</b>  | <b>D3.44</b>  |
| <b>CT-2940/LE</b> | <b>D3.44</b>  |
| <b>CT-2980/L</b>  | <b>D3.53</b>  |
| <b>CT-2980/LE</b> | <b>D3.53</b>  |
| CT-300-1          | D1.85         |
| <b>CT-3001</b>    | <b>D3.40</b>  |
| <b>CT-3001/E</b>  | <b>D3.40</b>  |
| CT-310            | D1.85         |
| CT-400            | D1.86         |
| CT-460            | D1.86         |
| CT-500CH          | D1.86         |
| CT-520CH          | D1.86         |
| CT-550CH          | D1.86         |
| CT-570CH          | D1.86         |
| CT-600-A          | D1.86         |
| CT-720            | D1.87, D3.37  |
| CT-720-3          | D3.38         |
| CT-720-3CC        | D3.38         |
| CT-720-7          | D3.38         |
| CT-720-7CC        | D3.38         |
| CT-8250HP         | D3.49         |
| CT-900HPH         | D3.47         |
| CT-900LPHPH       | D3.49         |
| CT-901HP          | D3.47         |
| CT-901RCH         | D3.47         |
| CT-901RFS         | D3.49, D3.47  |
| CT-930            | D3.39         |
| CT-930CH          | D3.45         |

| Part Number         | Page Number    |
|---------------------|----------------|
| CT-930LPCH          | D3.48          |
| CT-940CH            | D3.46          |
| CT-980              | D3.52          |
| CT-980CH            | D3.54          |
| CT-980LPCH          | D3.54          |
| <b>CT-LIBCKIT</b>   | <b>D3.55</b>   |
| <b>CT-LIBCKIT/E</b> | <b>D3.55</b>   |
| <b>CT-LIBA</b>      | <b>D3.55</b>   |
| CTAP2-2-X           | D3.12          |
| CTAP2-4-Q           | D3.12          |
| CTAP2/0-2-X         | D3.12          |
| CTAP2/0-2/0-X       | D3.12          |
| CTAP4-4-L           | D3.12          |
| CTAP4-6-L           | D3.12          |
| CTAP4-8-L           | D3.12          |
| CTAP4/0-2-X         | D3.12          |
| CTAP4/0-2/0-X       | D3.12          |
| CTAP4/0-4/0-X       | D3.12          |
| CTAPF1-12-C         | D3.11          |
| CTAPF1/0-12-L       | D3.11          |
| CTAPF10-16-C        | D3.11          |
| CTAPF2-12-C         | D3.11          |
| CTAPF2/0-12-Q       | D3.11          |
| CTAPF3-12-C         | D3.11          |
| CTAPF3/0-12-Q       | D3.11          |
| CTAPF4-12-C         | D3.11          |
| CTAPF6-12-C         | D3.11          |
| CTAPF8-12-C         | D3.11          |
| <b>CTH19U04-C30</b> | <b>B2.44</b>   |
| <b>CTH35U8-C30</b>  | <b>B2.44</b>   |
| <b>CTH38U10-C30</b> | <b>B2.44</b>   |
| <b>CTH50U13-C30</b> | <b>B2.44</b>   |
| <b>CTH62U17-C30</b> | <b>B2.44</b>   |
| <b>CTH87U22-C30</b> | <b>B2.44</b>   |
| CVR1000-1           | D3.13          |
| CVR2-1              | D3.13          |
| CVR250-1            | D3.13          |
| CVR500-1            | D3.13          |
| CVR6-1              | D3.13          |
| CW-12-Q             | D2.114, D2.155 |
| CW-14-L             | D2.114, D2.155 |
| CW-38-L             | D2.114, D2.155 |
| CW-56-L             | D2.114, D2.155 |
| CW-58-Q             | D2.114, D2.155 |
| CWD3                | C1.35          |
| CWD3LG6             | C1.9           |
| CWD3WH6             | C1.9           |
| CWD4                | C1.35          |
| CWD4LG6             | C1.9           |
| CWD4WH6             | C1.9           |
| CWF400              | C4.10          |
| CX125-14-QY         | D2.136         |
| CX125-56T-QY        | D2.136         |
| CX225-38T-QY        | D2.136         |
| CX225-56-QY         | D2.136         |
| CX225-56T-QY        | D2.136         |
| CX35-36-CY          | D2.136         |
| CX35-36T-CY         | D2.136         |
| CX400-12T-3Y        | D2.142         |
| CX400-38-3Y         | D2.142         |
| CX70-14-CY          | D2.136         |
| CX70-14T-CY         | D2.136         |

## D

|             |       |
|-------------|-------|
| D-250A-C    | D1.51 |
| D1.5X3LG6   | C1.17 |
| D1.5X4LG6   | C1.17 |
| D10-250-L   | D1.49 |
| D10-250M-L  | D1.53 |
| D14-145M-C  | D1.55 |
| D14-187-C   | D1.49 |
| D14-188-C   | D1.49 |
| D14-250-C   | D1.49 |
| D14-250MB-C | D1.53 |
| D18-145M-C  | D1.55 |
| D18-187-C   | D1.49 |

| Part Number     | Page Number  |
|-----------------|--------------|
| D18-188-C       | D1.49        |
| D18-250-C       | D1.49        |
| D18-250MB-C     | D1.53        |
| D1X2LG6         | C1.17        |
| D1X3LG6         | C1.17        |
| D1X4LG6         | C1.17        |
| D2.5X3LG6       | C1.17        |
| D2H6            | C1.26        |
| D2HWH6          | C1.26        |
| D2X2LG6         | C1.17        |
| D2X3LG6         | C1.17        |
| D2X4LG6         | C1.17        |
| D3H6            | C1.26        |
| D3HWH6          | C1.26        |
| D3X2LG6         | C1.17        |
| D3X3LG6         | C1.17        |
| D3X4LG6         | C1.17        |
| D4H6            | C1.26        |
| D4HWH6          | C1.26        |
| D4X2LG6         | C1.17        |
| D4X3LG6         | C1.17        |
| D4X4LG6         | C1.17        |
| DB-C            | C1.26        |
| DC450-38-3Y     | D2.145       |
| DC600-38-3Y     | D2.145       |
| DC800-12-3Y     | D2.145       |
| DCEF3IW-X       | C2.80, C2.81 |
| DCF10IW-X       | C2.79        |
| DCF3IW-X        | C2.79        |
| DCF5IW-X        | C2.79        |
| DCT             | C1.34        |
| DCT-BLD         | C1.34        |
| DCT-RI          | C1.34        |
| DFCT            | C1.34        |
| DHC1.12X1.75-D0 | B1.78        |
| DM1-488-C       | D1.58        |
| DM1-63-C        | D1.58        |
| DM1-63M-C       | D1.60        |
| DM2-488-C       | D1.58        |
| DM2-63-C        | D1.58        |
| DM2-63M-C       | D1.60        |
| DM6-63-L        | D1.58        |
| DM6-63M-L       | D1.60        |
| DMNF1-283FIB-3K | D1.133       |
| DMNF1-285-C     | D1.58        |
| DMNF1-285FIB-3K | D1.133       |
| DMNF1-285FIB-C  | D1.57        |
| DMNF1-288-C     | D1.58        |
| DMNF1-288FIB-3K | D1.133       |
| DMNF1-288FIB-C  | D1.57        |
| DMNF1-485FIB-3K | D1.133       |
| DMNF1-488-C     | D1.58        |
| DMNF1-488FIB-3K | D1.133       |
| DMNF1-488FIB-C  | D1.57        |
| DMNF1-63-C      | D1.58        |
| DMNF1-63FIB-3K  | D1.133       |
| DMNF1-63FIB-C   | D1.57        |
| DMNF1-63FIBX-2K | D1.134       |
| DMNF1-63FIM-2K  | D1.136       |
| DMNF1-63FIM-L   | D1.59        |
| DMNF1-63FIMB-K  | D1.136       |
| DMNF1-63FIMX-2K | D1.137       |
| DMNF1-63M-3K    | D1.137       |
| DMNF1-63M-C     | D1.59        |
| DMNF1485FIBX-2K | D1.134       |
| DMNF1488FIBX-2K | D1.134       |
| DMNF2-288-C     | D1.58        |
| DMNF2-485FIB-3K | D1.133       |
| DMNF2-488-C     | D1.58        |
| DMNF2-488FIB-3K | D1.133       |
| DMNF2-488FIB-C  | D1.57        |
| DMNF2-63-C      | D1.58        |
| DMNF2-63FIB-3K  | D1.133       |
| DMNF2-63FIB-C   | D1.57        |
| DMNF2-63FIBX-2K | D1.134       |
| DMNF2-63FIM-2K  | D1.136       |
| DMNF2-63FIM-L   | D1.59        |

A.  
System  
Overview

B1.  
Cable Ties

B2.  
Cable  
Accessories

B3.  
Stainless  
Steel Ties

C1.  
Wiring  
Duct

C2.  
Surface  
Raceway

C3.  
Abrasion  
Protection

C4.  
Cable  
Management

D1.  
Terminals

D2.  
Power  
Connectors

D3.  
Grounding  
Connectors

E1.  
Labeling  
Systems

E2.  
Labels

E3.  
Pre-Printed  
& Write-On  
Markers

E4.  
Permanent  
Identification

E5.  
Lockout/  
Tagout  
& Safety  
Solutions

F.  
Index

# PANDUIT® ELECTRICAL SOLUTIONS

| A. System Overview                    | Part Number     | Page Number  | Part Number     | Page Number  | Part Number     | Page Number |
|---------------------------------------|-----------------|--------------|-----------------|--------------|-----------------|-------------|
| B1. Cable Ties                        | DMNF2-63FIMB-K  | D1.136       | DNF14-250FI-L   | D1.45        | DNG18-187FB-3K  | D1.122      |
|                                       | DMNF2-63FIMX-2K | D1.137       | DNF14-250FIB-3K | D1.123       | DNG18-187FB-C   | D1.43       |
|                                       | DMNF2-63M-3K    | D1.137       | DNF14-250FIB-C  | D1.44, D1.45 | DNG18-188FB-3K  | D1.122      |
| B2. Cable Accessories                 | DMNF2-63M-C     | D1.59        | DNF14-250FIM-2K | D1.128       | DNG18-188FB-C   | D1.43       |
|                                       | DMNF6-63FI-L    | D1.57        | DNF14-250FIM-L  | D1.44        | DNG18-250FB-3K  | D1.122      |
|                                       | DMNF6-63M-L     | D1.59        | DNF14-250FIMB-K | D1.128       | DNG18-250FB-L   | D1.43       |
|                                       | DMNF2485FIBX-2K | D1.134       | DNF14-250FIMB-Q | D1.44        | DNG18-250FL-3K  | D1.123      |
|                                       | DMNF2488FIBX-2K | D1.134       | DNF14-250M-3K   | D1.129       | DNG18-250FL-L   | D1.44       |
|                                       | DMNF6-63FI-L    | D1.57        | DNF14-250M-C    | D1.52        | DNH10-250FI-E   | D1.47       |
| B3. Stainless Steel Ties              | DMNF6-63FIB-2K  | D1.133       | DNF14205FIBX-2K | D1.124       | DNH14-250FIB-Q  | D1.47       |
|                                       | DMNF6-63M-2K    | D1.137       | DNF14206FIBX-2K | D1.124       | DNH14-250FIM-Q  | D1.47       |
|                                       | DMNF6-63M-L     | D1.59        | DNF14206FIBX-L  | D1.45        | DNH18-250FIB-Q  | D1.47       |
| C1. Wiring Duct                       | DMNFR1485FIB-KD | D1.134       | DNF14250FIBX-2K | D1.124       | DNH18-250FIM-Q  | D1.47       |
|                                       | DMNFR1488FIB-KD | D1.134       | DNF14250FIBX-L  | D1.45        | DNT-100         | C1.34       |
|                                       | DMNFR163FIB-KD  | D1.134       | DNF14250FIMX-2K | D1.128       | DPF10-250FI-L   | D1.46       |
| C2. Surface Raceway                   | DMNFR2485FIB-KD | D1.134       | DNF18-110-C     | D1.47        | DPF10-250FIB-2K | D1.126      |
|                                       | DMNFR2488FIB-KD | D1.134       | DNF18-110FIB-3K | D1.123       | DPF10-250FIB-L  | D1.46       |
|                                       | DMNG1-485FB-3K  | D1.132       | DNF18-110FIB-C  | D1.45        | DPF14-187FIB-3K | D1.126      |
| C3. Abrasion Protection               | DMNG1-63FB-3K   | D1.132       | DNF18-111-C     | D1.47        | DPF14-205FIB-3K | D1.126      |
|                                       | DMNG1-63FL-3K   | D1.133       | DNF18-111FIB-3K | D1.123       | DPF14-205FIB-C  | D1.46       |
|                                       | DMNG2-485FB-3K  | D1.132       | DNF18-111FIB-C  | D1.45        | DPF14-206FIB-3K | D1.126      |
|                                       | DMNG2-488FB-3K  | D1.132       | DNF18-112FIB-3K | D1.123       | DPF14-206FIB-C  | D1.46       |
|                                       | DMNG2-63FB-3K   | D1.132       | DNF18-187-C     | D1.47        | DPF14-250FIB-3K | D1.126      |
|                                       | DMNG2-63FL-3K   | D1.133       | DNF18-187FIB-3K | D1.123       | DPF14-250FIB-C  | D1.46       |
| C4. Cable Management                  | DMPF1-285FIB-3K | D1.135       | DNF18-187FIB-C  | D1.45        | DPF14-250FIM-2K | D1.127      |
|                                       | DMPF1-288FIB-3K | D1.135       | DNF18-188-C     | D1.47        | DPF14-250FIM-L  | D1.46       |
|                                       | DMPF1-485FIB-3K | D1.135       | DNF18-188FIB-3K | D1.123       | DPF14-250FIMB-K | D1.127      |
|                                       | DMPF1-488FIB-3K | D1.135       | DNF18-188FIB-C  | D1.45        | DPF14-250FIMB-Q | D1.46       |
|                                       | DMPF1-63FIB-3K  | D1.135       | DNF18-205-C     | D1.47        | DPF18-110FIB-3K | D1.126      |
|                                       | DMPF1-63FIM-2K  | D1.136       | DNF18-205FIB-3K | D1.123       | DPF18-110FIB-C  | D1.46       |
| D1. Terminals                         | DMPF1-63FIMB-K  | D1.136       | DNF18-205FIB-L  | D1.45        | DPF18-111FIB-3K | D1.126      |
|                                       | DMPF2-485FIB-3K | D1.135       | DNF18-206-C     | D1.47        | DPF18-111FIB-C  | D1.46       |
|                                       | DMPF2-488FIB-3K | D1.135       | DNF18-206FIB-3K | D1.123       | DPF18-187FIB-3K | D1.126      |
|                                       | DMPF2-63FIB-3K  | D1.135       | DNF18-206FIB-L  | D1.45        | DPF18-188FIB-3K | D1.126      |
|                                       | DMPF2-63FIM-2K  | D1.136       | DNF18-250-C     | D1.47        | DPF18-205FIB-3K | D1.126      |
|                                       | DMPF2-63FIMB-K  | D1.136       | DNF18-250FI-L   | D1.45        | DPF18-205FIB-C  | D1.46       |
| D2. Power Connectors                  | DMPF2-63FIMX-2K | D1.136       | DNF18-250FIB-3K | D1.123       | DPF18-206FIB-3K | D1.126      |
|                                       | DMPF6-63FIB-2K  | D1.135       | DNF18-250FIB-C  | D1.44, D1.45 | DPF18-206FIB-C  | D1.46       |
|                                       | DMV1-37MB-3K    | D1.139       | DNF18-250FIM-2K | D1.128       | DPF18-250FIB-3K | D1.126      |
|                                       | DMV1-485B-3K    | D1.135       | DNF18-250FIM-L  | D1.44        | DPF18-250FIB-C  | D1.46       |
|                                       | DMV1-488B-3K    | D1.135       | DNF18-250FIMB-K | D1.128       | DPF18-250FIM-2K | D1.127      |
|                                       | DMV1-63B-3K     | D1.135       | DNF18-250FIMB-L | D1.44        | DPF18-250FIM-L  | D1.46       |
| D3. Grounding Connectors              | DMV1-63MB-3K    | D1.138       | DNF18-250M-3K   | D1.129       | DPF18-250FIMB-K | D1.127      |
|                                       | DMV1-63P-LY     | D1.59        | DNF18-250M-C    | D1.52        | DPF18-250FIMB-L | D1.46       |
|                                       | DMV2-37MB-3K    | D1.139       | DNF18205FIBX-2K | D1.124       | DR10-250-L      | D1.50       |
|                                       | DMV2-485B-3K    | D1.135       | DNF18205FIBX-L  | D1.45        | DR14-205-C      | D1.50       |
|                                       | DMV2-488B-3K    | D1.135       | DNF18206FIBX-2K | D1.124       | DR14-205B-C     | D1.51       |
|                                       | DMV2-63B-3K     | D1.135       | DNF18206FIBX-L  | D1.45        | DR14-206-C      | D1.50       |
| E1. Labeling Systems                  | DMV2-63MB-3K    | D1.138       | DNF18250FIBX-2K | D1.124       | DR14-206B-C     | D1.51       |
|                                       | DMV2-63P-L      | D1.59        | DNF18250FIBX-L  | D1.45        | DR14-250-C      | D1.50       |
|                                       | DMV6-63-2K      | D1.135       | DNF18250FIMX-2K | D1.128       | DR14-250B-C     | D1.51       |
|                                       | DMV6-63-L       | D1.58        | DNFR14-205B-L   | D1.50        | DR18-205-C      | D1.50       |
|                                       | DMV6-63M-2K     | D1.138       | DNFR14-205FIB-L | D1.49        | DR18-205B-C     | D1.51       |
|                                       | DNF10-250FI-L   | D1.44, D1.45 | DNFR14-206B-L   | D1.50        | DR18-206-C      | D1.50       |
| E2. Labels                            | DNF10-250FIB-2K | D1.123       | DNFR14-206FIB-L | D1.49        | DR18-206B-C     | D1.51       |
|                                       | DNF10-250FIB-L  | D1.45        | DNFR14-250B-L   | D1.50        | DR18-250-C      | D1.50       |
|                                       | DNF10-250FIMB-K | D1.128       | DNFR14-250FIB-L | D1.49        | DR18-250B-C     | D1.51       |
|                                       | DNF10-250FIMB-Q | D1.44        | DNFR14205FIB-KD | D1.124       | <b>DRD22LG6</b> | <b>C1.5</b> |
|                                       | DNF10-250M-2K   | D1.129       | DNFR14206FIB-KD | D1.124       | <b>DRD33LG6</b> | <b>C1.5</b> |
|                                       | DNF10-250M-L    | D1.52        | DNFR14250FIB-KD | D1.124       | <b>DRD44LG6</b> | <b>C1.5</b> |
| E3. Pre-Printed & Write-On Markers    | DNF10250FIBC-2K | D1.123       | DNFR18-205B-L   | D1.50        | <b>DRDC2LG6</b> | <b>C1.5</b> |
|                                       | DNF14-110-C     | D1.47        | DNFR18-205FIB-L | D1.49        | <b>DRDC3LG6</b> | <b>C1.5</b> |
|                                       | DNF14-111-C     | D1.47        | DNFR18-206B-L   | D1.50        | <b>DRDC4LG6</b> | <b>C1.5</b> |
|                                       | DNF14-187-C     | D1.47        | DNFR18-206FIB-L | D1.49        | <b>DRDCS2-X</b> | <b>C1.5</b> |
|                                       | DNF14-187FIB-3K | D1.123       | DNFR18-250B-L   | D1.50        | <b>DRDCS3-X</b> | <b>C1.5</b> |
|                                       | DNF14-187FIB-C  | D1.45        | DNFR18-250FIB-L | D1.49        | <b>DRDCS4-X</b> | <b>C1.5</b> |
| E4. Permanent Identification          | DNF14-188-C     | D1.47        | DNFR18205FIB-KD | D1.124       | <b>DRDSF-C</b>  | <b>C1.5</b> |
|                                       | DNF14-188FIB-3K | D1.123       | DNFR18206FIB-KD | D1.124       | <b>DRDWR2-X</b> | <b>C1.5</b> |
|                                       | DNF14-188FIB-C  | D1.45        | DNFR18250FIB-KD | D1.124       | <b>DRDWR3-X</b> | <b>C1.5</b> |
|                                       | DNF14-205-C     | D1.47        | DNG14-187FB-3K  | D1.122       | <b>DRDWR4-X</b> | <b>C1.5</b> |
|                                       | DNF14-205FIB-3K | D1.123       | DNG14-187FB-L   | D1.43        | DS1             | C3.18       |
|                                       | DNF14-205FIB-C  | D1.45        | DNG14-188FB-3K  | D1.122       | DS5             | C3.18       |
| E5. Lockout/Tagout & Safety Solutions | DNF14-206-C     | D1.47        | DNG14-188FB-L   | D1.43        | DSF-NP          | D1.144      |
|                                       | DNF14-206FIB-3K | D1.123       | DNG14-250FB-3K  | D1.122       | DSF-RS          | D1.144      |
|                                       | DNF14-206FIB-C  | D1.45        | DNG14-250FB-L   | D1.43        | DT14EH-L0       | B1.53       |
|                                       | DNF14-206-C     | D1.47        | DNG14-250FL-3K  | D1.123       | DT15EH-L0       | B1.53       |
|                                       | DNF14-206FIB-3K | D1.123       | DNG14-250FL-L   | D1.44        | DT28EH-C0       | B1.53       |
|                                       | DNF14-206FIB-C  | D1.45        |                 |              |                 |             |
| F. Index                              | DNF14-250-C     | D1.47        |                 |              |                 |             |

| Part Number   | Page Number |
|---------------|-------------|
| DT44EH-C0     | B1.53       |
| DT4EH-L0      | B1.53       |
| DT8EH-Q0      | B1.53       |
| DTHEH-Q0      | B1.53       |
| DTHH-Q0       | B1.53       |
| DTKEH-0       | B1.53       |
| DTKH-0        | B1.53       |
| DTREH-LR0     | B1.53       |
| DTRH-LR0      | B1.53       |
| DV10-250-2K   | D1.125      |
| DV10-250-L    | D1.48       |
| DV10-250C-2K  | D1.125      |
| DV10-250M-2K  | D1.129      |
| DV10-250M-L   | D1.52       |
| DV14-145M-C   | D1.55       |
| DV14-145MB-3K | D1.130      |
| DV14-187B-3K  | D1.125      |
| DV14-187B-C   | D1.48       |
| DV14-188B-3K  | D1.125      |
| DV14-188B-C   | D1.48       |
| DV14-205B-3K  | D1.125      |
| DV14-205B-C   | D1.48       |
| DV14-206B-3K  | D1.125      |
| DV14-206B-C   | D1.48       |
| DV14-250B-3K  | D1.125      |
| DV14-250B-C   | D1.48       |
| DV14-250MB-3K | D1.129      |
| DV14-250MB-C  | D1.52       |
| DV14-250P-L   | D1.51       |
| DV18-145M-CY  | D1.55       |
| DV18-145MB-3K | D1.130      |
| DV18-187B-3K  | D1.125      |
| DV18-187B-CY  | D1.48       |
| DV18-188B-3K  | D1.125      |
| DV18-188B-CY  | D1.48       |
| DV18-205B-3K  | D1.125      |
| DV18-205B-CY  | D1.48       |
| DV18-206B-3K  | D1.125      |
| DV18-206B-CY  | D1.48       |
| DV18-250B-3K  | D1.125      |
| DV18-250B-CY  | D1.48       |
| DV18-250MB-3K | D1.129      |
| DV18-250MB-CY | D1.52       |
| DV18-250P-LY  | D1.51       |
| DVF14-187-C   | D1.48       |
| DVF14-188-C   | D1.48       |
| DVF14-205-C   | D1.48       |
| DVF14-206-C   | D1.48       |
| DVF14-250-C   | D1.48       |
| DVF18-187-CY  | D1.48       |
| DVF18-188-CY  | D1.48       |
| DVF18-205-CY  | D1.48       |
| DVF18-206-CY  | D1.48       |
| DVF18-250-CY  | D1.48       |

## E

|                  |                     |
|------------------|---------------------|
| E2X2YL6          | C1.56               |
| E4X4YL6          | C1.56               |
| ECF10IW-X        | C2.79               |
| ECF3IW-E         | C2.79               |
| ECF5IW-E         | C2.79               |
| ECFX10IW-X       | C2.75, C2.80, C2.81 |
| ECFX3IW-X        | C2.80, C2.81        |
| ECFX5IW-X        | C2.80, C2.81        |
| EDU20IW-X        | C2.61               |
| EEFXIW           | C2.75               |
| EGU20IW-X        | C2.61               |
| EMA-X            | B2.9                |
| EMS-A-C          | B2.9                |
| EMS-A-C0         | B2.9                |
| EMSK12-4-12-X0   | B2.9                |
| EMSK3-1-3-0      | B2.9                |
| EMSK3-1-X0       | B2.9                |
| ER.5-E4-X        | B2.47               |
| ER1.25-E4-X      | B2.47               |
| <b>ERT2M-C20</b> | <b>B1.91</b>        |

| Part Number        | Page Number  |
|--------------------|--------------|
| <b>ERT3M-C20</b>   | <b>B1.91</b> |
| <b>ERT4.5M-C20</b> | <b>B1.91</b> |
| ERU20IW-X          | C2.61        |
| ETU20IW-X          | C2.61        |

## F

|               |       |
|---------------|-------|
| F.5X.5LG6     | C1.15 |
| F.5X.5LG6-A   | C1.33 |
| F.5X1LG6      | C1.15 |
| F.5X1LG6-A    | C1.33 |
| F.75X.75LG6   | C1.15 |
| F.75X.75LG6-A | C1.33 |
| F.75X1.5LG6   | C1.15 |
| F.75X1.5LG6-A | C1.33 |
| F1.5X1.5LG6   | C1.11 |
| F1.5X1.5LG6-A | C1.33 |
| F1.5X1LG6     | C1.15 |
| F1.5X1LG6-A   | C1.33 |
| F1.5X2LG6     | C1.15 |
| F1.5X2LG6-A   | C1.33 |
| F1.5X3LG6     | C1.15 |
| F1.5X3LG6-A   | C1.33 |
| F1.5X3WH6-A   | C1.33 |
| F1.5X4LG6     | C1.15 |
| F1.5X4LG6-A   | C1.33 |
| F1.5X4WH6-A   | C1.33 |
| F100X150AJC   | E1.7  |
| F14PN-L       | C1.59 |
| F14PWN-L      | C1.59 |
| F1X1.5LG6     | C1.15 |
| F1X1.5LG6A    | C1.33 |
| F1X1LG6       | C1.15 |
| F1X1LG6-A     | C1.33 |
| F1X2LG6       | C1.15 |
| F1X2LG6-A     | C1.33 |
| F1X2WH6-A     | C1.33 |
| F1X3LG6       | C1.15 |
| F1X3LG6-A     | C1.33 |
| F1X3WH6-A     | C1.33 |
| F1X4LG6       | C1.15 |
| F1X4LG6-A     | C1.33 |
| F1X4WH6-A     | C1.33 |
| F2.5X3LG6     | C1.15 |
| F2PCLB12      | C1.61 |
| F2PCLB58      | C1.61 |
| F2X1.5LG6     | C1.15 |
| F2X1.5LG6-A   | C1.33 |
| F2X1LG6       | C1.15 |
| F2X1LG6-A     | C1.33 |
| F2X2LG6       | C1.15 |
| F2X2LG6-A     | C1.33 |
| F2X2WH6-A     | C1.33 |
| F2X3LG6       | C1.15 |
| F2X3LG6-A     | C1.33 |
| F2X3WH6-A     | C1.33 |
| F2X4LG6       | C1.15 |
| F2X4LG6-A     | C1.33 |
| F2X4WH6-A     | C1.33 |
| F2X5LG6       | C1.15 |
| F2X5LG6A      | C1.33 |
| F3X1LG6       | C1.15 |
| F3X1LG6A      | C1.33 |
| F3X2LG6       | C1.15 |
| F3X2LG6-A     | C1.33 |
| F3X3LG6       | C1.15 |
| F3X3LG6-A     | C1.33 |
| F3X3WH6-A     | C1.33 |
| F3X4LG6       | C1.15 |
| F3X4LG6-A     | C1.33 |
| F3X4WH6-A     | C1.33 |
| F3X5LG6       | C1.15 |
| F3X5LG6-A     | C1.33 |
| F4X2LG6       | C1.15 |
| F4X2LG6-A     | C1.33 |
| F4X3LG6       | C1.15 |
| F4X3LG6-A     | C1.33 |

| Part Number    | Page Number  |
|----------------|--------------|
| F4X3WH6-A      | C1.33        |
| F4X4LG6        | C1.15        |
| F4X4LG6-A      | C1.33        |
| F4X4WH6-A      | C1.33        |
| F4X5LG6        | C1.15        |
| F4X5LG6-A      | C1.33        |
| <b>F6X4LG6</b> | <b>C1.15</b> |
| F73-5-M        | D1.76        |
| F73-7-M        | D1.76        |
| F74-5-M        | D1.76        |
| F74-7-M        | D1.76        |
| F75-10-M       | D1.76        |
| F75-6-M        | D1.76        |
| F75-8-M        | D1.76        |
| F76-10-M       | D1.76        |
| F76-12-M       | D1.76        |
| F76-6-M        | D1.76        |
| F76-8-M        | D1.76        |
| F77-10-M       | D1.76        |
| F77-12-M       | D1.76        |
| F77-6-M        | D1.76        |
| F77-7-M        | D1.76        |
| F77-8-M        | D1.76        |
| F78-10-M       | D1.76        |
| F78-12-M       | D1.76        |
| F78-15-M       | D1.76        |
| F78-18-M       | D1.76        |
| F78-20-M       | D1.76        |
| F78-7-M        | D1.76        |
| F78-8-M        | D1.76        |
| F80-10-M       | D1.77        |
| F80-12-M       | D1.77        |
| F80-15-M       | D1.77        |
| F80-18-M       | D1.77        |
| F80-20-M       | D1.77        |
| F80-7-M        | D1.77        |
| F80-8-M        | D1.77        |
| F81-10-M       | D1.77        |
| F81-12-M       | D1.77        |
| F81-15-M       | D1.77        |
| F81-18-M       | D1.77        |
| F81-20-M       | D1.77        |
| F81-9-M        | D1.77        |
| F82-10-M       | D1.77        |
| F82-12-M       | D1.77        |
| F82-15-M       | D1.77        |
| F82-18-M       | D1.77        |
| F82-20-M       | D1.77        |
| F83-12-D       | D1.77        |
| F83-15-D       | D1.77        |
| F83-18-D       | D1.77        |
| F83-20-D       | D1.77        |
| F83-25-D       | D1.77        |
| F84-12-TL      | D1.77        |
| F84-15-TL      | D1.77        |
| F84-18-TL      | D1.77        |
| F84-20-TL      | D1.77        |
| F84-25-TL      | D1.77        |
| F84-32-TL      | D1.77        |
| F85-12-C       | D1.77        |
| F85-15-C       | D1.77        |
| F85-18-C       | D1.77        |
| F85-25-C       | D1.77        |
| F85-32-C       | D1.77        |
| F86-18-C       | D1.77        |
| F86-20-C       | D1.77        |
| F86-25-C       | D1.77        |
| F86-32-C       | D1.77        |
| F87-18-C       | D1.77        |
| F87-22-C       | D1.77        |
| F87-25-C       | D1.77        |
| F87-32-C       | D1.77        |
| FBA10IW-X      | C2.79        |
| FBA5IW-X       | C2.79        |
| FCBI1-A-C20    | B2.25        |
| FCBI1-S10-C20  | B2.25        |
| FCBI2-A-C20    | B2.25        |

A.  
System  
Overview

B1.  
Cable Ties

B2.  
Cable  
Accessories

B3.  
Stainless  
Steel Ties

C1.  
Wiring  
Duct

C2.  
Surface  
Raceway

C3.  
Abrasion  
Protection

C4.  
Cable  
Management

D1.  
Terminals

D2.  
Power  
Connectors

D3.  
Grounding  
Connectors

E1.  
Labeling  
Systems

E2.  
Labels

E3.  
Pre-Printed  
& Write-On  
Markers

E4.  
Permanent  
Identification

E5.  
Lockout/  
Tagout  
& Safety  
Solutions

F.  
Index

# PANDUIT® ELECTRICAL SOLUTIONS

| A. System Overview                    | Part Number    | Page Number | Part Number   | Page Number   | Part Number | Page Number |
|---------------------------------------|----------------|-------------|---------------|---------------|-------------|-------------|
| B1. Cable Ties                        | FCBI2-S10-C20  | B2.25       | FS1X4LG6NM    | C1.21         | FSD86-16-L  | D1.73       |
|                                       | FCBI3-A-C20    | B2.25       | FS2X1.5LG6NM  | C1.21         | FSD86-18-L  | D1.73       |
|                                       | FCBI3-S10-C20  | B2.25       | FS2X1LG6NM    | C1.21         | FSD86-25-L  | D1.73       |
| B2. Cable Accessories                 | FCC-A-C8       | B2.39       | FS2X2LG6NM    | C1.21         | FSD87-20-L  | D1.73       |
|                                       | FCC5-A-C8      | B2.39       | FS2X3LG6NM    | C1.21         | FSD87-25-Q  | D1.73       |
|                                       | FCF2X2YL       | C1.56       | FS2X4LG6NM    | C1.21         | FSF72-6-D   | D1.74       |
|                                       | FCF4X4YL       | C1.56       | FS3X1LG6NM    | C1.21         | FSF72-8-D   | D1.74       |
|                                       | FCH2-A-C14     | B2.38       | FS3X2LG6NM    | C1.21         | FSF73-6-D   | D1.74       |
|                                       | FCH2-S6-C14    | B2.38       | FS3X3LG6NM    | C1.21         | FSF73-8-D   | D1.74       |
| B3. Stainless Steel Ties              | FCM1-A-C14     | B2.38       | FS3X4LG6NM    | C1.21         | FSF74-6-D   | D1.74       |
|                                       | FCM1-S6-C14    | B2.38       | FS3X5LG6NM    | C1.21         | FSF74-8-D   | D1.74       |
|                                       | FCM1.2-A-C14   | B2.38       | FS4X2LG6NM    | C1.21         | FSF75-10-D  | D1.74       |
|                                       | FCM1.2-S6-C14  | B2.38       | FS4X3LG6NM    | C1.21         | FSF75-6-D   | D1.74       |
|                                       | FCM2-A-C14     | B2.38       | FS4X4LG6NM    | C1.21         | FSF75-8-D   | D1.74       |
|                                       | FCM2-S6-C14    | B2.38       | FS4X5LG6NM    | C1.21         | FSF76-10-D  | D1.74       |
| C1. Wiring Duct                       | FCM3.25-A-L14  | B2.38       | FS6X4LG6-A    | C1.33         | FSF76-12-D  | D1.74       |
|                                       | FCM3.25-S6-L14 | B2.38       | FS6X4LG6NM    | C1.21         | FSF76-6-D   | D1.74       |
|                                       | FCPI1-C20      | B2.25       | FS75-8-5K3    | D1.142        | FSF76-8-D   | D1.74       |
| C2. Surface Raceway                   | FCPI2-C20      | B2.25       | FS75-8-DSL3   | D1.75, D1.141 | FSF77-10-D  | D1.74       |
|                                       | FCPI3-C20      | B2.25       | FS76-8-5K10   | D1.142        | FSF77-12-D  | D1.74       |
|                                       | FEC2X2YL       | C1.57       | FS76-8-5K7    | D1.142        | FSF77-6-D   | D1.74       |
|                                       | FEC4X4YL       | C1.57       | FS76-8-DSL10  | D1.75, D1.141 | FSF77-8-D   | D1.74       |
|                                       | FEIAB58        | C1.61       | FS76-8-DSL7   | D1.75, D1.141 | FSF78-10-D  | D1.74       |
|                                       | FFWC2X2YL      | C1.57       | FS77-8-5K4    | D1.142        | FSF78-12-D  | D1.74       |
| C3. Abrasion Protection               | FFWC4X4YL      | C1.57       | FS77-8-DSL4   | D1.75, D1.141 | FSF78-18-D  | D1.74       |
|                                       | FG1EI5.0-A     | C2.83       | FS78-8-5K2    | D1.142        | FSF78-6-D   | D1.74       |
|                                       | FG1EI50.0-A    | C2.83       | FS78-8-DSL2   | D1.75, D1.141 | FSF78-8-D   | D1.74       |
|                                       | FG3EI5.0-A     | C2.83       | FS80-8-3K8    | D1.142        | FSF79-8-D   | D1.74       |
|                                       | FG3EI50.0-A    | C2.83       | FS80-8-DSL8   | D1.75, D1.141 | FSF80-12-D  | D1.74       |
|                                       | FG5EI25.0-A    | C2.83       | FSD72-6-D     | D1.73         | FSF80-18-D  | D1.74       |
| C4. Cable Management                  | FG5EI5.0-A     | C2.83       | FSD72-8-D     | D1.73         | FSF80-8-D   | D1.74       |
|                                       | FIDT2X2YL      | C1.58       | FSD73-6-D     | D1.73         | FSF81-10-D  | D1.74       |
|                                       | FIDT4X4BL      | C1.58       | FSD73-8-D     | D1.73         | FSF81-12-C  | D1.74       |
|                                       | FITF4X4B       | C1.59       | FSD74-6-D     | D1.73         | FSF81-18-C  | D1.74       |
|                                       | FIV452X2YL     | C1.57       | FSD74-8-D     | D1.73         | FSF82-12-C  | D1.74       |
|                                       | FIV454X4YL     | C1.57       | FSD75-10-D    | D1.73         | FSF82-18-C  | D1.74       |
| D1. Terminals                         | FIVRA2X2YL     | C1.57       | FSD75-6-D     | D1.73         | FSF83-12-C  | D1.74       |
|                                       | FIVRA4X4YL     | C1.57       | FSD75-8-5K10  | D1.142        | FSF83-18-C  | D1.74       |
|                                       | FL12X12LG-A    | C1.26       | FSD75-8-D     | D1.73         | FSF84-12-C  | D1.74       |
| D2. Power Connectors                  | FL25X25LG-A    | C1.26       | FSD75-8-DSL10 | D1.75, D1.141 | FSF84-18-C  | D1.74       |
|                                       | FL50X50LG-A    | C1.26       | FSD76-10-D    | D1.73         | FSF85-16-L  | D1.74       |
|                                       | FLB            | C1.60       | FSD76-12-D    | D1.73         | FSF85-18-L  | D1.74       |
|                                       | FLB12X15       | C1.60       | FSD76-6-D     | D1.73         | FSF85-22-L  | D1.74       |
|                                       | FLB12X20       | C1.60       | FSD76-8-5K8   | D1.142        | FSF86-16-L  | D1.74       |
|                                       | FLB58X15       | C1.60       | FSD76-8-D     | D1.73         | FSF86-18-L  | D1.74       |
| D3. Grounding Connectors              | FLB58X20       | C1.60       | FSD76-8-DSL8  | D1.75, D1.141 | FSF86-25-L  | D1.74       |
|                                       | FLRB           | C1.60       | FSD77-10-D    | D1.73         | FSF87-20-L  | D1.74       |
|                                       | FMWR-C         | C1.29       | FSD77-12-D    | D1.73         | FSF87-25-Q  | D1.74       |
| E1. Labeling Systems                  | FOV452X2YL     | C1.57       | FSD77-6-D     | D1.73         | FSH40-X     | B2.50       |
|                                       | FOV454X4YL     | C1.57       | FSD77-8-5K2   | D1.142        | FSHH-X      | B2.50       |
|                                       | FOVRA2X2YL     | C1.57       | FSD77-8-D     | D1.73         | FT2X2YL     | C1.57       |
| E2. Labels                            | FOVRA4X4YL     | C1.57       | FSD77-8-DSL2  | D1.75, D1.141 | FT4X4YL     | C1.57       |
|                                       | FP2DCIW        | C2.60       | FSD78-10-D    | D1.73         | FTD75-8-D   | D1.75       |
|                                       | FP2RCIW        | C2.60       | FSD78-12-D    | D1.73         | FTD76-10-D  | D1.75       |
|                                       | FPC-600-A      | D1.86       | FSD78-18-D    | D1.73         | FTD76-8-D   | D1.75       |
|                                       | FRA2X2YL       | C1.56       | FSD78-6-D     | D1.73         | FTD77-10-D  | D1.75       |
|                                       | FRA4X4YL       | C1.56       | FSD78-6-D     | D1.73         | FTD77-8-D   | D1.75       |
| E3. Pre-Printed & Write-On Markers    | FRAFC58        | C1.61       | FSD78-8-5K0   | D1.142        | FTD78-12-D  | D1.75       |
|                                       | FRF42YL        | C1.57       | FSD78-8-D     | D1.73         | FTD78-8-D   | D1.75       |
|                                       | FS.5X.5LG6NM   | C1.21       | FSD78-8-DSL0  | D1.75, D1.141 | FTD80-10-TL | D1.75       |
|                                       | FS.5X1LG6NM    | C1.21       | FSD79-8-D     | D1.73         | FTD80-13-TL | D1.75       |
|                                       | FS.75X.75LG6NM | C1.21       | FSD80-12-D    | D1.73         | FTD81-12-C  | D1.75       |
|                                       | FS1.5X1.5BL6-A | C1.33       | FSD80-18-D    | D1.73         | FTD82-14-C  | D1.75       |
| E4. Permanent Identification          | FS1.5X1.5LG6-A | C1.33       | FSD80-8-3K6   | D1.142        | FTR2X2YL    | C1.58       |
|                                       | FS1.5X1.5LG6NM | C1.21       | FSD80-8-D     | D1.73         | FTR4X4YL    | C1.58       |
|                                       | FS1.5X1.5WH6-A | C1.33       | FSD80-8-DSL6  | D1.75, D1.141 | FTRBE12     | C1.60       |
|                                       | FS1.5X1LG6NM   | C1.21       | FSD81-10-D    | D1.73         | FTRBE12M    | C1.60       |
|                                       | FS1.5X2LG6NM   | C1.21       | FSD81-12-C    | D1.73         | FTRBE58     | C1.60       |
|                                       | FS1.5X3LG6NM   | C1.21       | FSD81-18-C    | D1.73         | FTRBN12     | C1.60       |
| E5. Lockout/Tagout & Safety Solutions | FS156-C        | B2.50       | FSD82-12-C    | D1.73         | FTRBN12M    | C1.60       |
|                                       | FS1X1.5LG6-A   | C1.33       | FSD82-18-C    | D1.73         | FTRBN58     | C1.60       |
|                                       | FS1X1.5LG6NM   | C1.21       | FSD83-12-C    | D1.73         | FUSB        | C1.60       |
|                                       | FS1X1LG6NM     | C1.21       | FSD83-18-C    | D1.73         | FVT4X4YL    | C1.58       |
|                                       | FS1X1WH6-A     | C1.33       | FSD84-12-C    | D1.73         | FVTHD2X2YL  | C1.58       |
|                                       | FS1X1WH6NM-A   | C1.33       | FSD84-18-C    | D1.73         | FWR-C       | C1.29       |
| F. Index                              | FS1X2LG6NM     | C1.21       | FSD85-16-L    | D1.73         | FZBA1.5X4   | C1.60       |
|                                       | FS1X3LG6NM     | C1.21       | FSD85-18-L    | D1.73         | FZBLP       | C1.60       |
|                                       |                |             | FSD85-22-L    | D1.73         |             |             |



# PANDUIT® ELECTRICAL SOLUTIONS

| Part Number   | Page Number |
|---------------|-------------|
| <b>G</b>      |             |
| G.5X.5LG6     | C1.13       |
| G.5X.5LG6-A   | C1.33       |
| G.5X.5WH6-A   | C1.33       |
| G.5X1LG6      | C1.13       |
| G.5X1LG6-A    | C1.33       |
| G.5X1WH6-A    | C1.33       |
| G.5X2LG6      | C1.13       |
| G.75X.75LG6   | C1.13       |
| G.75X.75LG6-A | C1.33       |
| G.75X1.5LG6   | C1.13       |
| G.75X1.5LG6-A | C1.33       |
| G.75X1.5WH6-A | C1.33       |
| G.75X1LG6     | C1.13       |
| G.75X1LG6-A   | C1.33       |
| G.75X1WH6-A   | C1.33       |
| G.75X2LG6     | C1.13       |
| G.75X2LG6-A   | C1.33       |
| G.75X2WH6-A   | C1.33       |
| G1.5X1.5LG6   | C1.13       |
| G1.5X1.5LG6-A | C1.33       |
| G1.5X1.5WH-A  | C1.33       |
| G1.5X1LG6     | C1.13       |
| G1.5X1LG6-A   | C1.33       |
| G1.5X1WH6-A   | C1.33       |
| G1.5X2LG6     | C1.13       |
| G1.5X2LG6-A   | C1.33       |
| G1.5X2WH6-A   | C1.33       |
| G1.5X3LG6     | C1.13       |
| G1.5X3LG6-A   | C1.33       |
| G1.5X3WH6-A   | C1.33       |
| G1.5X4LG6     | C1.13       |
| G1.5X4LG6-A   | C1.33       |
| G1.5X4WH6-A   | C1.33       |
| G1X1.5LG6     | C1.13       |
| G1X1.5LG6-A   | C1.33       |
| G1X1.5WH6-A   | C1.33       |
| G1X1LG6       | C1.13       |
| G1X1LG6-A     | C1.33       |
| G1X1WH6-A     | C1.33       |
| G1X2LG6       | C1.13       |
| G1X2LG6-A     | C1.33       |
| G1X2WH6-A     | C1.33       |
| G1X3BL6-A     | C1.33       |
| G1X3LG6       | C1.13       |
| G1X3LG6-A     | C1.33       |
| G1X3WH6-A     | C1.33       |
| G1X4LG6       | C1.13       |
| G1X4LG6-A     | C1.33       |
| G1X4WH6-A     | C1.33       |
| G2.5X3LG6     | C1.13       |
| G2.5X3LG6-A   | C1.33       |
| G2.5X3WH6-A   | C1.33       |
| G2X1.5LG6     | C1.13       |
| G2X1.5LG6-A   | C1.33       |
| G2X1WH6-A     | C1.33       |
| G2X1LG6       | C1.13       |
| G2X1LG6-A     | C1.33       |
| G2X1WH6-A     | C1.33       |
| G2X2BL6-A     | C1.33       |
| G2X2LG6       | C1.13       |
| G2X2LG6-A     | C1.33       |
| G2X2WH6-A     | C1.33       |
| G2X3LG6       | C1.13       |
| G2X3LG6-A     | C1.33       |
| G2X3WH6-A     | C1.33       |
| G2X4BL6-A     | C1.33       |
| G2X4LG6       | C1.13       |
| G2X4LG6-A     | C1.33       |
| G2X4WH6-A     | C1.33       |
| G2X5LG6       | C1.13       |
| G2X5LG6-A     | C1.33       |
| G2X5WH6-A     | C1.33       |
| G3X1LG6       | C1.13       |
| G3X1LG6-A     | C1.33       |
| G3X1WH6-A     | C1.33       |

| Part Number          | Page Number |
|----------------------|-------------|
| G3X2LG6              | C1.13       |
| G3X2LG6-A            | C1.33       |
| G3X2WH6-A            | C1.33       |
| G3X3BL6-A            | C1.33       |
| G3X3LG6              | C1.13       |
| G3X3LG6-A            | C1.33       |
| G3X3WH6-A            | C1.33       |
| G3X4LG6              | C1.13       |
| G3X4LG6-A            | C1.33       |
| G3X4WH6-A            | C1.33       |
| G3X5LG6              | C1.13       |
| G3X5LG6-A            | C1.33       |
| G3X5WH6-A            | C1.33       |
| G4X1.5LG6            | C1.13       |
| G4X1.5LG6-A          | C1.33       |
| G4X1.5WH6-A          | C1.33       |
| G4X2LG6              | C1.13       |
| G4X2LG6-A            | C1.33       |
| G4X2WH6-A            | C1.33       |
| G4X3LG6              | C1.13       |
| G4X3LG6-A            | C1.33       |
| G4X3WH6-A            | C1.33       |
| G4X4BL6-A            | C1.33       |
| G4X4LG6              | C1.13       |
| G4X4LG6-A            | C1.33       |
| G4X4WH6-A            | C1.33       |
| G4X5LG6              | C1.13       |
| G4X5LG6-A            | C1.33       |
| G4X5WH6-A            | C1.33       |
| G6X4LG6              | C1.13       |
| GB2B0304TPI-1        | D3.6        |
| GB2B0306TPI-1        | D3.6        |
| GB2B0312TPI-1        | D3.6        |
| GB2B0514TPI-1        | D3.6        |
| <b>GB2D0008TPI-1</b> | <b>D3.7</b> |
| <b>GB2D0021TPI-1</b> | <b>D3.7</b> |
| <b>GB2D0033TPI-1</b> | <b>D3.7</b> |
| <b>GB2D0044TPI-1</b> | <b>D3.7</b> |
| <b>GB2D0056TPI-1</b> | <b>D3.7</b> |
| GB4B0612TPI-1        | D3.6        |
| GB4B0624TPI-1        | D3.6        |
| GB4B1028TPI-1        | D3.6        |
| <b>GB4N0007TPI-1</b> | <b>D3.7</b> |
| <b>GB4N0016TPI-1</b> | <b>D3.7</b> |
| <b>GB4N0024TPI-1</b> | <b>D3.7</b> |
| <b>GB4N0026TPI-1</b> | <b>D3.7</b> |
| <b>GB4N0034TPI-1</b> | <b>D3.7</b> |
| GC-15A-Q             | D3.28       |
| GC-18A-X             | D3.28       |
| GC-22A-4             | D3.28       |
| <b>GCE1/0-1/0</b>    | <b>D3.8</b> |
| <b>GCE250-1/0</b>    | <b>D3.8</b> |
| <b>GCE250-250</b>    | <b>D3.8</b> |
| <b>GCE500-1/0</b>    | <b>D3.8</b> |
| <b>GCE500-250</b>    | <b>D3.8</b> |
| <b>GCC6X61/0-1/0</b> | <b>D3.9</b> |
| <b>GCC6X6250-1/0</b> | <b>D3.9</b> |
| <b>GCC6X6250-250</b> | <b>D3.9</b> |
| <b>GCC6X6500-1/0</b> | <b>D3.9</b> |
| <b>GCC6X6500-250</b> | <b>D3.9</b> |
| GE128-C              | C3.10       |
| GE128-C69            | C3.10       |
| GE192-L              | C3.10       |
| GE192-L69            | C3.10       |
| GE255-L              | C3.10       |
| GE318-L              | C3.10       |
| GE380-Q              | C3.10       |
| GE510-Q              | C3.10       |
| GE52-C               | C3.10       |
| GE52-C69             | C3.10       |
| GE85-C               | C3.10       |
| GE85-C69             | C3.10       |
| GEE134N-C            | C3.10       |
| GEE144F-A-C          | C3.9        |
| GEE144F-A-C0         | C3.9        |
| GEE144F-C            | C3.8        |
| GEE144F-C0           | C3.8        |

| Part Number       | Page Number  |
|-------------------|--------------|
| GEE144FR-CY       | C3.9         |
| GEE36F-C          | C3.8         |
| GEE36F-C0         | C3.8         |
| GEE36FR-CY        | C3.9         |
| GEE47N-C          | C3.10        |
| GEE55N-C          | C3.10        |
| GEE62F-A-C        | C3.9         |
| GEE62F-A-C0       | C3.9         |
| GEE62F-C          | C3.8         |
| GEE62F-C0         | C3.8         |
| GEE62FR-CY        | C3.9         |
| GEE71N-C          | C3.10        |
| GEE98N-C          | C3.10        |
| GEE99F-A-C        | C3.9         |
| GEE99F-A-C0       | C3.9         |
| GEE99F-C          | C3.8         |
| GEE99F-C0         | C3.8         |
| GEE99FR-CY        | C3.9         |
| GES144F-A-C       | C3.9         |
| GES144F-A-C0      | C3.9         |
| GES144F-C         | C3.9         |
| GES144F-C0        | C3.9         |
| GES144FR-CY       | C3.10        |
| GES189F-C         | C3.9         |
| GES189F-C0        | C3.9         |
| GES36F-C          | C3.9         |
| GES36F-C0         | C3.9         |
| GES36FR-CY        | C3.10        |
| GES62F-A-C        | C3.9         |
| GES62F-A-C0       | C3.9         |
| GES62F-C          | C3.9         |
| GES62F-C0         | C3.9         |
| GES62FR-CY        | C3.10        |
| GES99F-A-C        | C3.9         |
| GES99F-A-C0       | C3.9         |
| GES99F-C          | C3.9         |
| GES99F-C0         | C3.9         |
| GES99FR-CY        | C3.10        |
| GHH               | B1.114       |
| <b>GLMHK</b>      | <b>D3.7</b>  |
| GM-2-Q            | D3.29        |
| GM-3-Q            | D3.29        |
| GMS-1-X           | D3.29        |
| GMS-2-Q           | D3.29        |
| GMS-3-Q           | D3.29        |
| <b>GPC4H250-2</b> | <b>D3.10</b> |
| GPL-10-Q          | D3.25        |
| GPL-14-X          | D3.25        |
| GPL-15-X          | D3.25        |
| GPL-16-X          | D3.25        |
| GPL-20-X          | D3.25        |
| GPL-21-X          | D3.25        |
| GPL-22-X          | D3.25        |
| GPL-26-X          | D3.25        |
| GPL-27-X          | D3.25        |
| GPL-28-X          | D3.25        |
| GPL-32-3          | D3.25        |
| GPL-33-3          | D3.25        |
| GPL-34-3          | D3.25        |
| GPL-39-3          | D3.25        |
| GPL-4-Q           | D3.25        |
| GPL-40-3          | D3.25        |
| GPL-44-1          | D3.25        |
| GPL-45-1          | D3.25        |
| GPL-46-1          | D3.25        |
| GPL-5-Q           | D3.25        |
| GPL-51-1          | D3.25        |
| GPL-52-1          | D3.25        |
| GPL-57-1          | D3.25        |
| GPL-58-1          | D3.25        |
| GPL-75-X          | D3.25        |
| GPL-6-Q           | D3.25        |
| GPL-8-Q           | D3.25        |
| GPL-9-Q           | D3.25        |
| <b>GPQC07-1/0</b> | <b>D3.5</b>  |
| <b>GPQC10-1/0</b> | <b>D3.5</b>  |
| <b>GPQC12-1/0</b> | <b>D3.5</b>  |

|                                       |
|---------------------------------------|
| A. System Overview                    |
| B1. Cable Ties                        |
| B2. Cable Accessories                 |
| B3. Stainless Steel Ties              |
| C1. Wiring Duct                       |
| C2. Surface Raceway                   |
| C3. Abrasion Protection               |
| C4. Cable Management                  |
| D1. Terminals                         |
| D2. Power Connectors                  |
| D3. Grounding Connectors              |
| E1. Labeling Systems                  |
| E2. Labels                            |
| E3. Pre-Printed & Write-On Markers    |
| E4. Permanent Identification          |
| E5. Lockout/Tagout & Safety Solutions |
| F. Index                              |

# PANDUIT® ELECTRICAL SOLUTIONS

| A. System Overview                 | Part Number                 | Page Number  | Part Number               | Page Number | Part Number                  | Page Number  |
|------------------------------------|-----------------------------|--------------|---------------------------|-------------|------------------------------|--------------|
|                                    | <b>GPQC15-1/0</b> . . . . . | <b>D3.5</b>  | H200X025H1T-B . . . . .   | E2.13       | HL8-1-X . . . . .            | D2.130       |
|                                    | <b>GPQC17-1/0</b> . . . . . | <b>D3.5</b>  | H200X034H1T . . . . .     | E2.13       | HL8-2-X . . . . .            | D2.132       |
| B1. Cable Ties                     | <b>GPQC20-1/0</b> . . . . . | <b>D3.5</b>  | H200X034H1T-2 . . . . .   | E2.15       | HL8-2N-X . . . . .           | D2.133       |
|                                    | GS2B . . . . .              | B1.111       | H200X034H1T-2-B . . . . . | E2.15       | HLA13-1-90-5 . . . . .       | D2.131       |
|                                    | GS4EH . . . . .             | B1.111       | H200X034H1T-B . . . . .   | E2.13       | HLA21-1-90-5 . . . . .       | D2.131       |
|                                    | GS4H . . . . .              | B1.111       | H200X044H1T . . . . .     | E2.13       | HLA4-1-90-X . . . . .        | D2.131       |
| B2. Cable Accessories              | GS4MT . . . . .             | B3.14        | H200X044H1T-2 . . . . .   | E2.15       | HLA8-1-90-X . . . . .        | D2.131       |
|                                    | GTH . . . . .               | B1.111       | H200X044H1T-2-B . . . . . | E2.15       | HLB2S-C0 . . . . .           | B1.87        |
|                                    | GTS . . . . .               | B1.111       | H200X044H1T-B . . . . .   | E2.13       | HLB4-1-X . . . . .           | D2.130       |
|                                    | GTSL . . . . .              | B1.111       | H200X064H1T . . . . .     | E2.13       | HLM-15R0 . . . . .           | B1.87        |
| B3. Stainless Steel Ties           | GU-13-3 . . . . .           | D3.26        | H200X064H1T-2 . . . . .   | E2.15       | HLS-15R0 . . . . .           | B1.87        |
|                                    | GU-2-X . . . . .            | D3.26        | H200X064H1T-2-B . . . . . | E2.15       | HLS-75R0 . . . . .           | B1.87        |
|                                    | GU-4-X . . . . .            | D3.26        | H200X064H1T-B . . . . .   | E2.13       | HLS1.5S-X0 . . . . .         | B1.87        |
|                                    | <b>GUBC500-6</b> . . . . .  | <b>D3.10</b> | H200X084H1T . . . . .     | E2.13       | HLS-15R0 . . . . .           | B1.87        |
|                                    |                             |              | H200X084H1T-2 . . . . .   | E2.15       | HLS3S-X0 . . . . .           | B1.87        |
|                                    |                             |              | H200X084H1T-2-B . . . . . | E2.15       | HLS5S-X0 . . . . .           | B1.87        |
|                                    |                             |              | H200X084H2T . . . . .     | E2.13       | HLS-75R0 . . . . .           | B1.87        |
| C1. Wiring Duct                    |                             |              | H200X122H1T-2 . . . . .   | E2.15       | HLSP1.5S-X0 . . . . .        | B1.88        |
|                                    | H000X025H1C . . . . .       | E1.8         | H200X165H1T . . . . .     | E2.13       | HLSP1.5S-X12 . . . . .       | B1.88        |
|                                    | H000X025H2C . . . . .       | E1.8         | H200X165H1T-2 . . . . .   | E2.15       | HLSP3S-X0 . . . . .          | B1.88        |
|                                    | H000X034H1C . . . . .       | E1.8         | H200X165H2T . . . . .     | E2.14       | HLSP3S-X12 . . . . .         | B1.88        |
| C2. Surface Raceway                | H000X034H2C . . . . .       | E1.8         | H2L13-2N-2 . . . . .      | D2.134      | HLSP5S-X0 . . . . .          | B1.88        |
|                                    | H000X044H1C . . . . .       | E1.8         | H2L21-2N-2 . . . . .      | D2.134      | HLSP5S-X12 . . . . .         | B1.88        |
|                                    | H000X044H2C . . . . .       | E1.8         | H2L30-2N-1 . . . . .      | D2.134      | HLT2I-X0 . . . . .           | B1.87        |
|                                    | H000X064H1C . . . . .       | E1.8         | H2L4-2N-X . . . . .       | D2.134      | HLT3I-X0 . . . . .           | B1.87        |
|                                    | H000X064H2C . . . . .       | E1.8         | H2L8-2N-2 . . . . .       | D2.134      | HLTP2I-X0 . . . . .          | B1.88        |
| C3. Abrasion Protection            | H000X084H1C . . . . .       | E1.8         | H2X2LG6 . . . . .         | C1.11       | HLTP2I-X12 . . . . .         | B1.88        |
|                                    | H000X084H2C . . . . .       | E1.8         | H2X3LG6 . . . . .         | C1.11       | HLTP3I-X0 . . . . .          | B1.88        |
|                                    | H050X025H1T . . . . .       | E2.12        | H2X4LG6 . . . . .         | C1.11       | HLTP3I-X12 . . . . .         | B1.88        |
|                                    | H050X025H1T-B . . . . .     | E2.12        | H3X3LG6 . . . . .         | C1.11       | <b>HLWM1.5S-X0</b> . . . . . | <b>B1.91</b> |
|                                    | H050X044H1T . . . . .       | E2.12        | H3X4LG6 . . . . .         | C1.11       | <b>HLWM3S-X0</b> . . . . .   | <b>B1.91</b> |
|                                    | H050X044H1T-B . . . . .     | E2.12        | H4X4LG6 . . . . .         | C1.11       | HN1.5X2LG6 . . . . .         | C1.11        |
| C4. Cable Management               | H050X064H1T . . . . .       | E2.12        | H4X4LG6 . . . . .         | C1.11       | HN1.5X3LG6 . . . . .         | C1.11        |
|                                    | H050X064H1T-B . . . . .     | E2.12        | HB2SP19-X . . . . .       | B2.51       | HN2X2LG6 . . . . .           | C1.11        |
|                                    | H075X025H1T . . . . .       | E2.12        | HB2SP25-X . . . . .       | B2.51       | HN2X3LG6 . . . . .           | C1.11        |
|                                    | H075X025H1T-B . . . . .     | E2.12        | HBN.75-T . . . . .        | B2.49       | HN2X4LG6 . . . . .           | C1.11        |
| D1. Terminals                      | H075X034H1T . . . . .       | E2.12        | HBN1-T . . . . .          | B2.49       | HN3X3LG6 . . . . .           | C1.11        |
|                                    | H075X044H1T . . . . .       | E2.12        | HBN1.5-T . . . . .        | B2.49       | HN3X4LG6 . . . . .           | C1.11        |
|                                    | H1.5X2LG6 . . . . .         | C1.11        | HBN2-T . . . . .          | B2.49       | HN4X4LG6 . . . . .           | C1.11        |
|                                    | H1.5X3LG6 . . . . .         | C1.11        | HBN2.5-T . . . . .        | B2.49       | HS1.5X2LG6NM . . . . .       | C1.11        |
|                                    | H100X025H1C . . . . .       | E1.9         | HBN3-T . . . . .          | B2.49       | HS1.5X3LG6NM . . . . .       | C1.11        |
| D2. Power Connectors               | H100X025H1T . . . . .       | E2.13        | HBN4-T . . . . .          | B2.49       | HS2X2LG6NM . . . . .         | C1.11        |
|                                    | H100X025H1T-2 . . . . .     | E2.14        | HBUA-X . . . . .          | B2.51       | HS2X3LG6NM . . . . .         | C1.11        |
|                                    | H100X025H1T-2-B . . . . .   | E2.14        | HC1.5LG6 . . . . .        | C1.11       | HS2X4LG6NM . . . . .         | C1.11        |
|                                    | H100X025H1T-B . . . . .     | E2.12        | HC2LG6 . . . . .          | C1.11       | HS3X3LG6NM . . . . .         | C1.11        |
|                                    | H100X025H2C . . . . .       | E1.9         | HC3LG6 . . . . .          | C1.11       | HS3X4LG6NM . . . . .         | C1.11        |
| D3. Grounding Connectors           | H100X034H1C . . . . .       | E1.9         | HC4LG6 . . . . .          | C1.11       | HS4X4LG6NM . . . . .         | C1.11        |
|                                    | H100X034H1T . . . . .       | E2.12        | HC13-3 . . . . .          | D2.135      | HSC.25-L . . . . .           | B2.41        |
|                                    | H100X034H1T-2 . . . . .     | E2.14        | HC21-1 . . . . .          | D2.135      | HSC.25-L100 . . . . .        | B2.41        |
|                                    | H100X034H1T-2-B . . . . .   | E2.14        | HC30-1 . . . . .          | D2.135      | HSEC0.5-X . . . . .          | C3.39        |
|                                    | H100X034H1T-B . . . . .     | E2.14        | HC4-3 . . . . .           | D2.135      | HSEC0.8-X . . . . .          | C3.39        |
| E1. Labeling Systems               | H100X034H2C . . . . .       | E1.9         | HC5-1 . . . . .           | D2.135      | HSEC1.0-X . . . . .          | C3.39        |
|                                    | H100X044H1C . . . . .       | E1.9         | HC8-3 . . . . .           | D2.135      | HSEC1.5-5 . . . . .          | C3.39        |
|                                    | H100X044H1T . . . . .       | E2.12        | HCME04Y09-C30 . . . . .   | B2.45       | HSEC2.0-5 . . . . .          | C3.39        |
|                                    | H100X044H1T-2 . . . . .     | E2.14        | HCME06A12-C130 . . . . .  | B2.45       | HSEC4.0-2 . . . . .          | C3.39        |
|                                    | H100X044H1T-2-B . . . . .   | E2.14        | HCME06Y12-C30 . . . . .   | B2.45       | HSECFR0.5-XY . . . . .       | C3.39        |
| E2. Labels                         | H100X044H1T-B . . . . .     | E2.12        | HCMP06B12-C20 . . . . .   | B2.44       | HSECFR0.8-XY . . . . .       | C3.39        |
|                                    | H100X044H2C . . . . .       | E1.9         | HCMP06C12-C20 . . . . .   | B2.44       | HSECFR1.0-XY . . . . .       | C3.39        |
|                                    | H100X064H1C . . . . .       | E1.9         | HHL13-2N-5 . . . . .      | D2.133      | HSECFR1.5-5Y . . . . .       | C3.39        |
|                                    | H100X064H1T . . . . .       | E2.12        | HHL21-2N-5 . . . . .      | D2.133      | HSECFR2.0-5Y . . . . .       | C3.39        |
|                                    | H100X064H1T-2 . . . . .     | E2.14        | HHL30-22N-1 . . . . .     | D2.133      | HSG-115V-650 . . . . .       | C3.40        |
|                                    | H100X064H1T-2-B . . . . .   | E2.14        | HHL8-2N-X . . . . .       | D2.133      | HSG-A1 . . . . .             | C3.40, E2.15 |
|                                    | H100X064H1T-B . . . . .     | E2.12        | HHL8-2N-X . . . . .       | D2.133      | HSG-A2 . . . . .             | C3.40, E2.15 |
|                                    | H100X064H2C . . . . .       | E1.9         | HKBS . . . . .            | C3.16       | HSG-A4 . . . . .             | C3.40, E2.15 |
| E3. Pre-Printed & Write-On Markers | H100X084H1C . . . . .       | E1.9         | HL1-2-25-X . . . . .      | D2.132      | HSG-P1 . . . . .             | C3.40, E2.15 |
|                                    | H100X084H1T . . . . .       | E2.13        | HL1-25-X . . . . .        | D2.130      | HSG-P2 . . . . .             | C3.40, E2.15 |
|                                    | H100X084H1T-2 . . . . .     | E2.14        | HL13-1-5 . . . . .        | D2.130      | HSG-P3 . . . . .             | C3.40, E2.15 |
|                                    | H100X084H1T-2-B . . . . .   | E2.14        | HL13-2-5 . . . . .        | D2.132      | HSG-P7 . . . . .             | C3.40, E2.15 |
|                                    | H100X084H1T-B . . . . .     | E2.14        | HL13-2N-5 . . . . .       | D2.133      | HST0.4-3-Q2Y . . . . .       | C3.38        |
|                                    | H100X084H2C . . . . .       | E1.9         | HL21-1-5 . . . . .        | D2.130      | HST0.4-3-QY . . . . .        | C3.38        |
| E4. Permanent Identification       | H100X122H1T-2 . . . . .     | E2.14        | HL21-2-5 . . . . .        | D2.132      | HST0.4-48-5-2Y . . . . .     | C3.38        |
|                                    | H100X122H1T-2-B . . . . .   | E2.14        | HL21-2N-5 . . . . .       | D2.133      | HST0.4-48-5Y . . . . .       | C3.38        |
|                                    | H100X165H1T . . . . .       | E2.13        | HL30-1-2 . . . . .        | D2.130      | HST0.4-6-3Y . . . . .        | C3.38        |
|                                    | H100X165H1T-2 . . . . .     | E2.14        | HL30-2-2 . . . . .        | D2.132      | HST0.4-6-X2Y . . . . .       | C3.38        |
|                                    | H150X025H1T . . . . .       | E2.14        | HL30-2N-2 . . . . .       | D2.133      | HST0.4-6-XY . . . . .        | C3.38        |
|                                    | H150X034H1T . . . . .       | E2.13        | HL4-1-X . . . . .         | D2.130      | HST0.8-12-5-2Y . . . . .     | C3.38        |
|                                    | H150X044H1T . . . . .       | E2.14        | HL4-2-X . . . . .         | D2.132      | HST0.8-12-5Y . . . . .       | C3.38        |
|                                    | H200X025H1T . . . . .       | E2.13        | HL50-1-2 . . . . .        | D2.130      |                              |              |
|                                    | H100X165H1T-2 . . . . .     | E2.14        | HL50-2-2 . . . . .        | D2.132      |                              |              |
|                                    | H200X025H1T-2-B . . . . .   | E2.15        |                           |             |                              |              |



# PANDUIT® ELECTRICAL SOLUTIONS

| Part Number    | Page Number | Part Number    | Page Number | Part Number     | Page Number |
|----------------|-------------|----------------|-------------|-----------------|-------------|
| HST0.8-48-5-2Y | C3.38       | HSTT25-48-Q    | C3.24       | HSTTN38-CY      | C3.33       |
| HST0.8-48-5Y   | C3.38       | HSTT25-48-TL   | C3.24       | HSTTN50-CY      | C3.33       |
| HST0.8-6-3Y    | C3.38       | HSTT25-C       | C3.24       | HSTTN63-CY      | C3.33       |
| HST0.8-6-X2Y   | C3.38       | HSTT25-D       | C3.24       | HSTTN75-CY      | C3.33       |
| HST0.8-6-XY    | C3.38       | HSTT25-Q       | C3.25       | HSTTN88-CY      | C3.33       |
| HST0.8-9-X2Y   | C3.38       | HSTT25-Y       | C3.26       | HSTTP05-CY      | C3.32       |
| HST0.8-9-XY    | C3.38       | HSTT25-YK1     | C3.26       | HSTTP05-MY      | C3.32       |
| HST1.1-12-5-2Y | C3.38       | HSTT300-48-2   | C3.25       | HSTTP05-QY      | C3.32       |
| HST1.1-12-5Y   | C3.38       | HSTT300-L      | C3.25       | HSTTP06-CY      | C3.32       |
| HST1.1-48-5-2Y | C3.38       | HSTT38-48-Q    | C3.24       | HSTTP06-MY      | C3.32       |
| HST1.1-48-5Y   | C3.38       | HSTT38-48-TL   | C3.24       | HSTTP06-QY      | C3.32       |
| HST1.1-6-3Y    | C3.38       | HSTT38-C       | C3.24       | HSTTP09-CY      | C3.32       |
| HST1.1-6-X2Y   | C3.38       | HSTT38-Q       | C3.25       | HSTTP09-MY      | C3.32       |
| HST1.1-6-XY    | C3.38       | HSTT38-T       | C3.24       | HSTTP09-QY      | C3.32       |
| HST1.1-9-2Y    | C3.38       | HSTT38-Y       | C3.26       | HSTTP100-CY     | C3.32       |
| HST1.1-9-X2Y   | C3.38       | HSTT38-YK1     | C3.26       | HSTTP100-QY     | C3.32       |
| HST1.1-9-XY    | C3.38       | HSTT4A125-48-5 | C3.37       | HSTTP12-CY      | C3.32       |
| HST1.5-12-1Y   | C3.38       | HSTT4A15-48-Q  | C3.37       | HSTTP12-MY      | C3.32       |
| HST1.5-12-5Y   | C3.38       | HSTT4A200-48-5 | C3.37       | HSTTP12-QY      | C3.32       |
| HST1.5-48-5-2Y | C3.38       | HSTT4A31-48-Q  | C3.37       | HSTTP150-CY     | C3.32       |
| HST1.5-48-5Y   | C3.38       | HSTT4A47-48-Q  | C3.37       | HSTTP150-QY     | C3.32       |
| HST1.5-9-XY    | C3.38       | HSTT4A62-48-5  | C3.37       | HSTTP19-CY      | C3.32       |
| HST2.0-12-2Y   | C3.38       | HSTT4A94-48-5  | C3.37       | HSTTP19-MY      | C3.32       |
| HST2.0-48-2Y   | C3.38       | HSTT400-48-2   | C3.25       | HSTTP19-QY      | C3.32       |
| HST2.0-9-5Y    | C3.38       | HSTT400-L      | C3.25       | HSTTP200-QY     | C3.32       |
| HST2.7-12-2Y   | C3.38       | HSTT50-48-5    | C3.25       | HSTTP25-CY      | C3.32       |
| HST2.7-48-2Y   | C3.38       | HSTT50-48-Q    | C3.25       | HSTTP25-DY      | C3.32       |
| HST3.0-12-2    | C3.38       | HSTT50-48-T    | C3.25       | HSTTP25-QY      | C3.32       |
| HST3.0-48-2    | C3.38       | HSTT50-C       | C3.25       | HSTTP38-CY      | C3.32       |
| HST3.5-12-2Y   | C3.38       | HSTT50-Q       | C3.25       | HSTTP38-QY      | C3.32       |
| HST3.5-48-2Y   | C3.38       | HSTT50-T       | C3.25       | HSTTP38-TY      | C3.32       |
| HSTT-YK1       | C3.27       | HSTT50-Y       | C3.26       | HSTTP50-CY      | C3.32       |
| HSTT-YK1-45    | C3.27       | HSTT50-YK1     | C3.26       | HSTTP50-QY      | C3.32       |
| HSTT-YK2       | C3.27       | HSTT75-48-5    | C3.25       | HSTTP75-CY      | C3.32       |
| HSTT-YK2-45    | C3.27       | HSTT75-48-CQ   | C3.25       | HSTTP75-QY      | C3.32       |
| HSTT05-48-Q    | C3.24       | HSTT75-C       | C3.25       | HSTTPN100-775-Q | C3.33       |
| HSTT05-48-TL   | C3.24       | HSTT75-Q       | C3.25       | HSTTPN100-CC    | C3.33       |
| HSTT05-C       | C3.24       | HSTT75-T       | C3.25       | HSTTPN150-925-X | C3.33       |
| HSTT05-M       | C3.24       | HSTT75-Y       | C3.26       | HSTTPN150-CC    | C3.33       |
| HSTT05-Q       | C3.25       | HSTT75-YK1     | C3.26       | HSTTPN200-950-X | C3.33       |
| HSTT06-48-Q    | C3.24       | HSTTA100-48-5  | C3.36       | HSTTPN200-CC    | C3.33       |
| HSTT06-48-TL   | C3.24       | HSTTA100-48-L  | C3.36       | HSTTPN50-438-L  | C3.33       |
| HSTT06-C       | C3.24       | HSTTA100-Y     | C3.36       | HSTTPN50-713-Q  | C3.33       |
| HSTT06-M       | C3.24       | HSTTA150-48-5  | C3.36       | HSTTPN50-CC     | C3.33       |
| HSTT06-Q       | C3.25       | HSTTA150-48-Q  | C3.36       | HSTTPN62-750-Q  | C3.33       |
| HSTT06-Y       | C3.26       | HSTTA150-Y     | C3.36       | HSTTPN62-CC     | C3.33       |
| HSTT06-YK1     | C3.26       | HSTTA19-48-Q   | C3.36       | HSTTPN75-775-Q  | C3.33       |
| HSTT09-48-Q    | C3.24       | HSTTA19-Y      | C3.36       | HSTTPN75-CC     | C3.33       |
| HSTT09-48-TL   | C3.24       | HSTTA25-48-Q   | C3.36       | HSTTRA100-48-5  | C3.37       |
| HSTT09-C       | C3.24       | HSTTA25-48-TL  | C3.36       | HSTTRA12-48-Q   | C3.37       |
| HSTT09-M       | C3.24       | HSTTA25-Y      | C3.36       | HSTTRA19-48-Q   | C3.37       |
| HSTT09-Q       | C3.25       | HSTTA38-48-Q   | C3.36       | HSTTRA25-48-Q   | C3.37       |
| HSTT09-Y       | C3.26       | HSTTA38-48-TL  | C3.36       | HSTTRA38-48-Q   | C3.37       |
| HSTT09-YK1     | C3.26       | HSTTA38-Y      | C3.36       | HSTTRA50-48-5   | C3.37       |
| HSTT100-48-5   | C3.25       | HSTTA50-48-5   | C3.36       | HSTTRA75-48-5   | C3.37       |
| HSTT100-48-LQ  | C3.25       | HSTTA50-48-T   | C3.36       | HSTTT03-48-Q    | C3.34       |
| HSTT100-C      | C3.25       | HSTTA50-Y      | C3.36       | HSTTT04-48-Q    | C3.34       |
| HSTT100-Y      | C3.26       | HSTTA75-48-5   | C3.36       | HSTTT046-48-Q   | C3.34       |
| HSTT100-YK1    | C3.26       | HSTTA75-48-C   | C3.36       | HSTTT05-48-Q    | C3.34       |
| HSTT12-48-Q    | C3.24       | HSTTA75-Y      | C3.36       | HSTTT055-48-Q   | C3.34       |
| HSTT12-48-TL   | C3.24       | HSTTK05-48-Q   | C3.35       | HSTTT06-48-Q    | C3.34       |
| HSTT12-C       | C3.24       | HSTTK06-48-Q   | C3.35       | HSTTT08-48-Q    | C3.34       |
| HSTT12-M       | C3.24       | HSTTK09-48-Q   | C3.35       | HSTTT09-48-Q    | C3.34       |
| HSTT12-Q       | C3.25       | HSTTK100-48-5  | C3.35       | HSTTT112-48-5   | C3.34       |
| HSTT12-Y       | C3.26       | HSTTK12-48-Q   | C3.35       | HSTTT12-48-Q    | C3.34       |
| HSTT12-YK1     | C3.26       | HSTTK19-48-Q   | C3.35       | HSTTT131-48-2   | C3.34       |
| HSTT150-48-5   | C3.25       | HSTTK25-48-Q   | C3.35       | HSTTT15-48-Q    | C3.34       |
| HSTT150-C      | C3.25       | HSTTK38-48-Q   | C3.35       | HSTTT150-48-2   | C3.34       |
| HSTT19-48-Q    | C3.24       | HSTTK50-48-5   | C3.35       | HSTTT19-48-Q    | C3.34       |
| HSTT19-48-TL   | C3.24       | HSTTK75-48-5   | C3.35       | HSTTT24-48-Q    | C3.34       |
| HSTT19-C       | C3.24       | HSTTN100-CY    | C3.33       | HSTTT30-48-Q    | C3.34       |
| HSTT19-M       | C3.24       | HSTTN125-CY    | C3.33       | HSTTT37-48-Q    | C3.34       |
| HSTT19-Q       | C3.25       | HSTTN150-CY    | C3.33       | HSTTT43-48-Q    | C3.34       |
| HSTT19-Y       | C3.26       | HSTTN175-CY    | C3.33       | HSTTT47-48-Q    | C3.34       |
| HSTT19-YK1     | C3.26       | HSTTN200-QY    | C3.33       | HSTTT56-48-5    | C3.34       |
| HSTT200-48-5   | C3.25       | HSTTN25-CY     | C3.33       | HSTTT66-48-5    | C3.34       |
| HSTT200-L      | C3.25       | HSTTN300-QY    | C3.33       | HSTTT75-48-5    | C3.34       |

A.  
System  
Overview

B1.  
Cable Ties

B2.  
Cable  
Accessories

B3.  
Stainless  
Steel Ties

C1.  
Wiring  
Duct

C2.  
Surface  
Raceway

C3.  
Abrasion  
Protection

C4.  
Cable  
Management

D1.  
Terminals

D2.  
Power  
Connectors

D3.  
Grounding  
Connectors

E1.  
Labeling  
Systems

E2.  
Labels

E3.  
Pre-Printed  
& Write-On  
Markers

E4.  
Permanent  
Identification

E5.  
Lockout/  
Tagout  
& Safety  
Solutions

F.  
Index

# PANDUIT® ELECTRICAL SOLUTIONS

| A. System Overview                    | Part Number    | Page Number | Part Number   | Page Number | Part Number   | Page Number  |
|---------------------------------------|----------------|-------------|---------------|-------------|---------------|--------------|
| B1. Cable Ties                        | HSTTV93-48-5   | C3.34       | HSTTV50-T     | C3.30       | HVMPM32-C0    | B2.21, B1.62 |
|                                       | HSTTV05-48-Q   | C3.28       | HSTTV50-T2    | C3.30       | HVTM-06-C0    | B2.11        |
| B2. Cable Accessories                 | HSTTV05-48-TL  | C3.28       | HSTTV50-T4    | C3.30       | HVTM3S10-C0   | B1.62        |
|                                       | HSTTV05-C      | C3.29       | HSTTV50-T6    | C3.30       | HWS2819-C     | B2.43        |
|                                       | HSTTV05-M      | C3.30       | HSTTV50-Y     | C3.31       | <b>I</b>      |              |
|                                       | HSTTV05-M2     | C3.30       | HSTTV75-48-5  | C3.28       | ICF10IW-X     | C2.79        |
|                                       | HSTTV05-M4     | C3.30       | HSTTV75-48-CQ | C3.28       | ICF3IW-E      | C2.79        |
|                                       | HSTTV05-M6     | C3.30       | HSTTV75-C     | C3.29       | ICF5IW-E      | C2.79        |
|                                       | HSTTV05-Q      | C3.31       | HSTTV75-Q     | C3.31       | ICFC10IW-X    | C2.80        |
|                                       | HSTTV05-Y      | C3.31       | HSTTV75-T     | C3.30       | ICFC3IW-X     | C2.80        |
|                                       | HSTTV06-48-Q   | C3.28       | HSTTV75-T2    | C3.30       | ICFC5IW-X     | C2.80        |
|                                       | HSTTV06-48-TL  | C3.28       | HSTTV75-T4    | C3.30       | ICFX10IW-X    | C2.75, C2.81 |
| B3. Stainless Steel Ties              | HSTTV06-C      | C3.29       | HSTTV75-T6    | C3.30       | ICFX3IW-X     | C2.81        |
|                                       | HSTTV06-M      | C3.30       | HSTTV75-Y     | C3.31       | ICFX5IW-X     | C2.81        |
| C1. Wiring Duct                       | HSTTV06-M2     | C3.30       | HSTTV100-48-5 | C3.35       | ILT2S-C       | B1.61        |
|                                       | HSTTV06-M4     | C3.30       | HSTTV100-Y    | C3.36       | ILT2S-C0      | B1.61        |
|                                       | HSTTV06-M6     | C3.30       | HSTTV12-48-Q  | C3.35       | ILT3S-C       | B1.61        |
|                                       | HSTTV06-Q      | C3.31       | HSTTV12-Y     | C3.36       | ILT3S-C0      | B1.61        |
|                                       | HSTTV06-Y      | C3.31       | HSTTV150-48-5 | C3.35       | ILT4LH-TL     | B1.61        |
|                                       | HSTTV09-48-Q   | C3.28       | HSTTV19-48-Q  | C3.35       | ILT4LH-TL0    | B1.61        |
|                                       | HSTTV09-48-TL  | C3.28       | HSTTV19-Y     | C3.36       | ILT4S-C       | B1.61        |
|                                       | HSTTV09-C      | C3.29       | HSTTV25-48-Q  | C3.35       | ILT4S-C0      | B1.61        |
|                                       | HSTTV09-M      | C3.30       | HSTTV25-Y     | C3.36       | ILT6LH-C      | B1.61        |
|                                       | HSTTV09-M2     | C3.30       | HSTTV38-48-Q  | C3.35       | ILT6LH-C0     | B1.61        |
| C2. Surface Raceway                   | HSTTV09-M4     | C3.30       | HSTTV38-Y     | C3.36       | IT9100-C0     | B1.63        |
|                                       | HSTTV09-M6     | C3.30       | HSTTV50-48-5  | C3.35       | IT9100-CUV16B | B1.63        |
|                                       | HSTTV09-Q      | C3.31       | HSTTV50-Y     | C3.36       | IT9100-CUV2   | B1.63        |
|                                       | HSTTV09-Y      | C3.31       | HSTTV75-48-5  | C3.35       | IT9100-CUV4Y  | B1.63        |
|                                       | HSTTV100-48-5  | C3.28       | HSTTV75-Y     | C3.36       | IT9100-CUV6   | B1.63        |
|                                       | HSTTV100-48-LQ | C3.28       | HT2-BLU       | E5.33       | IT9100-CUV6A  | B1.63        |
|                                       | HSTTV100-C     | C3.29       | HT2-GRN       | E5.33       | IT9100-CUV7A  | B1.63        |
|                                       | HSTTV100-C5    | C3.29       | HT2-ORN       | E5.33       | IT9100-CUV8   | B1.63        |
|                                       | HSTTV100-Q     | C3.31       | HT2-RED       | E5.33       | IT9115-C0     | B1.63        |
|                                       | HSTTV100-T2    | C3.30       | HT2-WHT       | E5.33       | IT9115-CUV11  | B1.63        |
| C3. Abrasion Protection               | HSTTV100-Y     | C3.31       | HT2-YEL       | E5.33       | IT9115-CUV16B | B1.63        |
|                                       | HSTTV12-48-Q   | C3.28       | HT2S-BLK-YEL  | E5.33       | IT9115-CUV18  | B1.63        |
|                                       | HSTTV12-48-TL  | C3.28       | HT2S-RED-WHT  | E5.33       | IT9115-CUV2   | B1.63        |
|                                       | HSTTV12-C      | C3.29       | HT3S-BLK-YEL  | E5.33       | IT9115-CUV2A  | B1.63        |
|                                       | HSTTV12-M      | C3.30       | HT3S-RED-WHT  | E5.33       | IT9115-CUV4A  | B1.63        |
|                                       | HSTTV12-M2     | C3.30       | HTB3-C-M      | E5.36       | IT9115-CUV4Y  | B1.63        |
|                                       | HSTTV12-M4     | C3.30       | HTB3-DNE-M    | E5.36       | IT9115-CUV5A  | B1.63        |
|                                       | HSTTV12-M6     | C3.30       | HTB3-HV-M     | E5.36       | IT9115-CUV5B  | B1.63        |
|                                       | HSTTV12-Q      | C3.31       | HTCT2-2-1     | D3.14       | IT9115-CUV6   | B1.63        |
|                                       | HSTTV12-Y      | C3.31       | HTCT250-2-1   | D3.14       | IT9115-CUV6A  | B1.63        |
| C4. Cable Management                  | HSTTV150-48-5  | C3.28       | HTCT250-250-1 | D3.14       | IT9115-CUV6B  | B1.63        |
|                                       | HSTTV150-C     | C3.29       | HTCT6X-6X-1   | D3.14       | IT9115-CUV7A  | B1.63        |
|                                       | HSTTV19-48-Q   | C3.28       | HTDU2B-W      | E5.35       | IT9115-CUV8   | B1.63        |
|                                       | HSTTV19-48-TL  | C3.28       | HTDU20-FO     | E5.35       | IT940-C0      | B1.63        |
|                                       | HSTTV19-C      | C3.29       | HTDU20-T      | E5.35       | IT965-C0      | B1.63        |
|                                       | HSTTV19-M      | C3.30       | HTDU2R-E      | E5.35       | <b>J</b>      |              |
|                                       | HSTTV19-M2     | C3.30       | HTDU30-FO     | E5.35       | J214-312-T    | D1.68        |
|                                       | HSTTV19-M4     | C3.30       | HTDU30-T      | E5.35       | J216-410-L    | D1.68        |
|                                       | HSTTV19-M6     | C3.30       | HTDU3R-E      | E5.35       | J318-412-T    | D1.68        |
|                                       | HSTTV19-Q      | C3.31       | HTDU60-FO     | E5.35       | JB1DIW-A      | C2.57        |
| D1. Terminals                         | HSTTV19-Y      | C3.31       | HTDU60-T      | E5.35       | JB1FSIW-A     | C2.52, C2.57 |
|                                       | HSTTV25-48-Q   | C3.28       | HTDU6R-E      | E5.35       | JB1IW-A       | C2.57        |
|                                       | HSTTV25-48-TL  | C3.28       | HTMT          | B3.15       | JBA-X         | C2.57        |
|                                       | HSTTV25-C      | C3.29       | HTU3G-TM      | E5.35       | JBD1          | C2.59        |
|                                       | HSTTV25-D      | C3.30       | HTU30-FO-M    | E5.35       | JBD2          | C2.59        |
|                                       | HSTTV25-D2     | C3.30       | HTU30-TM      | E5.35       | JBP1DIW       | C2.58        |
|                                       | HSTTV25-D4     | C3.30       | HTU3R-E-M     | E5.35       | JBP1EIW       | C2.58        |
|                                       | HSTTV25-D6     | C3.30       | HTU3Y-E-M     | E5.35       | JBP1FSIW      | C2.52, C2.59 |
|                                       | HSTTV25-Q      | C3.31       | HTU60-FO      | E5.35       | JBP1IHW       | C2.58        |
|                                       | HSTTV25-Y      | C3.31       | HTU60-T       | E5.35       | JBP1IW        | C2.58        |
| D2. Power Connectors                  | HSTTV38-48-Q   | C3.28       | HTU60-TV      | E5.35       | JBP1MD20IW    | C2.59, C2.61 |
|                                       | HSTTV38-48-TL  | C3.28       | HTU6R-E       | E5.35       | JBP1MR20IW    | C2.59, C2.61 |
|                                       | HSTTV38-C      | C3.29       | HTU6Y-E       | E5.35       | JBP2DIW       | C2.57, C2.58 |
|                                       | HSTTV38-Q      | C3.31       | HTU6Y-G       | E5.35       | JBP2FSIW      | C2.52, C2.59 |
|                                       | HSTTV38-T      | C3.30       | HTWC2-2-1     | D3.15       | JBP2IW        | C2.57, C2.58 |
|                                       | HSTTV38-T2     | C3.30       | HTWC250-2-1   | D3.15       | JBP2SIW       | C2.59        |
|                                       | HSTTV38-T4     | C3.30       | HTWC250-250-1 | D3.15       | JBX3510IW-A   | C2.57        |
|                                       | HSTTV38-T6     | C3.30       | HTWC6X-6X-1   | D3.15       | JMCB-X        | C4.8         |
|                                       | HSTTV38-Y      | C3.31       | HV9100-C      | B1.64       | JMCMB25-1-X   | C4.8         |
|                                       | HSTTV50-48-Q   | C3.28       | HV9100-C0     | B1.62       |               |              |
| D3. Grounding Connectors              | HSTTV50-48-T   | C3.28       | HV9150-C0     | B1.62       |               |              |
|                                       | HSTTV50-C      | C3.29       | HV9250-C0     | B1.62       |               |              |
|                                       | HSTTV50-Q      | C3.31       | HV965-C0      | B1.62       |               |              |
|                                       |                |             |               |             |               |              |
|                                       |                |             |               |             |               |              |
| E1. Labeling Systems                  |                |             |               |             |               |              |
|                                       |                |             |               |             |               |              |
|                                       |                |             |               |             |               |              |
|                                       |                |             |               |             |               |              |
|                                       |                |             |               |             |               |              |
| E2. Labels                            |                |             |               |             |               |              |
|                                       |                |             |               |             |               |              |
|                                       |                |             |               |             |               |              |
|                                       |                |             |               |             |               |              |
|                                       |                |             |               |             |               |              |
| E3. Pre-Printed & Write-On Markers    |                |             |               |             |               |              |
|                                       |                |             |               |             |               |              |
|                                       |                |             |               |             |               |              |
|                                       |                |             |               |             |               |              |
|                                       |                |             |               |             |               |              |
| E4. Permanent Identification          |                |             |               |             |               |              |
|                                       |                |             |               |             |               |              |
|                                       |                |             |               |             |               |              |
|                                       |                |             |               |             |               |              |
|                                       |                |             |               |             |               |              |
| E5. Lockout/Tagout & Safety Solutions |                |             |               |             |               |              |
|                                       |                |             |               |             |               |              |
|                                       |                |             |               |             |               |              |
|                                       |                |             |               |             |               |              |
|                                       |                |             |               |             |               |              |
| F. Index                              |                |             |               |             |               |              |
|                                       |                |             |               |             |               |              |
|                                       |                |             |               |             |               |              |
|                                       |                |             |               |             |               |              |
|                                       |                |             |               |             |               |              |

# PANDUIT® ELECTRICAL SOLUTIONS

| Part Number     | Page Number |
|-----------------|-------------|
| JMCMB25-3-X     | C4.8        |
| JMDWB-1-X       | C4.8        |
| JMDWB-3-X       | C4.8        |
| JMJH2-X20       | C4.8        |
| JMJH2W-X20      | C4.8        |
| JMN2-C          | D1.69       |
| JMN6-C          | D1.69       |
| JMSBCB87-1-X    | C4.8        |
| JMSBCB87-3-X    | C4.8        |
| JMTRB38-1-X     | C4.8        |
| JMTRB38-3-X     | C4.8        |
| JN218-216-C     | D1.67       |
| JN224-318-C     | D1.67       |
| JN314-412-C     | D1.67       |
| JN418-212-C     | D1.67       |
| JP131CM-L20     | C4.4        |
| JP131CP-L20     | C4.6        |
| JP131DW-L20     | C4.4        |
| JP131HBC25R-L20 | C4.5        |
| JP131HBC50R-L20 | C4.5        |
| JP131HBC75R-L20 | C4.5        |
| JP131SBC50-L20  | C4.5        |
| JP131SBC50R-L20 | C4.5        |
| JP131SBC87-L20  | C4.5        |
| JP131SBC87R-L20 | C4.5        |
| JP131UF100-L20  | C4.6        |
| JP131W-L20      | C4.4        |
| JP131WP-L20     | C4.4        |
| JP131ZP-L20     | C4.6        |
| JP2CM-L20       | C4.4        |
| JP2CP-L20       | C4.6        |
| JP2DW-L20       | C4.4        |
| JP2HBC25R-L20   | C4.5        |
| JP2HBC50R-L20   | C4.5        |
| JP2HBC75R-L20   | C4.5        |
| JP2SBC50-L20    | C4.5        |
| JP2SBC50R-L20   | C4.5        |
| JP2SBC87-L20    | C4.5        |
| JP2SBC87R-L20   | C4.5        |
| JP2UF100-L20    | C4.6        |
| JP2W-L20        | C4.4        |
| JP2WP-L20       | C4.4        |
| JP2ZP-L20       | C4.6        |
| JP4CM-X20       | C4.4        |
| JP4CP-X20       | C4.6        |
| JP4HBC25R-X20   | C4.5        |
| JP4HBC50R-X20   | C4.5        |
| JP4HBC75R-X20   | C4.5        |
| JP4SBC50-X20    | C4.5        |
| JP4SBC50R-X20   | C4.5        |
| JP4SBC87-X20    | C4.5        |
| JP4SBC87R-X20   | C4.5        |
| JP4UF100-X20    | C4.6        |
| JP4W-X20        | C4.4        |
| JP4WP-X20       | C4.4        |
| JP4ZP-X20       | C4.6        |
| JP75CM-L20      | C4.4        |
| JP75CP-L20      | C4.6        |
| JP75DW-L20      | C4.4        |
| JP75HBC25R-L20  | C4.5        |
| JP75HBC50R-L20  | C4.5        |
| JP75HBC75R-L20  | C4.5        |
| JP75SBC50-L20   | C4.5        |
| JP75SBC50R-L20  | C4.5        |
| JP75SBC87-L20   | C4.5        |
| JP75SBC87R-L20  | C4.5        |
| JP75UF100-L20   | C4.6        |
| JP75W-L20       | C4.4        |
| JP75WP-L20      | C4.4        |
| JP75ZP-L20      | C4.6        |
| <b>K</b>        |             |
| K-1000          | D1.37       |
| K-1001          | D1.37       |
| K-1100          | D1.37       |
| K-1102Y         | D1.37       |

| Part Number    | Page Number  |
|----------------|--------------|
| K-1103Y        | D1.37        |
| K-1104         | D1.37        |
| K-205          | B1.83, D1.38 |
| K-504          | B1.83        |
| K1-PNKIT       | D1.38        |
| K2-BLD2        | B1.114       |
| K2-PVKITY      | D1.37, D1.38 |
| K4EH-BLD       | B1.114       |
| K4H-BLD        | B1.114       |
| K4M-BLD        | B3.14        |
| K4MTG          | B3.14        |
| K600-A         | D1.86        |
| K6-8R-T        | D1.12        |
| KB-550         | B1.84        |
| KB-551         | B1.84        |
| <b>KF-1005</b> | <b>D1.36</b> |
| KGTHBLD        | B1.114       |
| KGTHSLV        | B1.114       |
| KGHTL          | B1.114       |
| KGTSBLD        | B1.114       |
| KGTSLLV        | B1.114       |
| KGSTL          | B1.114       |
| KH-1-L         | D3.27        |
| KH-2-L         | D3.27        |
| KIMS-H366-C2   | B2.14        |
| KIMS-H430-C6   | B2.14        |
| KIMS-H500-C4   | B2.14        |
| KLM14-250Y     | D2.147       |
| KLM350-800Y    | D2.147       |
| KLM6-250Y      | D2.147       |
| KLM6-600Y      | D2.147       |
| KLM6-800Y      | D2.147       |
| KLS-0-Q        | D3.27        |
| KLS-1-Q        | D3.27        |
| KLS-1A-X       | D3.27        |
| KMTRTH         | B3.20        |
| KMTRTLS        | B3.20        |
| KP-1000        | D1.36        |
| KP-1075Y       | D1.36        |
| KP-1165Y       | D1.36        |
| KP-1166        | D1.36        |
| KP-506A        | B1.84        |
| KP-506A-0      | B1.84        |
| KP-509         | B1.84        |
| KP-F1          | D1.78        |
| KP-F2          | D1.78        |
| KP-FSD1        | D1.78        |
| KP-FSD2        | D1.78        |
| KP-FSD3        | D1.78        |
| KP-HSTT1       | C3.40        |
| KP-HSTT2       | C3.40        |
| KP-HSTTA       | C3.40        |
| KP1-C          | D3.26        |
| KP2-L          | D3.26        |
| KPPTMTB        | B3.16        |
| KPPTMTG        | B3.16        |
| KPTHBLD        | B1.114       |
| KPTSTL         | B1.114       |
| KRT2BLD        | B3.26        |
| KRT2HNDL       | B3.26        |
| <b>L</b>       |              |
| LAA1-14-X      | D2.112       |
| LAA1-38-X      | D2.112       |
| LAA1-56-X      | D2.112       |
| LAA1/0-12-X    | D2.112       |
| LAA1/0-38-X    | D2.112       |
| LAA1/0-56-X    | D2.112       |
| LAA1000-58-1   | D2.112       |
| LAA2-14-X      | D2.112       |
| LAA2-38-X      | D2.112       |
| LAA2-56-X      | D2.112       |
| LAA2/0-12-5    | D2.112       |
| LAA2/0-38-5    | D2.112       |
| LAA250-12-5    | D2.112       |
| LAA250-38-5    | D2.112       |

| Part Number     | Page Number |
|-----------------|-------------|
| LAA3/0-12-5     | D2.112      |
| LAA3/0-38-5     | D2.112      |
| LAA300-12-2     | D2.112      |
| LAA300-38-2     | D2.112      |
| LAA350-12-2     | D2.112      |
| LAA4-14-X       | D2.112      |
| LAA4-38-X       | D2.112      |
| LAA4-56-X       | D2.112      |
| LAA4/0-12-5     | D2.112      |
| LAA4/0-38-5     | D2.112      |
| LAA400-58-2     | D2.112      |
| LAA500-12-2     | D2.112      |
| LAA500-58-2     | D2.112      |
| LAA6-14-X       | D2.112      |
| LAA6-56-X       | D2.112      |
| LAA750-58-1     | D2.112      |
| LAB1/0-38-X     | D2.113      |
| LAB1000-12-1    | D2.113      |
| LAB2/0-12-5     | D2.113      |
| LAB250-12-5     | D2.113      |
| LAB3/0-12-5     | D2.113      |
| LAB300-12-2     | D2.113      |
| LAB350-12-2     | D2.113      |
| LAB4/0-12-5     | D2.113      |
| LAB400-12-2     | D2.113      |
| LAB500-12-2     | D2.113      |
| LAB600-12-2     | D2.113      |
| LAB750-12-1     | D2.113      |
| LAB800-12-1     | D2.113      |
| LAM2A1/0-14-6Y  | D2.142      |
| LAM2A1000-58-6Y | D2.142      |
| LAM2A2/0-14-6Y  | D2.142      |
| LAM2A250-38-6Y  | D2.142      |
| LAM2A350-12-6Y  | D2.142      |
| LAM2A600-12-6Y  | D2.142      |
| LAM2B350-12-3Y  | D2.143      |
| LAM2B600-12-3   | D2.143      |
| LAM2LB1000-12-3 | D2.143      |
| LAM2LB600-12-3  | D3.143      |
| LAM2SA300-56-3  | D2.143      |
| LAM2SB600-38-1Y | D2.144      |
| LAM2SB750-38-1Y | D2.144      |
| LAM2SSB500-141Y | D2.144      |
| LAM3B1/0-38-6Y  | D2.144      |
| LAM3B250-12-1Y  | D2.144      |
| LAM3B3/0-12-3Y  | D2.144      |
| LAM3B350-12-1Y  | D2.144      |
| LAM3D250-12-1Y  | D2.145      |
| LAM3D3/0-12-3Y  | D2.145      |
| LAM3D350-12-1Y  | D2.145      |
| LAM3LB600-12-1  | D2.144      |
| LAM3LB1000-121Y | D2.144      |
| LAM3LD1000-121Y | D2.145      |
| LAM3LD600-12-1  | D2.145      |
| LAM4LD1000-12-1 | D2.146      |
| LAM4D250-12-1Y  | D2.146      |
| LAM4D350-12-1Y  | D2.146      |
| LAM4LD600-12-1  | D2.146      |
| LAM4SB600-38-1Y | D2.146      |
| LAM4SB750-38-1Y | D2.146      |
| LAMA1/0-14-QY   | D2.141      |
| LAMA1/0-56-Q    | D2.141      |
| LAMA1000-58-6Y  | D2.141      |
| LAMA2-14-QY     | D2.141      |
| LAMA2/0-14-QY   | D2.141      |
| LAMA250-56-QY   | D2.141      |
| LAMA300-56-QY   | D2.141      |
| LAMA350-38-QY   | D2.141      |
| LAMA500-38-6Y   | D2.141      |
| LAMA6-14-QY     | D2.141      |
| LAMA600-38-6Y   | D2.141      |
| LAMA600S-38-6Y  | D2.141      |
| LAMB350-12-6Y   | D2.142      |
| LAMB600-12-3Y   | D2.142      |
| LAMLB1000-12-3  | D2.142      |
| LC10-A-L8       | B2.37       |
| LC3-A-C8        | B2.37       |

|  |
|--|
| A. System Overview                     |
| B1. Cable Ties                         |
| B2. Cable Accessories                  |
| B3. Stainless Steel Ties               |
| C1. Wiring Duct                        |
| C2. Surface Raceway                    |
| C3. Abrasion Protection                |
| C4. Cable Management                   |
| D1. Terminals                          |
| D2. Power Connectors                   |
| D3. Grounding Connectors               |
| E1. Labeling Systems                   |
| E2. Labels                             |
| E3. Pre-Printed & Write-On Markers     |
| E4. Permanent Identification           |
| E5. Lockout/ Tagout & Safety Solutions |
| F. Index                               |





| Part Number   | Page Number |
|---------------|-------------|
| LCAF1/0-38F-X | D2.77       |
| LCAF1/0-38H-X | D2.75       |
| LCAF1/0-56-X  | D2.73       |
| LCAF1/0-56F-X | D2.77       |
| LCAF1/0-56H-X | D2.75       |
| LCAF2-12-E    | D2.73       |
| LCAF2-12F-E   | D2.77       |
| LCAF2-12H-E   | D2.75       |
| LCAF2-14-E    | D2.73       |
| LCAF2-14F-E   | D2.77       |
| LCAF2-14H-E   | D2.75       |
| LCAF2-38-E    | D2.73       |
| LCAF2-38F-E   | D2.77       |
| LCAF2-38H-E   | D2.75       |
| LCAF2-56-E    | D2.73       |
| LCAF2-56F-E   | D2.77       |
| LCAF2-56H-E   | D2.75       |
| LCAF2/0-12-X  | D2.74       |
| LCAF2/0-12F-X | D2.78       |
| LCAF2/0-12H-X | D2.75       |
| LCAF2/0-14-X  | D2.74       |
| LCAF2/0-14F-X | D2.78       |
| LCAF2/0-14H-X | D2.75       |
| LCAF2/0-38-X  | D2.74       |
| LCAF2/0-38F-X | D2.78       |
| LCAF2/0-38H-X | D2.75       |
| LCAF2/0-56-X  | D2.74       |
| LCAF2/0-56F-X | D2.78       |
| LCAF2/0-56H-X | D2.75       |
| LCAF250-12-X  | D2.74       |
| LCAF250-12F-X | D2.78       |
| LCAF250-12H-X | D2.76       |
| LCAF250-38-X  | D2.74       |
| LCAF250-38F-X | D2.78       |
| LCAF250-38H-X | D2.76       |
| LCAF250-58-X  | D2.74       |
| LCAF250-58F-X | D2.78       |
| LCAF250-58H-X | D2.76       |
| LCAF250-78-X  | D2.74       |
| LCAF250-78F-X | D2.78       |
| LCAF250-78H-X | D2.76       |
| LCAF3/0-12-X  | D2.74       |
| LCAF3/0-12F-X | D2.78       |
| LCAF3/0-12H-X | D2.76       |
| LCAF3/0-14-X  | D2.74       |
| LCAF3/0-14F-X | D2.78       |
| LCAF3/0-14H-X | D2.76       |
| LCAF3/0-38-X  | D2.74       |
| LCAF3/0-38F-X | D2.78       |
| LCAF3/0-38H-X | D2.76       |
| LCAF3/0-56-X  | D2.74       |
| LCAF3/0-56F-X | D2.78       |
| LCAF3/0-56H-X | D2.76       |
| LCAF300-12-6  | D2.74       |
| LCAF300-12F-6 | D2.78       |
| LCAF300-12H-6 | D2.76       |
| LCAF300-38-6  | D2.74       |
| LCAF300-38F-6 | D2.78       |
| LCAF300-38H-6 | D2.76       |
| LCAF300-58-6  | D2.74       |
| LCAF300-58F-6 | D2.78       |
| LCAF300-58H-6 | D2.76       |
| LCAF300-78-6  | D2.74       |
| LCAF300-78F-6 | D2.78       |
| LCAF300-78H-6 | D2.76       |
| LCAF350-1-6   | D2.74       |
| LCAF350-12-6  | D2.74       |
| LCAF350-12F-6 | D2.78       |
| LCAF350-12H-6 | D2.76       |
| LCAF350-1F-6  | D2.78       |
| LCAF350-1H-6  | D2.76       |
| LCAF350-34-6  | D2.74       |
| LCAF350-34F-6 | D2.78       |
| LCAF350-34H-6 | D2.76       |
| LCAF350-38-6  | D2.74       |
| LCAF350-38F-6 | D2.78       |
| LCAF350-38H-6 | D2.76       |

| Part Number   | Page Number |
|---------------|-------------|
| LCAF350-58-6  | D2.74       |
| LCAF350-58F-6 | D2.78       |
| LCAF350-58H-6 | D2.76       |
| LCAF350-78-6  | D2.74       |
| LCAF350-78F-6 | D2.78       |
| LCAF350-78H-6 | D2.76       |
| LCAF4-10-L    | D2.73       |
| LCAF4-10F-L   | D2.77       |
| LCAF4-10H-L   | D2.75       |
| LCAF4-14-L    | D2.73       |
| LCAF4-14F-L   | D2.77       |
| LCAF4-14H-L   | D2.75       |
| LCAF4-38-L    | D2.73       |
| LCAF4-38F-L   | D2.77       |
| LCAF4-38H-L   | D2.75       |
| LCAF4-56-L    | D2.73       |
| LCAF4-56F-L   | D2.77       |
| LCAF4-56H-L   | D2.75       |
| LCAF4/0-12-X  | D2.74       |
| LCAF4/0-12F-X | D2.78       |
| LCAF4/0-12H-X | D2.76       |
| LCAF4/0-14-X  | D2.74       |
| LCAF4/0-14F-X | D2.78       |
| LCAF4/0-14H-X | D2.76       |
| LCAF4/0-38-X  | D2.74       |
| LCAF4/0-38F-X | D2.78       |
| LCAF4/0-38H-X | D2.76       |
| LCAF4/0-56-X  | D2.74       |
| LCAF4/0-56F-X | D2.78       |
| LCAF4/0-56H-X | D2.76       |
| LCAF400-12-6  | D2.74       |
| LCAF400-12F-6 | D2.78       |
| LCAF400-12H-6 | D2.76       |
| LCAF400-58-6  | D2.74       |
| LCAF400-58F-6 | D2.78       |
| LCAF400-58H-6 | D2.76       |
| LCAF400-78-6  | D2.74       |
| LCAF400-78F-6 | D2.78       |
| LCAF400-78H-6 | D2.76       |
| LCAF500-12-6  | D2.74       |
| LCAF500-58-6  | D2.74       |
| LCAF6-10-L    | D2.73       |
| LCAF6-10F-L   | D2.77       |
| LCAF6-10H-L   | D2.75       |
| LCAF6-14-L    | D2.73       |
| LCAF6-14F-L   | D2.77       |
| LCAF6-14H-L   | D2.75       |
| LCAF6-38-L    | D2.73       |
| LCAF6-38F-L   | D2.77       |
| LCAF6-38H-L   | D2.75       |
| LCAF6-56-L    | D2.73       |
| LCAF6-56F-L   | D2.77       |
| LCAF6-56H-L   | D2.75       |
| LCAF600-12-6  | D2.74       |
| LCAF600-58-6  | D2.74       |
| LCAF750-12-3  | D2.74       |
| LCAF750-58-3  | D2.74       |
| LCAF8-10-L    | D2.73       |
| LCAF8-10F-L   | D2.77       |
| LCAF8-10H-L   | D2.75       |
| LCAF8-14-L    | D2.73       |
| LCAF8-14F-L   | D2.77       |
| LCAF8-14H-L   | D2.75       |
| LCAF8-38-L    | D2.73       |
| LCAF8-38F-L   | D2.77       |
| LCAF8-38H-L   | D2.75       |
| LCAF8-56-L    | D2.73       |
| LCAF8-56F-L   | D2.77       |
| LCAF8-56H-L   | D2.75       |
| LCAN1-10-E    | D2.19       |
| LCAN1-14-E    | D2.19       |
| LCAN1/0-10-X  | D2.19       |
| LCAN1/0-14-X  | D2.19       |
| LCAN1/0-56-X  | D2.19       |
| LCAN2-10-Q    | D2.19       |
| LCAN2-14-Q    | D2.19       |
| LCAN2/0-10-X  | D2.19       |

| Part Number   | Page Number |
|---------------|-------------|
| LCAN2/0-14-X  | D2.19       |
| LCAN2/0-38-X  | D2.19       |
| LCAN2/0-56-X  | D2.19       |
| LCAN250-14-X  | D2.20       |
| LCAN250-38-X  | D2.20       |
| LCAN3/0-14-X  | D2.19       |
| LCAN3/0-38-X  | D2.19       |
| LCAN3/0-56-X  | D2.19       |
| LCAN300-14-X  | D2.20       |
| LCAN300-38-X  | D2.20       |
| LCAN350-12-X  | D2.20       |
| LCAN350-38-X  | D2.20       |
| LCAN4-10-L    | D2.19       |
| LCAN4-14-L    | D2.19       |
| LCAN4/0-14-X  | D2.19       |
| LCAN4/0-38-X  | D2.19       |
| LCAN4/0-56-X  | D2.19       |
| LCAN400-12-6  | D2.20       |
| LCAN400-38-6  | D2.20       |
| LCAN500-12-6  | D2.20       |
| LCAN500-38-6  | D2.20       |
| LCAN6-6-L     | D2.19       |
| LCAN600-12-6  | D2.20       |
| LCAN600-38-6  | D2.20       |
| LCAN750-12-6  | D2.20       |
| LCAN750-38-6  | D2.20       |
| LCAN750-58-6  | D2.20       |
| LCAN8-6-L     | D2.19       |
| LCAS1-12-E    | D2.7        |
| LCAS1-12F-E   | D2.11       |
| LCAS1-12H-E   | D2.9        |
| LCAS1-14-E    | D2.7        |
| LCAS1-14F-E   | D2.11       |
| LCAS1-14H-E   | D2.9        |
| LCAS1-38-E    | D2.7        |
| LCAS1-38F-E   | D2.11       |
| LCAS1-38H-E   | D2.9        |
| LCAS1-56-E    | D2.7        |
| LCAS1-56F-E   | D2.11       |
| LCAS1-56H-E   | D2.9        |
| LCAS1/0-12-X  | D2.7        |
| LCAS1/0-12F-X | D2.11       |
| LCAS1/0-12H-X | D2.9        |
| LCAS1/0-14-X  | D2.7        |
| LCAS1/0-14F-X | D2.11       |
| LCAS1/0-14H-X | D2.9        |
| LCAS1/0-38-X  | D2.7        |
| LCAS1/0-38F-X | D2.11       |
| LCAS1/0-38H-X | D2.9        |
| LCAS1/0-56-X  | D2.7        |
| LCAS1/0-56F-X | D2.11       |
| LCAS1/0-56H-X | D2.9        |
| LCAS2-12-Q    | D2.7        |
| LCAS2-12F-Q   | D2.11       |
| LCAS2-12H-Q   | D2.9        |
| LCAS2-14-Q    | D2.7        |
| LCAS2-14F-Q   | D2.11       |
| LCAS2-14H-Q   | D2.9        |
| LCAS2-38-Q    | D2.7        |
| LCAS2-38F-Q   | D2.11       |
| LCAS2-38H-Q   | D2.9        |
| LCAS2-56-Q    | D2.7        |
| LCAS2-56F-Q   | D2.11       |
| LCAS2/0-12-X  | D2.7        |
| LCAS2/0-12F-X | D2.11       |
| LCAS2/0-12H-X | D2.9        |
| LCAS2/0-14-X  | D2.7        |
| LCAS2/0-14F-X | D2.11       |
| LCAS2/0-14H-X | D2.9        |
| LCAS2/0-38-X  | D2.7        |
| LCAS2/0-38F-X | D2.11       |
| LCAS2/0-38H-X | D2.9        |
| LCAS2/0-56-X  | D2.7        |
| LCAS2/0-56F-X | D2.11       |
| LCAS2/0-56H-X | D2.9        |
| LCAS250-12-X  | D2.8        |

|                                       |
|---------------------------------------|
| A. System Overview                    |
| B1. Cable Ties                        |
| B2. Cable Accessories                 |
| B3. Stainless Steel Ties              |
| C1. Wiring Duct                       |
| C2. Surface Raceway                   |
| C3. Abrasion Protection               |
| C4. Cable Management                  |
| D1. Terminals                         |
| D2. Power Connectors                  |
| D3. Grounding Connectors              |
| E1. Labeling Systems                  |
| E2. Labels                            |
| E3. Pre-Printed & Write-On Markers    |
| E4. Permanent Identification          |
| E5. Lockout/Tagout & Safety Solutions |
| F. Index                              |

# PANDUIT® ELECTRICAL SOLUTIONS

| A.<br>System<br>Overview                           | Part Number   | Page<br>Number | Part Number   | Page<br>Number | Part Number   | Page<br>Number |
|--|---------------|----------------|---------------|----------------|---------------|----------------|
| B1.<br>Cable Ties                                  | LCAS250-12F-X | D2.12          | LCAX1-14-X    | D2.66          | LCAX3/0-12F-X | D2.71          |
|  | LCAS250-12H-X | D2.10          | LCAX1-14F-X   | D2.70          | LCAX3/0-12H-X | D2.69          |
|  | LCAS250-14-X  | D2.8           | LCAX1-14H-X   | D2.68          | LCAX3/0-14-X  | D2.67          |
| B2.<br>Cable<br>Accessories                        | LCAS250-14F-X | D2.12          | LCAX1-38-X    | D2.66          | LCAX3/0-14F-X | D2.71          |
|  | LCAS250-14H-X | D2.10          | LCAX1-38F-X   | D2.70          | LCAX3/0-14H-X | D2.69          |
|  | LCAS250-38-X  | D2.8           | LCAX1-38H-X   | D2.68          | LCAX3/0-38-X  | D2.67          |
|  | LCAS250-38F-X | D2.12          | LCAX1-56-X    | D2.66          | LCAX3/0-38F-X | D2.71          |
|  | LCAS250-38H-X | D2.10          | LCAX1-56F-X   | D2.70          | LCAX3/0-38H-X | D2.69          |
|  | LCAS250-56-X  | D2.8           | LCAX1-56H-X   | D2.68          | LCAX3/0-56-X  | D2.67          |
| B3.<br>Stainless<br>Steel Ties                     | LCAS250-56F-X | D2.12          | LCAX1/0-12-X  | D2.67          | LCAX3/0-56F-X | D2.71          |
|  | LCAS250-56H-X | D2.10          | LCAX1/0-12F-X | D2.70          | LCAX3/0-56H-X | D2.69          |
|  | LCAS3/0-12-X  | D2.8           | LCAX1/0-12H-X | D2.68          | LCAX3/0-58-X  | D2.67          |
|  | LCAS3/0-12F-X | D2.12          | LCAX1/0-14-X  | D2.67          | LCAX300-12-6  | D2.67          |
| C1.<br>Wiring<br>Duct                              | LCAS3/0-12H-X | D2.10          | LCAX1/0-14F-X | D2.70          | LCAX300-12F-6 | D2.71          |
|  | LCAS3/0-14-X  | D2.8           | LCAX1/0-14H-X | D2.68          | LCAX300-12H-6 | D2.69          |
|  | LCAS3/0-14F-X | D2.12          | LCAX1/0-38-X  | D2.67          | LCAX300-38-6  | D2.67          |
| C2.<br>Surface<br>Raceway                          | LCAS3/0-14H-X | D2.10          | LCAX1/0-38F-X | D2.70          | LCAX300-38F-6 | D2.71          |
|  | LCAS3/0-38-X  | D2.8           | LCAX1/0-38H-X | D2.68          | LCAX300-38H-6 | D2.69          |
|  | LCAS3/0-38F-X | D2.12          | LCAX1/0-56-X  | D2.67          | LCAX300-58-6  | D2.67          |
|  | LCAS3/0-38H-X | D2.10          | LCAX1/0-56F-X | D2.70          | LCAX300-58F-6 | D2.71          |
|  | LCAS3/0-56-X  | D2.8           | LCAX1/0-56H-X | D2.68          | LCAX300-58H-6 | D2.69          |
|  | LCAS3/0-56F-X | D2.12          | LCAX1/0-58-X  | D2.67          | LCAX350-12-6  | D2.67          |
| C3.<br>Abrasion<br>Protection                      | LCAS3/0-56H-X | D2.10          | LCAX2-10-E    | D2.66          | LCAX350-12F-6 | D2.71          |
|  | LCAS4-10-L    | D2.7           | LCAX2-10F-E   | D2.70          | LCAX350-12H-6 | D2.69          |
|  | LCAS4-10F-L   | D2.11          | LCAX2-10H-E   | D2.68          | LCAX350-38-6  | D2.67          |
|  | LCAS4-10H-L   | D2.9           | LCAX2-12-E    | D2.66          | LCAX350-38F-6 | D2.71          |
|  | LCAS4-14-L    | D2.7           | LCAX2-12F-E   | D2.70          | LCAX350-38H-6 | D2.69          |
|  | LCAS4-14F-L   | D2.11          | LCAX2-12H-E   | D2.68          | LCAX350-56-6  | D2.67          |
| C4.<br>Cable<br>Management                         | LCAS4-14H-L   | D2.9           | LCAX2-14-E    | D2.66          | LCAX350-56F-6 | D2.71          |
|  | LCAS4-38-L    | D2.7           | LCAX2-14F-E   | D2.70          | LCAX350-56H-6 | D2.69          |
|  | LCAS4-38F-L   | D2.11          | LCAX2-14H-E   | D2.68          | LCAX350-58-6  | D2.67          |
|  | LCAS4-38H-L   | D2.9           | LCAX2-38-E    | D2.66          | LCAX350-58F-6 | D2.71          |
|  | LCAS4-56-L    | D2.7           | LCAX2-38F-E   | D2.70          | LCAX350-58H-6 | D2.69          |
|  | LCAS4-56F-L   | D2.11          | LCAX2-38H-E   | D2.68          | LCAX4-10-L    | D2.66          |
| D1.<br>Terminals                                   | LCAS4-56H-L   | D2.9           | LCAX2-56-E    | D2.66          | LCAX4-10F-L   | D2.70          |
|  | LCAS4/0-12-X  | D2.8           | LCAX2-56F-E   | D2.70          | LCAX4-10H-L   | D2.68          |
|  | LCAS4/0-12F-X | D2.12          | LCAX2-56H-E   | D2.68          | LCAX4-14-L    | D2.66          |
|  | LCAS4/0-12H-X | D2.10          | LCAX2/0-10-X  | D2.67          | LCAX4-14F-L   | D2.70          |
|  | LCAS4/0-14-X  | D2.8           | LCAX2/0-10F-X | D2.71          | LCAX4-14H-L   | D2.68          |
|  | LCAS4/0-14F-X | D2.12          | LCAX2/0-10H-X | D2.69          | LCAX4-38-L    | D2.66          |
| D2.<br>Power<br>Connectors                         | LCAS4/0-14H-X | D2.10          | LCAX2/0-12-X  | D2.67          | LCAX4-38F-L   | D2.70          |
|  | LCAS4/0-38-X  | D2.8           | LCAX2/0-12F-X | D2.71          | LCAX4-38H-L   | D2.68          |
|  | LCAS4/0-38F-X | D2.12          | LCAX2/0-12H-X | D2.69          | LCAX4-56-L    | D2.66          |
|  | LCAS4/0-38H-X | D2.10          | LCAX2/0-14-X  | D2.67          | LCAX4-56F-L   | D2.70          |
|  | LCAS4/0-56-X  | D2.8           | LCAX2/0-14F-X | D2.71          | LCAX4-56H-L   | D2.68          |
|  | LCAS4/0-56F-X | D2.12          | LCAX2/0-14H-X | D2.69          | LCAX4/0-12-X  | D2.67          |
| D3.<br>Grounding<br>Connectors                     | LCAS4/0-56H-X | D2.10          | LCAX2/0-38-X  | D2.67          | LCAX4/0-12F-X | D2.71          |
|  | LCAS6-10-L    | D2.7           | LCAX2/0-38F-X | D2.71          | LCAX4/0-12H-X | D2.69          |
|  | LCAS6-10F-L   | D2.11          | LCAX2/0-38H-X | D2.69          | LCAX4/0-14-X  | D2.67          |
|  | LCAS6-10H-L   | D2.9           | LCAX2/0-56-X  | D2.67          | LCAX4/0-14F-X | D2.71          |
|  | LCAS6-14-L    | D2.7           | LCAX2/0-56F-X | D2.71          | LCAX4/0-14H-X | D2.69          |
|  | LCAS6-14F-L   | D2.11          | LCAX2/0-56H-X | D2.69          | LCAX4/0-34-X  | D2.67          |
| E1.<br>Labeling<br>Systems                         | LCAS6-14H-L   | D2.9           | LCAX2/0-58-X  | D2.67          | LCAX4/0-34F-X | D2.71          |
|  | LCAS6-38-L    | D2.7           | LCAX2/0-58F-X | D2.71          | LCAX4/0-34H-X | D2.69          |
|  | LCAS6-38F-L   | D2.11          | LCAX2/0-58H-X | D2.69          | LCAX4/0-38-X  | D2.67          |
|  | LCAS6-38H-L   | D2.9           | LCAX250-12-X  | D2.67          | LCAX4/0-38F-X | D2.71          |
|  | LCAS6-56-L    | D2.7           | LCAX250-12F-X | D2.71          | LCAX4/0-38H-X | D2.69          |
|  | LCAS6-56F-L   | D2.11          | LCAX250-12H-X | D2.69          | LCAX4/0-56-X  | D2.67          |
| E2.<br>Labels                                      | LCAS6-56H-L   | D2.9           | LCAX250-14-X  | D2.67          | LCAX4/0-56F-X | D2.71          |
|  | LCAS8-10-L    | D2.7           | LCAX250-14F-X | D2.71          | LCAX4/0-56H-X | D2.69          |
|  | LCAS8-10F-L   | D2.11          | LCAX250-14H-X | D2.69          | LCAX4/0-58-X  | D2.67          |
|  | LCAS8-10H-L   | D2.9           | LCAX250-34-X  | D2.67          | LCAX4/0-58F-X | D2.71          |
|  | LCAS8-14-L    | D2.7           | LCAX250-34F-X | D2.71          | LCAX4/0-58H-X | D2.69          |
|  | LCAS8-14F-L   | D2.11          | LCAX250-34H-X | D2.69          | LCAX450-12-6  | D2.67          |
| E3.<br>Pre-Printed<br>& Write-On<br>Markers        | LCAS8-14H-L   | D2.9           | LCAX250-38-X  | D2.67          | LCAX450-12F-6 | D2.71          |
|  | LCAS8-38-L    | D2.7           | LCAX250-38F-X | D2.71          | LCAX450-12H-6 | D2.69          |
|  | LCAS8-38F-L   | D2.11          | LCAX250-38H-X | D2.69          | LCAX450-58-6  | D2.67          |
|  | LCAS8-38H-L   | D2.9           | LCAX250-56-X  | D2.67          | LCAX450-58F-6 | D2.71          |
|  | LCAS8-56-L    | D2.7           | LCAX250-56F-X | D2.71          | LCAX450-58H-6 | D2.69          |
|  | LCAS8-56F-L   | D2.11          | LCAX250-56H-X | D2.69          | LCAX500-12-6  | D2.67          |
| E4.<br>Permanent<br>Identification                 | LCAS8-56H-L   | D2.9           | LCAX250-58-X  | D2.67          | LCAX500-12F-6 | D2.71          |
|  | LCAS8-10-L    | D2.7           | LCAX250-58F-X | D2.71          | LCAX500-12H-6 | D2.69          |
|  | LCAS8-10F-L   | D2.11          | LCAX250-58H-X | D2.69          | LCAX500-38-6  | D2.67          |
|  | LCAS8-10H-L   | D2.9           | LCAX250-58H-X | D2.69          | LCAX500-38F-6 | D2.71          |
|  | LCAS8-14-L    | D2.7           | LCAX250-58H-X | D2.69          | LCAX500-38H-6 | D2.69          |
|  | LCAS8-14F-L   | D2.11          | LCAX250-58H-X | D2.69          | LCAX500-56-6  | D2.67          |
| E5.<br>Lockout/<br>Tagout<br>& Safety<br>Solutions | LCAS8-14H-L   | D2.9           | LCAX250-58H-X | D2.69          | LCAX500-56F-6 | D2.71          |
|  | LCAS8-38-L    | D2.7           | LCAX250-58H-X | D2.69          | LCAX500-56F-6 | D2.71          |
|  | LCAS8-38F-L   | D2.11          | LCAX250-58H-X | D2.69          | LCAX500-56F-6 | D2.71          |
|  | LCAS8-38H-L   | D2.9           | LCAX250-58H-X | D2.69          | LCAX500-56F-6 | D2.71          |
|  | LCAS8-56-L    | D2.7           | LCAX250-58H-X | D2.69          | LCAX500-56F-6 | D2.71          |
|  | LCAS8-56F-L   | D2.11          | LCAX250-58H-X | D2.69          | LCAX500-56F-6 | D2.71          |
| F.<br>Index  | LCAS8-56H-L   | D2.9           | LCAX250-58H-X | D2.69          | LCAX500-56F-6 | D2.71          |
|  | LCAX1-10-X    | D2.66          | LCAX250-58H-X | D2.69          | LCAX500-56F-6 | D2.71          |
|  | LCAX1-10F-X   | D2.70          | LCAX250-58H-X | D2.69          | LCAX500-56F-6 | D2.71          |
|  | LCAX1-10H-X   | D2.68          | LCAX250-58H-X | D2.69          | LCAX500-56F-6 | D2.71          |
|  | LCAX1-12-X    | D2.66          | LCAX250-58H-X | D2.69          | LCAX500-56F-6 | D2.71          |
|  | LCAX1-12F-X   | D2.70          | LCAX250-58H-X | D2.69          | LCAX500-56F-6 | D2.71          |
| LCAX1-12H-X  | D2.68         | LCAX250-58H-X  | D2.69         | LCAX500-56F-6  | D2.71         |                |



# PANDUIT® ELECTRICAL SOLUTIONS

| Part Number   | Page Number | Part Number  | Page Number | Part Number   | Page Number |
|---------------|-------------|--------------|-------------|---------------|-------------|
| LCAX500-56H-6 | D2.69       | LCB2-12-Q    | D2.22       | LCB6-14H-L    | D2.24       |
| LCAX500-58-6  | D2.67       | LCB2-14-Q    | D2.22       | LCB6-38-L     | D2.22       |
| LCAX500-58F-6 | D2.71       | LCB2-38-Q    | D2.22       | LCB6-38F-L    | D2.26       |
| LCAX500-58H-6 | D2.69       | LCB2-56-Q    | D2.22       | LCB6-38H-L    | D2.24       |
| LCAX6-10-L    | D2.66       | LCB2-56F-Q   | D2.26       | LCB600-12-6   | D2.23       |
| LCAX6-10F-L   | D2.70       | LCB2-56H-Q   | D2.24       | LCB600-12F-6  | D2.27       |
| LCAX6-10H-L   | D2.68       | LCB2/0-12-X  | D2.23       | LCB600-12H-6  | D2.25       |
| LCAX6-14-L    | D2.66       | LCB2/0-12F-X | D2.26       | LCB600-58-6   | D2.23       |
| LCAX6-14F-L   | D2.70       | LCB2/0-12H-X | D2.24       | LCB600-58F-6  | D2.27       |
| LCAX6-14H-L   | D2.68       | LCB2/0-38-X  | D2.23       | LCB600-58H-6  | D2.25       |
| LCAX6-38-L    | D2.66       | LCB2/0-38F-X | D2.26       | LCB750-12W-6  | D2.28       |
| LCAX6-38F-L   | D2.70       | LCB2/0-38H-X | D2.24       | LCB750-38W-6  | D2.28       |
| LCAX6-38H-L   | D2.68       | LCB250-12-X  | D2.23       | LCB750-58-6   | D2.23       |
| LCAX6-56-L    | D2.66       | LCB250-12F-X | D2.27       | LCB750-58W-6  | D2.28       |
| LCAX6-56F-L   | D2.70       | LCB250-12H-X | D2.25       | LCB750-78-6   | D2.23       |
| LCAX6-56H-L   | D2.68       | LCB250-78-X  | D2.23       | LCB750-78W-6  | D2.28       |
| LCAX650-12-6  | D2.67       | LCB250-78F-X | D2.27       | LCB8-10-L     | D2.22       |
| LCAX650-12F-6 | D2.71       | LCB250-78H-X | D2.25       | LCB8-10F-L    | D2.26       |
| LCAX650-12H-6 | D2.69       | LCB3/0-12-X  | D2.23       | LCB8-10H-L    | D2.24       |
| LCAX650-38-6  | D2.67       | LCB3/0-12F-X | D2.26       | LCB8-14-L     | D2.22       |
| LCAX650-38F-6 | D2.71       | LCB3/0-12H-X | D2.24       | LCB8-14F-L    | D2.26       |
| LCAX650-38H-6 | D2.69       | LCB3/0-38-X  | D2.23       | LCB8-14H-L    | D2.24       |
| LCAX650-56-6  | D2.67       | LCB3/0-38F-X | D2.26       | LCB8-38-L     | D2.22       |
| LCAX650-56F-6 | D2.71       | LCB3/0-38H-X | D2.24       | LCB800-12W-6  | D2.28       |
| LCAX650-56H-6 | D2.69       | LCB300-12-X  | D2.23       | LCB800-58-6   | D2.23       |
| LCAX650-58-6  | D2.67       | LCB300-12F-X | D2.27       | LCB800-58W-6  | D2.28       |
| LCAX650-58F-6 | D2.71       | LCB300-12H-X | D2.25       | LCBH1-38-E    | D2.30       |
| LCAX650-58H-6 | D2.69       | LCB300-38-X  | D2.23       | LCBH1/0-38-X  | D2.30       |
| LCAX750-12-3  | D2.67       | LCB300-38F-X | D2.27       | LCBH2-38-Q    | D2.30       |
| LCAX750-12F-3 | D2.71       | LCB300-38H-X | D2.25       | LCBH2/0-12-X  | D2.30       |
| LCAX750-12H-3 | D2.69       | LCB300-56-X  | D2.23       | LCBH250-12-X  | D2.30       |
| LCAX750-58-3  | D2.67       | LCB300-56F-X | D2.27       | LCBH3/0-12-X  | D2.30       |
| LCAX750-58F-3 | D2.71       | LCB300-56H-X | D2.25       | LCBH4-38-L    | D2.30       |
| LCAX750-58H-3 | D2.69       | LCB350-12-X  | D2.23       | LCBH4/0-12-X  | D2.30       |
| LCAX8-10-L    | D2.66       | LCB350-12F-X | D2.27       | LCBX1-14-X    | D2.79       |
| LCAX8-10F-L   | D2.70       | LCB350-12H-X | D2.25       | LCBX1-14F-X   | D2.81       |
| LCAX8-10H-L   | D2.68       | LCB350-78-X  | D2.23       | LCBX1-14H-X   | D2.80       |
| LCAX8-14-L    | D2.66       | LCB350-78F-X | D2.27       | LCBX1-38-X    | D2.79       |
| LCAX8-14F-L   | D2.70       | LCB350-78H-X | D2.25       | LCBX1-38F-X   | D2.81       |
| LCAX8-14H-L   | D2.68       | LCB4-10-L    | D2.22       | LCBX1-38H-X   | D2.80       |
| LCAX8-38-L    | D2.66       | LCB4-10F-L   | D2.26       | LCBX1-56-X    | D2.79       |
| LCAX8-38F-L   | D2.70       | LCB4-10H-L   | D2.24       | LCBX1-56F-X   | D2.81       |
| LCAX8-38H-L   | D2.68       | LCB4-14-L    | D2.22       | LCBX1-56H-X   | D2.80       |
| LCAX8-56-L    | D2.66       | LCB4-14F-L   | D2.26       | LCBX1/0-12-X  | D2.79       |
| LCAX8-56F-L   | D2.70       | LCB4-14H-L   | D2.24       | LCBX1/0-12F-X | D2.81       |
| LCAX8-56H-L   | D2.68       | LCB4-38-L    | D2.22       | LCBX1/0-12H-X | D2.80       |
| LCAXN750-12-3 | D2.72       | LCB4-56-L    | D2.22       | LCBX1/0-14-X  | D2.79       |
| LCB1-10-E     | D2.22       | LCB4/0-12-X  | D2.23       | LCBX1/0-14F-X | D2.81       |
| LCB1-10F-E    | D2.26       | LCB4/0-12F-X | D2.26       | LCBX1/0-14H-X | D2.80       |
| LCB1-10H-E    | D2.24       | LCB4/0-12H-X | D2.25       | LCBX1/0-38-X  | D2.79       |
| LCB1-12-E     | D2.22       | LCB4/0-38-X  | D2.23       | LCBX1/0-38F-X | D2.81       |
| LCB1-38-E     | D2.22       | LCB4/0-38F-X | D2.26       | LCBX1/0-38H-X | D2.80       |
| LCB1-56-E     | D2.22       | LCB4/0-38H-X | D2.25       | LCBX2-12-E    | D2.79       |
| LCB1-56F-E    | D2.26       | LCB400-12-6  | D2.23       | LCBX2-12F-E   | D2.81       |
| LCB1-56H-E    | D2.24       | LCB400-12F-6 | D2.27       | LCBX2-12H-E   | D2.80       |
| LCB1/0-10-X   | D2.22       | LCB400-12H-6 | D2.25       | LCBX2-14-E    | D2.79       |
| LCB1/0-10F-X  | D2.26       | LCB400-38-6  | D2.23       | LCBX2-14F-E   | D2.81       |
| LCB1/0-10H-X  | D2.24       | LCB400-58-6  | D2.23       | LCBX2-14H-E   | D2.80       |
| LCB1/0-12-X   | D2.22       | LCB400-58F-6 | D2.27       | LCBX2-38-E    | D2.79       |
| LCB1/0-12F-X  | D2.26       | LCB400-58H-6 | D2.25       | LCBX2-38F-E   | D2.81       |
| LCB1/0-12H-X  | D2.24       | LCB400-78-6  | D2.23       | LCBX2-38H-E   | D2.80       |
| LCB1/0-38-X   | D2.22       | LCB400-78F-6 | D2.27       | LCBX2/0-12-X  | D2.79       |
| LCB1/0-38F-X  | D2.26       | LCB400-78H-6 | D2.25       | LCBX2/0-12F-X | D2.81       |
| LCB1/0-38H-X  | D2.24       | LCB500-12-6  | D2.23       | LCBX2/0-12H-X | D2.80       |
| LCB1/0-56-X   | D2.22       | LCB500-12F-6 | D2.27       | LCBX2/0-14-X  | D2.79       |
| LCB1/0-56F-X  | D2.26       | LCB500-12H-6 | D2.25       | LCBX2/0-14F-X | D2.81       |
| LCB1/0-56H-X  | D2.24       | LCB500-58-6  | D2.23       | LCBX2/0-14H-X | D2.80       |
| LCB10-14W-L   | D2.28       | LCB500-58F-6 | D2.27       | LCBX2/0-38-X  | D2.79       |
| LCB10-14WF-L  | D2.29       | LCB500-58H-6 | D2.25       | LCBX2/0-38F-X | D2.81       |
| LCB10-14WH-L  | D2.29       | LCB500-78-6  | D2.23       | LCBX2/0-38H-X | D2.80       |
| LCB1000-12W-3 | D2.28       | LCB500-78F-6 | D2.27       | LCBX250-12-X  | D2.79       |
| LCB1000-38W-3 | D2.28       | LCB500-78H-6 | D2.25       | LCBX250-38-X  | D2.79       |
| LCB1000-58-3  | D2.23       | LCB6-10-L    | D2.22       | LCBX250-38F-X | D2.81       |
| LCB1000-58W-3 | D2.28       | LCB6-10F-L   | D2.26       | LCBX250-38H-X | D2.80       |
| LCB2-10-Q     | D2.22       | LCB6-10H-L   | D2.24       | LCBX250-58-X  | D2.79       |
| LCB2-10F-Q    | D2.26       | LCB6-14-L    | D2.22       | LCBX3/0-38-X  | D2.79       |
| LCB2-10H-Q    | D2.24       | LCB6-14F-L   | D2.26       | LCBX3/0-38F-X | D2.81       |

A.  
System  
Overview

B1.  
Cable Ties

B2.  
Cable  
Accessories

B3.  
Stainless  
Steel Ties

C1.  
Wiring  
Duct

C2.  
Surface  
Raceway

C3.  
Abrasion  
Protection

C4.  
Cable  
Management

D1.  
Terminals

D2.  
Power  
Connectors

D3.  
Grounding  
Connectors

E1.  
Labeling  
Systems

E2.  
Labels

E3.  
Pre-Printed  
& Write-On  
Markers

E4.  
Permanent  
Identification

E5.  
Lockout/  
Tagout  
& Safety  
Solutions

F.  
Index

| A. System Overview                    | Part Number   | Page Number | Part Number    | Page Number | Part Number    | Page Number |
|---------------------------------------|---------------|-------------|----------------|-------------|----------------|-------------|
| B1. Cable Ties                        | LCC1-00-E     | D2.57       | LCC1-0-00-X    | D2.57       | LCC2-12H-Q     | D2.43       |
|                                       | LCC1-12-E     | D2.41       | LCC1-0-00W-X   | D2.58       | LCC2-12W-Q     | D2.48       |
|                                       | LCC1-12F-E    | D2.46       | LCC1-0-12-X    | D2.42       | LCC2-12WF-Q    | D2.54       |
| B2. Cable Accessories                 | LCC1-12H-E    | D2.44       | LCC1-0-12D-X   | D2.42       | LCC2-12WH-Q    | D2.51       |
|                                       | LCC1-12H-E    | D2.44       | LCC1-0-12DF-X  | D2.46       | LCC2-14A-Q     | D2.41       |
|                                       | LCC1-12W-E    | D2.48       | LCC1-0-12DH-X  | D2.44       | LCC2-14AF-Q    | D2.45       |
| B3. Stainless Steel Ties              | LCC1-12WF-E   | D2.54       | LCC1-0-12DW-X  | D2.48       | LCC2-14AH-Q    | D2.43       |
|                                       | LCC1-12WH-E   | D2.51       | LCC1-0-12DWF-X | D2.54       | LCC2-14AW-Q    | D2.48       |
|                                       | LCC1-14A-E    | D2.41       | LCC1-0-12DWH-X | D2.51       | LCC2-14AWF-Q   | D2.54       |
| C1. Wiring Duct                       | LCC1-14AF-E   | D2.46       | LCC1-0-12F-X   | D2.46       | LCC2-14AWH-Q   | D2.51       |
|                                       | LCC1-14AH-E   | D2.44       | LCC1-0-12H-X   | D2.44       | LCC2-14B-Q     | D2.41       |
|                                       | LCC1-14AW-E   | D2.48       | LCC1-0-12W-X   | D2.48       | LCC2-14BF-Q    | D2.45       |
| C2. Surface Raceway                   | LCC1-14AWF-E  | D2.54       | LCC1-0-12WF-X  | D2.54       | LCC2-14BH-Q    | D2.43       |
|                                       | LCC1-14AHF-E  | D2.44       | LCC1-0-12WH-X  | D2.51       | LCC2-14BW-Q    | D2.48       |
|                                       | LCC1-14AWHF-E | D2.54       | LCC1-0-14A-X   | D2.42       | LCC2-14BWF-Q   | D2.54       |
| C3. Abrasion Protection               | LCC1-14B-E    | D2.41       | LCC1-0-14AF-X  | D2.46       | LCC2-14BWH-Q   | D2.51       |
|                                       | LCC1-14BF-E   | D2.46       | LCC1-0-14AH-X  | D2.44       | LCC2-14DW-Q    | D2.48       |
|                                       | LCC1-14BH-E   | D2.44       | LCC1-0-14AW-X  | D2.48       | LCC2-14DWF-Q   | D2.54       |
| C4. Cable Management                  | LCC1-14BHF-E  | D2.46       | LCC1-0-14AWF-X | D2.54       | LCC2-14DWH-Q   | D2.51       |
|                                       | LCC1-14BH-E   | D2.44       | LCC1-0-14B-X   | D2.42       | LCC2-38-Q      | D2.41       |
|                                       | LCC1-14BWH-E  | D2.44       | LCC1-0-14BF-X  | D2.46       | LCC2-38BW-Q    | D2.48       |
| D1. Terminals                         | LCC1-14BWF-E  | D2.53       | LCC1-0-14BH-X  | D2.44       | LCC2-38BWF-Q   | D2.54       |
|                                       | LCC1-14BW-E   | D2.48       | LCC1-0-14BW-X  | D2.48       | LCC2-38BWH-Q   | D2.51       |
|                                       | LCC1-14BWF-E  | D2.53       | LCC1-0-14BWH-X | D2.51       | LCC2-38CW-Q    | D2.48       |
| D2. Power Connectors                  | LCC1-14BWH-E  | D2.44       | LCC1-0-14DW-X  | D2.48       | LCC2-38CWF-Q   | D2.54       |
|                                       | LCC1-14BWHF-E | D2.54       | LCC1-0-14DWF-X | D2.54       | LCC2-38CWH-Q   | D2.51       |
|                                       | LCC1-14BWH-E  | D2.51       | LCC1-0-14DWH-X | D2.51       | LCC2-38D-Q     | D2.41       |
| D3. Grounding Connectors              | LCC1-14BWH-E  | D2.51       | LCC1-0-14DF-X  | D2.46       | LCC2-38DF-Q    | D2.45       |
|                                       | LCC1-14BWH-E  | D2.51       | LCC1-0-14DH-X  | D2.44       | LCC2-38DH-Q    | D2.43       |
|                                       | LCC1-14BWH-E  | D2.51       | LCC1-0-14DHF-X | D2.46       | LCC2-38DWH-Q   | D2.48       |
| E1. Labeling Systems                  | LCC1-14BWH-E  | D2.51       | LCC1-0-14DHF-X | D2.46       | LCC2-38DWF-Q   | D2.54       |
|                                       | LCC1-14BWH-E  | D2.51       | LCC1-0-14DHF-X | D2.46       | LCC2-38DWH-Q   | D2.51       |
|                                       | LCC1-14BWH-E  | D2.51       | LCC1-0-14DHF-X | D2.46       | LCC2-38F-Q     | D2.43       |
| E2. Labels                            | LCC1-14BWH-E  | D2.51       | LCC1-0-14DHF-X | D2.46       | LCC2-38H-Q     | D2.43       |
|                                       | LCC1-14BWH-E  | D2.51       | LCC1-0-14DHF-X | D2.46       | LCC2-38W-Q     | D2.48       |
|                                       | LCC1-14BWH-E  | D2.51       | LCC1-0-14DHF-X | D2.46       | LCC2-38WF-Q    | D2.54       |
| E3. Pre-Printed & Write-On Markers    | LCC1-14BWH-E  | D2.51       | LCC1-0-14DHF-X | D2.46       | LCC2-38WH-Q    | D2.51       |
|                                       | LCC1-14BWH-E  | D2.51       | LCC1-0-14DHF-X | D2.46       | LCC2-56B-Q     | D2.41       |
|                                       | LCC1-14BWH-E  | D2.51       | LCC1-0-14DHF-X | D2.46       | LCC2-56BF-Q    | D2.45       |
| E4. Permanent Identification          | LCC1-14BWH-E  | D2.51       | LCC1-0-14DHF-X | D2.46       | LCC2-56BH-Q    | D2.43       |
|                                       | LCC1-14BWH-E  | D2.51       | LCC1-0-14DHF-X | D2.46       | LCC2-56BW-Q    | D2.48       |
|                                       | LCC1-14BWH-E  | D2.51       | LCC1-0-14DHF-X | D2.46       | LCC2-56BWF-Q   | D2.54       |
| E5. Lockout/Tagout & Safety Solutions | LCC1-14BWH-E  | D2.51       | LCC1-0-14DHF-X | D2.46       | LCC2-56BWH-Q   | D2.51       |
|                                       | LCC1-14BWH-E  | D2.51       | LCC1-0-14DHF-X | D2.46       | LCC2-56C-Q     | D2.41       |
|                                       | LCC1-14BWH-E  | D2.51       | LCC1-0-14DHF-X | D2.46       | LCC2-56CF-Q    | D2.45       |
| F. Index                              | LCC1-14BWH-E  | D2.51       | LCC1-0-14DHF-X | D2.46       | LCC2-56CH-Q    | D2.43       |
|                                       | LCC1-14BWH-E  | D2.51       | LCC1-0-14DHF-X | D2.46       | LCC2-56CW-Q    | D2.48       |
|                                       | LCC1-14BWH-E  | D2.51       | LCC1-0-14DHF-X | D2.46       | LCC2-56CWF-Q   | D2.54       |
|                                       | LCC1-14BWH-E  | D2.51       | LCC1-0-14DHF-X | D2.46       | LCC2-0-00-X    | D2.57       |
|                                       | LCC1-14BWH-E  | D2.51       | LCC1-0-14DHF-X | D2.46       | LCC2-0-00W-X   | D2.58       |
|                                       | LCC1-14BWH-E  | D2.51       | LCC1-0-14DHF-X | D2.46       | LCC2-0-12-X    | D2.42       |
|                                       | LCC1-14BWH-E  | D2.51       | LCC1-0-14DHF-X | D2.46       | LCC2-0-12D-X   | D2.42       |
|                                       | LCC1-14BWH-E  | D2.51       | LCC1-0-14DHF-X | D2.46       | LCC2-0-12DF-X  | D2.46       |
|                                       | LCC1-14BWH-E  | D2.51       | LCC1-0-14DHF-X | D2.46       | LCC2-0-12DH-X  | D2.44       |
|                                       | LCC1-14BWH-E  | D2.51       | LCC1-0-14DHF-X | D2.46       | LCC2-0-12DW-X  | D2.48       |
|                                       | LCC1-14BWH-E  | D2.51       | LCC1-0-14DHF-X | D2.46       | LCC2-0-12DWF-X | D2.54       |
|                                       | LCC1-14BWH-E  | D2.51       | LCC1-0-14DHF-X | D2.46       | LCC2-0-12DWH-X | D2.51       |
|                                       | LCC1-14BWH-E  | D2.51       | LCC1-0-14DHF-X | D2.46       | LCC2-0-12F-X   | D2.46       |
|                                       | LCC1-14BWH-E  | D2.51       | LCC1-0-14DHF-X | D2.46       | LCC2-0-12H-X   | D2.44       |
|                                       | LCC1-14BWH-E  | D2.51       | LCC1-0-14DHF-X | D2.46       | LCC2-0-12W-X   | D2.48       |
|                                       | LCC1-14BWH-E  | D2.51       | LCC1-0-14DHF-X | D2.46       | LCC2-0-12WF-X  | D2.54       |
|                                       | LCC1-14BWH-E  | D2.51       | LCC1-0-14DHF-X | D2.46       | LCC2-0-12WH-X  | D2.51       |
|                                       | LCC1-14BWH-E  | D2.51       | LCC1-0-14DHF-X | D2.46       | LCC2-0-14A-X   | D2.42       |
|                                       | LCC1-14BWH-E  | D2.51       | LCC1-0-14DHF-X | D2.46       | LCC2-0-14AF-X  | D2.46       |
|                                       | LCC1-14BWH-E  | D2.51       | LCC1-0-14DHF-X | D2.46       | LCC2-0-14AH-X  | D2.44       |
|                                       | LCC1-14BWH-E  | D2.51       | LCC1-0-14DHF-X | D2.46       | LCC2-0-14AW-X  | D2.48       |
|                                       | LCC1-14BWH-E  | D2.51       | LCC1-0-14DHF-X | D2.46       | LCC2-0-14AWF-X | D2.54       |
|                                       | LCC1-14BWH-E  | D2.51       | LCC1-0-14DHF-X | D2.46       | LCC2-0-14AWH-X | D2.51       |
|                                       | LCC1-14BWH-E  | D2.51       | LCC1-0-14DHF-X | D2.46       | LCC2-0-14B-X   | D2.42       |
|                                       | LCC1-14BWH-E  | D2.51       | LCC1-0-14DHF-X | D2.46       | LCC2-0-14BF-X  | D2.46       |
|                                       | LCC1-14BWH-E  | D2.51       | LCC1-0-14DHF-X | D2.46       | LCC2-0-14BH-X  | D2.44       |
|                                       | LCC1-14BWH-E  | D2.51       | LCC1-0-14DHF-X | D2.46       | LCC2-0-14BW-X  | D2.48       |
|                                       | LCC1-14BWH-E  | D2.51       | LCC1-0-14DHF-X | D2.46       | LCC2-0-14BWF-X | D2.54       |
|                                       | LCC1-14BWH-E  | D2.51       | LCC1-0-14DHF-X | D2.46       | LCC2-0-14BWH-X | D2.51       |
|                                       | LCC1-14BWH-E  | D2.51       | LCC1-0-14DHF-X | D2.46       | LCC2-0-38D-X   | D2.42       |
|                                       | LCC1-14BWH-E  | D2.51       | LCC1-0-14DHF-X | D2.46       | LCC2-0-38DF-X  | D2.46       |
|                                       | LCC1-14BWH-E  | D2.51       | LCC1-0-14DHF-X | D2.46       | LCC2-12F-Q     | D2.41       |
|                                       | LCC1-14BWH-E  | D2.51       | LCC1-0-14DHF-X | D2.46       | LCC2-12G-Q     | D2.45       |

| Part Number    | Page Number |
|----------------|-------------|
| LCC2/0-38DH-X  | D2.44       |
| LCC2/0-38DW-X  | D2.48       |
| LCC2/0-38DWF-X | D2.54       |
| LCC2/0-38DWH-X | D2.51       |
| LCC2/0-56D-X   | D2.42       |
| LCC2/0-56DF-X  | D2.46       |
| LCC2/0-56DH-X  | D2.44       |
| LCC2/0-56DW-X  | D2.48       |
| LCC2/0-56DWF-X | D2.54       |
| LCC2/0-56DWH-X | D2.51       |
| LCC250-00-X    | D2.57       |
| LCC250-00W-X   | D2.58       |
| LCC250-12-X    | D2.42       |
| LCC250-12D-X   | D2.42       |
| LCC250-12DF-X  | D2.46       |
| LCC250-12DH-X  | D2.44       |
| LCC250-12DW-X  | D2.49       |
| LCC250-12DWF-X | D2.55       |
| LCC250-12DWH-X | D2.52       |
| LCC250-12F-X   | D2.46       |
| LCC250-12H-X   | D2.44       |
| LCC250-12W-X   | D2.49       |
| LCC250-12WF-X  | D2.55       |
| LCC250-12WH-X  | D2.52       |
| LCC250-38D-X   | D2.42       |
| LCC250-38DF-X  | D2.46       |
| LCC250-38DH-X  | D2.44       |
| LCC250-38DW-X  | D2.49       |
| LCC250-38DWF-X | D2.55       |
| LCC250-38DWH-X | D2.52       |
| LCC250-56DW-X  | D2.49       |
| LCC250-56DWF-X | D2.55       |
| LCC250-56DWH-X | D2.52       |
| LCC3/0-00-X    | D2.57       |
| LCC3/0-00W-X   | D2.58       |
| LCC3/0-12-X    | D2.42       |
| LCC3/0-12D-X   | D2.42       |
| LCC3/0-12DF-X  | D2.46       |
| LCC3/0-12DH-X  | D2.44       |
| LCC3/0-12DW-X  | D2.49       |
| LCC3/0-12DWF-X | D2.54       |
| LCC3/0-12DWH-X | D2.51       |
| LCC3/0-12F-X   | D2.46       |
| LCC3/0-12H-X   | D2.44       |
| LCC3/0-12W-X   | D2.49       |
| LCC3/0-12WF-X  | D2.54       |
| LCC3/0-12WH-X  | D2.51       |
| LCC3/0-14B-X   | D2.42       |
| LCC3/0-14BF-X  | D2.46       |
| LCC3/0-14BH-X  | D2.44       |
| LCC3/0-14BW-X  | D2.49       |
| LCC3/0-14BWF-X | D2.54       |
| LCC3/0-14BWH-X | D2.51       |
| LCC3/0-38D-X   | D2.42       |
| LCC3/0-38DF-X  | D2.46       |
| LCC3/0-38DH-X  | D2.44       |
| LCC3/0-38DW-X  | D2.49       |
| LCC3/0-38DWF-X | D2.54       |
| LCC3/0-38DWH-X | D2.51       |
| LCC3/0-56DW-X  | D2.49       |
| LCC3/0-56DWF-X | D2.54       |
| LCC3/0-56DWH-X | D2.51       |
| LCC300-00-X    | D2.57       |
| LCC300-00W-X   | D2.58       |
| LCC300-12-X    | D2.42       |
| LCC300-12F-X   | D2.46       |
| LCC300-12H-X   | D2.44       |
| LCC300-12W-X   | D2.49       |
| LCC300-12WF-X  | D2.55       |
| LCC300-12WH-X  | D2.52       |
| LCC300-38D-X   | D2.42       |
| LCC300-38DF-X  | D2.46       |
| LCC300-38DH-X  | D2.44       |
| LCC300-38DW-X  | D2.49       |
| LCC300-38DWF-X | D2.55       |
| LCC300-38DWH-X | D2.52       |
| LCC350-00-X    | D2.57       |

| Part Number    | Page Number |
|----------------|-------------|
| LCC350-00W-X   | D2.58       |
| LCC350-12-X    | D2.42       |
| LCC350-12F-X   | D2.46       |
| LCC350-12H-X   | D2.44       |
| LCC350-12W-X   | D2.49       |
| LCC350-12WF-X  | D2.55       |
| LCC350-12WH-X  | D2.52       |
| LCC350-14B-X   | D2.42       |
| LCC350-14BF-X  | D2.46       |
| LCC350-14BH-X  | D2.44       |
| LCC350-14BW-X  | D2.49       |
| LCC350-14BWF-X | D2.55       |
| LCC350-14BWH-X | D2.52       |
| LCC350-38D-X   | D2.42       |
| LCC350-38DF-X  | D2.46       |
| LCC350-38DH-X  | D2.44       |
| LCC350-38DW-X  | D2.49       |
| LCC350-38DWF-X | D2.55       |
| LCC350-38DWH-X | D2.52       |
| LCC4-00-L      | D2.57       |
| LCC4-00W-L     | D2.58       |
| LCC4-10AW-L    | D2.48       |
| LCC4-10AWF-L   | D2.54       |
| LCC4-10AWH-L   | D2.51       |
| LCC4-10BW-L    | D2.48       |
| LCC4-10BWF-L   | D2.54       |
| LCC4-10BWH-L   | D2.51       |
| LCC4-12-L      | D2.41       |
| LCC4-12W-L     | D2.48       |
| LCC4-14A-L     | D2.41       |
| LCC4-14ADW-L   | D2.48       |
| LCC4-14AF-L    | D2.45       |
| LCC4-14AH-L    | D2.43       |
| LCC4-14AW-L    | D2.48       |
| LCC4-14AWF-L   | D2.54       |
| LCC4-14AWH-L   | D2.51       |
| LCC4-14B-L     | D2.41       |
| LCC4-14BF-L    | D2.45       |
| LCC4-14BH-L    | D2.43       |
| LCC4-14BW-L    | D2.48       |
| LCC4-14BWF-L   | D2.54       |
| LCC4-14BWH-L   | D2.51       |
| LCC4-14DW-L    | D2.48       |
| LCC4-38D-L     | D2.41       |
| LCC4-38DF-L    | D2.45       |
| LCC4-38DH-L    | D2.43       |
| LCC4-38DW-L    | D2.48       |
| LCC4-38DWF-L   | D2.54       |
| LCC4-38DWH-L   | D2.51       |
| LCC4/0-00-X    | D2.57       |
| LCC4/0-00W-X   | D2.58       |
| LCC4/0-12-X    | D2.42       |
| LCC4/0-12D-X   | D2.42       |
| LCC4/0-12DF-X  | D2.46       |
| LCC4/0-12DH-X  | D2.44       |
| LCC4/0-12DW-X  | D2.49       |
| LCC4/0-12DWF-X | D2.54       |
| LCC4/0-12DWH-X | D2.51       |
| LCC4/0-12F-X   | D2.46       |
| LCC4/0-12H-X   | D2.44       |
| LCC4/0-12W-X   | D2.49       |
| LCC4/0-12WF-X  | D2.54       |
| LCC4/0-12WH-X  | D2.51       |
| LCC4/0-14AW-X  | D2.49       |
| LCC4/0-14AWF-X | D2.54       |
| LCC4/0-14AWH-X | D2.51       |
| LCC4/0-14B-X   | D2.42       |
| LCC4/0-14BF-X  | D2.46       |
| LCC4/0-14BH-X  | D2.44       |
| LCC4/0-14BW-X  | D2.49       |
| LCC4/0-14BWF-X | D2.54       |
| LCC4/0-14BWH-X | D2.51       |
| LCC4/0-38-X    | D2.42       |
| LCC4/0-38D-X   | D2.42       |
| LCC4/0-38DF-X  | D2.46       |
| LCC4/0-38DH-X  | D2.44       |
| LCC4/0-38DW-X  | D2.49       |

| Part Number    | Page Number |
|----------------|-------------|
| LCC4/0-38DWF-X | D2.54       |
| LCC4/0-38DWH-X | D2.51       |
| LCC4/0-38F-X   | D2.46       |
| LCC4/0-38H-X   | D2.44       |
| LCC4/0-38W-X   | D2.49       |
| LCC4/0-38WF-X  | D2.54       |
| LCC4/0-38WH-X  | D2.51       |
| LCC4/0-56D-X   | D2.42       |
| LCC4/0-56DF-X  | D2.46       |
| LCC4/0-56DH-X  | D2.44       |
| LCC4/0-56DW-X  | D2.49       |
| LCC4/0-56DWF-X | D2.54       |
| LCC4/0-56DWH-X | D2.51       |
| LCC400-00-6    | D2.57       |
| LCC400-00W-6   | D2.58       |
| LCC400-12-6    | D2.42       |
| LCC400-12F-6   | D2.46       |
| LCC400-12H-6   | D2.44       |
| LCC400-12W-6   | D2.49       |
| LCC400-12WF-6  | D2.55       |
| LCC400-12WH-6  | D2.52       |
| LCC400-14B-6   | D2.42       |
| LCC400-14BF-6  | D2.46       |
| LCC400-14BH-6  | D2.44       |
| LCC400-14BW-6  | D2.49       |
| LCC400-14BWF-6 | D2.55       |
| LCC400-14BWH-6 | D2.52       |
| LCC400-38D-6   | D2.42       |
| LCC400-38DF-6  | D2.46       |
| LCC400-38DH-6  | D2.44       |
| LCC400-38DW-6  | D2.49       |
| LCC400-38DWF-6 | D2.55       |
| LCC400-38DWH-6 | D2.52       |
| LCC500-00-6    | D2.57       |
| LCC500-00W-6   | D2.58       |
| LCC500-12-6    | D2.42       |
| LCC500-12F-6   | D2.46       |
| LCC500-12H-6   | D2.44       |
| LCC500-12W-6   | D2.49       |
| LCC500-12WF-6  | D2.55       |
| LCC500-12WH-6  | D2.52       |
| LCC500-14B-6   | D2.42       |
| LCC500-14BF-6  | D2.46       |
| LCC500-14BH-6  | D2.44       |
| LCC500-14BW-6  | D2.49       |
| LCC500-14BWF-6 | D2.55       |
| LCC500-14BWH-6 | D2.52       |
| LCC500-38D-6   | D2.42       |
| LCC500-38DF-6  | D2.46       |
| LCC500-38DH-6  | D2.44       |
| LCC500-38DW-6  | D2.49       |
| LCC500-38DWF-6 | D2.55       |
| LCC500-38DWH-6 | D2.52       |
| LCC6-00-L      | D2.57       |
| LCC6-00W-L     | D2.58       |
| LCC6-10A-L     | D2.41       |
| LCC6-10ABW-L   | D2.47       |
| LCC6-10AF-L    | D2.45       |
| LCC6-10AH-L    | D2.43       |
| LCC6-10AW-L    | D2.47       |
| LCC6-10AWF-L   | D2.53       |
| LCC6-10AWH-L   | D2.50       |
| LCC6-10BW-L    | D2.47       |
| LCC6-10BWF-L   | D2.53       |
| LCC6-10BWH-L   | D2.50       |
| LCC6-12-L      | D2.41       |
| LCC6-12W-L     | D2.47       |
| LCC6-14A-L     | D2.41       |
| LCC6-14AF-L    | D2.45       |
| LCC6-14AH-L    | D2.43       |
| LCC6-14AW-L    | D2.47       |
| LCC6-14AWF-L   | D2.53       |
| LCC6-14AWH-L   | D2.50       |
| LCC6-14B-L     | D2.41       |
| LCC6-14BDW-L   | D2.47       |
| LCC6-14BF-L    | D2.45       |
| LCC6-14BH-L    | D2.43       |

|  |
|--|
| A. System Overview                     |
| B1. Cable Ties                         |
| B2. Cable Accessories                  |
| B3. Stainless Steel Ties               |
| C1. Wiring Duct                        |
| C2. Surface Raceway                    |
| C3. Abrasion Protection                |
| C4. Cable Management                   |
| D1. Terminals                          |
| D2. Power Connectors                   |
| D3. Grounding Connectors               |
| E1. Labeling Systems                   |
| E2. Labels                             |
| E3. Pre-Printed & Write-On Markers     |
| E4. Permanent Identification           |
| E5. Lockout/ Tagout & Safety Solutions |
| F. Index                               |

| A. System Overview                    | Part Number    | Page Number | Part Number    | Page Number | Part Number    | Page Number |
|---------------------------------------|----------------|-------------|----------------|-------------|----------------|-------------|
| B1. Cable Ties                        | LCC6-14BW-L    | D2.47       | LCC8-14BWF-L   | D2.53       | LCCF250-12H-X  | D2.99       |
|                                       | LCC6-14BWF-L   | D2.53       | LCC8-14BWH-L   | D2.50       | LCCF250-14B-X  | D2.97       |
|                                       | LCC6-14BWH-L   | D2.50       | LCC8-14D-L     | D2.41       | LCCF250-14BF-X | D2.101      |
| B2. Cable Accessories                 | LCC6-14D-L     | D2.41       | LCC8-14DF-L    | D2.45       | LCCF250-14BH-X | D2.99       |
|                                       | LCC6-14DF-L    | D2.45       | LCC8-14DH-L    | D2.43       | LCCF250-38D-X  | D2.97       |
|                                       | LCC6-14DH-L    | D2.43       | LCC8-14DW-L    | D2.47       | LCCF250-38DF-X | D2.101      |
|                                       | LCC6-14DW-L    | D2.47       | LCC8-14DWF-L   | D2.53       | LCCF250-38DH-X | D2.99       |
|                                       | LCC6-14DWF-L   | D2.53       | LCC8-14DWH-L   | D2.50       | LCCF3/0-12-X   | D2.97       |
| B3. Stainless Steel Ties              | LCC6-14DWH-L   | D2.50       | LCC8-38D-L     | D2.41       | LCCF3/0-12F-X  | D2.100      |
|                                       | LCC6-14EW-L    | D2.47       | LCC8-38DF-L    | D2.45       | LCCF3/0-12H-X  | D2.98       |
|                                       | LCC6-14EWF-L   | D2.53       | LCC8-38DH-L    | D2.43       | LCCF3/0-14B-X  | D2.97       |
|                                       | LCC6-14EWH-L   | D2.50       | LCC8-38DW-L    | D2.47       | LCCF3/0-14BF-X | D2.100      |
| C1. Wiring Duct                       | LCC6-14JAW-L   | D2.47       | LCC8-38DWF-L   | D2.53       | LCCF3/0-14BH-X | D2.98       |
|                                       | LCC6-14JAWF-L  | D2.53       | LCC8-38DWH-L   | D2.50       | LCCF3/0-38D-X  | D2.97       |
|                                       | LCC6-14JAWH-L  | D2.50       | LCC800-12-6    | D2.42       | LCCF3/0-38DF-X | D2.100      |
| C2. Surface Raceway                   | LCC6-14JW-L    | D2.47       | LCC800-12W-6   | D2.49       | LCCF3/0-38DH-X | D2.98       |
|                                       | LCC6-14JWF-L   | D2.53       | LCCF1-12-X     | D2.96       | LCCF300-12-6   | D2.97       |
|                                       | LCC6-14JWH-L   | D2.50       | LCCF1-12F-X    | D2.100      | LCCF300-12F-6  | D2.101      |
|                                       | LCC6-14W-L     | D2.47       | LCCF1-12H-X    | D2.98       | LCCF300-12H-6  | D2.99       |
|                                       | LCC6-38BDW-L   | D2.47       | LCCF1-14A-X    | D2.96       | LCCF300-14B-6  | D2.97       |
| C3. Abrasion Protection               | LCC6-38BW-L    | D2.47       | LCCF1-14AF-X   | D2.100      | LCCF300-14BF-6 | D2.101      |
|                                       | LCC6-38BWF-L   | D2.53       | LCCF1-14AH-X   | D2.98       | LCCF300-14BH-6 | D2.99       |
|                                       | LCC6-38BWH-L   | D2.50       | LCCF1-14B-X    | D2.96       | LCCF300-14BH-6 | D2.97       |
|                                       | LCC6-38CW-L    | D2.47       | LCCF1-14BF-X   | D2.100      | LCCF300-38DF-6 | D2.101      |
|                                       | LCC6-38CWF-L   | D2.53       | LCCF1-14BH-X   | D2.98       | LCCF300-38DH-6 | D2.99       |
| C4. Cable Management                  | LCC6-38CWH-L   | D2.50       | LCCF1-38D-X    | D2.96       | LCCF350-12-6   | D2.97       |
|                                       | LCC6-38D-L     | D2.41       | LCCF1-38DF-X   | D2.100      | LCCF350-12E-6  | D2.97       |
|                                       | LCC6-38DF-L    | D2.45       | LCCF1-38DH-X   | D2.98       | LCCF350-12EF-6 | D2.101      |
|                                       | LCC6-38DH-L    | D2.43       | LCCF1-56C-X    | D2.96       | LCCF350-12EH-6 | D2.99       |
|                                       | LCC6-38DW-L    | D2.47       | LCCF1-56CF-X   | D2.100      | LCCF350-12F-6  | D2.101      |
| D1. Terminals                         | LCC6-38DWF-L   | D2.53       | LCCF1-56CH-X   | D2.98       | LCCF350-12H-6  | D2.99       |
|                                       | LCC6-38DWH-L   | D2.50       | LCCF1/0-12-X   | D2.97       | LCCF350-14B-6  | D2.97       |
|                                       | LCC6-56BW-L    | D2.47       | LCCF1/0-12F-X  | D2.100      | LCCF350-14BF-6 | D2.101      |
|                                       | LCC6-56BWF-L   | D2.53       | LCCF1/0-12H-X  | D2.98       | LCCF350-14BH-6 | D2.99       |
|                                       | LCC6-56BWH-L   | D2.50       | LCCF1/0-14A-X  | D2.97       | LCCF350-38D-6  | D2.97       |
|                                       | LCC600-00-6    | D2.57       | LCCF1/0-14AF-X | D2.100      | LCCF350-38DF-6 | D2.101      |
|                                       | LCC600-00W-6   | D2.58       | LCCF1/0-14AH-X | D2.98       | LCCF350-38DH-6 | D2.99       |
|                                       | LCC600-12-6    | D2.42       | LCCF1/0-14B-X  | D2.97       | LCCF4-14A-L    | D2.96       |
|                                       | LCC600-12F-6   | D2.46       | LCCF1/0-14BF-X | D2.100      | LCCF4-14AF-L   | D2.100      |
|                                       | LCC600-12H-6   | D2.44       | LCCF1/0-14BH-X | D2.98       | LCCF4-14AH-L   | D2.98       |
| D2. Power Connectors                  | LCC600-12W-6   | D2.49       | LCCF1/0-38D-X  | D2.97       | LCCF4-14B-L    | D2.96       |
|                                       | LCC600-12WF-6  | D2.55       | LCCF1/0-38DF-X | D2.100      | LCCF4-14BF-L   | D2.100      |
|                                       | LCC600-12WH-6  | D2.52       | LCCF1/0-38DH-X | D2.98       | LCCF4-14BH-L   | D2.98       |
|                                       | LCC600-38D-6   | D2.42       | LCCF1/0-56C-X  | D2.97       | LCCF4-38D-L    | D2.96       |
|                                       | LCC600-38DF-6  | D2.46       | LCCF1/0-56CF-X | D2.100      | LCCF4-38DH-L   | D2.98       |
| D3. Grounding Connectors              | LCC600-38DH-6  | D2.44       | LCCF1/0-56CH-X | D2.98       | LCCF4/0-12-X   | D2.97       |
|                                       | LCC600-38DW-6  | D2.49       | LCCF2-12-E     | D2.96       | LCCF4/0-12F-X  | D2.101      |
|                                       | LCC600-38DWF-6 | D2.55       | LCCF2-12F-E    | D2.100      | LCCF4/0-12H-X  | D2.99       |
|                                       | LCC600-38DWH-6 | D2.52       | LCCF2-12H-E    | D2.98       | LCCF4/0-14B-X  | D2.97       |
|                                       | LCC750-00-6    | D2.57       | LCCF2-14A-E    | D2.96       | LCCF4/0-14BF-X | D2.101      |
| E1. Labeling Systems                  | LCC750-12-6    | D2.42       | LCCF2-14AH-E   | D2.98       | LCCF4/0-14BH-X | D2.99       |
|                                       | LCC750-12W-6   | D2.49       | LCCF2-14B-E    | D2.96       | LCCF4/0-38-X   | D2.97       |
|                                       | LCC750-38D-6   | D2.42       | LCCF2-14BF-E   | D2.100      | LCCF4/0-38D-X  | D2.97       |
| E2. Labels                            | LCC750-38DW-6  | D2.49       | LCCF2-14BH-E   | D2.98       | LCCF4/0-38DF-X | D2.101      |
|                                       | LCC8-00-L      | D2.57       | LCCF2-38D-E    | D2.96       | LCCF4/0-38DH-X | D2.99       |
|                                       | LCC8-00W-L     | D2.58       | LCCF2-38DF-E   | D2.100      | LCCF4/0-38F-X  | D2.101      |
|                                       | LCC8-10A-L     | D2.41       | LCCF2-38DH-E   | D2.98       | LCCF4/0-38H-X  | D2.99       |
|                                       | LCC8-10ABW-L   | D2.47       | LCCF2-56B-E    | D2.96       | LCCF400-12-6   | D2.97       |
| E3. Pre-Printed & Write-On Markers    | LCC8-10AF-L    | D2.45       | LCCF2-56BF-E   | D2.100      | LCCF400-12F-6  | D2.101      |
|                                       | LCC8-10AH-L    | D2.43       | LCCF2-56BH-E   | D2.98       | LCCF400-12H-6  | D2.99       |
|                                       | LCC8-10AW-L    | D2.47       | LCCF2/0-12-X   | D2.97       | LCCF400-38D-6  | D2.97       |
|                                       | LCC8-10AWF-L   | D2.53       | LCCF2/0-12F-X  | D2.100      | LCCF400-38DF-6 | D2.101      |
|                                       | LCC8-10AWH-L   | D2.50       | LCCF2/0-12H-X  | D2.98       | LCCF400-38DH-6 | D2.99       |
| E4. Permanent Identification          | LCC8-10BW-L    | D2.47       | LCCF2/0-14A-X  | D2.97       | LCCF500-12-6   | D2.97       |
|                                       | LCC8-10BWF-L   | D2.53       | LCCF2/0-14AF-X | D2.100      | LCCF500-12F-6  | D2.101      |
|                                       | LCC8-10BWH-L   | D2.50       | LCCF2/0-14AH-X | D2.98       | LCCF500-12H-6  | D2.99       |
|                                       | LCC8-14A-L     | D2.41       | LCCF2/0-14B-X  | D2.97       | LCCF6-14A-L    | D2.96       |
|                                       | LCC8-14ABW-L   | D2.47       | LCCF2/0-14BF-X | D2.100      | LCCF6-14AF-L   | D2.100      |
| E5. Lockout/Tagout & Safety Solutions | LCC8-14AF-L    | D2.45       | LCCF2/0-14BH-X | D2.98       | LCCF6-14AH-L   | D2.98       |
|                                       | LCC8-14AH-L    | D2.43       | LCCF2/0-38D-X  | D2.97       | LCCF6-14B-L    | D2.96       |
|                                       | LCC8-14AW-L    | D2.47       | LCCF2/0-38DF-X | D2.100      | LCCF6-14BF-L   | D2.100      |
|                                       | LCC8-14AWF-L   | D2.53       | LCCF2/0-38DH-X | D2.98       | LCCF6-14BH-L   | D2.98       |
|                                       | LCC8-14AWH-L   | D2.50       | LCCF250-12-X   | D2.97       | LCCF6-38D-L    | D2.96       |
| F. Index                              | LCC8-14B-L     | D2.41       | LCCF250-12E-X  | D2.97       | LCCF6-38DF-L   | D2.100      |
|                                       | LCC8-14BF-L    | D2.45       | LCCF250-12EF-X | D2.101      | LCCF6-38DH-L   | D2.98       |
|                                       | LCC8-14BH-L    | D2.43       | LCCF250-12EH-X | D2.99       | LCCF600-12-6   | D2.97       |
|                                       | LCC8-14BW-L    | D2.47       | LCCF250-12F-X  | D2.101      | LCCF600-12F-6  | D2.101      |



# PANDUIT® ELECTRICAL SOLUTIONS

| Part Number    | Page Number |
|----------------|-------------|
| LCCF600-12H-6  | D2.99       |
| LCCF750-12-3   | D2.97       |
| LCCF750-12F-3  | D2.101      |
| LCCF750-12H-3  | D2.99       |
| LCCF750-38D-3  | D2.97       |
| LCCF750-38DF-3 | D2.101      |
| LCCF750-38DH-3 | D2.99       |
| LCCF8-14A-L    | D2.96       |
| LCCF8-14AF-L   | D2.100      |
| LCCF8-14AH-L   | D2.98       |
| LCCF8-14B-L    | D2.96       |
| LCCF8-14BF-L   | D2.100      |
| LCCF8-14BH-L   | D2.98       |
| LCCF8-38D-L    | D2.96       |
| LCCF8-38DF-L   | D2.100      |
| LCCF8-38DH-L   | D2.98       |
| LCCH1/0-12-X   | D2.56       |
| LCCH1000-12-3  | D2.56       |
| LCCH2/0-12-X   | D2.56       |
| LCCH250-12-X   | D2.56       |
| LCCH3/0-12-X   | D2.56       |
| LCCH300-12-X   | D2.56       |
| LCCH350-12-X   | D2.56       |
| LCCH4/0-12-X   | D2.56       |
| LCCH400-12-6   | D2.56       |
| LCCH500-12-6   | D2.56       |
| LCCH600-12-6   | D2.56       |
| LCCH750-12-6   | D2.56       |
| LCCN750-12W-6  | D2.55       |
| LCCN750-38DW-6 | D2.55       |
| LCCX1-14A-X    | D2.91       |
| LCCX1-14AF-X   | D2.94       |
| LCCX1-14AH-X   | D2.92       |
| LCCX1-14B-X    | D2.91       |
| LCCX1-14BF-X   | D2.94       |
| LCCX1-14BH-X   | D2.92       |
| LCCX1-14D-X    | D2.91       |
| LCCX1-14DF-X   | D2.94       |
| LCCX1-14DH-X   | D2.92       |
| LCCX1-38D-X    | D2.91       |
| LCCX1-38DF-X   | D2.94       |
| LCCX1-38DH-X   | D2.92       |
| LCCX1-56C-X    | D2.91       |
| LCCX1-56CF-X   | D2.94       |
| LCCX1-56CH-X   | D2.92       |
| LCCX1-56D-X    | D2.91       |
| LCCX1-56DF-X   | D2.94       |
| LCCX1-56DH-X   | D2.92       |
| LCCX1/0-12-X   | D2.91       |
| LCCX1/0-12F-X  | D2.94       |
| LCCX1/0-12H-X  | D2.93       |
| LCCX1/0-14A-X  | D2.91       |
| LCCX1/0-14AF-X | D2.94       |
| LCCX1/0-14AH-X | D2.93       |
| LCCX1/0-14B-X  | D2.91       |
| LCCX1/0-14BF-X | D2.94       |
| LCCX1/0-14BH-X | D2.93       |
| LCCX1/0-38D-X  | D2.91       |
| LCCX1/0-38DF-X | D2.94       |
| LCCX1/0-38DH-X | D2.93       |
| LCCX2-12-E     | D2.91       |
| LCCX2-12F-E    | D2.94       |
| LCCX2-12H-E    | D2.92       |
| LCCX2-14A-E    | D2.91       |
| LCCX2-14AF-E   | D2.94       |
| LCCX2-14AH-E   | D2.92       |
| LCCX2-14B-E    | D2.91       |
| LCCX2-14BF-E   | D2.94       |
| LCCX2-14BH-E   | D2.92       |
| LCCX2-38D-E    | D2.91       |
| LCCX2-38DF-E   | D2.94       |
| LCCX2-38DH-E   | D2.92       |
| LCCX2/0-12-X   | D2.91       |
| LCCX2/0-12F-X  | D2.95       |
| LCCX2/0-12H-X  | D2.93       |
| LCCX2/0-14A-X  | D2.91       |
| LCCX2/0-14AF-X | D2.95       |

| Part Number    | Page Number |
|----------------|-------------|
| LCCX2/0-14AH-X | D2.93       |
| LCCX2/0-14B-X  | D2.91       |
| LCCX2/0-14BF-X | D2.95       |
| LCCX2/0-14BH-X | D2.93       |
| LCCX2/0-38D-X  | D2.91       |
| LCCX2/0-38DF-X | D2.95       |
| LCCX2/0-38DH-X | D2.93       |
| LCCX250-12-X   | D2.91       |
| LCCX250-14B-X  | D2.91       |
| LCCX250-14BF-X | D2.95       |
| LCCX250-14BH-X | D2.93       |
| LCCX250-38D-X  | D2.91       |
| LCCX250-38DF-X | D2.95       |
| LCCX250-38DH-X | D2.93       |
| LCCX3/0-14B-X  | D2.91       |
| LCCX3/0-14BF-X | D2.95       |
| LCCX3/0-14BH-X | D2.93       |
| LCCX3/0-38D-X  | D2.91       |
| LCCX3/0-38DF-X | D2.95       |
| LCCX3/0-38DH-X | D2.93       |
| LCCX300-38D-6  | D2.91       |
| LCCX300-38DF-6 | D2.95       |
| LCCX300-38DH-6 | D2.93       |
| LCCX350-12-6   | D2.91       |
| LCCX350-12F-6  | D2.95       |
| LCCX350-12H-6  | D2.93       |
| LCCX350-14B-6  | D2.91       |
| LCCX350-14BF-6 | D2.95       |
| LCCX350-14BH-6 | D2.93       |
| LCCX350-38D-6  | D2.91       |
| LCCX350-38DF-6 | D2.95       |
| LCCX350-38DH-6 | D2.93       |
| LCCX4-14A-L    | D2.90       |
| LCCX4-14AB-L   | D2.90       |
| LCCX4-14AF-L   | D2.94       |
| LCCX4-14AH-L   | D2.92       |
| LCCX4-14B-L    | D2.90       |
| LCCX4-14BF-L   | D2.94       |
| LCCX4-14BH-L   | D2.92       |
| LCCX4-14CE-L   | D2.90       |
| LCCX4-38B-L    | D2.90       |
| LCCX4-38BD-L   | D2.90       |
| LCCX4-38BF-L   | D2.94       |
| LCCX4-38BH-L   | D2.92       |
| LCCX4-38D-L    | D2.90       |
| LCCX4-38DF-L   | D2.94       |
| LCCX4-38DH-L   | D2.92       |
| LCCX4/0-12-X   | D2.91       |
| LCCX4/0-12F-X  | D2.95       |
| LCCX4/0-12H-X  | D2.93       |
| LCCX4/0-14B-X  | D2.91       |
| LCCX4/0-14BF-X | D2.95       |
| LCCX4/0-14BH-X | D2.93       |
| LCCX4/0-38D-X  | D2.91       |
| LCCX4/0-38DF-X | D2.95       |
| LCCX4/0-38DH-X | D2.93       |
| LCCX450-12-6   | D2.91       |
| LCCX500-12-6   | D2.91       |
| LCCX500-38D-6  | D2.91       |
| LCCX6-10B-L    | D2.90       |
| LCCX6-10BF-L   | D2.94       |
| LCCX6-10BH-L   | D2.92       |
| LCCX6-14A-L    | D2.90       |
| LCCX6-14AB-L   | D2.90       |
| LCCX6-14AF-L   | D2.94       |
| LCCX6-14AH-L   | D2.92       |
| LCCX6-14B-L    | D2.90       |
| LCCX6-14BF-L   | D2.94       |
| LCCX6-14BH-L   | D2.92       |
| LCCX6-14D-L    | D2.90       |
| LCCX6-14DF-L   | D2.94       |
| LCCX6-14DH-L   | D2.92       |
| LCCX6-38A-L    | D2.90       |
| LCCX6-38AC-L   | D2.90       |
| LCCX6-38AF-L   | D2.94       |
| LCCX6-38AH-L   | D2.92       |
| LCCX6-38C-L    | D2.90       |

| Part Number          | Page Number  |
|----------------------|--------------|
| LCCX6-38CF-L         | D2.94        |
| LCCX6-38CH-L         | D2.92        |
| LCCX6-38D-L          | D2.90        |
| LCCX6-38DF-L         | D2.94        |
| LCCX6-38DH-L         | D2.92        |
| LCCX650-12-6         | D2.91        |
| LCCX8-10A-L          | D2.90        |
| LCCX8-10AB-L         | D2.90        |
| LCCX8-10AF-L         | D2.94        |
| LCCX8-10AH-L         | D2.92        |
| LCCX8-10B-L          | D2.90        |
| LCCX8-10BF-L         | D2.94        |
| LCCX8-10BH-L         | D2.92        |
| LCCX8-14A-L          | D2.90        |
| LCCX8-14AB-L         | D2.90        |
| LCCX8-14AF-L         | D2.94        |
| LCCX8-14AH-L         | D2.92        |
| LCCX8-14B-L          | D2.90        |
| LCCX8-14BF-L         | D2.94        |
| LCCX8-14BH-L         | D2.92        |
| LCCX8-14D-L          | D2.90        |
| LCCX8-14DF-L         | D2.94        |
| LCCX8-14DH-L         | D2.92        |
| LCCX8-38D-L          | D2.90        |
| LCCX8-38DF-L         | D2.94        |
| LCCX8-38DH-L         | D2.92        |
| <b>LCCXN450-12-6</b> | <b>D2.95</b> |
| <b>LCCXN500-12-6</b> | <b>D2.95</b> |
| <b>LCCXN650-12-6</b> | <b>D2.95</b> |
| LCD1-12-E            | D2.32        |
| LCD1-12F-E           | D2.36        |
| LCD1-12H-E           | D2.34        |
| LCD1-14A-E           | D2.32        |
| LCD1-14AF-E          | D2.36        |
| LCD1-14AH-E          | D2.34        |
| LCD1-14B-E           | D2.32        |
| LCD1-14BF-E          | D2.36        |
| LCD1-14BH-E          | D2.34        |
| LCD1-38D-E           | D2.32        |
| LCD1-38DF-E          | D2.36        |
| LCD1-38DH-E          | D2.34        |
| LCD1-56C-E           | D2.32        |
| LCD1-56CF-E          | D2.36        |
| LCD1-56CH-E          | D2.34        |
| LCD1/0-00-X          | D2.40        |
| LCD1/0-12-X          | D2.32        |
| LCD1/0-12F-X         | D2.36        |
| LCD1/0-12H-X         | D2.34        |
| LCD1/0-14A-X         | D2.32        |
| LCD1/0-14AF-X        | D2.36        |
| LCD1/0-14AH-X        | D2.34        |
| LCD1/0-14B-X         | D2.32        |
| LCD1/0-14BF-X        | D2.36        |
| LCD1/0-14BH-X        | D2.34        |
| LCD1/0-38D-X         | D2.32        |
| LCD1/0-38DF-X        | D2.36        |
| LCD1/0-38DH-X        | D2.34        |
| LCD1/0-56C-X         | D2.32        |
| LCD1/0-56CF-X        | D2.36        |
| LCD1/0-56CH-X        | D2.34        |
| LCD10-10A-L          | D2.31        |
| LCD10-10AF-L         | D2.35        |
| LCD10-10AH-L         | D2.33        |
| LCD10-14A-L          | D2.31        |
| LCD10-14AF-L         | D2.35        |
| LCD10-14AH-L         | D2.33        |
| LCD10-14B-L          | D2.31        |
| LCD10-14D-L          | D2.31        |
| LCD10-38D-L          | D2.31        |
| LCD10-38DF-L         | D2.35        |
| LCD10-38DH-L         | D2.33        |
| LCD1000-00-3         | D2.40        |
| LCD1000-12-3         | D2.32        |
| LCD1000-12E-3        | D2.32        |
| LCD2-12-Q            | D2.31        |
| LCD2-12F-Q           | D2.36        |
| LCD2-12H-Q           | D2.34        |

|  |
|--|
| A. System Overview                     |
| B1. Cable Ties                         |
| B2. Cable Accessories                  |
| B3. Stainless Steel Ties               |
| C1. Wiring Duct                        |
| C2. Surface Raceway                    |
| C3. Abrasion Protection                |
| C4. Cable Management                   |
| D1. Terminals                          |
| D2. Power Connectors                   |
| D3. Grounding Connectors               |
| E1. Labeling Systems                   |
| E2. Labels                             |
| E3. Pre-Printed & Write-On Markers     |
| E4. Permanent Identification           |
| E5. Lockout/ Tagout & Safety Solutions |
| F. Index                               |

# PANDUIT® ELECTRICAL SOLUTIONS

| A. System Overview                    | Part Number   | Page Number | Part Number   | Page Number | Part Number    | Page Number |
|---------------------------------------|---------------|-------------|---------------|-------------|----------------|-------------|
| B1. Cable Ties                        | LCD2-14A-Q    | D2.31       | LCD4-14A-L    | D2.31       | LCD8-10A-L     | D2.31       |
|                                       | LCD2-14AF-Q   | D2.36       | LCD4-14AF-L   | D2.35       | LCD8-10AF-L    | D2.35       |
|                                       | LCD2-14AH-Q   | D2.34       | LCD4-14AH-L   | D2.33       | LCD8-10AH-L    | D2.33       |
| B2. Cable Accessories                 | LCD2-14B-Q    | D2.31       | LCD4-14B-L    | D2.31       | LCD8-14A-L     | D2.31       |
|                                       | LCD2-14BF-Q   | D2.36       | LCD4-14BF-L   | D2.35       | LCD8-14AF-L    | D2.35       |
|                                       | LCD2-14BH-Q   | D2.34       | LCD4-14BH-L   | D2.33       | LCD8-14AH-L    | D2.33       |
|                                       | LCD2-14D-Q    | D2.31       | LCD4-14D-L    | D2.31       | LCD8-14B-L     | D2.31       |
|                                       | LCD2-14DF-Q   | D2.36       | LCD4-14DF-L   | D2.35       | LCD8-14BF-L    | D2.35       |
|                                       | LCD2-14DH-Q   | D2.34       | LCD4-14DH-L   | D2.33       | LCD8-14BH-L    | D2.33       |
| B3. Stainless Steel Ties              | LCD2-38D-Q    | D2.31       | LCD4-38D-L    | D2.31       | LCD8-14D-L     | D2.31       |
|                                       | LCD2-38DF-Q   | D2.36       | LCD4-38DF-L   | D2.35       | LCD8-14DF-L    | D2.35       |
|                                       | LCD2-38DH-Q   | D2.34       | LCD4-38DH-L   | D2.33       | LCD8-14DH-L    | D2.33       |
|                                       | LCD2-56B-Q    | D2.31       | LCD4/0-00-X   | D2.40       | LCD8-38D-L     | D2.31       |
| C1. Wiring Duct                       | LCD2-56BF-Q   | D2.36       | LCD4/0-12-X   | D2.32       | LCD8-38DF-L    | D2.35       |
|                                       | LCD2-56BH-Q   | D2.34       | LCD4/0-12F-X  | D2.36       | LCD8-38DH-L    | D2.33       |
|                                       | LCD2/0-00-X   | D2.40       | LCD4/0-12H-X  | D2.34       | LCDN1-14B-E    | D2.37       |
|                                       | LCD2/0-12-X   | D2.32       | LCD4/0-14B-X  | D2.32       | LCDN1/0-14D-X  | D2.37       |
|                                       | LCD2/0-12F-X  | D2.36       | LCD4/0-14BF-X | D2.36       | LCDN1/0-14DF-X | D2.39       |
|                                       | LCD2/0-12H-X  | D2.34       | LCD4/0-14BH-X | D2.34       | LCDN1/0-14DH-X | D2.38       |
|                                       | LCD2/0-14A-X  | D2.32       | LCD4/0-38D-X  | D2.32       | LCDN1/0-56D-X  | D2.37       |
|                                       | LCD2/0-14AF-X | D2.36       | LCD4/0-38DF-X | D2.36       | LCDN1/0-56DF-X | D2.39       |
|                                       | LCD2/0-14AH-X | D2.34       | LCD4/0-38DH-X | D2.34       | LCDN1/0-56DH-X | D2.38       |
|                                       | LCD2/0-14B-X  | D2.32       | LCD400-00-6   | D2.40       | LCDN2-10B-Q    | D2.37       |
| C2. Surface Raceway                   | LCD2/0-14BF-X | D2.36       | LCD400-12-6   | D2.32       | LCDN2-14A-Q    | D2.37       |
|                                       | LCD2/0-14BH-X | D2.34       | LCD400-12F-6  | D2.36       | LCDN2-14AF-Q   | D2.39       |
|                                       | LCD2/0-38D-X  | D2.32       | LCD400-12H-6  | D2.34       | LCDN2-14AH-Q   | D2.38       |
|                                       | LCD2/0-38DF-X | D2.36       | LCD400-38D-6  | D2.32       | LCDN2-14B-Q    | D2.37       |
| C3. Abrasion Protection               | LCD2/0-38DH-X | D2.34       | LCD400-38DF-6 | D2.36       | LCDN2-14B-L    | D2.37       |
|                                       | LCD2/0-56C-X  | D2.32       | LCD400-38DH-6 | D2.34       | LCDN2-14D-Q    | D2.37       |
|                                       | LCD2/0-56CF-X | D2.36       | LCD500-00-6   | D2.40       | LCDN2-14DF-Q   | D2.39       |
|                                       | LCD2/0-56CH-X | D2.34       | LCD500-00-6   | D2.40       | LCDN2-14DH-Q   | D2.38       |
| C4. Cable Management                  | LCD250-00-X   | D2.40       | LCD500-12-6   | D2.32       | LCDN2/0-14A-X  | D2.37       |
|                                       | LCD250-12-X   | D2.32       | LCD500-12E-6  | D2.32       | LCDN2/0-14D-X  | D2.37       |
|                                       | LCD250-12F-X  | D2.36       | LCD500-12EF-6 | D2.36       | LCDN2/0-56A-X  | D2.37       |
|                                       | LCD250-12H-X  | D2.34       | LCD500-12EH-6 | D2.34       | LCDN2/0-56D-X  | D2.37       |
|                                       | LCD250-38D-X  | D2.32       | LCD500-12F-6  | D2.36       | LCDN350-38D-X  | D2.37       |
|                                       | LCD250-38DF-X | D2.36       | LCD500-12H-6  | D2.34       | LCDN500-12D-6  | D2.37       |
| D1. Terminals                         | LCD250-38DH-X | D2.34       | LCD500-14B-6  | D2.32       | LCDN500-38D-6  | D2.37       |
|                                       | LCD3/0-00-X   | D2.40       | LCD500-14BF-6 | D2.36       | LCDN750-12D-6  | D2.37       |
|                                       | LCD3/0-12-X   | D2.32       | LCD500-14BH-6 | D2.34       | LCDN750-12DF-6 | D2.39       |
|                                       | LCD3/0-12F-X  | D2.36       | LCD500-38D-6  | D2.32       | LCDN750-12DH-6 | D2.38       |
|                                       | LCD3/0-12H-X  | D2.34       | LCD500-38DF-6 | D2.36       | LCDN750-38D-6  | D2.37       |
|                                       | LCD3/0-14B-X  | D2.32       | LCD500-38DH-6 | D2.34       | LCDN750-38DF-6 | D2.39       |
| D2. Power Connectors                  | LCD3/0-14BF-X | D2.36       | LCD6-10A-L    | D2.31       | LCDN750-38DH-6 | D2.38       |
|                                       | LCD3/0-14BH-X | D2.34       | LCD6-10AF-L   | D2.35       | LCDX1-12-X     | D2.82       |
|                                       | LCD3/0-38D-X  | D2.32       | LCD6-10AH-L   | D2.33       | LCDX1-12F-X    | D2.86       |
|                                       | LCD3/0-38DF-X | D2.36       | LCD6-10B-L    | D2.31       | LCDX1-12H-X    | D2.84       |
|                                       | LCD3/0-38DH-X | D2.34       | LCD6-10BF-L   | D2.35       | LCDX1-14A-X    | D2.82       |
|                                       | LCD3/0-56D-X  | D2.32       | LCD6-10BH-L   | D2.33       | LCDX1-14AF-X   | D2.86       |
| D3. Grounding Connectors              | LCD3/0-56DF-X | D2.36       | LCD6-10B-L    | D2.31       | LCDX1-14AH-X   | D2.84       |
|                                       | LCD3/0-56DH-X | D2.34       | LCD6-10DF-L   | D2.35       | LCDX1-14B-X    | D2.82       |
|                                       | LCD300-00-X   | D2.40       | LCD6-10DH-L   | D2.33       | LCDX1-14BF-X   | D2.86       |
|                                       | LCD300-12-X   | D2.32       | LCD6-14A-L    | D2.31       | LCDX1-14BH-X   | D2.84       |
|                                       | LCD300-12F-X  | D2.36       | LCD6-14AF-L   | D2.35       | LCDX1-14D-X    | D2.82       |
|                                       | LCD300-12H-X  | D2.34       | LCD6-14AH-L   | D2.33       | LCDX1-14DF-X   | D2.86       |
| E1. Labeling Systems                  | LCD300-38D-X  | D2.32       | LCD6-14B-L    | D2.31       | LCDX1-14DH-X   | D2.84       |
|                                       | LCD300-38DF-X | D2.36       | LCD6-14BF-L   | D2.35       | LCDX1-38D-X    | D2.82       |
|                                       | LCD300-38DH-X | D2.34       | LCD6-14BH-L   | D2.33       | LCDX1-38DF-X   | D2.86       |
|                                       | LCD350-00-X   | D2.40       | LCD6-14D-L    | D2.31       | LCDX1-38DH-X   | D2.84       |
|                                       | LCD350-12-X   | D2.32       | LCD6-14DF-L   | D2.35       | LCDX1-56D-X    | D2.82       |
|                                       | LCD350-12E-X  | D2.32       | LCD6-14DH-L   | D2.33       | LCDX1-56DF-X   | D2.86       |
| E2. Labels                            | LCD350-12F-X  | D2.36       | LCD6-38D-L    | D2.31       | LCDX1-56DH-X   | D2.84       |
|                                       | LCD350-12H-X  | D2.34       | LCD6-38DF-L   | D2.35       | LCDX1/0-12-X   | D2.83       |
|                                       | LCD350-38D-X  | D2.32       | LCD6-38DH-L   | D2.33       | LCDX1/0-12D-X  | D2.83       |
|                                       | LCD350-38DF-X | D2.36       | LCD6-56D-L    | D2.31       | LCDX1/0-12DF-X | D2.87       |
| E3. Pre-Printed & Write-On Markers    | LCD350-38DH-X | D2.34       | LCD6-56DF-L   | D2.35       | LCDX1/0-12DH-X | D2.85       |
|                                       | LCD350-56D-X  | D2.40       | LCD6-56DH-L   | D2.33       | LCDX1/0-12H-X  | D2.87       |
|                                       | LCD350-56DF-X | D2.36       | LCD600-00-6   | D2.40       | LCDX1/0-12H-X  | D2.85       |
|                                       | LCD350-56DH-X | D2.34       | LCD600-12-6   | D2.32       | LCDX1/0-14A-X  | D2.83       |
| E4. Permanent Identification          | LCD350-14B-X  | D2.32       | LCD600-12F-6  | D2.36       | LCDX1/0-14AF-X | D2.87       |
|                                       | LCD350-14BF-X | D2.36       | LCD600-12H-6  | D2.34       | LCDX1/0-14AH-X | D2.85       |
|                                       | LCD350-14BH-X | D2.34       | LCD600-38D-6  | D2.32       | LCDX1/0-14B-X  | D2.83       |
|                                       | LCD350-14DH-X | D2.34       | LCD600-38DF-6 | D2.36       | LCDX1/0-14BF-X | D2.87       |
| E5. Lockout/Tagout & Safety Solutions | LCD350-38D-X  | D2.32       | LCD600-38DH-6 | D2.34       | LCDX1/0-14BH-X | D2.85       |
|                                       | LCD350-38DF-X | D2.36       | LCD750-00-6   | D2.40       | LCDX1/0-38D-X  | D2.83       |
|                                       | LCD350-38DH-X | D2.34       | LCD750-12-6   | D2.32       | LCDX1/0-38DF-X | D2.87       |
|                                       | LCD4-10A-L    | D2.31       | LCD750-38D-6  | D2.32       | LCDX1/0-38DH-X | D2.85       |
| F. Index                              | LCD4-10AF-L   | D2.35       | LCD750-58G-6  | D2.32       | LCDX1/0-56B-X  | D2.83       |
|                                       | LCD4-10AH-L   | D2.33       |               |             |                |             |
|                                       | LCD4-10B-L    | D2.31       |               |             |                |             |
|                                       | LCD4-10BF-L   | D2.35       |               |             |                |             |



# PANDUIT® ELECTRICAL SOLUTIONS

| Part Number    | Page Number |
|----------------|-------------|
| LCDX1/0-56BF-X | D2.87       |
| LCDX1/0-56BH-X | D2.85       |
| LCDX1/0-56D-X  | D2.83       |
| LCDX1/0-56DF-X | D2.87       |
| LCDX1/0-56DH-X | D2.85       |
| LCDX2-12-E     | D2.82       |
| LCDX2-12F-E    | D2.86       |
| LCDX2-12H-E    | D2.84       |
| LCDX2-14A-E    | D2.82       |
| LCDX2-14AF-E   | D2.86       |
| LCDX2-14AH-E   | D2.84       |
| LCDX2-14B-E    | D2.82       |
| LCDX2-14BF-E   | D2.86       |
| LCDX2-14BH-E   | D2.84       |
| LCDX2-14D-E    | D2.82       |
| LCDX2-14DF-E   | D2.86       |
| LCDX2-14DH-E   | D2.84       |
| LCDX2-38D-E    | D2.82       |
| LCDX2-38DF-E   | D2.86       |
| LCDX2-38DH-E   | D2.84       |
| LCDX2-56D-E    | D2.82       |
| LCDX2-56DF-E   | D2.86       |
| LCDX2-56DH-E   | D2.84       |
| LCDX2/0-12-X   | D2.83       |
| LCDX2/0-12D-X  | D2.83       |
| LCDX2/0-12DF-X | D2.87       |
| LCDX2/0-12DH-X | D2.85       |
| LCDX2/0-12F-X  | D2.87       |
| LCDX2/0-12H-X  | D2.85       |
| LCDX2/0-14A-X  | D2.83       |
| LCDX2/0-14AF-X | D2.87       |
| LCDX2/0-14AH-X | D2.85       |
| LCDX2/0-14B-X  | D2.83       |
| LCDX2/0-14BF-X | D2.87       |
| LCDX2/0-14BH-X | D2.85       |
| LCDX2/0-38D-X  | D2.83       |
| LCDX2/0-38DF-X | D2.87       |
| LCDX2/0-38DH-X | D2.85       |
| LCDX2/0-56D-X  | D2.83       |
| LCDX2/0-56DF-X | D2.87       |
| LCDX2/0-56DH-X | D2.85       |
| LCDX250-12-X   | D2.83       |
| LCDX250-12E-X  | D2.83       |
| LCDX250-12EF-X | D2.87       |
| LCDX250-12EH-X | D2.85       |
| LCDX250-12F-X  | D2.87       |
| LCDX250-12H-X  | D2.85       |
| LCDX250-38-X   | D2.83       |
| LCDX250-38D-X  | D2.83       |
| LCDX250-38DF-X | D2.87       |
| LCDX250-38DH-X | D2.85       |
| LCDX250-38F-X  | D2.87       |
| LCDX250-38H-X  | D2.85       |
| LCDX3/0-12-X   | D2.83       |
| LCDX3/0-12F-X  | D2.87       |
| LCDX3/0-12H-X  | D2.85       |
| LCDX3/0-14A-X  | D2.83       |
| LCDX3/0-14AF-X | D2.87       |
| LCDX3/0-14AH-X | D2.85       |
| LCDX3/0-38D-X  | D2.83       |
| LCDX3/0-38DF-X | D2.87       |
| LCDX3/0-38DH-X | D2.85       |
| LCDX3/0-56D-X  | D2.83       |
| LCDX3/0-56DF-X | D2.87       |
| LCDX3/0-56DH-X | D2.85       |
| LCDX300-12-6   | D2.83       |
| LCDX300-12F-6  | D2.87       |
| LCDX300-12H-6  | D2.85       |
| LCDX300-38D-6  | D2.83       |
| LCDX300-38DF-6 | D2.87       |
| LCDX300-38DH-6 | D2.85       |
| LCDX350-12-6   | D2.83       |
| LCDX350-12E-6  | D2.83       |
| LCDX350-12EF-6 | D2.87       |
| LCDX350-12EH-6 | D2.85       |
| LCDX350-12F-6  | D2.87       |
| LCDX350-12H-6  | D2.85       |

| Part Number    | Page Number |
|----------------|-------------|
| LCDX350-38-6   | D2.83       |
| LCDX350-38D-6  | D2.83       |
| LCDX350-38DF-6 | D2.87       |
| LCDX350-38DH-6 | D2.85       |
| LCDX350-38F-6  | D2.87       |
| LCDX350-38H-6  | D2.85       |
| LCDX350-56D-6  | D2.83       |
| LCDX350-56DF-6 | D2.87       |
| LCDX350-56DH-6 | D2.85       |
| LCDX4-14A-L    | D2.82       |
| LCDX4-14AF-L   | D2.86       |
| LCDX4-14AH-L   | D2.84       |
| LCDX4-14B-L    | D2.82       |
| LCDX4-14BF-L   | D2.86       |
| LCDX4-14BH-L   | D2.84       |
| LCDX4-14D-L    | D2.82       |
| LCDX4-14DF-L   | D2.86       |
| LCDX4-14DH-L   | D2.84       |
| LCDX4-38D-L    | D2.82       |
| LCDX4-38DF-L   | D2.86       |
| LCDX4-38DH-L   | D2.84       |
| LCDX4-56D-L    | D2.82       |
| LCDX4-56DF-L   | D2.86       |
| LCDX4-56DH-L   | D2.84       |
| LCDX4/0-12-X   | D2.83       |
| LCDX4/0-12D-X  | D2.83       |
| LCDX4/0-12DF-X | D2.87       |
| LCDX4/0-12DH-X | D2.85       |
| LCDX4/0-12F-X  | D2.83       |
| LCDX4/0-12EH-X | D2.87       |
| LCDX4/0-12H-X  | D2.85       |
| LCDX4/0-14A-X  | D2.83       |
| LCDX4/0-14AF-X | D2.87       |
| LCDX4/0-14AH-X | D2.85       |
| LCDX4/0-14B-X  | D2.83       |
| LCDX4/0-14BF-X | D2.87       |
| LCDX4/0-14BH-X | D2.85       |
| LCDX4/0-38D-X  | D2.83       |
| LCDX4/0-38DF-X | D2.87       |
| LCDX4/0-38DH-X | D2.85       |
| LCDX4/0-56D-X  | D2.83       |
| LCDX4/0-56DF-X | D2.87       |
| LCDX4/0-56DH-X | D2.85       |
| LCDX450-12-6   | D2.83       |
| LCDX450-12F-6  | D2.87       |
| LCDX450-12H-6  | D2.85       |
| LCDX450-38D-6  | D2.83       |
| LCDX450-38DF-6 | D2.87       |
| LCDX450-38DH-6 | D2.85       |
| LCDX500-12-6   | D2.83       |
| LCDX500-12E-6  | D2.83       |
| LCDX500-12EF-6 | D2.87       |
| LCDX500-12EH-6 | D2.85       |
| LCDX500-12F-6  | D2.87       |
| LCDX500-12H-6  | D2.85       |
| LCDX500-38D-6  | D2.83       |
| LCDX500-38DF-6 | D2.87       |
| LCDX500-38DH-6 | D2.85       |
| LCDX500-56D-6  | D2.83       |
| LCDX500-56DF-6 | D2.87       |
| LCDX500-56DH-6 | D2.85       |
| LCDX6-10A-L    | D2.82       |
| LCDX6-10AF-L   | D2.86       |
| LCDX6-10AH-L   | D2.84       |
| LCDX6-10B-L    | D2.82       |
| LCDX6-10BF-L   | D2.86       |
| LCDX6-10BH-L   | D2.84       |
| LCDX6-10G-L    | D2.82       |
| LCDX6-10GF-L   | D2.86       |
| LCDX6-10GH-L   | D2.84       |
| LCDX6-10H-L    | D2.82       |
| LCDX6-10PF-L   | D2.86       |
| LCDX6-10PH-L   | D2.84       |
| LCDX6-14A-L    | D2.82       |
| LCDX6-14AF-L   | D2.86       |

| Part Number     | Page Number |
|-----------------|-------------|
| LCDX6-14AH-L    | D2.84       |
| LCDX6-14B-L     | D2.82       |
| LCDX6-14BF-L    | D2.86       |
| LCDX6-14BH-L    | D2.84       |
| LCDX6-14D-L     | D2.82       |
| LCDX6-14DF-L    | D2.86       |
| LCDX6-14DH-L    | D2.84       |
| LCDX6-38D-L     | D2.82       |
| LCDX6-38DF-L    | D2.86       |
| LCDX6-38DH-L    | D2.84       |
| LCDX6-56D-L     | D2.82       |
| LCDX6-56DF-L    | D2.86       |
| LCDX6-56DH-L    | D2.84       |
| LCDX600-12-6    | D2.83       |
| LCDX600-12F-6   | D2.87       |
| LCDX600-12H-6   | D2.85       |
| LCDX650-12-6    | D2.83       |
| LCDX650-12F-6   | D2.87       |
| LCDX650-12H-6   | D2.85       |
| LCDX650-38D-6   | D2.83       |
| LCDX650-38DF-6  | D2.87       |
| LCDX650-38DH-6  | D2.85       |
| LCDX750-12-3    | D2.83       |
| LCDX750-12E-3   | D2.83       |
| LCDX750-12EF-3  | D2.87       |
| LCDX750-12EH-3  | D2.85       |
| LCDX750-12F-3   | D2.87       |
| LCDX750-12G-3   | D2.83       |
| LCDX750-12GF-3  | D2.87       |
| LCDX750-12GH-3  | D2.85       |
| LCDX750-12H-3   | D2.85       |
| LCDX750-38D-3   | D2.83       |
| LCDX750-38DF-3  | D2.87       |
| LCDX750-38DH-3  | D2.85       |
| LCDX750-58G-3   | D2.83       |
| LCDX750-58GF-3  | D2.87       |
| LCDX750-58GH-3  | D2.85       |
| LCDX8-10A-L     | D2.82       |
| LCDX8-10AF-L    | D2.86       |
| LCDX8-10AH-L    | D2.84       |
| LCDX8-14A-L     | D2.82       |
| LCDX8-14AF-L    | D2.86       |
| LCDX8-14AH-L    | D2.84       |
| LCDX8-14B-L     | D2.82       |
| LCDX8-14BF-L    | D2.86       |
| LCDX8-14BH-L    | D2.84       |
| LCDX8-14D-L     | D2.82       |
| LCDX8-14DF-L    | D2.86       |
| LCDX8-14DH-L    | D2.84       |
| LCDX8-38D-L     | D2.82       |
| LCDX8-38DF-L    | D2.86       |
| LCDX8-38DH-L    | D2.84       |
| LCDXN2-14A-E    | D2.88       |
| LCDXN2-14AF-E   | D2.89       |
| LCDXN2-14AH-E   | D2.89       |
| LCDXN350-38D-6  | D2.88       |
| LCDXN4/0-38D-X  | D2.88       |
| LCDXN500-38D-6  | D2.88       |
| LCDXN750-38D-3  | D2.88       |
| LCDXN750-38DF-3 | D2.89       |
| LCDXN750-38DH-3 | D2.89       |
| LCMA10-10-C     | D2.108      |
| LCMA10-5-C      | D2.108      |
| LCMA10-6-C      | D2.108      |
| LCMA10-8-C      | D2.108      |
| LCMA120-10-L    | D2.108      |
| LCMA120-12-L    | D2.108      |
| LCMA120-16-L    | D2.108      |
| LCMA120-8-L     | D2.108      |
| LCMA150-10-X    | D2.108      |
| LCMA150-12-X    | D2.108      |
| LCMA150-16-X    | D2.108      |
| LCMA150-20-X    | D2.108      |
| LCMA150-8-X     | D2.108      |
| LCMA16-10-C     | D2.108      |
| LCMA16-5-C      | D2.108      |

|  |
|--|
| A. System Overview                     |
| B1. Cable Ties                         |
| B2. Cable Accessories                  |
| B3. Stainless Steel Ties               |
| C1. Wiring Duct                        |
| C2. Surface Raceway                    |
| C3. Abrasion Protection                |
| C4. Cable Management                   |
| D1. Terminals                          |
| D2. Power Connectors                   |
| D3. Grounding Connectors               |
| E1. Labeling Systems                   |
| E2. Labels                             |
| E3. Pre-Printed & Write-On Markers     |
| E4. Permanent Identification           |
| E5. Lockout/ Tagout & Safety Solutions |
| F. Index                               |

# PANDUIT® ELECTRICAL SOLUTIONS

| A. System Overview                    | Part Number    | Page Number | Part Number          | Page Number  | Part Number    | Page Number |
|---------------------------------------|----------------|-------------|----------------------|--------------|----------------|-------------|
| B1. Cable Ties                        | LCMA16-6-C     | D2.108      | LCMD35-10-Q          | D2.109       | LS9-IB         | E1.2        |
|                                       | LCMA16-8-C     | D2.108      | LCMD35-12-Q          | D2.109       | LS9-WS         | E1.2        |
|                                       | LCMA185-10-X   | D2.108      | LCMD35-8CD-Q         | D2.109       | <b>LS9Q</b>    | <b>E1.2</b> |
| B2. Cable Accessories                 | LCMA185-12-X   | D2.108      | LCMD400-00-5         | D2.110       | LTYK           | D3.6        |
|                                       | LCMA185-16-X   | D2.108      | LCMD400-12-5         | D2.110       | LV-S-1G        | C4.9        |
|                                       | LCMA185-20-X   | D2.108      | LCMD400-14-5         | D2.110       | LV-S-2G        | C4.9        |
| B3. Stainless Steel Ties              | LCMA240-10-X   | D2.108      | LCMD400-16-5         | D2.110       | LV-W-1G        | C4.9        |
|                                       | LCMA240-12-X   | D2.108      | LCMD50-00-X          | D2.109       | LV-W-2G        | C4.9        |
|                                       | LCMA240-16-X   | D2.108      | LCMD50-10-X          | D2.109       | LWC100-A-L     | B2.34       |
| C1. Wiring Duct                       | LCMA240-20-X   | D2.108      | LCMD50-10CD-X        | D2.109       | LWC100-A-L14   | B2.34       |
|                                       | LCMA25-10-C    | D2.108      | LCMD50-12-X          | D2.109       | LWC100-A-L20   | B2.34       |
|                                       | LCMA25-6-C     | D2.108      | LCMD500-00-1         | D2.110       | LWC100-H25-L   | B2.34       |
| C2. Surface Raceway                   | LCMA25-8-C     | D2.108      | LCMD500-12-1         | D2.110       | LWC100-H25-L14 | B2.34       |
|                                       | LCMA300-10-5   | D2.108      | LCMD500-14-1         | D2.110       | LWC100-H25-L20 | B2.34       |
|                                       | LCMA300-12-5   | D2.108      | LCMD500-16-1         | D2.110       | LWC19-A-C      | B2.34       |
| C3. Abrasion Protection               | LCMA300-16-5   | D2.108      | LCMD6-5CD-Q          | D2.109       | LWC19-A-C14    | B2.34       |
|                                       | LCMA300-20-5   | D2.108      | LCMD630-00-1         | D2.110       | LWC19-A-C20    | B2.34       |
|                                       | LCMA35-10-C    | D2.108      | LCMD630-12-1         | D2.110       | LWC19-H25-C    | B2.34       |
| C4. Cable Management                  | LCMA35-12-C    | D2.108      | LCMD630-14-1         | D2.110       | LWC19-H25-C14  | B2.34       |
|                                       | LCMA35-6-C     | D2.108      | LCMD630-16-1         | D2.110       | LWC25-A-C      | B2.34       |
|                                       | LCMA35-8-C     | D2.108      | LCMD70-00-X          | D2.109       | LWC25-A-C14    | B2.34       |
| D1. Terminals                         | LCMA400-12-5   | D2.108      | LCMD70-10-X          | D2.109       | LWC25-A-C20    | B2.34       |
|                                       | LCMA400-16-5   | D2.108      | LCMD70-10CD-X        | D2.109       | LWC25-H25-C    | B2.34       |
|                                       | LCMA400-20-5   | D2.108      | LCMD70-12-X          | D2.109       | LWC25-H25-C14  | B2.34       |
| D2. Power Connectors                  | LCMA50-10-L    | D2.108      | LCMD95-00-X          | D2.109       | LWC25-H25-C20  | B2.34       |
|                                       | LCMA50-12-L    | D2.108      | LCMD95-10CD-X        | D2.109       | LWC38-A-C      | B2.34       |
|                                       | LCMA50-6-L     | D2.108      | LCMD95-12-X          | D2.109       | LWC38-A-C14    | B2.34       |
| D3. Grounding Connectors              | LCMA50-8-L     | D2.108      | LCMD95-14-X          | D2.109       | LWC38-A-C20    | B2.34       |
|                                       | LCMA500-00-1   | D2.108      | LD10IW10-A           | C2.76        | LWC38-H25-C    | B2.34       |
|                                       | LCMA500-12-1   | D2.108      | LD10IW6-A            | C2.76        | LWC38-H25-C14  | B2.34       |
| E1. Labeling Systems                  | LCMA500-16-1   | D2.108      | LD10IW8-A            | C2.76        | LWC38-H25-C20  | B2.34       |
|                                       | LCMA500-20-1   | D2.108      | LD2P10IW10-A         | C2.75        | LWC50-A-L      | B2.34       |
|                                       | LCMA6-5-C      | D2.107      | LD2P10IW8-A          | C2.75        | LWC50-A-L14    | B2.34       |
| E2. Labels                            | LCMA6-6-C      | D2.107      | LD3IW10-A            | C2.76        | LWC50-A-L20    | B2.34       |
|                                       | LCMA6-8-C      | D2.107      | LD3IW6-A             | C2.76        | LWC50-H25-L    | B2.34       |
|                                       | LCMA630-00-1   | D2.108      | LD3IW8-A             | C2.76        | LWC50-H25-L14  | B2.34       |
| E3. Pre-Printed & Write-On Markers    | LCMA630-16-1   | D2.108      | LD5IW10-A            | C2.76        | LWC50-H25-L20  | B2.34       |
|                                       | LCMA630-20-1   | D2.108      | LD5IW6-A             | C2.76        | LWC75-A-L      | B2.34       |
|                                       | LCMA70-10-L    | D2.108      | LD5IW8-A             | C2.76        | LWC75-A-L14    | B2.34       |
| E4. Permanent Identification          | LCMA70-12-L    | D2.108      | LDPH10IW10-A         | C2.77        | LWC75-A-L20    | B2.34       |
|                                       | LCMA70-6-L     | D2.108      | LDPH10IW8-A          | C2.77        | LWC75-H25-L    | B2.34       |
|                                       | LCMA70-8-L     | D2.108      | LDPH3IW10-A          | C2.77        | LWC75-H25-L14  | B2.34       |
| E5. Lockout/Tagout & Safety Solutions | LCMA95-10-L    | D2.108      | LDPH3IW8-A           | C2.77        | LWC75-H25-L20  | B2.34       |
|                                       | LCMA95-12-L    | D2.108      | LDPH5IW10-A          | C2.77        |                |             |
|                                       | LCMA95-16-L    | D2.108      | LDPH5IW8-A           | C2.77        |                |             |
| F. Index                              | LCMA95-8-L     | D2.108      | LDS3IW10-A           | C2.78        |                |             |
|                                       | LCMD10-00-Q    | D2.109      | LDS5IW10-A           | C2.78        |                |             |
|                                       | LCMD10-6CD-Q   | D2.109      | LHMS-S10-D           | B2.17        |                |             |
|                                       | LCMD10-8-Q     | D2.109      | LHMS-S5-D            | B2.17        |                |             |
|                                       | LCMD120-00-X   | D2.110      | LHMS-S6-D            | B2.17        |                |             |
|                                       | LCMD120-10CD-X | D2.110      | <b>LI-112S-L</b>     | <b>D3.24</b> |                |             |
|                                       | LCMD120-12-X   | D2.110      | <b>LI-252S-Q</b>     | <b>D3.24</b> |                |             |
|                                       | LCMD120-14-X   | D2.110      | <b>LI-50S-C</b>      | <b>D3.24</b> |                |             |
|                                       | LCMD150-00-X   | D2.110      | LMD3IW-Q             | C2.78        |                |             |
|                                       | LCMD150-10CD-X | D2.110      | LMD5IW-Q             | C2.78        |                |             |
|                                       | LCMD150-12-X   | D2.110      | LPFCM14-A-C14        | B2.37        |                |             |
|                                       | LCMD150-14-X   | D2.110      | LPFCM22-A-C14        | B2.37        |                |             |
|                                       | LCMD16-00-Q    | D2.109      | LPFCM34-A-C14        | B2.37        |                |             |
|                                       | LCMD16-6CD-Q   | D2.109      | LPMM-S2-C            | B2.14        |                |             |
|                                       | LCMD16-8-Q     | D2.109      | LPMM-S5-C            | B2.14        |                |             |
|                                       | LCMD185-00-X   | D2.110      | LPMS-S8-C            | B2.14        |                |             |
|                                       | LCMD185-10CD-X | D2.110      | LS8-CASE             | E1.2         |                |             |
|                                       | LCMD185-12-X   | D2.110      | LS8-CLN              | E1.2         |                |             |
|                                       | LCMD185-14-X   | D2.110      | LS8-IB               | E1.2         |                |             |
|                                       | LCMD240-00-5   | D2.110      | LS8-PCKIT            | E1.2         |                |             |
|                                       | LCMD240-10CD-5 | D2.110      | LS8-WS               | E1.2         |                |             |
|                                       | LCMD240-12-5   | D2.110      | LS8E                 | E1.2         |                |             |
|                                       | LCMD240-14-5   | D2.110      | LS8E-ACS             | E1.2         |                |             |
|                                       | LCMD25-00-Q    | D2.109      | LS8E-KIT             | E1.2         |                |             |
|                                       | LCMD25-10-Q    | D2.109      | <b>LS8E-KIT-ACS</b>  | <b>E1.2</b>  |                |             |
|                                       | LCMD25-12-Q    | D2.109      | <b>LS8EQ</b>         | <b>E1.2</b>  |                |             |
|                                       | LCMD25-8-Q     | D2.109      | <b>LS8EQ-KIT</b>     | <b>E1.2</b>  |                |             |
|                                       | LCMD25-8CD-Q   | D2.109      | <b>LS8EQ-KIT-ACS</b> | <b>E1.2</b>  |                |             |
|                                       | LCMD300-00-5   | D2.110      | LS9                  | E1.2         |                |             |
|                                       | LCMD300-12-5   | D2.110      | LS9-ACS              | E1.2         |                |             |
|                                       | LCMD300-14-5   | D2.110      | LS9-CASE             | E1.2         |                |             |
|                                       | LCMD35-00-Q    | D2.109      | LS9-CLN              | E1.2         |                |             |
|                                       |                |             |                      |              | <b>M</b>       |             |
|                                       |                |             |                      |              | M200X050Y6T    | E2.10       |
|                                       |                |             |                      |              | M200X050Y7T    | E2.10       |
|                                       |                |             |                      |              | M200X100Y6T    | E2.10       |
|                                       |                |             |                      |              | M200X100Y7T    | E2.10       |
|                                       |                |             |                      |              | M300X050Y6C    | E1.7        |
|                                       |                |             |                      |              | M300X050Y6T    | E2.10       |
|                                       |                |             |                      |              | M300X050Y7C    | E1.7        |
|                                       |                |             |                      |              | M300X050Y7T    | E2.10       |
|                                       |                |             |                      |              | M300X100Y6T    | E2.10       |
|                                       |                |             |                      |              | M300X100Y7T    | E2.10       |
|                                       |                |             |                      |              | MACC25-A-C     | B2.33       |
|                                       |                |             |                      |              | MACC25-AV-D    | B2.33       |
|                                       |                |             |                      |              | MACC62-A-C     | B2.33       |
|                                       |                |             |                      |              | MACC62-AV-C    | B2.33       |
|                                       |                |             |                      |              | MBCEH-QR316    | B3.13       |
|                                       |                |             |                      |              | MBCH-QR316     | B3.13       |
|                                       |                |             |                      |              | MBCSH-QR316    | B3.13       |
|                                       |                |             |                      |              | MBEH-TLR       | B3.12       |
|                                       |                |             |                      |              | MBEH-TLR316    | B3.12       |
|                                       |                |             |                      |              | MBH-TLR316     | B3.12       |
|                                       |                |             |                      |              | MBH-MR         | B3.12       |
|                                       |                |             |                      |              | MBH-MR316      | B3.12       |
|                                       |                |             |                      |              | MBH-TLR        | B3.12       |
|                                       |                |             |                      |              | MBH-TLR316     | B3.12       |
|                                       |                |             |                      |              | MBM-H25-Q      | B3.28       |
|                                       |                |             |                      |              | MBMS-S10-CY    | B2.19       |
|                                       |                |             |                      |              | MBS-MR         | B3.12       |
|                                       |                |             |                      |              | MBS-MR316      | B3.12       |
|                                       |                |             |                      |              | MBS-TLR        | B3.12       |
|                                       |                |             |                      |              | MBS-TLR316     | B3.12       |
|                                       |                |             |                      |              | MBSH-TR        | B3.12       |



# PANDUIT® ELECTRICAL SOLUTIONS

| A. System Overview                    | Part Number          | Page Number  | Part Number         | Page Number  | Part Number    | Page Number |
|---------------------------------------|----------------------|--------------|---------------------|--------------|----------------|-------------|
| B1. Cable Ties                        | MP2G106BWH           | C2.17        | MS8W63T15-L6        | B3.23        | MTP3S-E10-C    | B2.16       |
|                                       | MP2G106RWH           | C2.17        | <b>MS8W75T30-Q2</b> | <b>B3.23</b> | MTP3S-E6-C     | B2.16       |
|                                       | MP2G106TSWH          | C2.17        | MSBW38-C4           | B3.25        | MTP4H-E10-C    | B2.16       |
| B2. Cable Accessories                 | MP2G106WH            | C2.17        | MSBW38-C6           | B3.25        | MTP4H-E6-C     | B2.16       |
|                                       | MP2GBWH              | C2.17        | MSBW50-C4           | B3.25        | MTP4S-E10-C    | B2.16       |
|                                       | MP2GRBWH             | C2.17        | MSBW50-C6           | B3.25        | MTP4S-E6-C     | B2.16       |
|                                       | MP2GRTSWH            | C2.17        | MSBW63-C4           | B3.25        | MTP5H-E10-C    | B2.16       |
|                                       | MP2GRWH              | C2.17        | MSBW63-C6           | B3.25        | MTP5H-E6-C     | B2.16       |
|                                       | MP2TSWH              | C2.17        | <b>MSBW75-C2</b>    | <b>B3.25</b> | MTP5S-E10-C    | B2.16       |
|                                       | MP350-C              | B2.29        | MSC10W38T15-L6      | B3.24        | MTP5S-E6-C     | B2.16       |
|                                       | MP350-C0             | B2.29        | MSC10W50T15-L6      | B3.24        | MTP6H-E10-C    | B2.16       |
|                                       | MP3G1062TSWH         | C2.17        | MSC10W63T15-L6      | B3.24        | MTP6H-E6-C     | B2.16       |
|                                       | MP3G106WH            | C2.17        | MSC2W38T15-L6       | B3.24        | MTPC1H-E10-C39 | B2.16       |
| B3. Stainless Steel Ties              | MP3GRWH              | C2.17        | MSC4W38T15-L6       | B3.24        | MTPC2H-E10-C39 | B2.16       |
|                                       | MP3TSWH              | C2.17        | MSC4W50T15-L6       | B3.24        | MTPC3H-E10-C39 | B2.16       |
|                                       | MPMH38-L0            | B2.21        | MSC4W63T15-L6       | B3.24        | MTPC4H-E10-C39 | B2.16       |
| C1. Wiring Duct                       | MPMS19-C0            | B2.21        | MSC6W38T15-L6       | B3.24        | MTPC5H-E10-C39 | B2.16       |
|                                       | MPMS25-C0            | B2.21        | MSC6W50T15-L6       | B3.24        | MTPC6H-E10-C39 | B2.16       |
|                                       | MPMWH32-L0           | B2.21        | MSC6W63T15-L6       | B3.24        | MTRTH          | B3.20       |
| C2. Surface Raceway                   | MPWM-H56-Q           | B3.27        | MSC8W38T15-L6       | B3.24        | MTRTLS         | B3.20       |
|                                       | <b>MRS1.5H-L4</b>    | <b>B3.19</b> | MSC8W50T15-L6       | B3.24        |                |             |
|                                       | <b>MRS1.5LH-L4</b>   | <b>B3.19</b> | MSC8W63T15-L6       | B3.24        |                |             |
|                                       | <b>MRS1S-C4</b>      | <b>B3.19</b> | MSCN38T15-QR6       | B3.25        |                |             |
|                                       | <b>MRS2H-L4</b>      | <b>B3.19</b> | MSCN50T15-QR6       | B3.25        |                |             |
|                                       | <b>MRS2LH-L4</b>     | <b>B3.19</b> | MSCN63T15-QR6       | B3.25        |                |             |
|                                       | <b>MRS2S-C4</b>      | <b>B3.19</b> | MSG-1.3-C           | C4.10        |                |             |
|                                       | <b>MRS4H-L4</b>      | <b>B3.19</b> | MSGV-1.3-C          | C4.10        |                |             |
|                                       | <b>MRS4LH-L4</b>     | <b>B3.19</b> | MSPT-1.3            | C4.10        |                |             |
|                                       | <b>MRS4S-C4</b>      | <b>B3.19</b> | MSW38T15-CR4        | B3.25        |                |             |
| C3. Abrasion Protection               | <b>MRS6H-L4</b>      | <b>B3.19</b> | MSW38T15-CR6        | B3.25        |                |             |
|                                       | <b>MRS6LH-L4</b>     | <b>B3.19</b> | MSW50T15-CR4        | B3.25        |                |             |
|                                       | <b>MRS6S-C4</b>      | <b>B3.19</b> | MSW50T15-CR6        | B3.25        |                |             |
|                                       | MRT1.5DS-C4          | B3.18        | MSW63T15-CR4        | B3.25        |                |             |
|                                       | <b>MRT1.5H-L4</b>    | <b>B3.18</b> | MSW63T15-CR6        | B3.25        |                |             |
|                                       | <b>MRT1.5LH-L4</b>   | <b>B3.18</b> | <b>MSW75T30-CR2</b> | <b>B3.25</b> |                |             |
|                                       | <b>MRT1S-C4</b>      | <b>B3.18</b> | MT125S-Q            | E4.4         |                |             |
|                                       | MRT2.5DLH-L4         | B3.18        | MT150D-Q            | E4.4         |                |             |
|                                       | MRT2.5DS-C4          | B3.18        | MT150D-Q316         | E4.4         |                |             |
|                                       | MRT2DH-L4            | B3.18        | MT172-C             | E4.4         |                |             |
| C4. Cable Management                  | <b>MRT2H-L4</b>      | <b>B3.18</b> | MT172-C316          | E4.4         |                |             |
|                                       | <b>MRT2LH-L4</b>     | <b>B3.18</b> | MT172W38-C          | E4.4         |                |             |
|                                       | <b>MRT2S-C4</b>      | <b>B3.18</b> | MT1D-Q              | E4.4         |                |             |
|                                       | MRT4DH-L4            | B3.18        | MT1D-Q316           | E4.4         |                |             |
|                                       | <b>MRT4H-L4</b>      | <b>B3.18</b> | MT213D-Q            | E4.4         |                |             |
|                                       | <b>MRT4LH-L4</b>     | <b>B3.18</b> | MT213D-Q316         | E4.4         |                |             |
|                                       | <b>MRT4S-C4</b>      | <b>B3.18</b> | MT350-C             | E4.4         |                |             |
|                                       | <b>MRT6H-L4</b>      | <b>B3.18</b> | MT350-C316          | E4.4         |                |             |
|                                       | <b>MRT6LH-L4</b>     | <b>B3.18</b> | MT350W17-Q          | E4.4         |                |             |
|                                       | <b>MRT6S-C4</b>      | <b>B3.18</b> | MTB150D-Q           | E4.4         |                |             |
| D1. Terminals                         | MS10W38T15-L4        | B3.23        | MTB1D-Q             | E4.4         |                |             |
|                                       | MS10W38T15-L6        | B3.23        | MTB213D-Q           | E4.4         |                |             |
|                                       | MS10W50T15-L4        | B3.23        | MTHCEH-C316         | B3.13        |                |             |
| D2. Power Connectors                  | MS10W50T15-L6        | B3.23        | MTHCH-C316          | B3.13        |                |             |
|                                       | MS10W63T15-L4        | B3.23        | MTHCCH-C316         | B3.13        |                |             |
|                                       | MS10W63T15-L6        | B3.23        | MTHEH-C             | B3.13        |                |             |
|                                       | <b>MS10W75T30-Q2</b> | <b>B3.23</b> | MTHEH-C316          | B3.13        |                |             |
|                                       | MS2W38T15-L4         | B3.23        | MTHH-C              | B3.13        |                |             |
|                                       | MS2W38T15-L6         | B3.23        | MTHH-C316           | B3.13        |                |             |
|                                       | MS4W38T15-L4         | B3.23        | MTHS-C              | B3.13        |                |             |
|                                       | MS4W38T15-L6         | B3.23        | MTHS-C316           | B3.13        |                |             |
|                                       | MS4W50T15-L4         | B3.23        | MTHSH-C             | B3.13        |                |             |
|                                       | MS4W50T15-L6         | B3.23        | MTHSH-C316          | B3.13        |                |             |
| D3. Grounding Connectors              | MS4W63T15-L4         | B3.23        | MTM1H10-C           | B3.27        |                |             |
|                                       | MS4W63T15-L6         | B3.23        | MTM1H25-C           | B3.27        |                |             |
|                                       | <b>MS4W75T30-Q2</b>  | <b>B3.23</b> | MTM1H-C             | B3.27        |                |             |
|                                       | MS6W38T15-L4         | B3.23        | MTM2H-Q             | B3.28        |                |             |
|                                       | MS6W38T15-L6         | B3.23        | MTMBH-Q             | B3.29        |                |             |
|                                       | MS6W50T15-L4         | B3.23        | MTP1H-E10-C         | B2.15        |                |             |
|                                       | MS6W50T15-L6         | B3.23        | MTP1H-E6-C          | B2.15        |                |             |
|                                       | MS6W63T15-L4         | B3.23        | MTP1S-E10-C         | B2.15        |                |             |
|                                       | MS6W63T15-L6         | B3.23        | MTP1S-E6-C          | B2.15        |                |             |
|                                       | <b>MS6W75T30-Q2</b>  | <b>B3.23</b> | MTP2H-E10-C         | B2.15        |                |             |
| E1. Labeling Systems                  | MS8W38T15-L4         | B3.23        | MTP2H-E6-C          | B2.15        |                |             |
|                                       | MS8W38T15-L6         | B3.23        | MTP2S-E10-C         | B2.15        |                |             |
|                                       | MS8W50T15-L4         | B3.23        | MTP2S-E6-C          | B2.15        |                |             |
| E2. Labels                            | MS8W50T15-L6         | B3.23        | MTP3H-E10-C         | B2.16        |                |             |
|                                       | MS8W63T15-L4         | B3.23        | MTP3H-E6-C          | B2.16        |                |             |
|                                       | <b>MS8W75T30-Q2</b>  | <b>B3.23</b> |                     |              |                |             |
|                                       | MS8W75T30-Q2         | B3.23        |                     |              |                |             |
|                                       | MS8W75T30-Q2         | B3.23        |                     |              |                |             |
|                                       | MS8W75T30-Q2         | B3.23        |                     |              |                |             |
|                                       | MS8W75T30-Q2         | B3.23        |                     |              |                |             |
|                                       | MS8W75T30-Q2         | B3.23        |                     |              |                |             |
|                                       | MS8W75T30-Q2         | B3.23        |                     |              |                |             |
|                                       | MS8W75T30-Q2         | B3.23        |                     |              |                |             |
| E3. Pre-Printed & Write-On Markers    | MS8W75T30-Q2         | B3.23        |                     |              |                |             |
|                                       | MS8W75T30-Q2         | B3.23        |                     |              |                |             |
|                                       | MS8W75T30-Q2         | B3.23        |                     |              |                |             |
|                                       | MS8W75T30-Q2         | B3.23        |                     |              |                |             |
|                                       | MS8W75T30-Q2         | B3.23        |                     |              |                |             |
|                                       | MS8W75T30-Q2         | B3.23        |                     |              |                |             |
|                                       | MS8W75T30-Q2         | B3.23        |                     |              |                |             |
|                                       | MS8W75T30-Q2         | B3.23        |                     |              |                |             |
|                                       | MS8W75T30-Q2         | B3.23        |                     |              |                |             |
|                                       | MS8W75T30-Q2         | B3.23        |                     |              |                |             |
| E4. Permanent Identification          | MS8W75T30-Q2         | B3.23        |                     |              |                |             |
|                                       | MS8W75T30-Q2         | B3.23        |                     |              |                |             |
|                                       | MS8W75T30-Q2         | B3.23        |                     |              |                |             |
|                                       | MS8W75T30-Q2         | B3.23        |                     |              |                |             |
|                                       | MS8W75T30-Q2         | B3.23        |                     |              |                |             |
|                                       | MS8W75T30-Q2         | B3.23        |                     |              |                |             |
|                                       | MS8W75T30-Q2         | B3.23        |                     |              |                |             |
|                                       | MS8W75T30-Q2         | B3.23        |                     |              |                |             |
|                                       | MS8W75T30-Q2         | B3.23        |                     |              |                |             |
|                                       | MS8W75T30-Q2         | B3.23        |                     |              |                |             |
| E5. Lockout/Tagout & Safety Solutions | MS8W75T30-Q2         | B3.23        |                     |              |                |             |
|                                       | MS8W75T30-Q2         | B3.23        |                     |              |                |             |
|                                       | MS8W75T30-Q2         | B3.23        |                     |              |                |             |
|                                       | MS8W75T30-Q2         | B3.23        |                     |              |                |             |
|                                       | MS8W75T30-Q2         | B3.23        |                     |              |                |             |
|                                       | MS8W75T30-Q2         | B3.23        |                     |              |                |             |
|                                       | MS8W75T30-Q2         | B3.23        |                     |              |                |             |
|                                       | MS8W75T30-Q2         | B3.23        |                     |              |                |             |
|                                       | MS8W75T30-Q2         | B3.23        |                     |              |                |             |
|                                       | MS8W75T30-Q2         | B3.23        |                     |              |                |             |
| F. Index                              | MS8W75T30-Q2         | B3.23        |                     |              |                |             |
|                                       | MS8W75T30-Q2         | B3.23        |                     |              |                |             |
|                                       | MS8W75T30-Q2         | B3.23        |                     |              |                |             |
|                                       | MS8W75T30-Q2         | B3.23        |                     |              |                |             |
|                                       | MS8W75T30-Q2         | B3.23        |                     |              |                |             |
|                                       | MS8W75T30-Q2         | B3.23        |                     |              |                |             |
|                                       | MS8W75T30-Q2         | B3.23        |                     |              |                |             |
|                                       | MS8W75T30-Q2         | B3.23        |                     |              |                |             |
|                                       | MS8W75T30-Q2         | B3.23        |                     |              |                |             |
|                                       | MS8W75T30-Q2         | B3.23        |                     |              |                |             |

## N

|              |            |
|--------------|------------|
| N025X075CBT  | E2.11      |
| N025X075FJJ  | E2.4       |
| N025X125CBT  | E2.11      |
| N025X125FJJ  | E2.4       |
| N025X150CBT  | E2.11      |
| N025X150FJJ  | E2.4       |
| N025X175CBT  | E2.11      |
| N050X075CBC  | E1.6       |
| N050X075CBB  | E2.11      |
| N050X075FJJ  | E2.4       |
| N050X100CBT  | E2.11      |
| N050X125CBT  | E2.11      |
| N050X125FJJ  | E2.4       |
| N050X150CBC  | E1.6       |
| N050X150CBT  | E2.11      |
| N050X150FJJ  | E2.4, E2.5 |
| N050X175CBT  | E2.11      |
| N100X075CBT  | E2.11      |
| N100X075FJJ  | E2.4       |
| N100X125CBC  | E1.6       |
| N100X125CBT  | E2.11      |
| N100X125FJJ  | E2.4       |
| N100X150CBC  | E1.6       |
| N100X150CBT  | E2.11      |
| N100X150FJJ  | E2.4, E2.5 |
| N100X175CBC  | E1.6       |
| N100X175CBT  | E2.11      |
| NC.5WH6      | C1.24      |
| NC1.5WH6     | C1.24      |
| NC100LG2     | C1.23      |
| NC1WH6       | C1.24      |
| NC25LG2      | C1.23      |
| NC2WH6       | C1.24      |
| NC37LG2      | C1.23      |
| NC3WH6       | C1.24      |
| NC4WH6       | C1.24      |
| NC50LG2      | C1.23      |
| NC75LG2      | C1.23      |
| NE.5X.5WH6   | C1.24      |
| NE.5X1WH6    | C1.24      |
| NE1.5X1.5WH6 | C1.24      |
| NE1.5X2WH6   | C1.24      |
| NE1.5X2WH6-A | C1.33      |
| NE1.5X3WH6   | C1.24      |
| NE1.5X4WH6   | C1.24      |
| NE1X1.5WH6   | C1.24      |
| NE1X1WH6     | C1.24      |
| NE1X2WH6     | C1.24      |
| NE1X3WH6     | C1.24      |
| NE1X4WH6     | C1.24      |
| NE2X1WH6     | C1.24      |
| NE2X2WH6     | C1.24      |
| NE2X2WH6-A   | C1.33      |
| NE2X3WH6     | C1.24      |



| Part Number   | Page Number  |
|---------------|--------------|
| NE2X4WH6      | C1.24        |
| NE3X1WH6      | C1.24        |
| NE3X2WH6      | C1.24        |
| NE3X3WH6      | C1.24        |
| NE3X4WH6      | C1.24        |
| NE3X5WH6      | C1.24        |
| NE4X2WH6      | C1.24        |
| NE4X2WH6-A    | C1.33        |
| NE4X3WH6      | C1.24        |
| NE4X3WH6-A    | C1.33        |
| NE4X4WH6      | C1.24        |
| NE4X4WH6-A    | C1.33        |
| NE4X5WH6      | C1.24        |
| NK2HSRFIW     | C2.54        |
| NK4HSRFIW     | C2.54        |
| NK4VSRFIW     | C2.54        |
| NNC100X100LG2 | C1.23        |
| NNC100X50LG2  | C1.23        |
| NNC100X75LG2  | C1.23        |
| NNC25X25LG2   | C1.23        |
| NNC25X37LG2   | C1.23        |
| NNC25X50LG2   | C1.23        |
| NNC25X75LG2   | C1.23        |
| NNC37X37LG2   | C1.23        |
| NNC37X50LG2   | C1.23        |
| NNC37X75LG2   | C1.23        |
| NNC50DWH2     | C1.23, C1.27 |
| NNC50X100LG2  | C1.23        |
| NNC50X50LG2   | C1.23        |
| NNC50X75LG2   | C1.23        |
| NNC75DWH2     | C1.23, C1.27 |
| NNC75X75LG2   | C1.23        |
| NR1-C         | C1.34        |
| NR1-M         | C1.34        |
| NR2WH-L       | C1.59        |
| NR4BL-L       | C1.59        |

## O

|                 |              |
|-----------------|--------------|
| OCF10IW-X       | C2.79        |
| OCF3IW-E        | C2.79        |
| OCF5IW-E        | C2.79        |
| OCFC10IW-X      | C2.81        |
| OCFC3IW-X       | C2.81        |
| OCFC5IW-X       | C2.81        |
| OCFX10IW-X      | C2.75, C2.80 |
| OCFX3IW-X       | C2.80        |
| OCFX5IW-X       | C2.80        |
| OF70FH2OB       | C2.101       |
| OF70FH4OB       | C2.101       |
| OF70FV2OB       | C2.101       |
| OF70FV4OB       | C2.101       |
| OF70FCOB        | C2.100       |
| OF70FCOB6       | C2.98        |
| OF70FCOB6       | C2.98        |
| OFR20CCOB-X     | C2.101       |
| OFR20CPOB8      | C2.99        |
| OFR20CROB       | C2.100       |
| OFR20DMBOB      | C2.100       |
| OFR20DSOOb      | C2.100       |
| OFR20ECOB       | C2.101       |
| OFR20ICOB       | C2.101       |
| OFR20LCOB       | C2.101       |
| OFR20MPTOB      | C2.100       |
| OFR20OB6        | C2.98        |
| OFR20OB8        | C2.98        |
| OFR20OCOB       | C2.101       |
| OFR20OFCR70OB1  | C2.99        |
| OFR20OFCR70OB1P | C2.99        |
| OFR20OFCR70OB2  | C2.99        |
| OFR20OFCR70OB2P | C2.99        |
| OFR20OFCR70OB4  | C2.99        |
| OFR20OFCR70OB4P | C2.99        |
| OFR20RAOB       | C2.100       |
| OFR20SOOB       | C2.100       |
| OFR20TOB        | C2.100       |
| OFR20WEOB       | C2.100       |

| Part Number  | Page Number |
|--------------|-------------|
| OFVR5OB6     | C2.98       |
| <b>P</b>     |             |
| P10-10F-L    | D1.29       |
| P10-10FF-L   | D1.30       |
| P10-10LF-L   | D1.30       |
| P10-10R-L    | D1.17       |
| P10-10RHT6-L | D1.19       |
| P10-10SLF-L  | D1.31       |
| P10-12R-L    | D1.17       |
| P10-14F-L    | D1.29       |
| P10-14LF-L   | D1.30       |
| P10-14R-L    | D1.17       |
| P10-14RHT6-L | D1.19       |
| P10-14SLF-L  | D1.31       |
| P10-38R-L    | D1.17       |
| P10-56R-L    | D1.17       |
| P10-5SLF-L   | D1.31       |
| P10-610R-L   | D1.18       |
| P10-6F-L     | D1.29       |
| P10-6LF-L    | D1.30       |
| P10-6R-L     | D1.17       |
| P10-6RHT6-L  | D1.19       |
| P10-8F-L     | D1.29       |
| P10-8LF-L    | D1.30       |
| P10-8R-L     | D1.17       |
| P10-8RHT6-L  | D1.19       |
| P10-8SLF-L   | D1.31       |
| P10-P55-L    | D1.54       |
| P12-10HDR-L  | D1.20       |
| P12-14HDR-L  | D1.20       |
| P12-38HDR-L  | D1.20       |
| P12-56HDR-L  | D1.20       |
| P12-6HDR-L   | D1.20       |
| P12-8HDR-L   | D1.20       |
| P14-10F-C    | D1.29       |
| P14-10FN-C   | D1.29       |
| P14-10LF-C   | D1.30       |
| P14-10LFN-C  | D1.30       |
| P14-10R-C    | D1.17       |
| P14-10RHT6-C | D1.19       |
| P14-10SLF-C  | D1.31       |
| P14-12R-L    | D1.17       |
| P14-14F-C    | D1.29       |
| P14-14R-C    | D1.17       |
| P14-14SLF-C  | D1.31       |
| P14-38R-C    | D1.17       |
| P14-4R-C     | D1.17       |
| P14-56R-C    | D1.17       |
| P14-610R-C   | D1.18       |
| P14-6F-C     | D1.29       |
| P14-6FF-C    | D1.30       |
| P14-6FN-C    | D1.29       |
| P14-6LF-C    | D1.30       |
| P14-6LFW-C   | D1.30       |
| P14-6R-C     | D1.17       |
| P14-6RHT6-C  | D1.19       |
| P14-6SLF-C   | D1.31       |
| P14-8F-C     | D1.29       |
| P14-8FF-C    | D1.30       |
| P14-8LF-C    | D1.30       |
| P14-8R-C     | D1.17       |
| P14-8RHT6-C  | D1.19       |
| P14-8SLF-C   | D1.31       |
| P14-P47-C    | D1.54       |
| P18-10F-C    | D1.29       |
| P18-10FN-C   | D1.29       |
| P18-10LF-C   | D1.30       |
| P18-10LFN-C  | D1.30       |
| P18-10R-C    | D1.17       |
| P18-10RHT6-C | D1.19       |
| P18-10SLF-C  | D1.31       |
| P18-12R-C    | D1.17       |
| P18-14F-C    | D1.29       |
| P18-14R-C    | D1.17       |
| P18-38R-C    | D1.17       |

| Part Number        | Page Number  |
|--------------------|--------------|
| P18-4R-C           | D1.17        |
| P18-56R-C          | D1.17        |
| P18-610R-C         | D1.18        |
| P18-6F-C           | D1.29        |
| P18-6FN-C          | D1.29        |
| P18-6LF-C          | D1.30        |
| P18-6LFW-C         | D1.30        |
| P18-6R-C           | D1.17        |
| P18-6RHT6-C        | D1.19        |
| P18-6RN-C          | D1.17        |
| P18-6SLF-C         | D1.31        |
| P18-8F-C           | D1.29        |
| P18-8FF-C          | D1.30        |
| P18-8LF-C          | D1.30        |
| P18-8R-C           | D1.17        |
| P18-8RHT6-C        | D1.19        |
| P18-8SLF-C         | D1.31        |
| P18-P47-C          | D1.54        |
| P2-10R-X           | D1.20        |
| P2-12R-X           | D1.20        |
| <b>P2-12RHT6-X</b> | <b>D1.19</b> |
| P2-14R-X           | D1.20        |
| <b>P2-14RHT6-X</b> | <b>D1.19</b> |
| P2-38R-X           | D1.20        |
| <b>P2-38RHT6-X</b> | <b>D1.19</b> |
| P2-56R-X           | D1.20        |
| <b>P2-56RHT6-X</b> | <b>D1.19</b> |
| P22-10R-C          | D1.17        |
| P22-2F-C           | D1.29        |
| P22-2R-C           | D1.17        |
| P22-4F-C           | D1.29        |
| P22-4R-C           | D1.17        |
| P22-6F-C           | D1.29        |
| P22-6R-C           | D1.17        |
| P22-8R-C           | D1.17        |
| P2NLT-500-3        | D2.134       |
| P32W2A2-100-7      | C2.84        |
| P32W2A2-100-72     | C2.84        |
| P32W2A2-50-7       | C1.32, C2.84 |
| P32W2A2-50-72      | C1.32, C2.84 |
| P32W2A2-75-7       | C1.32, C2.84 |
| P32W2A2-75-72      | C1.32, C2.84 |
| P32W2R1-100-7      | C2.84        |
| P32W2R1-100-72     | C2.84        |
| P32W2R1-150-72     | C2.84        |
| P32W2R1-50-7       | C2.84        |
| P32W2R1-50-72      | C2.84        |
| P32W2R1-75-7       | C2.84        |
| P32W2R1-75-72      | C2.84        |
| P4-10R-E           | D1.20        |
| <b>P4-10RHT6-E</b> | <b>D1.19</b> |
| P4-12R-E           | D1.20        |
| <b>P4-12RHT6-E</b> | <b>D1.19</b> |
| P4-14R-E           | D1.20        |
| <b>P4-14RHT6-E</b> | <b>D1.19</b> |
| P4-38R-E           | D1.20        |
| <b>P4-38RHT6-E</b> | <b>D1.19</b> |
| P4-56R-E           | D1.20        |
| <b>P4-56RHT6-E</b> | <b>D1.19</b> |
| P6-10R-E           | D1.20        |
| <b>P6-10RHT6-E</b> | <b>D1.19</b> |
| P6-12R-E           | D1.20        |
| <b>P6-12RHT6-E</b> | <b>D1.19</b> |
| P6-14R-E           | D1.20        |
| <b>P6-14RHT6-E</b> | <b>D1.19</b> |
| P6-38R-E           | D1.20        |
| <b>P6-38RHT6-E</b> | <b>D1.19</b> |
| P6-56R-E           | D1.20        |
| <b>P6-56RHT6-E</b> | <b>D1.19</b> |
| P6-8R-E            | D1.20        |
| <b>P6-8RHT6-E</b>  | <b>D1.19</b> |
| P8-10R-Q           | D1.20        |
| <b>P8-10RHT6-Q</b> | <b>D1.19</b> |
| P8-12R-Q           | D1.20        |
| <b>P8-12RHT6-Q</b> | <b>D1.19</b> |
| P8-14R-Q           | D1.20        |

## A. System Overview

### B1. Cable Ties

### B2. Cable Accessories

### B3. Stainless Steel Ties

### C1. Wiring Duct

### C2. Surface Raceway

### C3. Abrasion Protection

### C4. Cable Management

### D1. Terminals

### D2. Power Connectors

### D3. Grounding Connectors

### E1. Labeling Systems

### E2. Labels

### E3. Pre-Printed & Write-On Markers

### E4. Permanent Identification

### E5. Lockout/ Tagout & Safety Solutions

### F. Index

# PANDUIT® ELECTRICAL SOLUTIONS

| A.<br>System<br>Overview                           | Part Number          | Page<br>Number | Part Number          | Page<br>Number | Part Number            | Page<br>Number |
|--|----------------------|----------------|----------------------|----------------|------------------------|----------------|
| B1.<br>Cable Ties                                  | <b>P8-14RHT6-Q</b>   | <b>D1.19</b>   | PCA23-A-D            | E3.12          | PCM-175-199            | E3.4           |
|  | P8-38R-Q             | D1.20          | PCA23-E-H            | E3.12          | PCM-19-36              | E3.4           |
| B2.<br>Cable<br>Accessories                        | <b>P8-38RHT6-Q</b>   | <b>D1.19</b>   | PCA23-I-L            | E3.12          | PCM-1L1 thru PCM-1L3   | E3.6           |
|  | P8-56R-Q             | D1.20          | PCA23-M-P            | E3.12          | PCM-1T1 thru PCM-1T3   | E3.6           |
| B3.<br>Stainless<br>Steel Ties                     | <b>P8-56RHT6-Q</b>   | <b>D1.19</b>   | PCA23-MIN            | E3.12          | PCM-200-224            | E3.4           |
|  | P8-8R-Q              | D1.20          | PCA23-PLS            | E3.12          | PCM-225-249            | E3.4           |
| C1.<br>Wiring<br>Duct                              | <b>P8-8RHT6-Q</b>    | <b>D1.19</b>   | PCA23-Q-T            | E3.12          | PCM-250-274            | E3.4           |
|  | PARW125-RED          | E5.31          | PCA23-U-X            | E3.12          | PCM-275-299            | E3.4           |
| C2.<br>Surface<br>Raceway                          | PARW125-YEL          | E5.31          | PCA23-Y-Z            | E3.12          | PCM-2L1 thru PCM-2L3   | E3.6           |
|  | PAT                  | B1.117         | PCL037-0             | E5.37          | PCM-300-324            | E3.4           |
| C3.<br>Abrasion<br>Protection                      | PAT1.5M              | B1.117         | PCL037-0-9           | E5.37          | PCM-325-349            | E3.4           |
|  | <b>PAT1.5M-ATM</b>   | <b>B1.117</b>  | PCL037-1             | E5.37          | PCM-34-66              | E3.4           |
| C4.<br>Cable<br>Management                         | PAT1M                | B1.117         | PCL037-9             | E5.37          | PCM-350-374            | E3.4           |
|  | PAT2S                | B1.117         | PCL037-A             | E5.37          | PCM-375-399            | E3.4           |
| D1.<br>Terminals                                   | <b>PAT3S</b>         | <b>B1.117</b>  | PCL037-A-Z           | E5.37          | PCM-3T1 thru PCM-3T3   | E3.6           |
|  | PATMBM               | B1.118         | PCL037-DSH           | E5.37          | PCM-400-424            | E3.4           |
| D2.<br>Power<br>Connectors                         | <b>PATM-RK</b>       | <b>B1.119</b>  | PCL062-0             | E5.37          | PCM-425-449            | E3.4           |
|  | <b>PATM-RKS</b>      | <b>B1.119</b>  | PCL062-0-9           | E5.37          | PCM-450-474            | E3.4           |
| D3.<br>Grounding<br>Connectors                     | <b>PATM-TT</b>       | <b>B1.119</b>  | PCL062-1             | E5.37          | PCM-475-499            | E3.4           |
|  | PATSBM               | B1.118         | PCL062-9             | E5.37          | PCM-4L1 thru PCM-4L3   | E3.6           |
| E1.<br>Labeling<br>Systems                         | PBDCT                | C1.34          | PCL062-A             | E5.37          | PCM-500-524            | E3.4           |
|  | PBMS-H25-C           | B2.20          | PCL062-A-Z           | E5.37          | PCM-67-99              | E3.4           |
| E2.<br>Labels                                      | PBMS-H25-C14         | B2.20          | PCL062-DSH           | E5.37          | PCM-A thru PCM-Z       | E3.5           |
|  | PBMS-H25-M0          | B2.20          | PCL062-Z             | E5.37          | PCM-A1 thru PCM-A4     | E3.5           |
| E3.<br>Pre-Printed<br>& Write-On<br>Markers        | PBMS-H25-M30         | B2.20          | PCL100-0             | E5.37          | PCM-A-Z                | E3.5           |
|  | PBMSL-H25-C30        | B2.20          | PCL100-0-9           | E5.37          | PCM-A-Z-0-9            | E3.5           |
| E4.<br>Permanent<br>Identification                 | PBMSL-H25-M30        | B2.20          | PCL100-1             | E5.37          | PCM-BLK                | E3.6           |
|  | PBSC1-X              | B2.50          | PCL100-9             | E5.37          | PCM-BRN                | E3.6           |
| E5.<br>Lockout/<br>Tagout<br>& Safety<br>Solutions | PBSC12-X             | B2.50          | PCL100-A             | E5.37          | PCM-DBL                | E3.6           |
|  | PBSC3-X              | B2.50          | PCL100-A-J           | E5.37          | PCM-DGN                | E3.6           |
| F.<br>Index  | PBSC6-X              | B2.50          | PCL100-DSH           | E5.37          | PCM-GRY                | E3.6           |
|  | <b>PBMT</b>          | <b>B3.16</b>   | PCL100-K-T           | E5.37          | PCM-LBL                | E3.6           |
|  | PC038-H25D-C0        | B2.39          | PCL100-U-Z           | E5.37          | PCM-LGN                | E3.6           |
|  | PC050-H25D-C0        | B2.39          | PCL100-Z             | E5.37          | PCM-ORN                | E3.6           |
|  | PC062-H25D-C0        | B2.39          | PCL200-0             | E5.37          | PCM-PNK                | E3.6           |
|  | PC075-H25D-C0        | B2.39          | PCL200-0-9           | E5.37          | PCM-PUR                | E3.6           |
|  | PC087-H25D-C0        | B2.39          | PCL200-1             | E5.37          | PCM-RED                | E3.6           |
|  | PC100-H25D-C0        | B2.39          | PCL200-9             | E5.37          | PCM-TAN                | E3.6           |
|  | PC112-H25D-C0        | B2.39          | PCL200-A             | E5.37          | PCM-WHT                | E3.6           |
|  | PC125-H25D-C0        | B2.39          | PCL200-A-J           | E5.37          | PCM-YEL                | E3.6           |
|  | PCA07-0 thru PCA07-9 | E3.11          | PCL200-DSH           | E5.37          | PCMB-1                 | E3.2           |
|  | PCA07-0-9            | E3.11          | PCL200-K-T           | E5.37          | PCM-B1 thru PCM-B5     | E3.5           |
|  | PCA07-A thru PCA07-Z | E3.11          | PCL200-U-Z           | E5.37          | PCMB-10                | E3.2           |
|  | PCA07-A-J            | E3.11          | PCL200-Z             | E5.37          | PCMB-11                | E3.2           |
|  | PCA07-K-T            | E3.11          | PCL300-0             | E5.38          | PCMB-12                | E3.2           |
|  | PCA07-MIN            | E3.11          | PCL300-1             | E5.38          | PCMB-13                | E3.2           |
|  | PCA07-PLS            | E3.11          | PCL300-9             | E5.38          | PCMB-14                | E3.2           |
|  | PCA07-U-Z            | E3.11          | PCL300-A             | E5.38          | PCMB-15                | E3.2           |
|  | PCA11-0 thru PCA11-9 | E3.12          | PCL300-DSH           | E5.38          | PCMB-16                | E3.2           |
|  | PCA11-0-9            | E3.12          | PCL300-Z             | E5.38          | PCMB-2                 | E3.2           |
|  | PCA11-A thru PCA11-Z | E3.12          | PCLCP037-0-9         | E5.37          | PCMB-25                | E3.2           |
|  | PCA11-A-J            | E3.12          | PCLCP037-A-Z         | E5.37          | PCMB-3                 | E3.2           |
|  | PCA11-K-T            | E3.12          | PCLCP062-0-9         | E5.37          | PCMB-4                 | E3.2           |
|  | PCA11-MIN            | E3.12          | PCLCP062-A-Z         | E5.37          | PCMB-5                 | E3.2           |
|  | PCA11-PLS            | E3.12          | PCLCP100-0-9         | E5.37          | PCMB-6                 | E3.2           |
|  | PCA11-U-Z            | E3.12          | PCLCP100-A-Z         | E5.37          | PCMB-7                 | E3.2           |
|  | PCA13-0 thru PCA13-9 | E3.12          | PCLCP200-0-9         | E5.37          | PCMB-8                 | E3.2           |
|  | PCA13-0-9            | E3.12          | PCLCP200-A-Z         | E5.37          | PCMB-9                 | E3.2           |
|  | PCA13-A thru PCA13-Z | E3.12          | PCLCP300-0-9         | E5.38          | PCM-C1 thru PCM-C4     | E3.5           |
|  | PCA13-A-J            | E3.12          | PCLCP300-A-Z         | E5.38          | PCMCP-1-25             | E3.7           |
|  | PCA13-K-T            | E3.12          | PCM-0 thru PCM-99    | E3.4           | PCMCP-101-125          | E3.7           |
|  | PCA13-MIN            | E3.12          | PCM-0-9              | E3.4           | PCMCP-126-150          | E3.7           |
|  | PCA13-PLS            | E3.12          | PCM-1-10             | E3.4           | PCMCP-26-50            | E3.7           |
|  | PCA13-U-Z            | E3.12          | PCM-1-12             | E3.4           | PCMCP-51-75            | E3.7           |
|  | PCA18-0 thru PCA18-9 | E3.12          | PCM-1-16             | E3.4           | PCMCP-76-100           | E3.7           |
|  | PCA18-0-9            | E3.12          | PCM-1-18             | E3.4           | PCMCP-A-Z              | E3.7           |
|  | PCA18-A thru PCA18-Z | E3.12          | PCM-1-3              | E3.4           | PCM-E1 thru PCM-E3     | E3.5           |
|  | PCA18-A-J            | E3.12          | PCM-1-33             | E3.4           | PCM-F1 thru PCM-F4     | E3.5           |
|  | PCA18-K-T            | E3.12          | PCM-1-4              | E3.4           | PCMH-0 thru PCMH-25    | E3.4           |
|  | PCA18-MIN            | E3.12          | PCM-1-5              | E3.4           | PCM-H1 thru PCM-H5     | E3.5           |
|  | PCA18-PLS            | E3.12          | PCM-1-6              | E3.4           | PCMH-3L1 thru PCMH-3L3 | E3.6           |
|  | PCA18-U-Z            | E3.12          | PCM-1-8              | E3.4           | PCM-L1 thru PCM-L5     | E3.5           |
|  | PCA23-0 thru PCA23-9 | E3.12          | PCM-1-9              | E3.4           | PCM-M1 thru PCM-M2     | E3.5           |
|  | PCA23-0-3            | E3.12          | PCM-100 thru PCM-202 | E3.4           | PCM-P1 thru PCM-P3     | E3.5           |
|  | PCA23-4-7            | E3.12          | PCM-100-124          | E3.4           | PCM-R1 thru PCM-R5     | E3.5           |
|  | PCA23-8-9            | E3.12          | PCM-125-149          | E3.4           | PCM-S1 thru PCM-S5     | E3.5           |
|  | PCA23-A thru PCA23-Z | E3.12          | PCM-150-174          | E3.4           | PCM-T1 thru PCM-T9     | E3.5           |



# PANDUIT® ELECTRICAL SOLUTIONS

| Part Number        | Page Number | Part Number     | Page Number | Part Number   | Page Number |
|--------------------|-------------|-----------------|-------------|---------------|-------------|
| PCM-X1 thru PCM-X4 | E3.5        | PCSB4-3S-12Y    | D2.149      | PCSSH-B-CR    | B3.26       |
| PCPA11IW           | C2.107      | PCSB4-4-6Y      | D2.150      | PCV-110AY     | E5.32       |
| PCPA11R20IW        | C2.104      | PCSB4-4S-6Y     | D2.149      | PCV-110BY     | E5.32       |
| PCPA13IW           | C2.107      | PCSB4-5-6Y      | D2.150      | PCV-110CY     | E5.32       |
| PCPA13R20IW        | C2.104      | PCSB4-5S-6Y     | D2.149      | PCV-115AY     | E5.32       |
| PCPAK16IW          | C2.110      | PCSB4-6-6Y      | D2.150      | PCV-115BY     | E5.32       |
| PCPAK22IW          | C2.110      | PCSB4-6S-6Y     | D2.149      | PCV-115CY     | E5.32       |
| PCPAKR20IW         | C2.110      | PCSB4-8-4Y      | D2.150      | PCV-120/208AY | E5.32       |
| PCPAKRIW           | C2.110      | PCSB600-10-1Y   | D2.151      | PCV-120/208BY | E5.32       |
| PCPBRC             | C2.111      | PCSB600-10S-1Y  | D2.149      | PCV-120/208CY | E5.32       |
| PCPECIW            | C2.111      | PCSB600-12-1Y   | D2.151      | PCV-120AY     | E5.32       |
| PCPKITIW           | C2.111      | PCSB600-12S-1Y  | D2.149      | PCV-120BY     | E5.32       |
| PCPTPIW            | C2.111      | PCSB600-14-1Y   | D2.151      | PCV-120CY     | E5.32       |
| PCSB2/0-10-2Y      | D2.150      | PCSB600-14S-1Y  | D2.149      | PCV-120RY     | E5.32       |
| PCSB2/0-10S-2Y     | D2.149      | PCSB600-2-4Y    | D2.151      | PCV-12470AY   | E5.32       |
| PCSB2/0-12-2Y      | D2.150      | PCSB600-2S-4Y   | D2.149      | PCV-12470BY   | E5.32       |
| PCSB2/0-12S-1Y     | D2.149      | PCSB600-3-3Y    | D2.151      | PCV-12470CY   | E5.32       |
| PCSB2/0-14-1Y      | D2.150      | PCSB600-3S-3Y   | D2.149      | PCV-13200AY   | E5.32       |
| PCSB2/0-14S-1Y     | D2.149      | PCSB600-4-2Y    | D2.151      | PCV-13200BY   | E5.32       |
| PCSB2/0-2-12       | D2.150      | PCSB600-4S-2Y   | D2.149      | PCV-13200CY   | E5.32       |
| PCSB2/0-2S-6       | D2.149      | PCSB600-5-2     | D2.151      | PCV-13800AY   | E5.32       |
| PCSB2/0-3-6        | D2.150      | PCSB600-5S-2Y   | D2.149      | PCV-13800BY   | E5.32       |
| PCSB2/0-3S-6Y      | D2.149      | PCSB600-6-2Y    | D2.151      | PCV-13800CY   | E5.32       |
| PCSB2/0-4-6        | D2.150      | PCSB600-6S-2Y   | D2.149      | PCV-1PHAY     | E5.32       |
| PCSB2/0-4S-6Y      | D2.149      | PCSB600-8-2Y    | D2.151      | PCV-1PHBY     | E5.32       |
| PCSB2/0-5-6        | D2.150      | PCSB600-8S-2Y   | D2.149      | PCV-1PHCY     | E5.32       |
| PCSB2/0-5S-4Y      | D2.149      | PCSB750-10-1Y   | D2.151      | PCV-208AY     | E5.32       |
| PCSB2/0-6-6        | D2.150      | PCSB750-2-2Y    | D2.151      | PCV-208BY     | E5.32       |
| PCSB2/0-6S-4Y      | D2.149      | PCSB750-2S-1    | D2.149      | PCV-208CY     | E5.32       |
| PCSB2/0-7-4        | D2.156      | PCSB750-3-2Y    | D2.151      | PCV-220AY     | E5.32       |
| PCSB2/0-8-4        | D2.150      | PCSB750-4-2Y    | D2.151      | PCV-220BY     | E5.32       |
| PCSB2/0-8S-3Y      | D2.149      | PCSB750-5-1Y    | D2.151      | PCV-220CY     | E5.32       |
| PCSB250-10-2Y      | D2.150      | PCSB750-6-1Y    | D2.151      | PCV-2300AY    | E5.32       |
| PCSB250-10S-2Y     | D2.149      | PCSB750-8-1Y    | D2.151      | PCV-2300BY    | E5.32       |
| PCSB250-12-2Y      | D2.150      | PCSB750-10-1Y   | D2.157      | PCV-2300CY    | E5.32       |
| PCSB250-12S-2Y     | D2.149      | PCSBMT2/0-10-2Y | D2.154      | PCV-230AY     | E5.32       |
| PCSB250-14-1Y      | D2.150      | PCSBMT2/0-10S2Y | D2.153      | PCV-230BY     | E5.32       |
| PCSB250-14S-1Y     | D2.149      | PCSBMT2/0-12-1Y | D2.154      | PCV-230CY     | E5.32       |
| PCSB250-2-6Y       | D2.150      | PCSBMT2/0-12S1Y | D2.153      | PCV-2400AY    | E5.32       |
| PCSB250-2S-6Y      | D2.149      | PCSBMT2/0-4-3Y  | D2.154      | PCV-2400BY    | E5.32       |
| PCSB250-3-6Y       | D2.150      | PCSBMT2/0-4S-3Y | D2.153      | PCV-2400CY    | E5.32       |
| PCSB250-3S-6Y      | D2.149      | PCSBMT2/0-6-2Y  | D2.154      | PCV-240AY     | E5.32       |
| PCSB250-4-6Y       | D2.150      | PCSBMT2/0-6S-2Y | D2.153      | PCV-240BY     | E5.32       |
| PCSB250-4S-6Y      | D2.149      | PCSBMT2/0-8-2Y  | D2.154      | PCV-240CY     | E5.32       |
| PCSB250-5-4Y       | D2.150      | PCSBMT2/0-8S-2Y | D2.153      | PCV-277/480AY | E5.32       |
| PCSB250-5S-4Y      | D2.149      | PCSBMT250-10-2Y | D2.154      | PCV-277/480BY | E5.32       |
| PCSB250-6-4Y       | D2.150      | PCSBMT250-10S2Y | D2.153      | PCV-277/480CY | E5.32       |
| PCSB250-6S-4Y      | D2.149      | PCSBMT250-12-1Y | D2.154      | PCV-277AY     | E5.32       |
| PCSB250-8-3Y       | D2.150      | PCSBMT250-12S1Y | D2.153      | PCV-277BY     | E5.32       |
| PCSB250-8S-3Y      | D2.149      | PCSBMT250-4-2Y  | D2.154      | PCV-277CY     | E5.32       |
| PCSB350-10-2Y      | D2.151      | PCSBMT250-4S-2Y | D2.153      | PCV-380AY     | E5.32       |
| PCSB350-10S-2Y     | D2.149      | PCSBMT250-6-2Y  | D2.154      | PCV-380BY     | E5.32       |
| PCSB350-12-1Y      | D2.151      | PCSBMT250-6S-2Y | D2.153      | PCV-380CY     | E5.32       |
| PCSB350-12S-1Y     | D2.149      | PCSBMT250-8-2Y  | D2.154      | PCV-3PHAY     | E5.32       |
| PCSB350-14-1Y      | D2.151      | PCSBMT250-8S-2Y | D2.153      | PCV-3PHBY     | E5.32       |
| PCSB350-14S-1Y     | D2.149      | PCSBMT250-10-1Y | D2.154      | PCV-3PHCY     | E5.32       |
| PCSB350-2-4        | D2.151      | PCSBMT250-10S1Y | D2.153      | PCV-415AY     | E5.32       |
| PCSB350-2S-4Y      | D2.149      | PCSBMT250-12-1Y | D2.154      | PCV-415BY     | E5.32       |
| PCSB350-3-4        | D2.151      | PCSBMT250-12S1Y | D2.153      | PCV-415CY     | E5.32       |
| PCSB350-3S-4Y      | D2.149      | PCSBMT250-4-2Y  | D2.154      | PCV-4160AY    | E5.32       |
| PCSB350-4-3        | D2.151      | PCSBMT250-4S-2Y | D2.153      | PCV-4160BY    | E5.32       |
| PCSB350-4S-3Y      | D2.149      | PCSBMT250-6-2Y  | D2.154      | PCV-4160CY    | E5.32       |
| PCSB350-5-3        | D2.151      | PCSBMT250-6S-2Y | D2.153      | PCV-440AY     | E5.32       |
| PCSB350-5S-3Y      | D2.149      | PCSBMT250-8-2Y  | D2.154      | PCV-440BY     | E5.32       |
| PCSB350-6-2        | D2.151      | PCSBMT250-8S-2Y | D2.153      | PCV-440CY     | E5.32       |
| PCSB350-6S-2Y      | D2.149      | PCSBMT600-10-1Y | D2.154      | PCV-460AY     | E5.32       |
| PCSB350-8-2        | D2.151      | PCSBMT600-10S1Y | D2.153      | PCV-460BY     | E5.32       |
| PCSB350-8S-2Y      | D2.149      | PCSBMT600-12-1Y | D2.154      | PCV-460CY     | E5.32       |
| PCSB4-10-4Y        | D2.150      | PCSBMT600-12S1Y | D2.153      | PCV-480AY     | E5.32       |
| PCSB4-10S-4Y       | D2.149      | PCSBMT600-4-2Y  | D2.154      | PCV-480BY     | E5.32       |
| PCSB4-12-3Y        | D2.150      | PCSBMT600-4S-2Y | D2.153      | PCV-480CY     | E5.32       |
| PCSB4-12S-3Y       | D2.149      | PCSBMT600-6-2Y  | D2.154      | PCV-600AY     | E5.32       |
| PCSB4-14-2Y        | D2.150      | PCSBMT600-6S-2Y | D2.153      | PCV-600BY     | E5.32       |
| PCSB4-14S-2Y       | D2.149      | PCSBMT600-8-2Y  | D2.154      | PCV-600CY     | E5.32       |
| PCSB4-2-12Y        | D2.150      | PCSBMT600-8S-2Y | D2.153      | PCV-BLANKAY   | E5.32       |
| PCSB4-2S-12Y       | D2.149      | PCSH-B-CR       | B3.26       | PCV-BLANKBY   | E5.32       |
| PCSB4-3-12Y        | D2.150      | PCSSH-B-CR      | B3.26       | PCV-BLANKCY   | E5.32       |

A.  
System  
Overview

B1.  
Cable Ties

B2.  
Cable  
Accessories

B3.  
Stainless  
Steel Ties

C1.  
Wiring  
Duct

C2.  
Surface  
Raceway

C3.  
Abrasion  
Protection

C4.  
Cable  
Management

D1.  
Terminals

D2.  
Power  
Connectors

D3.  
Grounding  
Connectors

E1.  
Labeling  
Systems

E2.  
Labels

E3.  
Pre-Printed  
& Write-On  
Markers

E4.  
Permanent  
Identification

E5.  
Lockout/  
Tagout  
& Safety  
Solutions

F.  
Index

# PANDUIT® ELECTRICAL SOLUTIONS

| A. System Overview                    | Part Number   | Page Number    | Part Number | Page Number         | Part Number       | Page Number   |
|---------------------------------------|---------------|----------------|-------------|---------------------|-------------------|---------------|
| B1. Cable Ties                        | PCV-ESAY      | E5.32          | PESS-B-L2   | E5.26               | PHM1              | B1.118        |
|                                       | PCV-ESBY      | E5.32          | PESS-B-L3   | E5.26               | PHM2              | B1.118        |
|                                       | PCV-ESCY      | E5.32          | PESS-B-N    | E5.26               | PHM3              | B1.118        |
| B2. Cable Accessories                 | PCV-FAAY      | E5.32          | PESS-B-SS   | E5.26               | PHM4              | B1.118        |
|                                       | PCV-FABY      | E5.32          | PESS-C-CE   | E5.26               | PHS2              | B1.118        |
|                                       | PCV-FACY      | E5.32          | PESS-C-ES   | E5.26               | PHS3              | B1.118        |
| B3. Stainless Steel Ties              | PCV-FOAY      | E5.32          | PESS-C-L1   | E5.26               | PISR1/0-1         | D2.152        |
|                                       | PCV-FOBY      | E5.32          | PESS-C-L2   | E5.26               | PISR2-1           | D2.152        |
|                                       | PCV-FOCAY     | E5.32          | PESS-C-L3   | E5.26               | PISR250-1         | D2.152        |
| C1. Wiring Duct                       | PCV-FOCBY     | E5.32          | PESS-C-N    | E5.26               | PISR350-1         | D2.152        |
|                                       | PCV-FOCCY     | E5.32          | PESS-C-SS   | E5.26               | PISR500-1         | D2.152        |
|                                       | PCV-FOCY      | E5.32          | PESS-D-CE   | E5.26               | PK10-10R-L        | D1.12         |
| C2. Surface Raceway                   | PCV-FOMY      | E5.32          | PESS-D-ES   | E5.26               | PK10-14R-L        | D1.12         |
|                                       | PCV-FORY      | E5.32          | PESS-D-L1   | E5.26               | <b>PK10-38R-Q</b> | <b>D1.12</b>  |
|                                       | PCV-MAINAY    | E5.32          | PESS-D-L2   | E5.26               | PK10-6R-L         | D1.12         |
| C3. Abrasion Protection               | PCV-MAINBY    | E5.32          | PESS-D-L3   | E5.26               | PK10-8R-L         | D1.12         |
|                                       | PCV-MAINCY    | E5.32          | PESS-D-N    | E5.26               | PK14-10R-C        | D1.12         |
|                                       | PCV-TELEAY    | E5.32          | PESS-D-SS   | E5.26               | PK14-14R-C        | D1.12         |
| C4. Cable Management                  | PCV-TELEBY    | E5.32          | PESS-E-CE   | E5.26               | <b>PK14-38R-C</b> | <b>D1.12</b>  |
|                                       | PCV-TELECY    | E5.32          | PESS-E-ES   | E5.26               | PK14-4R-C         | D1.12         |
|                                       | PCVB-110Y     | E5.33          | PESS-E-L1   | E5.26               | PK14-6R-C         | D1.12         |
| D1. Terminals                         | PCVB-220Y     | E5.33          | PESS-E-L2   | E5.26               | PK14-8R-C         | D1.12         |
|                                       | PCVB-277Y     | E5.33          | PESS-E-L3   | E5.26               | <b>PK14-56R-C</b> | <b>D1.12</b>  |
|                                       | PCVB-277/480Y | E5.33          | PESW-A-1Y   | E5.27               | PK18-10R-C        | D1.12         |
| D2. Power Connectors                  | PCVB-4160Y    | E5.33          | PESW-A-11Y  | E5.27               | <b>PK18-14R-C</b> | <b>D1.12</b>  |
|                                       | PCVB-440Y     | E5.33          | PESW-A-6Y   | E5.27               | <b>PK18-38R-C</b> | <b>D1.12</b>  |
|                                       | PCVB-480Y     | E5.33          | PESW-A-8Y   | E5.27               | PK18-4R-C         | D1.12         |
| D3. Grounding Connectors              | PCWL-ACC      | E5.29          | PESW-A-9Y   | E5.27               | PK18-6R-C         | D1.12         |
|                                       | PCWL-BL       | E5.29          | PESW-B-1Y   | E5.27               | PK18-8R-C         | D1.12         |
|                                       | PCWL-CAL      | E5.29          | PESW-B-11Y  | E5.27               | <b>PK18-56R-C</b> | <b>D1.12</b>  |
| E1. Labeling Systems                  | PCWL-CALD     | E5.29          | PESW-B-6Y   | E5.27               | <b>PK2-10R-T</b>  | <b>D1.12</b>  |
|                                       | PCWL-ICAL     | E5.29          | PESW-B-8Y   | E5.27               | <b>PK2-12R-T</b>  | <b>D1.12</b>  |
|                                       | PCWL-REJ      | E5.29          | PESW-B-8Y   | E5.27               | <b>PK2-14R-T</b>  | <b>D1.12</b>  |
| E2. Labels                            | PD3S          | B1.117         | PESW-B-9Y   | E5.27               | <b>PK2-38R-T</b>  | <b>D1.12</b>  |
|                                       | <b>PD3SF</b>  | <b>B1.118</b>  | PESW-C-1Y   | E5.27               | <b>PK2-56R-T</b>  | <b>D1.12</b>  |
|                                       | PD-DIA        | B1.119         | PESW-C-11Y  | E5.27               | <b>PK4-10R-T</b>  | <b>D1.12</b>  |
| E3. Pre-Printed & Write-On Markers    | PD-600-A      | D1.86          | PESW-C-6Y   | E5.27               | <b>PK4-10R-T</b>  | <b>D1.12</b>  |
|                                       | PDH10-37      | B1.118         | PESW-C-8Y   | E5.27               | <b>PK4-12R-T</b>  | <b>D1.12</b>  |
|                                       | PDM           | B1.117, B1.119 | PESW-C-9Y   | E5.27               | <b>PK4-14R-T</b>  | <b>D1.12</b>  |
| E4. Permanent Identification          | PDM-DI        | B1.119         | PESW-D-1Y   | E5.27               | <b>PK4-38R-T</b>  | <b>D1.12</b>  |
|                                       | PDS           | B1.117, B1.119 | PESW-D-11Y  | E5.27               | <b>PK4-56R-T</b>  | <b>D1.12</b>  |
|                                       | PDS-DI        | B1.119         | PESW-D-6Y   | E5.27               | <b>PK6-10R-T</b>  | <b>D1.12</b>  |
| E5. Lockout/Tagout & Safety Solutions | PDS-DIA       | B1.116         | PESW-D-8Y   | E5.27               | <b>PK6-12R-T</b>  | <b>D1.12</b>  |
|                                       | PDSF          | B1.118         | PESW-D-9Y   | E5.27               | <b>PK6-14R-T</b>  | <b>D1.12</b>  |
|                                       | PEIP-A-12Y    | E5.31          | PESW-E-1Y   | E5.27               | <b>PK6-38R-T</b>  | <b>D1.12</b>  |
| F. Index                              | PEIP-A-13Y    | E5.31          | PESW-E-11Y  | E5.27               | <b>PK6-56R-T</b>  | <b>D1.12</b>  |
|                                       | PEIP-A-14Y    | E5.31          | PESW-E-6Y   | E5.27               | <b>PK6-8R-T</b>   | <b>D1.12</b>  |
|                                       | PEIP-A-15Y    | E5.31          | PESW-E-8Y   | E5.27               | <b>PK8-10R-T</b>  | <b>D1.12</b>  |
|                                       | PEIP-D-12Y    | E5.31          | PESW-E-9Y   | E5.27               | <b>PK8-12R-T</b>  | <b>D1.12</b>  |
|                                       | PEIP-D-13Y    | E5.31          | PFX-0       | B1.51, B2.28, E5.18 | <b>PK8-14R-T</b>  | <b>D1.12</b>  |
|                                       | PEIP-D-14Y    | E5.31          | PFX-2       | B1.51, B2.28, E5.18 | <b>PK8-38R-T</b>  | <b>D1.12</b>  |
|                                       | PEIP-D-15Y    | E5.31          | PG-1        | D3.55               | <b>PK8-56R-T</b>  | <b>D1.12</b>  |
|                                       | <b>PES197</b> | <b>E4.6</b>    | PG-1SC      | D3.55               | <b>PK8-8R-T</b>   | <b>D1.12</b>  |
|                                       | PESC-H-AT     | E5.25          | PH10-10F-E  | D1.31               | PL283N1           | B1.118        |
|                                       | PESC-H-E      | E5.25          | PH10-10R-E  | D1.13               | PL289N1           | B1.113, B3.16 |
|                                       | PESC-H-EC     | E5.25          | PH10-12R-E  | D1.13               | PL2M2S-L          | B1.34         |
|                                       | PESC-H-HT     | E5.25          | PH10-14R-E  | D1.13               | PL2M2S-L0         | B1.34         |
|                                       | PESC-H-PE     | E5.25          | PH10-38R-E  | D1.13               | PL3B5EH-C0        | B1.78         |
|                                       | PESC-J-AT     | E5.25          | PH10-8F-E   | D1.31               | PL3M2S-D0         | B1.34         |
|                                       | PESC-J-E      | E5.25          | PH10-8R-E   | D1.13               | PL3M2S-L          | B1.34         |
|                                       | PESC-J-EC     | E5.25          | PH14-10F-Q  | D1.31               | PLA2S-A-Q         | B2.8          |
|                                       | PESC-J-HT     | E5.25          | PH14-10R-Q  | D1.13               | PLB2S-C           | B1.76         |
|                                       | PESC-J-PE     | E5.25          | PH14-14R-Q  | D1.13               | PLB2S-C0          | B1.76         |
|                                       | PES-S1        | E5.9           | PH14-38R-Q  | D1.13               | PLB2S-M30         | B1.76         |
|                                       | PESS-A-CE     | E5.26          | PH14-56R-Q  | D1.13               | PLB3S-C           | B1.76         |
|                                       | PESS-A-ES     | E5.26          | PH14-6F-Q   | D1.31               | PLB3S-C0          | B1.76         |
|                                       | PESS-A-L1     | E5.26          | PH14-6R-Q   | D1.13               | PLB3S-M30         | B1.76         |
|                                       | PESS-A-L2     | E5.26          | PH14-8F-Q   | D1.31               | PLB4H-TL          | B1.76         |
|                                       | PESS-A-L3     | E5.26          | PH14-8R-Q   | D1.13               | PLB4H-TL0         | B1.76         |
|                                       | PESS-A-LF     | E5.26          | PH18-10F-Q  | D1.31               | PLB4H-TL30        | B1.76         |
|                                       | PESS-A-LF     | E5.26          | PH18-10R-Q  | D1.13               | PLB4S-C           | B1.76         |
|                                       | PESS-A-N      | E5.26          | PH18-14R-Q  | D1.13               | PLB4S-M0          | B1.76         |
|                                       | PESS-A-PE     | E5.26          | PH18-6F-Q   | D1.31               | PLB4S-M30         | B1.76         |
|                                       | PESS-A-ROHS   | E5.26          | PH18-6R-Q   | D1.13               | PLC1.5I-S8-C      | B1.26         |
|                                       | PESS-A-SS     | E5.26          | PH18-8F-Q   | D1.31               | PLC1.5I-S8-C0     | B1.27         |
|                                       | PESS-B-CE     | E5.26          | PH18-8R-Q   | D1.13               | PLC1.5I-S8-M30    | B1.27         |
|                                       | PESS-B-ES     | E5.26          | PHCAQ       | B1.113              | PLC1M-S4-C        | B1.26         |
|                                       | PESS-B-L1     | E5.26          | PHCAT       | B1.113              | PLC1M-S4-C0       | B1.27         |

| Part Number    | Page Number |
|----------------|-------------|
| PLC1M-S4-M30   | B1.27       |
| PLC2H-S25-L    | B1.26       |
| PLC2H-S25-TL0  | B1.27       |
| PLC2H-S25-TL30 | B1.27       |
| PLC2S-S10-C    | B1.26       |
| PLC2S-S10-C0   | B1.27       |
| PLC2S-S10-M30  | B1.27       |
| PLC2S-S6-C     | B1.26       |
| PLC2S-S6-C0    | B1.27       |
| PLC3S-S10-C    | B1.26       |
| PLC3S-S10-C0   | B1.27       |
| PLC4H-S25-L    | B1.26       |
| PLC4H-S25-L0   | B1.27       |
| PLC4H-S25-TL30 | B1.27       |
| PLC4S-S10-C    | B1.26       |
| PLC4S-S10-C0   | B1.27       |
| PLC4S-S10-M30  | B1.27       |
| PLD-11         | E5.30       |
| PLD-12         | E5.28       |
| PLD-17         | E5.30       |
| PLD-18         | E5.30       |
| PLD-22         | E5.30       |
| PLD-28         | E5.30       |
| PLD-29         | E5.30       |
| PLD-3          | E5.30       |
| PLD-30         | E5.28       |
| PLD-36         | E5.28       |
| PLD-37         | E5.28       |
| PLD-38         | E5.28       |
| PLD-4          | E5.30       |
| PLD-43         | E5.28       |
| PLD-45         | E5.28       |
| PLD-46         | E5.28       |
| PLD-47         | E5.28       |
| PLD-52         | E5.28       |
| PLD-56         | E5.28       |
| PLD-57         | E5.28       |
| PLD-58         | E5.28       |
| PLD-60         | E5.28       |
| PLD-67         | E5.28       |
| PLD-68         | E5.28       |
| PLD-7          | E5.30       |
| PLD-71         | E5.28       |
| PLD-72         | E5.28       |
| PLD-74         | E5.28       |
| PLD-77         | E5.30       |
| PLD-78         | E5.30       |
| PLD-80         | E5.28       |
| PLD-81         | E5.28       |
| PLD-91         | E5.28       |
| PLF1M-C        | B1.34       |
| PLF1M-C0       | B1.34       |
| PLF1M-M69      | B1.34       |
| PLF1MA-C       | B1.34       |
| PLF1MA-M0      | B1.34       |
| PLF1MB-C       | B1.34       |
| PLF1MC-M       | B1.34       |
| PLF1M-M69      | B1.34       |
| PLM1M-C        | B1.34       |
| PLM1M-C0       | B1.34       |
| PLM1M-M69      | B1.34       |
| PLM2M-C        | B1.34       |
| PLM2M-M0       | B1.34       |
| PLM2S-C        | B1.34       |
| PLM2S-C0       | B1.34       |
| PLM4S-C        | B1.34       |
| PLM4S-D0       | B1.34       |
| PLMA14Y        | E3.3        |
| PLMA1Y         | E3.3        |
| PLMA2Y         | E3.3        |
| PLMA3Y         | E3.3        |
| PLP1.5I-C      | B1.33       |
| PLP1.5I-M0     | B1.33       |
| PLP1.5I-M30    | B1.33       |
| PLP1.5S-M      | B1.33       |
| PLP1S-M        | B1.33       |
| PLP1S-M0       | B1.33       |

| Part Number       | Page Number  |
|-------------------|--------------|
| PLP1S-M30         | B1.33        |
| PLP2S-C           | B1.33        |
| PLP2S-M0          | B1.33        |
| PLP2S-M30         | B1.33        |
| PLST30SC-D        | B1.81        |
| PLST30SC-D30      | B1.74        |
| PLST4HS25-TL      | B1.81        |
| PLST4HS25-TL300   | B1.74        |
| PLST50SC-D        | B1.81        |
| PLST50SC-D30      | B1.74        |
| PLT.6SM-C         | B1.8         |
| PLT.6SM-C0        | B1.10        |
| PLT.6SM-M30       | B1.12        |
| PLT.7M-C          | B1.8         |
| PLT.7M-M0         | B1.10        |
| PLT.7M-M30        | B1.12        |
| PLT1.5I-C         | B1.8         |
| PLT1.5I-C0        | B1.10        |
| PLT1.5I-C30       | B1.12        |
| PLT1.5I-M100      | B1.17        |
| PLT1.5I-M109      | B1.16        |
| PLT1.5I-M120      | B1.15        |
| PLT1.5I-M300      | B1.13        |
| PLT1.5I-M69       | B1.14        |
| PLT1.5M-C         | B1.8         |
| PLT1.5M-C0        | B1.10        |
| PLT1.5M-C71       | B1.20        |
| PLT1.5M-M30       | B1.12        |
| PLT1.5M-XMR       | B1.121       |
| PLT1.5M-XMR0      | B1.121       |
| PLT1.5M-XMR00     | B1.121       |
| PLT1.5M-XMR30     | B1.121       |
| PLT1.5S-C         | B1.8         |
| PLT1.5S-C0        | B1.10        |
| PLT1.5S-M30       | B1.12        |
| PLT10EH-C         | B1.9         |
| PLT10EH-Q0        | B1.11        |
| PLT10HL-L         | B1.8         |
| PLT12EH-C         | B1.9         |
| PLT12EH-Q0        | B1.11        |
| PLT13H-Q          | B1.8         |
| PLT13H-Q0         | B1.10        |
| PLT1M-C           | B1.8         |
| PLT1M-C0          | B1.10        |
| <b>PLT1M-C186</b> | <b>B1.21</b> |
| PLT1M-C30         | B1.12        |
| PLT1M-C702Y       | B1.18        |
| PLT1M-C71         | B1.20        |
| PLT1M-C76         | B1.19        |
| PLT1M-C86         | B1.21        |
| PLT1M-L0          | B1.82        |
| PLT1M-L1          | B1.82        |
| PLT1M-L1-0        | B1.82        |
| PLT1M-L1-10       | B1.82        |
| PLT1M-L1-2        | B1.82        |
| PLT1M-L1-4        | B1.82        |
| PLT1M-L1-7        | B1.82        |
| PLT1M-L2          | B1.82        |
| PLT1M-L3          | B1.82        |
| PLT1M-L3-0        | B1.82        |
| PLT1M-L3-10       | B1.82        |
| PLT1M-L3-2        | B1.82        |
| PLT1M-L3-4        | B1.82        |
| PLT1M-L3-7        | B1.82        |
| PLT1M-L4Y         | B1.82        |
| PLT1M-L5          | B1.82        |
| PLT1M-L5-0        | B1.82        |
| PLT1M-L5-10       | B1.82        |
| PLT1M-L5-2        | B1.82        |
| PLT1M-L5-4        | B1.82        |
| PLT1M-L5-7        | B1.82        |
| PLT1M-L6          | B1.82        |
| PLT1M-L6-0        | B1.82        |
| PLT1M-L6-10       | B1.82        |
| PLT1M-L6-2        | B1.82        |
| PLT1M-L6-4        | B1.82        |
| PLT1M-L6-7        | B1.82        |

| Part Number       | Page Number  |
|-------------------|--------------|
| PLT1M-L8          | B1.82        |
| PLT1M-L8-0        | B1.82        |
| PLT1M-L8-10       | B1.82        |
| PLT1M-L8-2        | B1.82        |
| PLT1M-L8-4        | B1.82        |
| PLT1M-L8-7        | B1.82        |
| PLT1M-M100        | B1.17        |
| PLT1M-M109        | B1.16        |
| PLT1M-M300        | B1.13        |
| PLT1M-M60         | B1.14        |
| PLT1M-M69         | B1.14        |
| PLT1M-XMR         | B1.121       |
| PLT1M-XMR0        | B1.121       |
| PLT1M-XMR00       | B1.121       |
| PLT1M-XMR1        | B1.121       |
| PLT1M-XMR10       | B1.121       |
| PLT1M-XMR2        | B1.121       |
| PLT1M-XMR3        | B1.121       |
| PLT1M-XMR30       | B1.121       |
| PLT1M-XMR4Y       | B1.121       |
| PLT1M-XMR5        | B1.121       |
| PLT1M-XMR6        | B1.121       |
| PLT1M-XMR7        | B1.121       |
| PLT1M-XMR8        | B1.121       |
| PLT1S-C           | B1.8         |
| PLT1S-C0          | B1.10        |
| PLT1S-M30         | B1.12        |
| PLT1S-M300        | B1.13        |
| PLT2.5H-L         | B1.8         |
| PLT2.5H-L0        | B1.10        |
| PLT2.5I-C         | B1.8         |
| PLT2.5I-C0        | B1.10        |
| PLT2.5S-C         | B1.8         |
| PLT2.5S-C0        | B1.10        |
| PLT2.5S-M30       | B1.12        |
| PLT2EH-C          | B1.9         |
| PLT2EH-Q0         | B1.11        |
| PLT2H-L           | B1.8         |
| PLT2H-L0          | B1.10        |
| PLT2H-TL100       | B1.17        |
| PLT2H-TL109       | B1.16        |
| PLT2H-TL30        | B1.12        |
| PLT2H-TL300       | B1.13        |
| PLT2I-C           | B1.8         |
| PLT2I-C0          | B1.10        |
| <b>PLT2I-C186</b> | <b>B1.21</b> |
| PLT2I-C30         | B1.12        |
| PLT2I-C76         | B1.19        |
| PLT2I-C86         | B1.21        |
| PLT2I-M300        | B1.13        |
| PLT2I-M69         | B1.14        |
| PLT2M-C           | B1.8         |
| PLT2M-C0          | B1.10        |
| PLT2M-M30         | B1.12        |
| PLT2M-M69         | B1.14        |
| PLT2S-C           | B1.8         |
| PLT2S-C0          | B1.10        |
| <b>PLT2S-C186</b> | <b>B1.21</b> |
| PLT2S-C30         | B1.12        |
| PLT2S-C702Y       | B1.18        |
| PLT2S-C71         | B1.20        |
| PLT2S-C76         | B1.19        |
| PLT2S-C86         | B1.21        |
| PLT2S-M100        | B1.17        |
| PLT2S-M109        | B1.16        |
| PLT2S-M120        | B1.15        |
| PLT2S-M300        | B1.13        |
| PLT2S-M39         | B1.12        |
| PLT2S-M60         | B1.14        |
| PLT2S-M69         | B1.14        |
| PLT2S-VMR         | B1.122       |
| PLT2S-VMR0        | B1.122       |
| PLT2S-VMR30       | B1.122       |
| PLT3EH-NB-C0      | B1.11        |
| PLT3H-L           | B1.8         |
| PLT3H-L0          | B1.10        |
| <b>PLT3H-L186</b> | <b>B1.21</b> |

|  |
|--|
| A. System Overview                     |
| B1. Cable Ties                         |
| B2. Cable Accessories                  |
| B3. Stainless Steel Ties               |
| C1. Wiring Duct                        |
| C2. Surface Raceway                    |
| C3. Abrasion Protection                |
| C4. Cable Management                   |
| D1. Terminals                          |
| D2. Power Connectors                   |
| D3. Grounding Connectors               |
| E1. Labeling Systems                   |
| E2. Labels                             |
| E3. Pre-Printed & Write-On Markers     |
| E4. Permanent Identification           |
| E5. Lockout/ Tagout & Safety Solutions |
| F. Index                               |

# PANDUIT® ELECTRICAL SOLUTIONS

| A. System Overview                    | Part Number        | Page Number   | Part Number          | Page Number | Part Number          | Page Number |
|---------------------------------------|--------------------|---------------|----------------------|-------------|----------------------|-------------|
| B1. Cable Ties                        | PLT3H-L76          | B1.19         | PLUP40S-D30          | B1.32       | PMDR-T1 thru PMDR-T3 | E3.10       |
|                                       | PLT3H-L86          | B1.21         | PLUP40SE-D           | B1.32       | PMDR-WHT             | E3.10       |
|                                       | PLT3H-TL100        | B1.17         | PLUP40SE-D30         | B1.32       | PMDR-YEL             | E3.10       |
|                                       | PLT3H-TL109        | B1.16         | PLWP1.5I-C           | B1.28       | PMN1-35R-3K          | D1.116      |
| B2. Cable Accessories                 | PLT3H-TL30         | B1.12         | PLWP1.5I-D30         | B1.29       | PMN1-3F-3K           | D1.119      |
|                                       | PLT3I-C            | B1.8          | PLWP1.5S-D           | B1.28       | PMN1-3R-3K           | D1.116      |
|                                       | PLT3I-C0           | B1.10         | PLWP1.5S-D30         | B1.29       | PMN1-4F-3K           | D1.119      |
|                                       | PLT3I-M30          | B1.12         | PLWP1.5SA-D          | B1.28       | PMN1-4R-3K           | D1.116      |
|                                       | PLT3S-C            | B1.8          | PLWP1M-C             | B1.28       | PMN1-5F-3K           | D1.119      |
|                                       | PLT3S-C0           | B1.10         | PLWP1M-D0            | B1.29       | PMN1-5R-3K           | D1.116      |
| B3. Stainless Steel Ties              | <b>PLT3S-C186</b>  | <b>B1.21</b>  | PLWP1M-D30           | B1.29       | PMN1-6F-3K           | D1.119      |
|                                       | PLT3S-C30          | B1.12         | PLWP1S-C             | B1.28       | PMN1-6R-3K           | D1.116      |
|                                       | PLT3S-C702Y        | B1.18         | PLWP1S-C0            | B1.29       | PMN2-35R-3K          | D1.116      |
|                                       | PLT3S-C76          | B1.19         | PLWP1S-D30           | B1.29       | PMN2-3F-3K           | D1.119      |
|                                       | PLT3S-C86          | B1.21         | PLWP1SA-D            | B1.28       | PMN2-3R-3K           | D1.116      |
|                                       | PLT3S-M100         | B1.17         | PLWP1SB-D            | B1.28       | PMN2-4F-3K           | D1.119      |
| C1. Wiring Duct                       | PLT3S-M109         | B1.16         | PLWP2H-TL            | B1.28       | PMN2-4R-3K           | D1.116      |
|                                       | <b>PLT3S-VMR</b>   | <b>B1.122</b> | PLWP2H-TL0           | B1.29       | PMN2-5F-3K           | D1.119      |
|                                       | <b>PLT3S-VMR30</b> | <b>B1.22</b>  | PLWP2H-TL30          | B1.29       | PMN2-5R-3K           | D1.116      |
|                                       | PLT4.5S-C          | B1.8          | PLWP2S-C             | B1.28       | PMN2-6F-3K           | D1.119      |
| C2. Surface Raceway                   | PLT4.5S-C0         | B1.10         | PLWP2S-C0            | B1.29       | PMN2-6R-3K           | D1.116      |
|                                       | PLT4H-L            | B1.8          | PLWP2S-D30           | B1.29       | PMN6-35R-2K          | D1.116      |
|                                       | PLT4H-L0           | B1.10         | PLWP2SA-D            | B1.28       | PMN6-3R-2K           | D1.116      |
|                                       | <b>PLT4H-L186</b>  | <b>B1.21</b>  | PLWP2SB-D            | B1.28       | PMN6-4F-2K           | D1.119      |
| C3. Abrasion Protection               | PLT4H-L76          | B1.19         | PLWP30SC-D30         | B1.31       | PMN6-4R-2K           | D1.116      |
|                                       | PLT4H-L86          | B1.21         | PLWP3H-TL            | B1.28       | PMN6-5F-2K           | D1.119      |
|                                       | PLT4H-TL100        | B1.17         | PLWP3H-TL0           | B1.29       | PMN6-5R-2K           | D1.116      |
|                                       | PLT4H-TL109        | B1.16         | PLWP40SC-D30         | B1.31       | PMN6-6F-2K           | D1.119      |
|                                       | PLT4H-TL120        | B1.15         | PLWP40SD-D30         | B1.31       | PMN6-6R-2K           | D1.116      |
|                                       | PLT4H-TL30         | B1.12         | PLWP50SC-D30         | B1.31       | PMN6-8R-2K           | D1.116      |
| C4. Cable Management                  | PLT4H-TL300        | B1.13         | PLWP50SE-D30         | B1.31       | PMNF1-35R-3K         | D1.117      |
|                                       | PLT4H-TL69         | B1.14         | PM1-3F-C             | D1.36       | PMNF1-3F-3K          | D1.119      |
|                                       | PLT4I-C            | B1.8          | PM1-3R-C             | D1.34       | PMNF1-3F-C           | D1.35       |
|                                       | PLT4I-C0           | B1.10         | PM1-4F-C             | D1.36       | PMNF1-3R-3K          | D1.117      |
| D1. Terminals                         | PLT4I-M30          | B1.12         | PM1-4R-C             | D1.34       | PMNF1-3R-C           | D1.33       |
|                                       | PLT4S-C            | B1.8          | PM1-5F-C             | D1.36       | PMNF1-4F-3K          | D1.119      |
|                                       | PLT4S-C0           | B1.10         | PM1-5R-C             | D1.34       | PMNF1-4F-C           | D1.35       |
|                                       | <b>PLT4S-C186</b>  | <b>B1.21</b>  | PM1-P10-C            | D1.60       | PMNF1-4R-3K          | D1.117      |
|                                       | PLT4S-C30          | B1.12         | PM2-3F-C             | D1.36       | PMNF1-4R-C           | D1.33       |
|                                       | PLT4S-C76          | B1.19         | PM2-3R-C             | D1.34       | PMNF1-5F-3K          | D1.119      |
| D2. Power Connectors                  | PLT4S-C86          | B1.21         | PM2-4F-C             | D1.36       | PMNF1-5F-C           | D1.35       |
|                                       | PLT4S-M100         | B1.17         | PM2-4R-C             | D1.34       | PMNF1-5R-3K          | D1.117      |
|                                       | PLT4S-M109         | B1.16         | PM2-5F-C             | D1.36       | PMNF1-5R-C           | D1.33       |
|                                       | PLT4S-M120         | B1.15         | PM2-5R-C             | D1.34       | PMNF1-6F-3K          | D1.119      |
|                                       | PLT4S-M300         | B1.13         | PM2-P10-C            | D1.60       | PMNF1-6F-C           | D1.35       |
|                                       | PLT4S-M69          | B1.14         | PM2H25-C             | B2.20       | PMNF1-6R-3K          | D1.117      |
| D3. Grounding Connectors              | PLT5EH-NB-C0       | B1.11         | PM2H25-M0            | B2.20       | PMNF1-6R-C           | D1.33       |
|                                       | PLT5EH-Q           | B1.9          | PM2H25-M30           | B2.20       | PMNF2-35R-3K         | D1.117      |
|                                       | PLT5EH-Q0          | B1.11         | PM6-3R-L             | D1.34       | PMNF2-3F-3K          | D1.119      |
|                                       | PLT5H-C30          | B1.12         | PM6-4R-L             | D1.34       | PMNF2-3F-C           | D1.35       |
|                                       | PLT5H-L            | B1.8          | PM6-5F-L             | D1.36       | PMNF2-3R-3K          | D1.117      |
|                                       | PLT5H-L0           | B1.10         | PM6-5R-L             | D1.34       | PMNF2-3R-C           | D1.33       |
| E1. Labeling Systems                  | PLT5S-C            | B1.8          | PM6-6F-L             | D1.36       | PMNF2-4F-3K          | D1.119      |
|                                       | PLT5S-C0           | B1.10         | PM6-6R-L             | D1.34       | PMNF2-4F-C           | D1.35       |
|                                       | PLT5S-M30          | B1.12         | PM6-8R-L             | D1.34       | PMNF2-4R-3K          | D1.117      |
|                                       | PLT6EH-NB-C0       | B1.11         | PM6-P10-L            | D1.60       | PMNF2-4R-C           | D1.33       |
|                                       | PLT6EH-Q           | B1.11         | PMCC38H25-C          | B2.31       | PMNF2-5F-3K          | D1.119      |
|                                       | PLT6H-C30          | B1.12         | PMCC38H25-M0         | B2.31       | PMNF2-5F-C           | D1.35       |
| E2. Labels                            | PLT6H-L            | B1.8          | PMD                  | E3.9        | PMNF2-5R-3K          | D1.117      |
|                                       | PLT6H-L0           | B1.10         | PMD-0-9              | E3.9        | PMNF2-5R-C           | D1.33       |
|                                       | PLT6LH-L           | B1.8          | PMD-NEMA             | E3.9        | PMNF2-6F-3K          | D1.119      |
|                                       | PLT6LH-L0          | B1.10         | PMDR-0 thru PMDR-9   | E3.10       | PMNF2-6F-C           | D1.35       |
|                                       | PLT7LH-C30         | B1.12         | PMDR-90 thru PMDR-99 | E3.10       | PMNF2-6R-3K          | D1.117      |
|                                       | PLT7LH-L           | B1.8          | PMDR-A thru PMDR-Z   | E3.10       | PMNF2-6R-L           | D1.33       |
| E3. Pre-Printed & Write-On Markers    | PLT7LH-L0          | B1.10         | PMDR-BL              | E3.10       | PMNF6-35R-2K         | D1.117      |
|                                       | PLT8EH-C           | B1.9          | PMDR-BLK             | E3.10       | PMNF6-3R-2K          | D1.117      |
|                                       | PLT8EH-Q0          | B1.11         | PMDR-BRN             | E3.10       | PMNF6-3R-L           | D1.33       |
|                                       | PLT8H-C30          | B1.12         | PMDR-GRN             | E3.10       | PMNF6-4F-2K          | D1.119      |
|                                       | PLT8H-L            | B1.8          | PMDR-GRS             | E3.10       | PMNF6-4F-L           | D1.35       |
|                                       | PLT8H-L0           | B1.10         | PMDR-GRY             | E3.10       | PMNF6-4R-2K          | D1.117      |
| E4. Permanent Identification          | PLT8LH-C120        | B1.15         | PMDR-L1 thru PMDR-L3 | E3.10       | PMNF6-4R-L           | D1.33       |
|                                       | PLT8LH-L           | B1.8          | PMDR-MIN             | E3.10       | PMNF6-5F-2K          | D1.119      |
|                                       | PLT8LH-L0          | B1.10         | PMDR-NEMA            | E3.10       | PMNF6-5F-L           | D1.35       |
|                                       | PLT9LH-C30         | B1.12         | PMDR-ORN             | E3.10       | PMNF6-5R-2K          | D1.117      |
|                                       | PLT9LH-L           | B1.8          | PMDR-PLS             | E3.10       | PMNF6-5R-L           | D1.33       |
|                                       | PLT9LH-L0          | B1.10         | PMDR-PUR             | E3.10       | PMNF6-6F-2K          | D1.119      |
| E5. Lockout/Tagout & Safety Solutions |                    |               | PMDR-RED             | E3.10       | PMNF6-6F-L           | D1.35       |
|                                       |                    |               |                      |             |                      |             |
| F. Index                              |                    |               |                      |             |                      |             |



| Part Number   | Page Number |
|---------------|-------------|
| PMNF6-6R-2K   | D1.117      |
| PMNF6-6R-L    | D1.33       |
| PMNF6-8R-2K   | D1.117      |
| PMNF6-8R-L    | D1.33       |
| PMR40BC       | C2.5        |
| PMR40BFWH     | C2.6        |
| PMR40BWH10    | C2.5        |
| PMR40CWH13.75 | C2.5        |
| PMR40CWH19.75 | C2.5        |
| PMR40CWH31.75 | C2.5        |
| PMR40CWH5     | C2.5        |
| PMR40CWH7.75  | C2.5        |
| PMR40DB50     | C2.6        |
| PMR40DC-X     | C2.5        |
| PMR40DP50WH   | C2.6        |
| PMR40DW5      | C2.5        |
| PMR40E45EWH   | C2.6        |
| PMR40ECWH     | C2.6        |
| PMR40EEWH     | C2.6        |
| PMR40FH2WH    | C2.6        |
| PMR40FH4WH    | C2.6        |
| PMR40I45EWH   | C2.6        |
| PMR40ICC      | C2.6        |
| PMR40ICWH     | C2.6        |
| PMR40KH2WH    | C2.6        |
| PMR40KH4WH    | C2.6        |
| PMR40OCWH     | C2.6        |
| PMR40PCWH     | C2.6        |
| PMR40RAWH     | C2.5        |
| PMR40SCWH-X   | C2.5        |
| PMR40SIC      | C2.5        |
| PMR40SOCWH    | C2.6        |
| PMR40TD50     | C2.6        |
| PMR40TRWH     | C2.6        |
| PMR40TWH      | C2.6        |
| PMR40WR-X     | C2.6        |
| PMR5736WH     | C2.16       |
| PMR5737AWH    | C2.16       |
| PMR5737WH     | C2.16       |
| PMR5738AWH    | C2.16       |
| PMR5738WH     | C2.16       |
| PMR5739AWH    | C2.16       |
| PMR5739WH     | C2.16       |
| PMR5744-2WH   | C2.16       |
| PMR5744-3WH   | C2.16       |
| PMR5744S-2WH  | C2.15       |
| PMR5744S-3WH  | C2.16       |
| PMR5744SWH    | C2.15       |
| PMR5744WH     | C2.16       |
| PMR5747-2WH   | C2.15       |
| PMR5747-3WH   | C2.15       |
| PMR5747WH     | C2.15       |
| PMR5748-2WH   | C2.15       |
| PMR5748-3WH   | C2.15       |
| PMR5748WH     | C2.15       |
| PMR5751-2WH   | C2.15       |
| PMR5751-3WH   | C2.15       |
| PMR5751WH     | C2.15       |
| PMR5752RD     | C2.16       |
| PMR5753RD     | C2.16       |
| PMR5760WH     | C2.15       |
| PMR57AOCWH    | C2.12       |
| PMR57CBWH     | C2.12       |
| PMR57CC50-X   | C2.12       |
| PMR57CC75-X   | C2.12       |
| PMR57EBCWH    | C2.12       |
| PMR57ECCWH    | C2.12       |
| PMR57EEWH     | C2.12       |
| PMR57GC-X     | C2.11       |
| PMR57JBC50-X  | C2.12       |
| PMR57JBC75-X  | C2.12       |
| PMR57JC-X     | C2.11       |
| PMR57LTEWH    | C2.12       |
| PMR57MRT      | C2.13       |
| PMR57RTEWH    | C2.12       |
| PMR57SC-X     | C2.11       |
| PMR57TWH      | C2.12       |

| Part Number  | Page Number |
|--------------|-------------|
| PMR5CCWH-X   | C2.12       |
| PMR5DAWH     | C2.12       |
| PMR5ICWH     | C2.12       |
| PMR5MSWH-X   | C2.11       |
| PMR5OCWH     | C2.12       |
| PMR5RAWH     | C2.12       |
| PMR5TRWH     | C2.12       |
| PMR5WH10     | C2.11       |
| PMR5WH5      | C2.11       |
| PMR5WPB-X    | C2.11       |
| PMR7CCWH-X   | C2.12       |
| PMR7DAWH     | C2.12       |
| PMR7ICWH     | C2.12       |
| PMR7MSWH-X   | C2.11       |
| PMR7OCWH     | C2.12       |
| PMR7RAWH     | C2.12       |
| PMR7TRWH     | C2.12       |
| PMR7WH10     | C2.11       |
| PMR7WH5      | C2.11       |
| PMR7WPB-X    | C2.11       |
| PMRTUPAL     | C2.13       |
| PMRTUPWH     | C2.13       |
| PMV1-35RB-3K | D1.118      |
| PMV1-3FB-3K  | D1.120      |
| PMV1-3FB-CY  | D1.35       |
| PMV1-3RB-3K  | D1.118      |
| PMV1-3RB-CY  | D1.34       |
| PMV1-4FB-3K  | D1.120      |
| PMV1-4FB-CY  | D1.35       |
| PMV1-4RB-3K  | D1.118      |
| PMV1-4RB-CY  | D1.34       |
| PMV1-5FB-3K  | D1.120      |
| PMV1-5FB-CY  | D1.35       |
| PMV1-5RB-3K  | D1.118      |
| PMV1-5RB-CY  | D1.34       |
| PMV1-6FB-3K  | D1.120      |
| PMV1-6FB-CY  | D1.35       |
| PMV1-6RB-3K  | D1.118      |
| PMV1-6RB-CY  | D1.34       |
| PMV1-P10-CY  | D1.60       |
| PMV1-P12B-3K | D1.138      |
| PMV2-35RB-3K | D1.118      |
| PMV2-3FB-3K  | D1.120      |
| PMV2-3FB-C   | D1.35       |
| PMV2-3RB-3K  | D1.118      |
| PMV2-3RB-C   | D1.34       |
| PMV2-4FB-3K  | D1.120      |
| PMV2-4FB-C   | D1.35       |
| PMV2-4RB-3K  | D1.118      |
| PMV2-4RB-C   | D1.34       |
| PMV2-5FB-3K  | D1.120      |
| PMV2-5FB-C   | D1.35       |
| PMV2-5RB-3K  | D1.118      |
| PMV2-5RB-C   | D1.34       |
| PMV2-6FB-3K  | D1.120      |
| PMV2-6FB-C   | D1.35       |
| PMV2-6RB-3K  | D1.118      |
| PMV2-6RB-C   | D1.34       |
| PMV2-P10-C   | D1.60       |
| PMV2-P12B-3K | D1.138      |
| PMV6-35RB-2K | D1.118      |
| PMV6-3R-L    | D1.34       |
| PMV6-3RB-2K  | D1.118      |
| PMV6-4F-L    | D1.35       |
| PMV6-4FB-2K  | D1.120      |
| PMV6-4R-L    | D1.34       |
| PMV6-4RB-2K  | D1.118      |
| PMV6-5F-L    | D1.35       |
| PMV6-5FB-2K  | D1.120      |
| PMV6-5R-L    | D1.34       |
| PMV6-5RB-2K  | D1.118      |
| PMV6-6F-L    | D1.35       |
| PMV6-6FB-2K  | D1.120      |
| PMV6-6R-L    | D1.34       |
| PMV6-6RB-2K  | D1.118      |
| PMV6-8R-L    | D1.34       |
| PMV6-8RB-2K  | D1.118      |

| Part Number   | Page Number |
|---------------|-------------|
| PMV6-P10-L    | D1.60       |
| PN10-10F-2K   | D1.107      |
| PN10-10F-L    | D1.22       |
| PN10-10FF-2K  | D1.113      |
| PN10-10FF-L   | D1.28       |
| PN10-10LF-2K  | D1.110      |
| PN10-10LF-L   | D1.24       |
| PN10-10R-2K   | D1.103      |
| PN10-10R-L    | D1.6        |
| PN10-10RX-L   | D1.8        |
| PN10-10SLF-2K | D1.112      |
| PN10-10SLF-L  | D1.26       |
| PN10-12R-Q    | D1.6        |
| PN10-14F-2K   | D1.107      |
| PN10-14F-L    | D1.22       |
| PN10-14LF-L   | D1.24       |
| PN10-14R-2K   | D1.103      |
| PN10-14R-L    | D1.6        |
| PN10-14RX-L   | D1.8        |
| PN10-14SLF-L  | D1.26       |
| PN10-38R-2K   | D1.103      |
| PN10-38R-L    | D1.6        |
| PN10-38RX-L   | D1.8        |
| PN10-56R-2K   | D1.103      |
| PN10-56R-L    | D1.6        |
| PN10-56RX-L   | D1.8        |
| PN10-5SLF-L   | D1.26       |
| PN10-610R-L   | D1.8        |
| PN10-6F-2K    | D1.107      |
| PN10-6F-L     | D1.22       |
| PN10-6LF-2K   | D1.110      |
| PN10-6LF-L    | D1.24       |
| PN10-6R-2K    | D1.103      |
| PN10-6R-L     | D1.6        |
| PN10-6RX-L    | D1.8        |
| PN10-6SLF-L   | D1.26       |
| PN10-8F-2K    | D1.107      |
| PN10-8F-L     | D1.22       |
| PN10-8FF-2K   | D1.113      |
| PN10-8FF-L    | D1.28       |
| PN10-8LF-2K   | D1.110      |
| PN10-8LF-L    | D1.24       |
| PN10-8R-2K    | D1.103      |
| PN10-8R-L     | D1.6        |
| PN10-8RX-L    | D1.8        |
| PN10-8SLF-2K  | D1.112      |
| PN10-8SLF-L   | D1.26       |
| PN12-10HDR-2K | D1.106      |
| PN12-10HDR-L  | D1.13       |
| PN12-14HDR-2K | D1.106      |
| PN12-14HDR-L  | D1.13       |
| PN12-38HDR-2K | D1.106      |
| PN12-38HDR-L  | D1.13       |
| PN12-56HDR-2K | D1.106      |
| PN12-56HDR-L  | D1.13       |
| PN12-6HDR-2K  | D1.106      |
| PN12-8HDR-2K  | D1.106      |
| PN12-8HDR-L   | D1.13       |
| PN14-10F-3K   | D1.107      |
| PN14-10F-C    | D1.22       |
| PN14-10FF-3K  | D1.113      |
| PN14-10FF-C   | D1.28       |
| PN14-10FN-3K  | D1.107      |
| PN14-10FN-C   | D1.22       |
| PN14-10LF-3K  | D1.110      |
| PN14-10LF-C   | D1.24       |
| PN14-10LFN-C  | D1.24       |
| PN14-10R-3K   | D1.103      |
| PN14-10R-C    | D1.6        |
| PN14-10RX-C   | D1.8        |
| PN14-10SLF-3K | D1.112      |
| PN14-10SLF-C  | D1.26       |
| PN14-12R-Q    | D1.6        |
| PN14-14F-3K   | D1.107      |
| PN14-14F-C    | D1.22       |
| PN14-14R-3K   | D1.103      |
| PN14-14R-C    | D1.6        |

| A. System Overview                     |
|--|
| B1. Cable Ties                         |
| B2. Cable Accessories                  |
| B3. Stainless Steel Ties               |
| C1. Wiring Duct                        |
| C2. Surface Raceway                    |
| C3. Abrasion Protection                |
| C4. Cable Management                   |
| D1. Terminals                          |
| D2. Power Connectors                   |
| D3. Grounding Connectors               |
| E1. Labeling Systems                   |
| E2. Labels                             |
| E3. Pre-Printed & Write-On Markers     |
| E4. Permanent Identification           |
| E5. Lockout/ Tagout & Safety Solutions |
| F. Index                               |





| Part Number                | Page Number         |
|----------------------------|---------------------|
| PP2S-S12-X                 | B2.23               |
| PP5X50F                    | B1.83               |
| PPC25X50                   | B1.83               |
| PPC25X50F                  | B1.83               |
| PPF2S-S25-V                | B2.24, C4.14        |
| PPF2S-S25-V69              | B2.24, C4.14        |
| PPF2SV-S25-V               | B2.24, C4.14        |
| PPF2SV-S25-V69             | B2.24, C4.14        |
| PPH10                      | B1.113, B3.16       |
| PPM-0 thru PPM-25          | E3.8                |
| PPM-1-33                   | E3.8                |
| PPM-A thru PPM-C           | E3.8                |
| PPMV1-4RB-3K               | D1.118              |
| PPS0202B493                | E5.19               |
| PPS0305C174                | E5.19, E5.24        |
| PPS0305D73                 | E5.24               |
| PPS0305D75                 | E5.24               |
| <b>PPS0305W2200</b>        | <b>E5.23</b>        |
| <b>PPS0507W2200</b>        | <b>E5.23</b>        |
| PPS0514B363                | E5.24               |
| PPS0710B364                | E5.19, E5.24        |
| PPS0710BWHT                | E5.39               |
| PPS0710BYEL                | E5.39               |
| PPS0710C141                | E5.24               |
| PPS0710C442                | E5.39               |
| PPS0710D101                | E5.24               |
| PPS0710D24                 | E5.24               |
| PPS0710D28                 | E5.24               |
| PPS0710D440                | E5.19               |
| PPS0710D66                 | E5.24               |
| PPS0710D70                 | E5.24               |
| PPS0710D72                 | E5.19, E5.24        |
| PPS0710D73                 | E5.24               |
| PPS0710D75                 | E5.24               |
| PPS0710D77                 | E5.24               |
| <b>PPS0710G001</b>         | <b>E5.25</b>        |
| <b>PPS0710G020</b>         | <b>E5.25</b>        |
| PPS0710N203                | E5.24               |
| PPS0710N443                | E5.39               |
| PPS1007D72SE               | E5.24               |
| PPS1014BWHT                | E5.39               |
| PPS1014BYEL                | E5.39               |
| PPS1014C442                | E5.39               |
| PPS1014D440                | E5.39               |
| PPS1014D73                 | E5.34               |
| <b>PPS1014G002</b>         | <b>E5.23, E5.25</b> |
| PPS1014N443                | E5.39               |
| <b>PPS1209G010</b>         | <b>E5.23, E5.25</b> |
| <b>PPS1209G011</b>         | <b>E5.23, E5.25</b> |
| <b>PPS1209G012</b>         | <b>E5.23, E5.25</b> |
| PPS1420BWHT                | E5.39               |
| PPS1420BYEL                | E5.39               |
| PPS1420C442                | E5.39               |
| PPS1420D440                | E5.39               |
| PPS1420N443                | E5.39               |
| PPTMT                      | B3.16               |
| PRA2S-A-Q                  | B2.8                |
| PRL100BY-0 thru PRL100BY-9 | E5.38               |
| PRL100BY-18KIT             | E5.38               |
| PRL100BY-36KIT             | E5.38               |
| PRL100BY-A thru PRL100BY-Z | E5.38               |
| PRL100BY-BLNK              | E5.38               |
| PRL100BY-DSH               | E5.38               |
| PRL150YB-0 thru PRL150YB-9 | E5.38               |
| PRL150YB-A thru PRL150YB-Z | E5.38               |
| PRL150YB-DSH               | E5.38               |
| PRL250YB-0 thru PRL250YB-9 | E5.38               |
| PRL250YB-A thru PRL250YB-Z | E5.38               |
| PRL250YB-DSH               | E5.38               |
| PRLWLP30S-D30              | B1.32               |
| PRLWLP50S-D30              | B1.32               |
| PROG-CCCD                  | E1.16               |
| PROG-EM2GO                 | E1.16               |
| PROG-EMCD3                 | E1.16               |
| PRS0710B364                | E5.19, E5.24        |
| PRS0710BWHT                | E5.39               |
| PRS0710BYEL                | E5.39               |

| Part Number     | Page Number  |
|-----------------|--------------|
| PRS0710C442     | E5.39        |
| PRS0710D440     | E5.39        |
| PRS0710D68      | E5.24        |
| PRS0710D72      | E5.19, E5.24 |
| PRS0710N443     | E5.39        |
| PRS0910D453     | E5.24        |
| PRS1014B364     | E5.19, E5.24 |
| PRS1014BWHT     | E5.39        |
| PRS1014BYEL     | E5.39        |
| PRS1014C442     | E5.39        |
| PRS1014D440     | E5.39        |
| PRS1014D70      | E5.24        |
| PRS1014D71      | E5.24        |
| PRS1014D72      | E5.19, E5.24 |
| PRS1014D73      | E5.24        |
| PRS1014D79      | E5.24        |
| PRS1014N443     | E5.39        |
| PRS1420BWHT     | E5.39        |
| PRS1420BYEL     | E5.39        |
| PRS1420C442     | E5.39        |
| PRS1420D440     | E5.39        |
| PRS1420D75      | E5.24        |
| PRS1420N443     | E5.39        |
| PRST30S-S14-M30 | B1.75        |
| PRST40SC-D30    | B1.74        |
| PRT1.5S-C       | B1.22        |
| PRT1.5S-C0      | B1.23        |
| PRT1.5S-M30     | B1.23        |
| PRT10EH-C       | B1.22        |
| PRT10EH-Q0      | B1.24        |
| PRT12EH-C       | B1.22        |
| PRT12EH-Q0      | B1.24        |
| PRT1S-C         | B1.22        |
| PRT1S-C0        | B1.23        |
| PRT2EH-C        | B1.22        |
| PRT2EH-C100     | B1.25        |
| PRT2EH-Q0       | B1.24        |
| PRT2H-L         | B1.22        |
| PRT2H-L0        | B1.23        |
| PRT2S-C         | B1.22        |
| PRT2S-C0        | B1.23        |
| PRT3H-L         | B1.22        |
| PRT3H-L0        | B1.23        |
| PRT3S-C         | B1.22        |
| PRT3S-C0        | B1.23        |
| PRT4H-L         | B1.22        |
| PRT4H-L0        | B1.23        |
| PRT4S-C         | B1.22        |
| PRT4S-C0        | B1.23        |
| PRT5EH-C100     | B1.25        |
| PRT5EH-C30      | B1.24        |
| PRT5EH-Q        | B1.22        |
| PRT5EH-Q0       | B1.24        |
| PRT6EH-C100     | B1.25        |
| PRT6EH-Q        | B1.22        |
| PRT6EH-Q0       | B1.24        |
| PRT8EH-C        | B1.22        |
| PRT8EH-C100     | B1.25        |
| PRT8EH-Q0       | B1.24        |
| PRWP1.5S-D      | B1.30        |
| PRWP1.5S-D0     | B1.30        |
| PRWP1.5S-D30    | B1.30        |
| PRWP1S-C        | B1.30        |
| PRWP1S-D0       | B1.30        |
| PRWP1SA-D       | B1.30        |
| PRWP1SB-D       | B1.30        |
| PRWP2H-TL       | B1.30        |
| PRWP2S-D        | B1.30        |
| PRWP2S-D0       | B1.30        |
| PS12-L          | D1.67        |
| PS16-C          | D1.67        |
| PS18-C          | D1.67        |
| PSCBLK-Q        | D2.64        |
| PSCBLU-L        | D2.64        |
| PSCBRN-L        | D2.64        |
| PSCB-12Y        | E3.3         |
| PSCB-13Y        | E3.3         |

| Part Number | Page Number |
|-------------|-------------|
| PSCB-16Y    | E3.3        |
| PSCB-3Y     | E3.3        |
| PSCB-3YELY  | E3.3        |
| PSCB-5Y     | E3.3        |
| PSCB-6Y     | E3.3        |
| PSCC-3Y     | E3.9        |
| PSCC-5Y     | E3.9        |
| PSCGRN-L    | D2.64       |
| PSCGRY-L    | D2.64       |
| PSCORG-Q    | D2.64       |
| PSCPKN-L    | D2.64       |
| PSCPUR-Q    | D2.64       |
| PSCRED-L    | D2.64       |
| PSCYEL-Q    | D2.64       |
| PSJBXIW     | C2.58       |
| PSL-1       | E5.11       |
| PSL-1.5     | E5.11       |
| PSL-1.5A    | E5.11       |
| PSL-10SA    | E5.8        |
| PSL-10SWCA  | E5.8        |
| PSL-1A      | E5.11       |
| PSL-20SA    | E5.8        |
| PSL-20SWCA  | E5.8        |
| PSL-4SA     | E5.8        |
| PSL-4SWCA   | E5.8        |
| PSL-6       | E5.11       |
| PSL-6BL     | E5.11       |
| PSL-6BL-LS  | E5.11       |
| PSL-6BU     | E5.11       |
| PSL-6BU-LS  | E5.11       |
| PSL-6GR     | E5.11       |
| PSL-6GR-LS  | E5.11       |
| PSL-6-L     | E5.11       |
| PSL-6WH     | E5.11       |
| PSL-6WH-LS  | E5.11       |
| PSL-6YL     | E5.11       |
| PSL-6YL-LS  | E5.11       |
| PSL-7       | E5.10       |
| PSL-7BL     | E5.10       |
| PSL-7BL-LS  | E5.10       |
| PSL-7BR     | E5.10       |
| PSL-7BR-LS  | E5.10       |
| PSL-7BU     | E5.10       |
| PSL-7BU-LS  | E5.10       |
| PSL-7GR     | E5.10       |
| PSL-7GR-LS  | E5.10       |
| PSL-7-L     | E5.10       |
| PSL-7OR     | E5.10       |
| PSL-7OR-LS  | E5.10       |
| PSL-7PU     | E5.10       |
| PSL-7PU-LS  | E5.10       |
| PSL-7YL     | E5.10       |
| PSL-7YL-LS  | E5.10       |
| PSL-8       | E5.10       |
| PSL-8BL     | E5.10       |
| PSL-8BR     | E5.10       |
| PSL-8BU     | E5.10       |
| PSL-8GR     | E5.10       |
| PSL-8-LABEL | E5.10       |
| PSL-8OR     | E5.10       |
| PSL-8PU     | E5.10       |
| PSL-8YL     | E5.10       |
| PSL-BFV     | E5.6        |
| PSL-BV1     | E5.6        |
| PSL-BV2     | E5.6        |
| PSL-BV3     | E5.6        |
| PSL-BX      | E5.8        |
| PSL-CB      | E5.3        |
| PSL-CB-3PC  | E5.3        |
| PSL-CBIL    | E5.3        |
| PSL-CBILNT  | E5.3        |
| PSL-CBKIT   | E5.3        |
| PSL-CBL     | E5.3        |
| PSL-CBNT    | E5.3        |
| PSL-CBWL    | E5.9        |
| PSL-CL110   | E5.4        |
| PSL-CL480   | E5.4        |

|  |
|--|
| A. System Overview                     |
| B1. Cable Ties                         |
| B2. Cable Accessories                  |
| B3. Stainless Steel Ties               |
| C1. Wiring Duct                        |
| C2. Surface Raceway                    |
| C3. Abrasion Protection                |
| C4. Cable Management                   |
| D1. Terminals                          |
| D2. Power Connectors                   |
| D3. Grounding Connectors               |
| E1. Labeling Systems                   |
| E2. Labels                             |
| E3. Pre-Printed & Write-On Markers     |
| E4. Permanent Identification           |
| E5. Lockout/ Tagout & Safety Solutions |
| F. Index                               |

| A. System Overview                    | Part Number    | Page Number | Part Number          | Page Number  | Part Number    | Page Number |
|---------------------------------------|----------------|-------------|----------------------|--------------|----------------|-------------|
| B1. Cable Ties                        | PSL-DCJB       | E5.20       | PSL-TG1              | E5.13        | PV10-14LF-L    | D1.25       |
|                                       | PSL-DCJB-BL    | E5.20       | PSL-V13              | E5.5         | PV10-14LFB-2K  | D1.111      |
|                                       | PSL-DCJB-BU    | E5.20       | PSL-V2A              | E5.5         | PV10-14LFX-L   | D1.26       |
|                                       | PSL-DCJB-GR    | E5.20       | PSL-V6A              | E5.5         | PV10-14R-L     | D1.9        |
|                                       | PSL-DCJB-IG    | E5.20       | PSL-V9               | E5.5         | PV10-14RB-2K   | D1.105      |
| B2. Cable Accessories                 | PSL-DCJB-IW    | E5.20       | PSL-WS               | E5.5         | PV10-14RX-L    | D1.10       |
|                                       | PSL-DCJB-OR    | E5.20       | PSL-WS1A             | E5.5         | PV10-14SLF-L   | D1.27       |
|                                       | PSL-DCJB-YL    | E5.20       | PSM-0-9-Y            | E3.7         | PV10-38R-L     | D1.9        |
|                                       | PSL-DCPLRX     | E5.21       | PSM-0-Y thru PSM-52Y | E3.7         | PV10-38RB-2K   | D1.105      |
|                                       | PSL-DCPLRX-BL  | E5.21       | PSM-1-33-Y           | E3.7         | PV10-38RX-L    | D1.10       |
| B3. Stainless Steel Ties              | PSL-DCPLRX-BU  | E5.21       | PSM-34-66-Y          | E3.7         | PV10-56R-L     | D1.9        |
|                                       | PSL-DCPLRX-GR  | E5.21       | PSM-67-99-Y          | E3.7         | PV10-56RB-2K   | D1.105      |
|                                       | PSL-DCPLRX-IG  | E5.21       | PSM-A-Y thru PSM-Z-Y | E3.7         | PV10-56RX-L    | D1.10       |
|                                       | PSL-DCPLRX-IW  | E5.21       | PSM-A-Z-Y            | E3.7         | PV10-5SLF-L    | D1.27       |
|                                       | PSL-DCPLRX-OR  | E5.21       | PSN12-L              | D1.66        | PV10-610R-L    | D1.11       |
| C1. Wiring Duct                       | PSL-DCPLRX-YL  | E5.21       | PSN16-C              | D1.66        | PV10-610RB-2K  | D1.105      |
|                                       | PSL-DCPLRX     | E5.21       | PSN18-C              | D1.66        | PV10-6F-L      | D1.23       |
|                                       | PSL-DCPLX-BL   | E5.21       | PSSB-13              | E5.33        | PV10-6FB-2K    | D1.109      |
|                                       | PSL-DCPLX-BU   | E5.21       | PST-12               | E5.18        | PV10-6LF-L     | D1.25       |
|                                       | PSL-DCPLX-GR   | E5.21       | PST-3                | E5.18        | PV10-6LFB-2K   | D1.111      |
| C2. Surface Raceway                   | PSL-DCPLX-IG   | E5.21       | PST-FO               | E5.42        | PV10-6LFX-L    | D1.26       |
|                                       | PSL-DCPLX-IW   | E5.21       | PST-FOBLNK           | E5.42        | PV10-6R-L      | D1.9        |
|                                       | PSL-DCPLX-OR   | E5.21       | PSWM-1500Y           | E3.9         | PV10-6RB-2K    | D1.105      |
|                                       | PSL-DCPLX-YL   | E5.21       | PSWM-375Y            | E3.9         | PV10-6RX-L     | D1.10       |
|                                       | PSL-ERB        | E5.4        | PSWM-750Y            | E3.9         | PV10-6SLF-L    | D1.27       |
| C3. Abrasion Protection               | PSL-GLBN       | E5.8        | PSWMH-375Y           | E3.9         | PV10-6SLFB-2K  | D1.113      |
|                                       | PSL-HD1        | E5.11       | PSWMH-750Y           | E3.9         | PV10-8F-L      | D1.23       |
|                                       | PSL-HD2.4      | E5.11       | PT10-10R-L           | D1.12        | PV10-8FB-2K    | D1.109      |
|                                       | PSL-HD3        | E5.11       | PT10-14R-L           | D1.12        | PV10-8FF-L     | D1.28       |
|                                       | PSL-KT         | E5.8        | PT10-6R-L            | D1.12        | PV10-8FFB-2K   | D1.114      |
| C4. Cable Management                  | PSL-KT-CONA    | E5.7        | PT10-8R-L            | D1.12        | PV10-8FX-L     | D1.24       |
|                                       | PSL-KT-MROA    | E5.7        | PT14-10R-C           | D1.12        | PV10-8LF-L     | D1.25       |
|                                       | PSL-KT-PWR     | E5.7        | PT14-14R-C           | D1.12        | PV10-8LFB-2K   | D1.111      |
|                                       | PSL-LCAB       | E5.22       | PT14-4R-C            | D1.12        | PV10-8LFX-L    | D1.26       |
|                                       | PSL-LCAB-AQ    | E5.22       | PT14-6R-C            | D1.12        | PV10-8R-L      | D1.9        |
| D1. Terminals                         | PSL-LCAB-BL    | E5.22       | PT14-8R-C            | D1.12        | PV10-8RB-2K    | D1.105      |
|                                       | PSL-LCAB-BU    | E5.22       | PT18-10R-C           | D1.12        | PV10-8RX-L     | D1.10       |
|                                       | PSL-LCAB-EI    | E5.22       | PT18-4R-C            | D1.12        | PV10-8SLF-L    | D1.27       |
|                                       | PSL-LCM        | E5.2        | PT18-6R-C            | D1.12        | PV10-8SLFB-2K  | D1.113      |
|                                       | PSL-LOTO-TRAIN | E5.2        | PT18-8R-C            | D1.12        | PV10-P55-L     | D1.54       |
| D2. Power Connectors                  | PSL-LTM        | E5.2        | PT2S-ARW             | E5.34        | PV12-10HDR-L   | D1.14       |
|                                       | PSL-LTMGP      | E5.2        | PT2S-BLK             | E5.34        | PV12-10HDRB-2K | D1.106      |
|                                       | PSL-LTMS       | E5.2        | PT2S-RED             | E5.34        | PV12-10HDRX-L  | D1.14       |
|                                       | PSL-LTP        | E5.2        | PT-BGND              | E5.42        | PV12-14HDR-L   | D1.14       |
|                                       | PSL-LTPGP      | E5.2        | PT-GND               | E5.42        | PV12-14HDRB-2K | D1.106      |
| D3. Grounding Connectors              | PSL-LTPS       | E5.2        | PT-TGND              | E5.42        | PV12-14HDRX-L  | D1.14       |
|                                       | PSL-LTV        | E5.2        | <b>PTB-GP</b>        | <b>D3.55</b> | PV12-38HDR-L   | D1.14       |
|                                       | PSL-LTV-DVD    | E5.2        | <b>PTB-HO</b>        | <b>D3.40</b> | PV12-38HDRB-2K | D1.106      |
|                                       | PSL-MLD        | E5.6, E5.11 | PTH                  | B1.113       | PV12-38HDRX-L  | D1.14       |
|                                       | PSL-MLDC       | E5.6        | PTR-CLN              | E1.13        | PV12-56HDR-L   | D1.14       |
| E1. Labeling Systems                  | PSL-MLDC200    | E5.6        | PTS                  | B1.113       | PV12-56HDRB-2K | D1.106      |
|                                       | PSL-MLD-CRIMP  | E5.6        | PT-TGND              | E5.42        | PV12-56HDRX-L  | D1.14       |
|                                       | PSL-MLDCT      | E5.6        | PUM-049-2S-D30       | B2.22        | PV12-6HDR-L    | D1.14       |
|                                       | PSL-MLDH-X     | E5.6, E5.11 | PUM-049-M30          | B2.22        | PV12-6HDRB-2K  | D1.106      |
|                                       | PSL-MLD-TOOL   | E5.6        | PUM-071-2S-D30       | B2.22        | PV12-6HDRX-L   | D1.14       |
| E2. Labels                            | PSL-P          | E5.4        | PUM-071-M30          | B2.22        | PV12-8HDR-L    | D1.14       |
|                                       | PSL-PC         | E5.13       | PUM-100-2S-D30       | B2.22        | PV12-8HDRB-2K  | D1.106      |
|                                       | PSL-PE1        | E5.13       | PUM-100-M30          | B2.22        | PV12-8HDRX-L   | D1.14       |
|                                       | PSL-PE2        | E5.13       | PUM-925-3H-T30       | B2.22        | PV14-10F-C     | D1.23       |
|                                       | PSL-PEL        | E5.6        | PUM-925-M30          | B2.22        | PV14-10FB-3K   | D1.109      |
| E3. Pre-Printed & Write-On Markers    | PSL-PI         | E5.4        | PV10-10F-L           | D1.23        | PV14-10FF-C    | D1.28       |
|                                       | PSL-PK         | E5.8        | PV10-10FB-2K         | D1.109       | PV14-10FFB-3K  | D1.114      |
|                                       | PSL-PK-EA      | E5.7        | PV10-10FF-L          | D1.28        | PV14-10FN-C    | D1.23       |
|                                       | PSL-PL1BLKY    | E5.12       | PV10-10FFB-2K        | D1.114       | PV14-10FNB-3K  | D1.109      |
|                                       | PSL-PL1BLUY    | E5.12       | PV10-10FX-L          | D1.24        | PV14-10FX-C    | D1.24       |
| E4. Permanent Identification          | PSL-PL1GRNY    | E5.12       | PV10-10LF-L          | D1.25        | PV14-10LF-C    | D1.25       |
|                                       | PSL-PL1REDY    | E5.12       | PV10-10LFB-2K        | D1.111       | PV14-10LFB-3K  | D1.111      |
|                                       | PSL-PL1WHY     | E5.12       | PV10-10LFX-L         | D1.26        | PV14-10LFN-C   | D1.25       |
|                                       | PSL-PL1YELY    | E5.12       | PV10-10R-L           | D1.9         | PV14-10LFX-C   | D1.26       |
|                                       | PSL-SC         | E5.13       | PV10-10RB-2K         | D1.105       | PV14-10R-C     | D1.9        |
| E5. Lockout/Tagout & Safety Solutions | PSL-SCBD-AG    | E5.22       | PV10-10RX-L          | D1.10        | PV14-10RB-3K   | D1.105      |
|                                       | PSL-SCBD-AQ    | E5.22       | PV10-10SLF-L         | D1.27        | PV14-10RX-C    | D1.10       |
|                                       | PSL-SCBD-BL    | E5.22       | PV10-10SLFB-2K       | D1.113       | PV14-10SLF-C   | D1.27       |
|                                       | PSL-SCBD-BU    | E5.22       | PV10-12R-Q           | D1.9         | PV14-10SLFB-3K | D1.113      |
|                                       | PSL-SCBD-EI    | E5.22       | PV10-14F-L           | D1.23        | PV14-12R-L     | D1.9        |
| F. Index                              | PSL-STATION    | E5.8        | PV10-14FB-2K         | D1.109       | PV14-14F-C     | D1.23       |
|                                       | PSL-STEPS      | E5.2        | PV10-14FX-L          | D1.24        | PV14-14FB-3K   | D1.109      |

# PANDUIT® ELECTRICAL SOLUTIONS

| Part Number    | Page Number |
|----------------|-------------|
| PV14-14R-C     | D1.9        |
| PV14-14RB-3K   | D1.105      |
| PV14-14RX-L    | D1.10       |
| PV14-14SLF-C   | D1.27       |
| PV14-14SLFB-3K | D1.113      |
| PV14-38R-L     | D1.9        |
| PV14-38RB-2K   | D1.105      |
| PV14-38RX-L    | D1.10       |
| PV14-4R-C      | D1.9        |
| PV14-4RB-3K    | D1.105      |
| PV14-4RX-C     | D1.10       |
| PV14-56R-C     | D1.9        |
| PV14-56RB-2K   | D1.105      |
| PV14-56RX-L    | D1.10       |
| PV14-5SLF-C    | D1.27       |
| PV14-610R-C    | D1.11       |
| PV14-610RB-3K  | D1.105      |
| PV14-6F-C      | D1.23       |
| PV14-6FB-3K    | D1.109      |
| PV14-6FF-C     | D1.28       |
| PV14-6FFB-3K   | D1.114      |
| PV14-6FN-C     | D1.23       |
| PV14-6FNB-3K   | D1.109      |
| PV14-6FX-C     | D1.24       |
| PV14-6LF-C     | D1.25       |
| PV14-6LFB-3K   | D1.111      |
| PV14-6LFW-C    | D1.25       |
| PV14-6LWB-3K   | D1.111      |
| PV14-6LFX-C    | D1.26       |
| PV14-6R-C      | D1.9        |
| PV14-6RB-3K    | D1.105      |
| PV14-6RN-C     | D1.9        |
| PV14-6RNB-3K   | D1.105      |
| PV14-6RX-C     | D1.10       |
| PV14-6SLF-C    | D1.27       |
| PV14-6SLFB-3K  | D1.113      |
| PV14-8F-C      | D1.23       |
| PV14-8FB-3K    | D1.109      |
| PV14-8FF-C     | D1.28       |
| PV14-8FFB-3K   | D1.114      |
| PV14-8FX-C     | D1.24       |
| PV14-8LF-C     | D1.25       |
| PV14-8LFB-3K   | D1.111      |
| PV14-8LFX-C    | D1.26       |
| PV14-8R-C      | D1.9        |
| PV14-8RB-3K    | D1.105      |
| PV14-8RX-C     | D1.10       |
| PV14-8SLF-C    | D1.27       |
| PV14-8SLFB-3K  | D1.113      |
| PV14-P47-C     | D1.54       |
| PV14-P47B-3K   | D1.130      |
| PV18-10F-CY    | D1.23       |
| PV18-10FB-3K   | D1.109      |
| PV18-10FF-CY   | D1.28       |
| PV18-10FFB-3K  | D1.114      |
| PV18-10FN-CY   | D1.23       |
| PV18-10FX-CY   | D1.24       |
| PV18-10LF-CY   | D1.25       |
| PV18-10LFB-3K  | D1.111      |
| PV18-10LFN-CY  | D1.25       |
| PV18-10LFNB-3K | D1.111      |
| PV18-10LFX-CY  | D1.26       |
| PV18-10R-CY    | D1.9        |
| PV18-10RB-3K   | D1.105      |
| PV18-10RX-CY   | D1.10       |
| PV18-10SLF-CY  | D1.27       |
| PV18-10SLFB-3K | D1.113      |
| PV18-12R-LY    | D1.9        |
| PV18-14FB-3K   | D1.109      |
| PV18-14R-CY    | D1.9        |
| PV18-14RB-3K   | D1.105      |
| PV18-14RX-CY   | D1.10       |
| PV18-38R-LY    | D1.9        |
| PV18-38RB-2K   | D1.105      |
| PV18-38RX-LY   | D1.10       |
| PV18-4R-CY     | D1.9        |
| PV18-4RB-3K    | D1.105      |

| Part Number   | Page Number |
|---------------|-------------|
| PV18-4RNB-3K  | D1.105      |
| PV18-4RX-CY   | D1.10       |
| PV18-56R-CY   | D1.9        |
| PV18-56RB-2K  | D1.105      |
| PV18-56RX-LY  | D1.10       |
| PV18-5SLF-CY  | D1.27       |
| PV18-5SLFB-3K | D1.113      |
| PV18-610R-CY  | D1.11       |
| PV18-610RB-3K | D1.105      |
| PV18-6F-CY    | D1.23       |
| PV18-6FB-3K   | D1.109      |
| PV18-6FF-CY   | D1.28       |
| PV18-6FFB-3K  | D1.114      |
| PV18-6FN-CY   | D1.23       |
| PV18-6FNB-3K  | D1.109      |
| PV18-6FX-CY   | D1.24       |
| PV18-6LF-CY   | D1.25       |
| PV18-6LFB-3K  | D1.111      |
| PV18-6LFW-CY  | D1.25       |
| PV18-6LFWB-3K | D1.111      |
| PV18-6LFX-CY  | D1.26       |
| PV18-6R-CY    | D1.9        |
| PV18-6RB-3K   | D1.105      |
| PV18-6RNB-3K  | D1.105      |
| PV18-6RX-CY   | D1.10       |
| PV18-6SLF-CY  | D1.27       |
| PV18-6SLFB-3K | D1.113      |
| PV18-8F-CY    | D1.23       |
| PV18-8FB-3K   | D1.109      |
| PV18-8FF-CY   | D1.28       |
| PV18-8FFB-3K  | D1.114      |
| PV18-8FX-CY   | D1.24       |
| PV18-8LF-CY   | D1.25       |
| PV18-8LFB-3K  | D1.111      |
| PV18-8LFX-CY  | D1.26       |
| PV18-8R-CY    | D1.9        |
| PV18-8RB-3K   | D1.105      |
| PV18-8RX-CY   | D1.10       |
| PV18-8SLF-CY  | D1.27       |
| PV18-8SLFB-3K | D1.113      |
| PV18-P47-CY   | D1.54       |
| PV18-P47B-3K  | D1.130      |
| PV2-10R-XY    | D1.15       |
| PV2-10RX-XY   | D1.16       |
| PV2-12R-XY    | D1.15       |
| PV2-12RX-XY   | D1.16       |
| PV2-14R-XY    | D1.15       |
| PV2-14RX-XY   | D1.16       |
| PV22-10R-CY   | D1.9        |
| PV22-2F-CY    | D1.23       |
| PV22-2R-CY    | D1.9        |
| PV22-4F-CY    | D1.23       |
| PV22-4R-CY    | D1.9        |
| PV22-6F-CY    | D1.23       |
| PV22-6R-CY    | D1.9        |
| PV22-8R-CY    | D1.9        |
| PV2-38R-XY    | D1.15       |
| PV2-38RX-XY   | D1.16       |
| PV2-56R-XY    | D1.15       |
| PV2-56RX-XY   | D1.16       |
| PV4-10R-E     | D1.15       |
| PV4-10RX-E    | D1.16       |
| PV4-12R-E     | D1.15       |
| PV4-12RX-E    | D1.16       |
| PV4-14R-E     | D1.15       |
| PV4-14RX-E    | D1.16       |
| PV4-38R-E     | D1.15       |
| PV4-38RX-E    | D1.16       |
| PV4-56R-E     | D1.15       |
| PV4-56RX-E    | D1.16       |
| PV6-10R-X     | D1.15       |
| PV6-10RX-X    | D1.16       |
| PV6-12R-X     | D1.15       |
| PV6-14R-X     | D1.15       |
| PV6-14RX-X    | D1.16       |
| PV6-38R-X     | D1.15       |
| PV6-38RX-X    | D1.16       |

| Part Number                    | Page Number  |
|--------------------------------|--------------|
| PV6-56R-X                      | D1.15        |
| PV6-56RX-X                     | D1.16        |
| PV6-8R-E                       | D1.15        |
| PV6-8RX-E                      | D1.16        |
| PV8-10R-QY                     | D1.15        |
| PV8-10RX-QY                    | D1.16        |
| PV8-12R-XY                     | D1.15        |
| PV8-12RX-XY                    | D1.16        |
| PV8-14R-QY                     | D1.15        |
| PV8-14RX-QY                    | D1.16        |
| PV8-38R-QY                     | D1.15        |
| PV8-38RX-QY                    | D1.16        |
| PV8-56R-QY                     | D1.15        |
| PV8-56RX-QY                    | D1.16        |
| PV8-8R-QY                      | D1.15        |
| PV8-8RX-QY                     | D1.16        |
| PVL100BY-0-Y                   | E5.36        |
| PVL100BY-1-Y thru PVL100BY-9-Y | E5.36        |
| PVL100BY-A-Y thru PVL100BY-Z-Y | E5.36        |
| PVL100BY-DSH-Y                 | E5.36        |
| PVL200BY-0-Y                   | E5.36        |
| PVL200BY-1-Y thru PVL200BY-9-Y | E5.36        |
| PVL200BY-A-Y thru PVL200BY-Z-Y | E5.36        |
| PVL200BY-DSH-Y                 | E5.36        |
| PVL200BY-Z-Y                   | E5.34        |
| PVS0109D72Y                    | E5.19, E5.24 |
| PVS0204C171Y                   | E5.19        |
| PVS0204C176Y                   | E5.19        |
| PVS0204C177Y                   | E5.19        |
| PVS0204C178Y                   | E5.19        |
| PVS0204C179Y                   | E5.19        |
| PVS0204D100Y                   | E5.19, E5.24 |
| PVS0204D72Y                    | E5.19, E5.24 |
| PVS0204W172Y                   | E5.19        |
| PVS0209D445Y                   | E5.19        |
| PVS0305C174Y                   | E5.19        |
| PVS0305C174Y                   | E5.24        |
| PVS0305W2101Y                  | E5.19, E5.24 |
| PVS0305W2102Y                  | E5.19, E5.24 |
| PVS0503N458Y                   | E5.19        |
| PVS0505C174Y                   | E5.19, E5.24 |
| PVS0507W2101Y                  | E5.19, E5.24 |
| PVS0509B364Y                   | E5.19, E5.24 |
| PVS0710B364Y                   | E5.19, E5.24 |
| PVS0710C173Y                   | E5.19        |
| PVS0710C180Y                   | E5.19        |
| PVS0710D72Y                    | E5.19, E5.24 |
| PVT-110                        | E5.17        |
| PVT-111                        | E5.17        |
| PVT-112                        | E5.17        |
| PVT-113-Q                      | E5.17        |
| PVT-118-Q                      | E5.17        |
| PVT-148-Q                      | E5.16        |
| PVT-15                         | E5.14        |
| PVT-150-Q                      | E5.16        |
| PVT-153-Q                      | E5.16        |
| PVT-155-Q                      | E5.16        |
| PVT-156-Q                      | E5.16        |
| PVT-157-Q                      | E5.16        |
| PVT-158-Q                      | E5.16        |
| PVT-160-Q                      | E5.16        |
| PVT-161-Q                      | E5.17        |
| PVT-165-Q                      | E5.17        |
| PVT-179-Q                      | E5.17        |
| PVT-199-Q                      | E5.17        |
| PVT-200-Q                      | E5.17        |
| PVT-23                         | E5.14        |
| PVT-23-Q                       | E5.14        |
| PVT-238-Q                      | E5.16        |
| PVT-30                         | E5.14        |
| PVT-30-Q                       | E5.14        |
| PVT-41                         | E5.14        |
| PVT-42-Q                       | E5.14        |
| PVT-43                         | E5.15        |
| PVT-44                         | E5.15        |
| PVT-44-Q                       | E5.15        |
| PVT-56-Q                       | E5.15        |

|  |
|--|
| A. System Overview                     |
| B1. Cable Ties                         |
| B2. Cable Accessories                  |
| B3. Stainless Steel Ties               |
| C1. Wiring Duct                        |
| C2. Surface Raceway                    |
| C3. Abrasion Protection                |
| C4. Cable Management                   |
| D1. Terminals                          |
| D2. Power Connectors                   |
| D3. Grounding Connectors               |
| E1. Labeling Systems                   |
| E2. Labels                             |
| E3. Pre-Printed & Write-On Markers     |
| E4. Permanent Identification           |
| E5. Lockout/ Tagout & Safety Solutions |
| F. Index                               |





| Part Number  | Page Number |
|--------------|-------------|
| S100X150VHC  | E1.4        |
| S100X150VHTY | E2.8        |
| S100X150VIC  | E1.4        |
| S100X150VITY | E2.8        |
| S100X150YAJ  | E2.3        |
| S100X225V0TY | E2.9        |
| S100X225V9TY | E2.9        |
| S100X225VA1Y | E2.8        |
| S100X225VAC  | E1.4        |
| S100X225VAFY | E3.11       |
| S100X225VARY | E3.11       |
| S100X225VATY | E2.8        |
| S100X225VBC  | E1.4        |
| S100X225VBTY | E2.8        |
| S100X225VCTY | E2.8        |
| S100X225VDC  | E1.4        |
| S100X225VDTY | E2.9        |
| S100X225VETY | E2.9        |
| S100X225VFTY | E2.9        |
| S100X225VGTY | E2.9        |
| S100X225VHC  | E1.4        |
| S100X225VHTY | E2.9        |
| S100X225VIC  | E1.4        |
| S100X225VITY | E2.9        |
| S100X225YAJ  | E2.3        |
| S100X225YHJ  | E2.2        |
| S100X250VATY | E2.9        |
| S100X400VA1Y | E2.9        |
| S100X400VAC  | E1.4        |
| S100X400VATY | E2.3        |
| S100X400YAJ  | E2.2        |
| S100X650VA1Y | E2.9        |
| S100X650VAC  | E1.4        |
| S100X650VATY | E2.9        |
| S100X650YAJ  | E2.3        |
| S150X150VATY | E2.9        |
| S150X225VATY | E2.9        |
| S150X400VATY | E2.9        |
| S1F-C        | C1.31       |
| S2-10R-X     | D1.21       |
| S2-12R-X     | D1.21       |
| S2-14R-X     | D1.21       |
| S2-38R-X     | D1.21       |
| S2-56R-X     | D1.21       |
| S2/0-12R-X   | D1.21       |
| S2/0-14R-X   | D1.21       |
| S2/0-38R-X   | D1.21       |
| S2/0-56R-X   | D1.21       |
| S2/0-76R-X   | D1.21       |
| S200X150YAJ  | E2.3        |
| S200X225VA1Y | E2.9        |
| S200X225VATY | E2.9        |
| S200X225YAJ  | E2.3        |
| S200X250VATY | E2.9        |
| S200X400TAT  | E2.8        |
| S200X400VA1Y | E2.9        |
| S200X400VATY | E2.9        |
| S200X400YAJ  | E2.3        |
| S200X650VA1Y | E2.9        |
| S200X650VATY | E2.9        |
| S200X650YAJ  | E2.3        |
| S2-10R-X     | D1.21       |
| S2-12R-X     | D1.21       |
| S2-14R-X     | D1.21       |
| S2-38R-X     | D1.21       |
| S250-12R-5   | D1.21       |
| S250-38R-5   | D1.21       |
| S250-56R-5   | D1.21       |
| S250-76R-5   | D1.21       |
| S2-56R-X     | D1.21       |
| S2F-C        | C1.31       |
| S2X2YL6NM    | C1.56       |
| S3/0-12R-5   | D1.21       |
| S3/0-14R-5   | D1.21       |
| S3/0-38R-5   | D1.21       |
| S3/0-56R-5   | D1.21       |
| S3/0-76R-5   | D1.21       |

| Part Number  | Page Number  |
|--------------|--------------|
| S3F-C        | C1.31        |
| S4/0-12R-5   | D1.21        |
| S4/0-38R-5   | D1.21        |
| S4/0-56R-5   | D1.21        |
| S4/0-76R-5   | D1.21        |
| S4-10R-E     | D1.21        |
| S4-14R-E     | D1.21        |
| S4-38R-E     | D1.21        |
| S4-56R-E     | D1.21        |
| S4F-C        | C1.31        |
| S4X4YL6NM    | C1.56        |
| S6-10R-E     | D1.21        |
| S6-14R-E     | D1.21        |
| S6-38R-E     | D1.21        |
| S6-56R-E     | D1.21        |
| S8-10R-Q     | D1.21        |
| S8-14R-Q     | D1.21        |
| S8-38R-Q     | D1.21        |
| S8-56R-Q     | D1.21        |
| SA1-X        | D2.115       |
| SA1/0-X      | D2.115       |
| SA1000-1     | D2.115       |
| SA2-X        | D2.115       |
| SA2/0-5      | D2.115       |
| SA250-5      | D2.115       |
| SA3/0-5      | D2.115       |
| SA300-2      | D2.115       |
| SA350-2      | D2.115       |
| SA4-X        | D2.115       |
| SA4/0-5      | D2.115       |
| SA400-2      | D2.115       |
| SA500-2      | D2.115       |
| SA6-X        | D2.115       |
| SA600-2      | D2.115       |
| SA750-1      | D2.115       |
| SA800-1      | D2.115       |
| SACS50-T100  | B1.54, B2.27 |
| SAR1/0-2-X   | D2.116       |
| SAR2-4-X     | D2.116       |
| SAR3/0-1/0-5 | D2.116       |
| SAR350-4/0-2 | D2.116       |
| SAR4/0-2/0-5 | D2.116       |
| SAR500-350-2 | D2.116       |
| SAR600-500-2 | D2.116       |
| SAR750-600-2 | D2.116       |
| SBA1/0-Q     | D2.127       |
| SBA2-C       | D2.127       |
| SBA2/0-Q     | D2.127       |
| SBA350-1     | D2.127       |
| SBA4-C       | D2.127       |
| SBA4/0-Q     | D2.127       |
| SBA500-1     | D2.127       |
| SBA6-C       | D2.127       |
| SBC1/0-L     | D2.125       |
| SBC1000-1    | D2.125       |
| SBC2-C       | D2.125       |
| SBC2L-C      | D2.125       |
| SBC2/0-Q     | D2.125       |
| SBC250-Q     | D2.125       |
| SBC3-C       | D2.125       |
| SBC3/0-Q     | D2.125       |
| SBC350-1     | D2.125       |
| SBC4S-C      | D2.125       |
| SBC4SL-C     | D2.125       |
| SBC500-1     | D2.125       |
| SBC6S-C      | D2.125       |
| SBC6SL-C     | D2.125       |
| SBC750-1     | D2.125       |
| SBC8-C       | D2.125       |
| SBC8L-C      | D2.125       |
| SBCT10-C     | D2.126       |
| SBCT1/0-L    | D2.126       |
| SBCT1000-1   | D2.126       |
| SBCT2-C      | D2.126       |
| SBCT2/0-Q    | D2.126       |
| SBCT250-Q    | D2.126       |
| SBCT3-C      | D2.126       |

| Part Number | Page Number |
|-------------|-------------|
| SBCT3/0-Q   | D2.126      |
| SBCT350-1   | D2.126      |
| SBCT500-1   | D2.126      |
| SBCT6-C     | D2.126      |
| SBCT750-1   | D2.126      |
| SBCT8-C     | D2.126      |
| SCH1-E      | D2.62       |
| SCH1/0-X    | D2.62       |
| SCH1000-3   | D2.62       |
| SCH2-Q      | D2.62       |
| SCH2/0-X    | D2.62       |
| SCH250-X    | D2.62       |
| SCH3/0-X    | D2.62       |
| SCH300-X    | D2.62       |
| SCH350-X    | D2.62       |
| SCH4-L      | D2.62       |
| SCH4/0-X    | D2.62       |
| SCH500-6    | D2.62       |
| SCH6-L      | D2.62       |
| SCH750-6    | D2.62       |
| SCL1-E      | D2.61       |
| SCL1/0-X    | D2.61       |
| SCL1000-3   | D2.61       |
| SCL2-Q      | D2.61       |
| SCL2/0-X    | D2.61       |
| SCL250-X    | D2.61       |
| SCL3/0-X    | D2.61       |
| SCL300-X    | D2.61       |
| SCL350-X    | D2.61       |
| SCL4-L      | D2.61       |
| SCL4/0-X    | D2.61       |
| SCL400-6    | D2.61       |
| SCL500-6    | D2.61       |
| SCL6-L      | D2.61       |
| SCL600-6    | D2.61       |
| SCL750-6    | D2.61       |
| SCL8-L      | D2.61       |
| SCMS10-C    | D2.111      |
| SCMS120-Q   | D2.111      |
| SCMS150-X   | D2.111      |
| SCMS16-C    | D2.111      |
| SCMS185-X   | D2.111      |
| SCMS240-X   | D2.111      |
| SCMS25-L    | D2.111      |
| SCMS300-5   | D2.111      |
| SCMS35-L    | D2.111      |
| SCMS400-5   | D2.111      |
| SCMS50-L    | D2.111      |
| SCMS500-6   | D2.111      |
| SCMS630-6   | D2.111      |
| SCMS70-L    | D2.111      |
| SCMS95-Q    | D2.111      |
| SCS1-E      | D2.60       |
| SCS1/0-X    | D2.60       |
| SCS1000-3   | D2.60       |
| SCS2-Q      | D2.60       |
| SCS2/0-X    | D2.60       |
| SCS250-X    | D2.60       |
| SCS3/0-X    | D2.60       |
| SCS300-X    | D2.60       |
| SCS350-X    | D2.60       |
| SCS4-L      | D2.60       |
| SCS4/0-X    | D2.60       |
| SCS400-6    | D2.60       |
| SCS500-6    | D2.60       |
| SCS6-L      | D2.60       |
| SCS600-6    | D2.60       |
| SCS750-6    | D2.60       |
| SCS8-L      | D2.60       |
| SCSF1-X     | D2.102      |
| SCSF1/0-X   | D2.102      |
| SCSF2-E     | D2.102      |
| SCSF2/0-X   | D2.102      |
| SCSF250-X   | D2.102      |
| SCSF3/0-X   | D2.102      |
| SCSF300-6   | D2.102      |
| SCSF350-6   | D2.102      |

**A.**  
System Overview

**B1.**  
Cable Ties

**B2.**  
Cable Accessories

**B3.**  
Stainless Steel Ties

**C1.**  
Wiring Duct

**C2.**  
Surface Raceway

**C3.**  
Abrasion Protection

**C4.**  
Cable Management

**D1.**  
Terminals

**D2.**  
Power Connectors

**D3.**  
Grounding Connectors

**E1.**  
Labeling Systems

**E2.**  
Labels

**E3.**  
Pre-Printed & Write-On Markers

**E4.**  
Permanent Identification

**E5.**  
Lockout/ Tagout & Safety Solutions

**F.**  
Index

# PANDUIT® ELECTRICAL SOLUTIONS

| A. System Overview                    | Part Number   | Page Number | Part Number     | Page Number | Part Number     | Page Number |
|---------------------------------------|---------------|-------------|-----------------|-------------|-----------------|-------------|
| B1. Cable Ties                        | SCSF4-L       | D2.102      | SE25PFR-TR8     | C3.16       | SGABM30-AV-C300 | B2.7        |
|                                       | SCSF4/0-X     | D2.102      | SE25PSC-TR0     | C3.17       | SGABM40-A-L     | B2.7        |
|                                       | SCSF6-L       | D2.102      | SE38P-MR0       | C3.15       | SGABM40-AT-L0   | B2.7        |
| B2. Cable Accessories                 | SCSF8-L       | D2.102      | SE38P-MR10      | C3.15       | SGABM50-A-L     | B2.7        |
|                                       | SCSS1-Q       | D2.59       | SE38P-MR8       | C3.15       | SGABM50-AT-L0   | B2.7        |
|                                       | SCSS1/0-X     | D2.59       | SE38P-TR0       | C3.15       | SGMPMH38-L0     | B2.21       |
|                                       | SCSS2-Q       | D2.59       | SE38P-TR8       | C3.15       | SGMPMS19-C0     | B2.21       |
|                                       | SCSS2/0-X     | D2.59       | SE38PFR-MR0     | C3.16       | SGMPMS25-C0     | B2.21       |
|                                       | SCSS250-X     | D2.59       | SE38PFR-MR10    | C3.16       | SGMPMWH32-L0    | B2.21       |
| B3. Stainless Steel Ties              | SCSS3/0-X     | D2.59       | SE38PFR-MR8     | C3.16       | SGTA1S8-C       | B2.13       |
|                                       | SCSS4-L       | D2.59       | SE38PFR-TR0     | C3.16       | SGTM1S6-C       | B2.11       |
|                                       | SCSS4/0-X     | D2.59       | SE38PFR-TR8     | C3.16       | SGTM1S6-C0      | B2.11       |
| C1. Wiring Duct                       | SCSS6-L       | D2.59       | SE38PSC-TR0     | C3.17       | SGTM2S8-C       | B2.11       |
|                                       | SCSS8-L       | D2.59       | SE50P-CR0       | C3.15       | SGTM2S8-C0      | B2.11       |
|                                       | SCT1/0-1/0    | D2.63       | SE50P-CR8       | C3.15       | SGTM3S10-C      | B2.11       |
| C2. Surface Raceway                   | SCT2-2        | D2.63       | SE50P-DR0       | C3.15       | SGTM3S10-C0     | B2.11       |
|                                       | SCT2/0-2/0    | D2.63       | SE50P-DR10      | C3.15       | SHH1-S8-X       | B2.50       |
|                                       | SCT250-250    | D2.63       | SE50P-DR8       | C3.15       | SHH3-S8-X       | B2.50       |
| C3. Abrasion Protection               | SCT300-300    | D2.63       | SE50PFR-CR0     | C3.16       | SICH100-C       | B2.43       |
|                                       | SCT350-350    | D2.63       | SE50PFR-CR8     | C3.16       | SICH150-C       | B2.43       |
|                                       | SCT4/0-1/0    | D2.63       | SE50PFR-DR0     | C3.16       | SICH25-C        | B2.43       |
| C4. Cable Management                  | SCT4/0-4/0    | D2.63       | SE50PFR-DR10    | C3.16       | SICH38-C        | B2.43       |
|                                       | SCT500-4/0    | D2.63       | SE50PFR-DR8     | C3.16       | SICH50-C        | B2.43       |
|                                       | SCT500-500    | D2.63       | SE50PSC-CR0     | C3.17       | SICH75-C        | B2.43       |
| D1. Terminals                         | <b>SD2EMI</b> | <b>C1.7</b> | SE75P-CR0       | C3.15       | SLCT-3          | E5.41       |
|                                       | SD2H6         | C1.26       | SE75P-CR8       | C3.15       | SLCT-IG         | E5.41       |
|                                       | SD2HWH6       | C1.26       | SE75P-DR0       | C3.15       | SLCT-3OR        | E5.41       |
| D2. Power Connectors                  | <b>SD3EMI</b> | <b>C1.7</b> | SE75P-DR10      | C3.15       | SLCT-3YL        | E5.41       |
|                                       | SD3H6         | C1.26       | SE75P-DR8       | C3.15       | SLCT-3IG        | E5.41       |
|                                       | SD3HWH6       | C1.26       | SE75PFR-CR0     | C3.16       | SLCT-OR         | E5.41       |
| D3. Grounding Connectors              | <b>SD4EMI</b> | <b>C1.7</b> | SE75PFR-CR8     | C3.16       | SLCT-WH         | E5.41       |
|                                       | SD4H6         | C1.26       | SE75PFR-DR0     | C3.16       | SLCT-YL         | E5.41       |
|                                       | SD4HWH6       | C1.26       | SE75PFR-DR10    | C3.16       | SMS-A-C         | B2.8        |
| E1. Labeling Systems                  | SE125P-LR0    | C3.15       | SE75PFR-DR8     | C3.16       | SMS-A-C14       | B2.8        |
|                                       | SE125P-LR8    | C3.15       | SE75PSC-CR0     | C3.17       | SMS-A-C15       | B2.8        |
|                                       | SE125P-TR0    | C3.15       | SEZ-1CLL        | E5.40       | SMS-S6-D        | B2.8        |
| E2. Labels                            | SE125P-TR8    | C3.15       | SEZ-1DLL        | E5.40       | SNS-5-C         | C1.31       |
|                                       | SE125PFR-LR0  | C3.16       | SEZ-1NLL        | E5.40       | SNS.75-C        | C1.31       |
|                                       | SE125PFR-LR8  | C3.16       | SEZ-1WHLL       | E5.40       | SNS1-C          | C1.31       |
| E3. Pre-Printed & Write-On Markers    | SE125PFR-TR0  | C3.16       | SEZ-1WLL        | E5.40       | SNS1.5-C        | C1.31       |
|                                       | SE125PFR-TR8  | C3.16       | SEZ-1YLL        | E5.40       | SNS2-C          | C1.31       |
|                                       | SE125PSC-LR0  | C3.17       | SEZ-RSC1        | E5.41       | SNS25F-C        | C1.31       |
| E4. Permanent Identification          | SE12P-MR0     | C3.15       | SEZ-RSC2        | E5.41       | SNS3-C          | C1.31       |
|                                       | SE12P-MR10    | C3.15       | SEZ-RSC3        | E5.41       | SNS37F-C        | C1.31       |
|                                       | SE12P-MR8     | C3.15       | SEZ-RSC4        | E5.41       | SNS50F-C        | C1.31       |
| E5. Lockout/Tagout & Safety Solutions | SE12P-TR0     | C3.15       | SEZ-SNC1        | E5.41       | SNS62F-C        | C1.31       |
|                                       | SE12P-TR8     | C3.15       | SEZ-SNC2        | E5.41       | SNS75F-C        | C1.31       |
|                                       | SE12PFR-MR0   | C3.16       | SEZ-SNC3        | E5.41       | SP1-1/0-L       | D3.20       |
| F. Index                              | SE12PFR-MR8   | C3.16       | SEZ-SNC4        | E5.41       | SP1-1/0L-L      | D3.20       |
|                                       | SE12PFR-TR0   | C3.16       | SG100M-C        | B1.40       | SP1-2-C         | D3.20       |
|                                       | SE12PFR-TR8   | C3.16       | SG100M-C0       | B1.41       | SP1-2/0-Q       | D3.20       |
|                                       | SE12PSC-TR0   | C3.17       | SG150I-C        | B1.40       | SP1-2/0L-Q      | D3.20       |
|                                       | SE150P-LR0    | C3.15       | SG150I-C0       | B1.41       | SP1-2L-C        | D3.20       |
|                                       | SE150P-LR8    | C3.15       | SG200S-C        | B1.40       | SP1-3-C         | D3.20       |
|                                       | SE150P-TR0    | C3.15       | SG200S-C0       | B1.41       | SP1-350-12      | D3.20       |
|                                       | SE150P-TR8    | C3.15       | SG200S-M30      | B1.41       | SP1-350L-12     | D3.20       |
|                                       | SE150PFR-LR0  | C3.16       | SG250S-C        | B1.40       | SP1-3L-C        | D3.20       |
|                                       | SE150PFR-LR8  | C3.16       | SG250S-C0       | B1.41       | SP1-4-C         | D3.20       |
|                                       | SE150PFR-TR0  | C3.16       | SG300S-C        | B1.40       | SP1-4/0-Q       | D3.20       |
|                                       | SE150PFR-TR10 | C3.16       | SG300S-C0       | B1.41       | SP1-4/0L-Q      | D3.20       |
|                                       | SE150PFR-TR8  | C3.16       | SG300S-M30      | B1.41       | SP1-4L-C        | D3.20       |
|                                       | SE150PSC-LR0  | C3.17       | SG350LH-L       | B1.40       | SP1-500-12      | D3.20       |
|                                       | SE175P-TR0    | C3.15       | SG350LH-L0      | B1.41       | SP1-500L-12     | D3.20       |
|                                       | SE175PFR-TR0  | C3.16       | SG350LH-TL30    | B1.41       | SP1-7-C         | D3.20       |
|                                       | SE25P-MR0     | C3.15       | SG370S-C        | B1.40       | SP1-7L-C        | D3.20       |
|                                       | SE25P-MR10    | C3.15       | SG370S-C0       | B1.41       | SP1-8-C         | D3.20       |
|                                       | SE25P-MR8     | C3.15       | SG450H-L        | B1.40       | SP1-8L-C        | D3.20       |
|                                       | SE25P-TR0     | C3.15       | SG450H-L0       | B1.41       | SP2-1/0-L       | D3.21       |
|                                       | SE25P-TR8     | C3.15       | SGABM20-A-C     | B2.7        | SP2-1/0L-L      | D3.21       |
|                                       | SE25PFR-MR0   | C3.16       | SGABM20-AT-C0   | B2.7        | SP2-2-C         | D3.21       |
|                                       | SE25PFR-MR10  | C3.16       | SGABM20-AV-C300 | B2.7        | SP2-2/0-Q       | D3.21       |
|                                       | SE25PFR-MR8   | C3.16       | SGABM25-A-C     | B2.7        | SP2-2/0L-Q      | D3.21       |
|                                       | SE25PFR-TR0   | C3.16       | SGABM25-AT-C0   | B2.7        | SP2-2L-C        | D3.21       |
|                                       |               |             | SGABM25-S6-C    | B2.7        | SP2-3-C         | D3.21       |
|                                       |               |             | SGABM25-S6-C0   | B2.7        | SP2-350-12      | D3.21       |
|                                       |               |             | SGABM30-A-C     | B2.7        | SP2-350L-12     | D3.21       |
|                                       |               |             | SGABM30-AT-C0   | B2.7        | SP2-3L-C        | D3.21       |



| Part Number        | Page Number  |
|--------------------|--------------|
| SP2-4-C            | D3.21        |
| SP2-4/0-Q          | D3.21        |
| SP2-4/0L-Q         | D3.21        |
| SP2-4L-C           | D3.21        |
| SP2-500-12         | D3.21        |
| SP2-500L-12        | D3.21        |
| SP2-7-C            | D3.21        |
| SP2-7L-C           | D3.21        |
| SP2-8-C            | D3.21        |
| SP2-8L-C           | D3.21        |
| SPF1-1/0-L         | D3.22        |
| SPF1-2-C           | D3.22        |
| SPF1-2/0-Q         | D3.22        |
| SPF1-3-C           | D3.22        |
| SPF1-350-12        | D3.22        |
| SPF1-4-C           | D3.22        |
| SPF1-4/0-Q         | D3.22        |
| SPF1-500-12        | D3.22        |
| SPF1-7-C           | D3.22        |
| SPF1-8-C           | D3.22        |
| SPF2-1/0-L         | D3.23        |
| SPF2-2-C           | D3.23        |
| SPF2-2/0-Q         | D3.23        |
| SPF2-3-C           | D3.23        |
| SPF2-350-12        | D3.23        |
| SPF2-4-C           | D3.23        |
| SPF2-4/0-Q         | D3.23        |
| SPF2-500-12        | D3.23        |
| SPF2-7-C           | D3.23        |
| SPF2-8-C           | D3.23        |
| SR-0-XY            | D2.148       |
| SR-1000-1Y         | D2.148       |
| SR-2-XY            | D2.148       |
| SR-250-XY          | D2.148       |
| SR-350-XY          | D2.148       |
| SR-4/0-XY          | D2.148       |
| SR-500-3Y          | D2.148       |
| SR-750-1Y          | D2.148       |
| SR2                | B1.83, D1.37 |
| SR4                | D1.37        |
| SR6                | D1.37        |
| SRT                | C2.83        |
| SS-1               | D3.49        |
| SS-1GAGE           | D3.49        |
| SSB2S-C            | B1.77        |
| SSB2S-M0           | B1.77        |
| SSB2S-M30          | B1.77        |
| SSC2S-S10-C        | B1.70        |
| SSC2S-S10-M0       | B1.70        |
| SSC2S-S10-M30      | B1.70        |
| SSC2S-S6-C         | B1.70        |
| SSC2S-S6-M0        | B1.70        |
| SSC4H-S25-D0       | B1.70        |
| SSC4H-S25-D30      | B1.70        |
| SSC4H-S25-L        | B1.70        |
| SSC4S-S10-C        | B1.70        |
| SSC4S-S10-M0       | B1.70        |
| <b>SSCW14-C</b>    | D3.7         |
| <b>SSCW38-C</b>    | D3.7         |
| <b>SSFW14-C</b>    | D3.7         |
| <b>SSFW38-C</b>    | D3.7         |
| SSM2S-C            | B1.71        |
| SSM2S-D0           | B1.71        |
| SSM4S-D            | B1.71        |
| <b>SSN1420-C</b>   | D3.7         |
| <b>SSN3816-C</b>   | D3.7         |
| <b>SSNTS1420-C</b> | D3.7         |
| <b>SSNTS3816-C</b> | D3.7         |
| SSPM2.5H-L300      | B1.79        |
| SSPM2.5HP-L300     | B1.79        |
| SSPM4H-L300        | B1.79        |
| SSPM4HLP-TL300     | B1.79        |
| SSPM4HP-L300       | B1.79        |
| SST1.5I-C          | B1.67        |
| SST1.5I-M0         | B1.68        |
| SST1.5M-C          | B1.67        |
| SST1.5M-M0         | B1.68        |

| Part Number | Page Number |
|-------------|-------------|
| SST1.5M-M30 | B1.69       |
| SST1.5S-M   | B1.67       |
| SST1.5S-M0  | B1.68       |
| SST1M-C     | B1.67       |
| SST1M-C0    | B1.68       |
| SST1M-M30   | B1.69       |
| SST2H-D     | B1.67       |
| SST2H-D0    | B1.68       |
| SST2HH-D30  | B1.69       |
| SST2I-C     | B1.67       |
| SST2I-M0    | B1.68       |
| SST2S-C     | B1.67       |
| SST2S-C0    | B1.68       |
| SST2S-M30   | B1.69       |
| SST3I-C     | B1.67       |
| SST3I-C0    | B1.68       |
| SST3S-C     | B1.67       |
| SST3S-C0    | B1.68       |
| SST3S-M30   | B1.69       |
| SST4H-D30   | B1.69       |
| SST4H-L     | B1.67       |
| SST4H-L0    | B1.68       |
| SST4HH-D30  | B1.69       |
| SST4I-C     | B1.67       |
| SST4I-M0    | B1.68       |
| SST4S-C     | B1.67       |
| SST4S-C0    | B1.68       |
| SST4S-M30   | B1.69       |
| SST8H-D30   | B1.69       |
| SST8H-L     | B1.67       |
| SST8H-L0    | B1.68       |
| ST2MT       | B3.15       |
| ST3EH       | B1.112      |
| STH2        | B1.112      |
| STHV        | B1.112      |
| STK12       | E4.6        |
| STS2        | B1.112      |

## T

|                |       |
|----------------|-------|
| T019X000FJC-BK | E1.11 |
| T024X000FJC-BK | E1.11 |
| T031X000FJC-BK | E1.11 |
| T038X000C1C-BK | E1.5  |
| T038X000C2C-BK | E1.5  |
| T038X000FJC-BK | E1.11 |
| T038X000VPC-BK | E1.12 |
| T038X000VYC-WH | E1.12 |
| T038X000YKC-BK | E1.12 |
| T050X000C1C-BK | E1.5  |
| T050X000C2C-BK | E1.5  |
| T050X000CBC-BK | E1.5  |
| T050X000VPC-BK | E1.12 |
| T050X000VQC-BK | E1.12 |
| T050X000VQC-WH | E1.12 |
| T050X000VSC-BK | E1.12 |
| T050X000VSC-WH | E1.12 |
| T050X000VUC-BK | E1.12 |
| T050X000VVC-BK | E1.12 |
| T050X000VVC-WH | E1.12 |
| T050X000VXC-BK | E1.12 |
| T050X000VYC-WH | E1.12 |
| T050X000YKC-BK | E1.12 |
| T050X000YKC-WH | E1.12 |
| T075X000C1C-BK | E1.5  |
| T075X000C2C-BK | E1.5  |
| T075X000VPC-BK | E1.12 |
| T075X000YKC-BK | E1.12 |
| T100X000C1C-BK | E1.5  |
| T100X000C2C-BK | E1.5  |
| T100F-C        | C3.5  |
| T100F-C0       | C3.5  |
| T100FR-C20Y    | C3.6  |
| T100FR-CY      | C3.6  |
| T100N-C        | C3.7  |
| T100N-C0       | C3.7  |
| T100R-CY       | C3.6  |

| Part Number     | Page Number |
|-----------------|-------------|
| T100T-X         | C3.7        |
| T100X000CBC-BK  | E1.5        |
| T100X000RP1     | E5.34       |
| T100X000RPC-BK  | E1.12       |
| T100X000RU1     | E5.34       |
| T100X000RUC-BK  | E1.12       |
| T100X000RX1     | E5.34       |
| T100X000RXC-BK  | E1.12       |
| T100X000VP1Y    | E2.22       |
| T100X000VPC-BK  | E1.12       |
| T100X000VQ1Y    | E2.22       |
| T100X000VQC-BK  | E1.12       |
| T100X000VQC-WH  | E1.12       |
| T100X000VS1Y    | E2.22       |
| T100X000VSC-BK  | E1.12       |
| T100X000VSC-WH  | E1.12       |
| T100X000VU1Y    | E2.22       |
| T100X000VUC-BK  | E1.12       |
| T100X000VUC-WH  | E1.12       |
| T100X000VV1Y    | E2.22       |
| T100X000VVC-BK  | E1.12       |
| T100X000VVC-WH  | E1.12       |
| T100X000VX1Y    | E2.12       |
| T100X000VXC-BK  | E1.12       |
| T100X000VXC-WH  | E1.12       |
| T100X000VY1Y    | E2.22       |
| T100X000YKC-BK  | E1.12       |
| T100X000YKC-WH  | E1.12       |
| T12F-C          | C3.4        |
| T12F-C0         | C3.5        |
| T12F-D          | C3.4        |
| T12F-D0         | C3.5        |
| T12FR-CY        | C3.6        |
| T12FR-C20Y      | C3.6        |
| T12N-C          | C3.7        |
| T12N-C0         | C3.7        |
| T12R-CY         | C3.5        |
| T12T-C          | C3.7        |
| T19F-C          | C3.4        |
| T19F-C0         | C3.5        |
| T19F-M          | C3.4        |
| T19FR-CY        | C3.6        |
| T19FR-C20Y      | C3.6        |
| T19N-C          | C3.7        |
| T19N-C0         | C3.7        |
| T19R-CY         | C3.5        |
| T19T-C          | C3.7        |
| <b>T100P-C0</b> | <b>C3.7</b> |
| T200X000RP1     | E1.34       |
| T200X000RU1     | E1.34       |
| T200X000RX1     | E1.34       |
| T200X000VP1Y    | E2.22       |
| T200X000VQ1Y    | E2.22       |
| T200X000VS1Y    | E2.22       |
| T200X000VU1Y    | E2.22       |
| T200X000VV1Y    | E2.22       |
| T200X000VW1Y    | E2.22       |
| T200X000VX1Y    | E2.22       |
| T200X000VY1Y    | E2.22       |
| T200X000Y2T     | E5.34       |
| T200X000YK1     | E2.22       |
| T225X000YK1     | E2.22       |
| T25F-C          | C3.4        |
| T25F-C0         | C3.5        |
| T25F-C1         | C3.4        |
| T25F-C10        | C3.4        |
| T25F-C16        | C3.4        |
| T25F-C2         | C3.4        |
| T25F-C3Y        | C3.4        |
| T25F-C4Y        | C3.4        |
| T25F-C5         | C3.4        |
| T25F-C6         | C3.4        |
| T25F-C7         | C3.4        |
| T25F-C8         | C3.4        |

A.  
System  
Overview

B1.  
Cable Ties

B2.  
Cable  
Accessories

B3.  
Stainless  
Steel Ties

C1.  
Wiring  
Duct

C2.  
Surface  
Raceway

C3.  
Abrasion  
Protection

C4.  
Cable  
Management

D1.  
Terminals

D2.  
Power  
Connectors

D3.  
Grounding  
Connectors

E1.  
Labeling  
Systems

E2.  
Labels

E3.  
Pre-Printed  
& Write-On  
Markers

E4.  
Permanent  
Identification

E5.  
Lockout/  
Tagout  
& Safety  
Solutions

F.  
Index

# PANDUIT® ELECTRICAL SOLUTIONS

| A. System Overview                    | Part Number        | Page Number  | Part Number    | Page Number         | Part Number    | Page Number                  |
|---------------------------------------|--------------------|--------------|----------------|---------------------|----------------|------------------------------|
| B1. Cable Ties                        | T25F-M             | C3.4         | T50F-C5        | C3.4                | T70PGIW        | C2.53                        |
|                                       | T25F-M0            | C3.5         | T50F-C6        | C3.4                | T70PGSIW       | C2.53                        |
|                                       | T25F-X0            | C3.5         | T50F-C7        | C3.4                | T70PIW         | C2.53                        |
|                                       | T25FR-CY           | C3.6         | T50F-C8        | C3.4                | T70PNIW        | C2.53                        |
| B2. Cable Accessories                 | T25FR-C20Y         | C3.6         | T50F-TL        | C3.5                | T70PSIW        | C2.53                        |
|                                       | T25FR-M20Y         | C3.6         | T50F-TL0       | C3.5                | T70RAIW        | C2.36                        |
|                                       | T25FR-MY           | C3.6         | T50F-TL4Y      | C3.5                | T70S-X         | C2.40                        |
|                                       | T25N-C             | C3.7         | T50F-X         | C3.4                | T70SDB-X       | C2.26, C2.40, C2.101, C2.110 |
|                                       | T25N-C0            | C3.7         | T50F-X0        | C3.5                | T70TD          | C2.37                        |
|                                       | T25R-C20Y          | C3.5         | T50FR-CY       | C3.6                | T70TIW         | C2.37                        |
|                                       | T25R-CY            | C3.5         | T50FR-C20Y     | C3.6                | T70TRCIW       | C2.37                        |
| B3. Stainless Steel Ties              | T25R-M20Y          | C3.6         | T50FR-TLY      | C3.6                | T70TRI         | C2.37                        |
|                                       | T25R-MY            | C3.6         | T50N-C         | C3.7                | T70TRIW        | C2.37                        |
|                                       | T25T-L             | C3.7         | T50N-C0        | C3.7                | T70WC2IW       | C2.37                        |
|                                       | T25T-L0            | C3.7         | <b>T50P-C0</b> | <b>C3.7</b>         | T70WCIW        | C2.37                        |
| C1. Wiring Duct                       | T38F-C             | C3.4         | T50R-CY        | C3.6                | T70WM40TRIW    | C2.37                        |
|                                       | T38F-C0            | C3.5         | T50R-TLY       | C3.6                | T70WR-X        | C2.40                        |
|                                       | T38FR-C20Y         | C3.6         | T50T-Q         | C3.7                | T75F-C         | C3.5                         |
|                                       | T38FR-CY           | C3.6         | T62F-C         | C3.5                | T75F-C0        | C3.5                         |
| C2. Surface Raceway                   | T38FR-TLY          | C3.6         | T62F-C0        | C3.5                | T75F-T         | C3.5                         |
|                                       | T38F-TL            | C3.4         | T62F-TL        | C3.5                | T75F-T0        | C3.5                         |
|                                       | T38F-TL0           | C3.5         | T62F-TL0       | C3.5                | T75FR-CY       | C3.6                         |
|                                       | T38N-C             | C3.7         | T62FR-CY       | C3.6                | T75FR-C20Y     | C3.6                         |
| C3. Abrasion Protection               | T38N-C0            | C3.7         | T62FR-C20Y     | C3.6                | T75FR-TY       | C3.6                         |
|                                       | <b>T38P-C0</b>     | <b>C3.7</b>  | T62N-C         | C3.7                | T75N-C         | C3.7                         |
|                                       | T38R-CY            | C3.6         | T62N-C0        | C3.7                | T75N-C0        | C3.7                         |
|                                       | T38R-TLY           | C3.6         | T62R-CY        | C3.6                | T75R-CY        | C3.6                         |
| C4. Cable Management                  | T38T-L             | C3.7         | T62T-Q         | C3.7                | T75T-X         | C3.7                         |
|                                       | T400X000RP1        | E5.34        | T702BCIW-X     | C2.39               | TA1S10-C       | B2.13                        |
|                                       | T400X000RQ1        | E5.34        | T702BIW10      | C2.38               | TA1S10-M0      | B2.13                        |
|                                       | T400X000RU1        | E5.34        | T702BIW8       | C2.38               | TA1S8-C        | B2.13                        |
|                                       | T400X000RW1        | E5.34        | T702ECIW       | C2.39               | TA1S8-M0       | B2.13                        |
|                                       | T400X000RX1        | E5.34        | T702EEIW       | C2.39               | TA1S8-M30      | B2.13                        |
|                                       | T400X000VP1Y       | E2.22        | T702ICIW       | C2.39               | TA1S8-M69      | B2.13                        |
|                                       | T400X000VQ1Y       | E2.22        | T702OCIW       | C2.39               | TA2-C          | B2.13                        |
|                                       | T400X000VS1Y       | E2.22        | T702RAIW       | C2.39               | TA2-M          | B2.13                        |
|                                       | T400X000VT1Y       | E2.22        | T702TIW        | C2.39               | TAPC2-2/0-X    | D2.123, D3.8                 |
| D1. Terminals                         | T400X000VU1Y       | E2.22        | T702TRI        | C2.39               | TAPC3/0-4/0-5  | D2.123, D3.8                 |
|                                       | T400X000VV1Y       | E2.22        | T702TRIW       | C2.39               | TAPC500-2      | D2.123, D3.8                 |
|                                       | T400X000VW1Y       | E2.22        | T702TRLIW      | C2.39               | TC10-14-C100   | B2.41                        |
|                                       | T400X000VX1Y       | E2.22        | T702TTLIW      | C2.39               | TC14-20-C100   | B2.41                        |
| D2. Power Connectors                  | T400X000VY1Y       | E2.22        | T70B1IW        | C2.53               | TC3-5-C100     | B2.41                        |
|                                       | T400X000Y2T        | E5.34        | T70B2IW        | C2.53               | TC5-7-C100     | B2.41                        |
|                                       | T425X000YK1        | E2.22        | T70BCIW-X      | C2.36               | TC5X8-C100     | B2.41                        |
|                                       | <b>T400X000YX1</b> | <b>E5.40</b> | T70BFI         | C2.37               | TC6X10-C100    | B2.41                        |
| D3. Grounding Connectors              | T45BIW10           | C2.48        | T70BFIW        | C2.37               | TC7-10-C100    | B2.41                        |
|                                       | T45BIW10-A         | C2.48        | T70BH1IW       | C2.53               | TC7X14-C100    | B2.41                        |
|                                       | T45BIW8            | C2.48        | T70BH2IW       | C2.53               | TC9X18-C100    | B2.41                        |
|                                       | T45BIW8-A          | C2.48        | T70BIW10       | C2.36               | TDP42HY        | E1.14                        |
|                                       | T45CCIW-X          | C2.49        | T70BIW8        | C2.36               | TDP43HY        | E1.14                        |
| E1. Labeling Systems                  | T45CIW10           | C2.48        | T70CCIW-X      | C2.25, C2.36, C2.39 | TDP43M-AC      | E1.11                        |
|                                       | T45CIW8            | C2.48        | T70CIW10       | C2.24, C2.36, C2.38 | TDP43M-ACY     | E1.13                        |
|                                       | T45DW10            | C2.48        | T70CIW8        | C2.24, C2.36, C2.38 | TDP43M-CASE    | E1.13                        |
|                                       | T45DW8             | C2.48        | T70DB-X        | C2.26, C2.40        | TDP43M-RS      | E1.13                        |
| E2. Labels                            | T45ECIW            | C2.49        | T70DW10        | C2.36, C2.38        | TDP43ME-RS     | E1.13                        |
|                                       | T45EEIW            | C2.49        | T70DW8         | C2.36, C2.38        | TDP43MY        | E1.13                        |
|                                       | T45HDBIW           | C2.49        | T70ECIW        | C2.37               | TDP46HY        | E1.14                        |
|                                       | T45HEBIW           | C2.49        | T70EEIW        | C2.37               | TF10IW-X       | C2.79                        |
| E3. Pre-Printed & Write-On Markers    | T45HEGBIW          | C2.49        | T70FH2IW       | C2.52               | TF3IW-E        | C2.79                        |
|                                       | T45HEGBIW          | C2.49        | T70FH4IW       | C2.52               | TF5IW-E        | C2.79                        |
|                                       | T45ICIW            | C2.49        | T70FSB         | C2.40               | TFC10IW-X      | C2.80                        |
|                                       | T45OCIW            | C2.49        | T70FV2IW       | C2.52               | TFC3IW-X       | C2.80                        |
|                                       | T45RAIW            | C2.49        | T70FV4IW       | C2.52               | TFC5IW-X       | C2.80                        |
| E4. Permanent Identification          | T45RLDIW           | C2.49        | T70HB-X        | C2.40               | TFX10IW-X      | C2.81                        |
|                                       | T45TD              | C2.49        | T70HB3-X       | C2.40               | TFX3IW-X       | C2.81                        |
|                                       | T45TIW             | C2.49        | T70HB3GFICI-X  | C2.40               | TFX5IW-X       | C2.81                        |
|                                       | T45TRI             | C2.49        | T70ICIW        | C2.36               | TFXD10IW-X     | C2.75                        |
|                                       | T45WC2IW           | C2.49        | T70KW2IW       | C2.54               | TG70BCIW-X     | C2.25                        |
| E5. Lockout/Tagout & Safety Solutions | T45WCIW            | C2.49        | T70KW4IW       | C2.54               | TG70HB3-X      | C2.26                        |
|                                       | T45WR-X            | C2.49        | T70L2IW        | C2.55               | TG70HB3GFICI-X | C2.26                        |
|                                       | T50F-C             | C3.4         | T70L4IW        | C2.55               | TG70IW10       | C2.24                        |
|                                       | T50F-C0            | C3.5         | T70LV2IW       | C2.55               | TG70IW8        | C2.24                        |
|                                       | T50F-C1            | C3.4         | T70LV4IW       | C2.55               | TG70WR-X       | C2.26                        |
|                                       | T50F-C10           | C3.4         | T70N2IW        | C2.56               | TGBFI          | C2.25                        |
|                                       | T50F-C16           | C3.4         | T70N4IW        | C2.56               | TGBFIW         | C2.25                        |
| F. Index                              | T50F-C2            | C3.4         | T70NV2IW       | C2.56               | TGDW10         | C2.24                        |
|                                       | T50F-C3Y           | C3.4         | T70NV4IW       | C2.56               |                |                              |
|                                       | T50F-C4Y           | C3.4         | T70OCIW        | C2.37               |                |                              |
|                                       |                    |              |                |                     |                |                              |

| Part Number        | Page Number         |
|--------------------|---------------------|
| TGDW8              | C2.24               |
| TGECIW             | C2.25               |
| TGEEIW             | C2.25               |
| TGF5B              | C2.26               |
| TGICIW             | C2.25               |
| TGOCIW             | C2.25               |
| TGRAIW             | C2.25               |
| TGSICIW            | C2.25               |
| TGSOCIW            | C2.25               |
| TGTD               | C2.25               |
| TGTIW              | C2.25               |
| TGTRIW             | C2.25               |
| THM1SC-C           | B1.120              |
| THM1SC-C30         | B1.120              |
| THMSP20-C          | B2.51               |
| THMSP20-C30        | B2.51               |
| THMSP20F-C         | B2.51               |
| THMSP20F-C30       | B2.51               |
| THMSP25-C          | B2.51               |
| THMSP25-C30        | B2.51               |
| THMSP25F-C         | B2.51               |
| THMSP25F-C30       | B2.51               |
| TJF-X              | B2.48               |
| TM1A-C             | B2.10               |
| TM1S4-C            | B2.9                |
| TM1S4-M30          | B2.11               |
| TM1S4-M69          | B2.11, B1.14        |
| TM1S6-M0           | B2.11               |
| TM1S6-M30          | B2.11               |
| TM1S6-M69          | B2.11, B1.14        |
| TM2A-C             | B2.10               |
| TM2PWH25-C         | B2.19               |
| TM2R6-M0           | B2.11               |
| TM2R6-M30          | B2.11               |
| TM2S6-C            | B2.9                |
| TM2S6-M0           | B2.11               |
| TM2S6-M30          | B2.11               |
| TM2S6-M69          | B2.11, B1.14        |
| <b>TM2S8-C186</b>  | <b>B2.11, B1.14</b> |
| TM2S8-C71          | B2.11, B1.14        |
| TM2S8-C76          | B2.11, B1.14        |
| <b>TM2S8-C86</b>   | <b>B2.11, B1.14</b> |
| TM3S8-C100         | B2.11               |
| TM2S8-M0           | B2.11               |
| TM2S8-M30          | B2.11               |
| TM2S8-M69          | B1.14               |
| TM3-X2-C0Y         | B2.12               |
| TM3A-C             | B2.10               |
| TM3S8-C            | B2.11, B2.9         |
| TM3S8-C69          | B2.11, B1.14        |
| TM3S8-C76          | B1.19               |
| <b>TM3S8-C86</b>   | <b>B1.21</b>        |
| TM3S8-C100         | B2.11               |
| <b>TM3S8-C186</b>  | <b>B2.11, B1.21</b> |
| TM3R6-M0           | B2.11               |
| TM3S8-M30          | B2.11               |
| TM3S8-M100         | B2.11               |
| TM3S10-M0          | B2.11               |
| <b>TM3S10-86</b>   | <b>B2.11, B1.21</b> |
| TM3S10-C76         | B1.19               |
| <b>TM3S10-C186</b> | <b>B2.11, B1.21</b> |
| TM3S10-M30         | B2.11               |
| TM3S10-M69         | B2.11, B1.14        |
| TM3S25-M0          | B2.11               |
| TM3S25-M30         | B2.11               |
| TMEH-S10-C100      | B2.12               |
| TMEH-S10-C109      | B2.12               |
| TMEH-S10-Q0        | B2.12               |
| TMEH-S25-Q0        | B2.12               |
| TMEH-S8-Q0         | B2.12               |
| TMEH-X2-LOY        | B2.12               |
| TMSTHS10-D0        | B2.18               |
| TMSTHS11-D0        | B2.18               |
| TMSTHS12-D0        | B2.18               |
| TMSTHS13-D0        | B2.18               |
| TMSTHS16-D0        | B2.18               |
| TMSTHS19-D0        | B2.18               |

| Part Number    | Page Number |
|----------------|-------------|
| TMSTLHS6-M0    | B2.18       |
| TMSTLHS8-M0    | B2.18       |
| TNR            | C1.34       |
| TP2-C          | B2.15       |
| TP4H-C         | B2.15       |
| TRC18FR-X20Y   | C4.12       |
| TRC18FR-X8Y    | C4.12       |
| TRC2BL         | C1.59       |
| TRC4BL         | C1.59       |
| TTLK3          | B1.114      |
| TTS-20R        | B1.90       |
| TTS-20R0       | B1.88       |
| TTS-35R3       | B1.90       |
| TTS-35R3-0     | B1.88       |
| TTS-35RX       | B1.90       |
| TTS-35RX0      | B1.88       |
| TV105-.38D20Y  | C3.18       |
| TV105-.38DY    | C3.18       |
| TV105-.50D20Y  | C3.18       |
| TV105-.50DY    | C3.18       |
| TV105-.75TL20Y | C3.18       |
| TV105-.75TLY   | C3.18       |
| TV105-1.0C20Y  | C3.18       |
| TV105-1.0CY    | C3.18       |
| TV105-12M20Y   | C3.18       |
| TV105-12MY     | C3.18       |
| TV105-1M20Y    | C3.18       |
| TV105-1MY      | C3.18       |
| TV105-3M20Y    | C3.18       |
| TV105-3MY      | C3.18       |
| TV105-6M20Y    | C3.18       |
| TV105-6MY      | C3.18       |
| TWR-C          | B2.41       |
| TWR-C0         | B2.41       |

## U

|             |       |
|-------------|-------|
| UCT3S-X0    | B1.89 |
| UCT5S-X0    | B1.89 |
| UCTGS1224-X | B1.89 |
| UCTGSM5-X   | B1.89 |
| UCTGSM6-X   | B1.89 |
| UGCTC3S-X0  | B1.89 |
| UGCTC5S-X0  | B1.89 |
| UGCTE3S-X0  | B1.89 |
| UGCTE5S-X0  | B1.89 |

## V

|             |        |
|-------------|--------|
| VCC25-A-C   | B2.36  |
| VCC50-A-C   | B2.36  |
| VSC.25-L    | B2.41  |
| VSC.25-L100 | B2.41  |
| VT-0-Q      | D2.127 |
| VT-1-Q      | D2.127 |
| VT2-Q       | D2.127 |
| VT3-12      | D2.127 |
| VT4-12      | D2.127 |
| VT5-6       | D2.127 |
| VT6-6       | D2.127 |
| VTA-0-Q     | D2.128 |
| VTA-1-Q     | D2.128 |
| VTA-2-Q     | D2.128 |
| VTA-3-12    | D2.128 |
| VTA-4-12    | D2.128 |
| VTA-5-6     | D2.128 |
| VTA-6-6     | D2.128 |
| VWS106-C    | B2.45  |
| VWS106-C20  | B2.45  |
| VWS42105-C  | B2.43  |
| VWS4218-C   | B2.43  |
| VWS4238-C   | B2.43  |
| VWS4274-C   | B2.43  |
| VWSDC-C     | B2.45  |
| VWSDC-C20   | B2.45  |

| Part Number | Page Number |
|-------------|-------------|
| <b>W</b>    |             |
| WB12-L      | D3.28       |
| WB34-X      | D3.28       |
| WB58-Q      | D3.28       |
| WBS6-Q      | B2.45       |
| WCM35BFIW   | C2.91       |
| WCM35BIW8   | C2.90       |
| WCM35CCIW-X | C2.91       |
| WCM35CIW8   | C2.90       |
| WCM35DBFIW  | C2.91       |
| WCM35DW8    | C2.90       |
| WCM35ECIW   | C2.91       |
| WCM35ICIW   | C2.91       |
| WCM35OCIW   | C2.91       |
| WCM35TI     | C2.91       |
| WCM35TIW    | C2.91       |
| WCM35TR10IW | C2.91       |
| WCM35TR5IW  | C2.91       |
| WCM35TR70IW | C2.91       |
| WCM35TRIW   | C2.91       |
| WCM35WR-X   | C2.91       |
| WEH-E8-C    | B2.49       |
| WL1         | E5.27       |
| WL3         | E5.27       |
| WL32Y       | E5.27       |
| WL33Y       | E5.27       |
| WL35Y       | E5.27       |
| WL36Y       | E5.27       |
| WPMH-C      | B2.21       |
| WPS-20      | C2.61       |
| WPS-202     | C2.61       |
| WR2-C       | C1.28       |
| WR2H-C      | C1.28       |
| WR3-C       | C1.28       |
| WR4-C       | C1.28       |
| WR5-C       | C1.28       |
| WRS-A-C10   | C1.28       |
| WS25-25-C   | B2.42       |
| WS25-50-C   | B2.42       |
| WS25-75-C   | B2.42       |
| WS35-25-C   | B2.42       |
| WS35-50-C   | B2.42       |
| WS35-75-C   | B2.42       |
| WS50-25-C   | B2.42       |
| WS50-50-C   | B2.42       |
| WS50-75-C   | B2.42       |
| WS75-25-C   | B2.42       |
| WS75-50-C   | B2.42       |
| WS75-75-C   | B2.42       |

## A. System Overview

### B1. Cable Ties

### B2. Cable Accessories

### B3. Stainless Steel Ties

### C1. Wiring Duct

### C2. Surface Raceway

### C3. Abrasion Protection

### C4. Cable Management

### D1. Terminals

### D2. Power Connectors

### D3. Grounding Connectors

### E1. Labeling Systems

### E2. Labels

### E3. Pre-Printed & Write-On Markers

### E4. Permanent Identification

### E5. Lockout/Tagout & Safety Solutions

### F. Index

**Panduit is a global leader in cabling and communication products, delivering end-to-end solutions in support of demanding electrical and networking requirements.**

## **Panduit Catalogs**

### **Network Connectivity**

**SA-NCCB51**

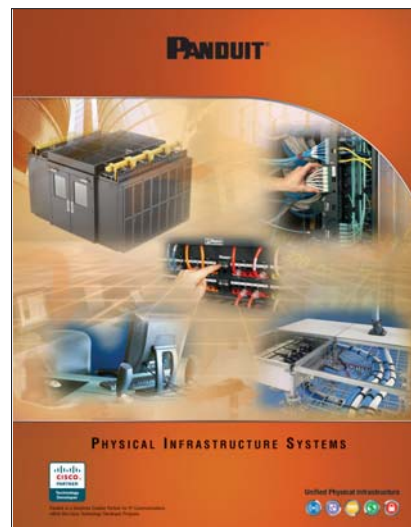

- Copper Systems
- Fiber Optic Systems
- Power over Ethernet
- Zone Cabling
- Wireless
- Outlets
- Media Distribution
- Physical Infrastructure Management
- Overhead and Underfloor Routing
- Surface Raceway
- Cabinets, Racks, and Cable Management
- Grounding and Bonding
- Industrial
- Labeling and Identification
- Cable Management Accessories